

# TOOLS SEAT WRENCHES

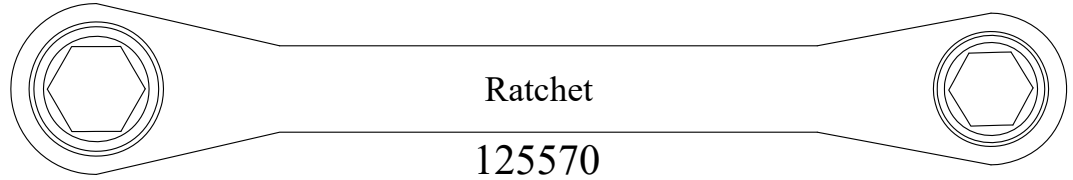

Ratchet

125570

THESE TOOLS ARE ALL HARDENED & COATED WITH BLACK OXIDE WITH THE EXCEPTION OF THE RATCHET

## Available Wrench Kits

162630 - Kit Includes:  
Packaging Tube with  
Easy-Out Wrench  
Squex Wrench

125500 - Kit Includes:  
Packaging Tube with  
Hex Wrench  
Small Square Wrench  
Large Square Wrench  
and Ratchet Wrench

132850 - Kit Includes:  
All items from 125500  
+ Easy-Out Wrench

132920 - Kit Includes:  
All items from 125500  
+ Squex Wrench

132990 - Kit Includes:  
All items from 125500  
+ Easy-Out Wrench  
and Squex Wrench

Packaging Tube  
127040

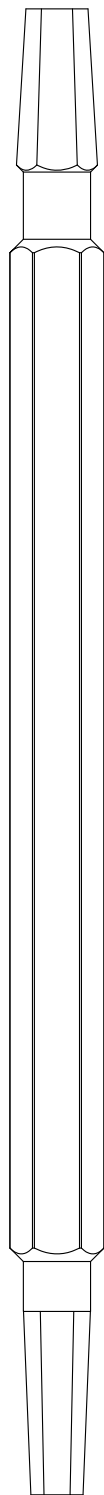

Hex Wrench

121580

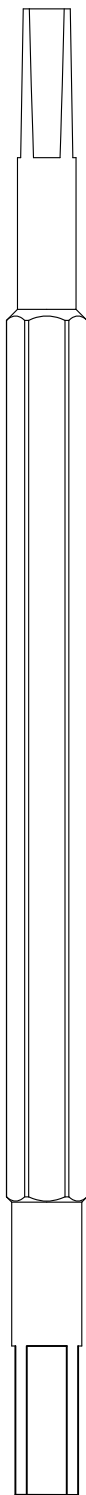

Small Square Wrench

121510

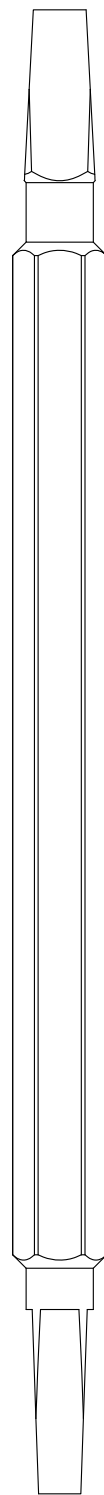

Large Square Wrench

121440

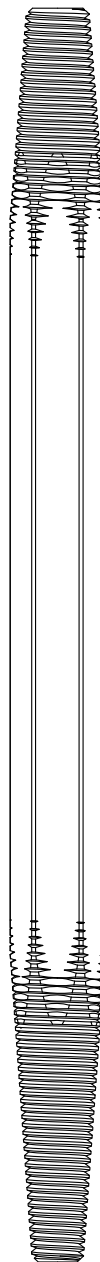

Easy-Out Wrench

134790

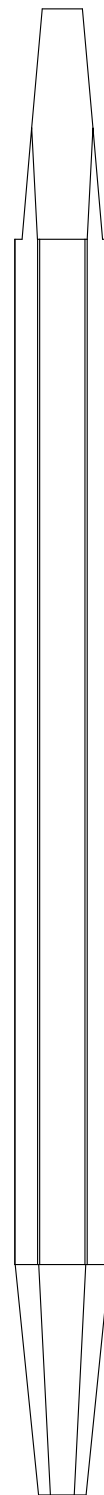

Squex Wrench

121650

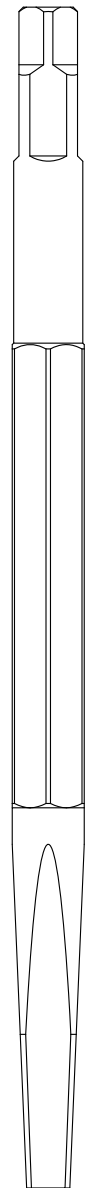

Mobile Home Wrench

192790

# TOOLS SEAT WRENCHES

THESE TOOLS ARE ALL HARDENED & COATED WITH BLACK OXIDE

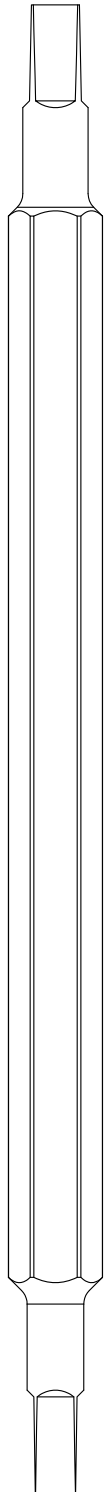

Small Square Wrench

116450

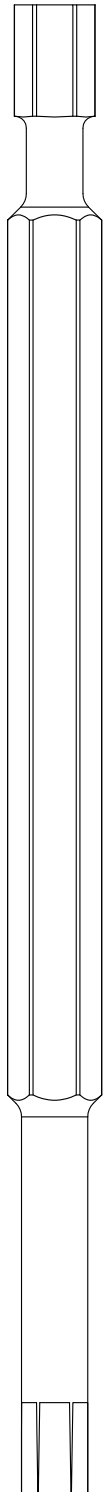

Small Hex Wrench

116730

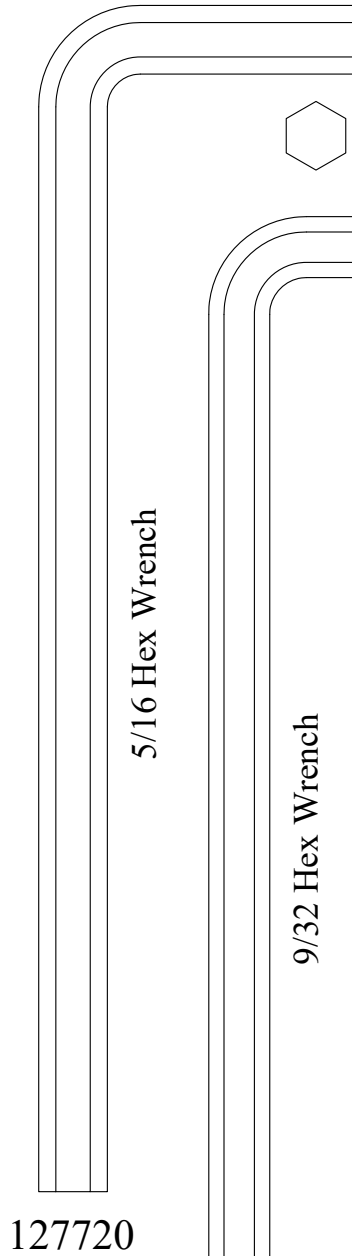

5/16 Hex Wrench

127720

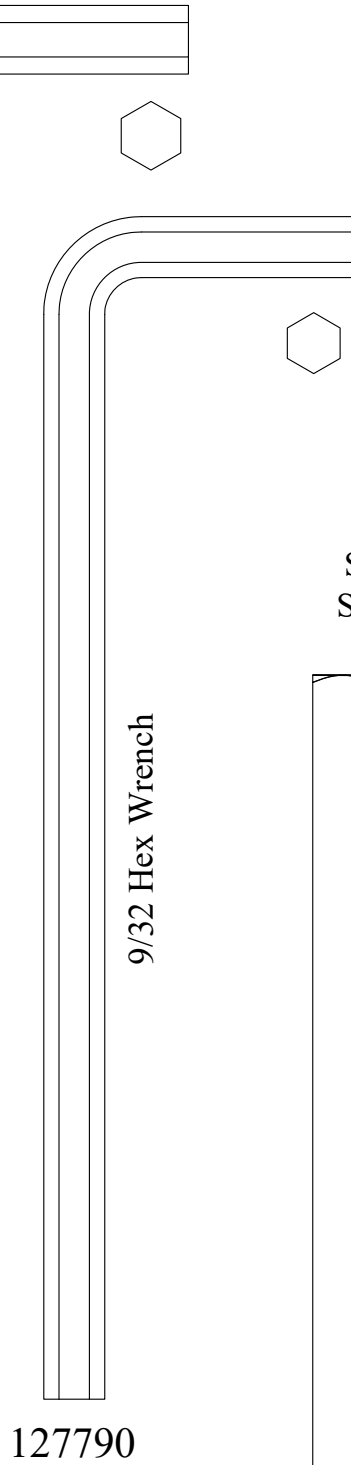

9/32 Hex Wrench

127790



Symmons Hot Seat Wrench

123220

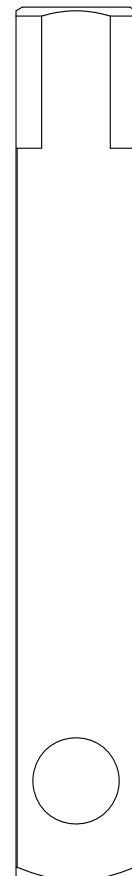

Symmons Hot Cold Wrench

123240

## Available Wrench Kits

123150 - Kit Includes:  
Symmons Hot Seat Wrench  
Symmons Cold Seat Wrench

# TOOLS

## THE PREMIERE MOEN™ CARTRIDGE EXTRACTOR

### ONA PULLER



CHECK OUT OUR VIDEO



#### FOR EXTRACTING MOEN VALVE CARTRIDGES



**MADE IN THE USA**



1. Turn off water supply. Follow instructions with new Moen cartridge.
2. Insert the LONG THREADED ROD through the Posi-Temp PULLER TUBE, threading it into the old cartridge stem.
3. Center the PULLER TUBE over the cartridge and hold firmly in line.
4. Thread the HANDLE on to the LONG THREADED ROD and turn. This will draw the old cartridge into the PULLER TUBE.



Labels: Puller Tube For Posi-Temp, Handle, Old Cartridge, Long Threaded Rod

See instructional video at [barrYWalter.com](http://barrYWalter.com) or QR code on the front

---

1. Turn off water supply. Follow instructions with new Moen cartridge.
2. Insert the LONG THREADED ROD through the PULLER TUBE, threading it into the old cartridge stem.
3. Center the PULLER TUBE over the cartridge and hold firmly in line.
4. Thread the HANDLE on to the LONG THREADED ROD and turn. This will draw the old cartridge into the PULLER TUBE.

If the cartridge pulls out but the cartridge sleeve remains:

1. Remove the PULLER TUBE and LONG THREADED ROD from the HANDLE.
2. Assemble the TAPERED BOLT through the EXPANDER on the HANDLE and thread the CROSS PIN onto the TAPERED BOLT.
3. Insert the EXPANDER into the cartridge sleeve until it bottoms out and tighten the TAPERED BOLT with the CROSS PIN until the EXPANDER will not turn in the cartridge sleeve.
4. Work the HANDLE back and forth to break the cartridge sleeve loose, pulling on the CROSS PIN with your other hand to remove the sleeve.

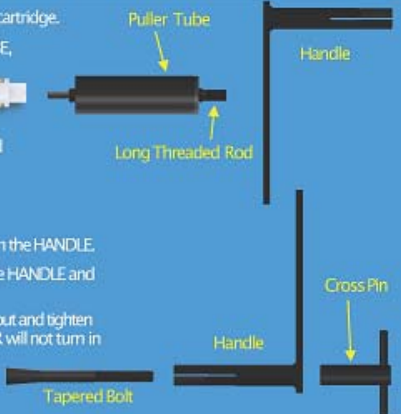

Labels: Puller Tube, Handle, Old Cartridge, Long Threaded Rod, Tapered Bolt, Cross Pin



SCAN TO WATCH THE ONA PULLER TUTORIAL VIDEO

EXTRACT ANY  
1200, 1220 OR 1225  
VALVE CARTRIDGE  
WITH EASE

PART # 999150-ALL

**ONA tool comes packaged in a hanging clamshell with display card and instructions. Small drawstring bag included to hold tools for safe storage.**

# TOOLS

## THE PREMIERE MOEN™ CARTRIDGE EXTRACTOR

STAND ALONE ONA PULLER KIT FOR REMOVAL  
OF A BROKEN POSI-TEMP CARTRIDGE



### BROKEN POSI ONA PULLER



CHECK OUT  
OUR VIDEO

FOR EXTRACTING BROKEN  
MOEN POSI-TEMP CARTRIDGES



MADE IN THE USA



PART # 999070-ALL

FOR USE WITH 999150-ALL  
ONA PULLER KIT TO  
REMOVE A BROKEN  
POSI-TEMP CARTRIDGE

### BROKEN POSI ONA PULLER



FOR USE W/  
999150-ALL



CHECK OUT  
OUR VIDEO

FOR EXTRACTING BROKEN MOEN  
POSI-TEMP CARTRIDGES



MADE IN THE USA



PART # 999070

# TOOLS

## THE PREMIERE DELTA™ CARTRIDGE EXTRACTOR

**ONA FOR DELTA**

**PART # 999150-7**

**USE WITH 999150-ALL**



**FOR EXTRACTING  
DELTA MULTI-CHOICE  
13/14 SERIES CARTRIDGES**

**MADE IN THE USA**



USE WITH 999150-ALL  
TO EXTRACT DELTA  
MULTI-CHOICE 13/14  
SERIES CARTRIDGES

**PART # 999150-7**

1. Turn off water supply. Follow instructions with new Delta cartridge.
2. After removing the trim, remove the bonnet/locking nut from the valve body.
3. Insert the LONG THREADED ROD through the DELTA ONA TUBE, threading it into the Delta cartridge.

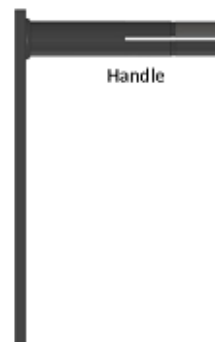
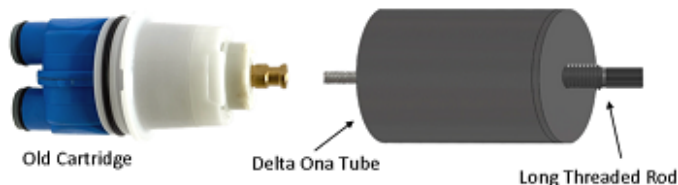

4. Screw the DELTA ONA TUBE onto the valve body, seating it all the way down the body.
5. Thread the HANDLE on to the LONG THREADED ROD and turn. This will draw the old cartridge into the DELTA ONA TUBE removing it from the valve body.
6. Re-assemble the faucet in the reverse order you started.

# TOOLS

FOR VOLA



Thermostatic Hex Key

153600

FOR VOLA



18mm Hex Key

154970

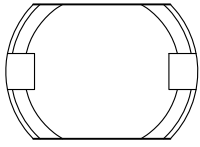

FOR SLOAN and TOTO



3/4" Square  
161370

Tailpiece Nipple Wrench

Stainless Steel

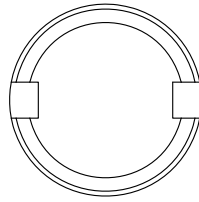

FOR SLOAN



141810

Tailpiece Nipple Wrench

Stainless Steel

FOR KOHLER



Niedecken Bushing Wrench

150170  
OEM # 22117-A

# TOOLS

## UNIVERSAL AERATOR KEY

Front & Back View

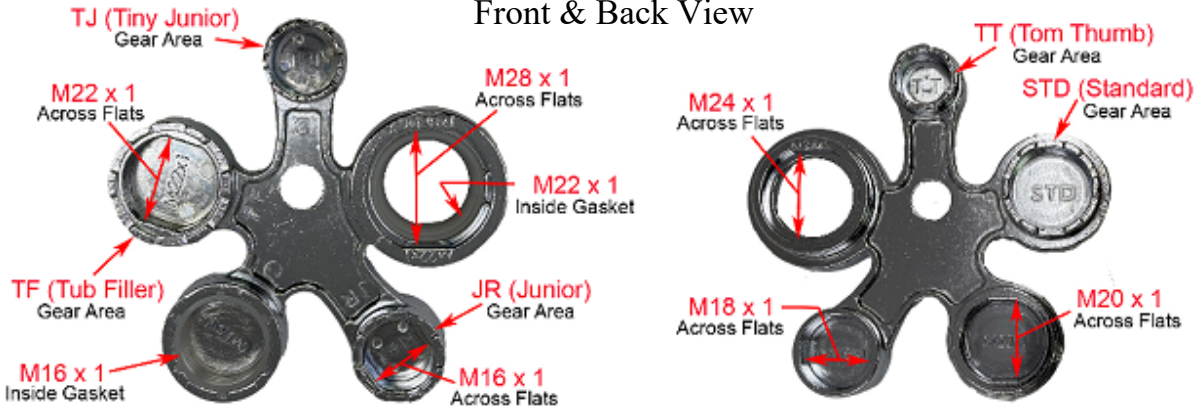

AK13

13 Aerator sizes in 1 Tool. Works on almost all standardized aerators in the market.

### HYDRANT KEY



1.60" Long  
5/16" & 3/8" Square

999030

Neoperl Aerators

TF (Tub Filler)  
TJ (Tiny Junior)  
TT (Tom Thumb)  
JR (Junior)  
STD (Standard)

Metric Sizes

M28 x 1  
M24 x 1  
M22 x 1  
M20 x 1  
M18 x 1  
M16 x 1

### HYDRANT KEY



3.13" Long  
5/16" Square

999040

FOR AMERICAN STANDARD



Colony Stem Removal Wrench

AS94587

FOR SAVOY



Stem Removal Tool

3/4" Square  
SV94547

Internal  
7/8" Flats

Internal  
3/4" Flats

# TOOLS

Waste Shoe Removal Tool

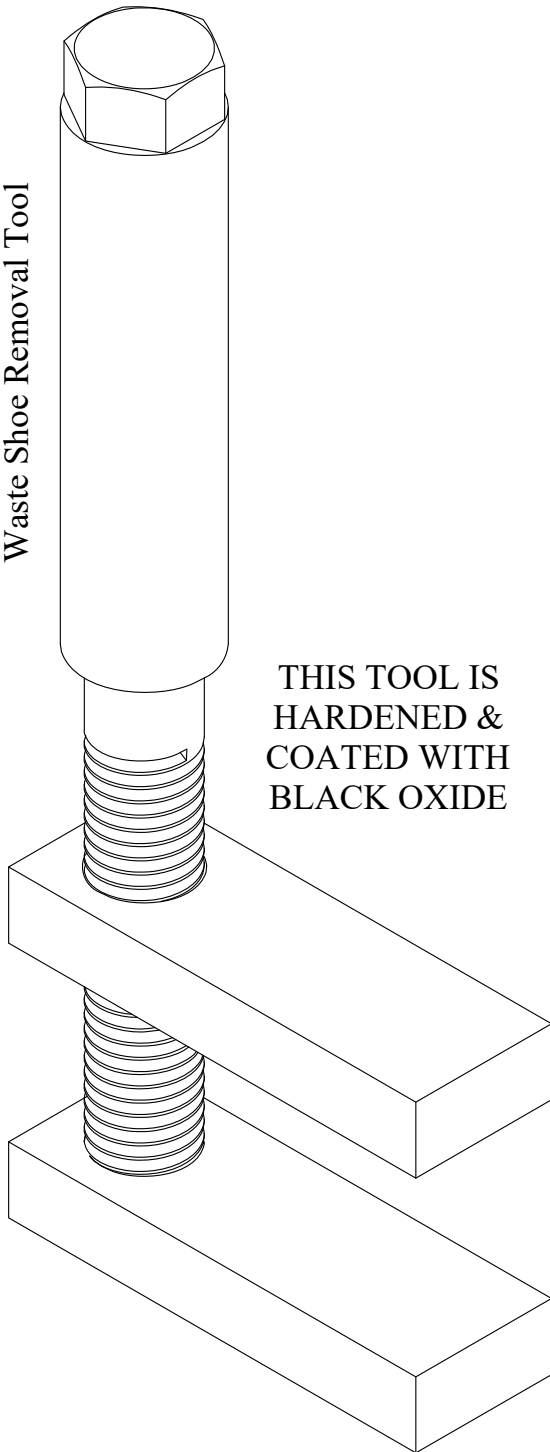

THIS TOOL IS  
HARDENED &  
COATED WITH  
BLACK OXIDE

120670

T-Handle for Stop Stem

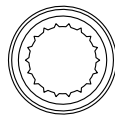
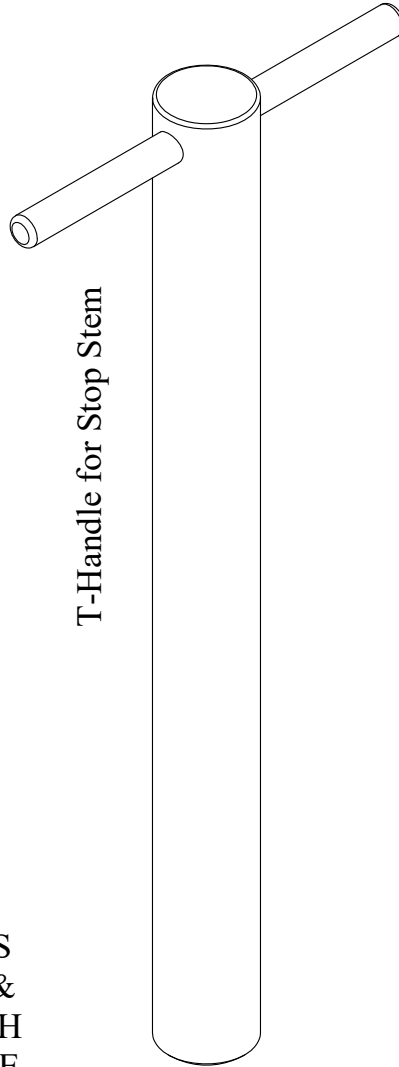

18  
3-3

999010

Radiator Valve Wrench



999060