

BARRY E.  WALTER  SR. CO.

SUPPLEMENTAL CATALOG

MISSION STATEMENT

Our mission is to serve with integrity, being dedicated to manufacturing and supplying superior quality plumbing parts to our customers with a focus on relationships and an eye on future needs while caring for our team and their families by providing a fair wage and good benefits in a safe and quality work environment.

TERMS AND CONDITIONS OF SALE

SALES POLICY:

It is our policy to sell the OEM and wholesale level only. Possession of this book does not constitute an offer to sell. Prices are subject to change without notice. All orders will be shipped and invoiced at the prevailing price at the time of shipment. We reserve the right to adjust orders to standard package quantities unless otherwise stated on purchase order. All orders are subject to acceptance by Barry E. Walter Sr. Co., 2550 E. Platte Ave., Fort Morgan, CO 80701. The Minimum billing is \$50.00. Drop shipments will carry a 10% surcharge and must meet minimum requirements.

TERMS:

3% 20, Net 30. Payment must be received within 20 days of the invoice date for the discount to be allowed. Any amount past due is subject to finance charge on the total past due balance in accordance with the truth-in-lending act. Invoices not paid according to the terms are subject to MONTHLY SERVICE CHARGES of 1 1/2% per month (which is an ANNUAL PERCENTAGE RATE OF 18%). Returned checks (NSF) will be charged a \$25.00 handling charge. Prices are subject to any federal, state, sales use or other tax applying, unless exemption certificates are on file with Barry E. Walter Sr. Co. Cancellation of regular merchandise orders can be authorized only by Barry E. Walter Sr. Co. Handling charges may be assessed for canceled orders.

FREIGHT:

All orders will be shipped FOB Fort Morgan, Colorado. Shipping charges will be prepaid and added to the invoice unless different arrangements have been made.

RETURNS:

No goods will be accepted for return unless authorized by Barry E. Walter Sr. Co. in advance of return. Return goods are subject to a minimum 20% handling charge plus freight. All material returned without prior written permission will be assessed a minimum of 50% plus freight.

CLAIMS:

Claims for shortage must be made within five days after receipt of shipment. Items defective in material or workmanship will be replaced without charge. It is expressly understood that Barry E. Walter Sr. Co., liability is limited to furnishing of such replacement parts and that Barry E. Walter Sr. Co. will not be liable for any damages, losses, or expenses arising in connection with the use of or inability to use our products for any purpose. Damaged shipments must be made available to the carrier or transportation company for inspection.

SPECIAL MATERIAL:

Materials made to the specifications of the customers by Barry E. Walter Sr. Co. are not returnable. Once an order has been placed it cannot be canceled. Barry E. Walter Sr. Co. reserves the right to charge a \$50.00 research fee to identify and quote on customer special requests.

GENERAL:

Barry E. Walter Sr. Co. represents that it has complied with the Fair Labor Standards Act of 1938, as amended, and the Fair Employment Practice Act. All Catalogs, Price List, and Production Information Publications remain the property of Barry E. Walter Sr. Co. We also stock many items which are not currently included in our catalog and are constantly adding replacement parts. If you don't find the item you need, just ask!

Any usage of original manufactures' names or numbers, product names, and model names or numbers on invoices, quotes, or packing slips are strictly for descriptive and identification purposes. All drawing representations or depictions of original manufactures' products in Barry E. Walter Sr. Co. catalogs or faxes are strictly for identification purposes, and are used to determine the proper Barry Walter Co. replacement part. They are not meant to imply that the parts are manufactured by the original equipment manufacturer.

TABLE OF CONTENTS

FOR MOST UP-TO-DATE CERAMIC CARTRIDGE SECTION SEE THE PARTS CATALOG ON OUR WEBSITE AND CLICK ON CERAMIC UNITS

Ceramic Disc Cartridges	1
Non-Rising Units	65
Stop Stems	85
Seats	99
Seat Kits	113
Barrels	117
Stem Extensions, Stems Extension Kits & Handle Adapters	123
Handles	147
Nipples & Threaded Extensions	155
Escutcheon Adapters	163
Escutcheon Extensions	167
Escutcheon Holders	168
Escutcheon Tubes	170
Escutcheons	173
Shower Heads & Components	179
Repair Parts	185
Flushometer Parts	199
Balancing Spools	203
Kohler Bonnets	204

Spout Posts, Nuts & Components	205
Drain Components	207
Stem & Handle ID Gauges	211
O-Rings	213
Cap Gaskets	216
Friction Washers	219
Top Gaskets	220
Packings	221
Diverter Washers	222
Bibb Washers	224
Special Washers	225
Ceramic Components	226
Screws	227
Seat Wrenches & Tools	228
Adapters	239
Ballcock Plungers & Components	251
Institutional & Security Repair Parts	257
Valve Bodies, Body Extensions & Components	279
OEM Parts	285

Send Your Orders To:

BARRY E.  SR. CO.

E-mail: orderdesk@barrywalter.com

Fax: 1.800.886.9831

Phone: 1.800.767.5552

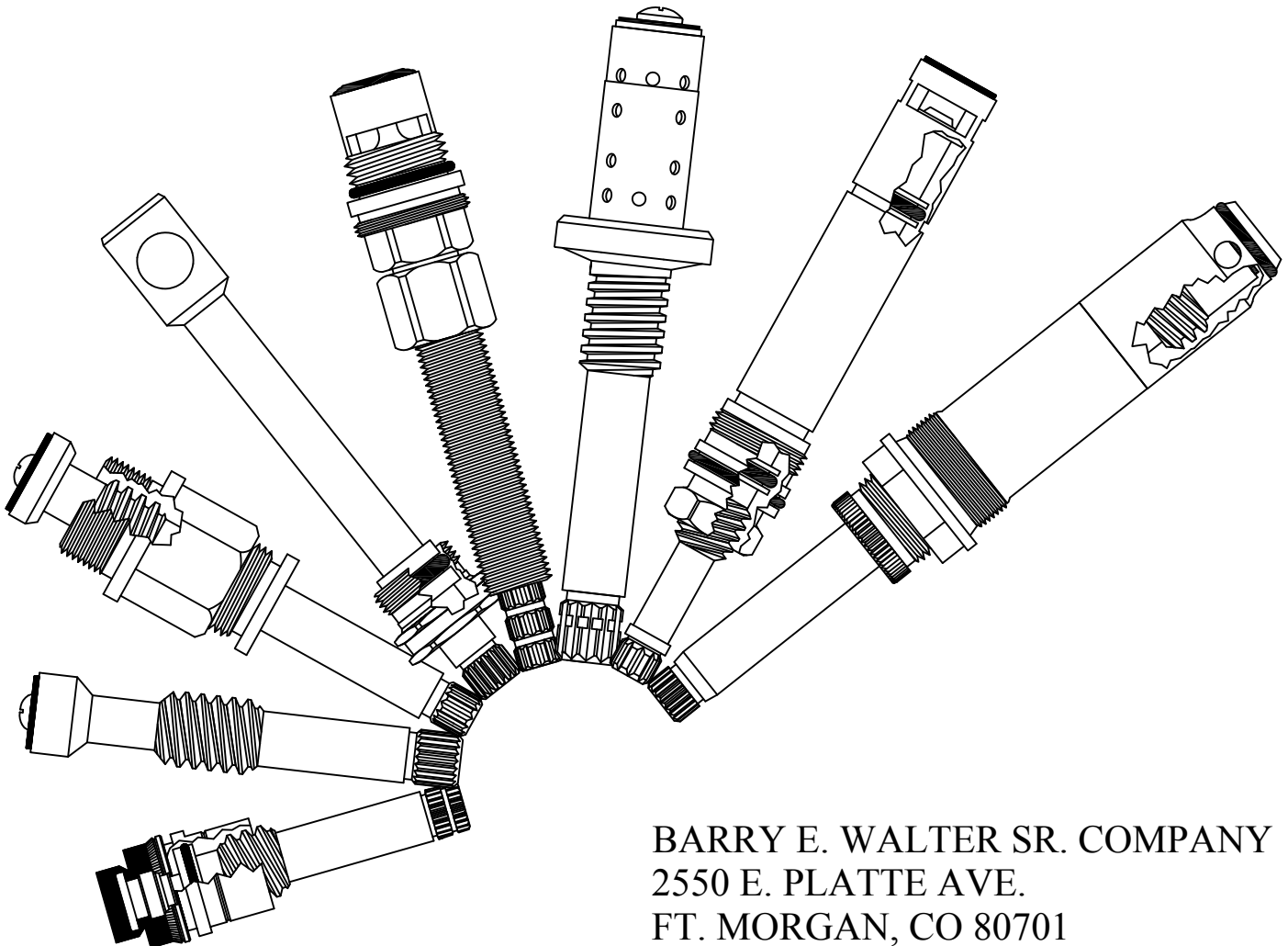

BARRY E. WALTER SR. COMPANY
2550 E. PLATTE AVE.
FT. MORGAN, CO 80701

BARRY E.  WALTER SR. CO.

CERAMIC
DISC
CARTRIDGES

CERAMIC DISC CARTRIDGES

Ceramic Conversion for:

FOR AM STD
LENGTH: 1.39"

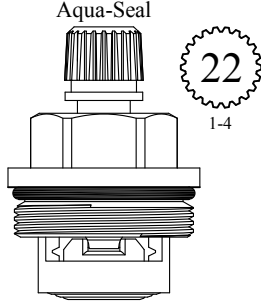

GASKET: 890180 O-RING INCLUDED
SEAL: 898500
DISC SET: 112530-PKG

LF450931
LF450932

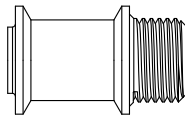

SEAT INCLUDED: LF646950

UNKNOWN
LENGTH: 1.52"

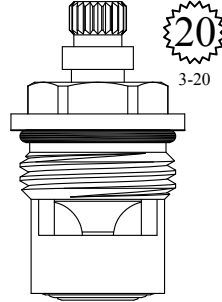

GASKET: 890170 O-RING INCLUDED
SEAL: 898500
DISC SET: 112530-PKG

LF450991
LF450992

FOR ARTISTIC BRASS
LENGTH: 1.40"

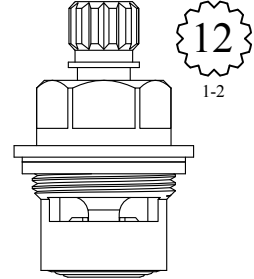

GASKET: 895100 INCLUDED
SEAL: 898500
DISC SET: 112530-PKG

LF450941
LF450942

FOR UNION BRASS
LENGTH: 1.45"

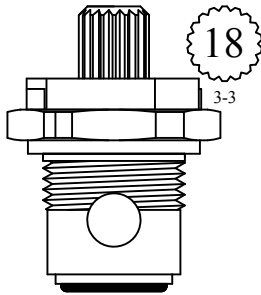

GASKET: 895100 INCLUDED

LF452121
LF452122

FOR SAYCO
LENGTH: 1.49"

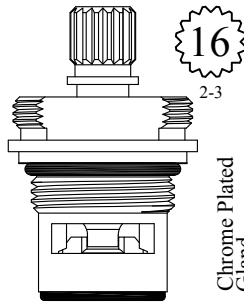

GASKET: 890170 O-RING INCLUDED
SEAL: 898540
DISC SET: 112530-PKG

LF451231
LF451232

FOR ARTISTIC BRASS
LENGTH: 1.53"

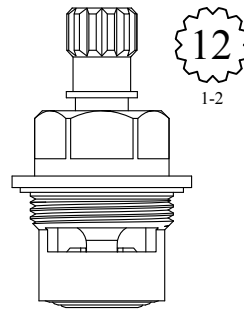

GASKET: 895100 INCLUDED
SEAL: 898500
DISC SET: 112530-PKG

LF451191
LF451192

UNKNOWN
LENGTH: 1.54"

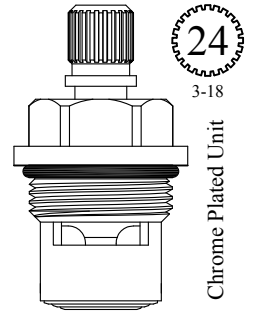

GASKET: 890170 O-RING INCLUDED
SEAL: 898500
DISC SET: 112530-PKG

LF451201
LF451202

FOR AUBURN BRASS
LENGTH: 1.57"

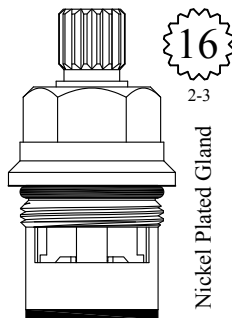

GASKET: 890160 O-RING INCLUDED
SEAL: 893030
DISC SET: 151380-PKG

LF450901
LF450902

UNKNOWN
LENGTH: 1.59"

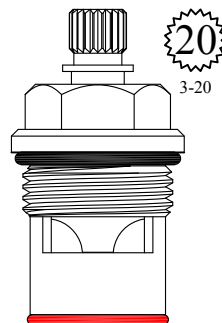

GASKET: 890170 O-RING INCLUDED
SEAL: 898580-R/B
DISC SET: 151380-PKG

LF451261
LF451262

UNKNOWN
LENGTH: 1.63"

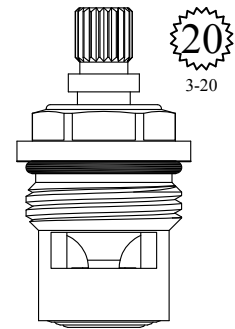

GASKET: 890170 O-RING INCLUDED
SEAL: 898500
DISC SET: 112530-PKG

LF451281
LF451282

CERAMIC DISC CARTRIDGES

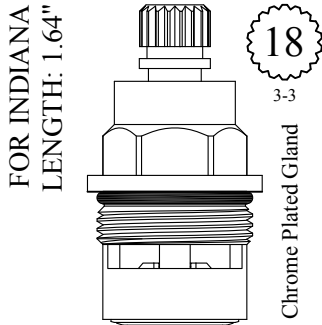

GASKET: 890170 O-RING INCLUDED
SEAL: 898510-W
DISC SET: 151380-PKG

LF451901
LF451902

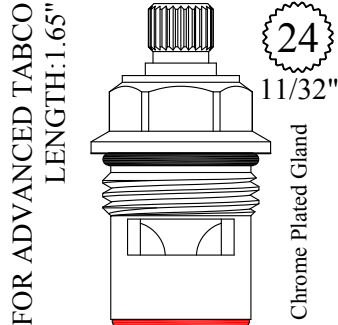

GASKET: 890170 O-RING INCLUDED
SEAL: 898570-R/B
DISC SET: 151380-PKG

LF452601
LF452602

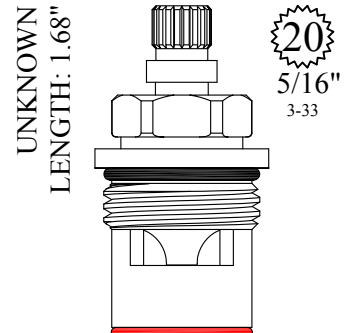

GASKET: 890170 O-RING INCLUDED
SEAL: 898580-R/B
DISC SET: 151380-PKG

LF452611
LF452612



GASKET: 890170 O-RING INCLUDED
SEAL: 898570-R/B
DISC SET: 151380-PKG

LF452621
LF452622

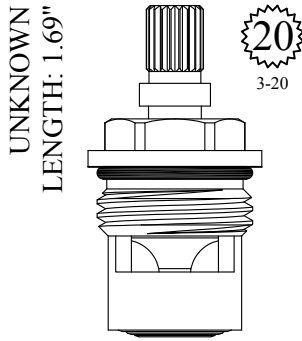

GASKET: 890170 O-RING INCLUDED
SEAL: 898500
DISC SET: 112530-PKG

LF452381
LF452382

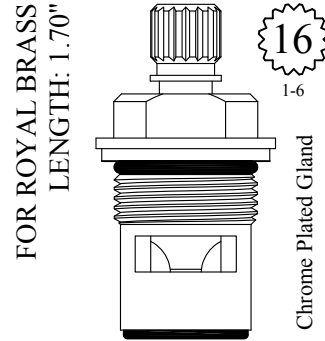

GASKET: 890160 O-RING INCLUDED
SEAL: 898540
DISC SET: 112530-PKG

LF451501
LF451502

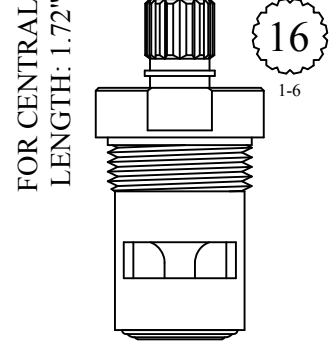

GASKET INCLUDED: 895270
SEAL: 898500
DISC SET: 112530-PKG

LF455901
LF455902

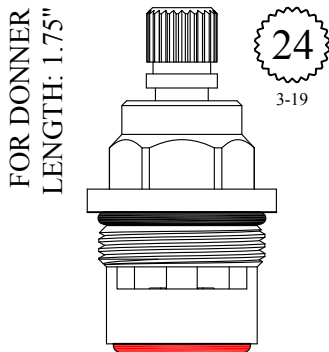

GASKET: 890180 O-RING INCLUDED
SEAL: 898570-R/B
DISC SET: 151380-PKG

LF455301
LF455302

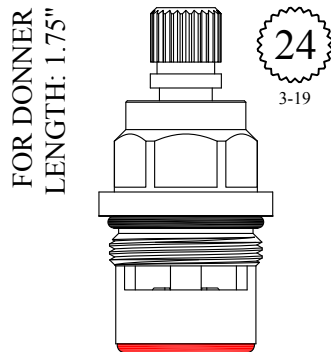

GASKET: 890170 O-RING INCLUDED
SEAL: 898570-R/B
DISC SET: 151380-PKG

LF455311
LF455312

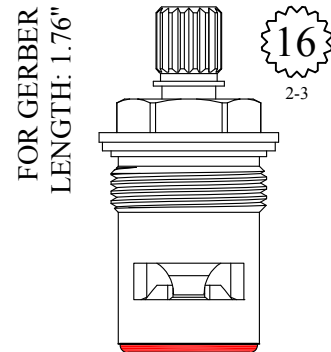

GASKET: 895140 INCLUDED
SEAL: 898570-R/B
DISC SET: 151380-PKG

LF455951
LF455952

CERAMIC DISC CARTRIDGES

FOR PRICE PFISTER
LENGTH: 1.78"

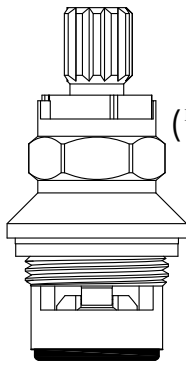

12
1-2
(LESS ONE
SPLINE)

Nickel Plated Unit

FOR PACIFICA
LENGTH: 1.80"

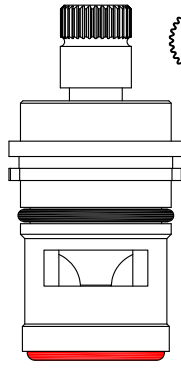

32
3-23

FOR PREMIER
LENGTH: 1.81"

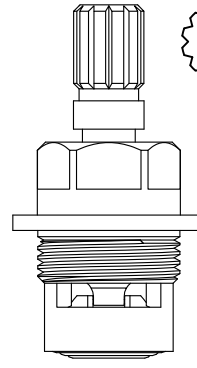

12
1-2

Chrome Plated Unit

UNKNOWN
LENGTH: 1.81"

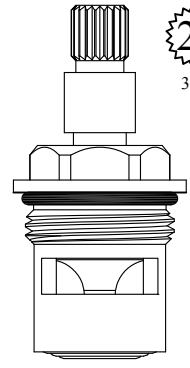

20
3-20

GASKET: 895190 INCLUDED
SEAL: 898540
DISC SET: 112530-PKG

LF452801
LF452802

GASKET: 890170 O-RING INCLUDED
SEAL: 898570-R/B
DISC SET: 151380-PKG

LF456221
LF456222

SEAL: 898500
DISC SET: 112530-PKG

LF455981
LF455982

GASKET: 890170 O-RING INCLUDED
SEAL: 898500
DISC SET: 112530-PKG

LF456031
LF456032

UNKNOWN
LENGTH: 1.85"

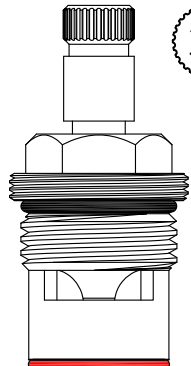

30
3-35

Chrome Plated Unit

UNKNOWN
LENGTH: 1.86"

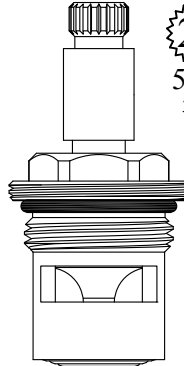

20
5/16
3-33

UNKNOWN
LENGTH: 1.86"

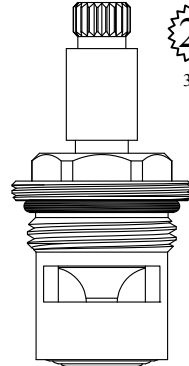

20
3-20

GASKET: 890170 O-RING INCLUDED
SEAL: 898580-R/B
DISC SET: 151380-PKG

LF456481
LF456482

GASKET: 890170 O-RING INCLUDED
SEAL: 898500
DISC SET: 112530-PKG

LF456251
LF456252

GASKET: 890170 O-RING INCLUDED
SEAL: 898500
DISC SET: 112530-PKG

LF456271
LF456272

UNKNOWN
LENGTH: 1.86"

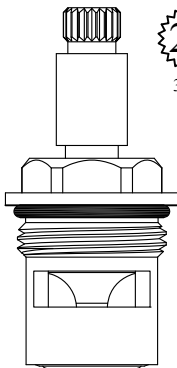

20
3-20

UNKNOWN
LENGTH: 1.86"

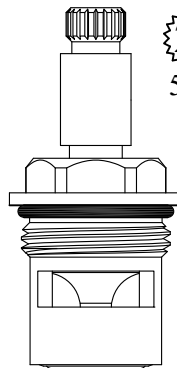

20
5/16
3-33

FOR T & S
LENGTH: 1.87"

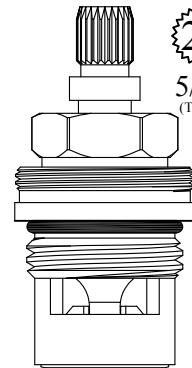

22
5/16
(T & S)

GASKET: 890170 O-RING INCLUDED
SEAL: 898500
DISC SET: 112530-PKG

LF456281
LF456282

GASKET: 890170 O-RING INCLUDED
SEAL: 898500
DISC SET: 112530-PKG

LF456291
LF456292

GASKET: 890170 O-RING INCLUDED
SEAL: 898500
DISC SET: 112530-PKG

LF456261
LF456262

CERAMIC DISC CARTRIDGES

FOR GLACIER BAY
LENGTH: 1.87"

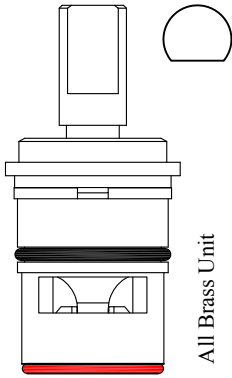

All Brass Unit

GASKET: 890170 O-RING INCLUDED
SEAL: 898580-R/B
DISC SET: 151380-PKG

LF456341
LF456342

FOR MOUNTAIN
LENGTH: 1.87"

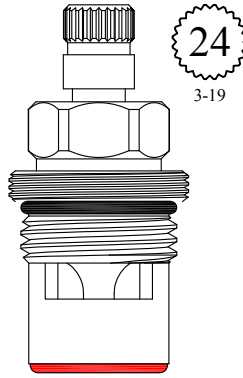

24
3-19

GASKET: 890170 O-RING INCLUDED
SEAL: 898570-R/B
DISC SET: 151380-PKG

LF456371
LF456372

FOR MOUNTAIN
LENGTH: 1.87"

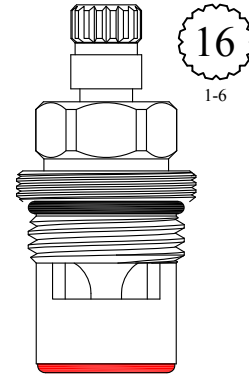

16
1-6

GASKET: 890170 O-RING INCLUDED
SEAL: 898570-R/B
DISC SET: 151380-PKG

LF456381
LF456382

UNKNOWN
LENGTH: 1.87"

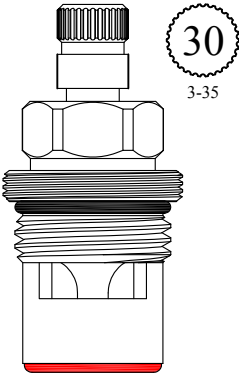

30
3-35

GASKET: 890170 O-RING INCLUDED
SEAL: 898570-R/B
DISC SET: 151380-PKG

LF456411
LF456412

UNKNOWN
LENGTH: 1.88"

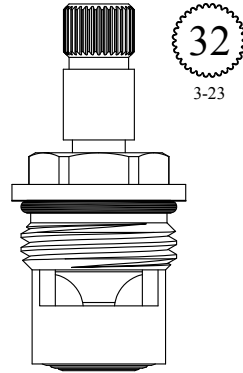

32
3-23

GASKET: 890170 O-RING INCLUDED
SEAL: 898500
DISC SET: 112530-PKG

LF455381
LF455382

FOR GLACIER BAY
LENGTH: 1.88"

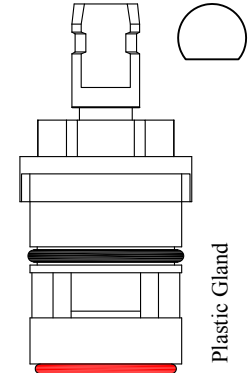

Plastic Gland

GASKET: 890170 O-RING INCLUDED
SEAL: 898580-R
DISC SET: 115520-PKG

LF456201
LF456202

FOR GLACIER BAY
LENGTH: 1.88"

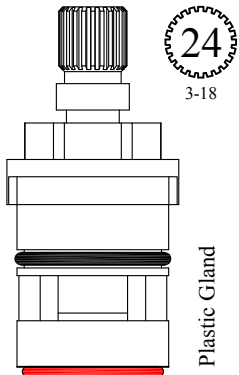

24
3-18

Plastic Gland

GASKET: 890170 O-RING INCLUDED
SEAL: 898580-R
DISC SET: 115520-PKG

LF456231
LF456232

UNKNOWN
LENGTH: 1.90"

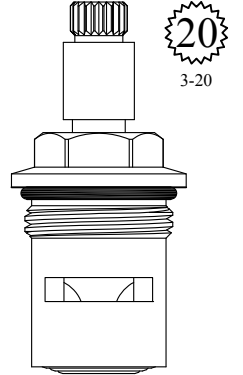

20
3-20

GASKET: 890170 O-RING INCLUDED
SEAL: 898500
DISC SET: 112530-PKG

LF456881
LF456882

UNKNOWN
LENGTH: 1.91"

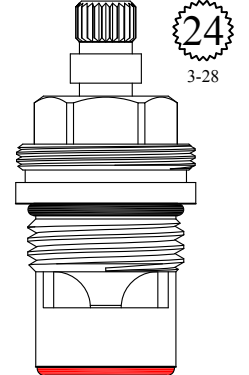

24
3-28

GASKET: 890170 O-RING INCLUDED
SEAL: 898570-R/B
DISC SET: 151380-PKG

LF459131
LF459132

CERAMIC DISC CARTRIDGES

FOR INDIANA
LENGTH: 1.91"

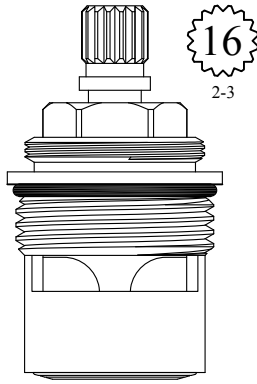

GASKET: 890210 O-RING INCLUDED
SEAL: 898520
DISC SET: 109850-PKG

400811
400812

FOR INDIANA
LENGTH: 1.91"

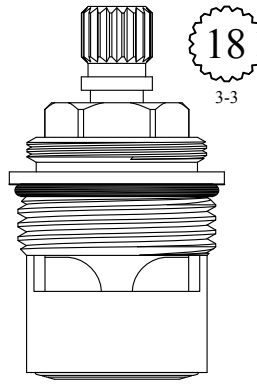

GASKET: 890210 O-RING INCLUDED
SEAL: 898520
DISC SET: 109850-PKG

400861
400862

FOR GLACIER BAY
LENGTH: 1.91"

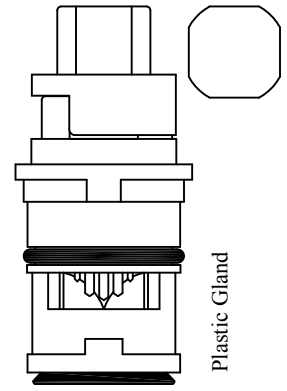

GASKET: 890170 O-RING INCLUDED
SEAL: 898510
DISC SET: 151380-PKG

LF456351
LF456352

FOR MILWAUKEE
LENGTH: 1.92"

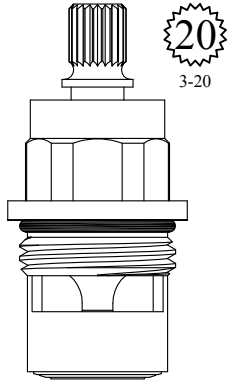

GASKET: 890170 O-RING INCLUDED
SEAL: 898510-W
DISC SET: 151380-PKG

LF456401
LF456402

FOR NICOLAZZI / ROHL
LENGTH: 1.92"

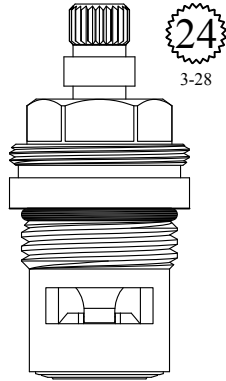

GASKET: 890170 O-RING INCLUDED
SEAL: 898510-W
DISC SET: 151380-PKG

LF456921
LF456922

FOR SIMBOLO
LENGTH: 1.92"

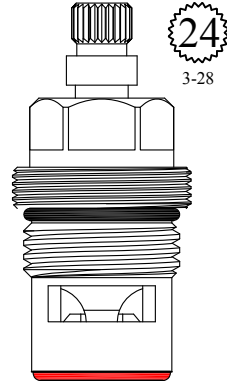

GASKET: 890170 O-RING INCLUDED
SEAL: 898570-R/B
DISC SET: 151380-PKG

LF456911
LF456912

FOR DOBO
LENGTH: 1.93"

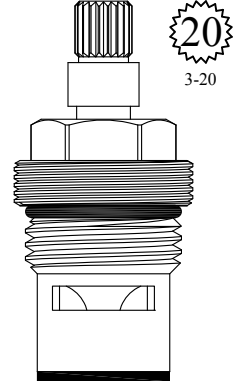

GASKET: 890170 O-RING INCLUDED
SEAL: 853030
DISC SET: 151380-PKG

LF456391
LF456392

FOR OMNI / EAGLE GROUP
LENGTH: 1.95"

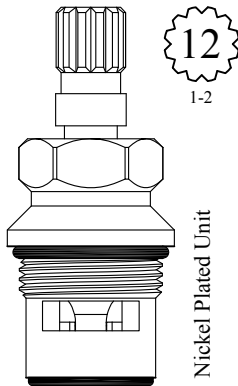

GASKET: 890170 O-RING INCLUDED
SEAL: 898540
DISC SET: 112530-PKG

LF458821
LF458822

FOR STERLING FAUCET
LENGTH: 1.94"

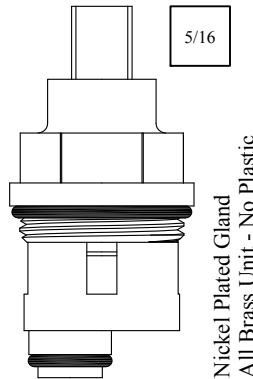

GASKET: 890180 O-RING INCLUDED

LF458171
LF458172

FOR AQUASOURCE
LENGTH: 1.94"

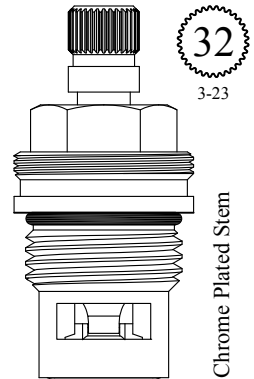

GASKET: 890170 O-RING INCLUDED
SEAL: 898500
DISC SET: 112530-PKG

LF457311
LF457312

CERAMIC DISC CARTRIDGES

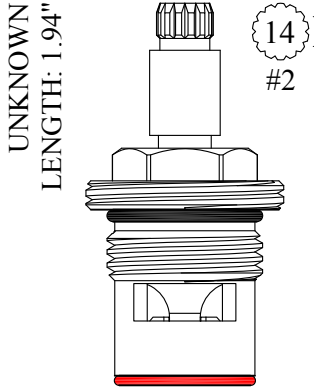

GASKET: 890170 O-RING INCLUDED
SEAL: 898580-R/B
DISC SET: 151380-PKG

LF458431
LF458432

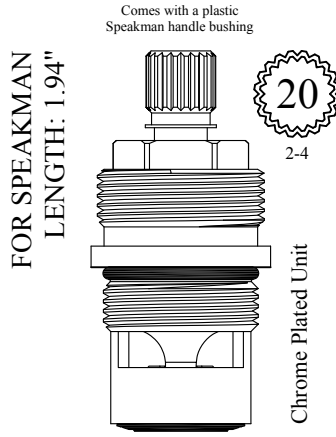

GASKET: 890170 O-RING INCLUDED
SEAL: 898510-W
DISC SET: 151380-PKG

LF458801
LF458802

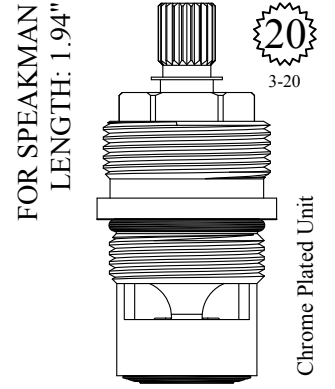

GASKET: 890170 O-RING INCLUDED
SEAL: 898510-W
DISC SET: 151380-PKG

LF458811
LF458812

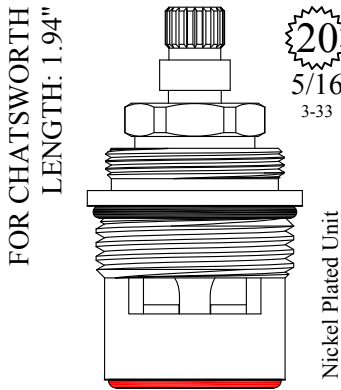

GASKET: 890210 O-RING INCLUDED
SEAL: 898610-R
DISC SET: 109850-PKG

400971
400972

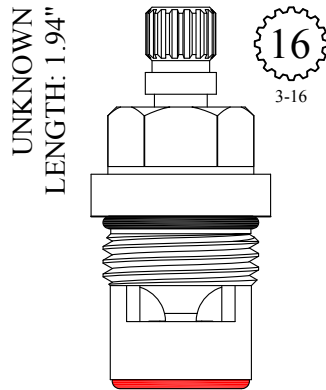

GASKET: 890170 O-RING INCLUDED
SEAL: 898570-R/B
DISC SET: 151380-PKG

LF458871
LF458872

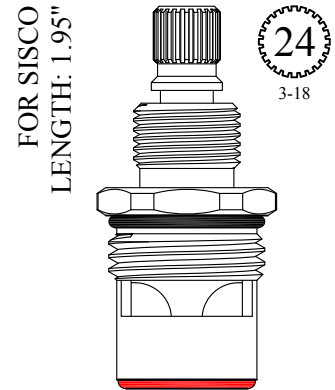

GASKET: 890170 O-RING INCLUDED
SEAL: 898570-R/B
DISC SET: 151380-PKG

LF456901
LF456902

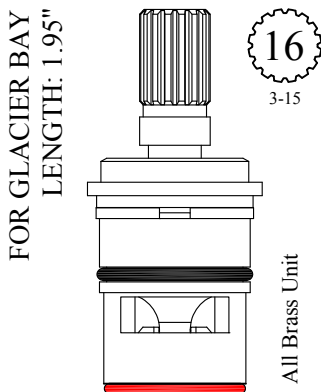

GASKET: 890170 O-RING INCLUDED
SEAL: 898580-R/B
DISC SET: 151380-PKG

LF457611
LF457612

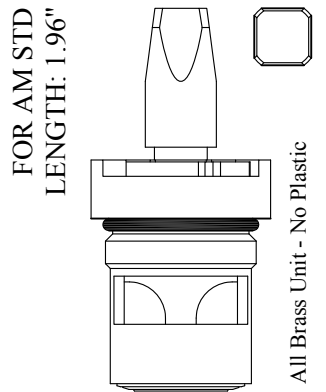

GASKET: 890170 O-RING INCLUDED
SEAL: 898510-W
DISC SET: 151380-PKG

LF458901
LF458902

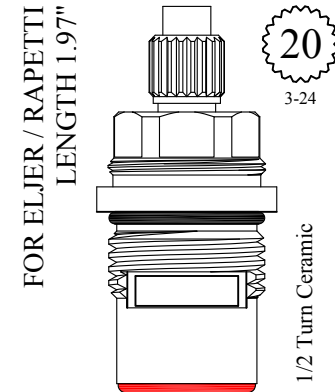

GASKET: 890170 O-RING INCLUDED
SEAL: 898570-R/B
DISC SET: 124290-PKG

LF457361
LF457362

CERAMIC DISC CARTRIDGES

FOR ARTISTIC BRASS
LENGTH 1.97"

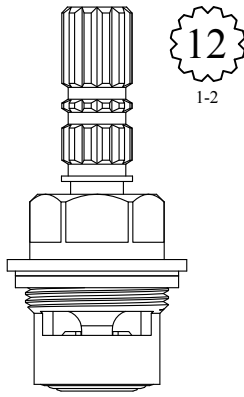

GASKET: 895100 INCLUDED
SEAL: 898500
DISC SET: 112530-PKG

LF458161
LF458162

FOR BROADWAY
LENGTH 1.97"

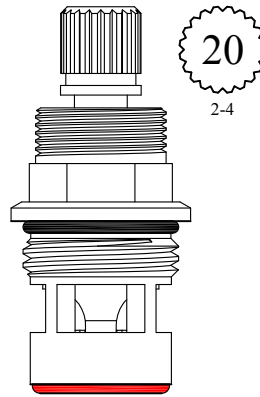

GASKET: 890170 O-RING INCLUDED
SEAL: 898570-R/B
DISC SET: 151380-PKG

LF457601
LF457602

FOR ARTISTIC BRASS
LENGTH 1.97"

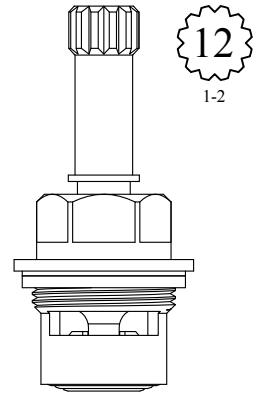

GASKET: 895100 INCLUDED
SEAL: 898500
DISC SET: 112530-PKG

LF458151
LF458152

FOR PRICE PFISTER
LENGTH: 1.98"

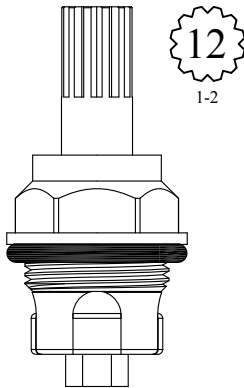

GASKET: 891100 O-RING INCLUDED

LF456331
LF456332

FOR ELJER
LENGTH 1.98"

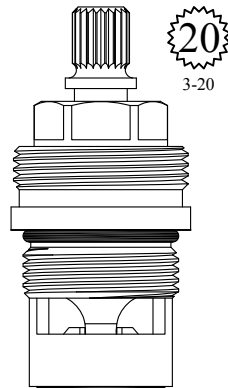

GASKET: 890170 O-RING INCLUDED
SEAL: 898510
DISC SET: 151380-PKG

LF457701
LF457702

FOR J.R. SMITH HYDRANT
LENGTH 1.98"

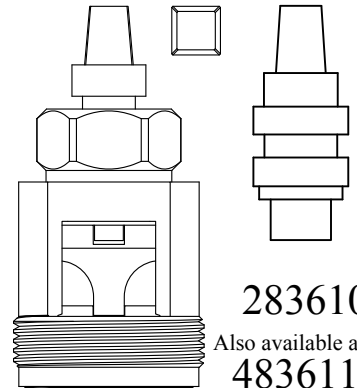

SEAL: 823420
DISC SET: 109850-PKG

483611

283610-1
Also available as a kit
483611-1

Kit includes:
(1) 283610-1
(1) 483611

FOR FOREMOST
LENGTH: 2.00"

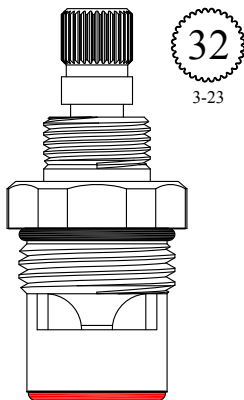

GASKET: 890170 O-RING INCLUDED
SEAL: 898580-R/B
DISC SET: 151380-PKG

LF459271
LF459272

UNKNOWN
LENGTH 2.00"

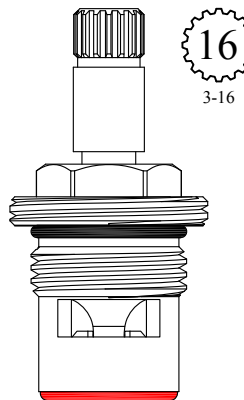

GASKET: 890170 O-RING INCLUDED
SEAL: 898570-R/B
DISC SET: 151380-PKG

LF459431
LF459432

FOR PEGASUS
FOR SIGN OF THE CRAB
LENGTH 2.00"

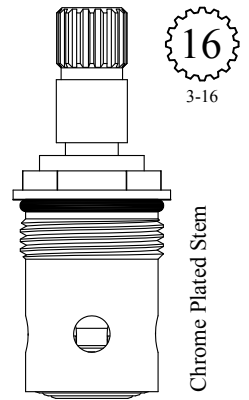

GASKET: 890160 O-RING INCLUDED
SEAL: 898500
DISC SET: 112530-PKG

LF457901
LF457902

Chrome Plated Stem

CERAMIC DISC CARTRIDGES

FOR GLACIER BAY
LENGTH: 2.00"

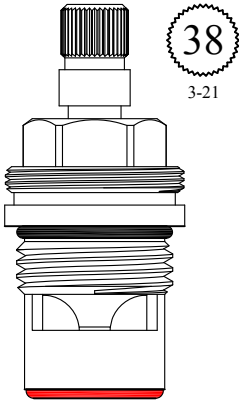

GASKET: 890170 O-RING INCLUDED
SEAL: 898570-R/B
DISC SET: 151380-PKG

LF458341
LF458342

FOR PIONEER
LENGTH: 2.01"

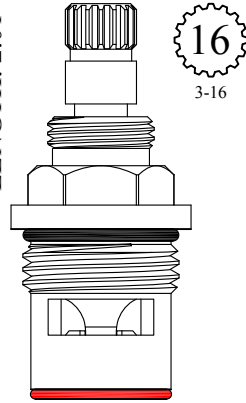

GASKET: 890170 O-RING INCLUDED
SEAL: 898580-R/B
DISC SET: 151380-PKG

LF459681
LF459682

FOR PAINI
LENGTH: 2.02"

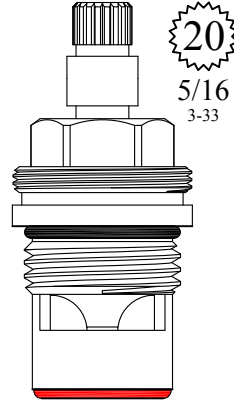

GASKET: 890170 O-RING INCLUDED
SEAL: 898570-R/B
DISC SET: 151380-PKG

LF458891
LF458892

FOR BALOCCHI
LENGTH: 2.02"

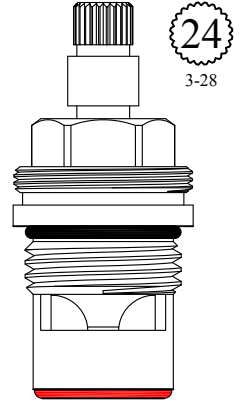

GASKET: 890170 O-RING INCLUDED
SEAL: 898570-R/B
DISC SET: 151380-PKG

LF459341
LF459342

FOR FRANKE

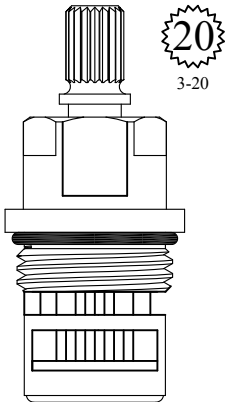

Not Available
USE LF458941/LF458942

FOR FRANKE
LENGTH: 2.03"

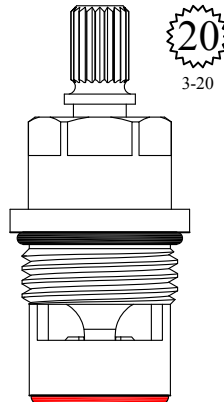

GASKET: 890170 O-RING INCLUDED
SEAL: 898570-R/B
DISC SET: 151380-PKG

LF458941
LF458942

UNKNOWN
LENGTH: 2.03"

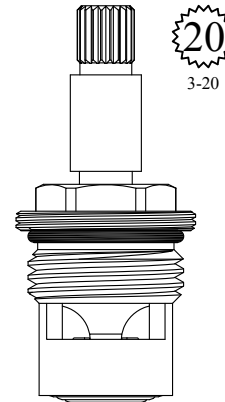

GASKET: 890170 O-RING INCLUDED
SEAL: 898500
DISC SET: 112530-PKG

LF459281
LF459282

UNKNOWN
LENGTH: 2.03"

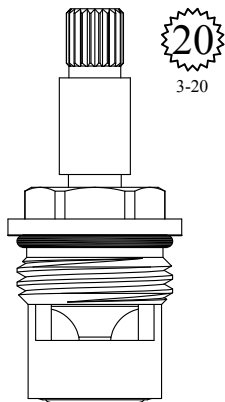

GASKET: 890170 O-RING INCLUDED
SEAL: 898500
DISC SET: 112530-PKG

LF459381
LF459382

FOR SEARS
LENGTH: 2.03"

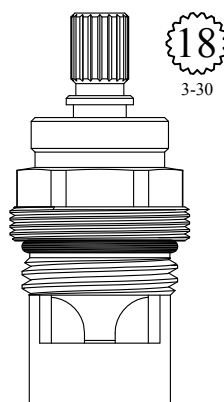

GASKET: 890170 O-RING INCLUDED
SEAL: 898510
DISC SET: 151380-PKG

LF459171
LF459172

FOR ELKAY
LENGTH: 2.03"

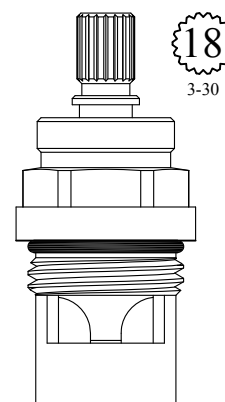

GASKET: 890170 O-RING INCLUDED
SEAL: 898510
DISC SET: 151380-PKG

LF459181
LF459182

CERAMIC DISC CARTRIDGES

FOR SEPCO
LENGTH: 2.04"

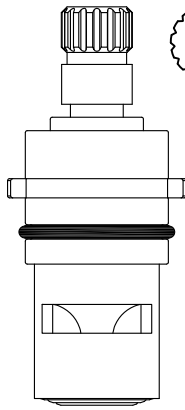

15
3-27

GASKET: 890170 O-RING INCLUDED
SEAL: 898500
DISC SET: 112530-PKG

LF458841
LF458842

FOR SPRINGHOUSE
LENGTH: 2.04"

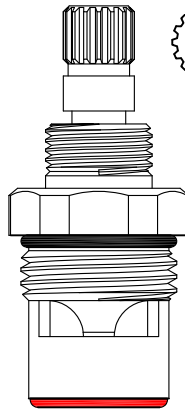

16
3-16

GASKET: 890170 O-RING INCLUDED
SEAL: 898580-R/B
DISC SET: 151380-PKG

LF459771
LF459772

UNKNOWN
LENGTH: 2.04"

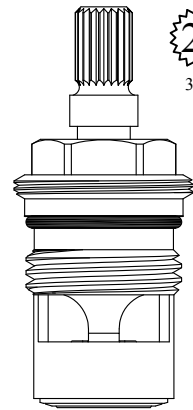

20
3-20

GASKET: 890170 O-RING INCLUDED
SEAL: 898510-W
DISC SET: 151380-PKG

LF459161
LF459162

FOR PHYLRICH

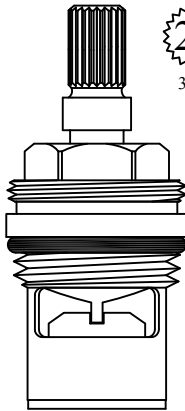

20
3-20

Style Not Available
USE LF459201/LF459202

(ALTMANS
FOR THG)
(UNIVERSAL RUNDLE)
LENGTH: 2.04"

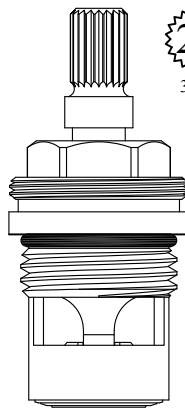

20
3-20

GASKET: 890170 O-RING INCLUDED
SEAL: 898510-W
DISC SET: 151380-PKG

LF459201
LF459202

Also available with
nickel plated gland

LF459201-N / LF459202-N

FOR CONCINNY
LENGTH: 2.04"

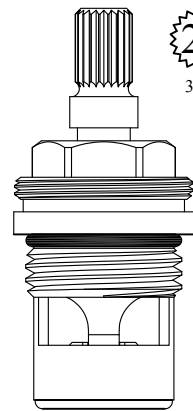

20
3-20

GASKET: 890170 O-RING INCLUDED
SEAL: 898570-W
DISC SET: 151380-PKG

LF459231
LF459232

Chrome Plated Unit

UNKNOWN
LENGTH: 2.04"

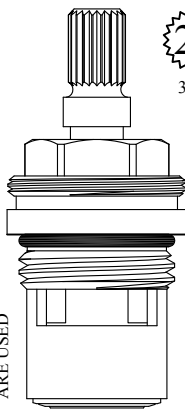

20
3-20

GASKET: 890170 O-RING INCLUDED
SEAL: 898510-W
DISC SET: 124290-PKG

LF459211
LF459212

FITS ALL BODIES
WHERE 459201/459202
ARE USED

1/2 Turn Ceramic

FOR SIGN OF THE CRAB
LENGTH: 2.04"

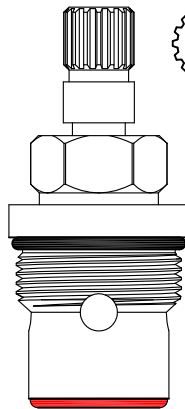

16
3-16

GASKET: 890170 O-RING INCLUDED
SEAL: 898570-R/B
DISC SET: 151380-PKG

LF459371
LF459372

Chrome Plated Stem

FOR ARSELUX
LENGTH: 2.04"

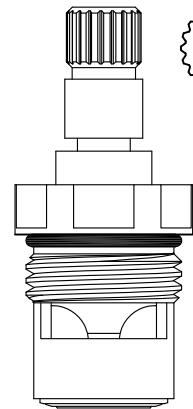

19
1-7

GASKET: 890170 O-RING INCLUDED
SEAL: 898510
DISC SET: 151380-PKG

LF461501
LF461502

Chrome Plated Gland

CERAMIC DISC CARTRIDGES

FOR MILWAUKEE
LENGTH: 2.05"

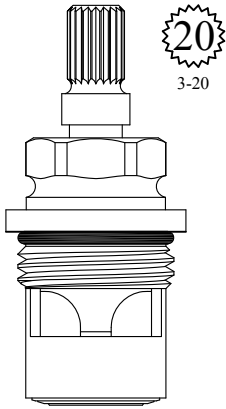

GASKET: 890170 O-RING INCLUDED
SEAL: 898510-W
DISC SET: 151380-PKG

LF458191
LF458192

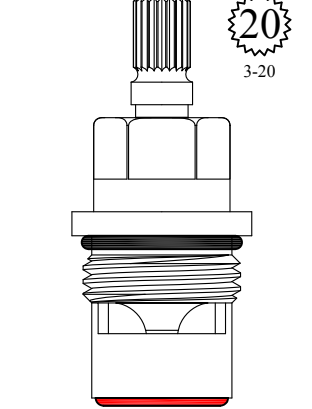

Old Style Kohler
USE LF459331/LF459332

FOR KOHLER
Nickel Plated Gland
LENGTH: 2.05"

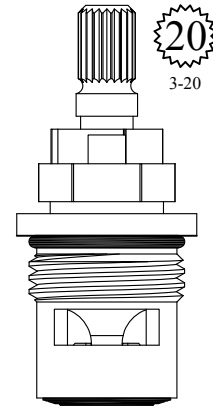

GASKET: 890170 O-RING INCLUDED
SEAL: 898510
DISC SET: 151380-PKG

LF459331
LF459332



Also available with 19pt
Kohler Adapter Broach #121230
LF460331 / LF460332

FOR BELMONT
LENGTH: 2.05"

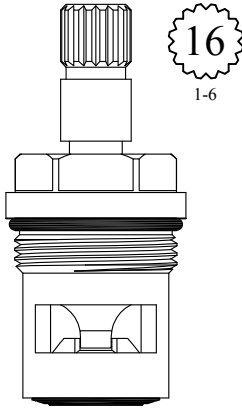

GASKET: 890170 O-RING INCLUDED
SEAL: 898510
DISC SET: 151380-PKG

LF459261
LF459262

FOR OTTONE & MELODA
LENGTH: 2.05"

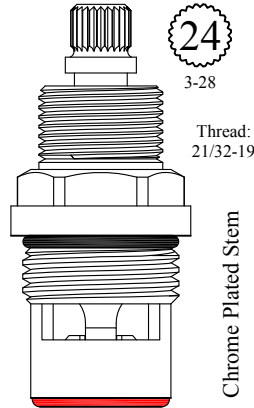

GASKET: 890170 O-RING INCLUDED
SEAL: 898570-R/B
DISC SET: 151380-PKG

LF459691
LF459692

FOR DORNBRACHT
LENGTH: 2.05"

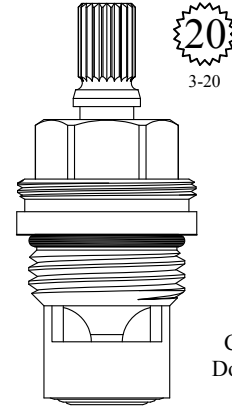

GASKET: 890170 O-RING INCLUDED
SEAL: 898500
DISC SET: 112530-PKG

LF459751
LF459752

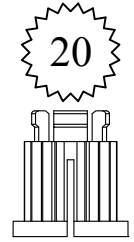

Comes with 20pt
Dornbracht adapter:
103200

UNKNOWN
LENGTH: 2.06"

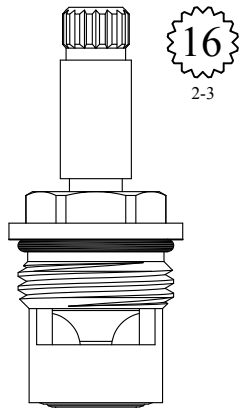

GASKET: 890170 O-RING INCLUDED
SEAL: 898500
DISC SET: 112530-PKG

LF457291
LF457292

FOR KRONIN BY VIOLA
LENGTH: 2.06"

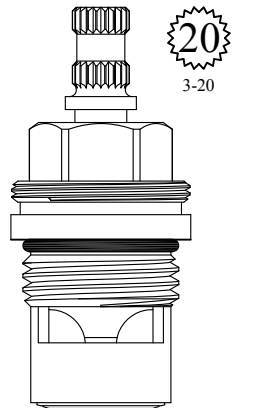

GASKET: 890170 O-RING INCLUDED
SEAL: 898510-W
DISC SET: 151380-PKG

LF459291
LF459292

UNKNOWN
LENGTH 2.07"

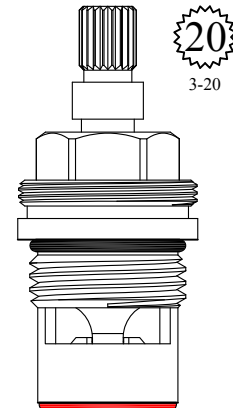

GASKET: 890170 O-RING INCLUDED
SEAL: 898570-R/B
DISC SET: 151380-PKG

LF458861
LF458862

CERAMIC DISC CARTRIDGES

FOR BRIZO (DELTA)
LENGTH: 2.07"

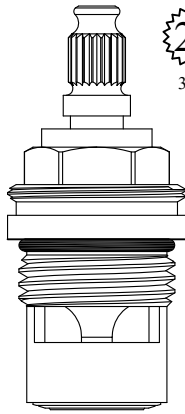

20
3-20

GASKET: 890170 O-RING INCLUDED
SEAL: 898510-W
DISC SET: 151380-PKG

LF459191
LF459192

FOR MANGORI
LENGTH: 2.07"

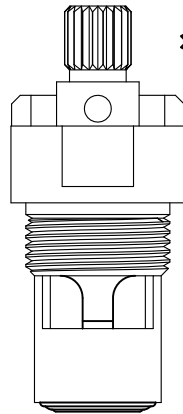

20
3-34

SEAL: 898500
DISC SET: 112530-PKG

LF459471
LF459472

FOR WELLINGTON
LENGTH: 2.08"

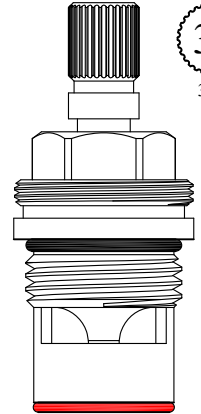

30
3-35

GASKET: 890170 O-RING INCLUDED
SEAL: 898580-R/B
DISC SET: 151380-PKG

LF459351
LF459352

Nickel Plated Unit

FOR KALLISTA
LENGTH: 2.08"

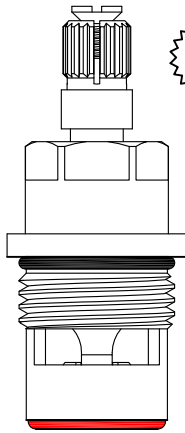

20
3-22

Comes with handle
screw: # 899230

GASKET: 890170 O-RING INCLUDED
SEAL: 898570-R/B
DISC SET: 151380-PKG

LF459401
LF459402

FOR AVILION / FRANKE
LENGTH: 2.08"

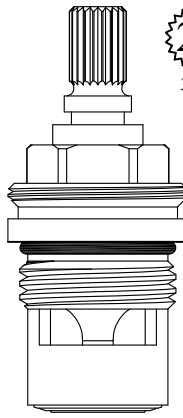

20
3-20

Chrome Plated Gland

GASKET: 890170 O-RING INCLUDED
SEAL: 898510-W
DISC SET: 151380-PKG

LF459491
LF459492

FOR FRANKE / ROHL
LENGTH: 2.08"

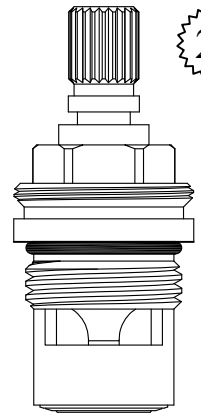

21

OEM used a plastic
broach adapter

Chrome Plated Gland

GASKET: 890170 O-RING INCLUDED
SEAL: 898510-W
DISC SET: 151380-PKG

LF459541
LF459542

UNKNOWN
LENGTH: 2.08"

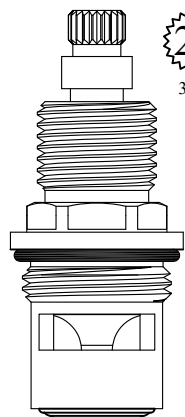

20
3-20

GASKET: 890170 O-RING INCLUDED
SEAL: 898500
DISC SET: 112530-PKG

LF459591
LF459592

FOR NICOLAZZI
LENGTH: 2.08"

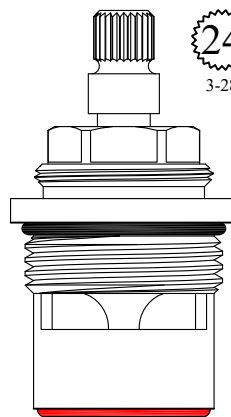

24
3-28

GASKET: 890210 O-RING INCLUDED
SEAL: 898610-R/B
DISC SET: 109850-PKG

401011
401012

FOR CRANE
CERAMIC CONVERSION FOR DIAL-EZE
LENGTH: 2.08"

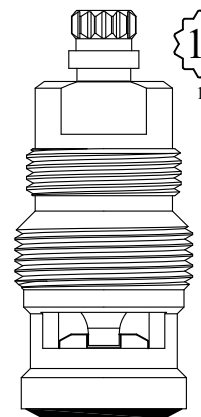

12
1-1

Supplied with Cork Gasket

GASKET: 895250 INCLUDED
DISC SET: 151380-PKG

LF459521
LF459522

CERAMIC DISC CARTRIDGES

FOR PAUL / PHYLRICH
LENGTH: 2.08"

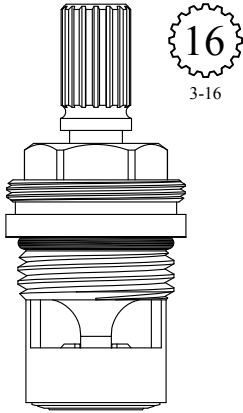

GASKET: 890170 O-RING INCLUDED
SEAL: 898510-W
DISC SET: 151380-PKG

LF461901
LF461902

FOR SANTEC
LENGTH: 2.08"

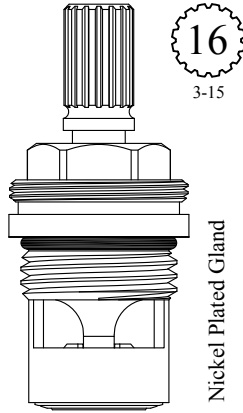

GASKET: 890170 O-RING INCLUDED
SEAL: 898510-W
DISC SET: 151380-PKG

LF461911
LF461912

Nickel Plated Gland

FOR ZURN
LENGTH: 2.08"

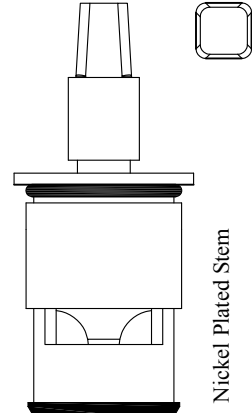

GASKET: 890170 O-RING INCLUDED
SEAL: 898590 & LF132250
DISC SET: 151380-PKG

LF459441
LF459442

Nickel Plated Stem

FOR CHICAGO
LENGTH: 2.09"

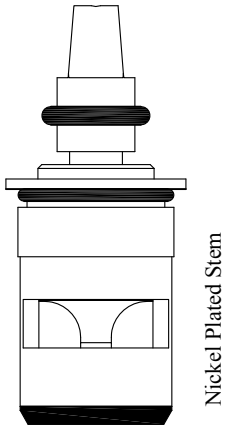

GASKET: 890170 O-RING INCLUDED
SEAL: 898590 & LF132250
DISC SET: 151380-PKG

LF459411
LF459412

Nickel Plated Stem

UNKNOWN
LENGTH: 2.09"

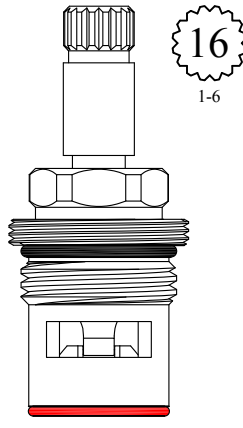

GASKET: 890170 O-RING INCLUDED
SEAL: 898580-R/B
DISC SET: 151380-PKG

LF459531
LF459532

16
1-6

FOR KALLISTA
LENGTH: 2.09"

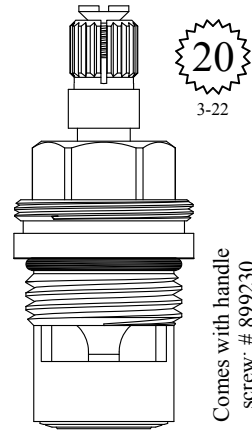

GASKET: 890170 O-RING INCLUDED
SEAL: 898510-W
DISC SET: 151380-PKG

LF459391
LF459392

20
3-22
Comes with handle
screw: # 899230

FOR JADO
LENGTH 2.10"

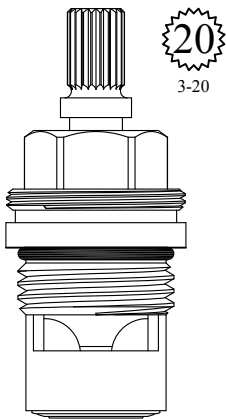

GASKET: 890170 O-RING INCLUDED
SEAL: 898510-W
DISC SET: 151380-PKG

LF459301
LF459302

20
3-20

FOR SANTEC
LENGTH 2.10"

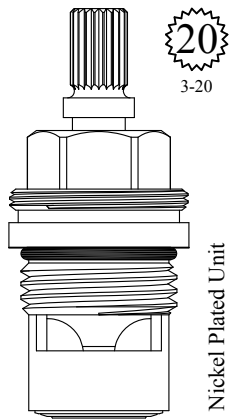

GASKET: 890170 O-RING INCLUDED
SEAL: 898510-W
DISC SET: 151380-PKG

LF459311
LF459312

20
3-20

Nickel Plated Unit

FOR BROADWAY
LENGTH: 2.10"

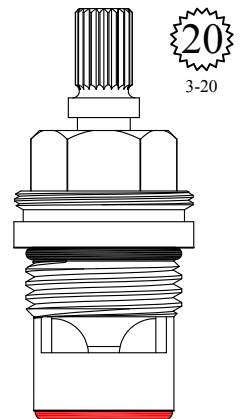

GASKET: 890170 O-RING INCLUDED
SEAL: 898570-R/B
DISC SET: 151380-PKG

LF459321
LF459322

20
3-20

CERAMIC DISC CARTRIDGES

FOR SISCO
LENGTH: 2.10"

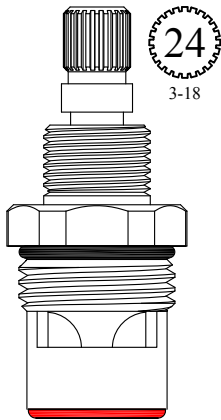

24
3-18

GASKET: 890170 O-RING INCLUDED
SEAL: 898580-R/B
DISC SET: 151380-PKG

LF459221
LF459222

FOR ELKAY
LENGTH: 2.10"

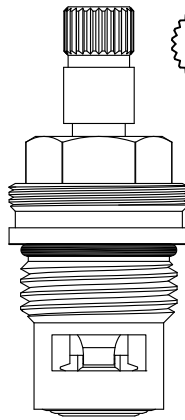

24
3-19

GASKET: 890170 O-RING INCLUDED
SEAL: 898500
DISC SET: 112530-PKG

LF459581
LF459582

UNKNOWN
LENGTH: 2.11"

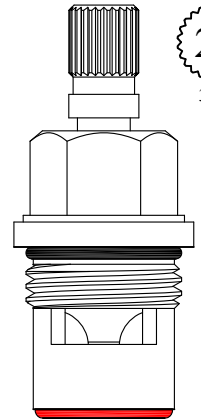

24
3-19

GASKET: 890170 O-RING INCLUDED
SEAL: 898570-R/B
DISC SET: 151380-PKG

LF459421
LF459422

UNKNOWN
LENGTH: 2.11"

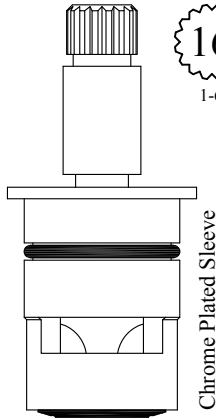

16
1-6

GASKET: 890170 O-RING INCLUDED
SEAL: 898510
DISC SET: 151380-PKG

LF459641
LF459642

Chrome Plated Sleeve

UNKNOWN
LENGTH: 2.11"

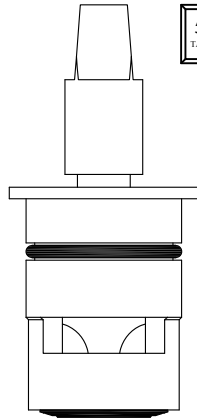

5/16
TAPERED

GASKET: 890170 O-RING INCLUDED
SEAL: 898510
DISC SET: 151380-PKG

LF459671
LF459672

Chrome Plated Unit

FOR REID WATSON
LENGTH: 2.12"

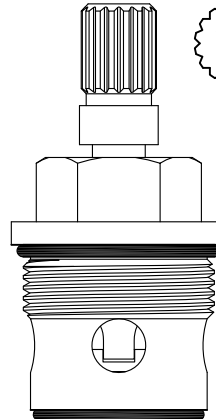

16
1-5

GASKET: 890210 O-RING INCLUDED
SEAL: 898530
DISC SET: 109850-PKG

401151
401152

FOR GROHE
LENGTH: 2.12"

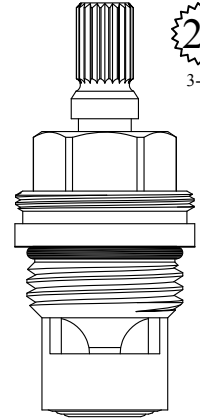

20
3-20

GASKET: 890170 O-RING INCLUDED
SEAL: 898500
DISC SET: 112530-PKG

LF459501
LF459502

FOR KOHLER
CERAMIC CONVERSION FOR LF459101/2
LENGTH: 2.12"

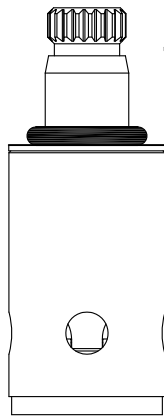

19
1-7

DISC SET: 151380-PKG

LF459601
LF459602

Chrome Plated Stem

UNKNOWN
LENGTH: 2.12"

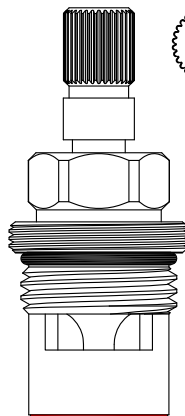

32
3-23

GASKET: 890170 O-RING INCLUDED
SEAL: 898570-R/B
DISC SET: 151380-PKG

LF460371
LF460372

FOR REID WATSON
LENGTH: 2.13"

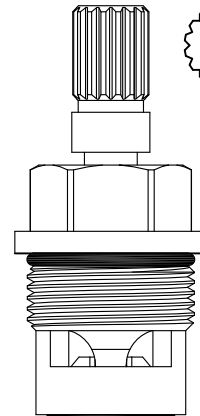

16
1-5

GASKET: 890180 O-RING INCLUDED
SEAL: 898510
DISC SET: 151380-PKG

LF459451
LF459452

CERAMIC DISC CARTRIDGES

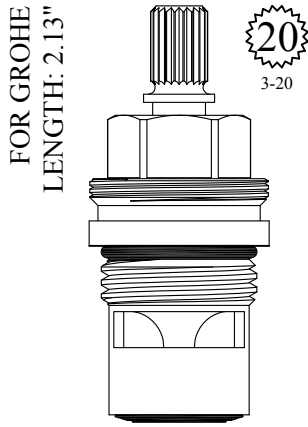

GASKET: 890170 O-RING INCLUDED
SEAL: 898510
DISC SET: 151380-PKG

LF459701
LF459702

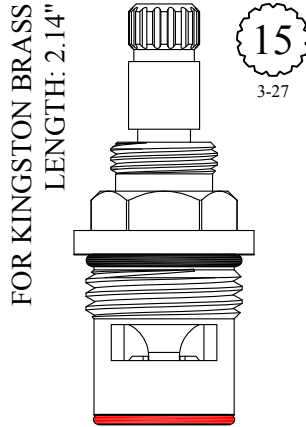

GASKET: 890170 O-RING INCLUDED
SEAL: 898580-R/B
DISC SET: 151380-PKG

LF459711
LF459712

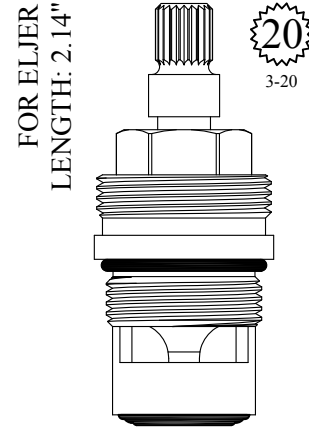

GASKET: 890170 O-RING INCLUDED
SEAL: 898510
DISC SET: 151380-PKG

LF459571
LF459572

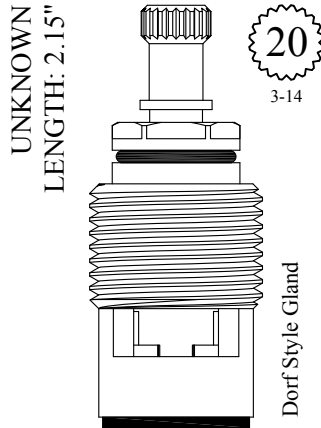

LF458981

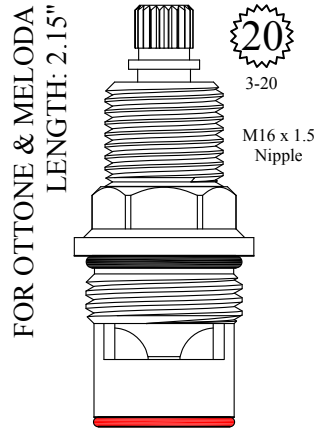

GASKET: 890170 O-RING INCLUDED
SEAL: 898580-R/B
DISC SET: 151380-PKG

LF460841
LF460842

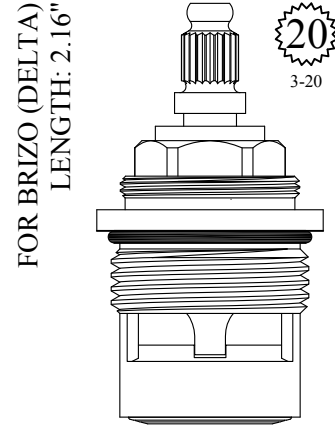

SEAL: 898520
DISC SET: 109850-PKG

401101
401102

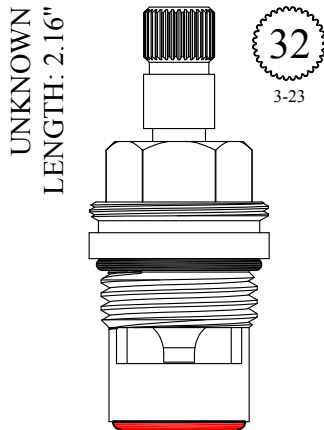

GASKET: 890170 O-RING INCLUDED
SEAL: 898570-R/B
DISC SET: 151380-PKG

LF459361
LF459362

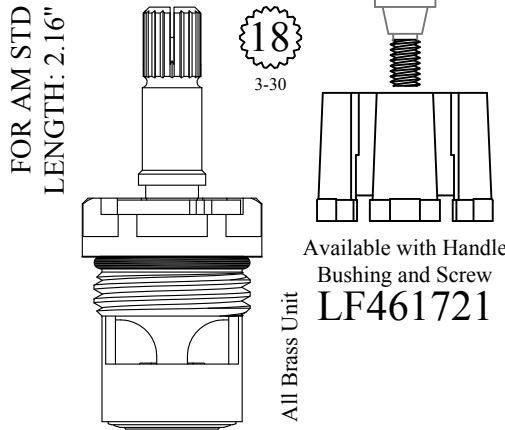

GASKET: 890170 O-RING INCLUDED
SEAL: 898510-W
DISC SET: 151380-PKG

LF461701
LF461702

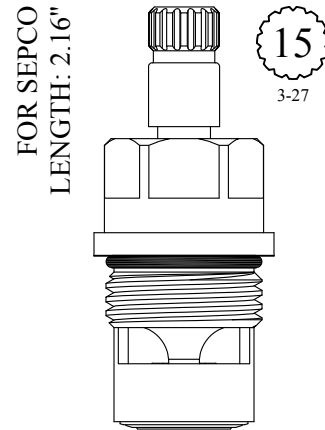

GASKET: 890170 O-RING INCLUDED
SEAL: 898510-W
DISC SET: 151380-PKG

LF462451
LF462452

CERAMIC DISC CARTRIDGES

FOR GLACIER BAY
LENGTH: 2.17"

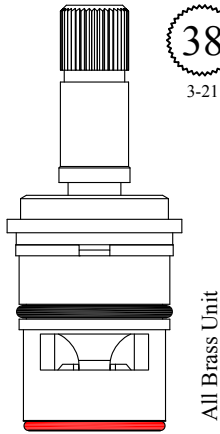

38
3-21

All Brass Unit

GASKET: 890170 O-RING INCLUDED
SEAL: 898580-R/B
DISC SET: 151380-PKG

LF460611
LF460612

FOR SAYCO
LENGTH 2.17"

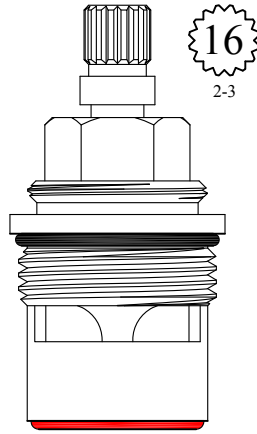

16
2-3

GASKET: 890210 O-RING INCLUDED
SEAL: 898610-R/B
DISC SET: 109850-PKG

401051
401052

FOR ELKAY
LENGTH: 2.19"

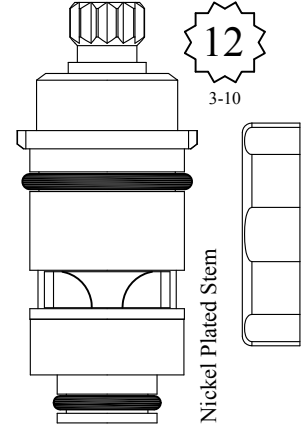

12
3-10

Nickel Plated Stem

GASKET: 890170 O-RING INCLUDED
DISC SET: 151380-PKG

LF461171
LF461172

Also available with cap nut

LF461171-N / LF461172-N

FOR KOHLER OLD STYLE
LENGTH: 2.18"

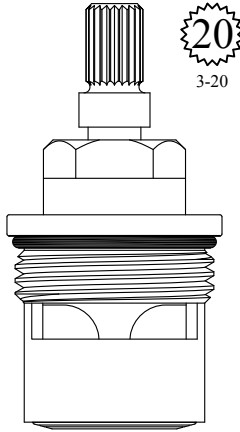

20
3-20

GASKET: 890210 O-RING INCLUDED
SEAL: 898520
DISC SET: 109850-PKG

401271
401272

FOR PHYLRICH, PAUL,
MILWAUKEE, THG
KOHLER (NEW STYLE)
LENGTH: 2.18"

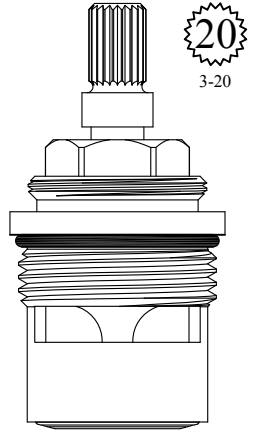

20
3-20

GASKET: 890210 O-RING INCLUDED
SEAL: 898520
DISC SET: 109850-PKG

401121
401122

FOR STERLING FAUCET
LENGTH: 2.18"

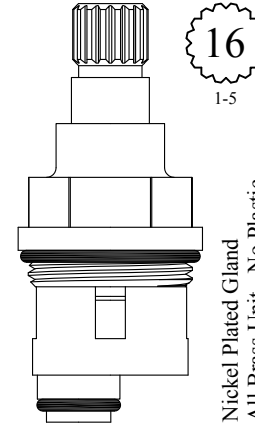

16
1-5

Nickel Plated Gland
All Brass Unit - No Plastic

GASKET: 890180 O-RING INCLUDED

LF458181
LF458182

UNKNOWN
LENGTH: 2.18"

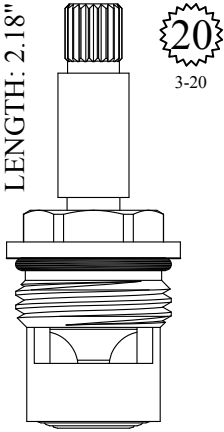

20
3-20

GASKET: 890170 O-RING INCLUDED
SEAL: 898500
DISC SET: 112530-PKG

LF459561
LF459562

UNKNOWN
LENGTH: 2.17"

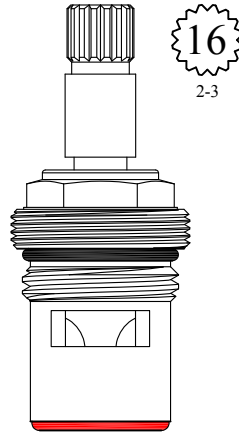

16
2-3

GASKET: 890170 O-RING INCLUDED
SEAL: 898570-R/B
DISC SET: 151380-PKG

LF459661
LF459662

FOR WATER SAVER
LENGTH: 2.18"

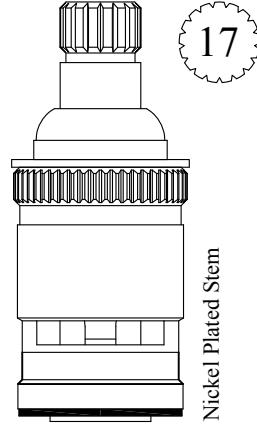

17
3-10

Nickel Plated Stem

DISC SET: 151380-PKG

LF461321
LF461321

FOR SEARS
LENGTH: 2.19"

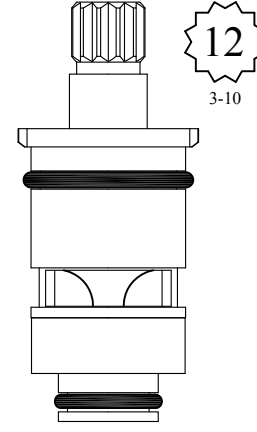

12
3-10

GASKET: 890170 O-RING INCLUDED
DISC SET: 151380-PKG

LF461071
LF461072

CERAMIC DISC CARTRIDGES

FOR SYSTEM
LENGTH: 2.19"

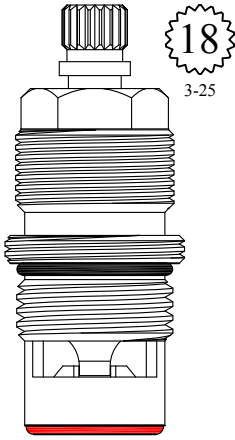

18
3-25

GASKET: 890170 O-RING INCLUDED
SEAL: 898570-R/B
DISC SET: 151380-PKG

LF460711
LF460712

FOR B & K
LENGTH: 2.20"

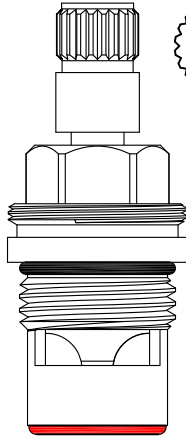

20
2-4

GASKET: 890170 O-RING INCLUDED
SEAL: 898570-R/B
DISC SET: 151380-PKG

LF460311
LF460312

Chrome Plated Stem

FOR ROHL
LENGTH: 2.21"

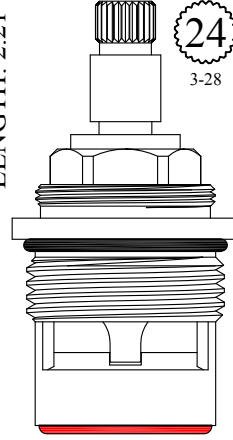

24
3-28

GASKET: 890210 O-RING INCLUDED
SEAL: 898610-R/B
DISC SET: 109850-PKG

401031
401032

FOR JADO
LENGTH 2.22"

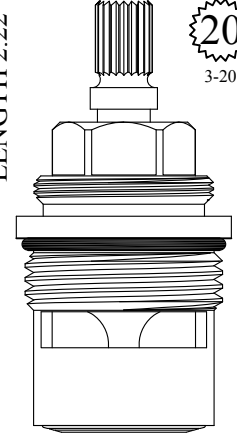

20
3-20

GASKET: 890210 O-RING INCLUDED
SEAL: 898520
DISC SET: 109850-PKG

401161
401162

FOR BRASSCRAFT
LENGTH: 2.23"

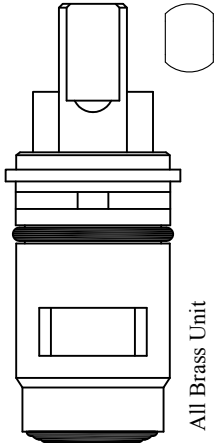

All Brass Unit

GASKET: 890170 O-RING INCLUDED
SEAL: 898510
DISC SET: 124290-PKG

LF460721

FOR SIGN OF THE CRAB
LENGTH: 2.23"

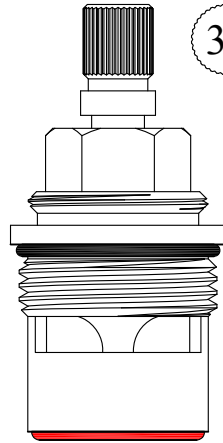

36

GASKET: 890210 O-RING INCLUDED
SEAL: 898610-R/B
DISC SET: 109850-PKG

400981
400982

FOR KALLISTA
LENGTH: 2.23"

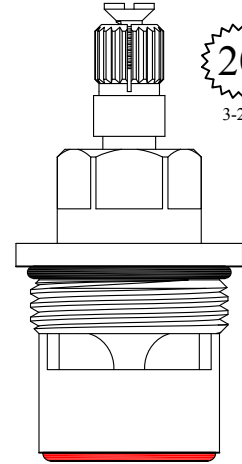

20
3-22

GASKET: 890210 O-RING INCLUDED
SEAL: 898610-R/B
DISC SET: 109850-PKG

401091
401092

Comes with handle screw: # 899230

UNKNOWN
LENGTH: 2.24"

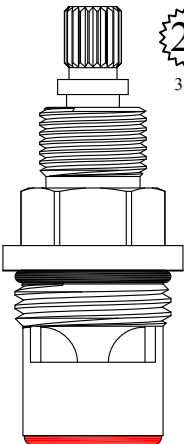

20
3-20

GASKET: 890170 O-RING INCLUDED
SEAL: 898570-R/B
DISC SET: 151380-PKG

LF460341
LF460342

Chrome Plated Unit

FOR NEWPORT
LENGTH: 2.24"

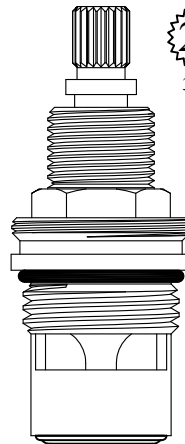

20
3-20

GASKET: 890170 O-RING INCLUDED
SEAL: 898510-W
DISC SET: 151380-PKG

LF460361
LF460362

Chrome Plated Stem

FOR ARMONIA
LENGTH: 2.24"

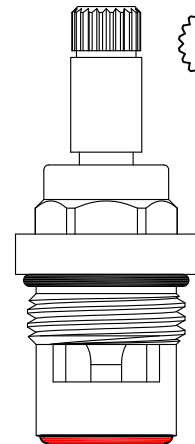

20
3-14

GASKET: 890170 O-RING INCLUDED
SEAL: 898570-R/B
DISC SET: 151380-PKG

LF461861
LF461862

CERAMIC DISC CARTRIDGES

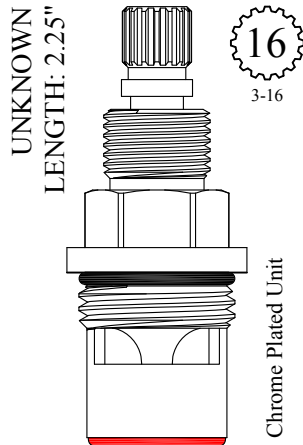

GASKET: 890170 O-RING INCLUDED
SEAL: 898570-R/B
DISC SET: 151380-PKG

LF461341
LF461342

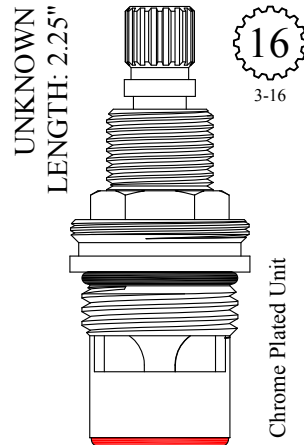

GASKET: 890170 O-RING INCLUDED
SEAL: 898570-R/B
DISC SET: 151380-PKG

LF461361
LF461362

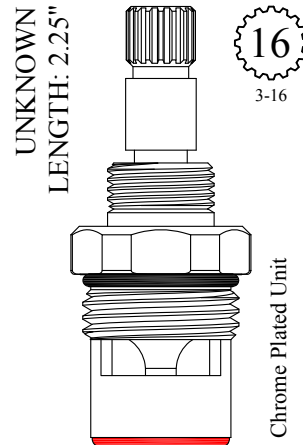

GASKET: 890170 O-RING INCLUDED
SEAL: 898570-R/B
DISC SET: 151380-PKG

LF462311
LF462312

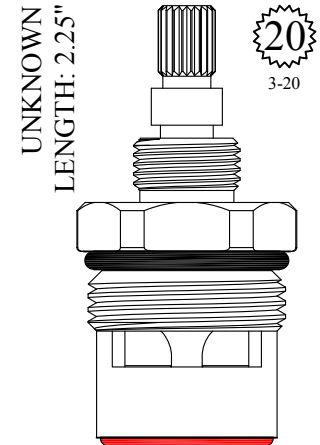

GASKET: 890170 O-RING INCLUDED
SEAL: 898610-R/B
DISC SET: 109850-PKG

401441
401442

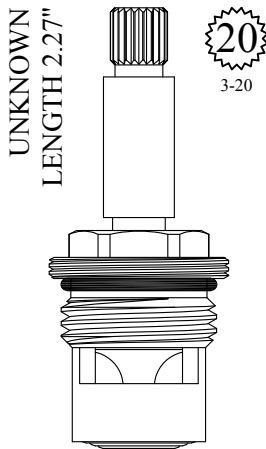

GASKET: 890170 O-RING INCLUDED
SEAL: 898500
DISC SET: 112530-PKG

LF462281
LF462282

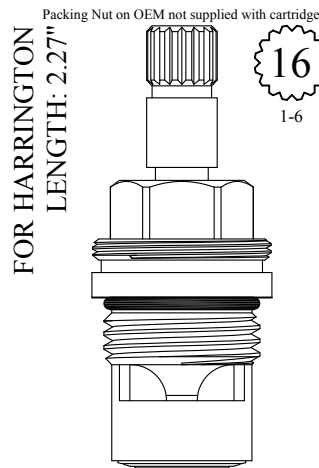

GASKET: 890170 O-RING INCLUDED
SEAL: 898510-W
DISC SET: 151380-PKG

LF462541
LF462542

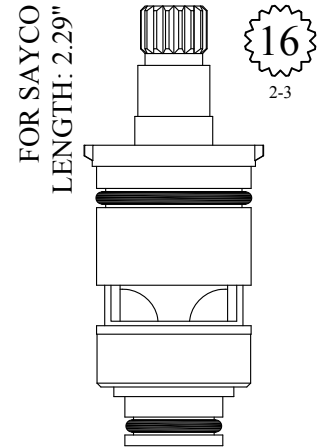

GASKET: 890170 O-RING INCLUDED
DISC SET: 151380-PKG

LF459611
LF459612

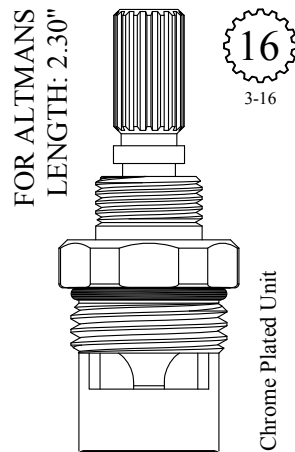

GASKET: 890170 O-RING INCLUDED
SEAL: 898580-R/B
DISC SET: 151380-PKG

LF462411
LF462412

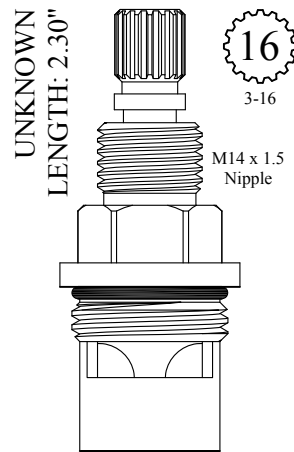

GASKET: 890170 O-RING INCLUDED
SEAL: 898570-R/B
DISC SET: 151380-PKG

LF462641
LF462642

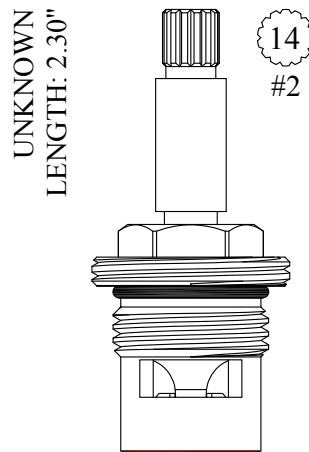

GASKET: 890170 O-RING INCLUDED
SEAL: 898570-R/B
DISC SET: 151380-PKG

LF462431
LF462432

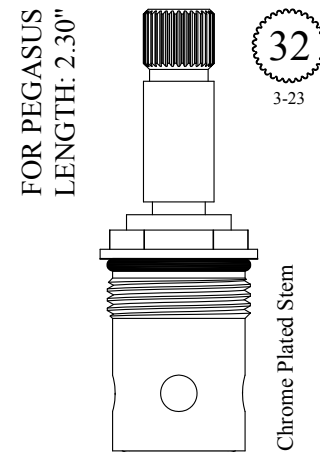

GASKET: 890160 O-RING INCLUDED
SEAL: 898500
DISC SET: 112530-PKG

LF462901
LF462902

CERAMIC DISC CARTRIDGES

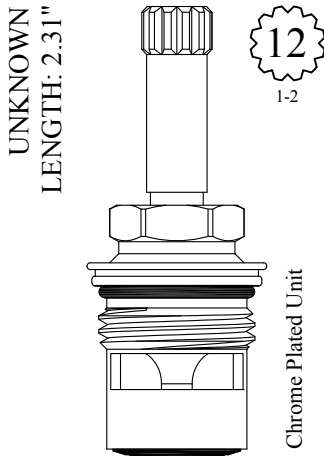

UNKNOWN
LENGTH: 2.31"

12
1-2

Chrome Plated Unit

GASKET: 890170 O-RING INCLUDED
SEAL: 898510
DISC SET: 151380-PKG

LF462551
LF462552

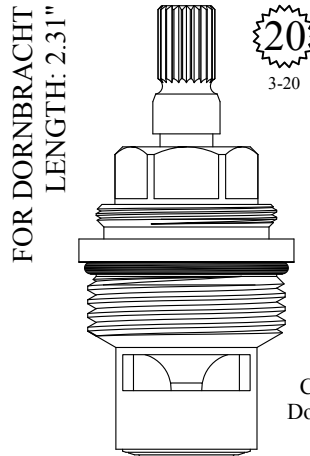

FOR DORNBRACHT
LENGTH: 2.31"

20
3-20

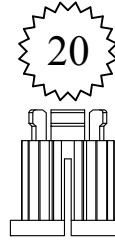

Comes with 20pt
Dornbracht adapter:
103200

GASKET: 890210 O-RING INCLUDED
SEAL: 898510-W
DISC SET: 151380-PKG

401171
401172

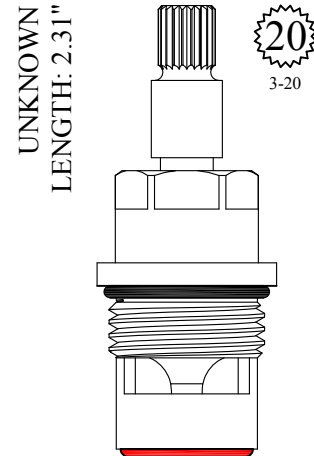

UNKNOWN
LENGTH: 2.31"

20
3-20

GASKET: 890170 O-RING INCLUDED
SEAL: 898570-R/B
DISC SET: 151380-PKG

LF461401
LF461402

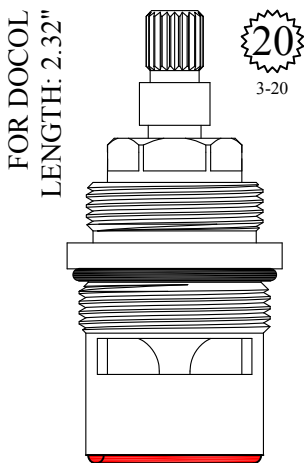

FOR DOCOL
LENGTH: 2.32"

20
3-20

GASKET: 890210 O-RING INCLUDED
SEAL: 898610
DISC SET: 109850-PKG

401041
401042

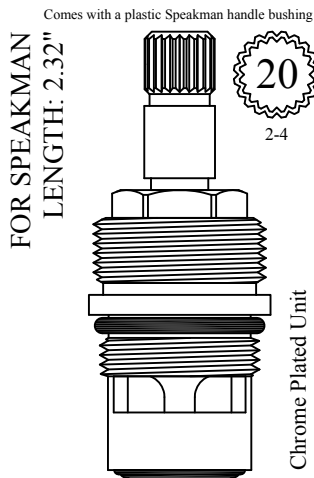

FOR SPEAKMAN
LENGTH: 2.32"

20
2-4

GASKET: 890170 O-RING INCLUDED
SEAL: 898510
DISC SET: 151380-PKG

LF462501
LF462502

Chrome Plated Unit

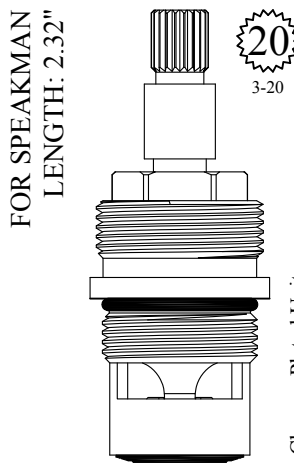

FOR SPEAKMAN
LENGTH: 2.32"

20
3-20

GASKET: 890170 O-RING INCLUDED
SEAL: 898510
DISC SET: 151380-PKG

LF462511
LF462512

Chrome Plated Unit

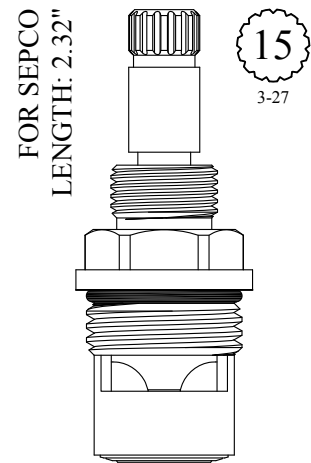

FOR SEPCO
LENGTH: 2.32"

15
3-27

GASKET: 890170 O-RING INCLUDED
SEAL: 898510-W
DISC SET: 151380-PKG

LF459721
LF459722

CERAMIC DISC CARTRIDGES

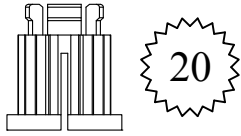

Comes with 20pt Dornbracht adapter: 103200

FOR DORNBRACHT
LENGTH: 2.34"

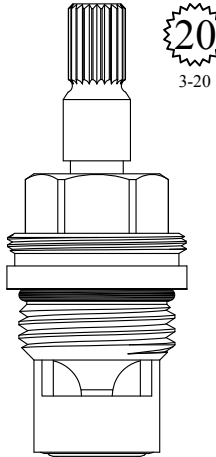

GASKET: 890170 O-RING INCLUDED
SEAL: 898500
DISC SET: 112530-PKG

LF462601
LF462602

FOR DELTA (CER-TECK)
FOR CAMBRIDGE
LENGTH: 2.36"

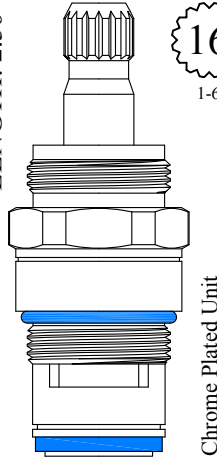

Chrome Plated Unit

LF462711
LF462712

FOR PIEL
LENGTH: 2.36"

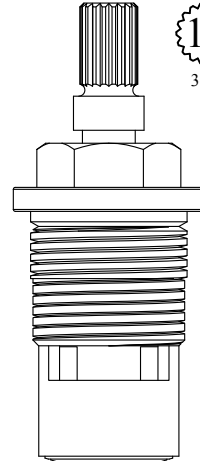

GASKET: 895150 INCLUDED
SEAL: 898510-W
DISC SET: 151380-PKG

LF462661
LF462662

FOR SPRINGHOUSE
LENGTH: 2.37"

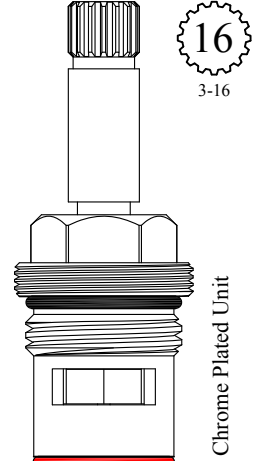

GASKET: 890170 O-RING INCLUDED
SEAL: 898580-R
DISC SET: 115520-PKG

LF462681
LF462682

FOR SHERLE WAGNER
LENGTH: 2.40"

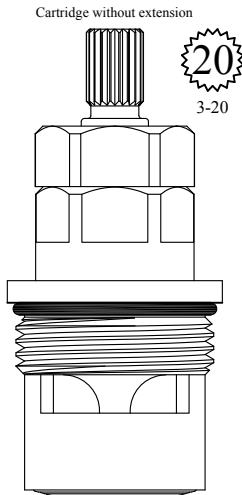

GASKET: 890210 O-RING INCLUDED
SEAL: 898520
DISC SET: 109850-PKG

401381
401382

FOR HELVEX
LENGTH: 2.40"

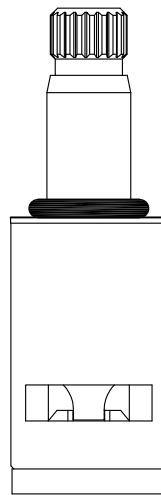

DISC SET: 151380-PKG

LF463801
LF463802

FOR SHERLE WAGNER
LENGTH: 2.41"

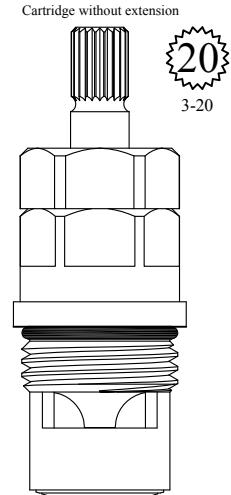

GASKET: 890170 O-RING INCLUDED
SEAL: 898510-W
DISC SET: 151380-PKG

LF462521
LF462522

CERAMIC DISC CARTRIDGES

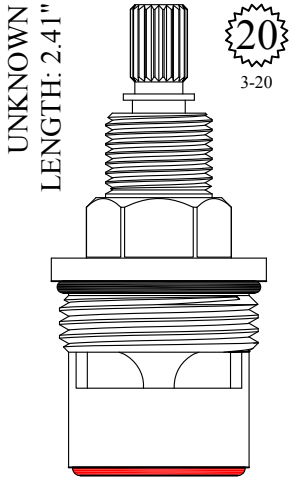

GASKET: 890210 INCLUDED
SEAL: 898610-R/B
DISC SET: 109850-PKG

400961
400962

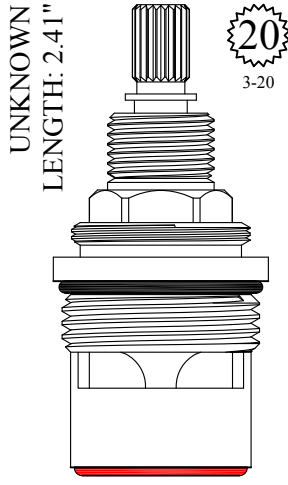

GASKET: 890210 INCLUDED
SEAL: 898610-R/B
DISC SET: 109850-PKG

400991
400992

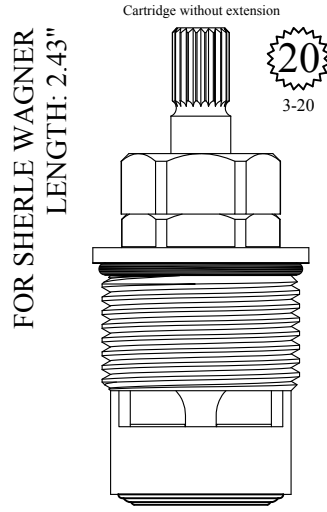

GASKET: 890210 O-RING INCLUDED
SEAL: 898520
DISC SET: 109850-PKG

401581
401582

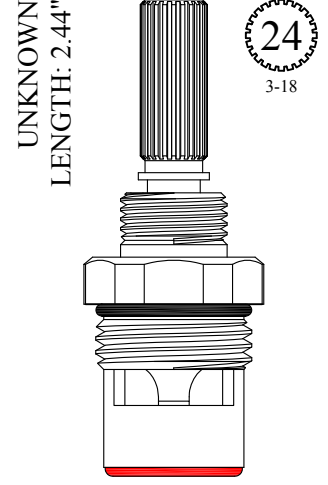

GASKET: 890170 O-RING INCLUDED
SEAL: 898570-R/B
DISC SET: 151380-PKG

LF463661
LF463662

Also available as a RH/LH Kit

LF463321-2

Kit includes: (1) 263321, (1) 263322, (1) 604520

Available: Stem Only

LF263321 / LF263322

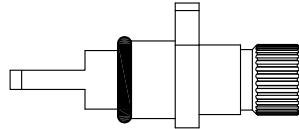

Individual item available
cap nut: #763320

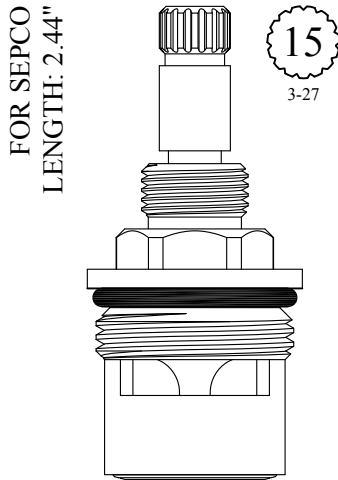

GASKET: 891180 O-RING INCLUDED
SEAL: 898520
DISC SET: 109850-PKG

401251
401252

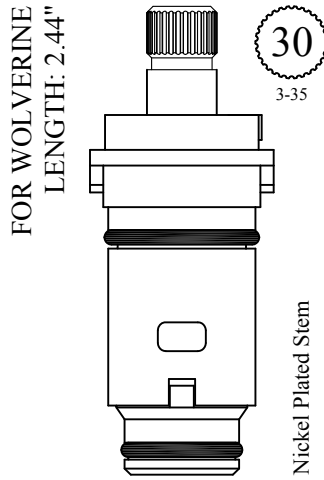

Nickel Plated Stem

LF463321
LF463322

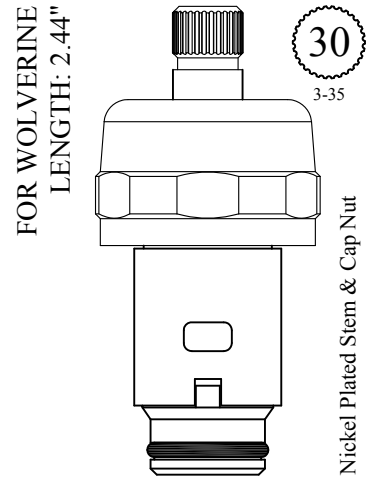

Nickel Plated Stem & Cap Nut

LF463321-N
LF463322-N

CERAMIC DISC CARTRIDGES

Also available as a RH/LH Kit

LF463361-2

Kit includes: (1) 263361, (1) 263362, (1) 604520

Available: Stem Only

LF263361 / LF263362

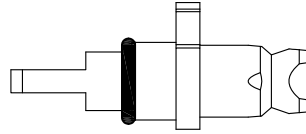

FOR KOHLER
LENGTH: 2.45"

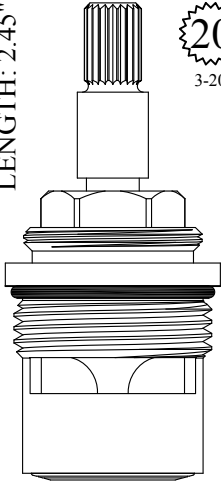

20
3-20

GASKET: 890210 O-RING INCLUDED
SEAL: 898520
DISC SET: 109850-PKG

401291
401292

FOR WOLVERINE
LENGTH: 2.47"

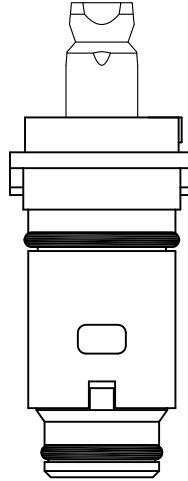

Nickel Plated Stem

LF463361
LF463362

FOR SUPER GRIF
LENGTH: 2.45"

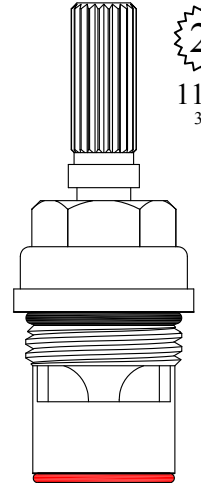

20
11/32
3-34

Chrome Plated Gland

GASKET: 890170 O-RING INCLUDED
SEAL: 898580-R/B
DISC SET: 151380-PKG

LF463641
LF463642

FOR SUPER GRIF
LENGTH 2.46"

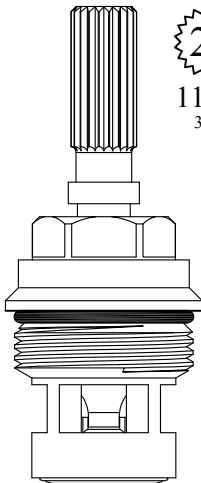

20
11/32
3-34

All Brass Unit
Chrome Plated Gland

GASKET: 890190 O-RING INCLUDED
SEAL: 898510-W
DISC SET: 151380-PKG

LF463621
LF463622

UNKNOWN
LENGTH: 2.49"

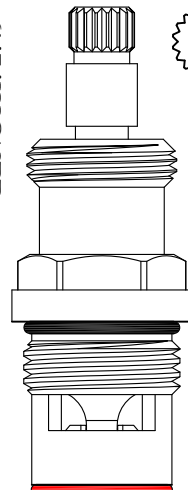

18
3-25

Thread:
25/32-18

GASKET: 890170 O-RING INCLUDED
SEAL: 898580-R/B
DISC SET: 151380-PKG

LF401361
LF401362

FOR WATERMARK
LENGTH: 2.49"

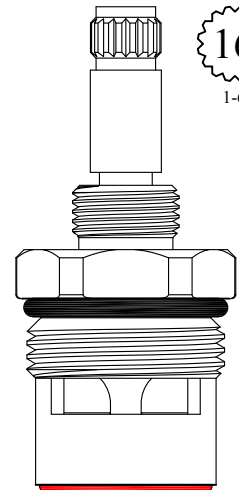

16
1-6

GASKET: 890170 O-RING INCLUDED
SEAL: 898610-R/B
DISC SET: 109850-PKG

401261
401262

CERAMIC DISC CARTRIDGES

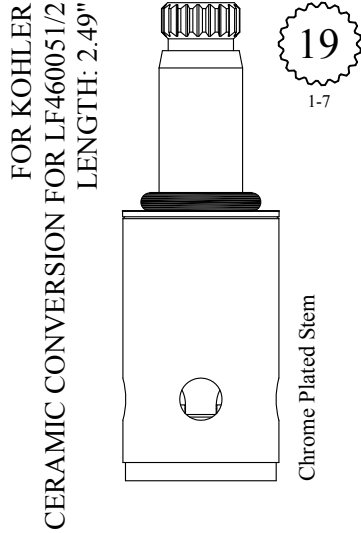

DISC SET: 151380-PKG

LF463811
LF463812

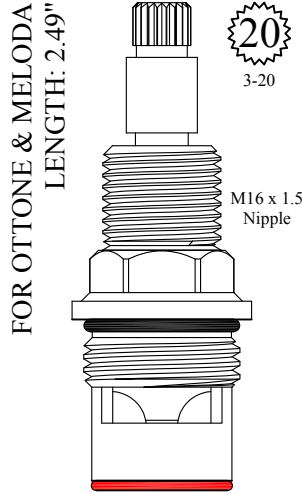

GASKET: 890170 O-RING INCLUDED
SEAL: 898580-R/B
DISC SET: 151380-PKG

LF462841
LF462842

Individual items available
Stem Ext. 29/32": #128350-PB
& 128350-CP
Ext. Adapt. Screw: #103310

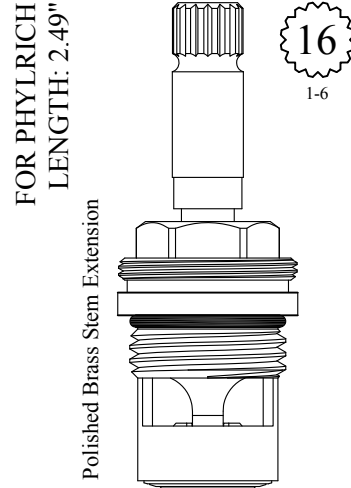

GASKET: 890170 O-RING INCLUDED
SEAL: 898510-W
DISC SET: 151380-PKG

LF463651
LF463652

Also available with chrome plated stem extension
LF463651-CP / LF463652-CP

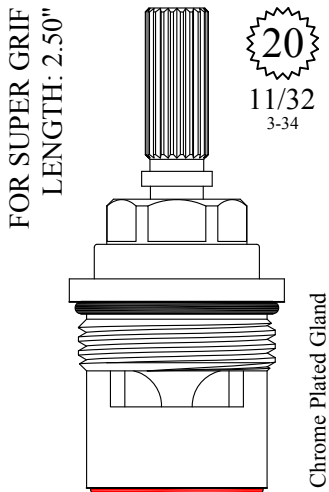

GASKET: 890210 O-RING INCLUDED
SEAL: 898610-R/B
DISC SET: 109850-PKG

401281
401282

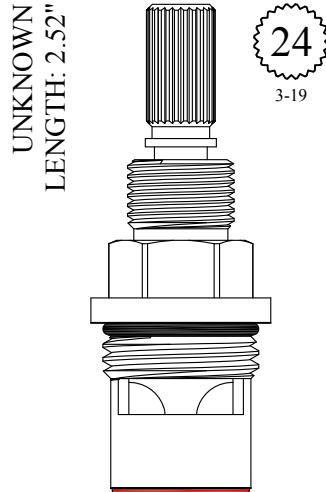

GASKET: 890170 O-RING INCLUDED
SEAL: 898570-R/B
DISC SET: 151380-PKG

LF464351
LF464352

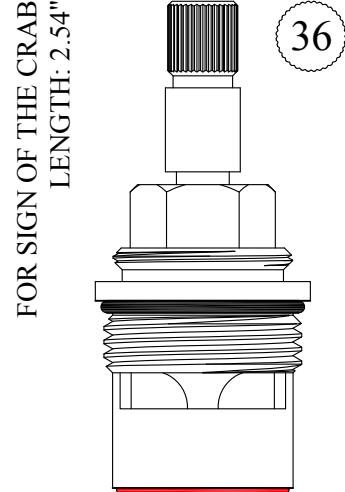

GASKET: 890210 O-RING INCLUDED
SEAL: 898610-R/B
DISC SET: 109850-PKG

401481
401482

CERAMIC DISC CARTRIDGES

FOR GLACIER BAY
LENGTH: 2.54"

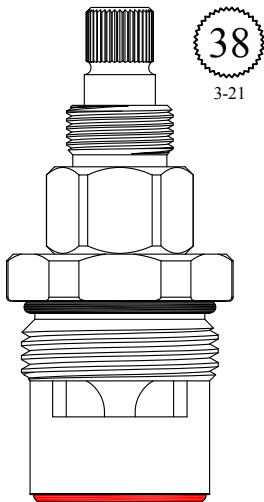

GASKET: 890200 O-RING INCLUDED
SEAL: 898610-R/B
DISC SET: 109850-PKG

401421
401422

FOR DONNER
LENGTH: 2.54"

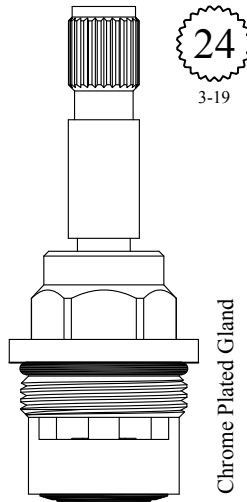

GASKET: 890180 O-RING INCLUDED
SEAL: 898510
DISC SET: 151380-PKG

LF464371
LF464372

FOR ARMONIA
LENGTH: 2.55"

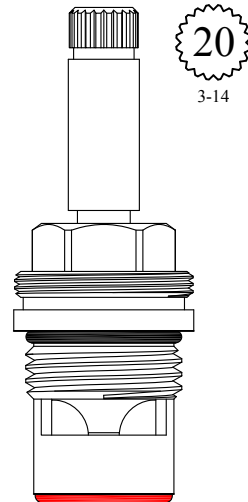

GASKET: 890170 O-RING INCLUDED
SEAL: 898570-R/B
DISC SET: 151380-PKG

LF462861
LF462862

Individual items available
Stem Ext.: #118760
Esc Cap Nut: #124940

FOR ARMONIA
LENGTH: 2.55"

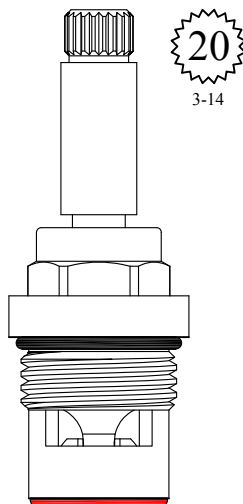

GASKET: 890170 O-RING INCLUDED
SEAL: 898570-R/B
DISC SET: 151380-PKG

LF462881
LF462882

FOR ARMONIA
LENGTH: 2.55"

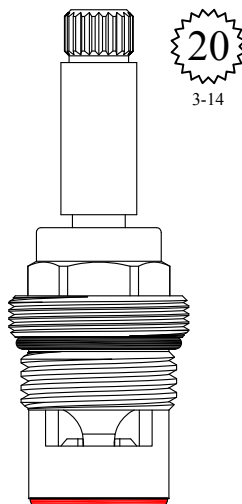

GASKET: 890170 O-RING INCLUDED
SEAL: 898570-R/B
DISC SET: 151380-PKG

LF462891
LF462892

FOR MILWAUKEE
LENGTH 2.57"

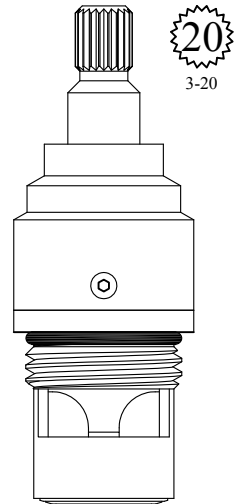

GASKET: 890170 O-RING INCLUDED
SEAL: 898510-W
DISC SET: 151380-PKG

LF463941
LF463942

CERAMIC DISC CARTRIDGES

FOR OTTONE & MELODA
LENGTH: 2.60"

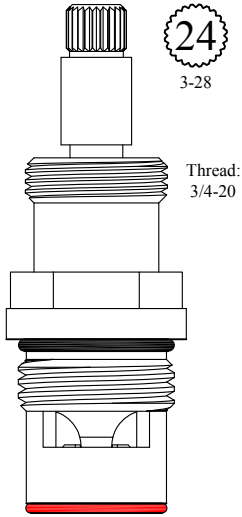

GASKET: 890170 O-RING INCLUDED
SEAL: 898580-R/B
DISC SET: 151380-PKG

LF401391
LF401392

FOR SIGMA
LENGTH: 2.60"

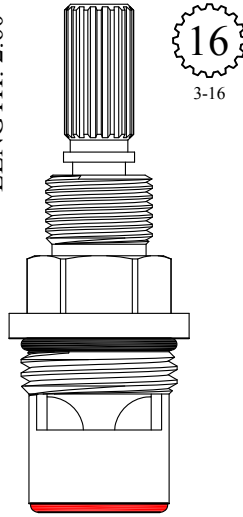

GASKET: 890170 O-RING INCLUDED
SEAL: 898570-R/B
DISC SET: 151380-PKG

LF464341
LF464342

FOR NEWPORT
LENGTH: 2.60"

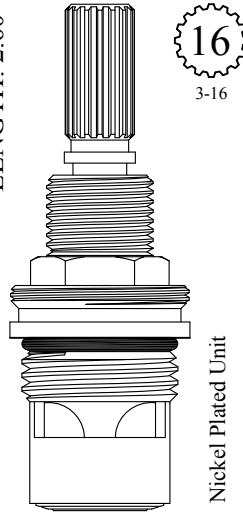

GASKET: 890170 O-RING INCLUDED
SEAL: 898510-W
DISC SET: 151380-PKG

LF464361
LF464362

FOR SEPCO
LENGTH: 2.60"

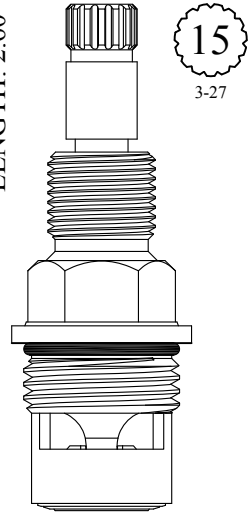

GASKET: 890170 O-RING INCLUDED
SEAL: 898510-W
DISC SET: 151380-PKG

LF464381
LF464382

Individual items available
Stem Ext. 1-1/16": #105270-PB
& #105270-CP
Ext. Adap. Screw: #103310

FOR SIGN OF THE CRAB
LENGTH: 2.60"

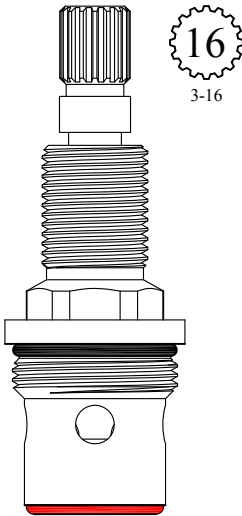

GASKET: 890170 O-RING INCLUDED
SEAL: 898570-R/B
DISC SET: 151380-PKG

LF464511
LF464512

FOR AM STD
LENGTH: 2.62"

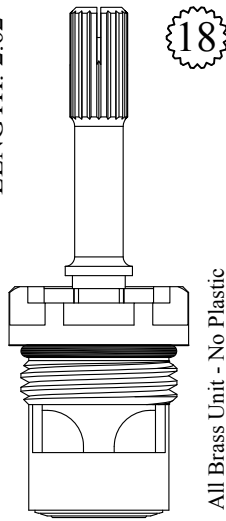

GASKET: 890170 O-RING INCLUDED
SEAL: 898510-W
DISC SET: 151380-PKG

401501
401502

FOR PHYLRICH
LENGTH: 2.64"

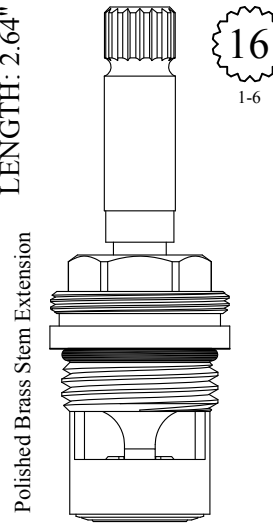

GASKET: 890170 O-RING INCLUDED
SEAL: 898510-W
DISC SET: 151380-PKG

LF464661
LF464662

Also available with chrome plated stem extension
LF464661-CP / LF464662-CP

CERAMIC DISC CARTRIDGES

UNKNOWN
LENGTH: 2.67"

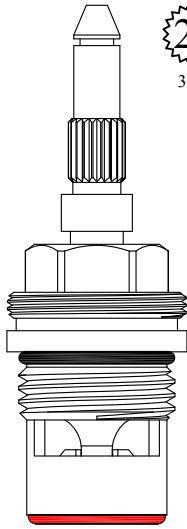

20
3-20

GASKET: 890170 O-RING INCLUDED
SEAL: 898570-R/B
DISC SET: 151380-PKG

LF464681
LF464682

FOR CRANE
CERAMIC CONVERSION FOR DIAL-EZE
LENGTH: 2.67"

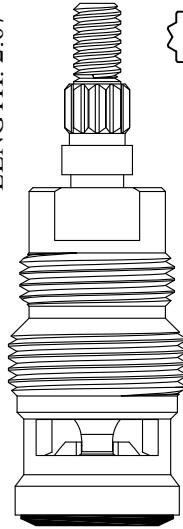

12
1-1

GASKET: 895250 INCLUDED
DISC SET: 151380-PKG

LF464311
LF464312

Supplied as a one-piece stem
Does not use an extension

FOR SEACREST
LENGTH: 2.68"

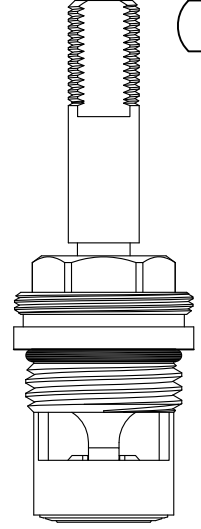

Nickel Plated Unit

GASKET: 890170 O-RING INCLUDED
SEAL: 898510-W
DISC SET: 151380-PKG

LF464611
LF464612

FOR BARBER WILSON
LENGTH: 2.70"

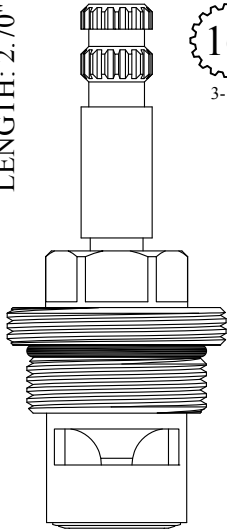

16
3-16

GASKET: 890190 O-RING INCLUDED
SEAL: 898510-W
DISC SET: 151380-PKG

LF464571
LF464572

FOR OTTONE & MELODA
LENGTH: 2.70"

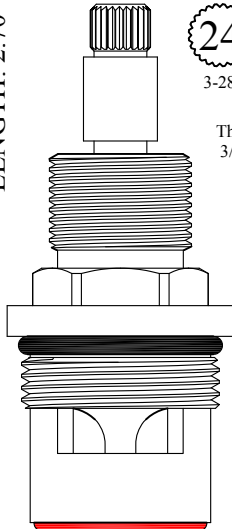

24
3-28

Thread:
3/4-19

GASKET: 891180 O-RING INCLUDED
SEAL: 898610-R/B
DISC SET: 109850-PKG

401471
401472

UNKNOWN
LENGTH: 2.72"

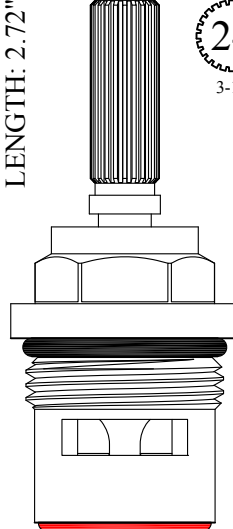

24
3-18

GASKET: 891180 O-RING INCLUDED
SEAL: 898610-R/B
DISC SET: 109850-PKG

401591
401592

UNKNOWN
LENGTH: 2.72"

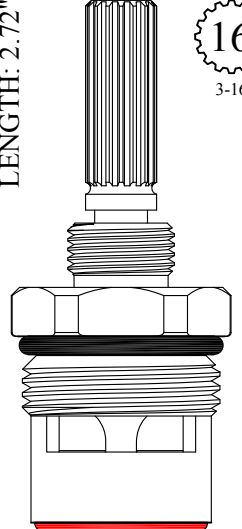

16
3-16

GASKET: 891180 O-RING INCLUDED
SEAL: 898610-R/B
DISC SET: 109850-PKG

401561
401562

CERAMIC DISC CARTRIDGES

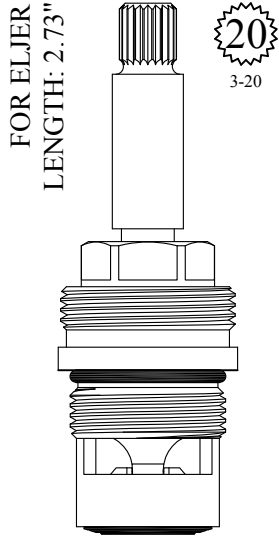

GASKET: 890170 O-RING INCLUDED
SEAL: 898510
DISC SET: 151380-PKG

LF464921
LF464922

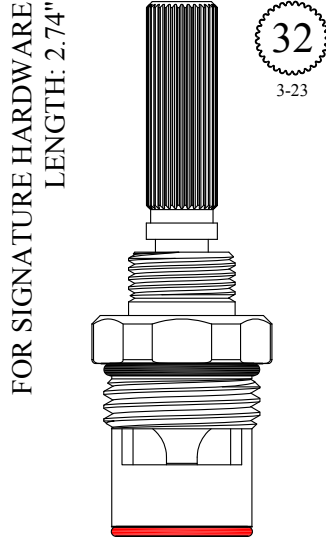

GASKET: 890170 O-RING INCLUDED
SEAL: 898570-R/B
DISC SET: 151380-PKG

LF464421
LF464422

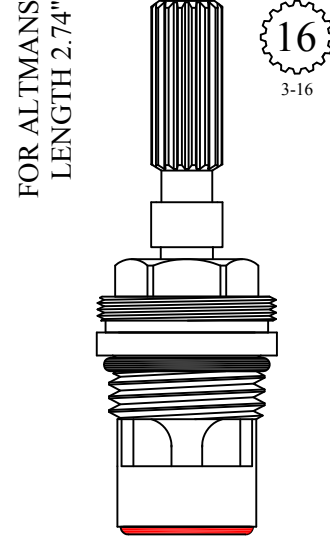

GASKET: 890170 O-RING INCLUDED
SEAL: 898570-R/B
DISC SET: 151380-PKG

LF464911
LF464912

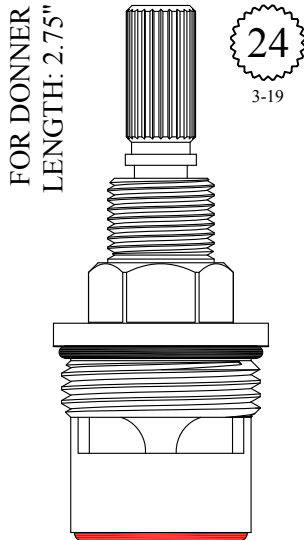

GASKET: 890210 O-RING INCLUDED
SEAL: 898610-R/B
DISC SET: 109850-PKG

401491
401492

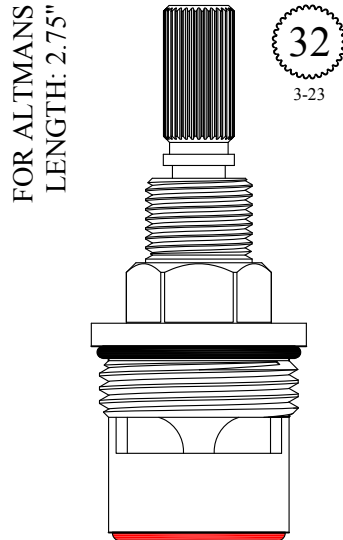

GASKET: 890210 O-RING INCLUDED
SEAL: 898610-R/B
DISC SET: 109850-PKG

401571
401572

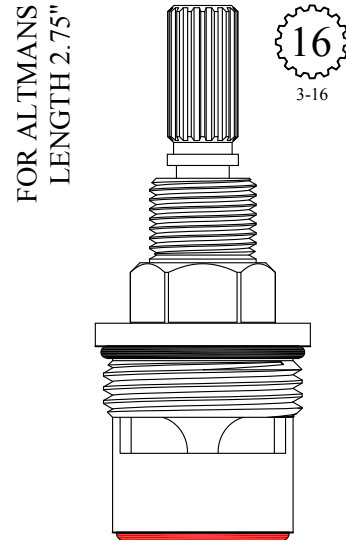

GASKET: 890210 O-RING INCLUDED
SEAL: 898610-R/B
DISC SET: 109850-PKG

401641
401642

CERAMIC DISC CARTRIDGES

FOR NEWPORT
LENGTH: 2.75"

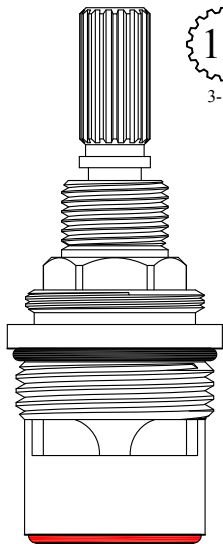

16
3-16

Also available in a Chrome Plated Unit
401651-CP / 401652-CP

GASKET: 890210 O-RING INCLUDED
SEAL: 898610-R/B
DISC SET: 109850-PKG

401651
401652

Extension Available
#135000

FOR KOHLER
LENGTH 2.77"

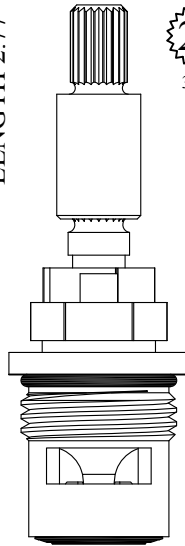

20
3-20

Nickel Plated Gland

GASKET: 890170 O-RING INCLUDED
SEAL: 898510
DISC SET: 151380-PKG

LF464941

FOR CHICAGO
LENGTH: 2.77"

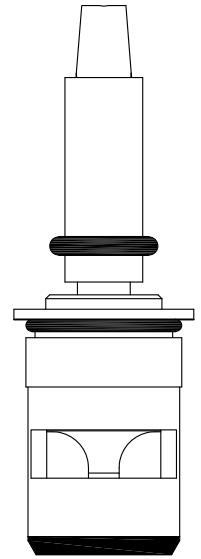

Nickel Plated Stem

GASKET: 890170 O-RING INCLUDED
SEAL: 898590 & LF132250
DISC SET: 151380-PKG

LF465461
LF465462

FOR ARTISTIC BRASS
LENGTH: 2.79"

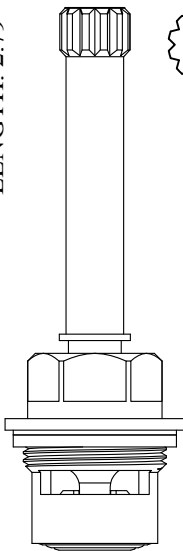

12
1-2

GASKET: 895100 INCLUDED
SEAL: 898500
DISC SET: 112530-PKG

401661
401662

UNKNOWN
LENGTH: 2.79"

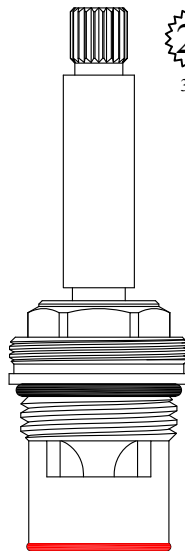

20
3-20

GASKET: 890170 O-RING INCLUDED
SEAL: 898580-R/B
DISC SET: 151380-PKG

LF465331
LF465332

FOR ZURN
LENGTH: 2.81"

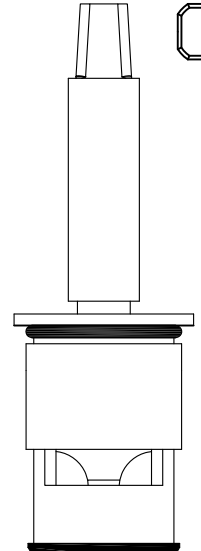

Nickel Plated Stem

GASKET: 890170 O-RING INCLUDED
SEAL: 898590 & LF132250
DISC SET: 151380-PKG

LF465441
LF465442

CERAMIC DISC CARTRIDGES

Individual items available
 Stem Ext. 1-1/4": #105340-PB
 & 105340-CP
 Ext. Adap. Screw: #103310

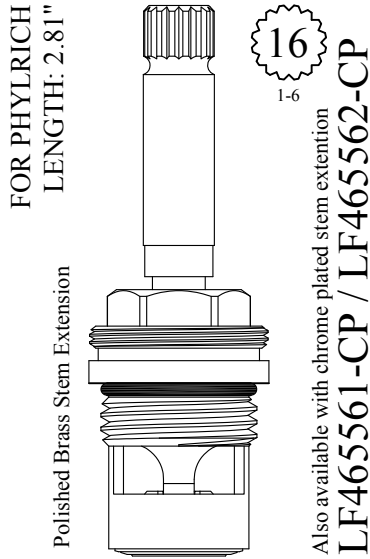

GASKET: 890170 O-RING INCLUDED
 SEAL: 898510-W
 DISC SET: 151380-PKG

LF465561
LF465562

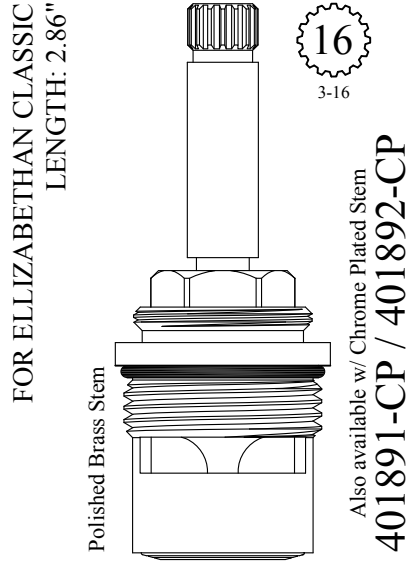

GASKET: 890210 O-RING INCLUDED
 SEAL: 898520
 DISC SET: 109850-PKG

401891
401892

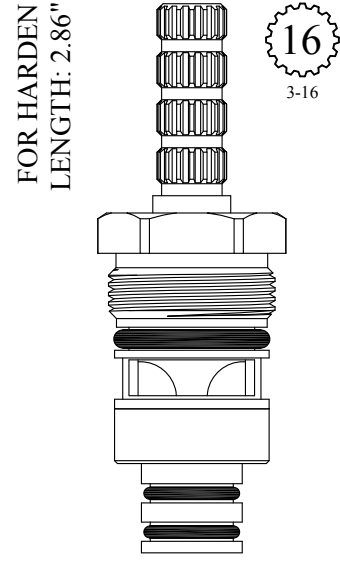

GASKET: 891140 O-RING INCLUDED
 DISC SET: 151380-PKG

LF465401
LF465402

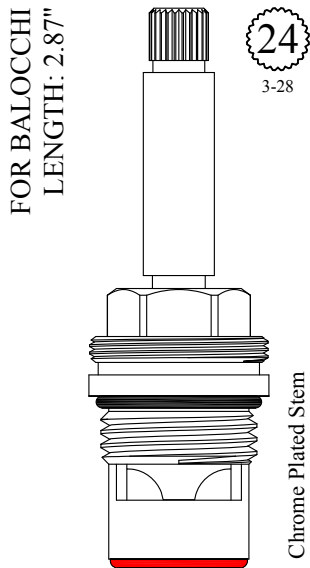

GASKET: 890170 O-RING INCLUDED
 SEAL: 898570-R/B
 DISC SET: 151380-PKG

LF465341
LF465342

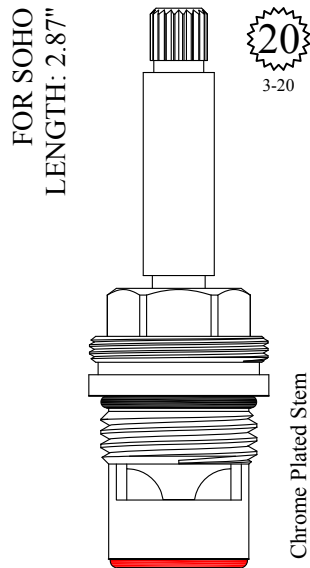

GASKET: 890170 O-RING INCLUDED
 SEAL: 898570-R/B
 DISC SET: 151380-PKG

LF465371
LF465372

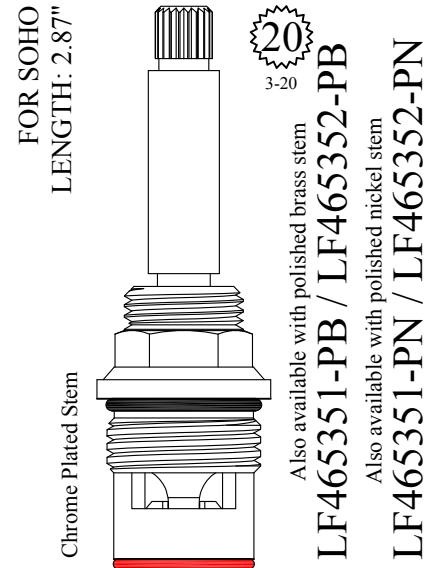

GASKET: 890170 O-RING INCLUDED
 SEAL: 898580-R/B
 DISC SET: 151380-PKG

LF465351
LF465352

CERAMIC DISC CARTRIDGES

FOR DORNBRACHT
LENGTH: 2.88"

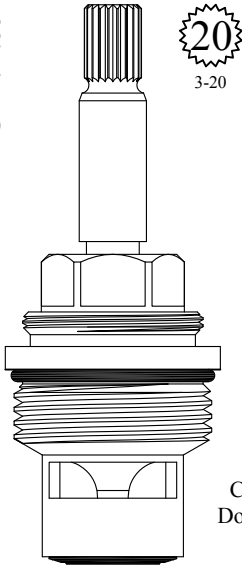

20
3-20

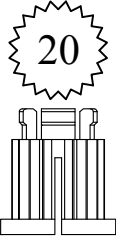

Comes with 20pt
Dornbracht adapter:
103200

GASKET: 890210 O-RING INCLUDED
SEAL: 898510
DISC SET: 151380-PKG

401691
401692

FOR LIBERTY
LENGTH: 2.89"

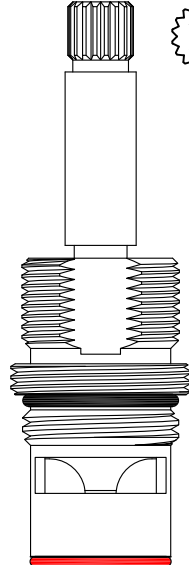

18
3-25

GASKET: 890170 O-RING INCLUDED
SEAL: 898570-R/B
DISC SET: 151380-PKG

LF465431
LF465432

FOR LIBERTY
LENGTH: 2.89"

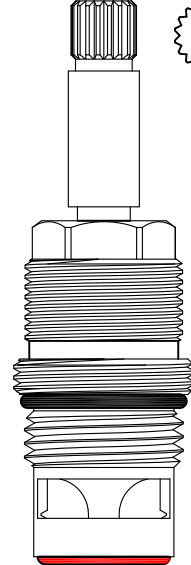

18
3-25

Alternate Style
Not Available
USE LF465431/LF465432

Extension Available
#135000

FOR THG
LENGTH 2.90"

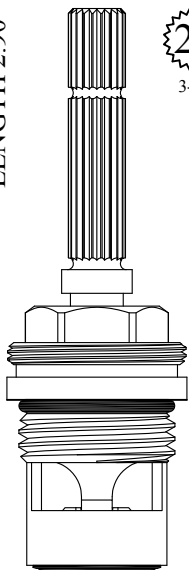

20
3-20

GASKET: 890170 O-RING INCLUDED
SEAL: 898510-W
DISC SET: 151380-PKG

LF465581
LF465582

FOR KOHLER NEW STYLE
LENGTH: 2.91"

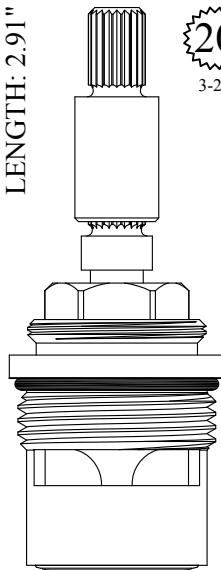

20
3-20

GASKET: 890210 O-RING INCLUDED
SEAL: 898520
DISC SET: 109850-PKG

401671
401672

Extension Available
#135000

FOR KOHLER OLD STYLE
LENGTH: 2.91"

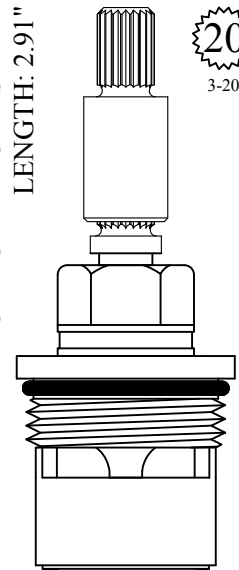

20
3-20

GASKET: 890210 O-RING INCLUDED
SEAL: 898520
DISC SET: 109850-PKG

401671 OS
401672 OS

CERAMIC DISC CARTRIDGES

Send Your Orders To:

BARRY E.  ALTER SR. CO.

E-mail: orderdesk@barrywalter.com

Fax: 1.800.886.9831

Phone: 1.800.767.5552

CERAMIC DISC CARTRIDGES

FOR KOHLER / ROHL
LENGTH: 2.91"

24
9/32

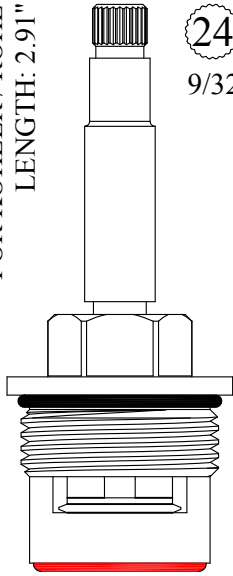

GASKET: 890210 O-RING INCLUDED
SEAL: 898610-R/B
DISC SET: 109850-PKG

401601
401602

FOR KRONIN BY VIOLA
LENGTH: 2.94"

20
3-20

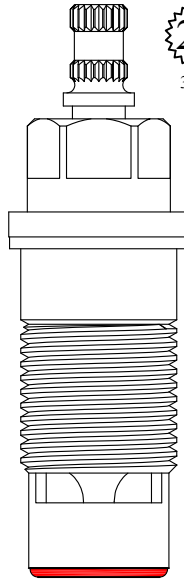

GASKET: 895150 INCLUDED
SEAL: 898570-R/B
DISC SET: 151380-PKG

LF466251
LF466252

FOR DORF
LENGTH: 2.97"

3/8 - 26 TPI

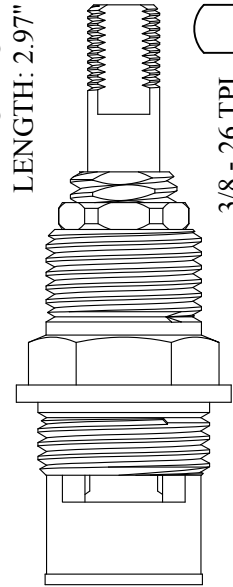

GASKET: 895370 INCLUDED
DISC SET: 124290-PKG

LF465941
LF465942

Also available with Chrome Plated Stem
LF465941-CP / LF465942-CP

FOR PHYLRICH
LENGTH: 2.96"

16
1-6

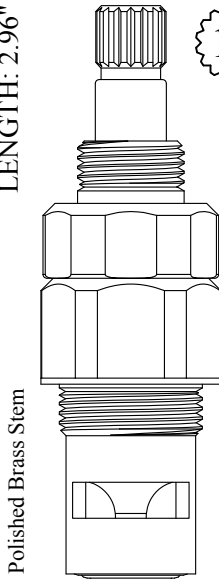

GASKET: 895270 INCLUDED
SEAL: 898500
DISC SET: 112530-PKG

LF466201
LF466202

Also available with Polished Chrome Stem
LF466201-CP / LF466202-CP

FOR ZURN HYDRANT
LENGTH: 2.95"

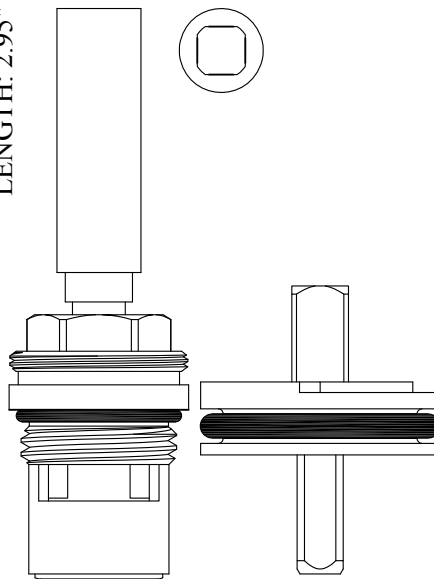
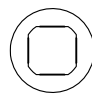

GASKET: 895170 INCLUDED
SEAL: 898510-W
DISC SET: 151380-PKG

466311

The above stem is available in the following lengths:

Stem #:	Length	Stem #:	Length
483171-6	6.00"	483171-18	18.00"
483171-8	8.00"	483171-20	20.00"
483171-10	10.00"	483171-22	22.00"
483171-12	12.00"	483171-24	24.00"
483171-14	14.00"	483171-26	26.00"
483171-16	16.00"	483171-30	30.00"

OPERATING STEM
IS FOR
REFERENCE ONLY

FOR AUBURN BRASS
LENGTH: 2.98"

16
2-3

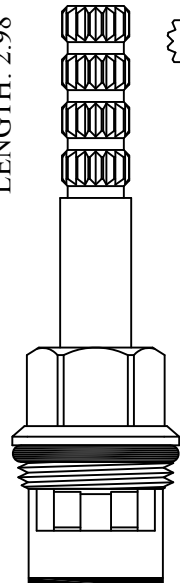

GASKET: 890160 O-RING INCLUDED
DISC SET: 151380-PKG

LF465451
LF465452

Nickel Plated Gland

CERAMIC DISC CARTRIDGES

Individual items available
 Stem Ext. 1-1/2": #121860-PB
 & 121860-CP
 Ext. Adap. Screw: #103310

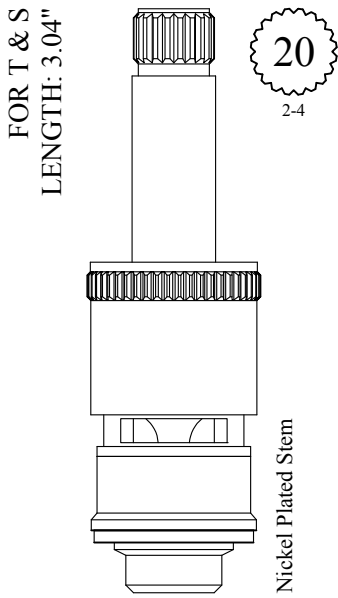

SEAL: 898510
 DISC SET: 151380-PKG
LF466401
LF466402

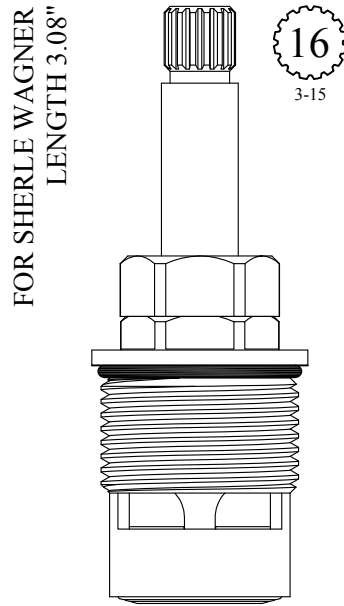

GASKET: 890210 O-RING INCLUDED
 SEAL: 898520
 DISC SET: 109850-PKG
401881
401882

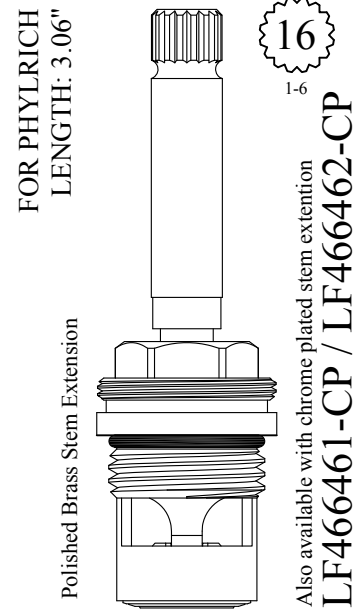

GASKET: 890170 O-RING INCLUDED
 SEAL: 898510-W
 DISC SET: 151380-PKG
LF466461
LF466462

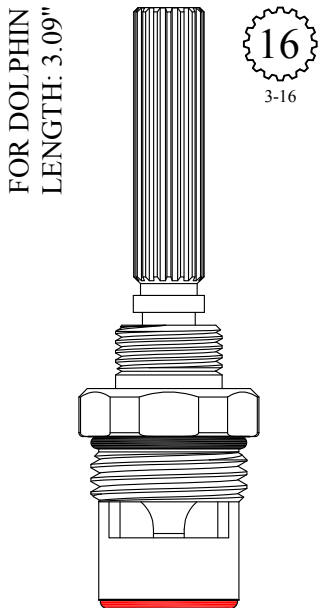

GASKET: 890170 O-RING INCLUDED
 SEAL: 898570-R/B
 DISC SET: 151380-PKG
LF466421
LF466422

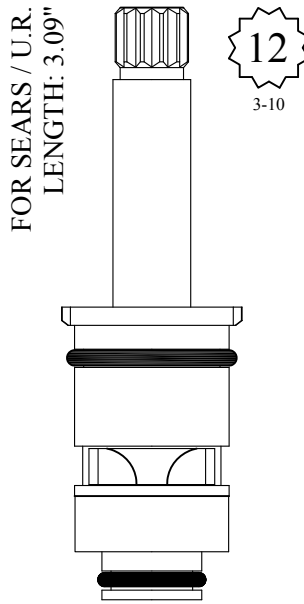

GASKET: 890170 O-RING INCLUDED
 DISC SET: 151380-PKG
LF467031
LF467032

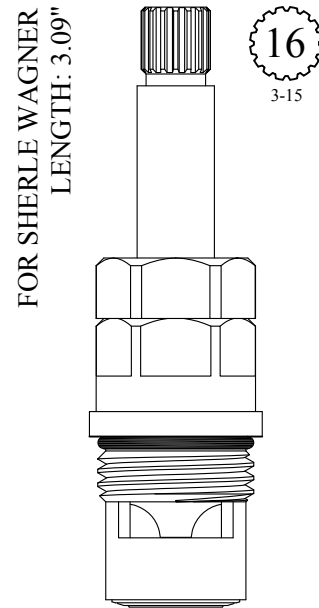

GASKET: 890170 O-RING INCLUDED
 SEAL: 898510-W
 DISC SET: 151380-PKG
LF466521
LF466522

CERAMIC DISC CARTRIDGES

Individual item available
Esc Cap Nut: #124940

UNKNOWN
LENGTH: 3.09"

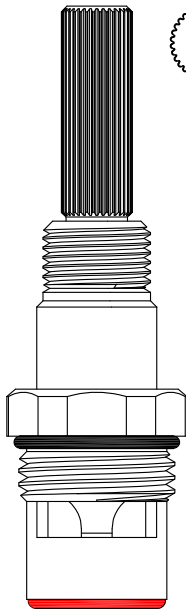

32
3-23

Individual item available
9/16-20 x 7/8" ext. nipple: #118320

GASKET: 890170 O-RING INCLUDED
SEAL: 898570-R/B
DISC SET: 151380-PKG

LF466441
LF466442

FOR SOHO
LENGTH: 3.10"

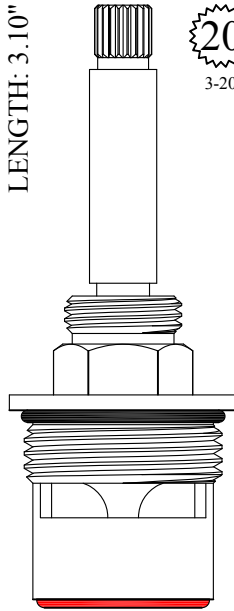

20
3-20

Chrome Plated Stem

GASKET: 890170 O-RING INCLUDED
SEAL: 898610-R/B
DISC SET: 109850-PKG

402351
402352

UNKNOWN
LENGTH: 3.14"

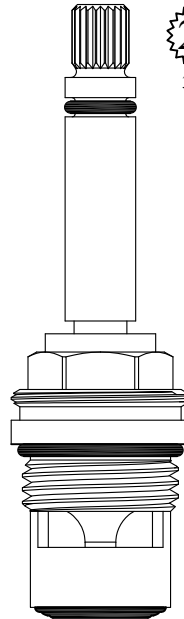

20
3-20

GASKET: 890170 O-RING INCLUDED
SEAL: 898510
DISC SET: 151380-PKG

LF466921
LF466922

UNKNOWN
LENGTH: 3.14"

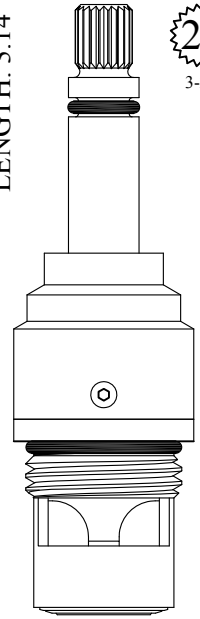

20
3-20

GASKET: 890170 O-RING INCLUDED
SEAL: 898510
DISC SET: 151380-PKG

LF466941
LF466942

UNKNOWN
LENGTH: 3.15"

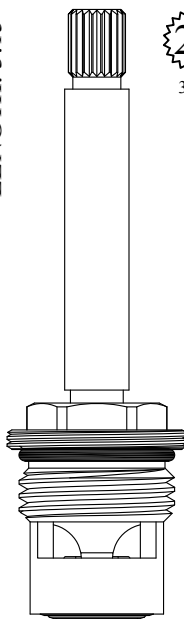

20
3-20

GASKET: 890170 O-RING INCLUDED
SEAL: 898500
DISC SET: 151380-PKG

LF467381
LF467382

FOR SPEAKMAN
LENGTH: 3.27"

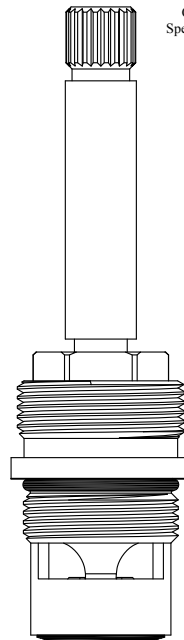

Comes with a plastic
Speakman handle bushing

20
2-4

Chrome Plated Unit

GASKET: 890170 O-RING INCLUDED
SEAL: 898510
DISC SET: 151380-PKG

LF466901
LF466902

FOR SPEAKMAN
LENGTH: 3.27"

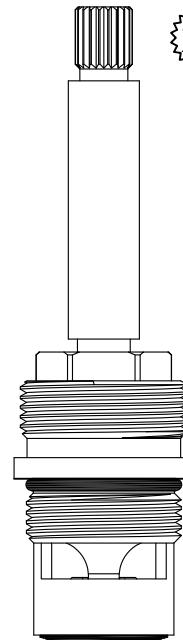

20
3-20

Chrome Plated Unit

GASKET: 890170 O-RING INCLUDED
SEAL: 898510
DISC SET: 151380-PKG

LF466911
LF466912

CERAMIC DISC CARTRIDGES

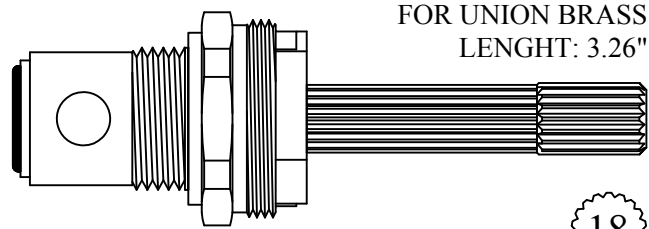

402511/ 402512

GASKET: 895100
SEAL: 898510
DISC SET: 151380-PKG

18
3-3

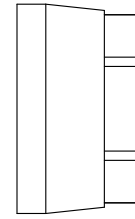

Cap Nut
available
702510

FOR AM STD
CERAMIC CONVERSION FOR
COLONY S/V UNIT (SHORT)
LENGTH: 3.28"

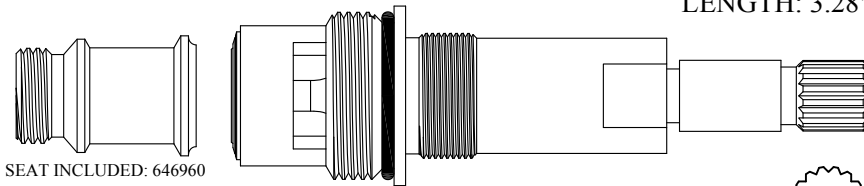

SEAT INCLUDED: 646960

402441

GASKET: 890180 O-RING INCLUDED
SEAL: 898510
DISC SET: 151380-PKG

16
1-6

Polished Brass Stem

FOR PHYLRICH
LENGTH: 3.33"

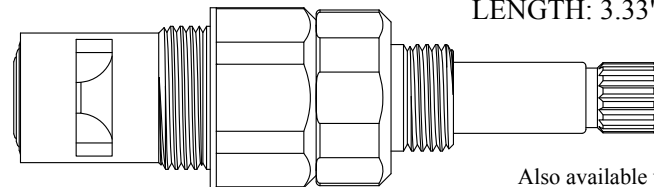

16
1-6

Also available with
polished chrome stem

LF468101/ LF468102

GASKET: 895270 INCLUDED
SEAL: 898500
DISC SET: 112530-PKG

**LF468101-CP
LF468102-CP**

UNKNOWN
LENGTH: 3.34"

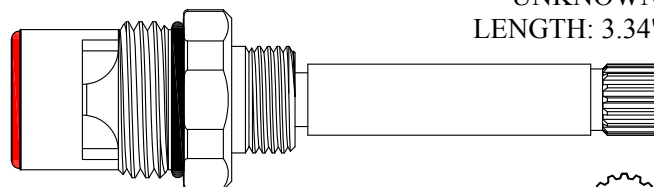

16
3-16

LF402681/ LF402682

GASKET: 890170 O-RING INCLUDED
SEAL: 898570-R/B
DISC SET: 151380-PKG

CERAMIC DISC CARTRIDGES

Polished Brass Stem

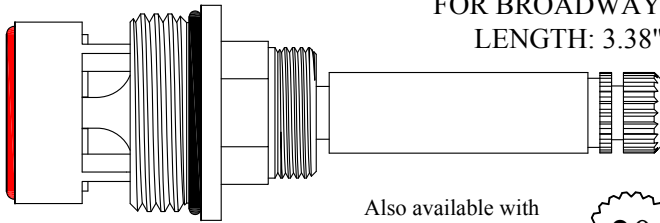

FOR BROADWAY
LENGTH: 3.38"

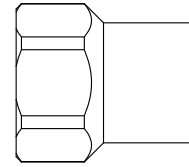

Escutcheon Nut
302740
available

402651/ 402652

GASKET: 890210 O-RING INCLUDED
SEAL: 898610-R/B
DISC SET: 109850-PKG

Also available with
polished chrome stem
402651-CP
402652-CP



2-4

FOR REID WATSON
LENGTH: 3.38"

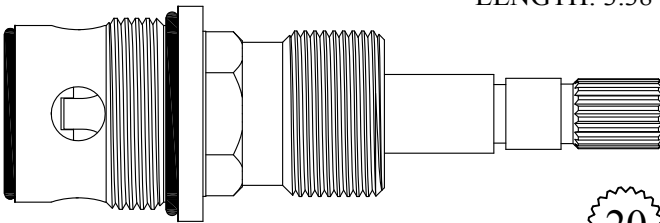

402661/ 402662

GASKET: 890210 O-RING INCLUDED
SEAL: 898530
DISC SET: 109850-PKG



3-14

FOR DORNBRACHT
LENGTH: 3.38"

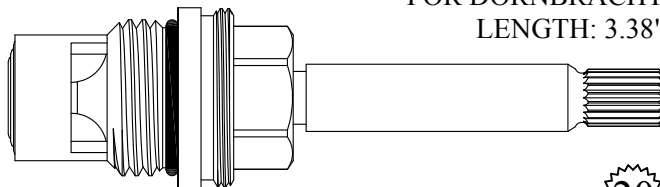

402601/ 402602

GASKET: 890170 O-RING INCLUDED
SEAL: 898500
DISC SET: 112530-PKG



3-20

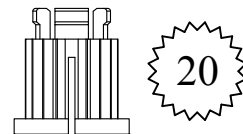

Comes with 20pt Dornbracht
adapter: 103200

Polished Brass Stem Extension

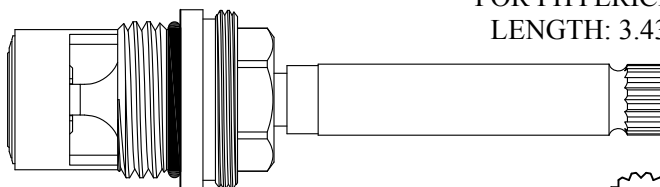

FOR PHYLRICH
LENGTH: 3.43"

Individual items available
Stem Ext. 1 7/8": #102890-PB
& 102890-CP
Ext. Adap. Screw: #103310

LF468461/ LF468462

GASKET: 890170 O-RING INCLUDED
SEAL: 898510-W
DISC SET: 151380-PKG



1-6

Also available with chrome plated stem extension

LF468461-CP/ LF468462-CP

CERAMIC DISC CARTRIDGES

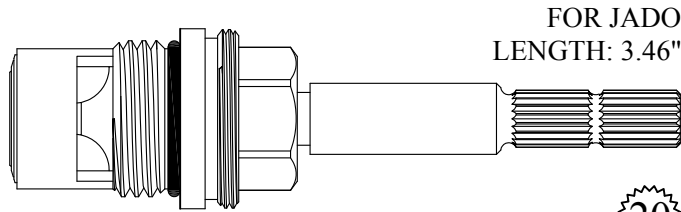

402841/ 402842

GASKET: 890170 O-RING INCLUDED
SEAL: 898510-W
DISC SET: 151380-PKG

20
3-20

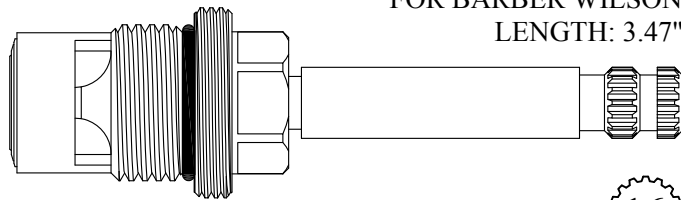

LF468581/ LF468582

GASKET: 890190 O-RING INCLUDED
SEAL: 898510-W
DISC SET: 151380-PKG

16
3-16

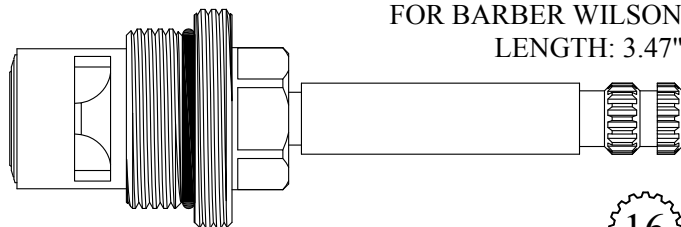

LF468571/ LF468572

GASKET: 890190 O-RING INCLUDED
SEAL: 898510-W
DISC SET: 151380-PKG

16
3-16

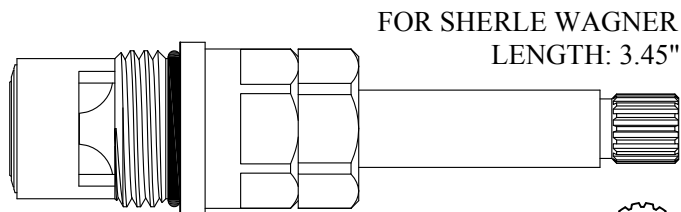

LF468521/ LF468522

GASKET: 890170 O-RING INCLUDED
SEAL: 898510-W
DISC SET: 151380-PKG

16
3-15

CERAMIC DISC CARTRIDGES

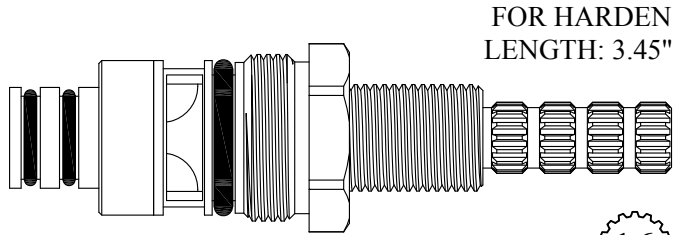

LF468201/ LF468202

GASKET: 891140 O-RING INCLUDED
DISC SET: 151380-PKG

16
3-16

Polished Brass Stem

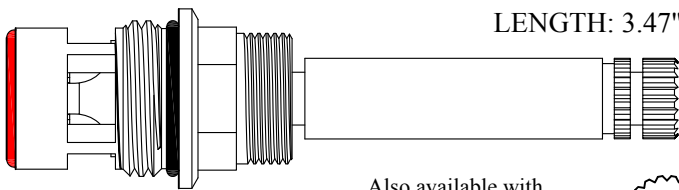

**LF402741
LF402742**

GASKET: 890170 O-RING INCLUDED
SEAL: 898570-R/B
DISC SET: 151380-PKG

Also available with
polished chrome stem
**LF402741-CP
LF402742-CP**

20
2-4

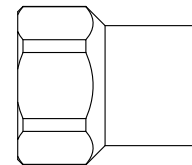

Escutcheon Nut
302740
available

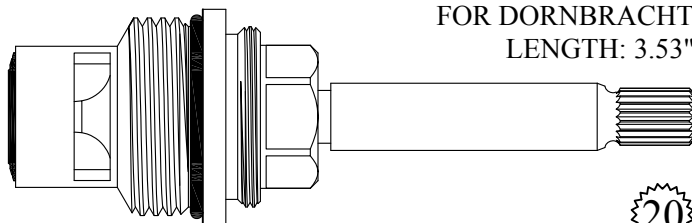

402861/ 402862

GASKET: 890210 O-RING INCLUDED
SEAL: 898510
DISC SET: 151380-PKG

20
3-20

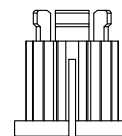

Comes with 20pt Dornbracht
adapter: 103200

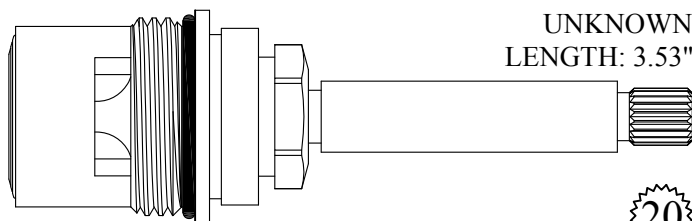

402571/ 402572

GASKET: 890210 O-RING INCLUDED
SEAL: 898520
DISC SET: 109850-PKG

20
3-20

CERAMIC DISC CARTRIDGES

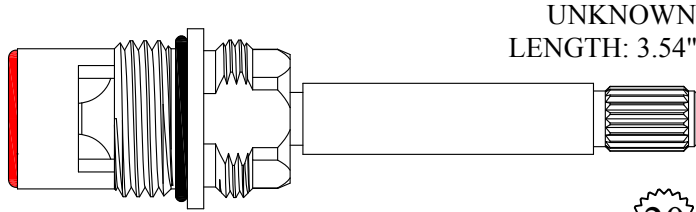

UNKNOWN
LENGTH: 3.54"

LF468221/ LF468222

GASKET: 890170 O-RING INCLUDED
SEAL: 898570-R/B
DISC SET: 151380-PKG

20
11/32
3-34

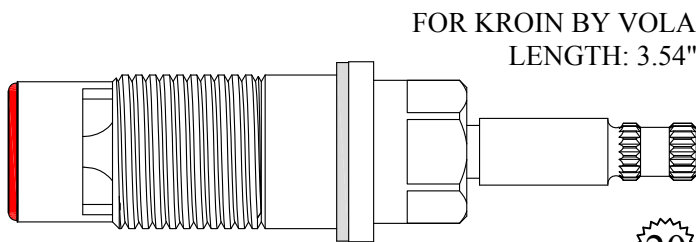

FOR KROIN BY VOLA
LENGTH: 3.54"

LF468251/ LF468252

GASKET: 895150 INCLUDED
SEAL: 898570-R/B
DISC SET: 151380-PKG

20
3-20

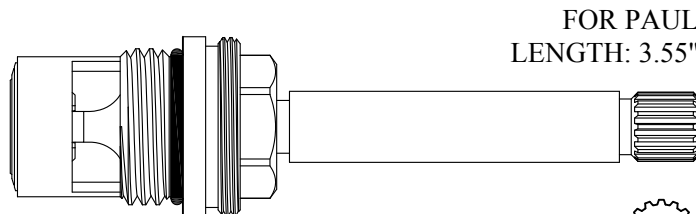

FOR PAUL
LENGTH: 3.55"

402931/ 402932

GASKET: 890170 O-RING INCLUDED
SEAL: 898510-W
DISC SET: 151380-PKG

16
3-16

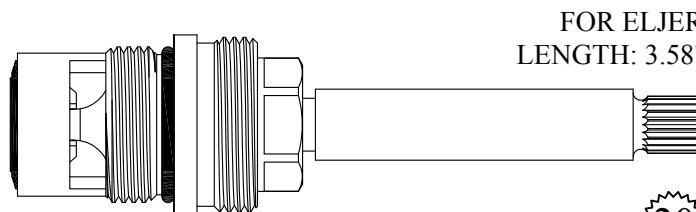

FOR ELJER
LENGTH: 3.58"

402911/ 402912

GASKET: 890170 O-RING INCLUDED
SEAL: 898510
DISC SET: 151380-PKG

20
3-20

CERAMIC DISC CARTRIDGES

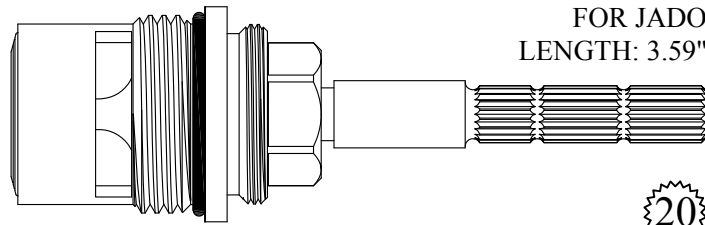

FOR JADO
LENGTH: 3.59"

20
3-20

402971/ 402972

GASKET: 890210 O-RING INCLUDED
SEAL: 898520
DISC SET: 109850-PKG

Chrome Plated Unit

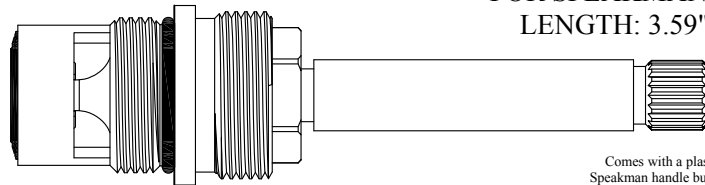

FOR SPEAKMAN
LENGTH: 3.59"

Comes with a plastic
Speakman handle bushing

20
2-4

402951/ 402952

GASKET: 890170 O-RING INCLUDED
SEAL: 898510
DISC SET: 151380-PKG

Chrome Plated Unit

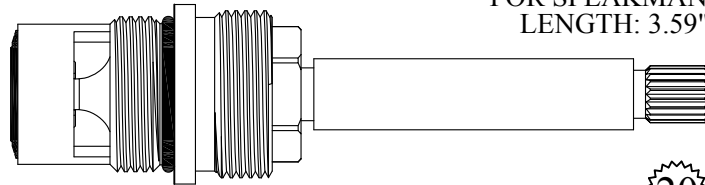

FOR SPEAKMAN
LENGTH: 3.59"

20
3-20

402961/ 402962

GASKET: 890170 O-RING INCLUDED
SEAL: 898510
DISC SET: 151380-PKG

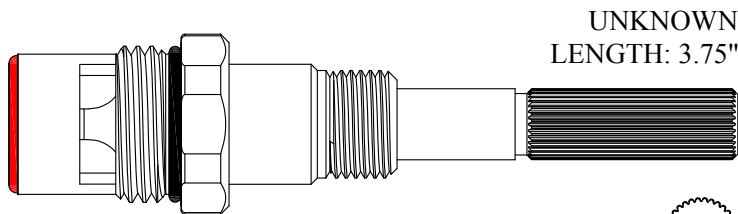

UNKNOWN
LENGTH: 3.75"

Two nipple extensions are
used in some applications.
Order an extra if needed.

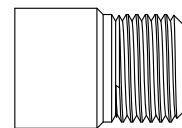

32
3-23

LF468441/ LF468442

GASKET: 890170 O-RING INCLUDED
SEAL: 898570-R/B
DISC SET: 151380-PKG

Individual item available
9/16-20 x 7/8" ext.
nipple: #118320

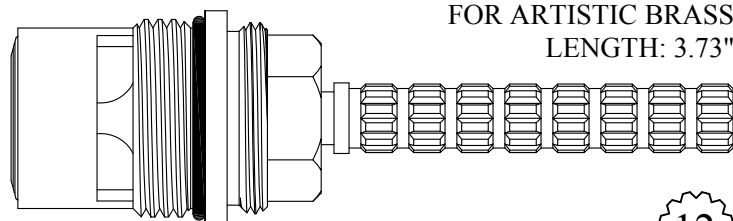

FOR ARTISTIC BRASS
LENGTH: 3.73"

12
1-2

403041/ 403042

GASKET: 890210 O-RING INCLUDED
SEAL: 898520
DISC SET: 109850-PKG

CERAMIC DISC CARTRIDGES

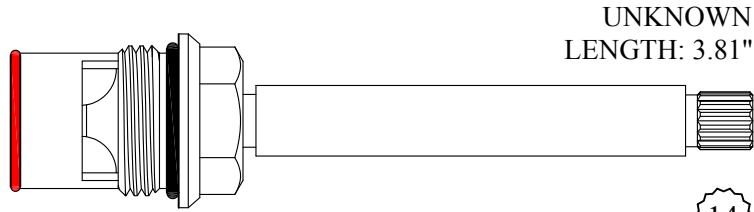

UNKNOWN
LENGTH: 3.81"

LF403461/ LF403462

GASKET: 890170 O-RING INCLUDED
SEAL: 898580-R/B
DISC SET: 151380-PKG

14
5/16

All Brass Unit - No Plastic

FOR AM STD
LENGTH: 3.87"

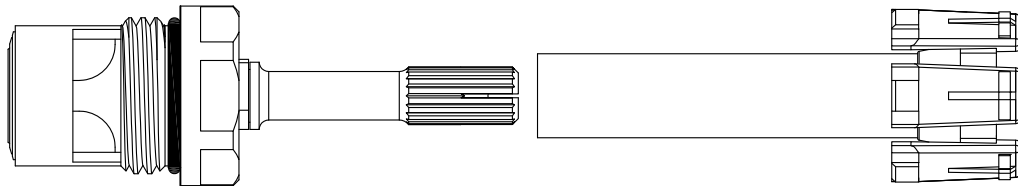

406101

GASKET: 890170 O-RING INCLUDED
SEAL: 898510-W
DISC SET: 151380-PKG

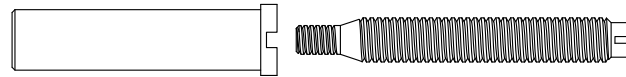

CERAMIC CONVERSION FOR AM STD COLONY (LONG)
LENGTH: 3.90"

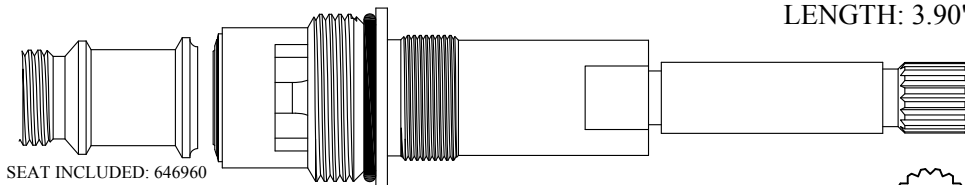

SEAT INCLUDED: 646960

403481

GASKET: 890180 O-RING INCLUDED
SEAL: 898510-W
DISC SET: 151380-PKG

16
1-6

FOR JACUZZI
LENGTH: 3.92"

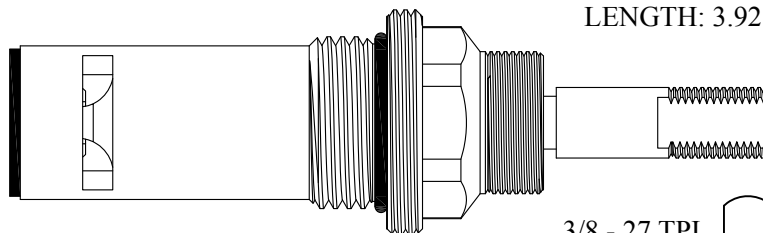

403821/ 403822

GASKET: 890190 O-RING INCLUDED
SEAL: 898550
DISC SET: 151380-PKG

3/8 - 27 TPI



CERAMIC DISC CARTRIDGES

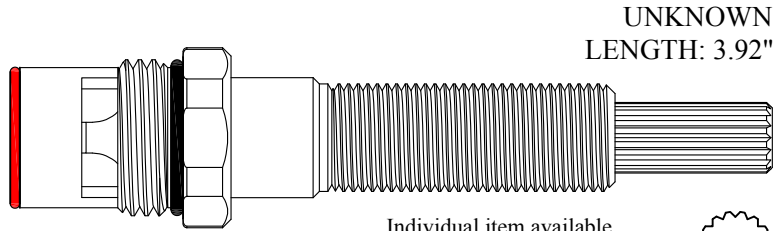

UNKNOWN
LENGTH: 3.92"

403631/ 403632

GASKET: 890170 O-RING INCLUDED
SEAL: 898580-R/B
DISC SET: 151380-PKG

Individual item available
9/16-20 x 2.0" ext. nipple: #135260



1-6

Polished Brass Stem

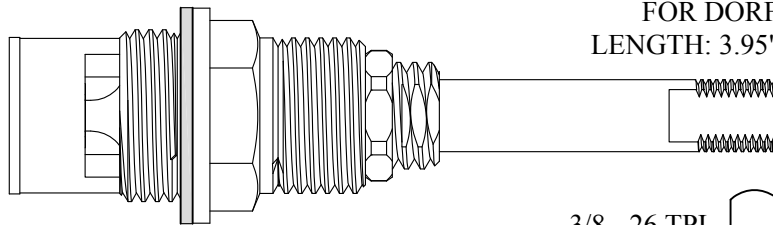

FOR DORF
LENGTH: 3.95"

3/8 - 26 TPI



LF469301/ LF469302

DISC SET: 151380-PKG
GASKET: 895370 INCLUDED

Also available with a Polished Chrome Plated Stem
LF469301-CP / LF469302-CP

Polished Brass Stem

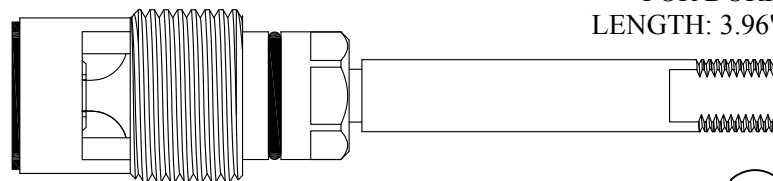

FOR DORF
LENGTH: 3.96"

3/8 - 26 TPI



LF469501/ LF469502

DISC SET: 151380-PKG
GASKET: 895370

Also available with a Polished Chrome Plated Stem
LF469501-CP / LF469502-CP

Nut Also available
369500

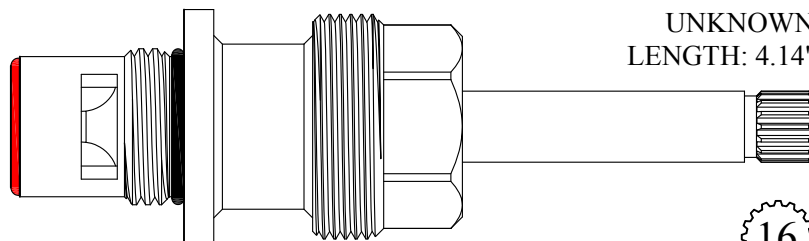
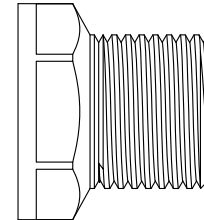

UNKNOWN
LENGTH: 4.14"

404301/ 404302

GASKET: 890170 O-RING INCLUDED
SEAL: 898580-R/B
DISC SET: 151380-PKG



3-16

CERAMIC DISC CARTRIDGES

CERAMIC CONVERSION FOR BROADWAY COMPRESSION

LENGTH: 4.16"

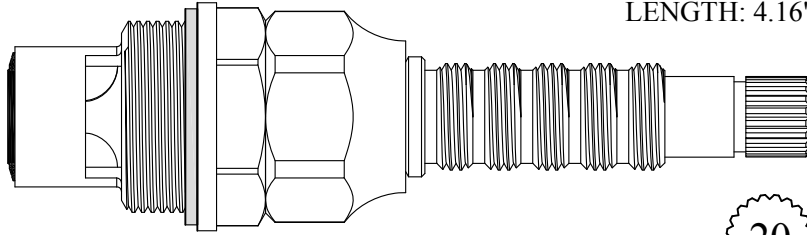

Must use the 647490 seat to convert from a compression to the ceramic

404621

GASKET INCLUDED: 895550
SEAL: 898510
DISC SET: 151380-PKG

20

2-4

FOR WOLVERINE

LENGTH: 4.19"

Nickel Plated Stem

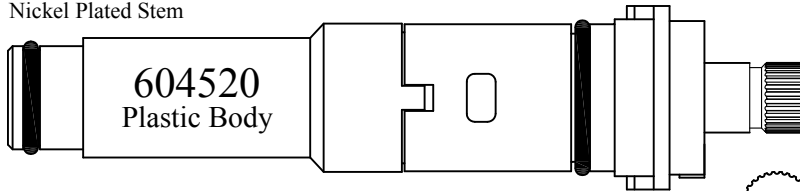

604520
Plastic Body

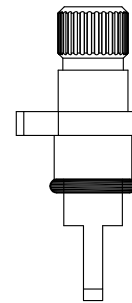

Available: Stem Only

LF263321
LF263322

Also available as
a RH/LH Kit

LF404521-2

Kit includes:

(1) RH Stem

(1) LH Stem

(1) Body

LF404521/ LF404522

DISC SET: 151380-PKG

30

3-35

FOR WOLVERINE

LENGTH: 4.22"

Nickel Plated Stem

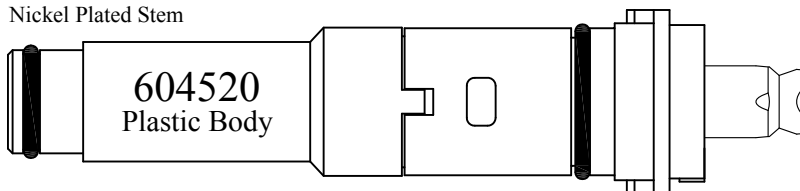

604520
Plastic Body

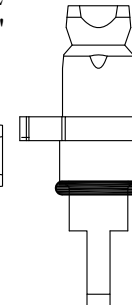

Available: Stem Only

LF263361
LF263362

Also available as
a RH/LH Kit

LF404531-2

Kit includes:

(1) RH Stem

(1) LH Stem

(1) Body

LF404531/ LF404532

DISC SET: 151380-PKG

CERAMIC CONVERSION FOR KOHLER LF470701/2

LENGTH: 4.25"

Chrome Plated Stem

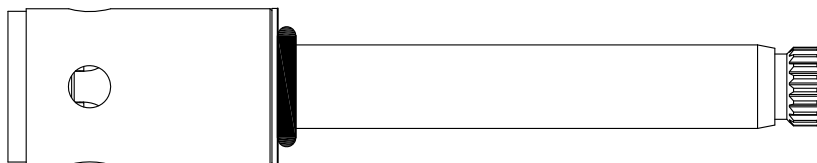

19

1-7

Also available with a Polished Gold Stem

LF470741/ LF470742

DISC SET: 151380-PKG

LF470741-PG / LF470742-PG

CERAMIC DISC CARTRIDGES

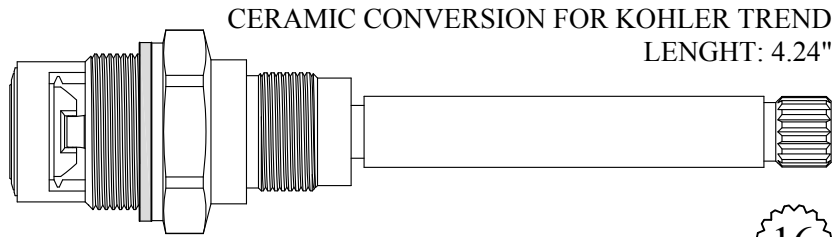

404821/ 404822

GASKET: 895150 INCLUDED
SEAL: 898510-W
DISC SET: 151380-PKG

16
1-6

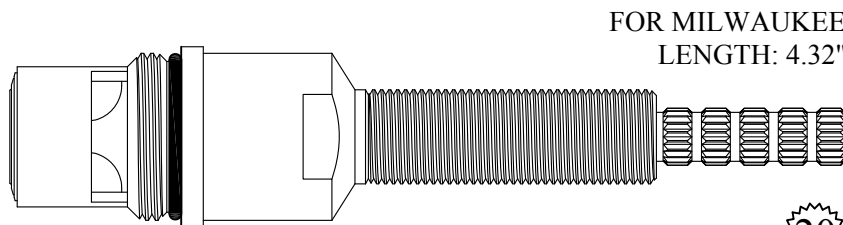

405191/ 405192

GASKET: 890170 O-RING INCLUDED
SEAL: 898510-W
DISC SET: 151380-PKG

20
3-20

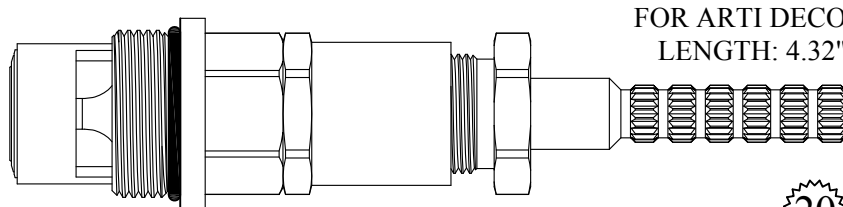

405221/ 405222

GASKET: 890170 O-RING INCLUDED
SEAL: 898510-W
DISC SET: 151380-PKG

20
3-20

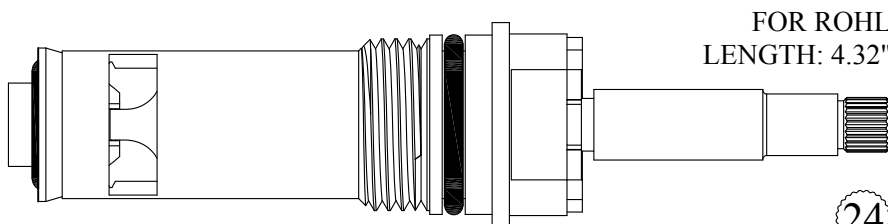

LF471401/ LF471402

GASKET: 891160 O-RING INCLUDED
DISC SET: 151380-PKG

24
9/32

CERAMIC DISC CARTRIDGES

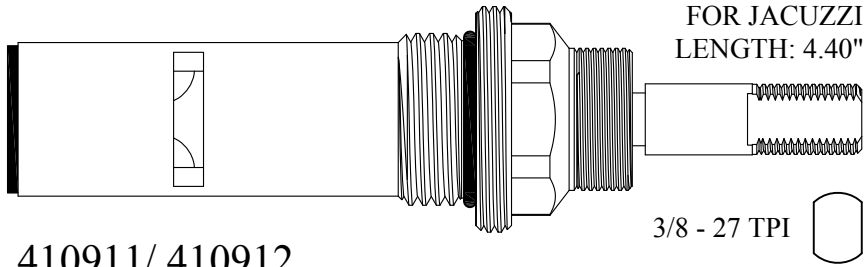

FOR JACUZZI
LENGTH: 4.40"

3/8 - 27 TPI

410911/ 410912

GASKET: 890190 O-RING INCLUDED
SEAL: 898550
DISC SET: 151380-PKG

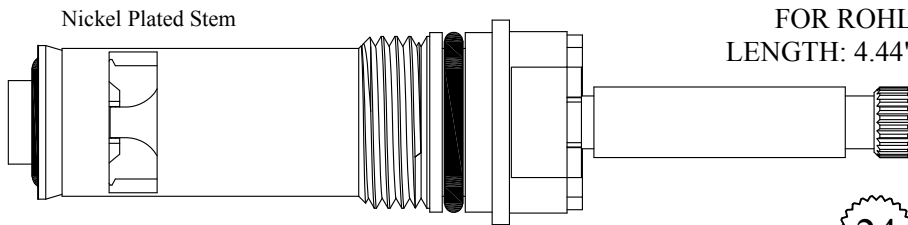

FOR ROHL
LENGTH: 4.44"

24
3-19

LF471601/ LF471602

GASKET: 891160 O-RING INCLUDED
DISC SET: 151380-PKG

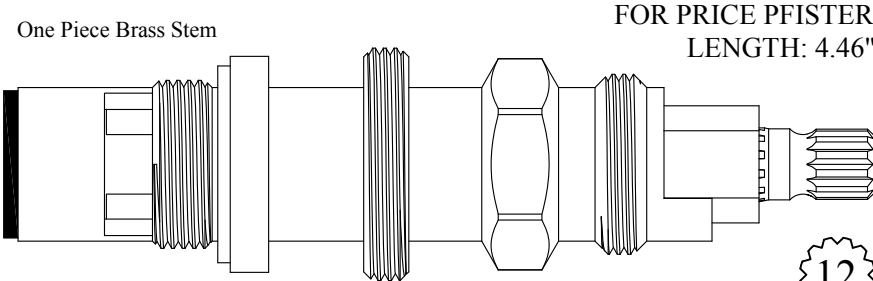

FOR PRICE PFISTER
LENGTH: 4.46"

12
1-2

405411

GASKET: 895390 INCLUDED
SEAL: 898550
DISC SET: 151380-PKG



You can use the 647390 seat to convert the old Beau Art body to accept the 405411 ceramic cartridge

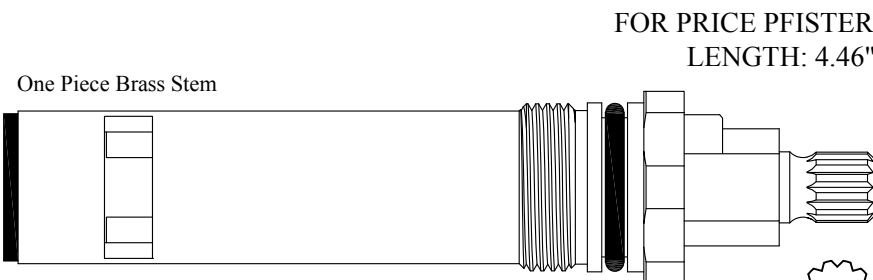

FOR PRICE PFISTER
LENGTH: 4.46"

12
1-2

405421

GASKET: 891150 O-RING INCLUDED
SEAL: 898550
DISC SET: 124290-PKG

CERAMIC DISC CARTRIDGES

Chrome Plated Stem

FOR PAUL
LENGTH: 4.45"



406731/ 406732

GASKET: 890170 O-RING INCLUDED
SEAL: 898510-W
DISC SET: 151380-PKG

16
3-16

All Brass Stem - No Plastic

FOR STERLING FAUCET
LENGTH: 4.56"

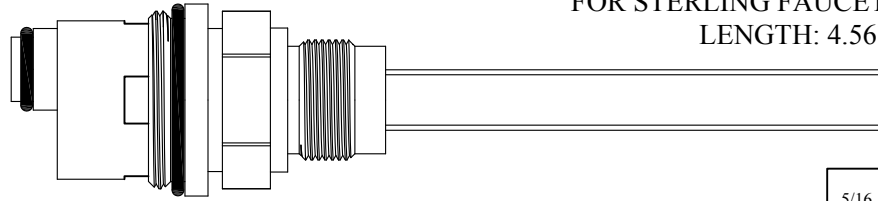

406741/ 406742

GASKET: 890190 O-RING INCLUDED

5/16



UNKNOWN
LENGTH: 4.56"

426271/ 426272

GASKET: 890210 O-RING INCLUDED
SEAL: 898520
DISC SET: 109850-PKG

20
3-20

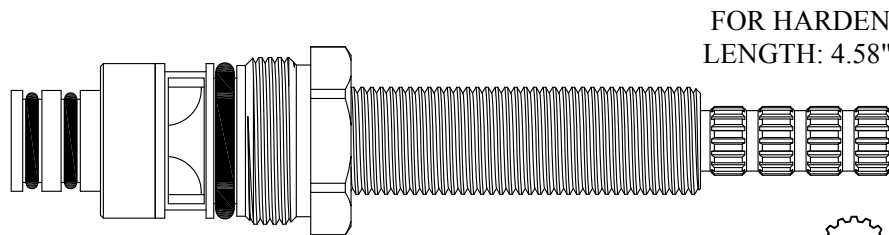

FOR HARDEN
LENGTH: 4.58"

408011/ 408012

GASKET: 891140 O-RING INCLUDED
DISC SET: 151380-PKG

16
3-16

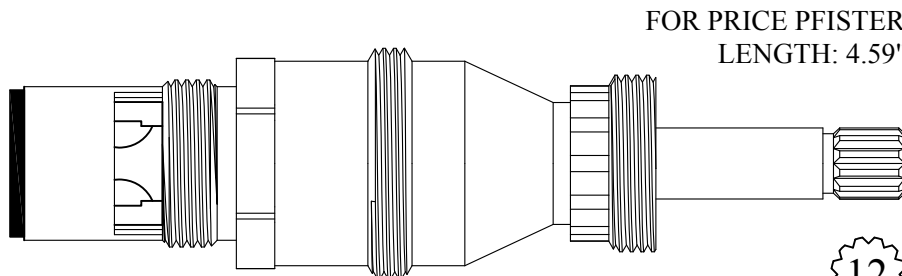

FOR PRICE PFISTER
LENGTH: 4.59"

405441

GASKET: 895390 INCLUDED
SEAL: 898550
DISC SET: 151380-PKG

12
1-2

CERAMIC DISC CARTRIDGES

1/2 Turn Ceramic
Polished Brass Stem

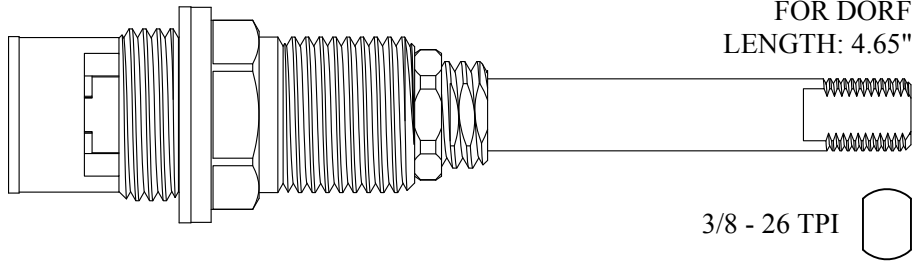

FOR DORF
LENGTH: 4.65"

3/8 - 26 TPI 

407941/ 407942

DISC SET: 124290-PKG
GASKET: 895370 INCLUDED

Also available with a Polished Chrome Plated Stem

407941-CP / 407942-CP

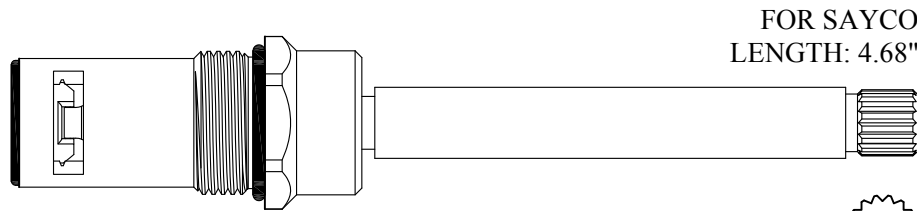

FOR SAYCO
LENGTH: 4.68"

16
2-3

408611/ 408612

GASKET: 890170 O-RING INCLUDED
SEAL: 898540
DISC SET: 112530-PKG

Ceramic Conversion for 412811

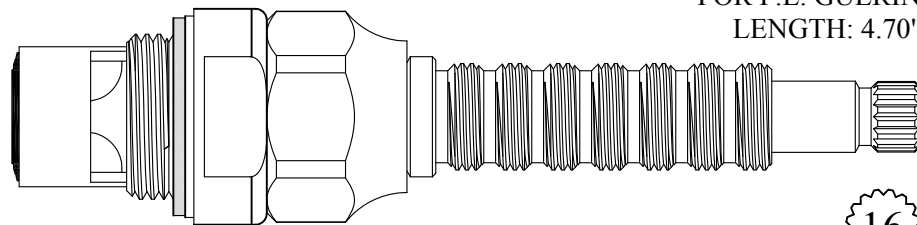

FOR P.E. GUERIN
LENGTH: 4.70"

16
1-6

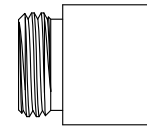

Must use the 647480 seat
to convert from a
compression to the ceramic

407991

GASKET: 895400 INCLUDED
SEAL: 898510
DISC SET: 151380-PKG

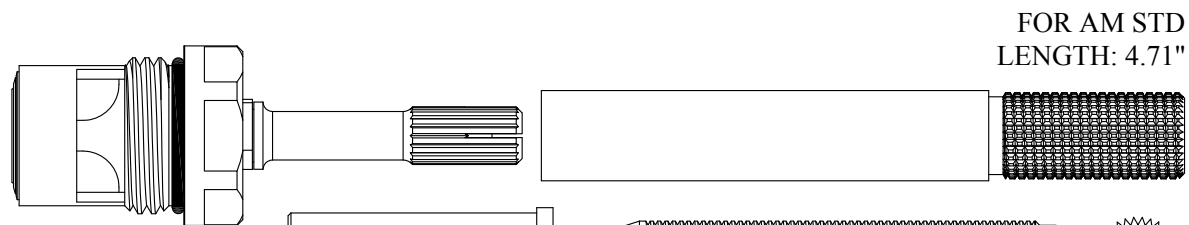

FOR AM STD
LENGTH: 4.71"

34

419211

GASKET: 890170 O-RING INCLUDED
SEAL: 898510-W
DISC SET: 151380-PKG

CERAMIC DISC CARTRIDGES

Nickel Plated Gland

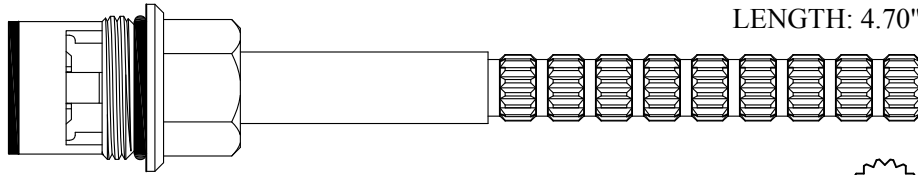

FOR AUBURN BRASS
LENGTH: 4.70"

404831/ 404832

GASKET: 890160 O-RING INCLUDED
DISC SET: 151380-PKG

16
2-3

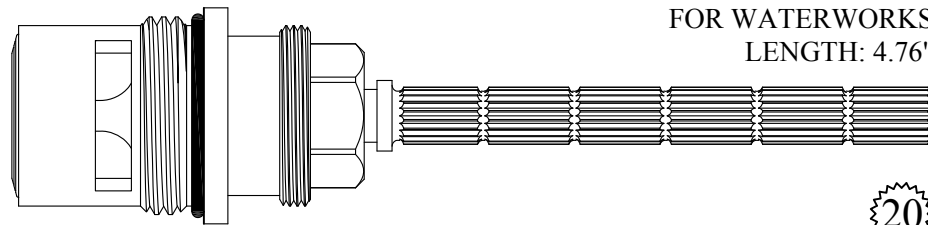

FOR WATERWORKS
LENGTH: 4.76"

409941/ 409942

GASKET: 890210 O-RING INCLUDED
SEAL: 898520
DISC SET: 109850-PKG

20
3-20

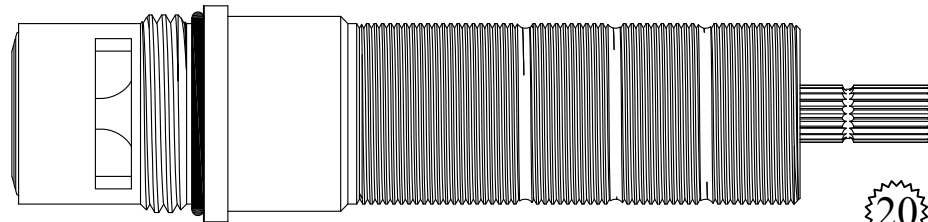

FOR WATERWORKS
LENGTH: 4.76"

409941-EN/ 409942-EN

GASKET: 890210 O-RING INCLUDED
SEAL: 898520
DISC SET: 109850-PKG

Escutcheon Nipple available separately
127350

20
3-20

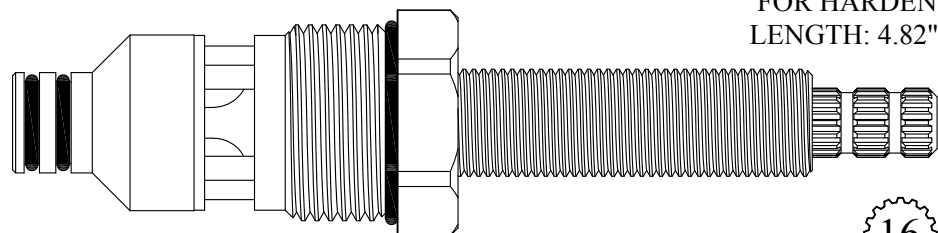

FOR HARDEN
LENGTH: 4.82"

409931/ 409932

GASKET: 890210 O-RING INCLUDED
DISC SET: 151380-PKG

16
3-16

CERAMIC DISC CARTRIDGES

FOR SEPCO
LENGTH: 4.83"

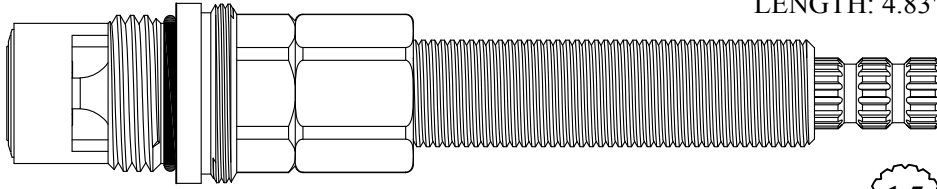

15
3-27

410031/ 410032

GASKET: 890170 O-RING INCLUDED
SEAL: 898510-W
DISC SET: 151380-PKG

Polished Brass Stem Extension

FOR PHYLRICH
LENGTH: 4.83"

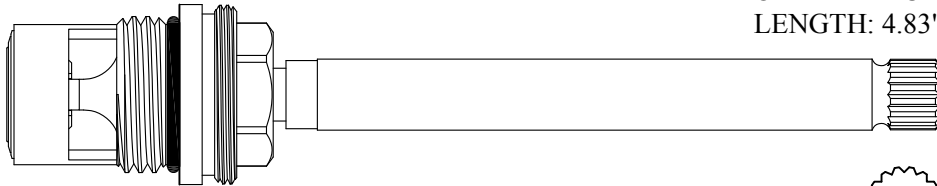

Individual items available
Stem Ext. 3.25": #132150-PB
& 132150-CP
Ext. Adap. Screw: #103310

Also available with chrome plated stem extension

16
1-6

410061/ 410062 410061-CP/ 410062-CP

GASKET: 890170 O-RING INCLUDED
SEAL: 898510-W
DISC SET: 151380-PKG

FOR PHYLRICH
LENGTH: 4.83"

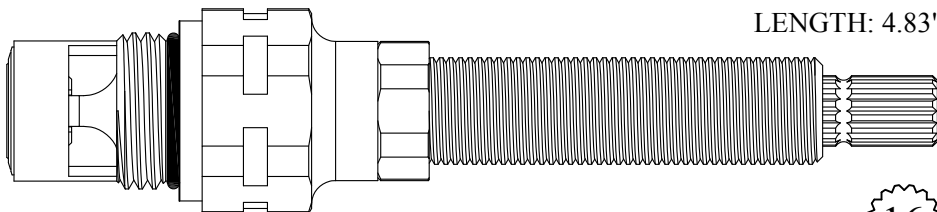

16
1-6

410081/ 410082

GASKET: 890170 O-RING INCLUDED
SEAL: 898510-W
DISC SET: 151380-PKG

Individual items available
Stem Ext. 3-1/4": #102960
Ext. Adap. Screw: #103310



FOR NEWPORT
LENGTH: 4.88"

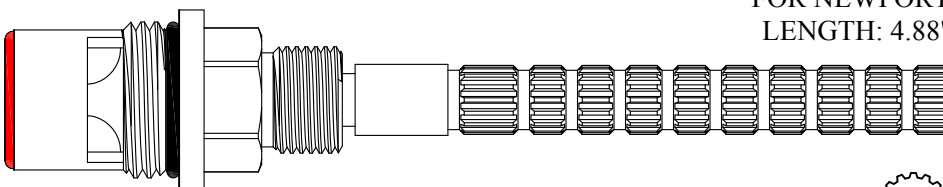

16
3-16

411221/ 411222

GASKET: 890170 O-RING INCLUDED
SEAL: 898570-R/B
DISC SET: 151380-PKG

CERAMIC DISC CARTRIDGES

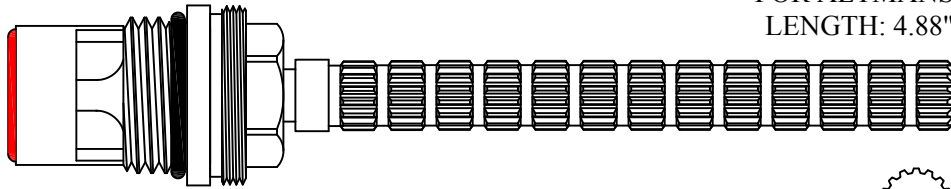

FOR ALTMANS
LENGTH: 4.88"

417311/ 417312

GASKET: 890170 O-RING INCLUDED
SEAL: 898570-R/B
DISC SET: 151380-PKG

16
3-16

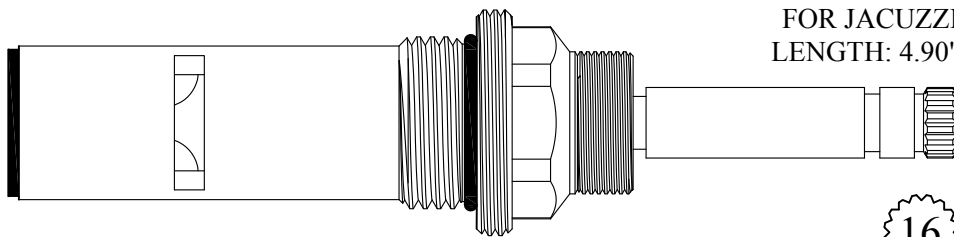

FOR JACUZZI
LENGTH: 4.90"

410921/ 410922

GASKET: 890190 O-RING INCLUDED
SEAL: 898550
DISC SET: 151380-PKG

16
1-6

Chrome Plated Stem

CERAMIC CONVERSION FOR KOHLER 407001/2
LENGTH: 4.90"

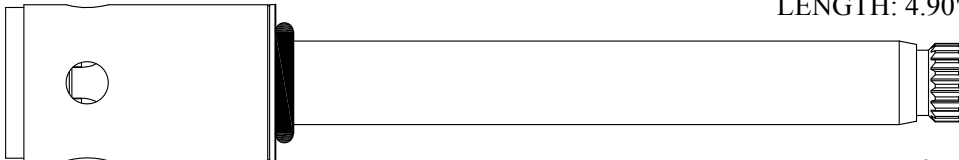

407041/ 407042

DISC SET: 151380-PKG

Also available with gold plated stem
407041-PG/ 407042-PG

19
1-7

Polished Brass Stem Extension

FOR PHYLRICH
LENGTH: 4.97"

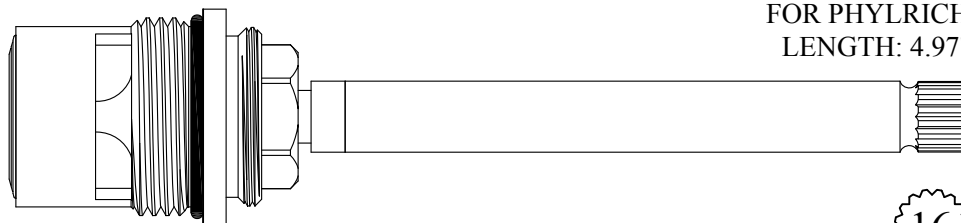

412041/ 412042

GASKET: 890210 O-RING INCLUDED
SEAL: 898520
DISC SET: 109850-PKG

Also available with chrome plated stem extension

412041-CP/ 412042-CP

16
1-6

Individual items available
Stem Ext. 3.25": #132150-PB
& 132150-CP
Ext. Adap. Screw: #103310

CERAMIC DISC CARTRIDGES

FOR CONCINITY
LENGTH: 4.97"

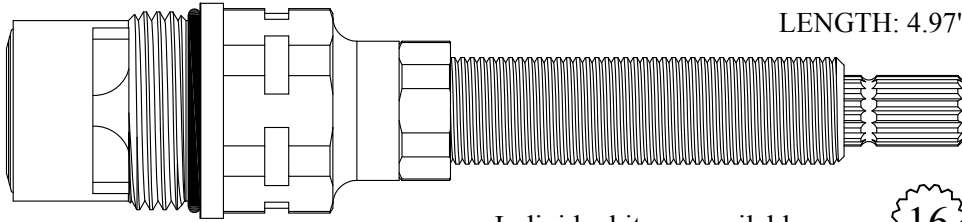

412031/ 412032

GASKET: 890210 O-RING INCLUDED
SEAL: 898520
DISC SET: 109850-PKG

Individual items available
Stem Ext. 3-1/4": #102960
Ext. Adap. Screw: #103310

16
1-6

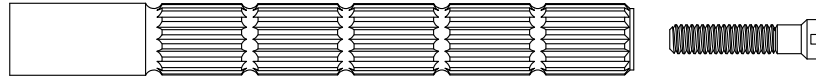

Chrome Plated Unit

UNKNOWN
LENGTH: 5.00"

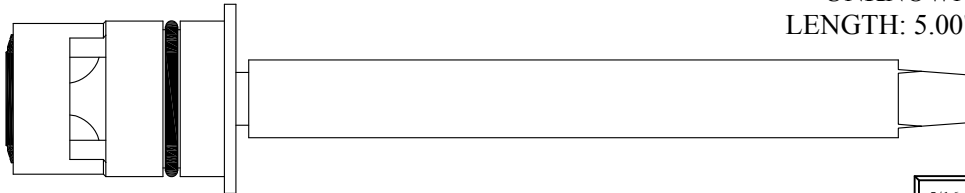

412641/ 412642

GASKET: 890170 O-RING INCLUDED
SEAL: 898510
DISC SET: 151380-PKG

5/16
TAPERED

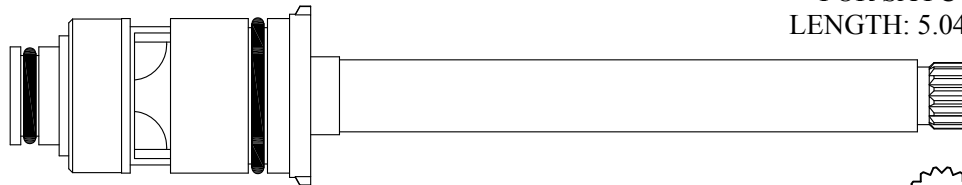

FOR SAYCO
LENGTH: 5.04"

414421/ 414422

GASKET: 890170 O-RING INCLUDED
DISC SET: 151380-PKG

16
2-3



Not Available, Use 414421 / 414422

Chrome Plated Stem

FOR SIGN OF THE CRAB
LENGTH: 5.01"

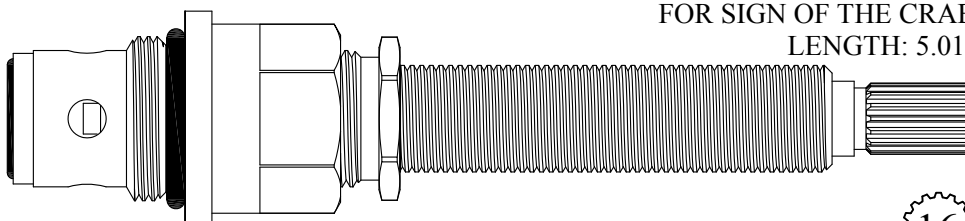

16
3-16

414911/ 414912

GASKET: 891160 O-RING INCLUDED
DISC SET: 112530-PKG

CERAMIC DISC CARTRIDGES

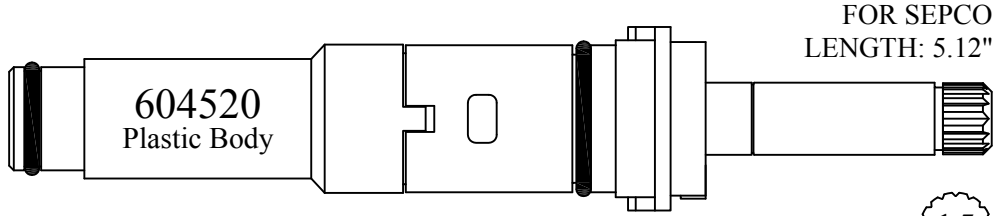

FOR SEPCO
LENGTH: 5.12"

414711/ 414712

15
3-27

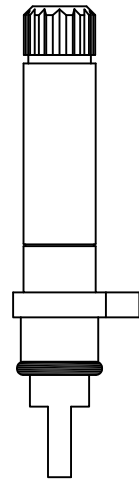

Available: Stem Only
214711 / 214712

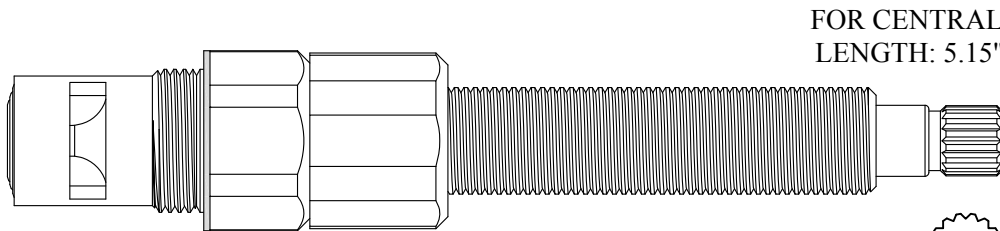

FOR CENTRAL
LENGTH: 5.15"

416821/ 416822

GASKET: 895270 INCLUDED
SEAL: 898500
DISC SET: 112530-PKG

16
1-6

Polished Brass Stem

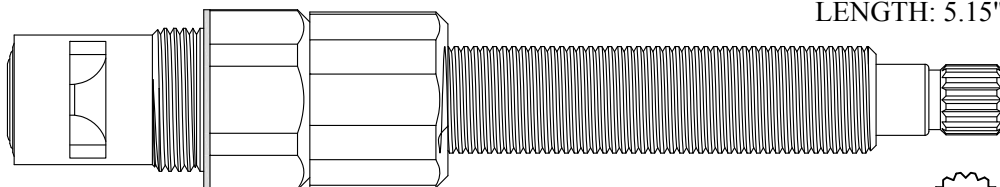

FOR PHYLRICH
LENGTH: 5.15"

416831/ 416832

GASKET: 895270 INCLUDED
SEAL: 898500
DISC SET: 112530-PKG

Also available with chrome plated stem
416831-CP/ 416832-CP

16
1-6

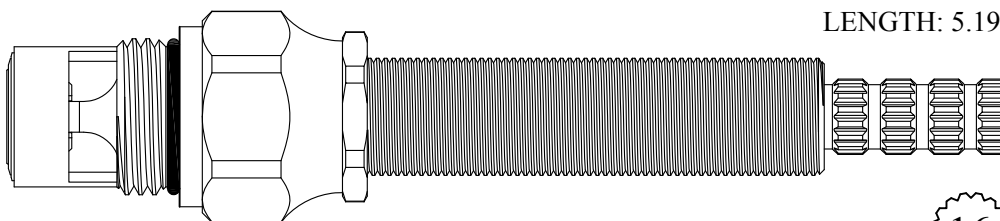

FOR REID WATSON
LENGTH: 5.19"

416711/ 416712

GASKET: 890170 O-RING INCLUDED
SEAL: 898510-W
DISC SET: 151380-PKG

16
1-5

CERAMIC DISC CARTRIDGES

Nickel Plated Stem

FOR CHICAGO
LENGTH: 5.28"

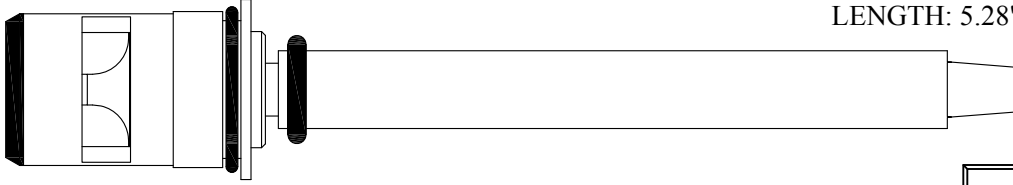

LF475411/ LF475412

GASKET: 890170 O-RING INCLUDED
SEAL: 898590 & LF132250
DISC SET: 151380-PKG



FOR NFC / AMERICAN FAUCETS
LENGTH: 5.30"

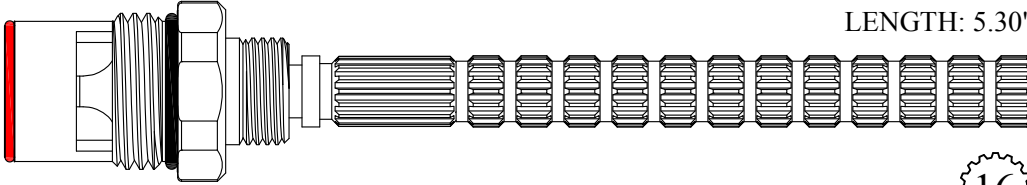

417221/ 417222

GASKET: 890170 O-RING INCLUDED
SEAL: 898580-R/B
DISC SET: 151380-PKG



FOR GLACIER BAY
LENGTH: 5.35"

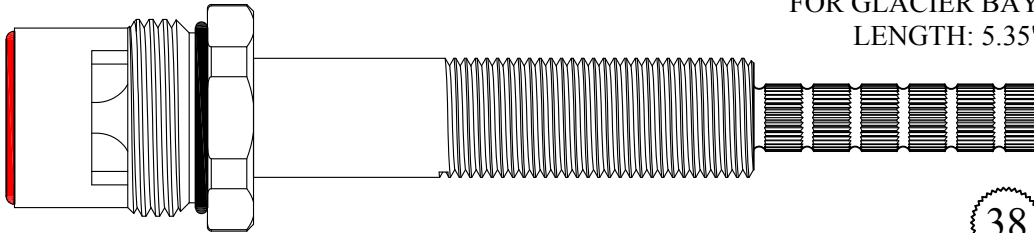

421421/ 421422

GASKET: 890200 O-RING INCLUDED
SEAL: 898610-R/B
DISC SET: 109850-PKG



FOR DORNBRACHT
LENGTH: 5.38"

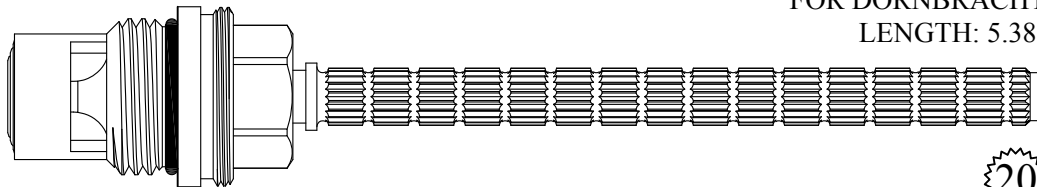

421161/ 421162

GASKET: 890170 O-RING INCLUDED
SEAL: 898500
DISC SET: 112530-PKG

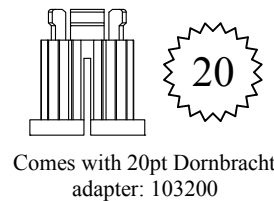

FOR DORNBRACHT
LENGTH: 5.38"

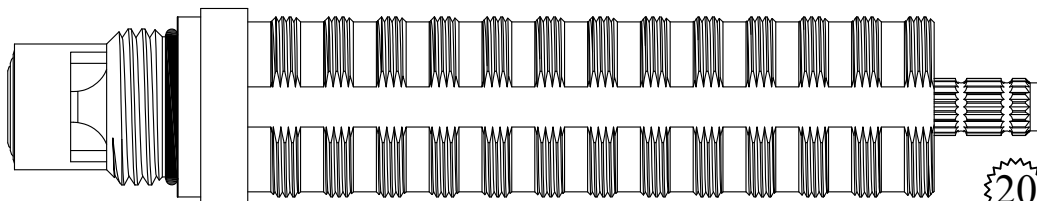

421161-EN/ 421162-EN

GASKET: 890170 O-RING INCLUDED
SEAL: 898500
DISC SET: 112530-PKG

Individual item available
esc.. nipple: #125080

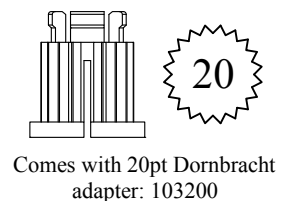

CERAMIC DISC CARTRIDGES



FOR ONDINE
LENGTH: 5.43"

421221/ 421222

GASKET: 890170 O-RING INCLUDED
SEAL: 898570-R/B
DISC SET: 151380-PKG



3-16

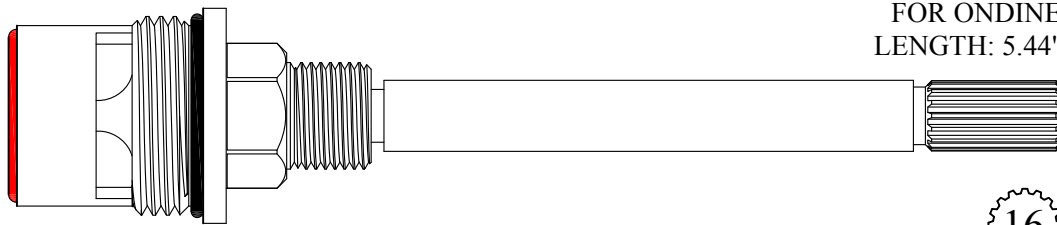

FOR ONDINE
LENGTH: 5.44"

421241/ 421242

GASKET: 890210 O-RING INCLUDED
SEAL: 898610-R/B
DISC SET: 109850-PKG



3-16

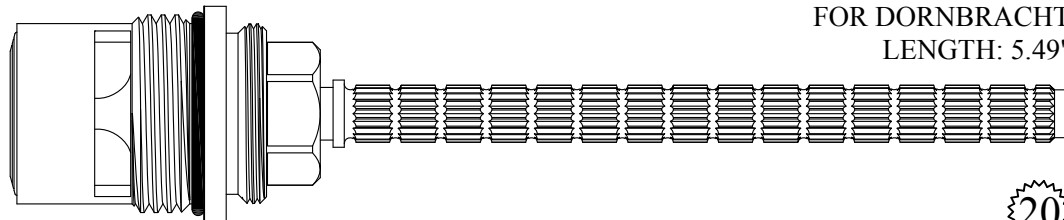

FOR DORNBRACHT
LENGTH: 5.49"

422601/ 422602

GASKET: 890210 O-RING INCLUDED
SEAL: 898520
DISC SET: 109850-PKG



3-20

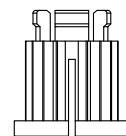

Comes with 20pt Dornbracht
adapter: 103200

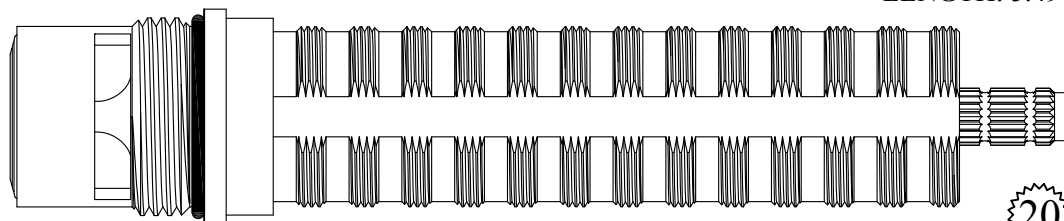

FOR DORNBRACHT
LENGTH: 5.49"

422601-EN/ 422602-EN

GASKET: 890210 O-RING INCLUDED
SEAL: 898520
DISC SET: 109850-PKG



3-20

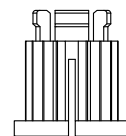

Comes with 20pt Dornbracht
adapter: 103200

Individual item available
esc.. nipple: #125080

CERAMIC DISC CARTRIDGES

1/2 Turn Ceramic

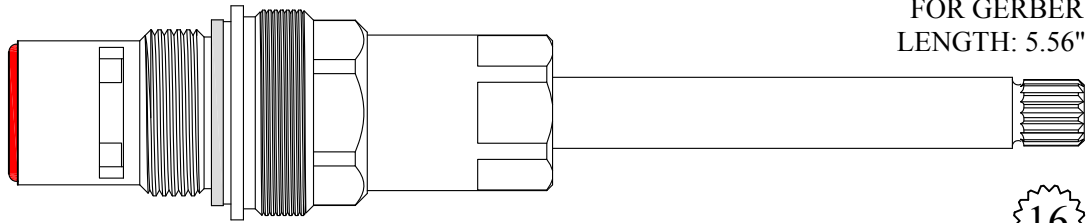

FOR GERBER
LENGTH: 5.56"

16

2-3

422411/ 422412

GASKET: 895180 INCLUDED
SEAL: 898570-R/B
DISC SET: 124290-PKG

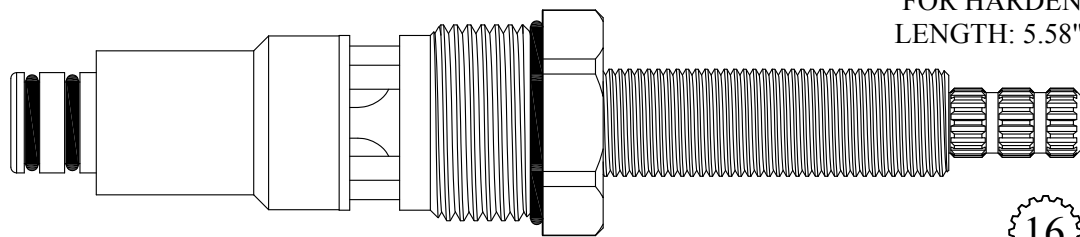

FOR HARDEN
LENGTH: 5.58"

16

3-16

423931/ 423932

GASKET: 890210 O-RING INCLUDED
DISC SET: 151380-PKG

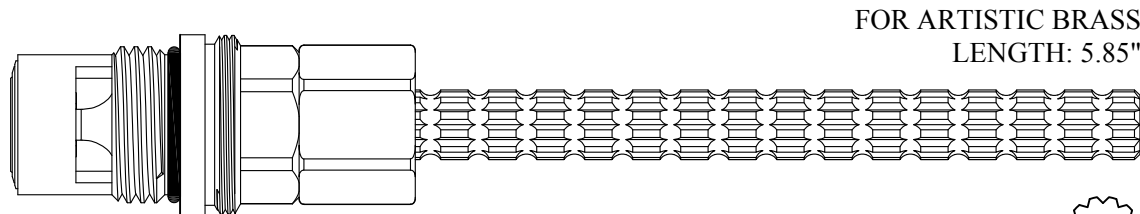

FOR ARTISTIC BRASS
LENGTH: 5.85"

12

1-2

425721/ 425722

GASKET: 890170 O-RING INCLUDED
SEAL: 898510-W
DISC SET: 151380-PKG

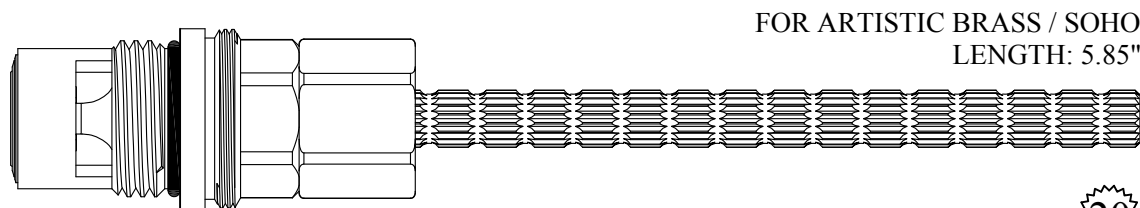

FOR ARTISTIC BRASS / SOHO
LENGTH: 5.85"

20

3-20

425741/ 425742

GASKET: 890170 O-RING INCLUDED
SEAL: 898510-W
DISC SET: 151380-PKG

CERAMIC DISC CARTRIDGES

FOR NEWPORT
LENGTH: 5.85"

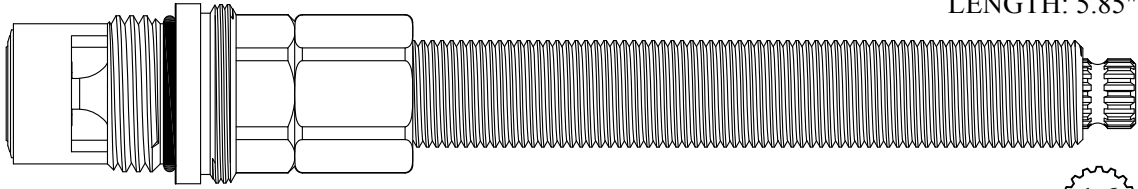

411271/ 411272

GASKET: 890170 O-RING INCLUDED
SEAL: 898510-W
DISC SET: 151380-PKG



FOR NEWPORT
LENGTH: 5.88"

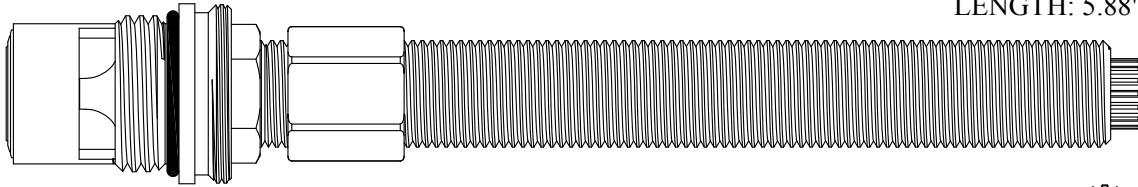

411281/ 411282

GASKET: 890170 O-RING INCLUDED
SEAL: 898510-W
DISC SET: 151380-PKG

Individual items available
Nipple Ext. Nut: #611270



FOR CAL FAUCETS
LENGTH: 5.88"

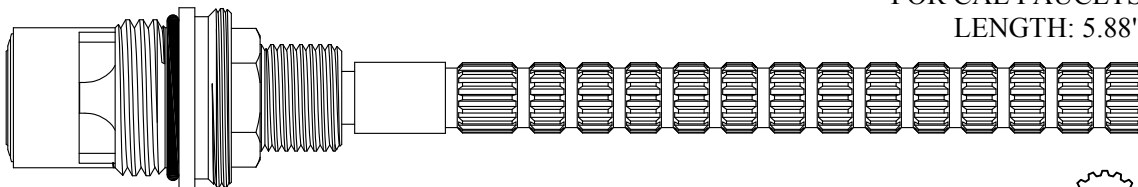

411291/ 411292

GASKET: 890170 O-RING INCLUDED
SEAL: 898510-W
DISC SET: 151380-PKG



1/2 Turn Ceramic

FOR DOLLY TRIM
LENGTH: 5.88"

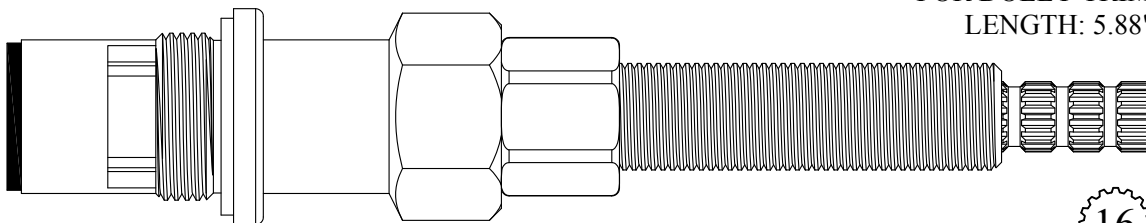

421641/ 421642

GASKET: 895390 INCLUDED
SEAL: 898550
DISC SET: 124290-PKG



CERAMIC DISC CARTRIDGES

Ceramic Conversion for 421601 / 421602

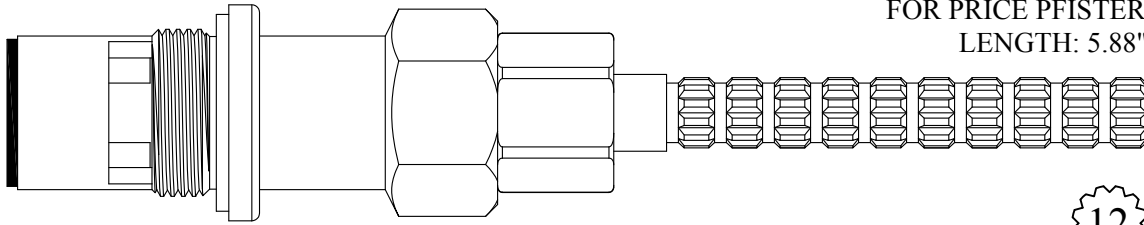

FOR PRICE PFISTER
LENGTH: 5.88"

421691/ 421692

GASKET: 895390 INCLUDED
SEAL: 898550
DISC SET: 124290-PKG

12
1-2

1/2 Turn Ceramic
Polished Gold Stem

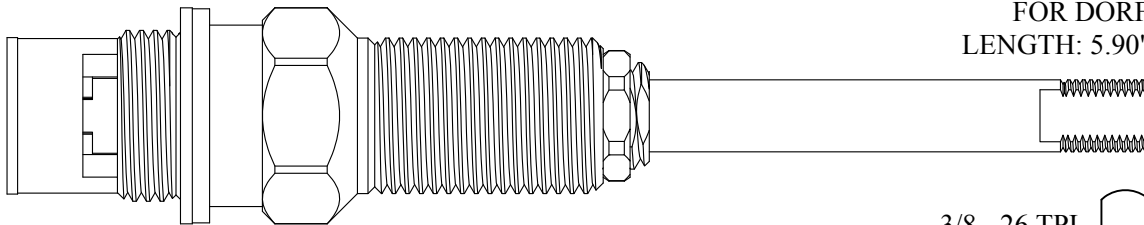

FOR DORF
LENGTH: 5.90"

425941/ 425942

DISC SET: 124290-PKG
GASKET: 895370 INCLUDED

Also available with Polished Chrome Stem
425941-CP/ 425942-CP

3/8 - 26 TPI

1/4 Turn Ceramic
Polished Gold Stem

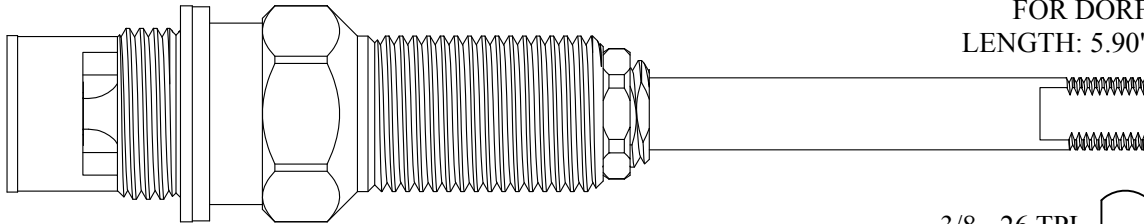

FOR DORF
LENGTH: 5.90"

425981/ 425982

DISC SET: 151380-PKG
GASKET: 895370 INCLUDED

3/8 - 26 TPI

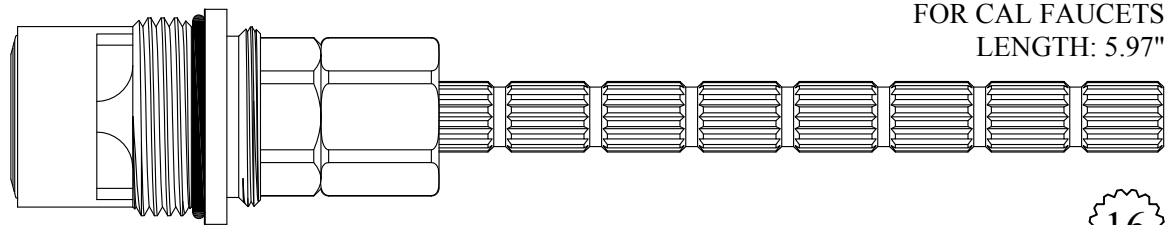

FOR CAL FAUCETS
LENGTH: 5.97"

421661/ 421662

GASKET: 890210 O-RING INCLUDED
SEAL: 898520
DISC SET: 109850-PKG

16
1-6

CERAMIC DISC CARTRIDGES

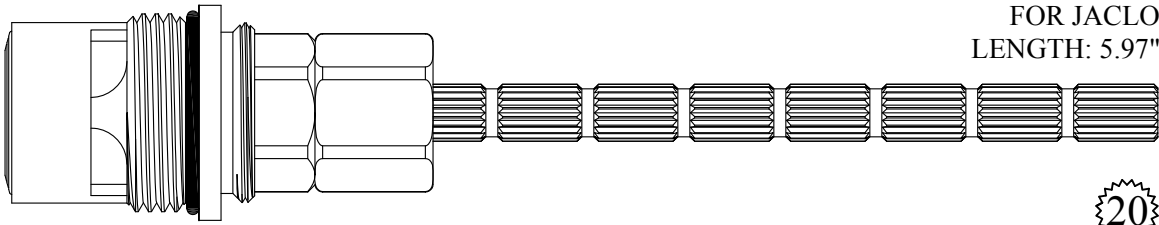

FOR JACLO
LENGTH: 5.97"

20
3-20

421681/ 421682

GASKET: 890210 O-RING INCLUDED
SEAL: 898520
DISC SET: 109850-PKG

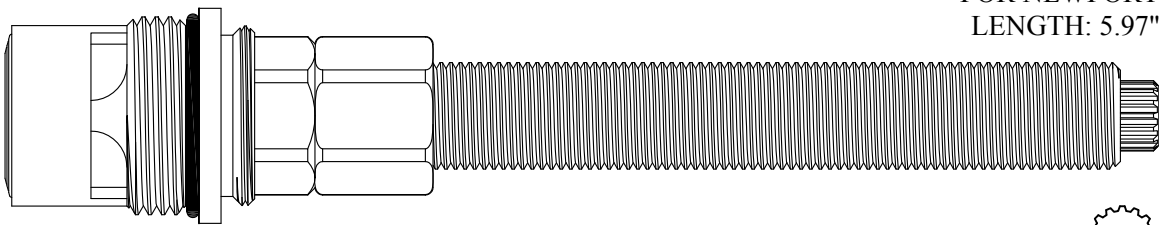

FOR NEWPORT
LENGTH: 5.97"

16
3-16

424911/ 424912

GASKET: 890210 O-RING INCLUDED
SEAL: 898520
DISC SET: 109850-PKG

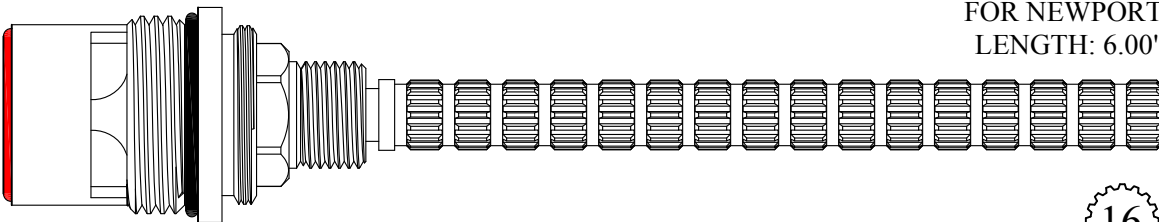

FOR NEWPORT
LENGTH: 6.00"

16
3-16

423651/ 423652

GASKET: 890210 O-RING INCLUDED
SEAL: 898610-R/B
DISC SET: 109850-PKG

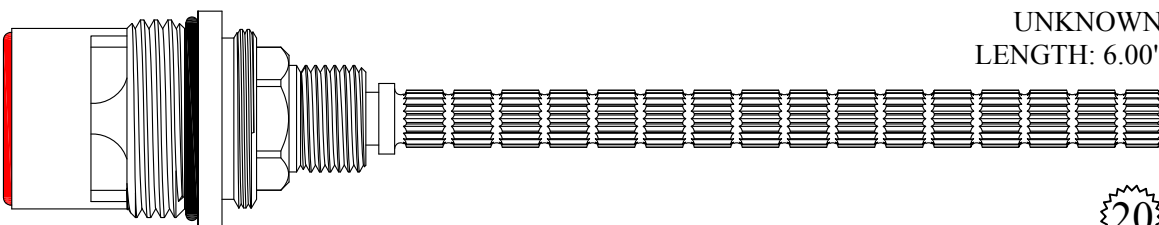

UNKNOWN
LENGTH: 6.00"

20
3-20

423671/ 423672

GASKET: 890170 O-RING INCLUDED
SEAL: 898610-R/B
DISC SET: 109850-PKG

CERAMIC DISC CARTRIDGES

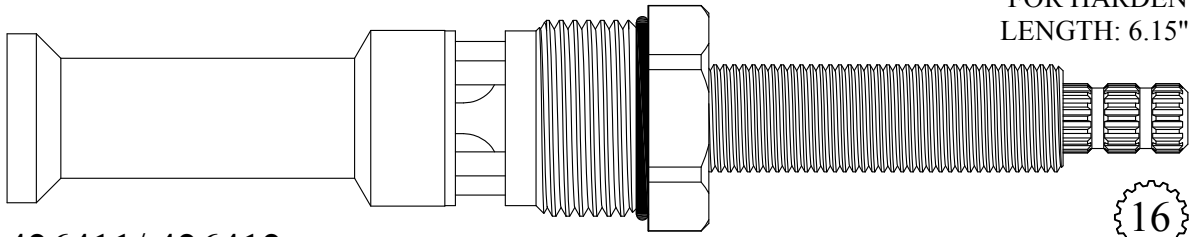

FOR HARDEN
LENGTH: 6.15"

426411/ 426412

GASKET: 890210 O-RING INCLUDED
SEAL: 64705-07
DISC SET: 151380-PKG



3-16

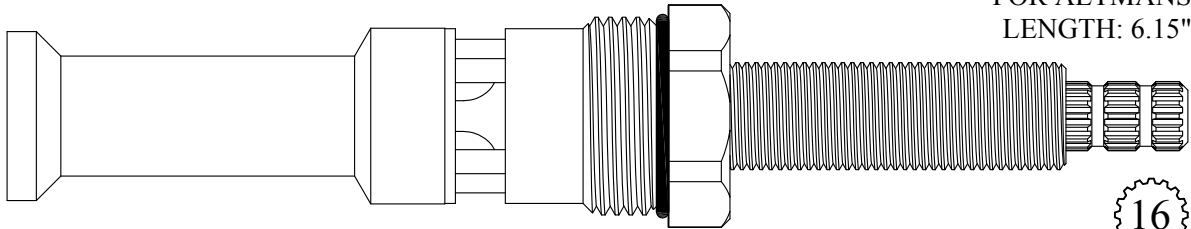

FOR ALTMANS
LENGTH: 6.15"

426421/ 426422

(Replaces Walter# 418811 / 418812 Compression Units)

GASKET: 890210 O-RING INCLUDED
SEAL: 64705-07
DISC SET: 151380-PKG



3-16

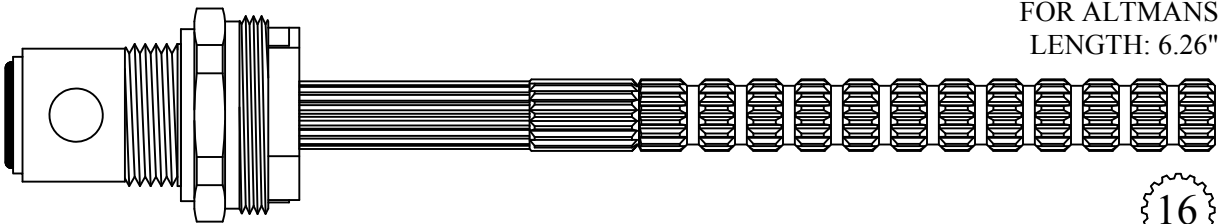

FOR ALTMANS
LENGTH: 6.26"

426731/ 426732

GASKET: 895100 INCLUDED



3-16

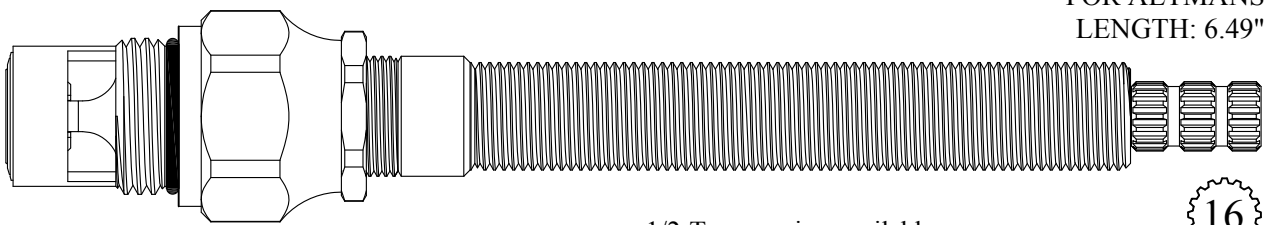

FOR ALTMANS
LENGTH: 6.49"

426841/ 426842

459201 / 459202
w/ ceramic adapter parts

GASKET: 890170 O-RING INCLUDED
SEAL: 898510-W
DISC SET: 151380-PKG

1/2-Turn version available:

426891/ 426892

459211 / 459212
w/ ceramic adapter parts

GASKET: 890170 O-RING INCLUDED
SEAL: 898510-W
DISC SET: 124290-PKG



3-16

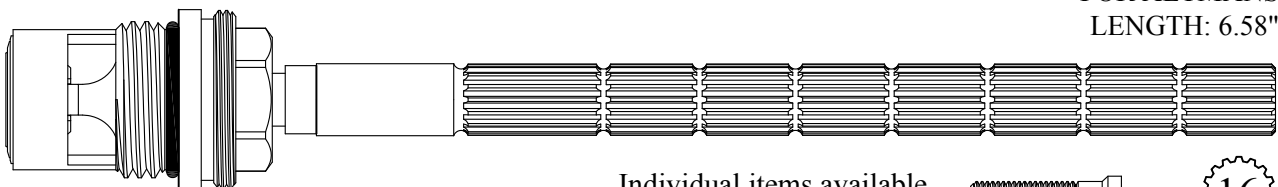

FOR ALTMANS
LENGTH: 6.58"

426881/ 426882

GASKET: 890170 O-RING INCLUDED
SEAL: 898510-W
DISC SET: 151380-PKG

Individual items available
Stem Ext. 5.00": #118290
Ext. Adap. Screw: #103310



3-16

CERAMIC DISC CARTRIDGES

FOR PHYLRICH
LENGTH: 6.58"

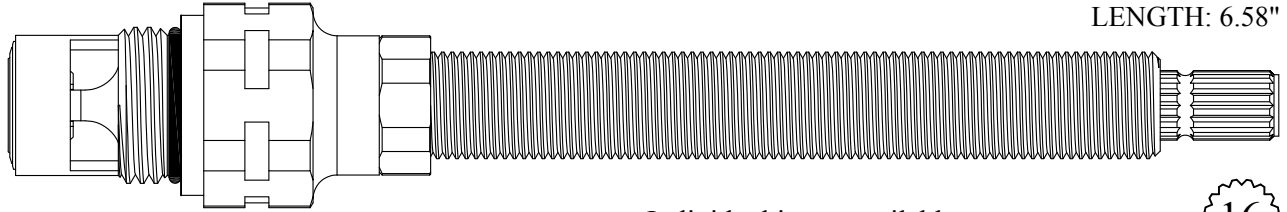

427281/ 427282

GASKET: 890170 O-RING INCLUDED
SEAL: 898510-W
DISC SET: 151380-PKG

Individual items available
Stem Ext. 5.00": #136050
Ext. Adap. Screw: #103310

16
1-6

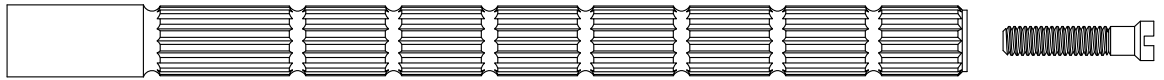

403941/ 403942

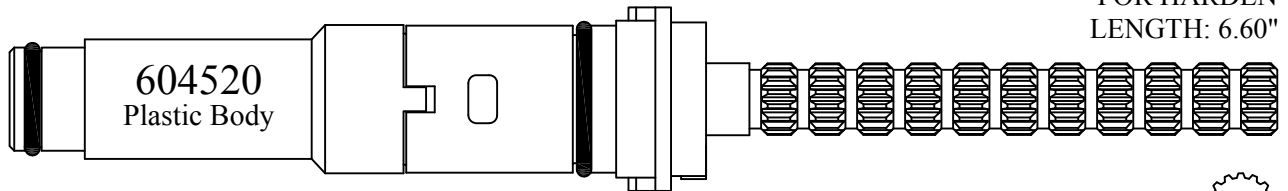

FOR HARDEN
LENGTH: 6.60"

Available: Stem Only
203941
203942

16
3-16

Nickel Plated Gland

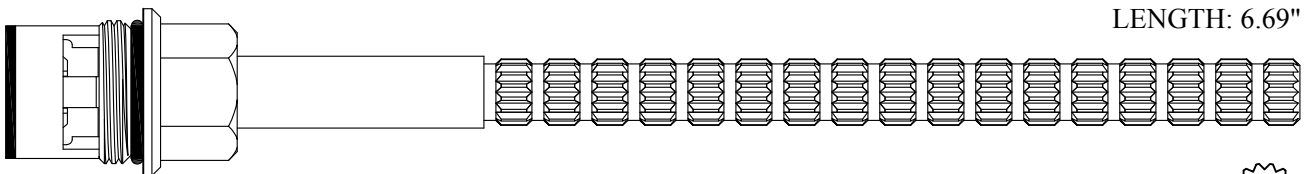

FOR AUBURN BRASS
LENGTH: 6.69"

427601/ 427602

GASKET: 890160 O-RING INCLUDED
DISC SET: 151380-PKG

16
2-3

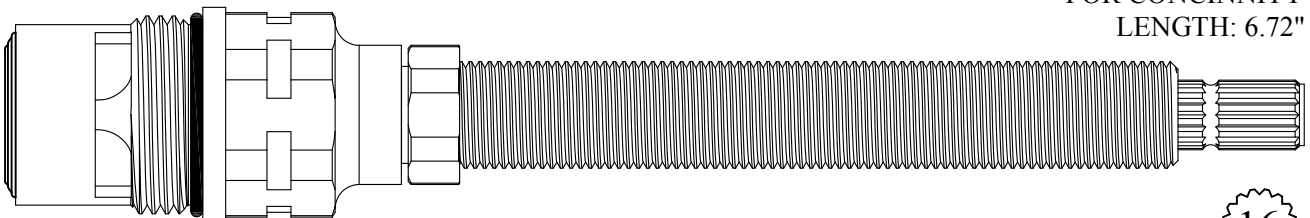

FOR CONCINNITY
LENGTH: 6.72"

428031/ 428032

GASKET: 890210 O-RING INCLUDED
SEAL: 898520
DISC SET: 109850-PKG

Individual items available
Stem Ext. 5.00": #136050
Ext. Adap. Screw: #103310

16
1-6

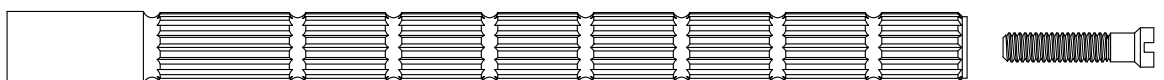

CERAMIC DISC CARTRIDGES

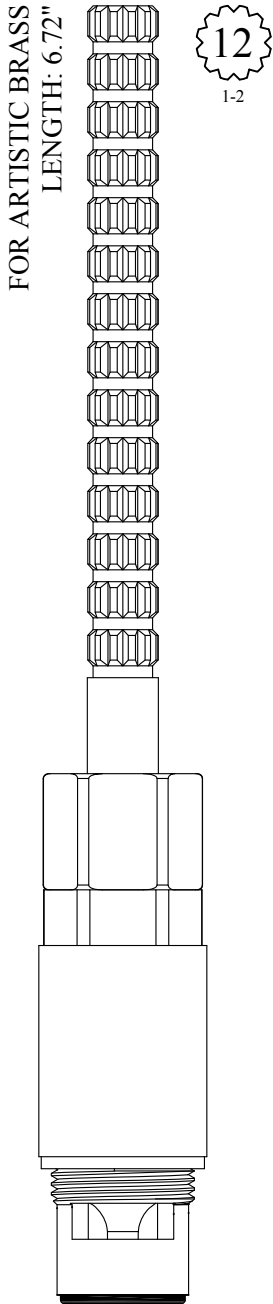

GASKET: 895100 INCLUDED
SEAL: 898540
DISC SET: 112530-PKG

427301
427302

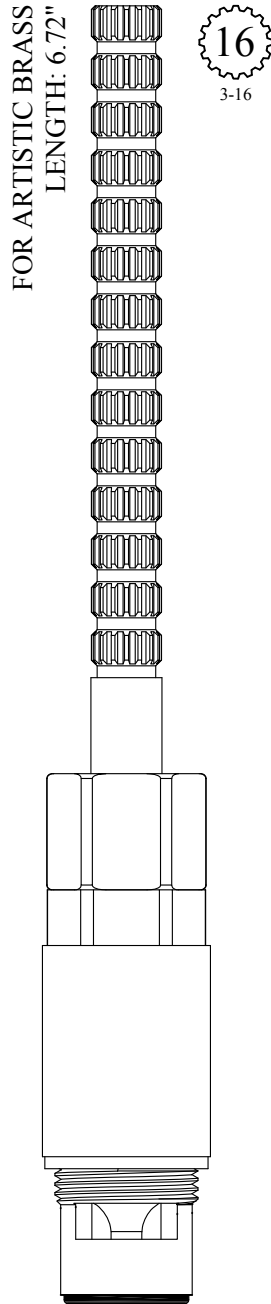

GASKET: 895100 INCLUDED
SEAL: 898540
DISC SET: 112530-PKG

427331
427332

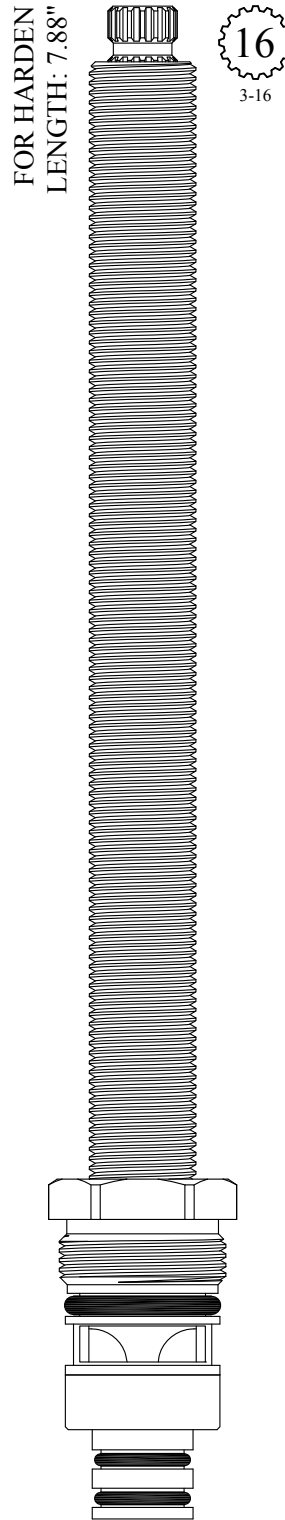

GASKET: 891140 O-RING INCLUDED
DISC SET: 151380-PKG

428201
428202

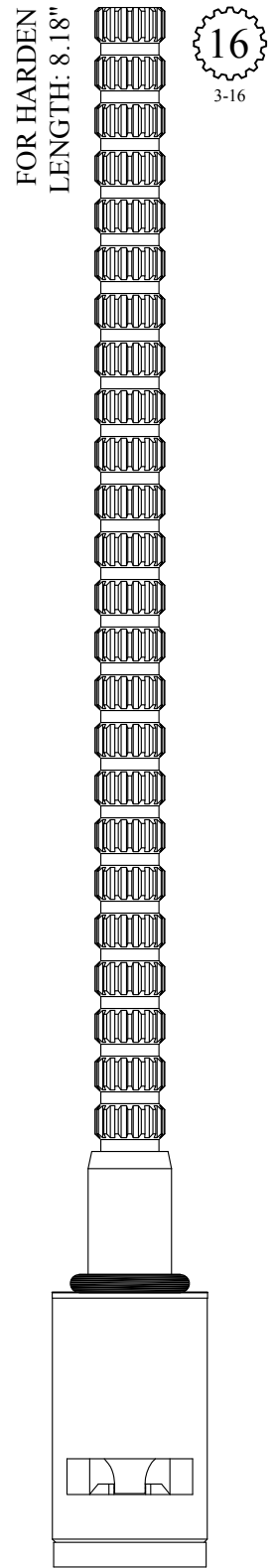

DISC SET: 151380-PKG

428211
428212

CERAMIC DISC CARTRIDGES

FOR HARDEN
LENGTH: 8.32"

16
3-16

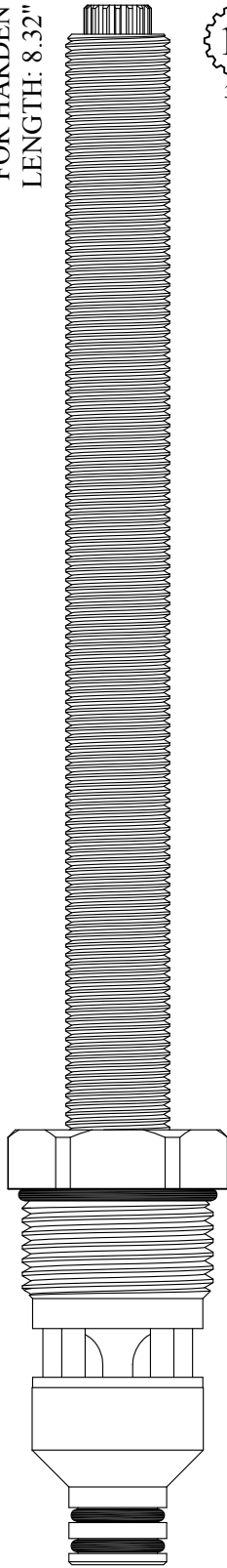

GASKET: 890210 O-RING INCLUDED
DISC SET: 151380-PKG

428111
428112

FOR HARDEN
LENGTH: 9.35"

16
3-16

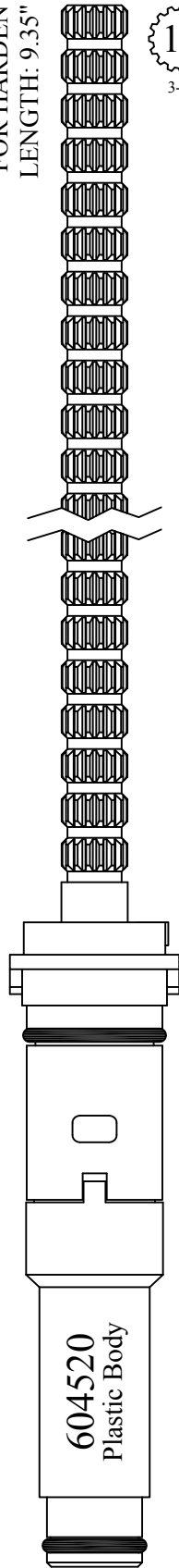

Available: Stem Only

227311 / 227312

427311
427312

FOR HARDEN
LENGTH: 9.66"

16
3-16

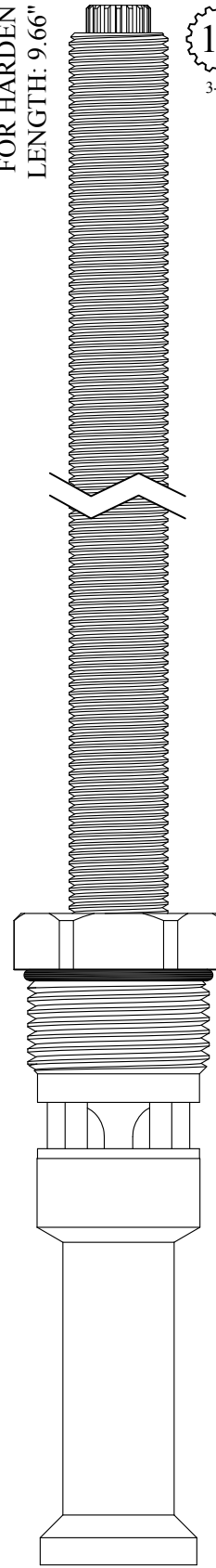

GASKET: 890210 O-RING INCLUDED
SEAL: 64705-07
DISC SET: 151380-PKG

428441
428442

FOR ALTMANS
LENGTH: 9.66"

16
3-16

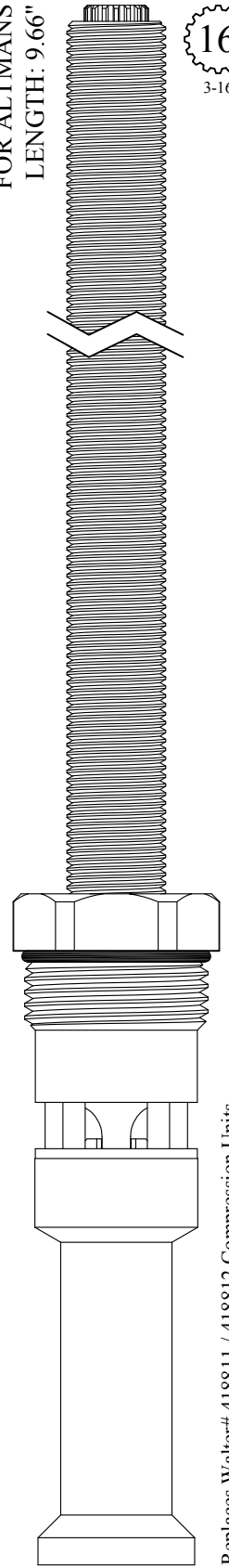

GASKET: 890210 O-RING INCLUDED
SEAL: 64705-07
DISC SET: 151380-PKG

428461
428462

Replaces Walter# 418811 / 418812 Compression Units

CERAMIC DISC CARTRIDGES

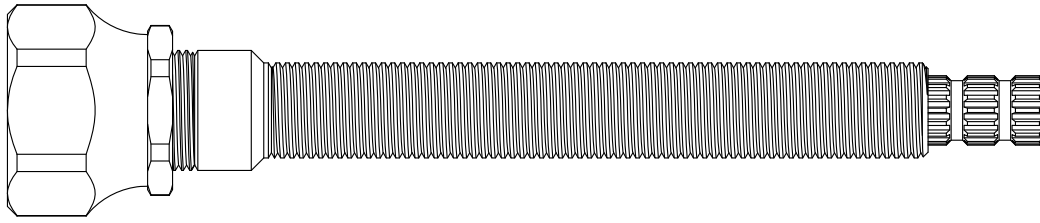

STEM EXTENSIONS

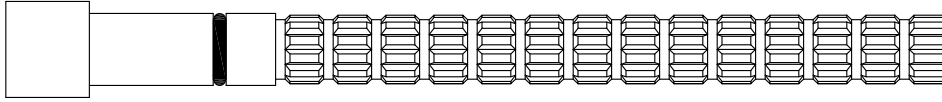

Female 20pt European Broach to:	Part #
Male 16pt Harden, Altmans, Etc.	105090
Male 12pt Price Pfister	105230
Male 20pt Speakman, Broadway	105370
Male 16pt Sayco, Gerber	105510
Male 20pt European	106140

106070
16pt Harden Stem Ext. with
1/4-20 Male Thread

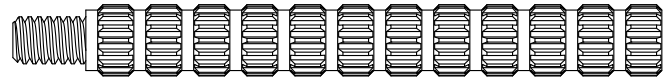

* For more Stem Extensions see the Stem Extension Section

NIPPLE EXTENSIONS

5/8-24 x 1/2-24	105720
5/8-24 x 9/16-20	105790
5/8-24 x 5/8-18	105860
5/8-24 x 11/16-24	105930
5/8-24 x 5/8-24	106280

106000
9/16-20 Nipple Extension

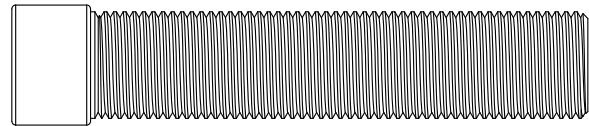

611270
9/16-20 x 9/16-20
Nipple Extension Adapter

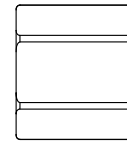
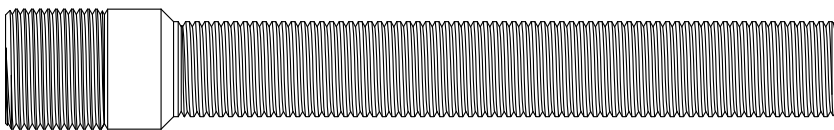

105650
Tapped 5/8-24
Locknut for Nipple Adapter

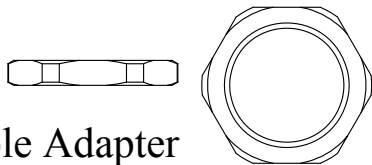

106210
10-24 Female x 1/4-20 Male
Handle Screw Adapter



5/8-24

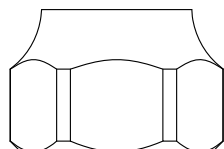

105580
Nipple Adapter

M24 X 1.00

BARRY E.  WALTER SR. CO.

NON-RISING UNITS

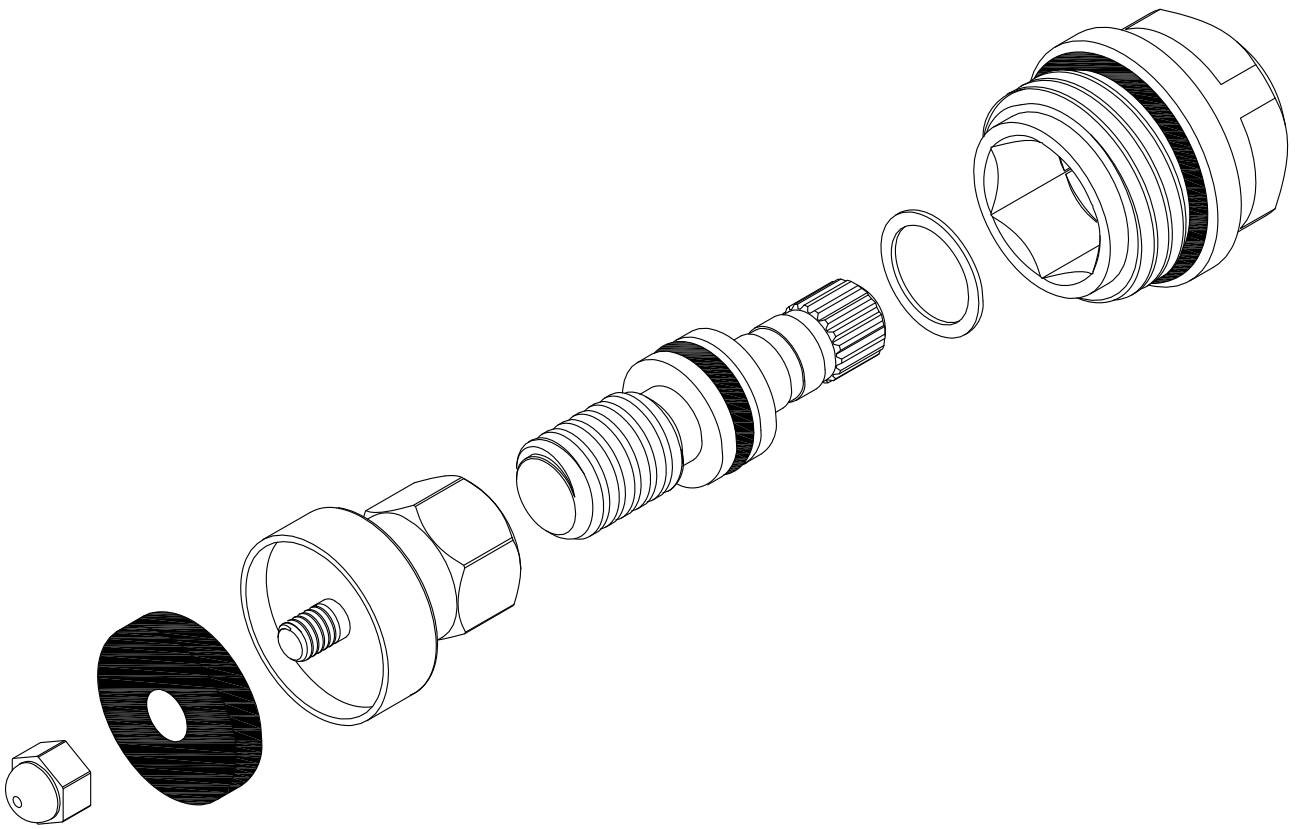

NON-RISING UNITS

FOR INDIANA
LENGTH: 1.36"

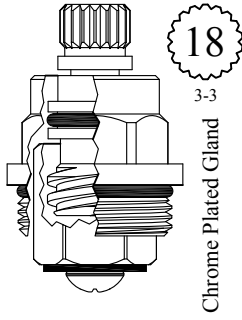

GASKET: 890170 O-RING INCLUDED

LF450501
LF450502

UNKNOWN
LENGTH: 1.67"

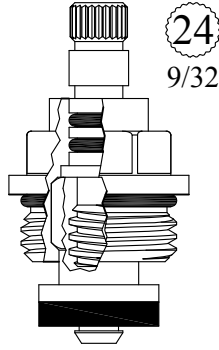

GASKET: 890170 O-RING INCLUDED

LF455942

UNKNOWN
LENGTH: 1.75"

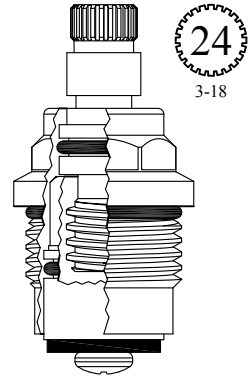

GASKET: 890170 O-RING INCLUDED

LF455422

UNKNOWN
LENGTH: 1.79"

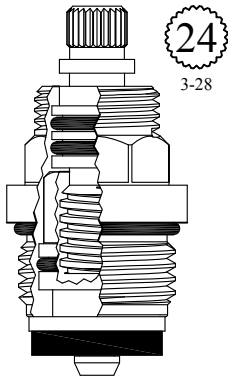

GASKET: 890170 O-RING INCLUDED

LF456422

FOR MOEN
LENGTH: 1.79"

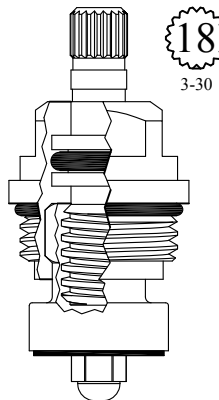

GASKET: 890180 O-RING INCLUDED

LF455362

FOR ELJER
LENGTH: 1.79"

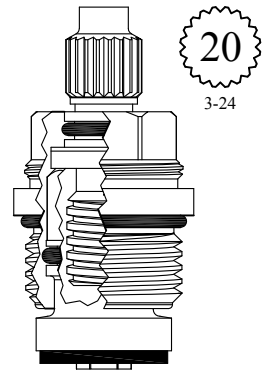

GASKET: 890170 O-RING INCLUDED

LF455962

FOR KINGSBURY
LENGTH: 1.82"

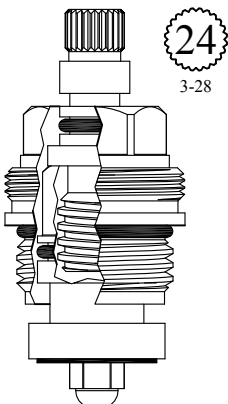

GASKET: 890170 O-RING INCLUDED

LF455972

FOR PIAZZA
LENGTH: 1.85"

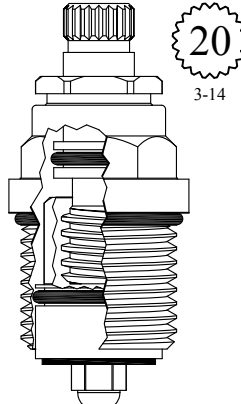

GASKET: 890180 O-RING INCLUDED

LF460802

UNKNOWN
LENGTH: 1.87"

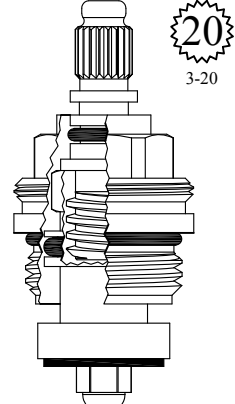

GASKET: 890170 O-RING INCLUDED

LF456462

NON-RISING UNITS

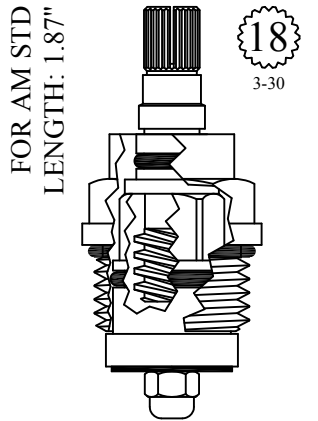

18
3-30

GASKET: 890180 O-RING INCLUDED

LF456302

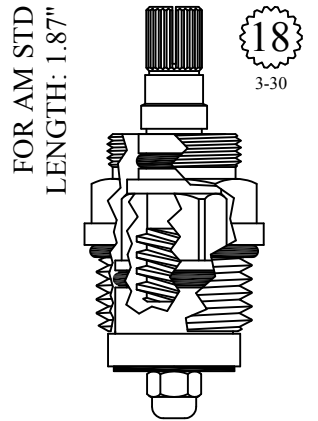

18
3-30

GASKET: 890180 O-RING INCLUDED

LF456312

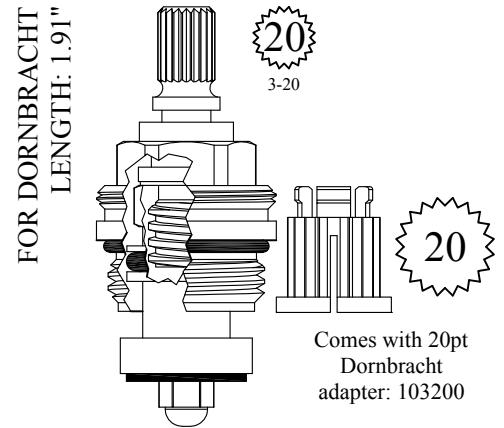

20
3-20

20

Comes with 20pt
Dornbracht
adapter: 103200

GASKET: 890170 O-RING INCLUDED

LF456362

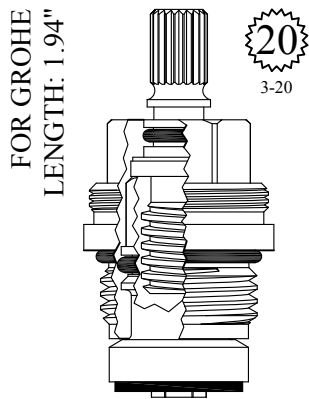

20
3-20

GASKET: 890170 O-RING INCLUDED

LF457282

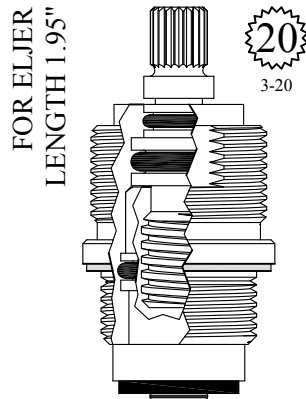

20
3-20

GASKET: 895160 INCLUDED

LF457242

Comes with handle screw: # 899230

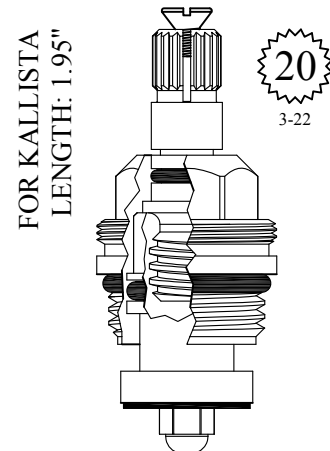

20
3-22

GASKET: 891150 O-RING INCLUDED

LF458502

Comes with handle screw: # 899230

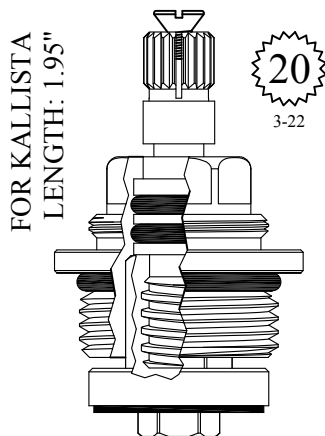

20
3-22

GASKET: 891180 O-RING INCLUDED

401072

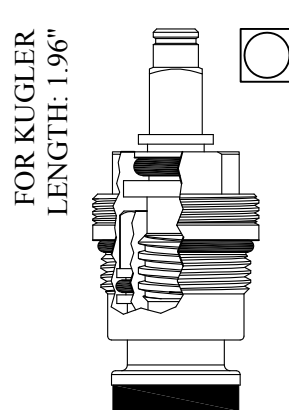

FOR KUGLER
LENGTH: 1.96"

GASKET: 890170 O-RING INCLUDED

LF457262

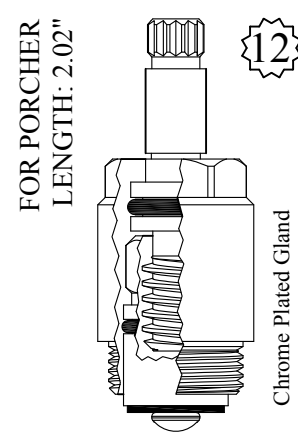

12

Chrome Plated Gland

LF458602

NON-RISING UNITS

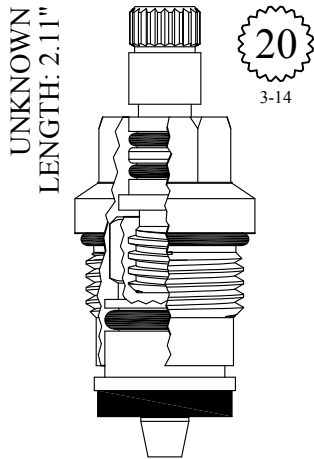

GASKET: 890180 O-RING INCLUDED

LF459482

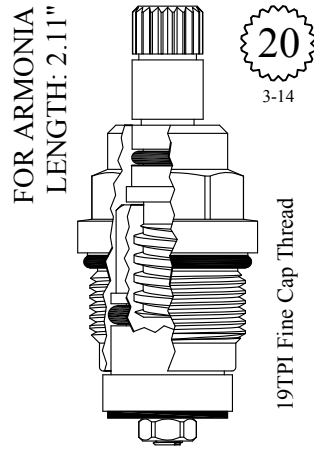

GASKET: 890180 O-RING INCLUDED

LF460172

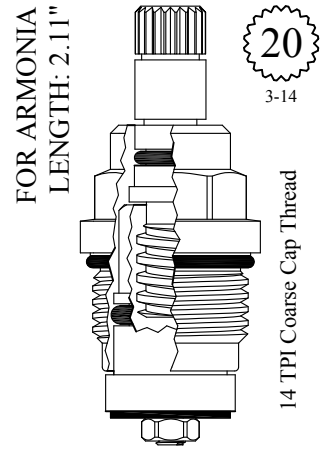

GASKET: 890180 O-RING INCLUDED

LF460182

Comes with handle screw:
899230

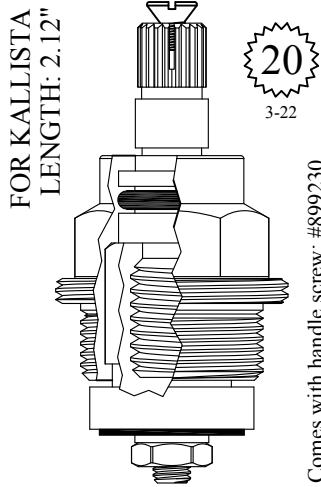

GASKET: 895350

LF463602

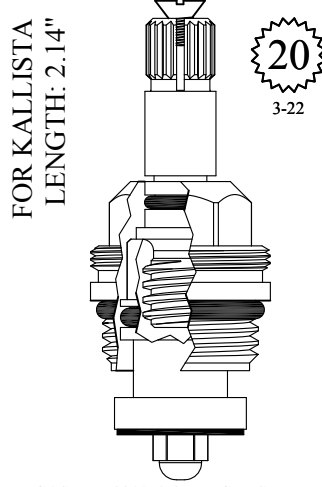

GASKET: 891150 O-RING INCLUDED

LF459801
LF459802

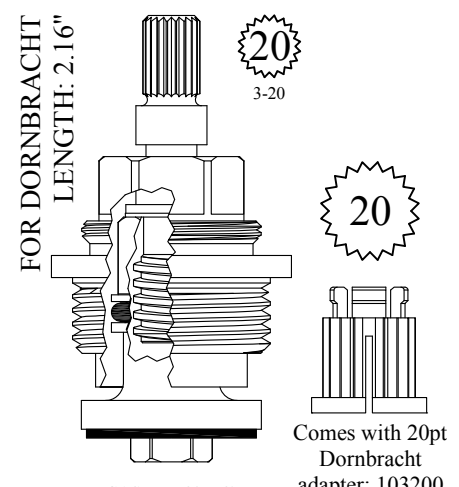

GASKET: 895560

401082

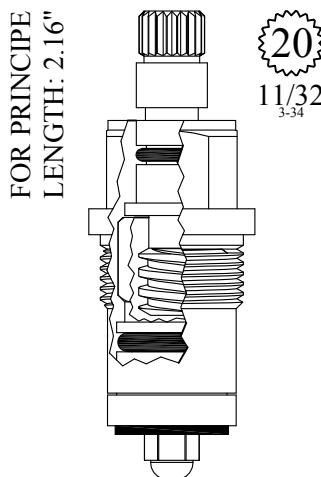

GASKET: 895100

LF459812

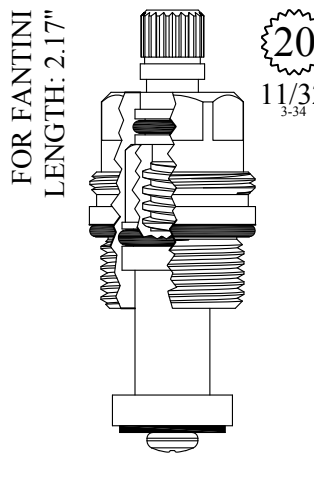

GASKET: 890170 O-RING INCLUDED

LF463332

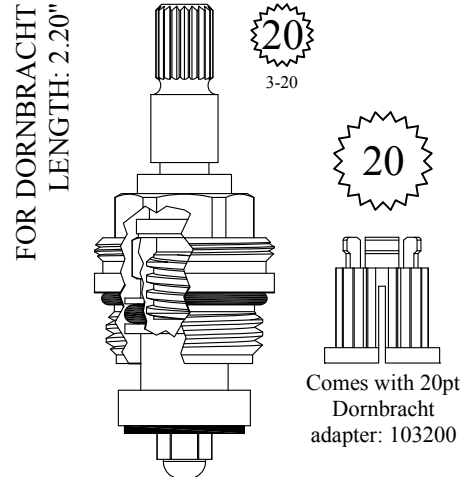

GASKET: 890170 O-RING INCLUDED

LF459512

NON-RISING UNITS

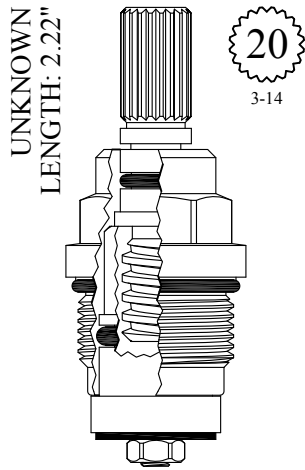

GASKET: 890180 O-RING INCLUDED

LF460272

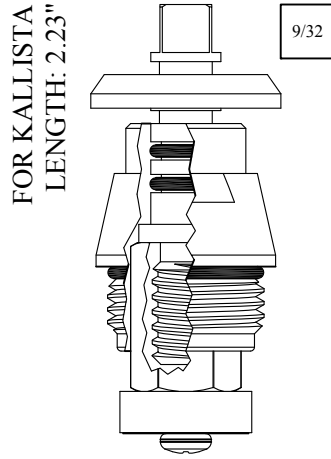

GASKET: 890170 O-RING INCLUDED

LF460652

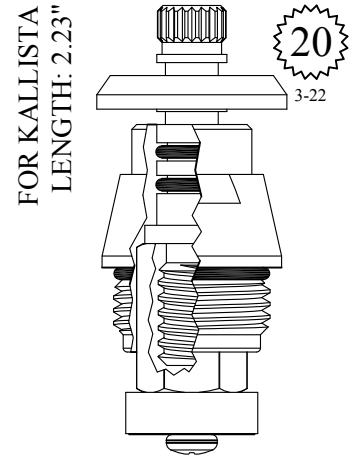

GASKET: 890170 O-RING INCLUDED

LF460672

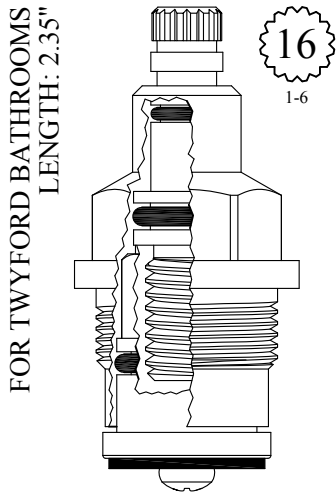

GASKET: 895370

401372

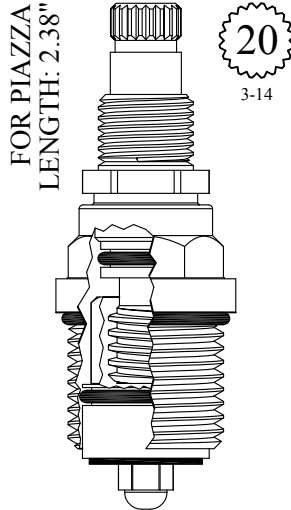

GASKET: 890180 O-RING INCLUDED

LF463702

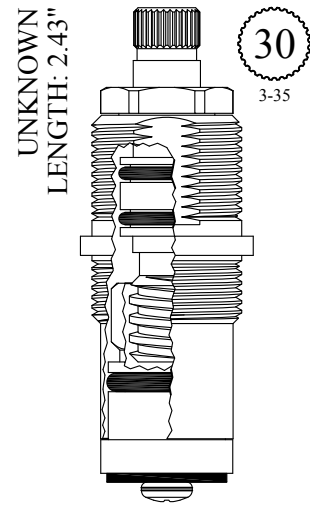

GASKET: 895140

LF463302

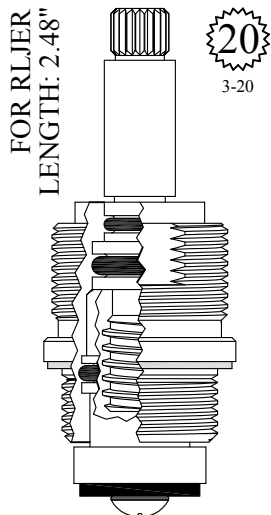

GASKET: 895160 INCLUDED

401342

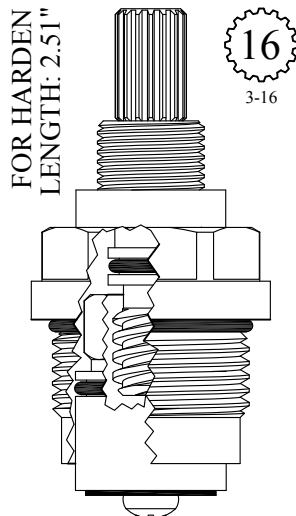

GASKET: 890210 O-RING INCLUDED

LF463901
LF463902

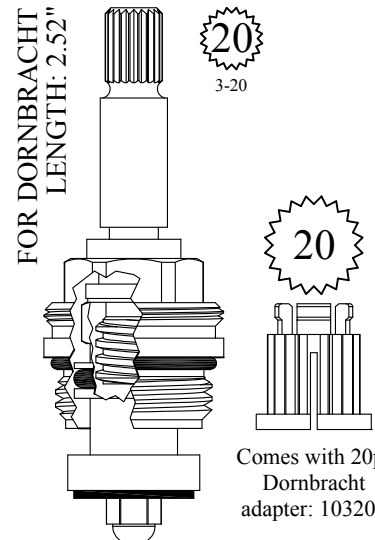

GASKET: 890170 O-RING INCLUDED

LF463872

Comes with 20pt
Dornbracht
adapter: 103200

NON-RISING UNITS

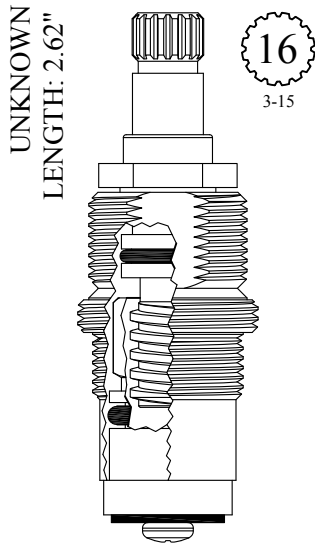

GASKET: 895140

LF464602

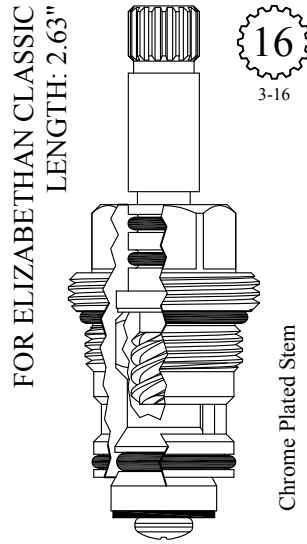

GASKET: 890180 O-RING INCLUDED

430881

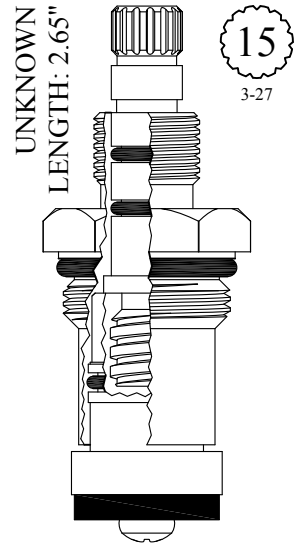

GASKET: 891160 INCLUDED

LF464391
LF464392

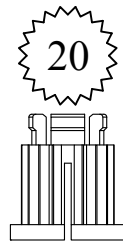

Comes with 20pt Dornbracht
adapter: 103200

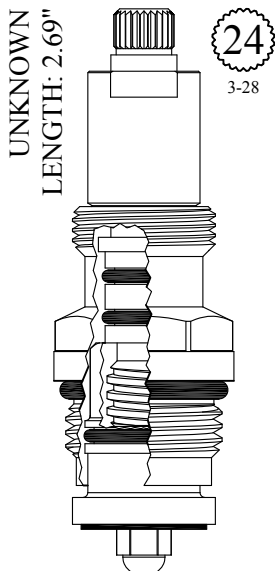

GASKET: 891150 INCLUDED

LF464712

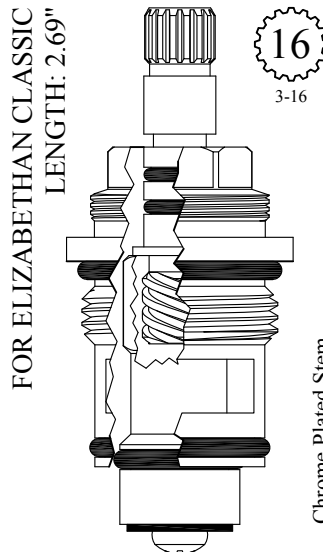

GASKET: 890180 O-RING INCLUDED

431052

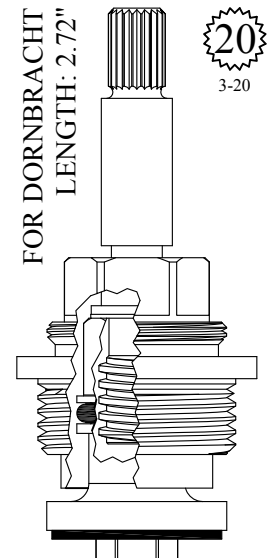

GASKET: 895560

401762

NON-RISING UNITS

UNKNOWN
LENGTH: 2.76"

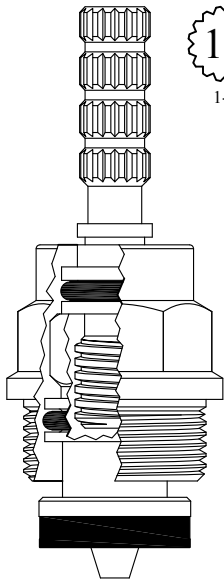

16
1-6

GASKET: 895330

LF465702

UNKNOWN
LENGTH: 2.83"

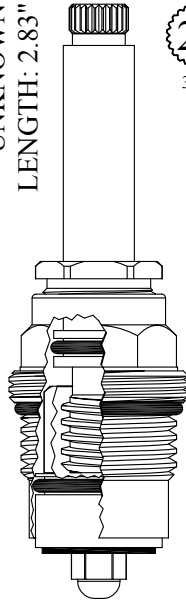

24
3-28

GASKET: 890180 INCLUDED

LF464962

UNKNOWN
LENGTH: 2.91"

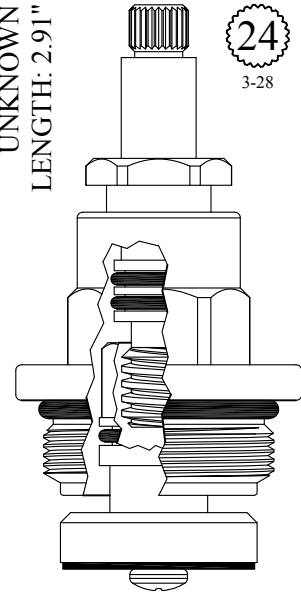

24
3-28

GASKET: 891210 O-RING INCLUDED

401922

Chrome Plated Unit

UNKNOWN
LENGTH: 2.94"

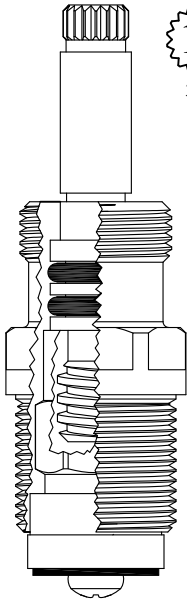

18
3-25

GASKET: 895180

401722

FOR ARMONIA
LENGTH: 3.05"

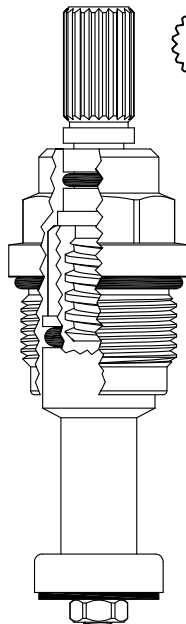

20
3-14

GASKET: 890180 O-RING INCLUDED

401822

19 TPI Gland Fine Thread

UNKNOWN
LENGTH: 3.08"

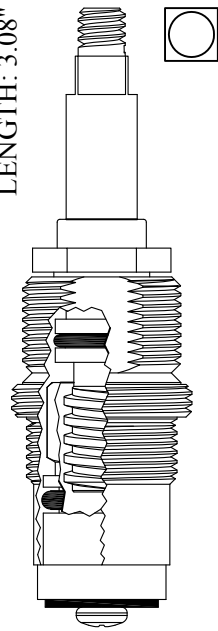

GASKET: 895160

LF466532

NON-RISING UNITS

Comes with handle screw:
899240

FOR ELJER
LENGTH: 3.12"

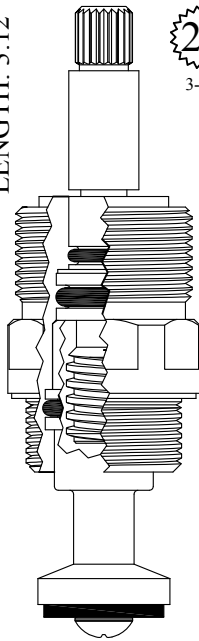

20
3-20

GASKET: 895160 INCLUDED

402012

FOR AM STD
LENGTH: 3.14"

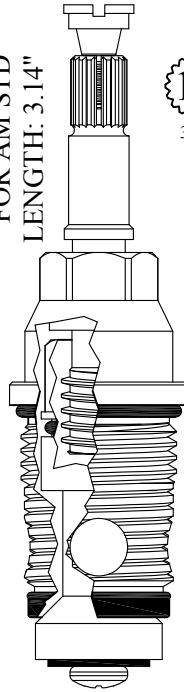

18
3-30

GASKET: 890170 O-RING INCLUDED

430022

FOR JAMECO
LENGTH: 3.20"

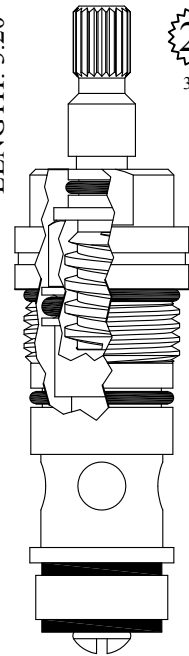

20
3-20

GASKET: 890170 O-RING INCLUDED

430392

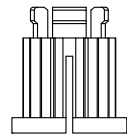

20

Comes with 20pt Dornbracht
adapter: 103200

FOR LABONGE
LENGTH: 3.22"

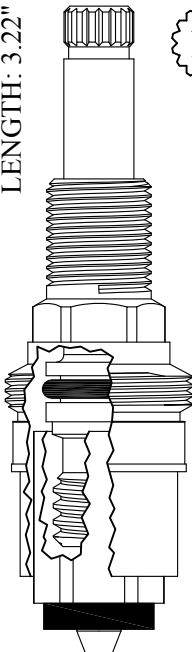

16
1-6

LF466712

FOR DORNBRACHT
LENGTH: 3.24"

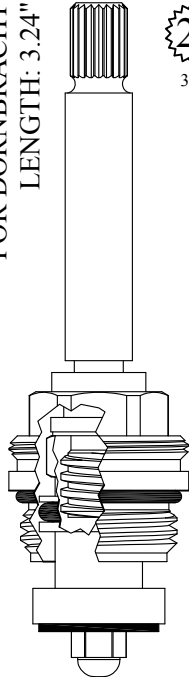

20
3-20

GASKET: 890170 O-RING INCLUDED

402242

UNKNOWN
LENGTH: 3.25"

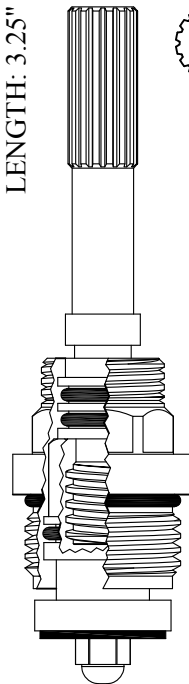

16
3-15

GASKET: 890170 O-RING INCLUDED

402472

FOR PIAZZA
LENGTH: 3.26"

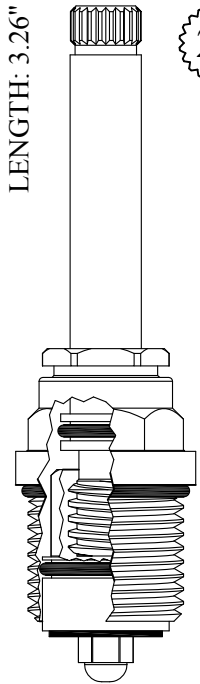

20
3-14

GASKET: 890180 O-RING INCLUDED

402252

NON-RISING UNITS

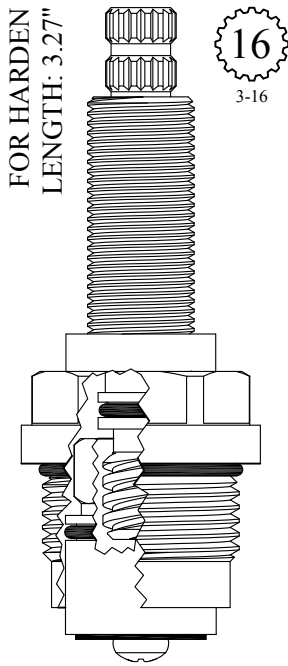

GASKET: 890210 O-RING INCLUDED

402421
402422

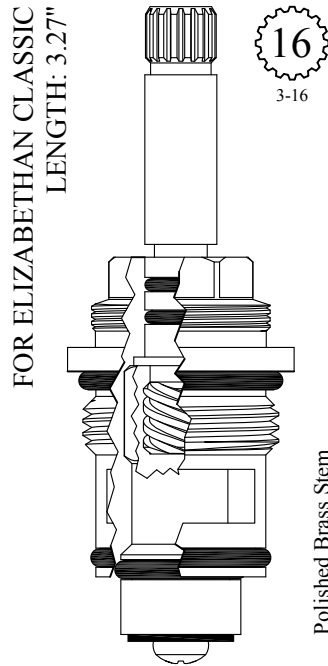

GASKET: 890180 O-RING INCLUDED

431552

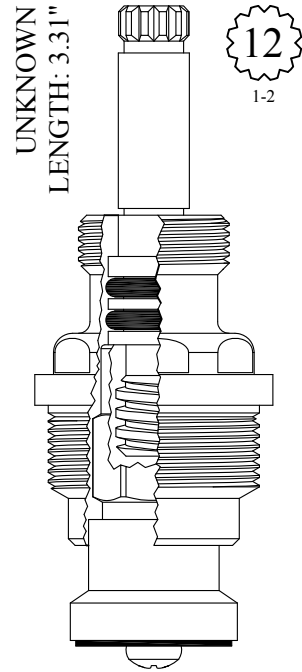

GASKET: 895450

402522

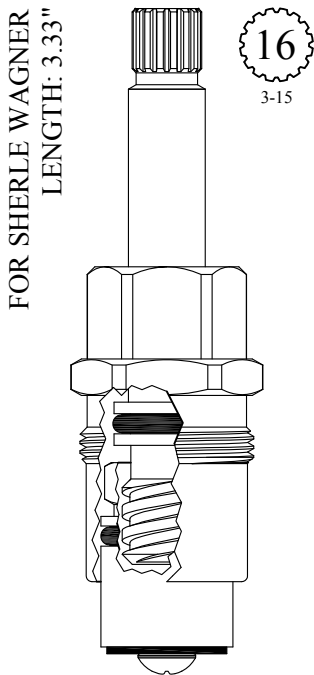

GASKET: 895100

LF467501
LF467502

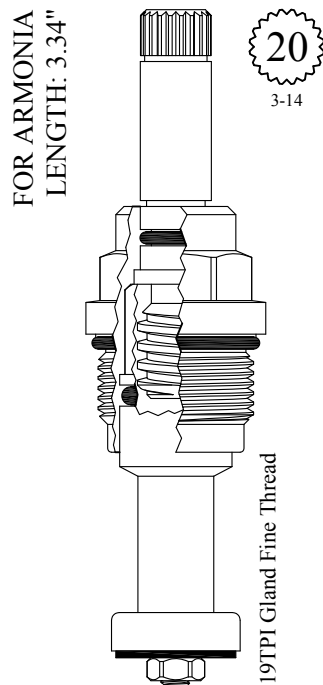

GASKET: 890180 O-RING INCLUDED

402532

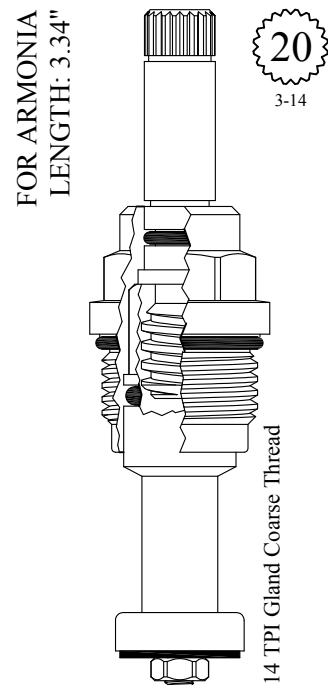

GASKET: 890180 O-RING INCLUDED

402542

NON-RISING UNITS

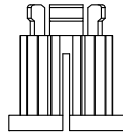

20

Comes with 20pt Dornbracht adapter: 103200

UNKNOWN
LENGTH: 3.35"

24
3-28

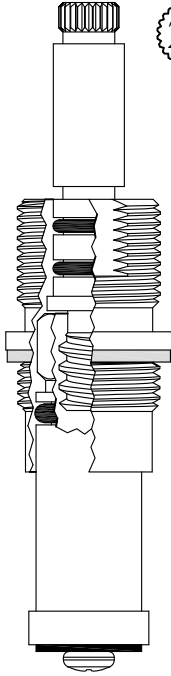

GASKET: 895100 INCLUDED

LF466822

FOR DORNBRACHT
LENGTH: 3.35"

20
3-20

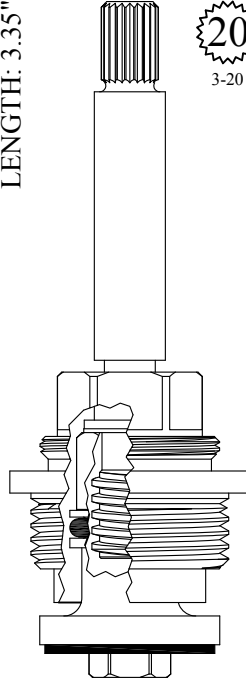

GASKET: 895560

402752

FOR GROHE
LENGTH 3.38"

20
3-20

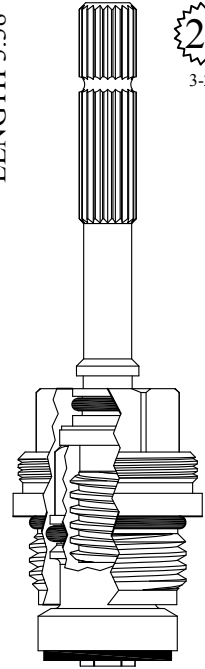

GASKET: 890170 O-RING INCLUDED

402642

FOR AM STD
LENGTH: 3.39"

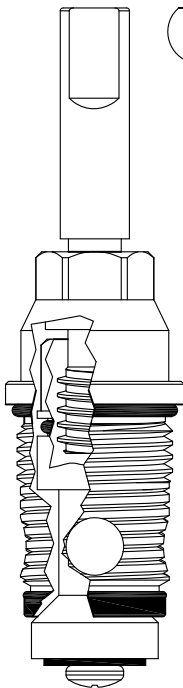

430662

FOR KALLISTA
LENGTH: 3.44"

9/32

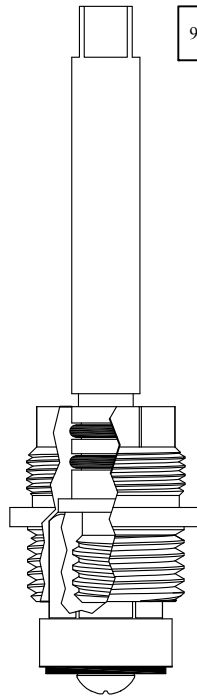

GASKET: 895160

402762

FOR AUBURN BRASS
LENGTH: 3.51"

16
2-3

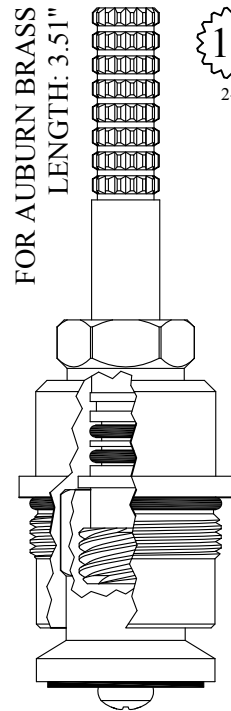

GASKET: 890200 O-RING INCLUDED

403021
403022

NON-RISING UNITS

Comes with handle screw:
899230

UNKNOWN
LENGTH: 3.56"

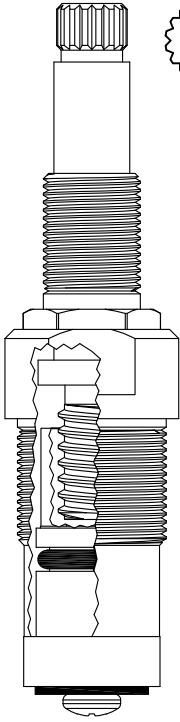

16
1-6

GASKET: 895140
402782

FOR KALLISTA
LENGTH: 3.57"

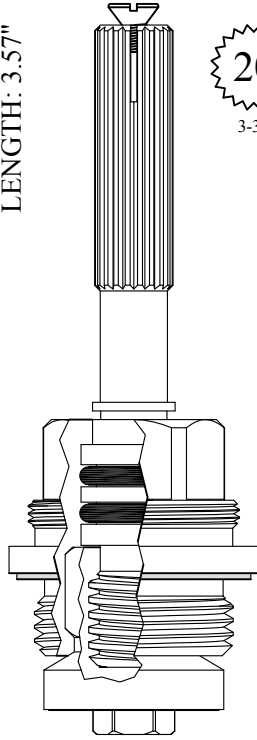

20
3-32

GASKET: 895440 INCLUDED
402792

FOR GROHE
LENGTH: 3.57"

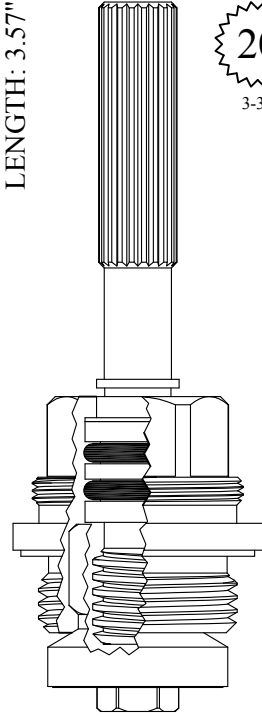

20
3-32

GASKET: 895440 INCLUDED
402892

FOR AM STD
LENGTH: 3.60"

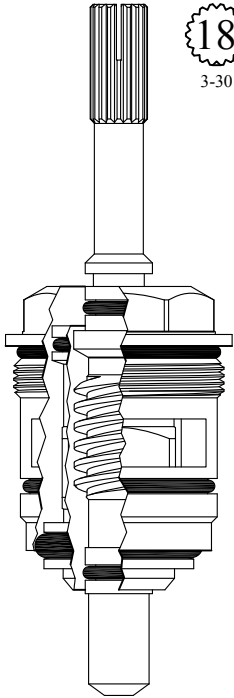

18
3-30

GASKET: 890210 O-RING INCLUDED
431681

FOR ELJER
LENGTH: 3.65"

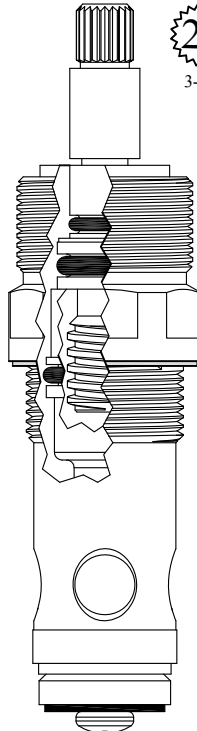

20
3-20

GASKET: 895160 INCLUDED
430192

UNKNOWN
LENGTH: 3.66"

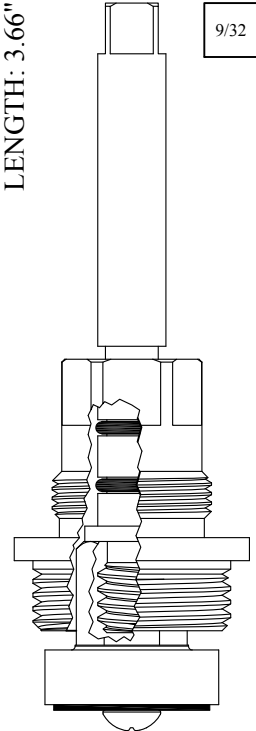

9/32

GASKET: 895560
403062

NON-RISING UNITS

FOR CIFIAL
LENGTH: 3.74"

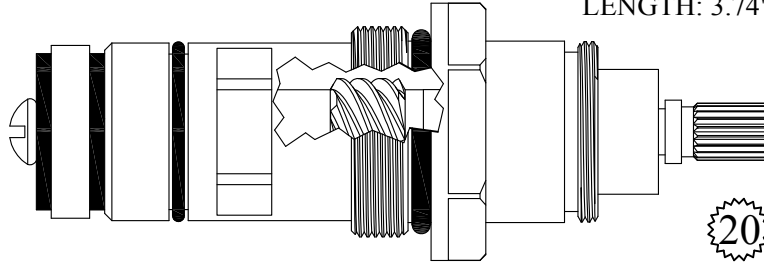

430871

GASKET: 891180 O-RING INCLUDED

20
3-20

UNKNOWN
LENGTH: 3.81"

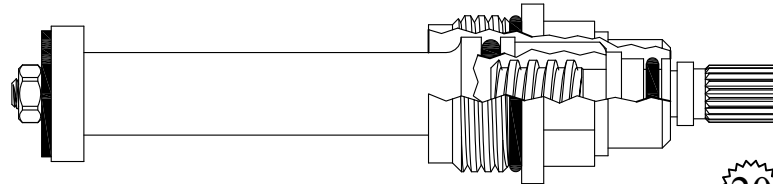

426812

GASKET: 890170 O-RING INCLUDED

20
3-20

FOR ELJER
LENGTH: 3.82"

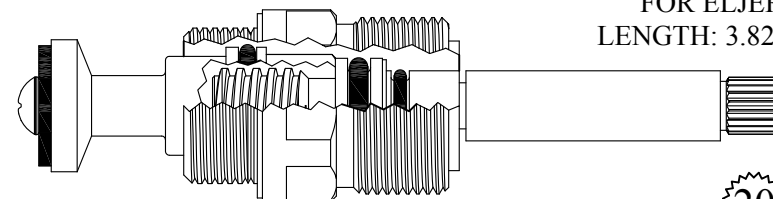

403232

GASKET: 895160 INCLUDED

20
3-20

FOR KALLISTA
LENGTH: 3.94"

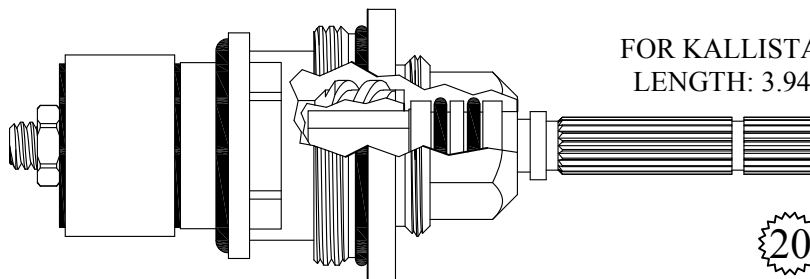

430982

GASKET: 890210 O-RING INCLUDED

20
3-20

NON-RISING UNITS

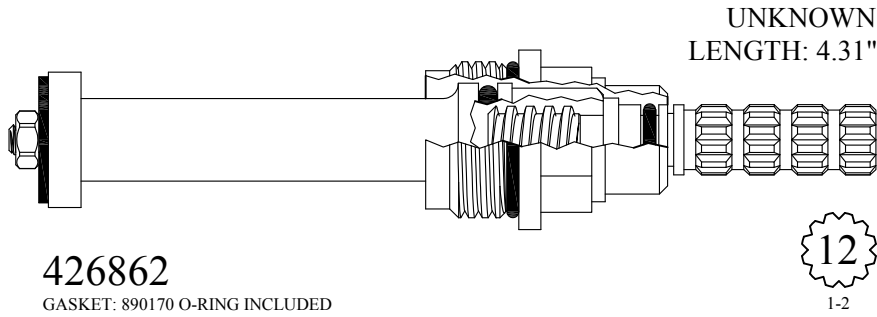

426862
GASKET: 890170 O-RING INCLUDED

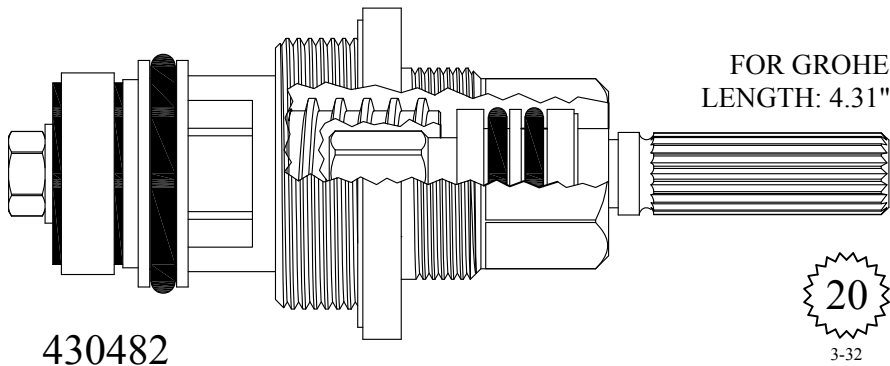

430482
GASKET: 895520 INCLUDED

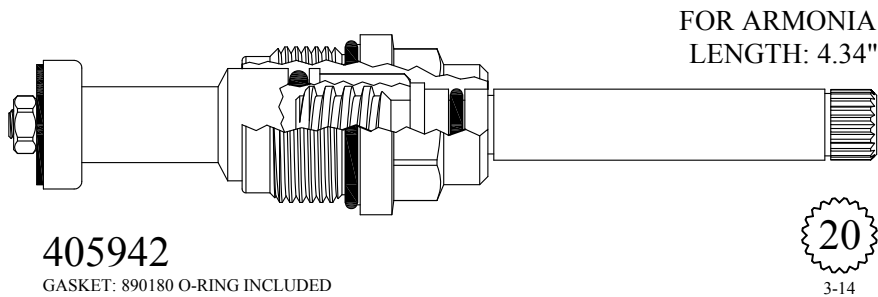
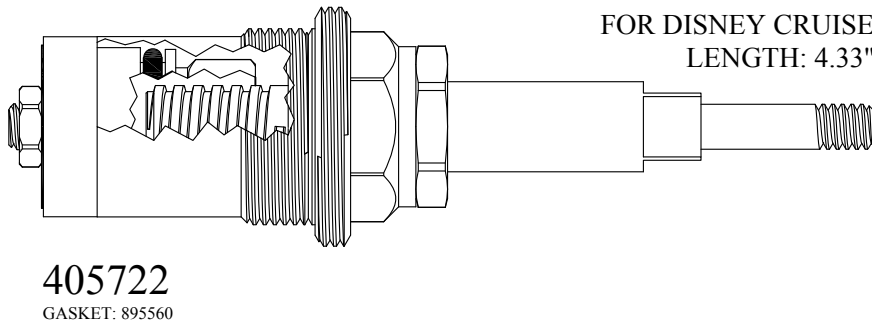

NON-RISING UNITS

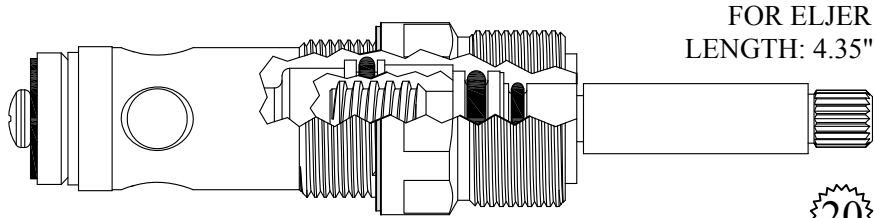

430552

GASKET INCLUDED: 895160

20
3-20

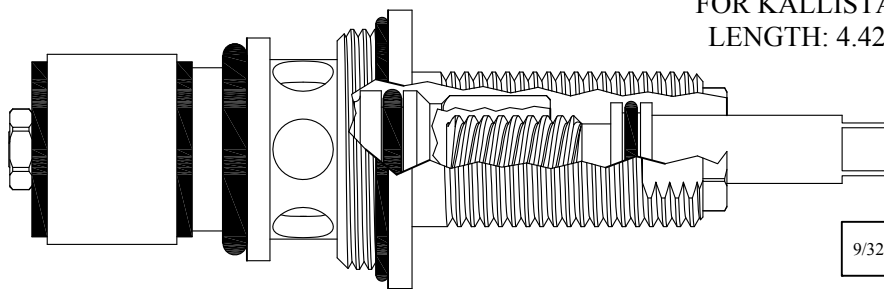

430642

GASKET: 890240 O-RING INCLUDED

9/32

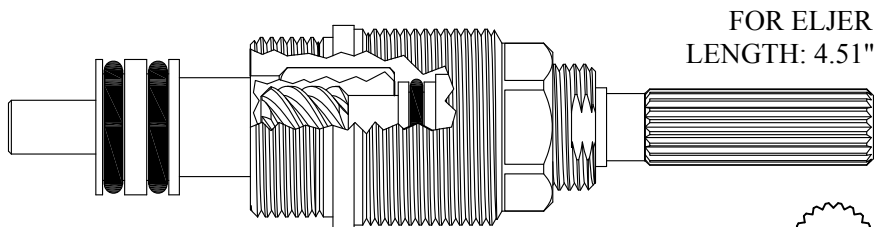

432071

GASKET: 895300

20
3-24

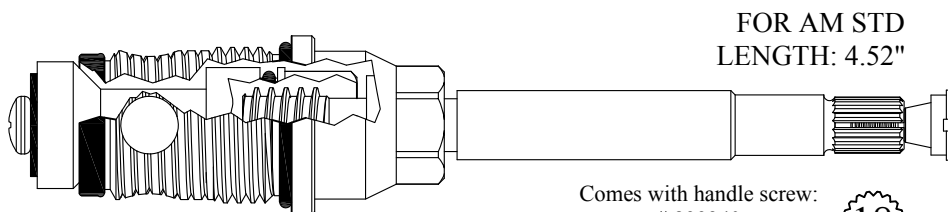

430692

GASKET: 890170

Comes with handle screw:
899240

18
3-30

NON-RISING UNITS

FOR KALLISTA
LENGTH: 4.55"

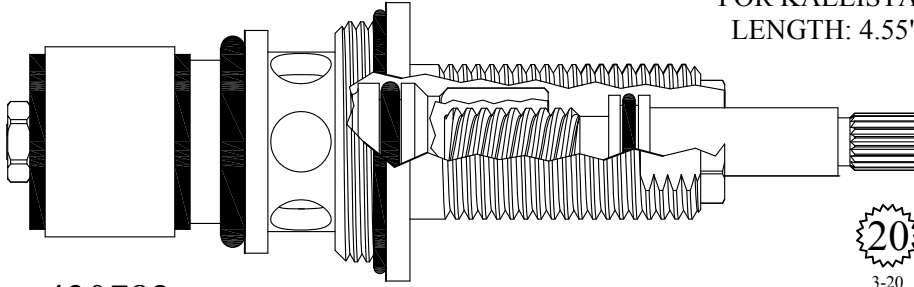

430782

GASKET: 890240 O-RING INCLUDED

20
3-20

Chrome Plated Stem

FOR ARMONIA
LENGTH: 4.60"

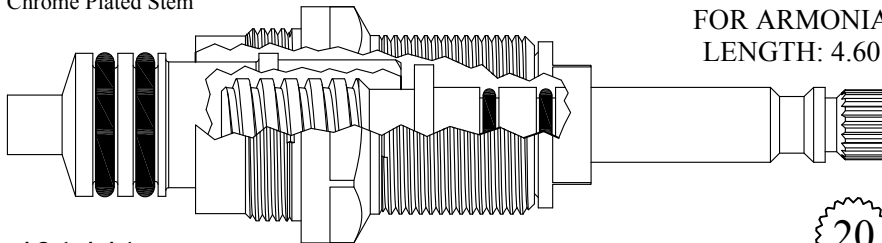

431441

GASKET: 895570 INCLUDED

20
3-14

FOR ELJER
LENGTH 4.65"

Plastic Plunger End

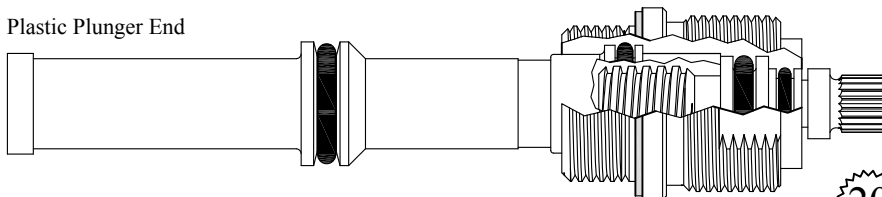

432822

GASKET: 895160 INCLUDED

20
3-20

FOR KALLISTA
LENGTH: 4.84"

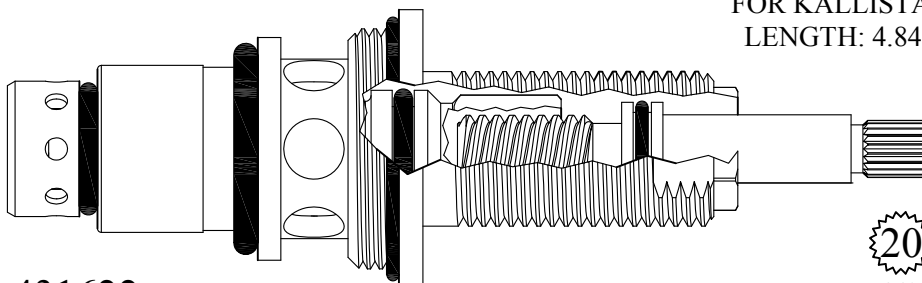

431622

GASKET: 890240 O-RING INCLUDED

20
3-20

NON-RISING UNITS

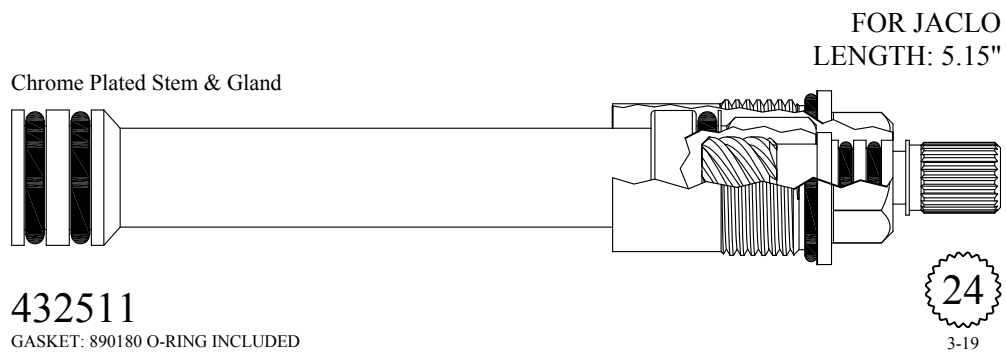
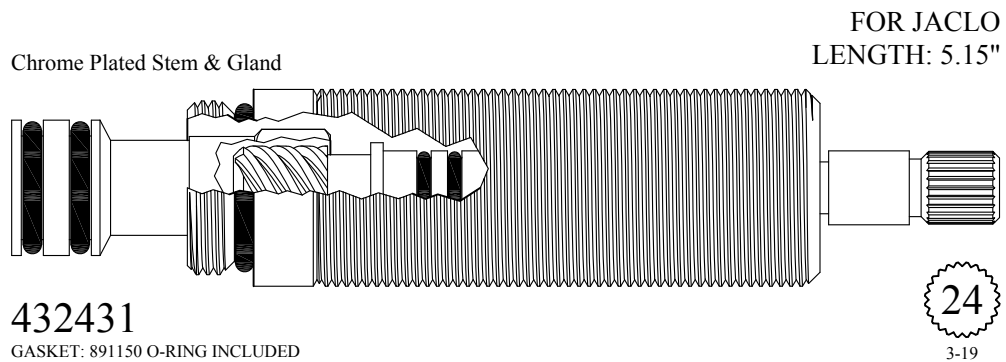
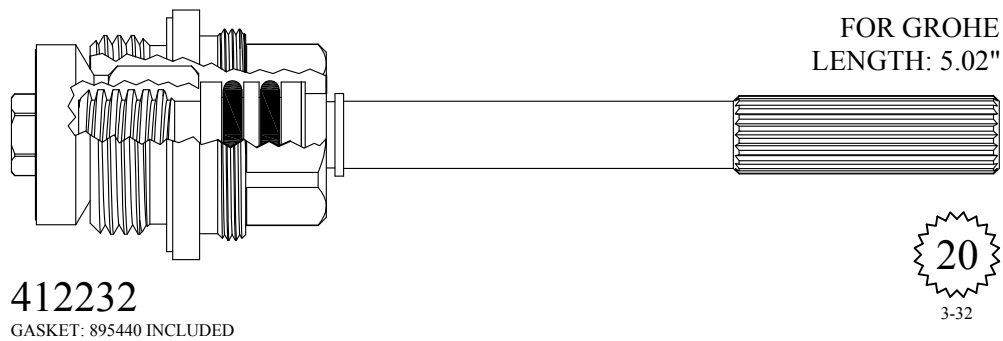
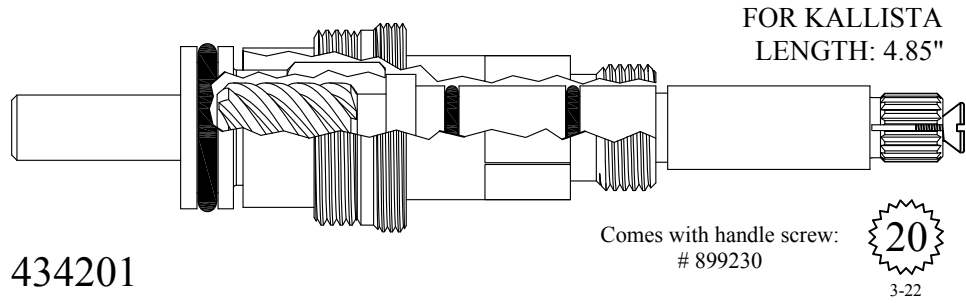

NON-RISING UNITS

Plastic Plunger End

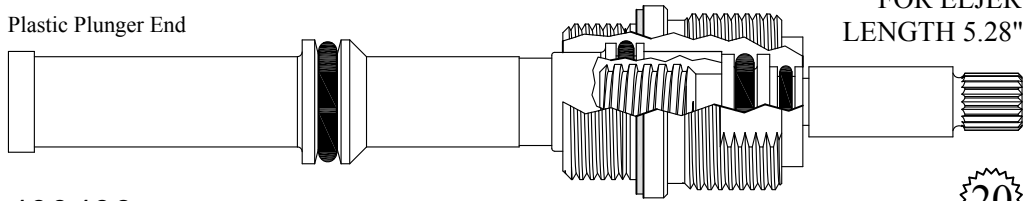

433432

GASKET: 895160 INCLUDED

20
3-20

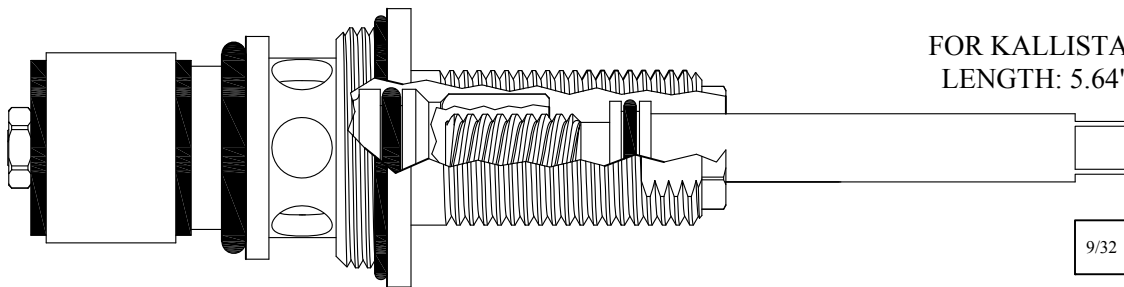

437112

GASKET: 890240 O-RING INCLUDED

FOR KALLISTA
LENGTH: 5.64"

9/32

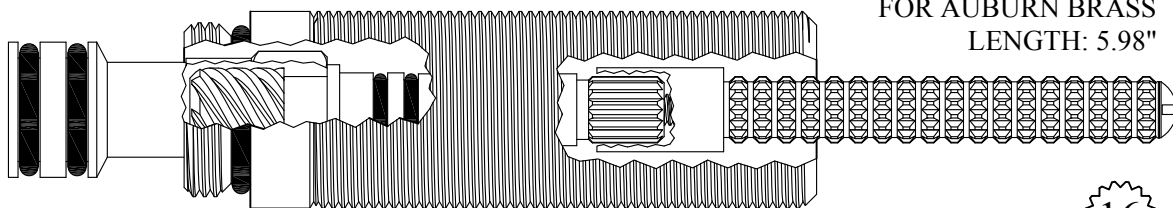

437611

GASKET: 891150 O-RING INCLUDED

FOR AUBURN BRASS
LENGTH: 5.98"

16
2-3

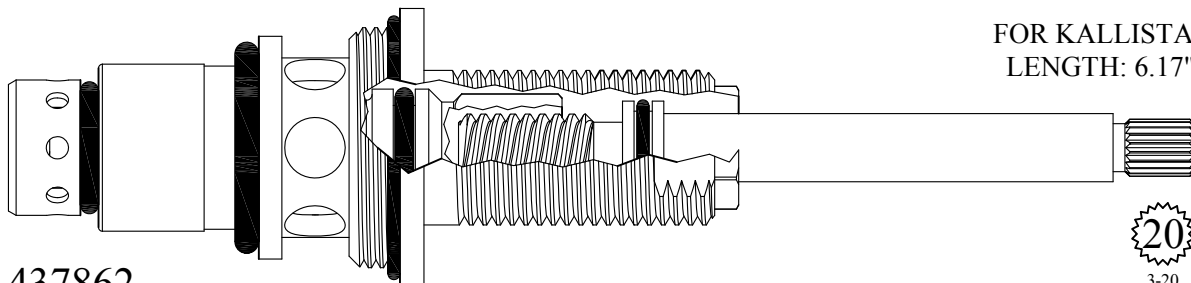

437862

GASKET: 890240 O-RNG INCLUDED

FOR KALLISTA
LENGTH: 6.17"

20
3-20

NON-RISING UNITS

FOR JACLO
LENGTH: 7.15"

24
3-19

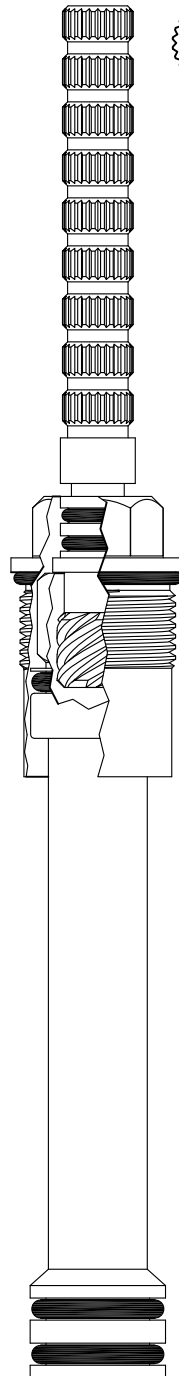

GASKET: 890180 O-RING INCLUDED

439421

Send Your Orders To:

BARRY E.  ALTER SR. CO.

E-mail: orderdesk@barrywalter.com

Fax: 1.800.886.9831

Phone: 1.800.767.5552

BARRY E.  WALTER SR. CO.

STOP STEMS

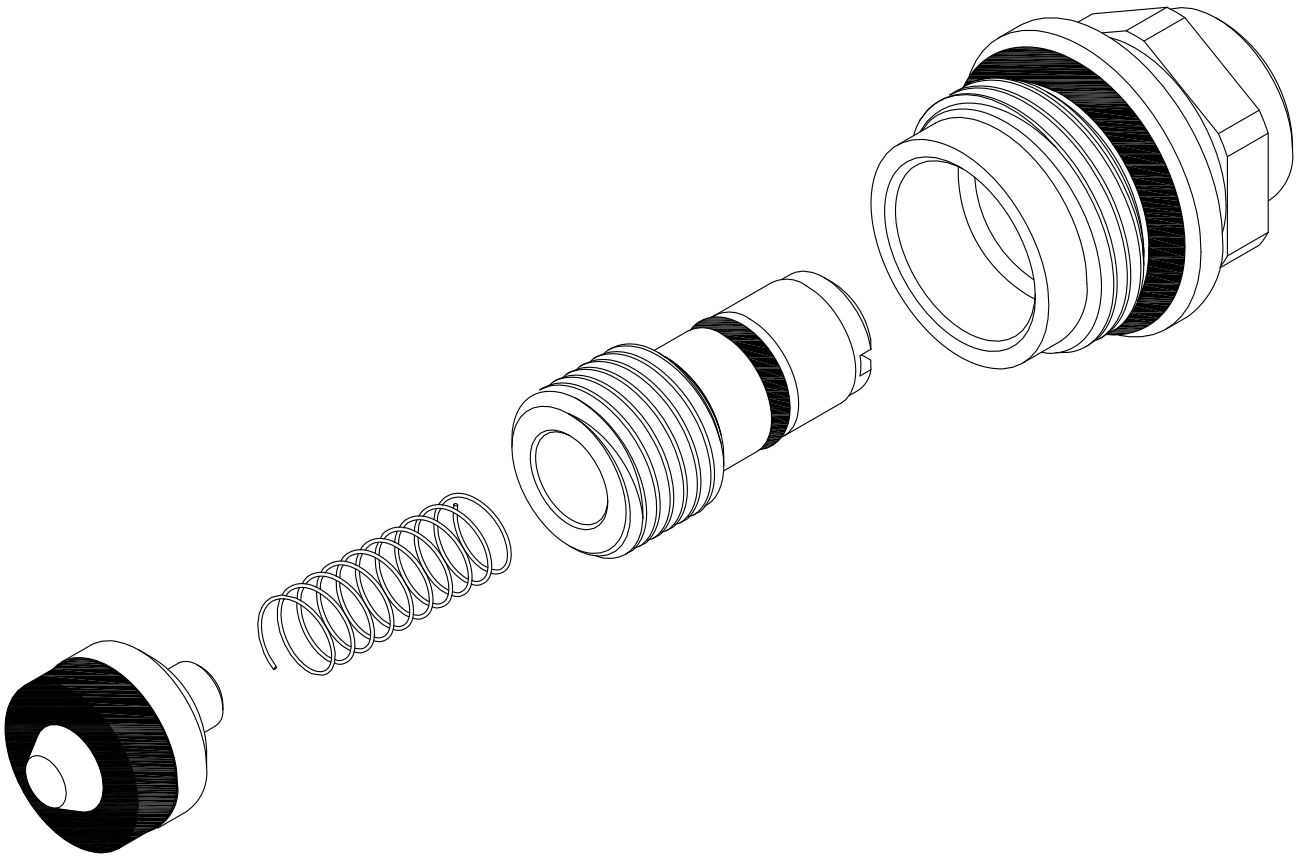

CHECK STOP STEM UNITS

FOR SPEAKMAN

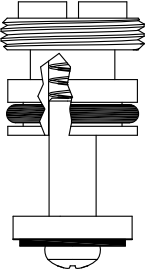

400220

FOR GLACIER BAY

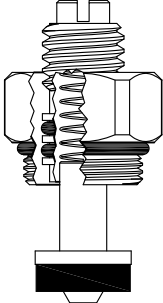

GASKET: 890150 O-RING INCLUDED

400231

FOR ADVANCED TABCO

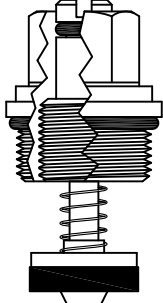

GASKET: 890170 O-RING INCLUDED

400241

FOR SEARS

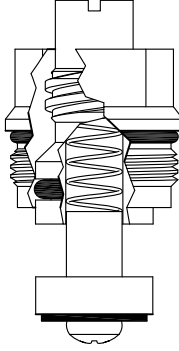

GASKET: 890180 O-RING INCLUDED

400261

FOR MIXET

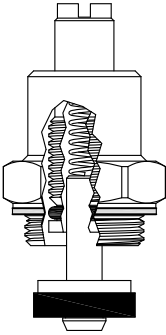

GASKET: 895060 INCLUDED

400371

FOR MOEN

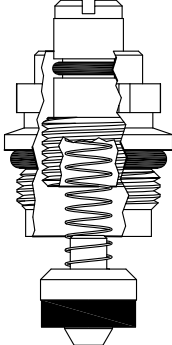

Nickel Plated Stem

GASKET: 891140 O-RING INCLUDED

400421

FOR SAYCO

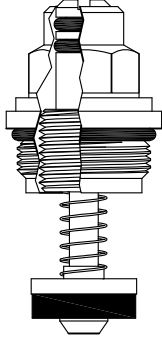

Nickel Plated Stem

GASKET: 890160 O-RING INCLUDED

400121

FOR AM STD

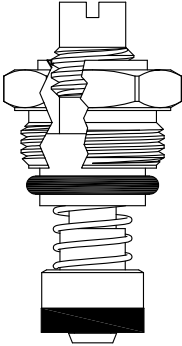

GASKET: 891130 O-RING INCLUDED

400171

FOR DELTA

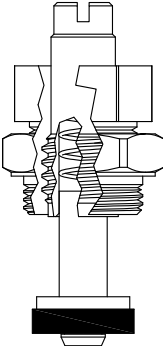

GASKET: 895060 INCLUDED

400151

FOR WILLOUGHBY

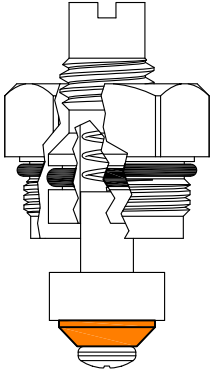

GASKET: 890190 O-RING INCLUDED

LF400451

FOR ACORN

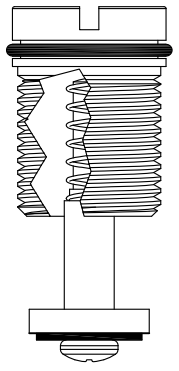

LF400190

CHECK STOP STEM UNITS

FOR POWERS

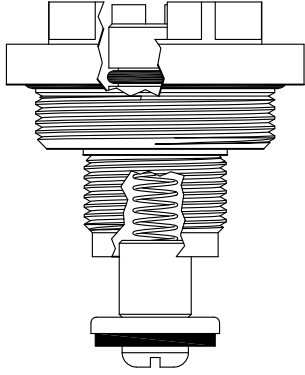

Also available as chrome plated unit
400471-CP
200471-CP Stem Only

GASKET: 891230 O-RING INCLUDED

400471
200471 Stem Only
500470-KIT Retainer & Spring Only

FOR SPEAKMAN

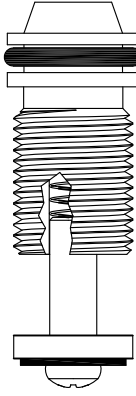

400390

FOR METCRAFT

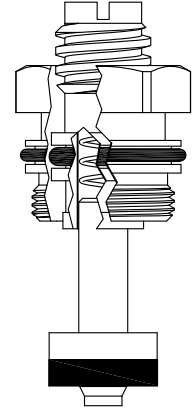

GASKET: 890160 O-RING INCLUDED

LF400441

FOR METCRAFT

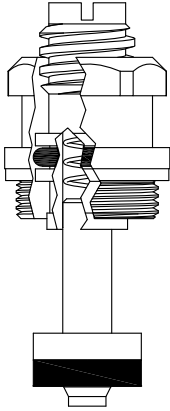

GASKET: 895100 INCLUDED

LF400461

FOR METCRAFT

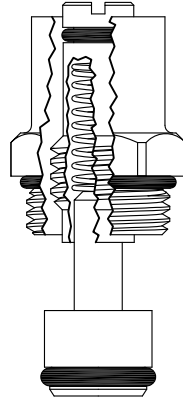

GASKET: 890170 O-RING INCLUDED

LF400751

FOR MIXET

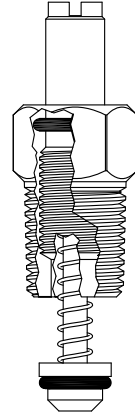

400731

FOR ACORN

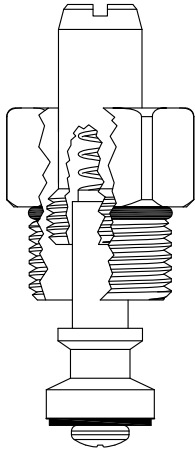

GASKET: 890160 O-RING INCLUDED

LF400571
LF200571 Stem Only

FOR MIXET

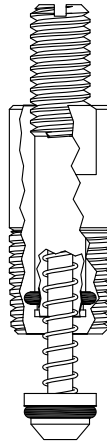

400901

FOR AM STD

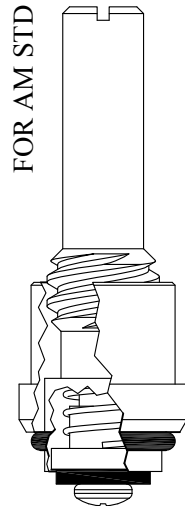

Chrome Plated Stem

GASKET: 8911300-RING INCLUDED

464221
264221 Stem Only

CHECK STOP STEM UNITS

FOR CRANE
LENGTH: 3.71"

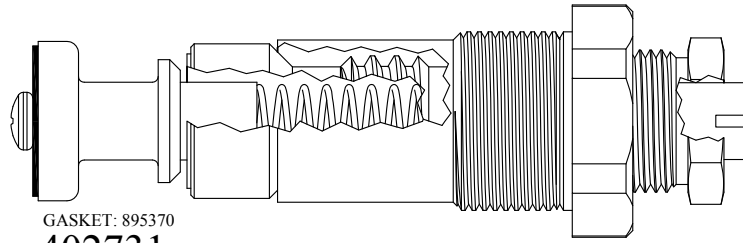

GASKET: 895370
402731
202731 Stem Only

STOP STEMS & UNITS

FOR SPEAKMAN
LENGTH: 1.07"

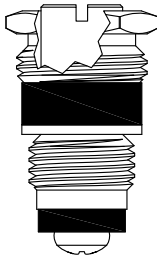

Nickel Plated Stem
Chrome Plated Pkg Nut

LF400111
LF200111 Stem Only

FOR ELJER
LENGTH: 1.05"

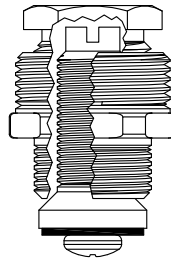

GASKET: 895060

400101

FOR DELTA
LENGTH: 1.15"

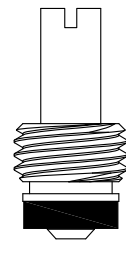

200141

FOR CRANE
LENGTH: 1.15"

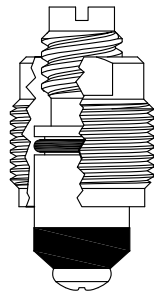

400201
200201 Stem Only

FOR CRANE
LENGTH: 1.15"

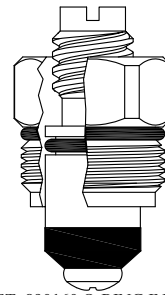

GASKET: 890160 O-RING INCLUDED

400211
200201 Stem Only

FOR GERBER
LENGTH: 1.19"

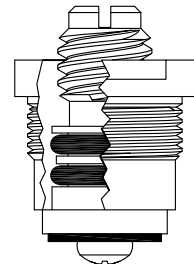

GASKET: 895150

400381

FOR STERLING FAUCET
LENGTH: 1.24"

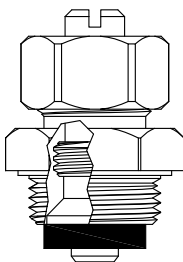

GASKET: 895110

400181

FOR ELJER
LENGTH: 1.25"



GASKET: 890160 O-RING INCLUDED

400131

FOR PRICE PFISTER
STEM LENGTH: 1.26"

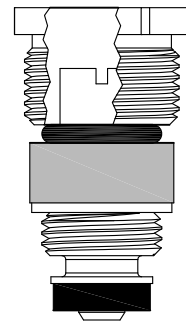

400301
200301 Stem Only

STOP STEMS & UNITS

FOR SAVOY
LENGTH: 1.31"

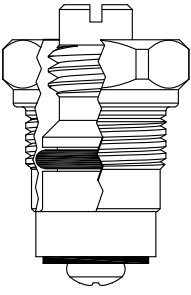

GASKET: 895100

400291

FOR SAYCO
LENGTH: 1.37"

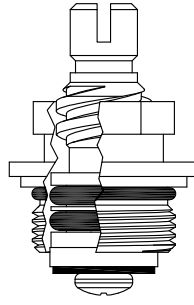

Nickel Plated Gland

GASKET: 890160 O-RING INCLUDED

400271

FOR SAYCO
LENGTH: 1.37"

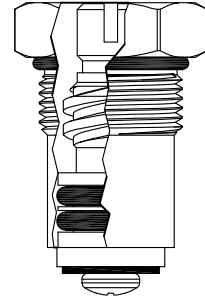

GASKET: 890170 O-RING INCLUDED

400281

FOR ELJER
LENGTH: 1.38"

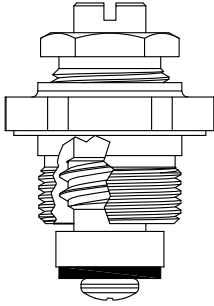

GASKET: 895100

400331
200331

FOR ELJER
LENGTH: 1.44"

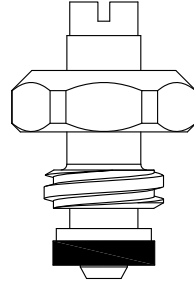

400251

FOR ELJER
LENGTH: 1.56"

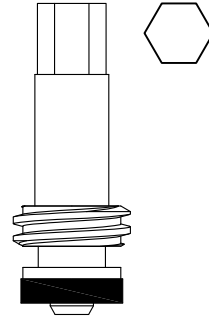

200351

FOR CRANE
LENGTH: 1.57"

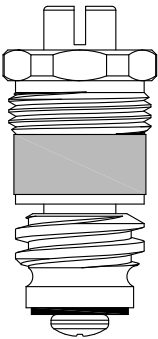

452821
252821 Stem Only

FOR MIXET
LENGTH: 1.60"

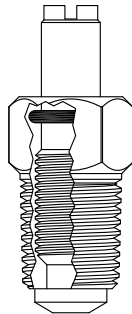

400721

FOR SPEAKMAN
LENGTH: 1.64"

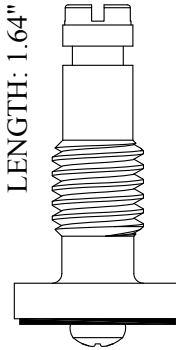

Chrome Plated Stem

252911

STOP STEMS & UNITS

UNKNOWN
LENGTH: 1.66"

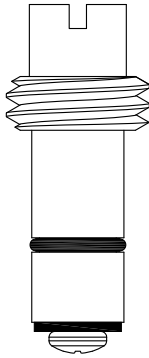

200611

FOR AM STD
LENGTH: 1.69"

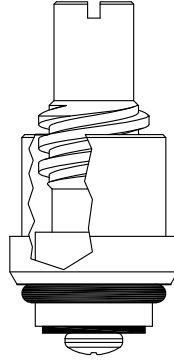

GASKET: 891130 O-RING INCLUDED

453181

253181 Stem Only

FOR AM STD
LENGTH: 1.71"

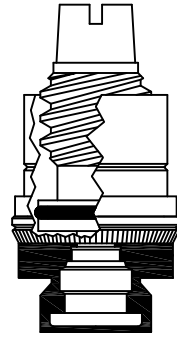

453191

FOR ACORN
LENGTH: 1.73"

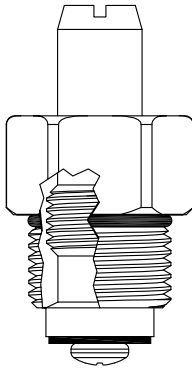

GASKET: 890160 O-RING INCLUDED

LF454071

LF254071 Stem Only

FOR SYMMONS
LENGTH: 1.75"



400661

200661 Stem Only

FOR PRICE PFISTER
LENGTH: 1.77"

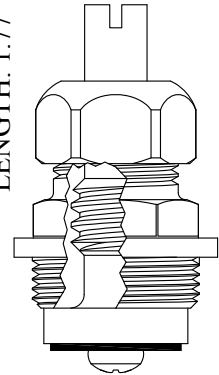

GASKET: 895400

400741

200741 Stem Only

FOR MOEN
UNIT LENGTH: 1.77"

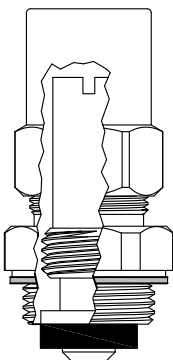

11/16-20 TPI Gland

GASKET: 895110 INCLUDED

400311

FOR MOEN
UNIT LENGTH: 1.77"

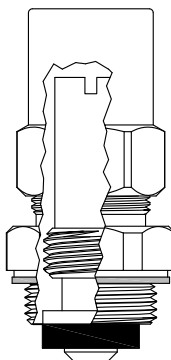

11/16-27 TPI Gland

GASKET: 895110 INCLUDED

400321

FOR MOEN
UNIT LENGTH: 1.77"

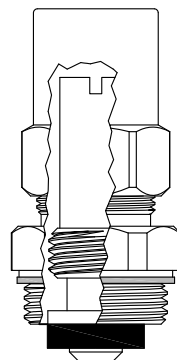

3/4-20 TPI Gland

GASKET: 895110 INCLUDED

400341

STOP STEMS & UNITS

FOR KOHLER
LENGTH: 1.80"

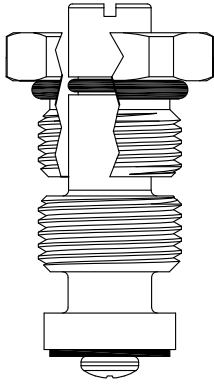

GASKET: 891140 O-RING INCLUDED

400921
200921 Stem Only

FOR SEARS
LENGTH: 1.83"

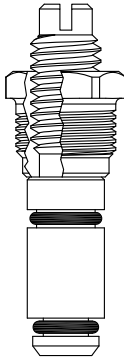

400361

FOR DICK BROS.
LENGTH: 1.84"

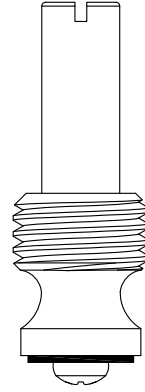

LF257001

FOR COYNE DELANEY
LENGTH: 1.93"

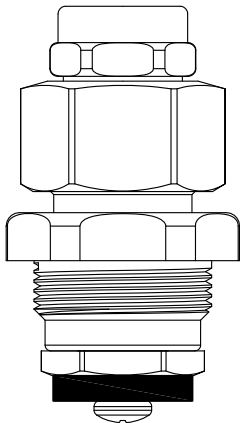

Chrome Plated Unit

GASKET INCLUDED: 895370

460302

FOR AM STD
LENGTH: 1.95"

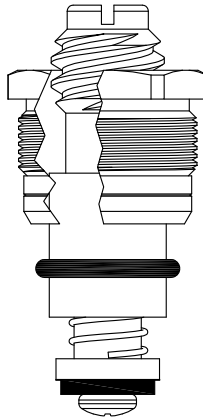

GASKET: 891130 O-RING INCLUDED

400591
200591 Stem Only

FOR AM STD
LENGTH: 1.96"



257351

FOR KOHLER
LENGTH: 1.98"

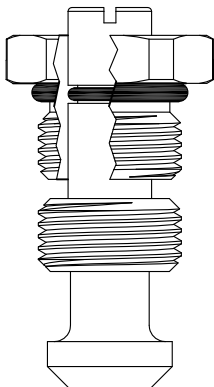

GASKET: 891140 O-RING INCLUDED

400911
200911 Stem Only

FOR BRIGGS
LENGTH: 2.08"

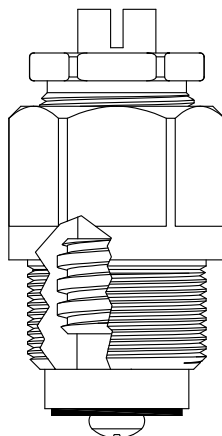

GASKET: 895370

401461
201461 Stem Only

FOR MUELLER
LENGTH: 2.15"

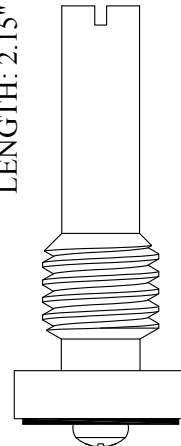

Chrome Plated Stem

201141

STOP STEMS & UNITS

FOR SPEAKMAN
LENGTH: 2.15"

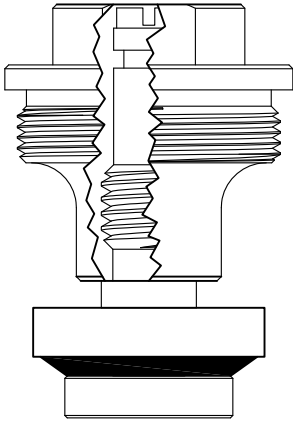

460401

LENGTH: 2.20"

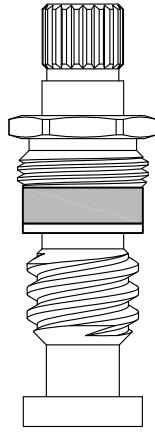

STEM UNIT
FOR SENTINEL VALVE

401131

20
2-4

Chrome Plated Stem

UNKNOWN
LENGTH: 2.24"

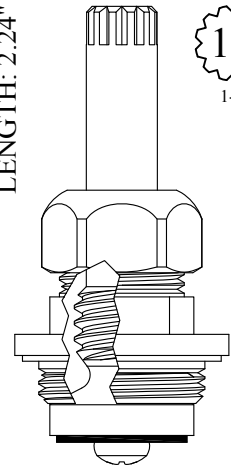

GASKET: 895400

191041

12
1-2

FOR ACORN
LENGTH: 2.25"

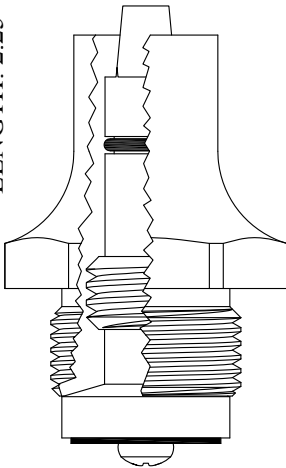

GASKET: 895570

483121

Chrome Plated Bonnet

FOR AM STD
LENGTH: 2.28"

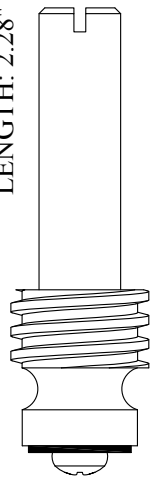

Nickel Plated Stem

261131

FOR AM STD
LENGTH: 2.28"

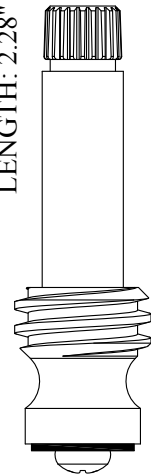

263281

22
1-4

FOR TANNER
LENGTH: 2.29"

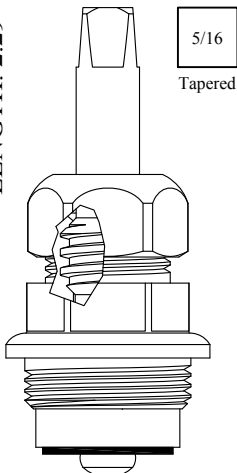

GASKET: 895400

462561

5/16
Tapered

FOR ACORN
LENGTH: 2.27"

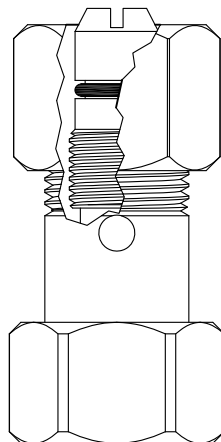

GASKET: 895100 INCLUDED

LF138921
LF136401 Stem Only

FOR BRADLEY
LENGTH: 2.46"

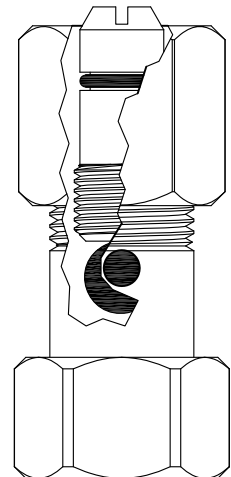

GASKET: 895100 INCLUDED

LF126480

STOP STEMS & UNITS

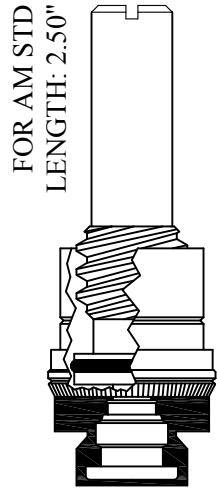

FOR AM STD
LENGTH: 2.50"

401551

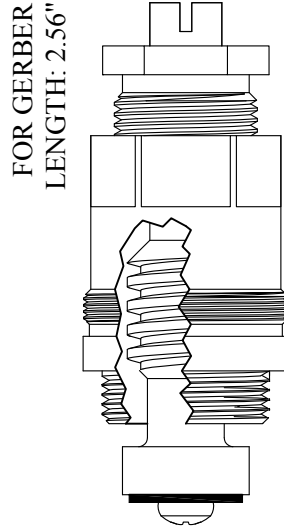

FOR GERBER
LENGTH: 2.56"

GASKET: 895400

401241
201241 Stem Only

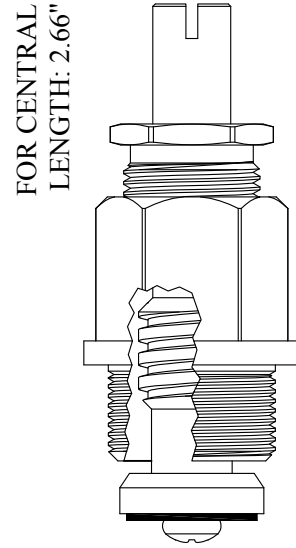

FOR CENTRAL
LENGTH: 2.66"

GASKET: 895400

401611
201611 Stem Only

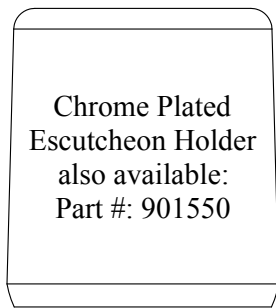

Chrome Plated
Escutcheon Holder
also available:
Part #: 901550

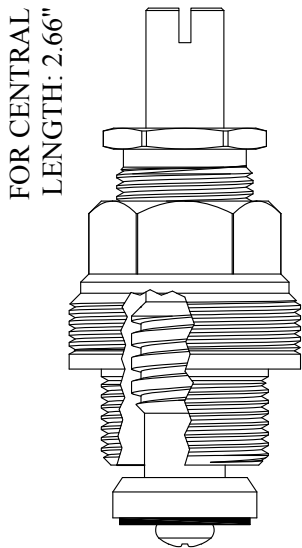

FOR CENTRAL
LENGTH: 2.66"

GASKET: 895400

401621
201611 Stem Only

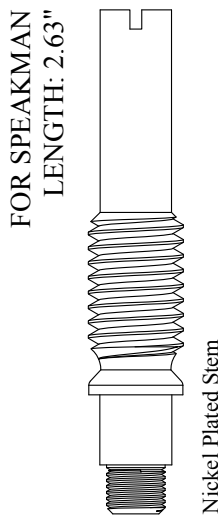

FOR SPEAKMAN
LENGTH: 2.63"

Nickel Plated Stem

264331

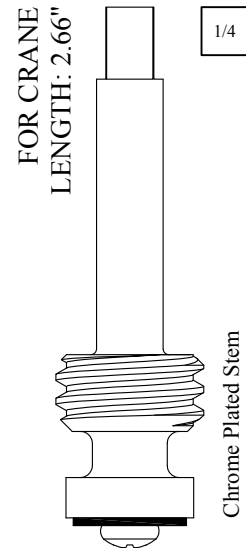

FOR CRANE
LENGTH: 2.66"

1/4

Chrome Plated Stem

LF264461

STOP STEMS & UNITS

Also available less gland
LF117621

FOR ACORN
 LENGTH: 2.72"

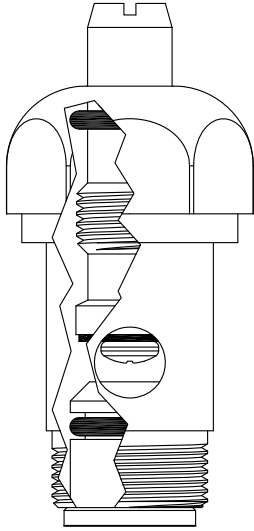

GASKET: 895400 INCLUDED
 SEAT INCLUDED: LF601780

LF401781
LF254071 Stem Only

FOR AM STD
 LENGTH: 2.78"

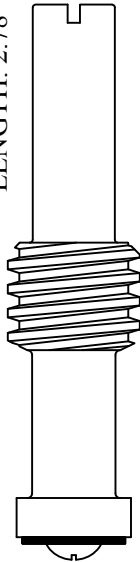

Chrome Plated Stem

201711

FOR AM STD
 LENGTH: 2.88"

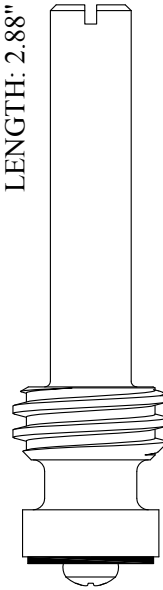

Chrome Plated Stem

265611

LENGTH: 3.02"

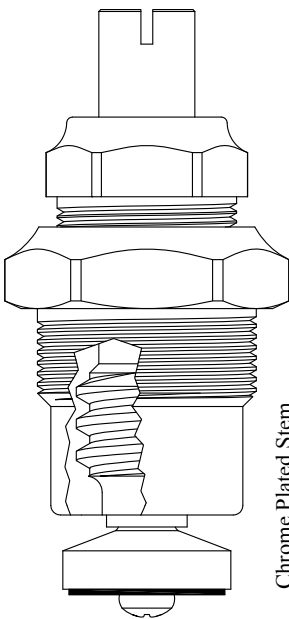

Chrome Plated Stem

GASKET: 895450

402071
202071 Stem Only

FOR SPEAKMAN
 LENGTH: 3.06"

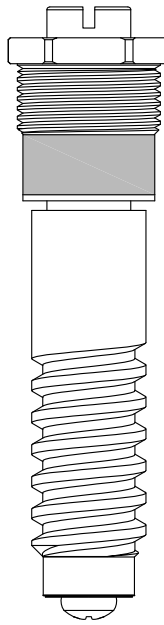

Chrome Plated Stem

401901
201901 Stem Only

FOR PRICE PFISTER
 LENGTH: 3.22"

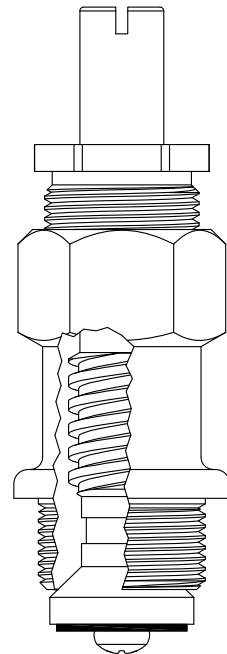

GASKET: 895400

402621
202621 Stem Only

STOP STEMS & UNITS

FOR PRICE PFISTER
LENGTH: 3.22"

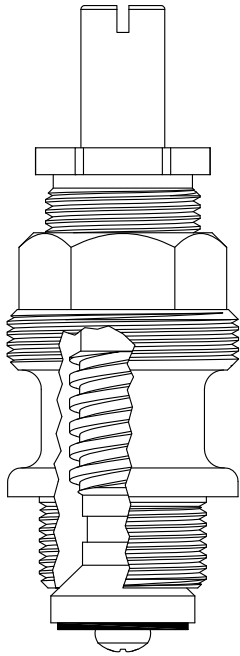

GASKET: 895400

402671

202621 Stem Only

FOR ILLINOIS
LENGTH: 3.24"

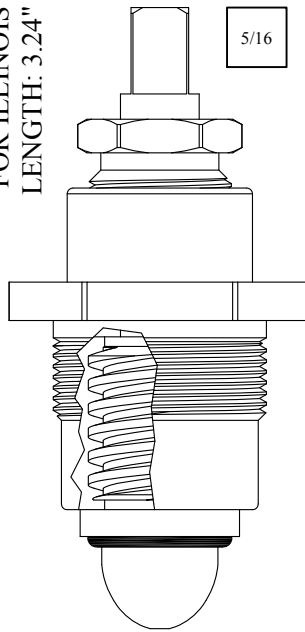

483421

FOR BRIGGS
LENGTH: 3.25"

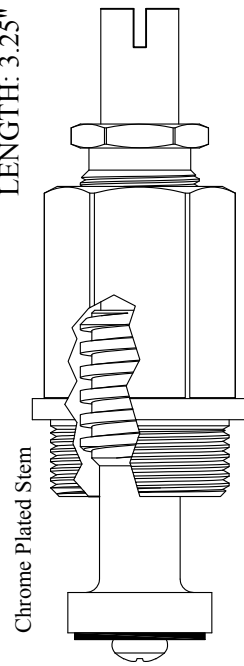

GASKET: 895370

402611

202611 Stem Only

FOR SAVOY
LENGTH: 3.47"

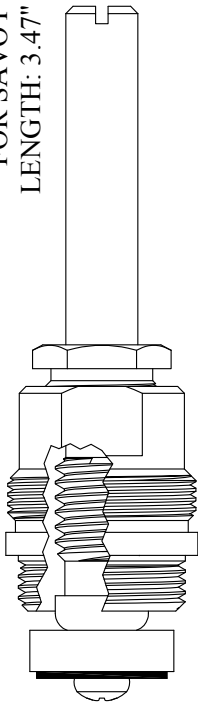

GASKET: 895400

402831

FOR KOHLER
LENGTH: 3.50"

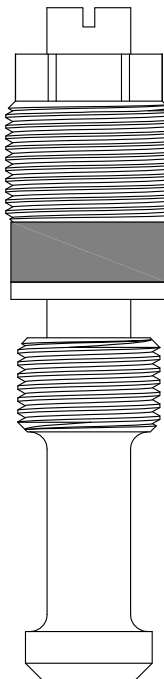

402991

202991 Stem Only

FOR CRANE
LENGTH: 3.66"

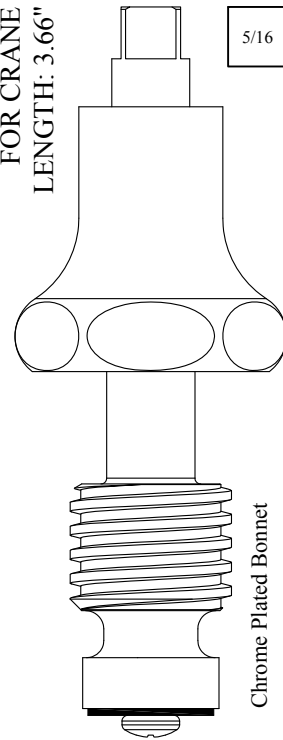

403121

203121 Stem Only

STOP STEMS & UNITS

FOR GLAUBER WEST COAST
STEM LENGTH: 3.65"

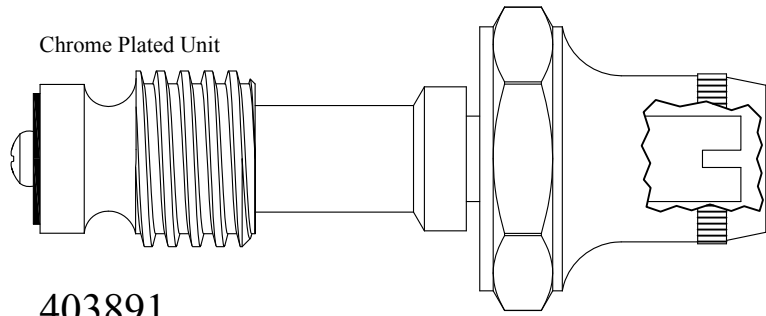

403891
203891 Stem Only

FOR BRIGGS
LENGTH: 4.17"

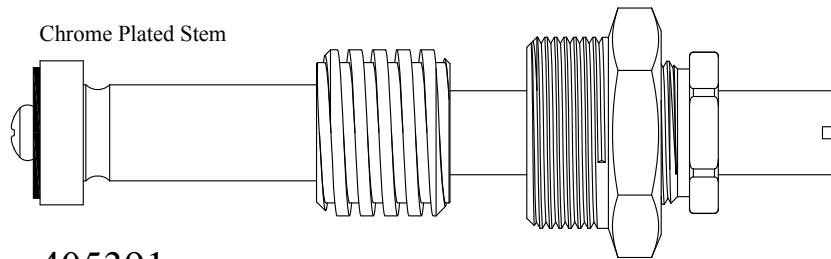

405391
205391 Stem Only
GASKET: 895340

FOR SAVOY
LENGTH: 4.14"

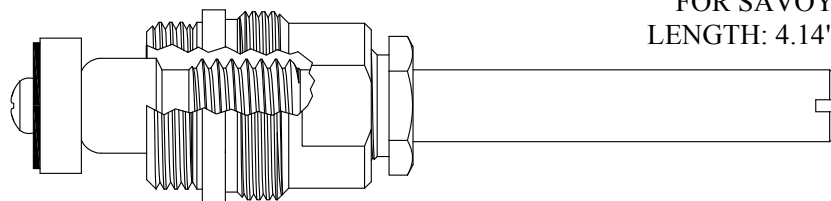

405521
GASKET: 895400

FOR DICK BROS.
LENGTH: 4.81"

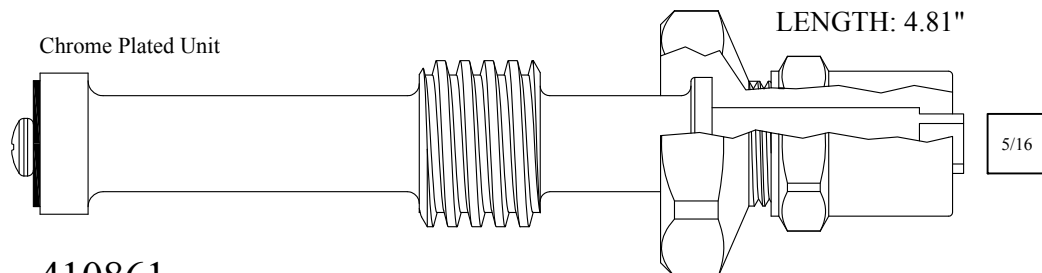

410861
210861 Stem Only
GASKET: 895400 INCLUDED

5/16

STOP STEMS & UNITS

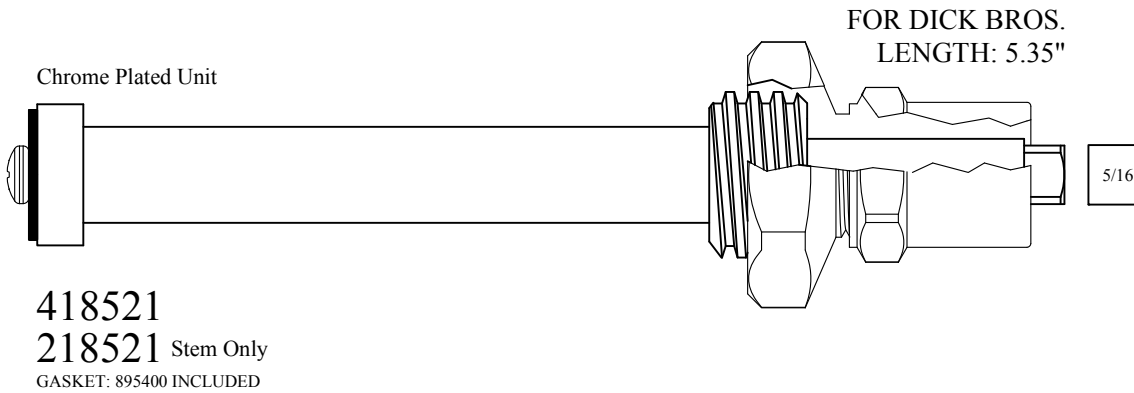
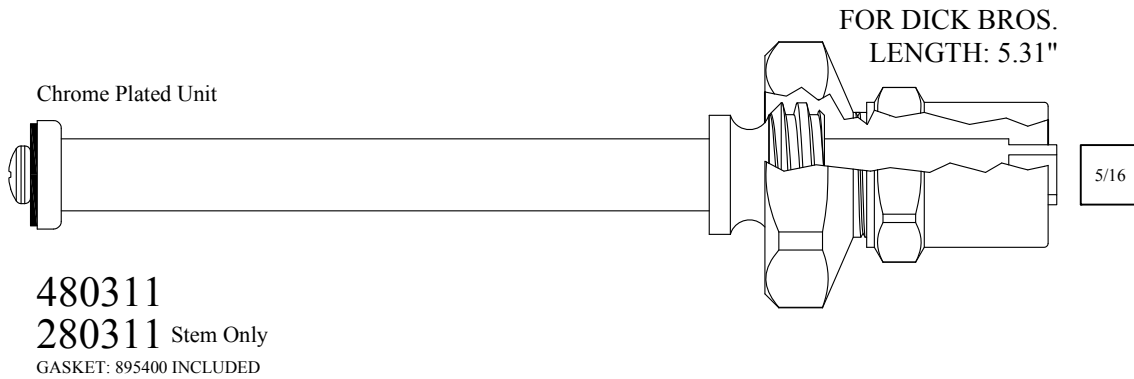
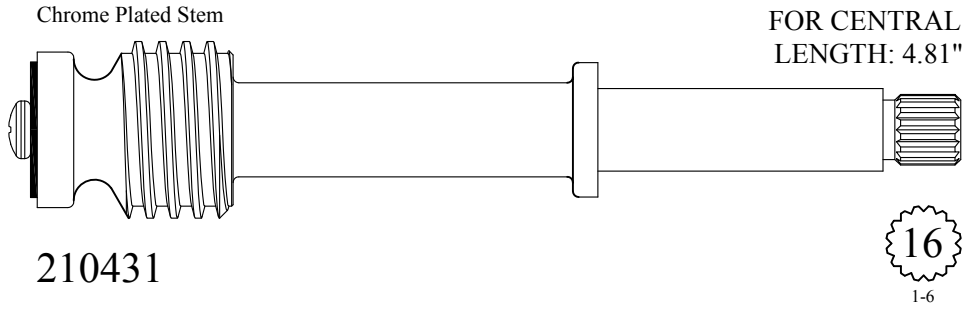

BARRY E.  SR. CO.

BARRY E.  WALTER SR. CO.

SEATS,
SEAT KITS &
BARRELS

Send Your Orders To:

BARRY E.  SR. CO.











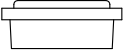
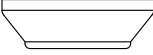

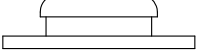

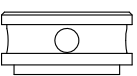
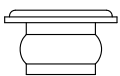

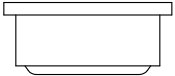
E-mail: orderdesk@barrywalter.com

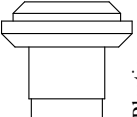
Fax: 1.800.886.9831

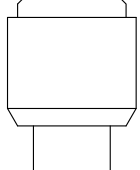
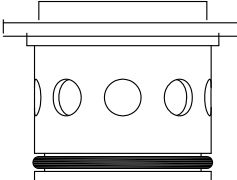
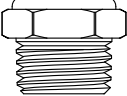
Phone: 1.800.767.5552

SEATS

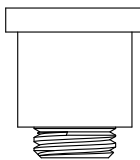
PRESS-IN

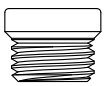
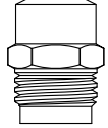
15/64  647140 CONCINNITY* Plastic	1/4  LF648200 REPCAL*	1/4  648750 CHICAGO* - OLD Stainless	7/32  649560 CHICAGO* - NEW Monel	9/32  649510 SPHINX*
21/64  LF649460 KOHLER* Chrome Plated	21/64  LF958070 PRICE PFISTER*	11/32  LF649020 UNION BRASS\G GOPHER*	3/8  LF648310 PRICE PFISTER*	3/8  649520 SPHINX*
13/32  649110 SPEAKMAN* Plastic	39/64  652360 SAYCO* Plastic	3/4  LF601780 ACORN*	29/32  609910 SAYCO* Plastic	15/16  647660 SYMMONS J-18*
<u>1/4 PIPE</u>	<u>3/8-27</u>		<u>27/64-28</u>	<u>7/16-18</u>
1/2  LF648390 AM. STD.*	9/32  LF649130 CHICAGO SPECIALTY*	29/32  649970 SCOVILLE* Plastic	1/2  647830 INDIANA*	25/32  LF647090 ELJER*
<u>7/16-20</u>				
	3/8  LF649050 BORG-WARNER*	5/16  LF647690 ELJER*	21/32  647600 ELJER*	

SEATS

7/16-24

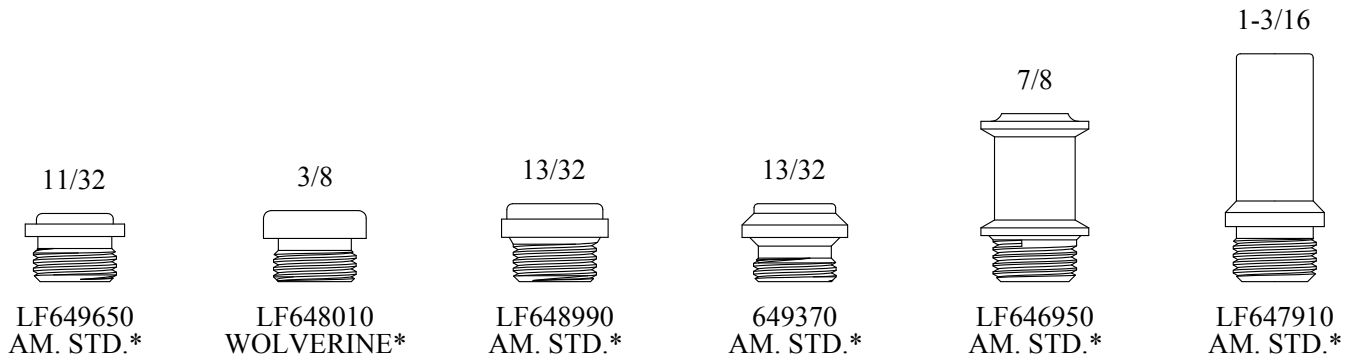

7/16-27

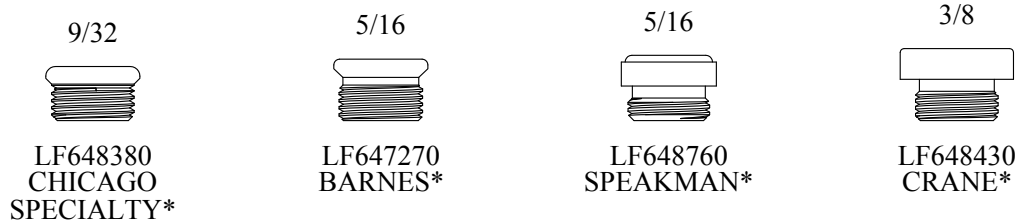

12mm x 1.00



15/32-27



1/2-12

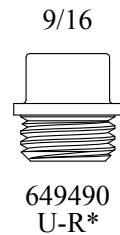

1/2-18

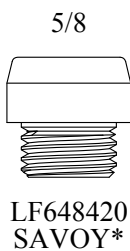

1/2-20

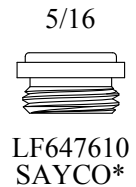

SEATS

1/2-20

19/64



LF648210
MICHIGAN*

11/32

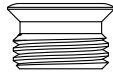

LF648020
BARNES/ELJER*

11/32

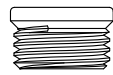

LF648410
AM. BRASS*

11/32

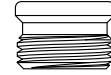

LF648400
STREAMWAY*

3/8



LF647000
AM. KITCHEN*

3/8



LF648270 NICKEL
LF648270-B UNPLATED
PRICE PFISTER*

3/8



LF648100
AM. STD.*

3/8

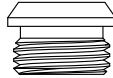

LF648320
ELJER*

3/8



LF647450
SAYCO*

3/8

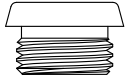

LF648260
ROYAL BRASS*

25/64



LF646970
PRICE PFISTER*

13/32



LF649740
SAVOY*

27/64



LF649810
GERBER*

7/16

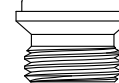

LF648350
AM. STD.*

7/16



LF649270
GRAND HAVEN*

5/8

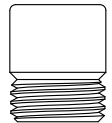

LF648030
STREAMWAY*

5/8

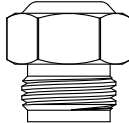

649590
AM. STD.*

5/8

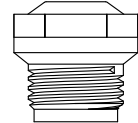

73002-07
AM. STD.*

Plastic

5/8

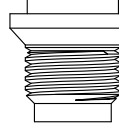

LF649290
MANSFIELD*

3/4

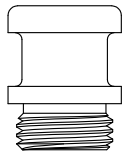

LF648250
BRIGGS*

3/4

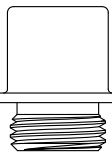

LF648440
ROYAL/HAWS*

3/4

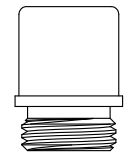

LF649310
SAYCO*

13/16

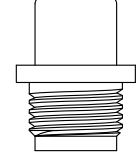

LF649580
AMERLINE*

27/32

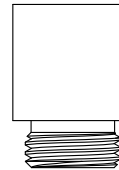

649350
AUBURN*

7/8

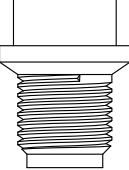

LF649340
MANSFIELD*

15/16

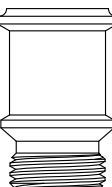

646960
AM. STD.*

1-1/32

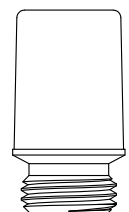

LF649330
SCHAIBLE*

1-1/8

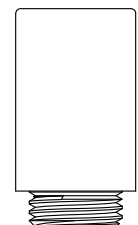

LF649380
FISHER*

1-7/32

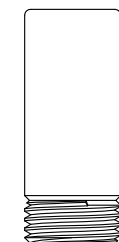

LF648040
STREAMWAY*

1-1/4

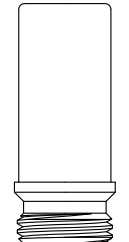

LF648140

SEATS

1/2-20

1-17/32

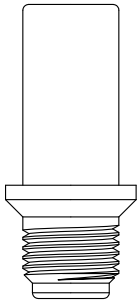

LF648460
AM. BRASS*

1-19/32



LF647670
PHOENIX*

1-19/32



LF647680
STREAMWAY*

1-21/32



LF648050
STREAMWAY*

1.71"

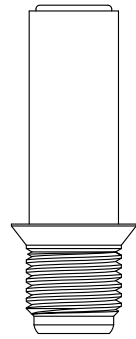

LF647470
AM. BRASS*

1-3/4

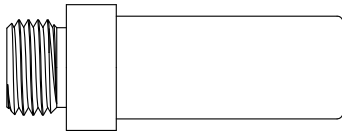

LF649160
INDIANA*

1-7/8

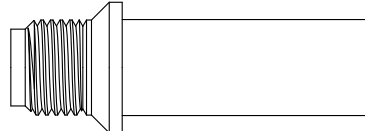

LF649950
AM. BRASS*

2-11/32



LF649170
STREAMWAY*

2-1/2



LF649180
AUBURN*

2-3/32



LF649120
AUBURN*

1/2-24

17/64



LF649600
WEST BRASS*

11/32



LF649190
STREAMWAY*

23/64

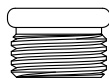

LF648280
STREAMWAY*

3/8



LF648170
STERLING*

3/8

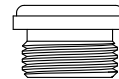

LF649200
WOLVERINE*

3/8



LF649610
ROYAL BRASS*

27/64



LF648550
CENTRAL*

7/16



LF648120
BRIGGS/REPCAL*

5/8



LF648060
STREAMWAY*

3/4

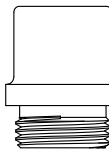

LF648470
CENTRAL*

15/16

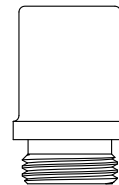

LF647300
CENTRAL*

15/16

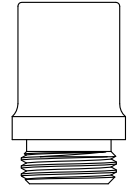

LF649230
ROYAL BRASS*

1-7/32



LF648240
STREAMWAY*

1-1/4

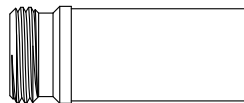

LF649240
AM. BRASS*

1-5/8



LF647170
STREAMWAY*

SEATS

1/2-24

1-5/8

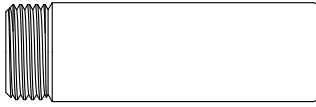

LF648080
STREAMWAY*

2-13/32

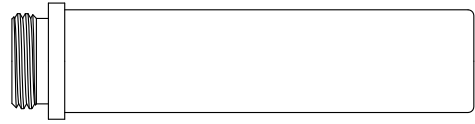

LF649980
UNKNOWN

1/2-27

9/32



LF648500
CHICAGO
SPECIALTY*

5/16



LF649760
DICK BROS.*

5/16

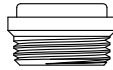

LF648070
KOHLER*

11/32

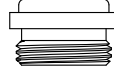

LF647700
T & S*

11/32

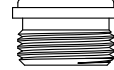

LF649450
DISHMASTER*

3/8

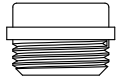

LF647560
ACORN*

3/8

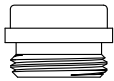

LF649390
KOHLER*

3/8

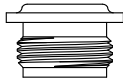

647240
CASE*

7/16

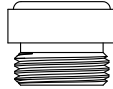

LF648860
UNKNOWN

1/2

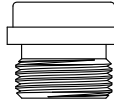

LF648160
ELJER*

1/2



LF649280
KOHLER*

5/8

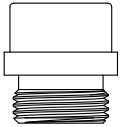

LF648610
ELJER*

1-9/32

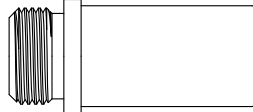

LF648620
ELJER*

1-19/32



LF648520
ELJER*

1/2-28

5/16



LF647180
BURLINGTON*

13/32

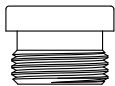

LF648560
INDIANA*

33/64-18

ALL UNION BRASS*

5/16



LF648480

5/8

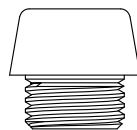

LF647460

1-5/32



LF648090

1-29/32

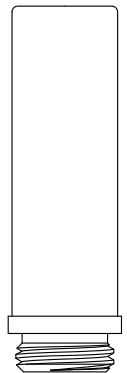

LF648110

SEATS

33/64-27

ALL MILWAUKEE*

23/32

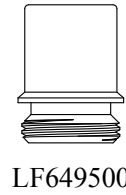
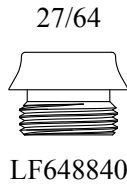

17/32-18

35/64-20

35/64-24

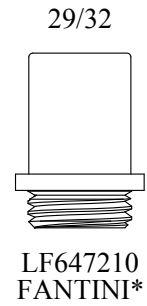
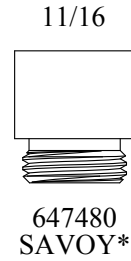
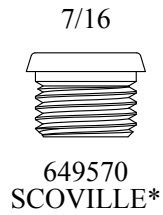

17/32-24

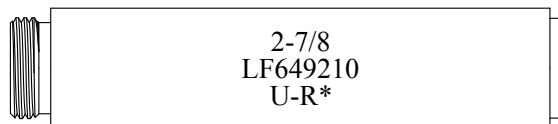
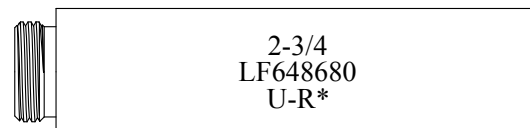
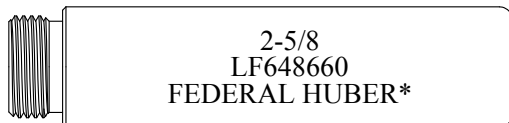
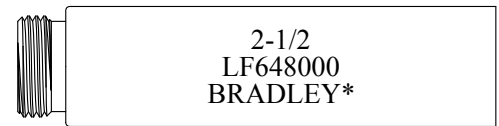
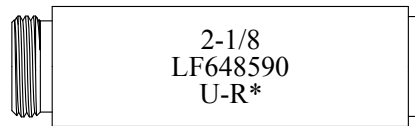
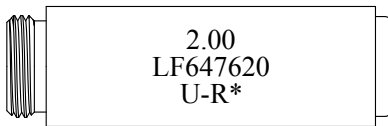
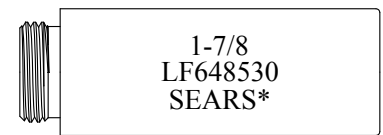
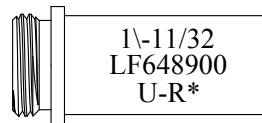
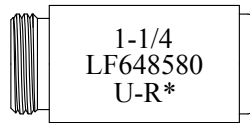
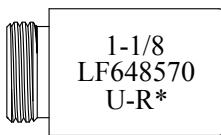
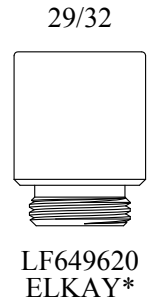
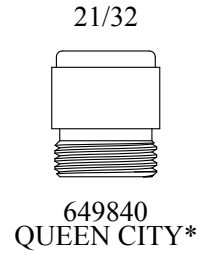
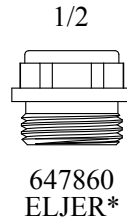

SEATS

14mm x 1.0

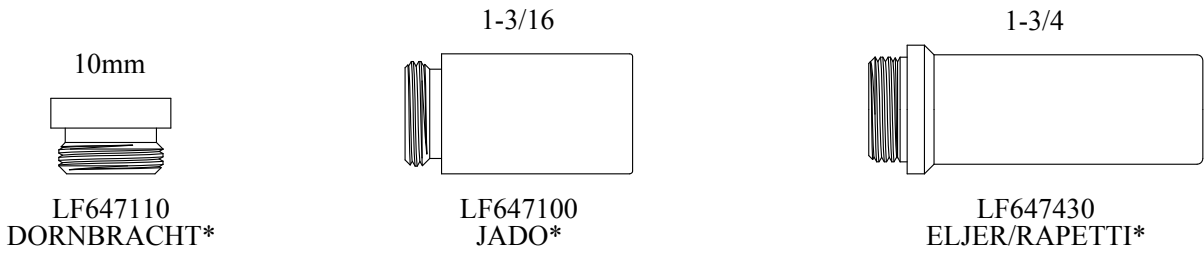

9/16-18

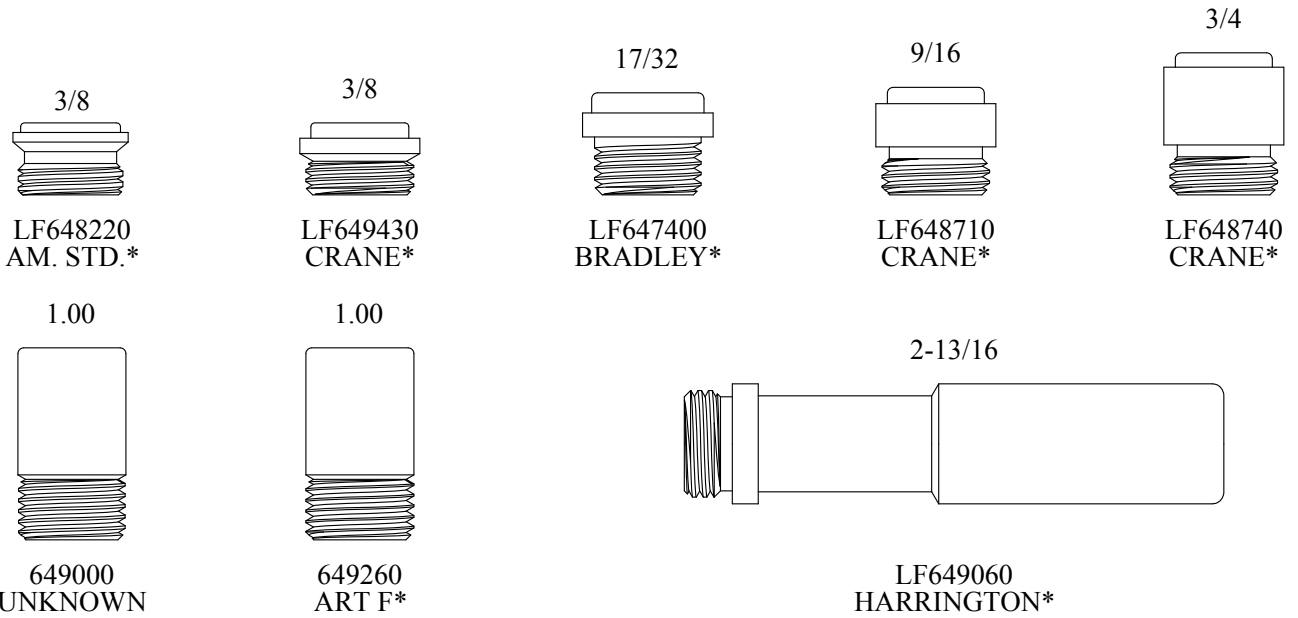

9/16-20

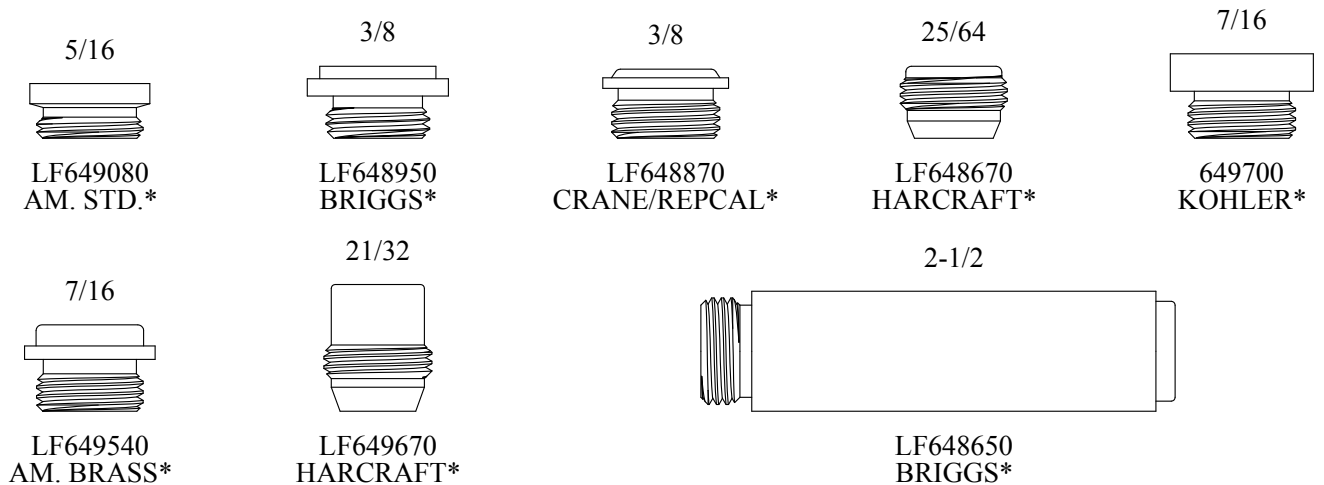

9/16-22

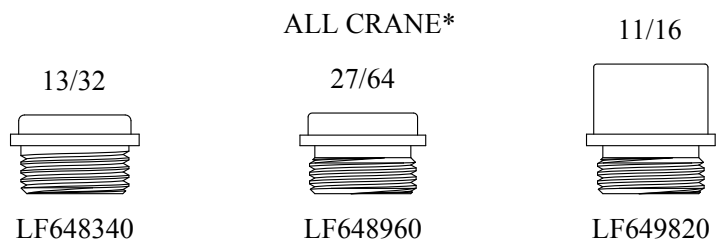

*Original Mfg's names are used for identification only and are not a representation that the items offered are genuine items of the original Mfg.

SEATS

9/16-24

9/32



LF649470
U-R*

3/8



LF646940
CAMBRIDGE*

3/8



LF648330
BARNES*

3/8



LF649030
McDONALD/CRANE*

7/16

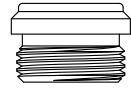

LF649790
BRIGGS*

15/16

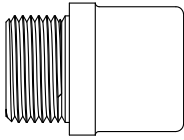

649100
HAJOCA*

1-33/64

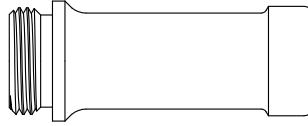

LF647420
CAMBRIDGE*

2-39/64



LF647290
MILWAUKEE*

29/64

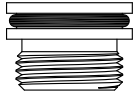

LF663350
PERLICK*

2-5/8



647440
FEDERAL HUBER*

2-29/32

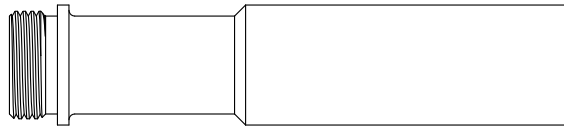

LF647810
CONCINNITY*

3-11/64

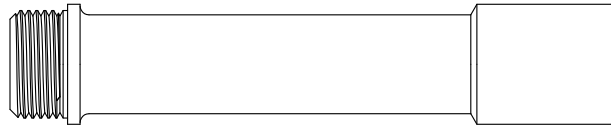

LF646980
PHYLIRICH*

9/16-27

9/32

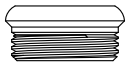

LF648780
CHICAGO
SPECIALTY*

11/32

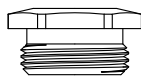

646990
BRADLEY*
Stainless

3/8



LF648930
SPEAKMAN*

13/32

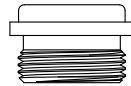

LF648790
CENTRAL*

13/32

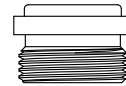

LF648980
DICK BROS.*

5/8

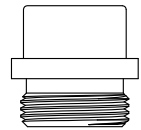

LF649300
INDIANA*

1-1/4

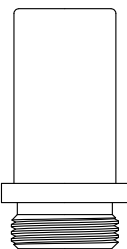

LF649400
INDIANA*

1-1/2

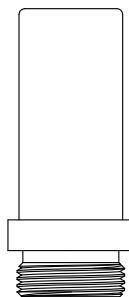

LF648820
INDIANA*

1-5/8

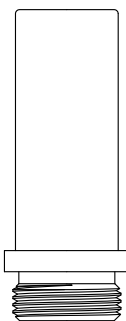

LF649410
INDIANA*

1-23/32

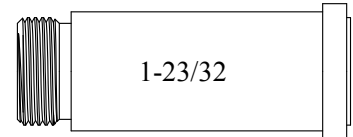

LF649250
SPEAKMAN*

2-9/32

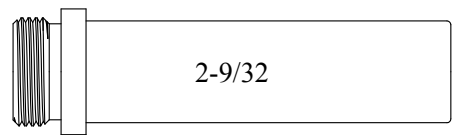

LF647880
INDIANA*

SEATS

9/16-27

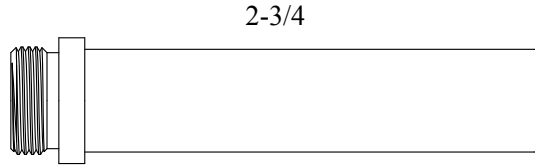

LF647870
INDIANA*

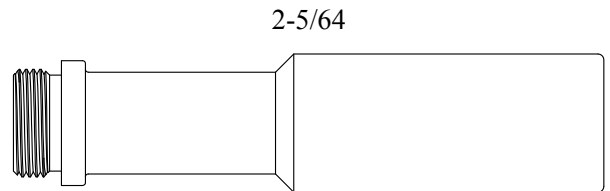

LF647150
HARRINGTON*

9/16-28

15mm x 1.25

19/32-20

11/32

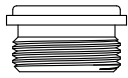

LF649770
CRANE/REPCAL*

17/32

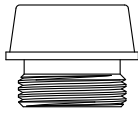

LF648880
CRANE*

8mm

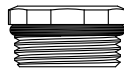

647080
METCRAFT*
Stainless

10mm

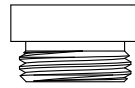

LF646930
KUGLER*

31/64

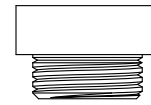

649090
AM. STD.*

1-9/64

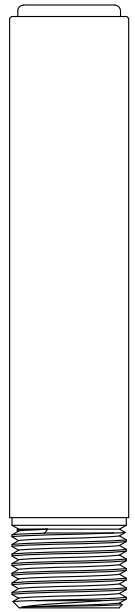

646910
MUELLER*

5/8-16

19/32-24

3/8

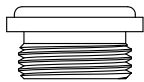

649680
WOLVERINE*

19/32-27

7/16

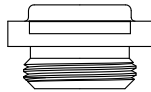

649730
KOHLER*

29/32

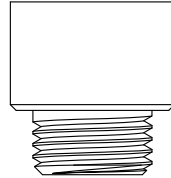

LF647770
CRANE*

1-31/32

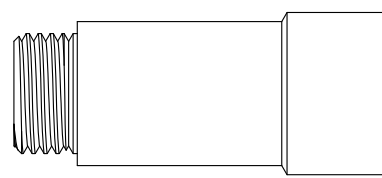

LF647800
CRANE*

5/8-18

5/16

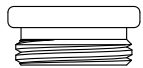

LF649910
UNION BRASS*

21/64

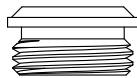

LF649720
UNION BRASS*

3/8

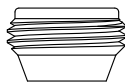

LF648830
HARCRAFT*

7/16

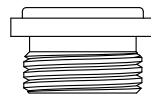

LF649010
CHASE*

15/32

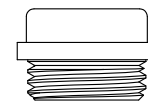

LF649930
UNION BRASS*

11/16

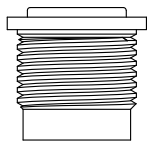

LF646880
UNKNOWN

3/4

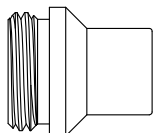

LF649940
UNION BRASS*

7/8

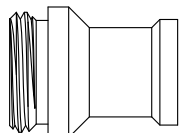

LF649890
UNION BRASS*

1-5/32

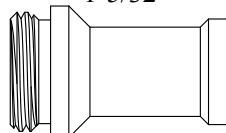

LF649900
UNION BRASS*

1-29/32

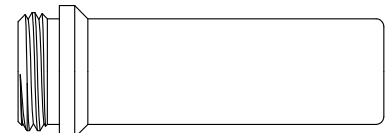

LF649780
UNION BRASS*

*Original Mfg's names are used for identification only and are not a representation that the items offered are genuine items of the original Mfg.

SEATS

5/8-20



648640
SAYCO*

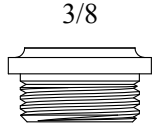

649830
SYMMONS*

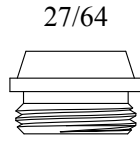

LF649150
GERBER*

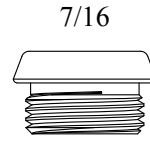

647410
ARROWHEAD*

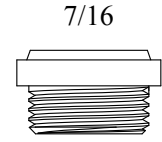

647650
SYMMONS*



LF648450
TRACY*

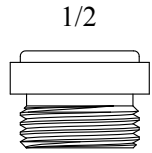

649850
ROYAL BRASS*



649800
GLAUBER*

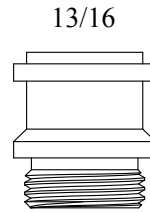

648630
BRIGGS/
REPUBLIC*

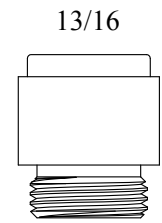

LF649480
FISHER*

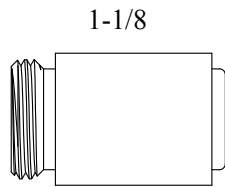

LF649140
GERBER*

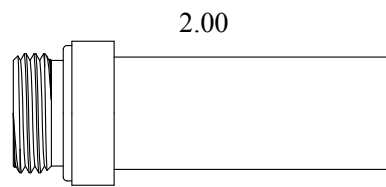

647720
ROSS & GADE*

5/8-24



648190
SPEAKMAN*

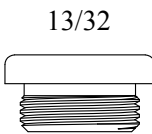

648180
SPEAKMAN*

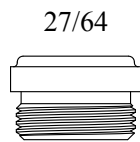

648970
CENTRAL*

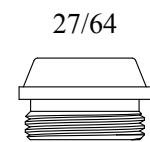

649860
GERBER*

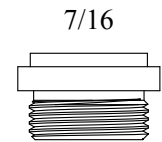

648510
BRIGGS*

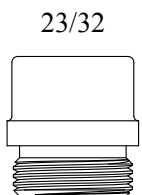

648810
CENTRAL*

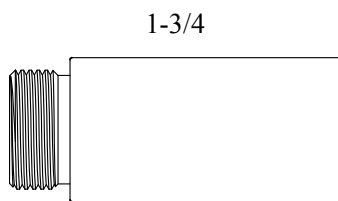

647490
BROADWAY*

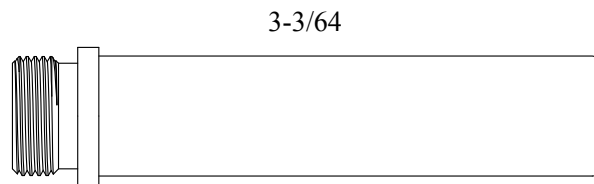

647260
STERLING*

SEATS

5/8-27

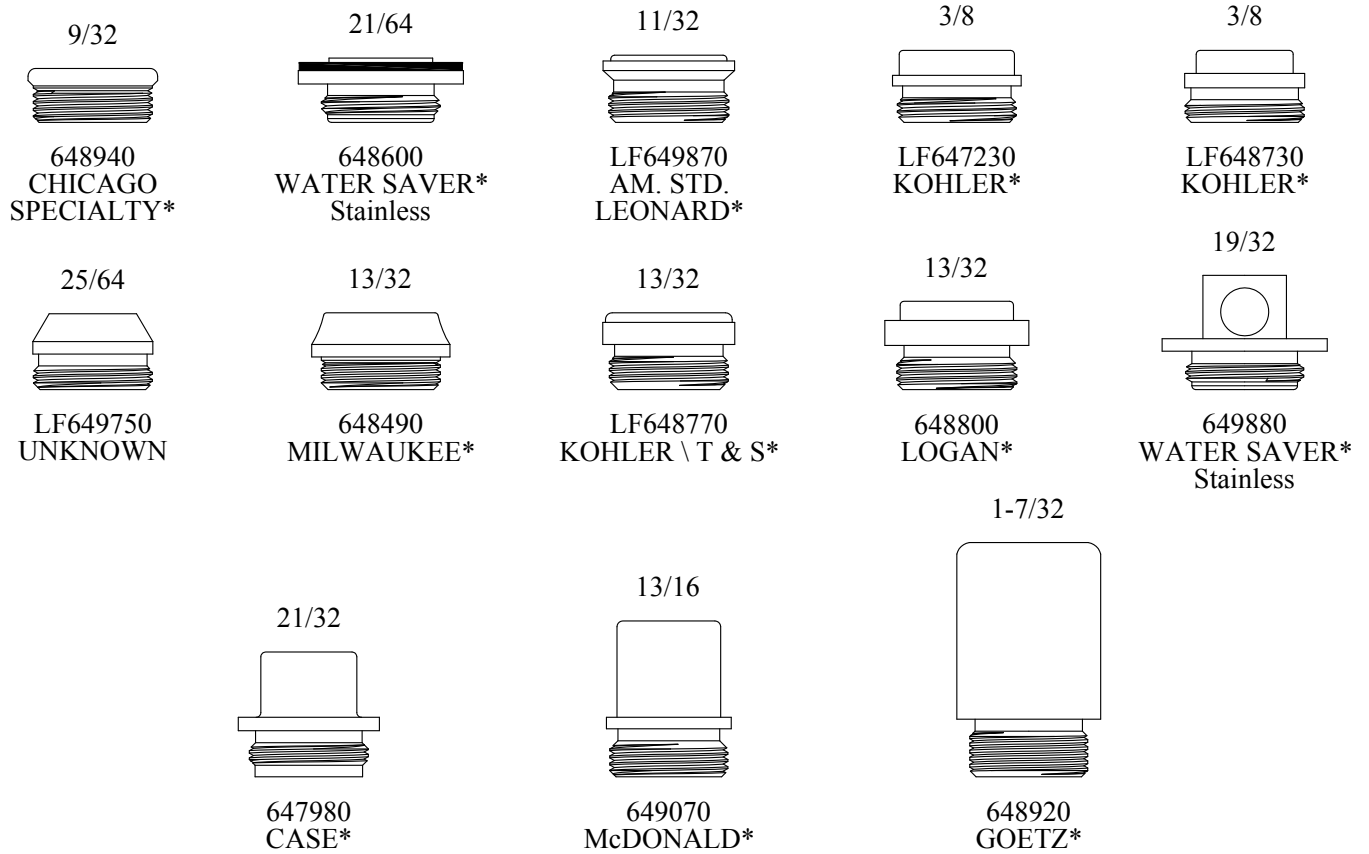

16mm x 1.0

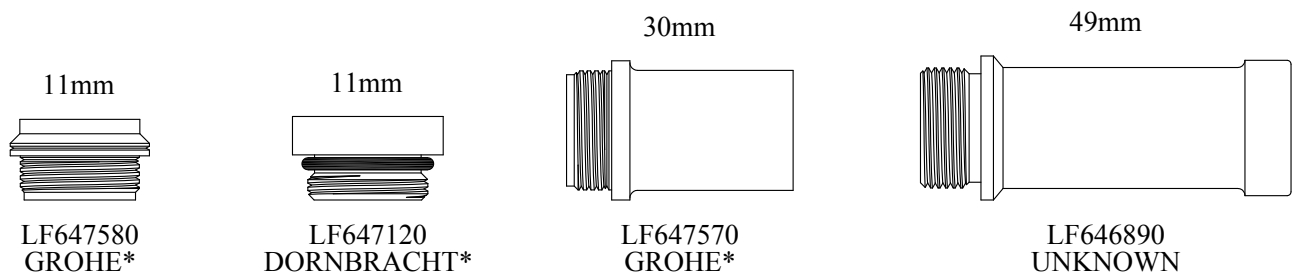

21/32-18 PRICE PFISTER*

11/16-16

11/16-18

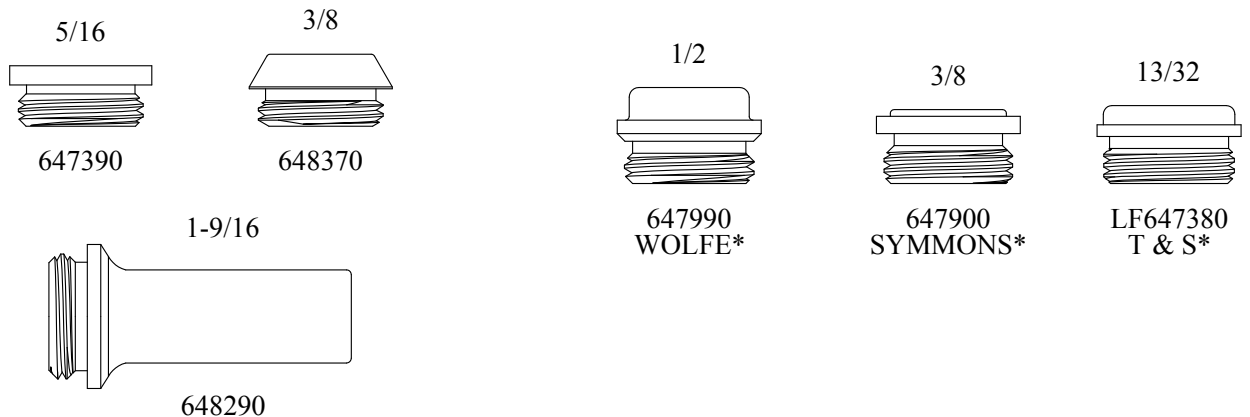

*Original Mfg's names are used for identification only and are not a representation that the items offered are genuine items of the original Mfg.

SEATS

11/16-20

13/32

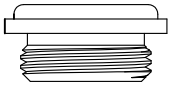

649690
WOLVERINE*

7/16

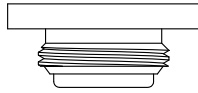

LF647280
SEARS*

11/16-22

7/16



LF649660
CRANE*

7/16



LF649920
CRANE*

1/2

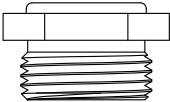

LF649710
AM. STD.*

7/8

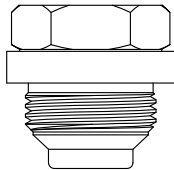

649360
AM. STD.*

31/64

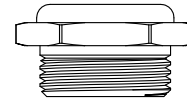

647890
CRANE*

11/16-27

11/16-24

3/8



649960
CRANE*

25/64



LF647850
CENTRAL*

13/32

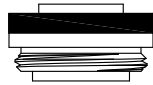

LF648850
SAVOY*

13/32

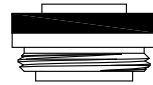

648850-M
SAVOY*
Monel

15/32

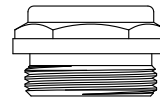

647220
KOHLER*

1-1/8

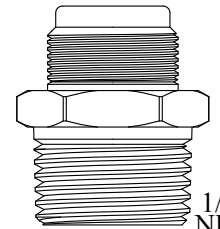

LF647500
KOHLER*

1/2
NPS

3/4-16

3/8



648890
BRADLEY*

9/16

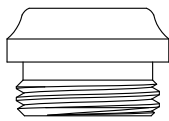

646920
ZURN*

13/16

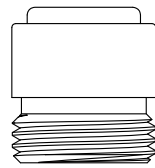

647920
BRADLEY*

1-1/16

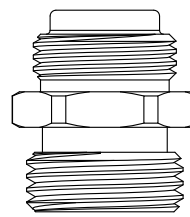

647540
SAVOY*

1/2
NPS

1-1/4

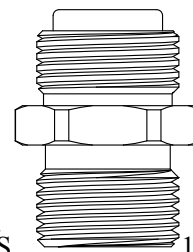

647510
SAVOY*

3/4
16 TPI

1-1/4

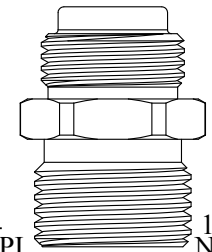

647520
SAVOY*

1/2
NPS

3/4-18

27/64



647950
UNKNOWN

1-1/4

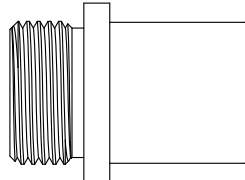

649420
MORGAN*

SEATS

3/4-20

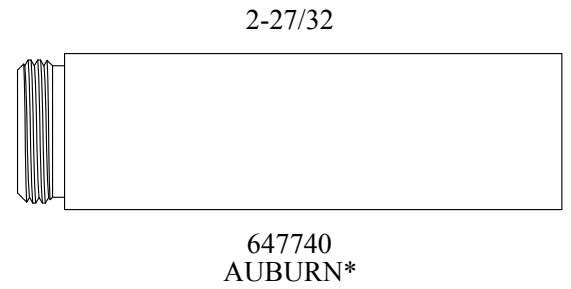
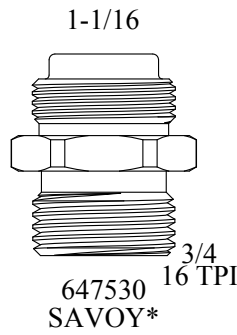

3/4-27

20mm x 1.0

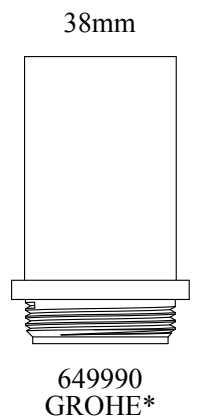
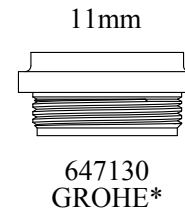
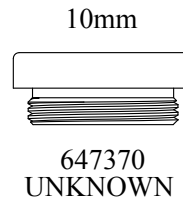
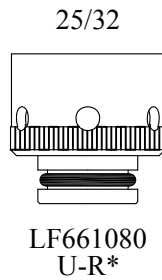
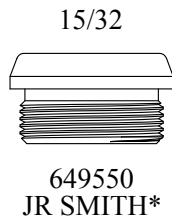

13/16-14

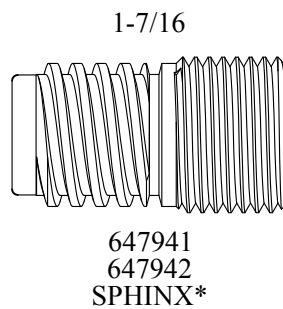

13/16-16

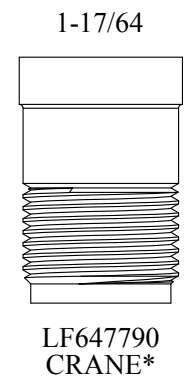
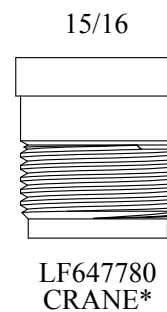
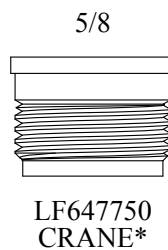
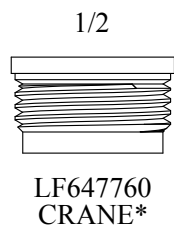
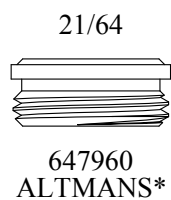

*Original Mfg's names are used for identification only and are not a representation that the items offered are genuine items of the original Mfg.

SEATS

13/16-16

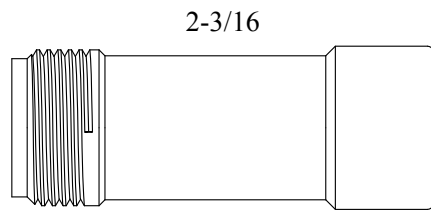

LF647820
CRANE*

13/16-24

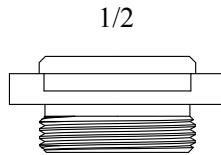

647190
KOHLER*

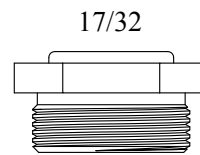

648910
AM. STD.*

13/16-26

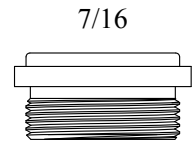

646870
UNKNOWN

53/64-24

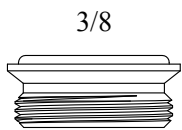

647840
LEONARD*

27/32-18

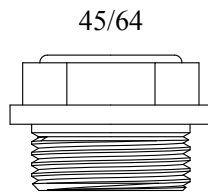

649630
UNKNOWN

7/8-18

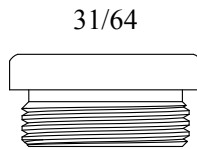

647160

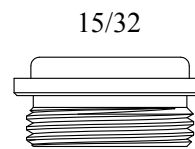

649320
MUELLER*

7/8-20

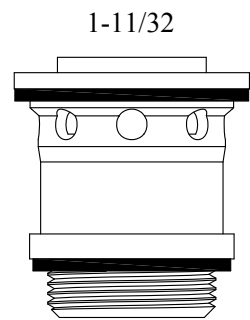

647970
SYMMONS TS-2*

7/8-22

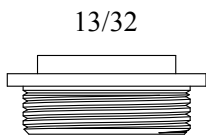

647730
CRANE*

29/32-18

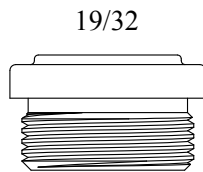

649440
LENHART*

15/16-20

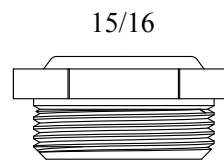

649530
AM. STD.*

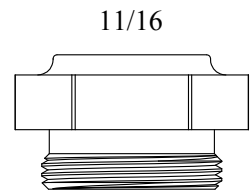

647710
SPEAKMAN*

1-5/32-20



OLD STYLE
15/16

647630-OS
SYMMONS*

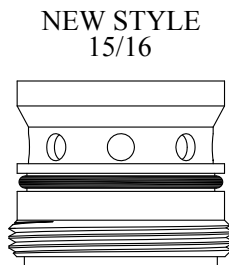

NEW STYLE
15/16

647630
SYMMONS T-3*

1-3/16-16

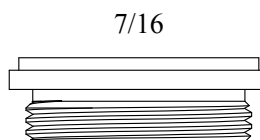

647550
UNKNOWN

1-5/16-20

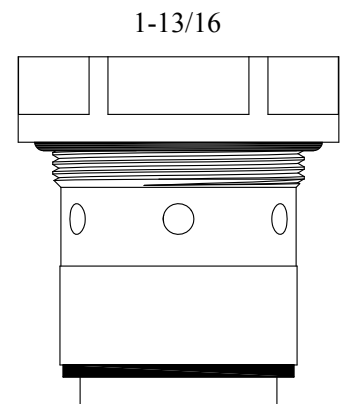

647640
SYMMONS C-3*

SEAT KITS

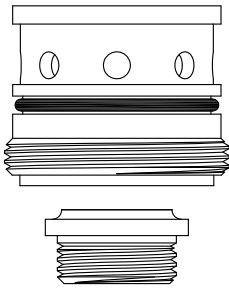

106090-OS
SYMMONS TA-4*
OLD STYLE (SHORT)

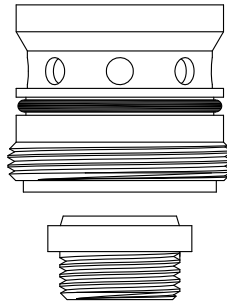

106090
SYMMONS TA-4*
NEW STYLE

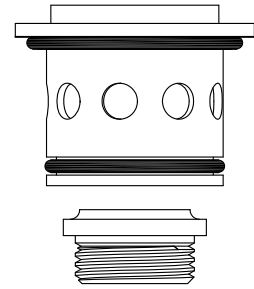

130540
SYMMONS J-18/22*

Send Your Orders To:

BARRY E.  ALTER  SR. CO.

E-mail: orderdesk@barrywalter.com

Fax: 1.800.886.9831

Phone: 1.800.767.5552

SEAT KITS

144 PIECE SEAT ASSORTMENT

PART# 131010

4 PIECES PER SEAT

COMES IN A PLASTIC COMPARTMENTED BOX

1/4

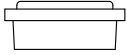

LF648200
REPCAL*

5/16



1/2-20
LF647610
SAYCO*

5/16

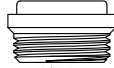

1/2-27
LF648070
KOHLER*

5/16



1/2-20
LF648230
ARROWHEAD*

5/16

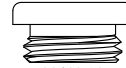

33/64-18
LF648480
UNION BRASS*

5/16

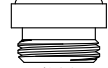

7/16-27
LF648760
SPEAKMAN*

5/16

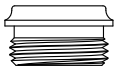

33/64-27
LF649040
MILWAUKEE*

5/16



5/8-18
LF649910
UNION BRASS*

11/32

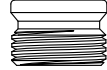

1/2-24
LF649190
STREAMWAY*

11/32

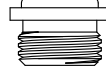

7/16-24
LF649650
AM. STD.*

11/32



9/16-28
LF649770
CRANE/REPCAL*

3/8

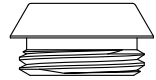

21/32-18
648370
PRICE PFISTER*

3/8



1/2-20
LF647450
SAYCO*

3/8



1/2-20
LF648100
AM. STD.*

3/8



1/2-24
LF648170
STERLING*

3/8



9/16-18
LF648220
AM. STD.*

3/8



1/2-20
LF648270
PRICE PFISTER*

3/8



1/2-20
LF648320
ELJER*

3/8



35/64-24
LF648360
AM. STD.*

3/8



9/16-27
LF648930
SPEAKMAN*

3/8



1/2-27
LF649390
KOHLER*

3/8

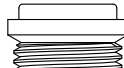

9/16-18
LF649430
CRANE*

25/64

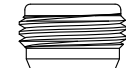

9/16-20
LF648670
HARCRAFT*

13/32



1/2-28
LF648560
INDIANA*

13/32



7/16-24
LF648990
AM. STD.*

27/64

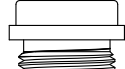

1/2-24
LF648550
CENTRAL*

27/64

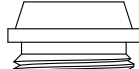

5/8-20
LF649150
GERBER*

7/16



5/8-20
647410
ARROWHEAD*

7/16

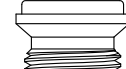

1/2-20
LF648350
AM. STD.*

7/16



35/64-20
LF648130
SAVOY*

1/2

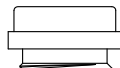

1/2-27
LF648160
ELJER*

5/8



9/16-27
LF649300
INDIANA*

23/32

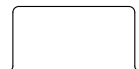

5/8-24
648810
CENTRAL*

7/8

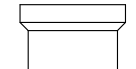

5/8-18
LF649890
UNION BRASS*

1-3/16



7/16-24
LF647910
AM. STD.*

1-7/32



1/2-20
LF648040
STREAMWAY*

SEAT KITS

100 PIECE SEAT ASSORTMENT

PART# 131080

COMES IN A PLASTIC COMPARTMENTED BOX

5/16

1/2-20
LF647610
SAYCO*
10 PCS

5/16

1/2-27
LF648070
KOHLER*
5 PCS

3/8

1/2-24
LF648170
STERLING*
10 PCS

3/8

1/2-20
LF648270
PRICE PFISTER*
5 PCS

3/8

35/64-24
LF648360
AM. STD.*
5 PCS

3/8

21/32-18
648370
PRICE PFISTER*
10 PCS

13/32

7/16-24
LF648990
AM. STD.*
15 PCS

27/64

1/2-24
LF648550
CENTRAL*
10 PCS

27/64

5/8-20
LF649150
GERBER*
15 PCS

7/16

1/2-20
LF648350
AM. STD.*
5 PCS

7/16

35/64-20
LF648130
SAVOY*
5 PCS

1/2

1/2-27
LF648160
ELJER*
5 PCS

BARRY E.  SR. CO.











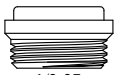
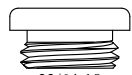
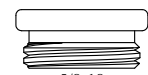
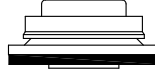



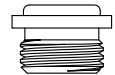
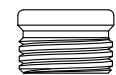

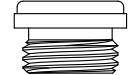

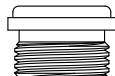
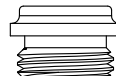
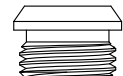





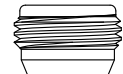

SEAT KITS

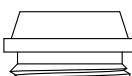
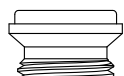
72 PIECE SEAT ASSORTMENT

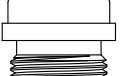
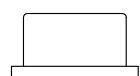
PART# 118810

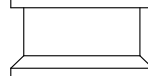
2 PIECES PER SEAT UNLESS OTHERWISE NOTED

COMES IN A PLASTIC COMPARTMENTED BOX

5/16  1/2-27 LF648070 KOHLER*	5/16  33/64-18 LF648480 UNION BRASS*	5/16  5/8-18 LF649910 UNION BRASS*	2 1/4  LF649460 KOHLER*	1 1/2  1/2-20 LF648410 AM. BRASS*	1 1/2  LF648020 ELJER*
1 1/2  7/16-27 LF648760 SPEAKMAN*	1 1/2  7/16-24 LF649650 AM. STD.*	2 3/4  1/2-20 LF648280 STREAMWAY*	3/8  2 1/2-18 648370 PRICE PFISTER*	3/8  1/2-20 LF647000 AM. KITCHEN*	3/8  5/8-27 LF647230 KOHLER*
3/8  1/2-20 LF647450 SAYCO*	3/8  1/2-24 LF648170 STERLING*	3/8  1/2-20 LF648270 PRICE PFISTER*	3/8  1/2-20 LF648320 ELJER* 6 PCS	3/8  35/64-24 LF648360 AM. STD.*	3/8  9/16-18 LF648220 AM. STD.*
3/8  5/8-20 648640 SAYCO*	3/8  1/2-27 LF649390 KOHLER*	3/8  9/16-18 LF649430 CRANE*	3/8  9/16-20 LF648670 HARCRAFT*	1 3/2  1/2-28 LF648560 INDIANA*	1 3/2  7/16-24 LF648990 AM. STD.*
1 3/2  9/16-22 LF648340 CRANE*	2 7/4  5/8-20 LF649150 GERBER*	7/16  1/2-20 LF648350 AM. STD.*	7/16  1/2-24 LF648550 CENTRAL*	7/16  1/2-24 LF648120 BRIGGS / REPCAL*	1/2  1/2-27 LF648160 ELJER*
5/8  9/16-27 LF649300 INDIANA*	2 3/2  5/8-24 648810 CENTRAL*	1 3/16  5/8-20 648630 BRIGGS / REPUBLIC*	7/8  5/8-18 LF649890 UNION BRASS*	1-3/16  7/16-24 LF647910 AM. STD.*	1-7/32  1/2-20 LF648040 STREAMWAY*

BARRELS

FOR CHG
LENGTH: 1.29"

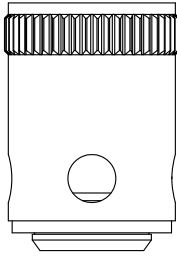

O.D.: 0.870"

LF662571
LF662572

FOR WATER SAVER
LENGTH: 1.33"

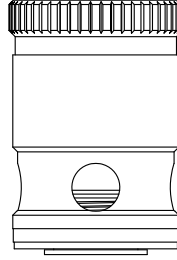

O.D.: 0.865"
Stainless Steel
Seat Included: 648600

LF661301
LF661302

FOR KOHLER
LENGTH: 1.41"

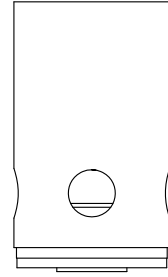

O.D.: 0.812"
OEM PART # 24822

LF660050

FOR KOHLER
LENGTH: 1.44"

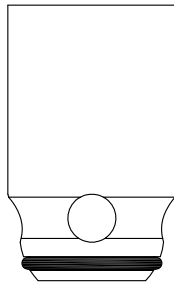

O.D.: 0.875"
OEM PART # 32462

LF647321
LF647322

FOR AM STD
LENGTH: 1.47"

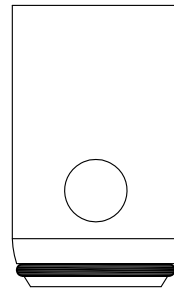

O.D.: 0.870"
OEM PART # 21376-27

LF647020

FOR AM STD
LENGTH: 1.47"

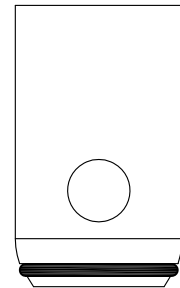

O.D.: 0.870"
OEM PART # 20336-27

LF647021
LF647022

FOR T & S
LENGTH: 1.53"

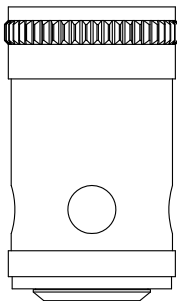

O.D.: 0.840"
OEM PART # 00788-20

LF664061
LF664062

FOR CHG
LENGTH: 1.53"

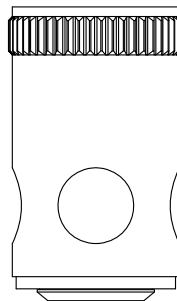

O.D.: 0.870"

LF666481
LF666482

FOR T & S
LENGTH: 1.54"

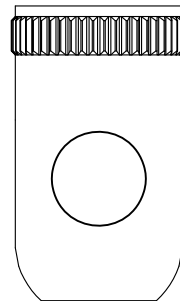

O.D.: 0.870"

LF664561
LF664562

BARRELS

FOR AM STD
LENGTH: 1.56"

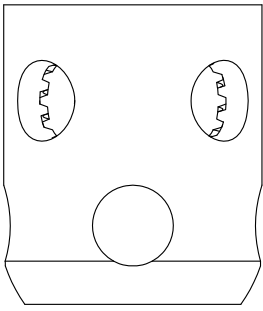

O.D.: 1.345"

635801

Single Lead

FOR AM STD RENU
LENGTH: 1.59"

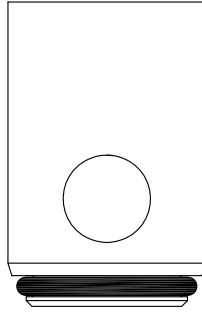

O.D.: 1.030"

OEM PART # 20651-27

LF647031

Double Lead

FOR AM STD RENU
LENGTH: 1.59"

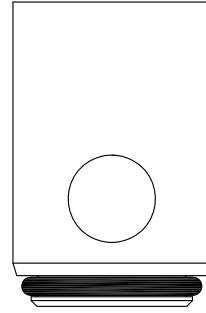

O.D.: 1.030"

OEM PART # 20691-27

LF647041

LF647042

FOR KOHLER
LENGTH: 1.77"

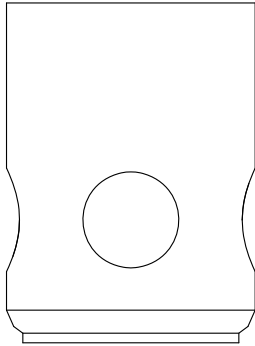

O.D.: 1.30"

OEM PART # 22592

647341

FOR WATER SAVER
LENGTH: 1.67"

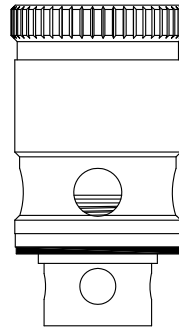

O.D.: 0.865"

Stainless Steel

Seat Included: 648600

LF664041

LF664042

FOR KOHLER
LENGTH: 1.85"

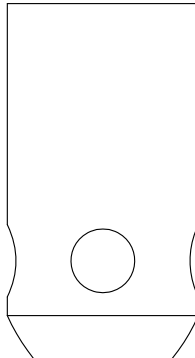

O.D.: 0.995"

OEM PART # 22565

647351

FOR MUELLER RENU
LENGTH: 2.25"

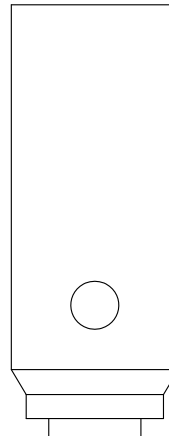

O.D.: 0.875"

623401

BARRELS

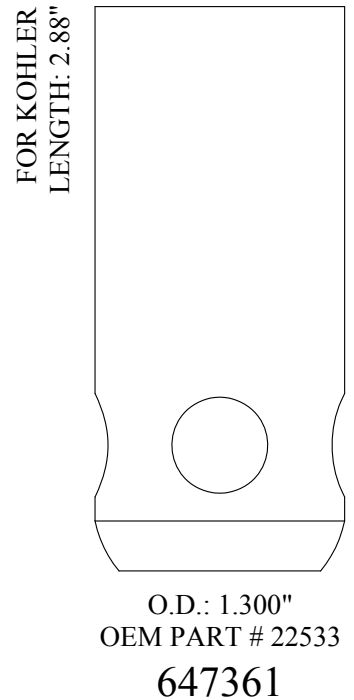
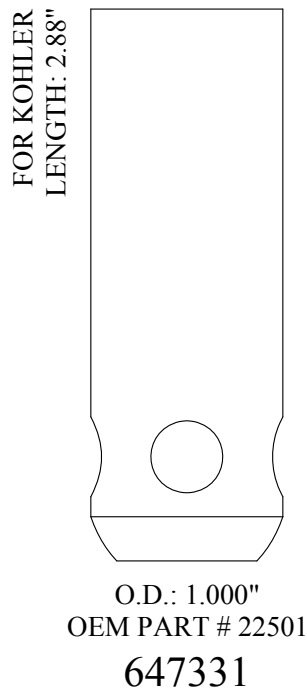
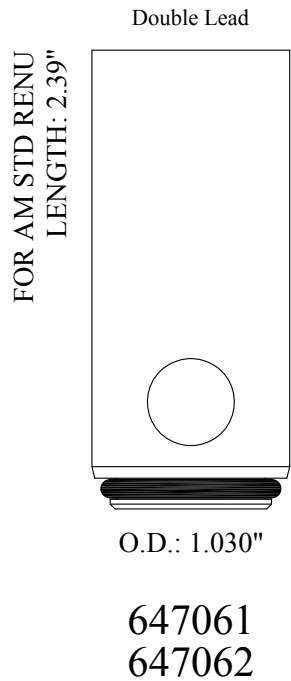
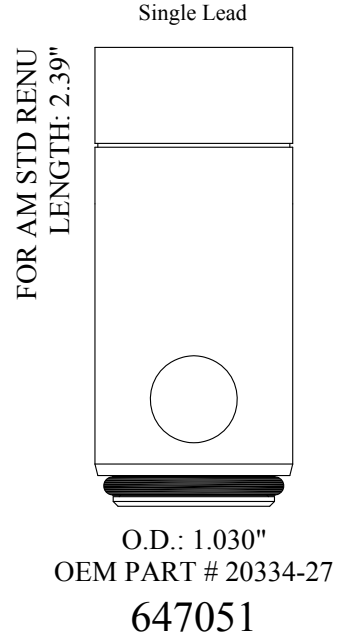
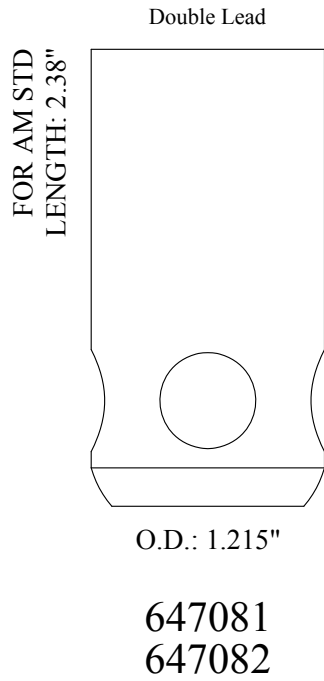
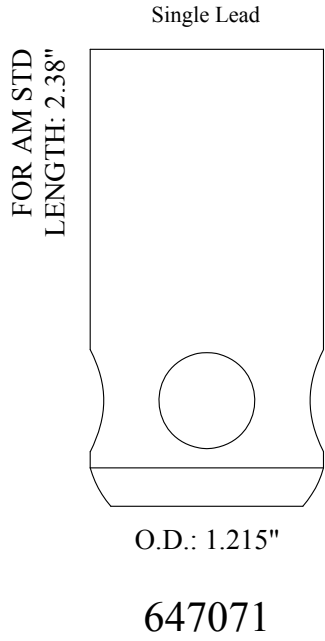

Send Your Orders To:

BARRY E.  SR. CO.

E-mail: orderdesk@barrywalter.com

Fax: 1.800.886.9831

Phone: 1.800.767.5552

BARRY E.  WALTER SR. CO.

STEM EXTENSIONS,
STEM EXTENSION KITS &
HANDLE ADAPTERS

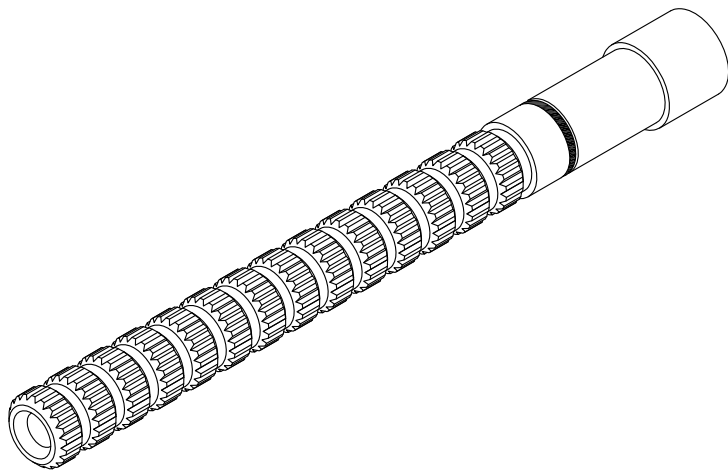

STEM EXTENSIONS & HANDLE ADAPTERS

FOR SPEAKMAN
PLASTIC PART

20

2-4

3-14

20

105740

FOR SPEAKMAN
NICKEL PLATED

20

Speakman
9/16

2-4

20

05-1409

FOR GLACIER BAY
SOLID BRASS

20

109750

FOR SPEAKMAN
NICKEL PLATED

20

2-4

05-1423

FOR SPEAKMAN
NICKEL PLATED

20

3-14

05-1641

FOR CONCINITY

16

1-6

3-20

20

152430

FOR KOHLER
SOLID BRASS

19

1-7

3-20

20

121230

FOR SYMMONS
SOLID BRASS

12

Symmons
Small

122240

FOR SYMMONS
SOLID BRASS

12

Symmons
Small

109640

American
Standard
Azimuth

FOR AM STD

34

1-6

3-30

18

106810

Also available as a kit
with handle screw

140370

Part# 899240
Screw Only

FOR AM STD

18

3-30

140300

FOR DORNBRACHT
PLASTIC PART

20

3-32

3-20

20

103200

FOR AM STD
PLASTIC PART

18

3-30

144240

FOR SINGLE LEVER

20

3-20

126020

FOR U/R

20

3-20

153690

FOR BROADWAY

20

2-4

1-6

16

167480

STEM EXTENSIONS & HANDLE ADAPTERS

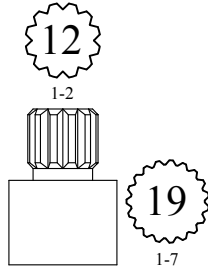

118250
Fits KOHLER

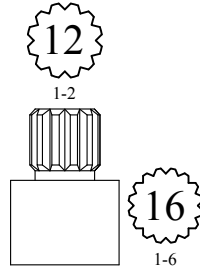

171740
Fits CENTRAL

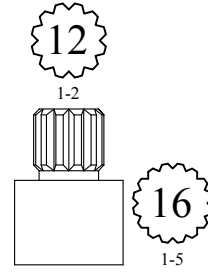

172860
Fits STERLING

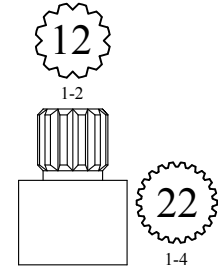

172930
Fits AM STD

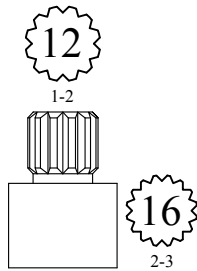

173000
Fits SAYCO

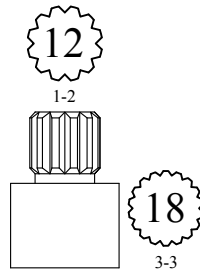

173070
Fits BRIGGS

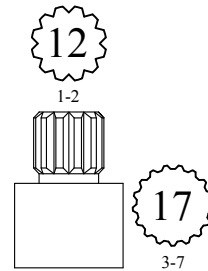

173140
Fits AM BRASS / STREAMWAY

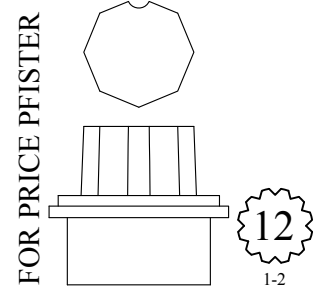

106440

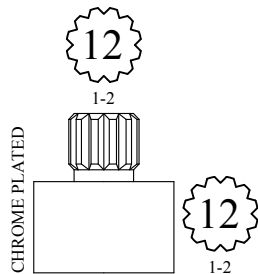

175310
Fits PRICE PFISTER

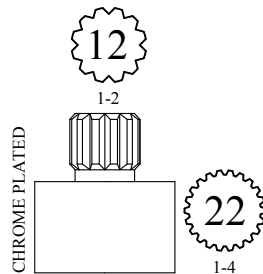

175380
Fits AM STD

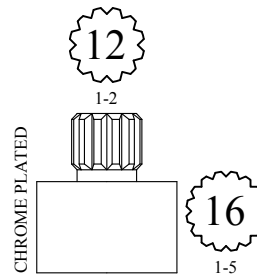

175450
Fits STERLING

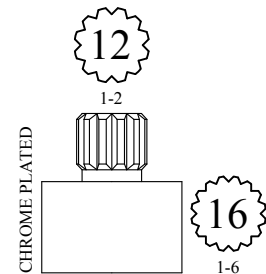

175520
Fits CENTRAL

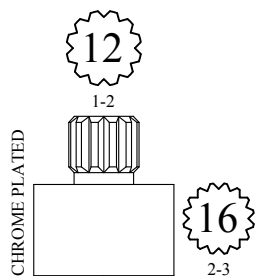

175590
Fits SAYCO

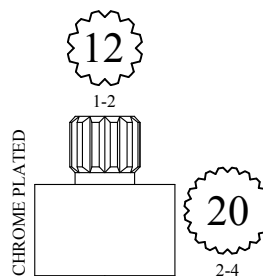

175660
Fits SPEAKMAN

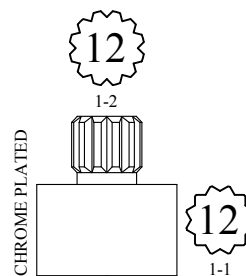

175730
Fits CRANE

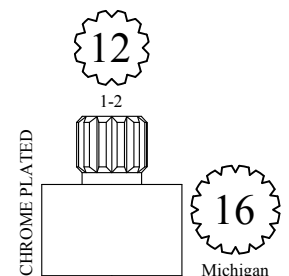

175800
FIT-ALL
Michigan

STEM EXTENSIONS & HANDLE ADAPTERS

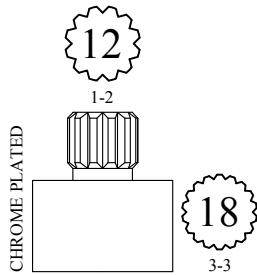

180920

Fits BRIGGS

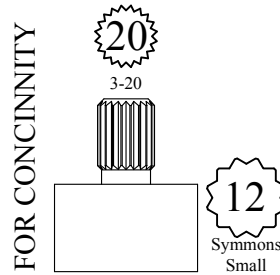

114490

Symmons Small

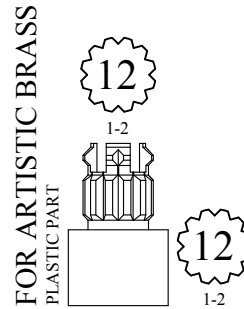

103150

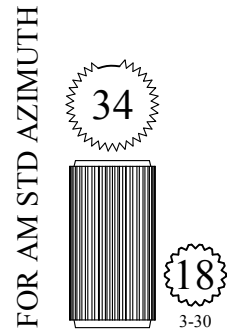

122030

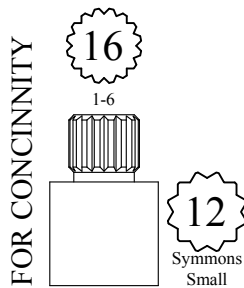

105130

Symmons Small

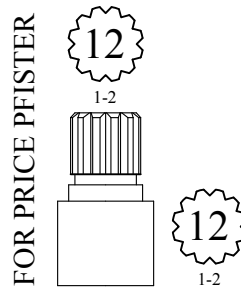

186380

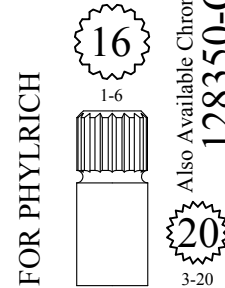

128350

Also Available Chrome Plated
128350-CP
Also Available Polished Brass
128350-PB

Also available as a kit
with handle screw

140510

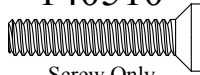

Screw Only
Part# 899300

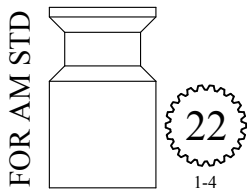

140440

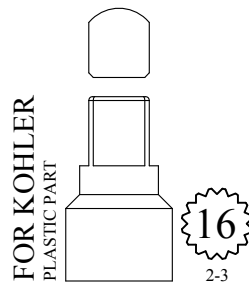

133040

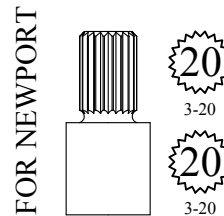

135820

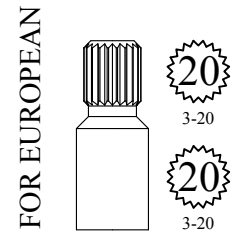

118760

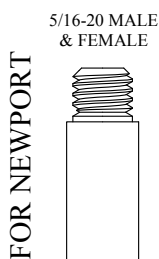

144380

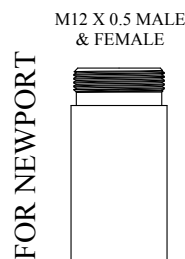

144450

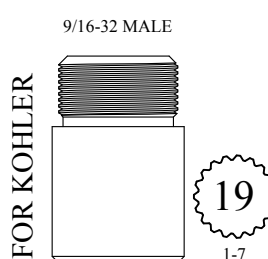

131480

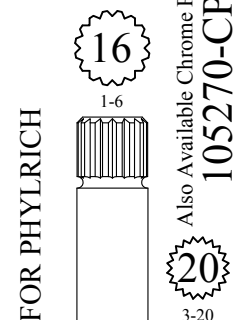

105270

Also Available Chrome Plated
105270-CP
Also Available Polished Brass
105270-PB

STEM EXTENSIONS & HANDLE ADAPTERS

FOR KOHLER

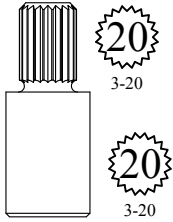

135000

FOR GLACIER BAY
CHROME PLATED

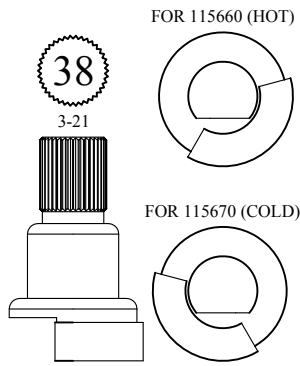

115660
115670

M4 x 0.7 MALE
& FEMALE

FOR ROHL

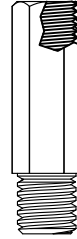

230850-2

FOR PHYLRICH

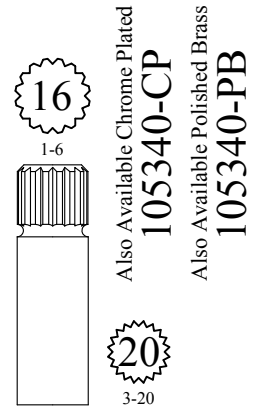

105340

FOR ELJER

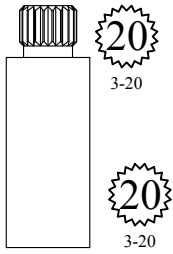

113090

FOR PRICE PFISTER

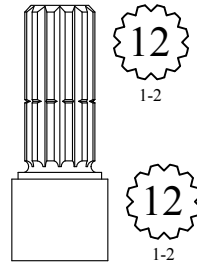

125480

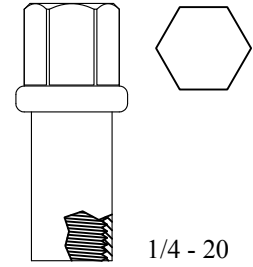

113160

Also available as a kit
with handle screw

140720

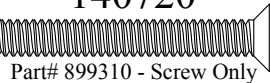

Part# 899310 - Screw Only

FOR PRICE PFISTER
NICKEL PLATED

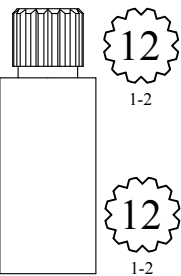

645510

FOR CENTRAL

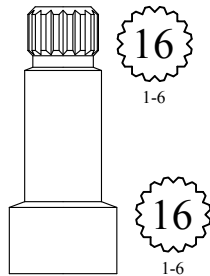

149980

FOR AM STD



140580

FOR PHYLRICH

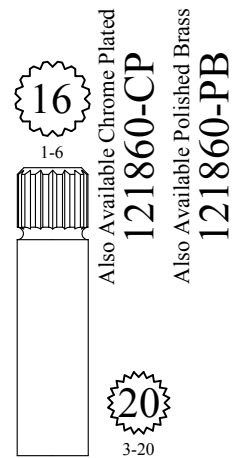

121860

STEM EXTENSIONS & HANDLE ADAPTERS

FOR SYMMONS

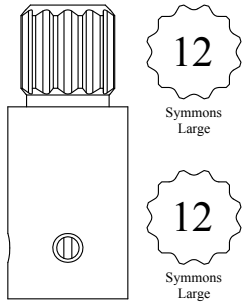

113840

FOR ULTRA MIX

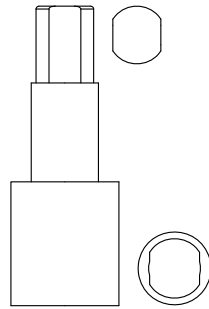

198110

FOR PHYLRICH

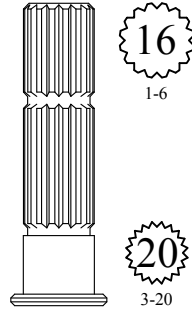

116750

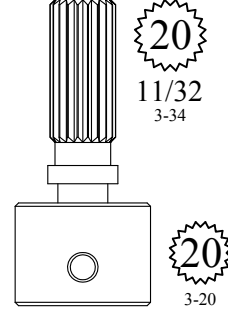

140410

FOR KALISTA

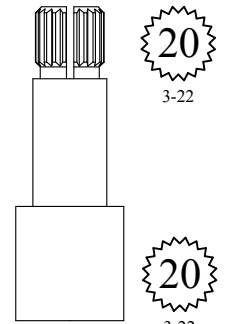

108980

FOR SYSTEM

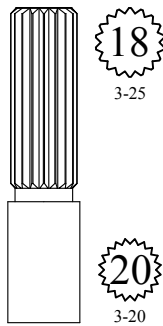

160120

FOR ELJER

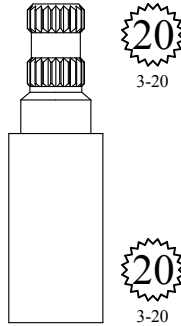

129140

FOR SYMMONS

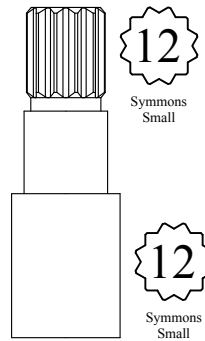

102290

FOR MOEN

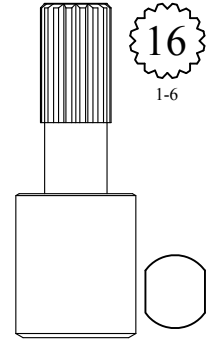

168870

FOR ALTMANS

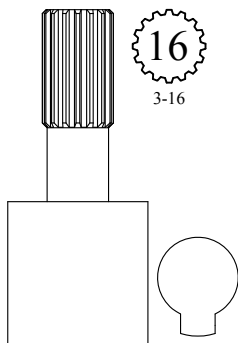

177200

FOR JADO

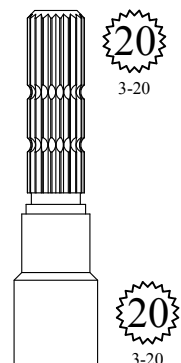

103570

FOR CIFIAL

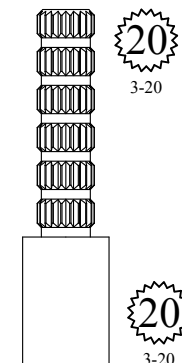

156280

FOR PHYLRICH

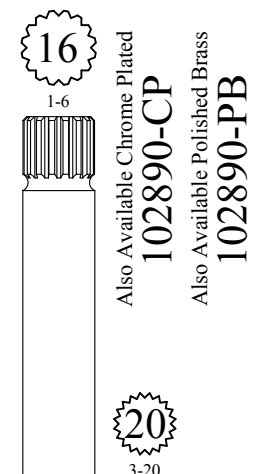

102890

STEM EXTENSIONS & HANDLE ADAPTERS

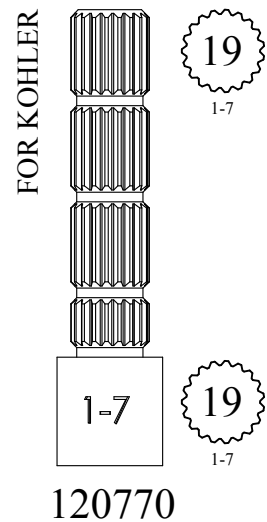
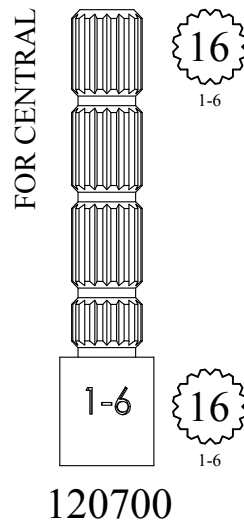
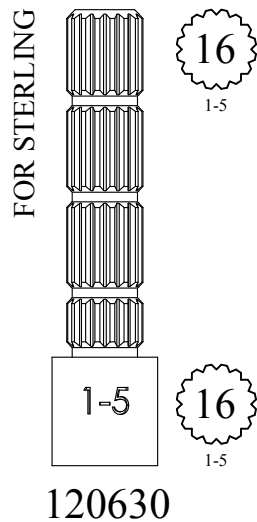
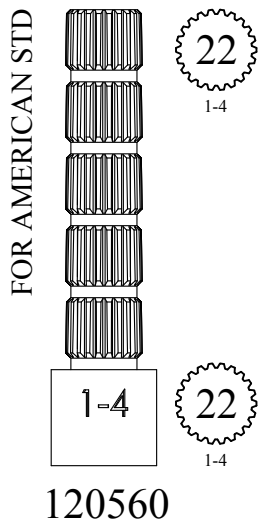
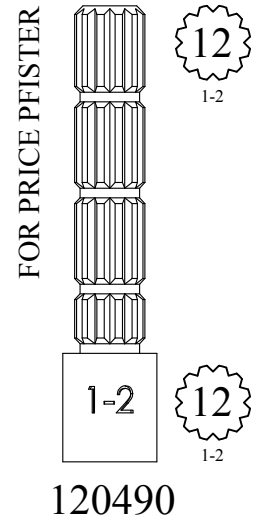
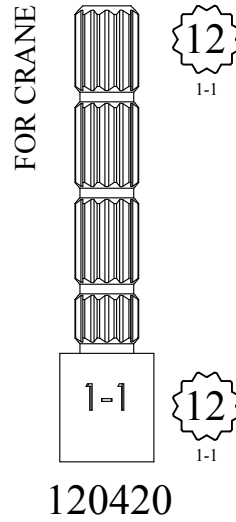
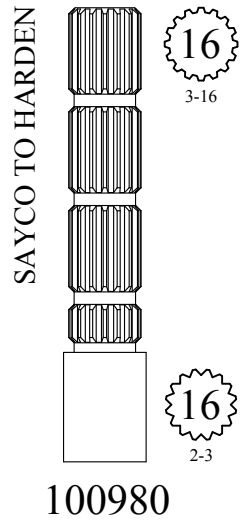
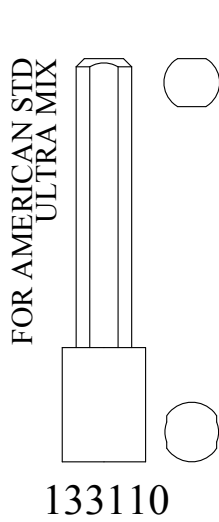
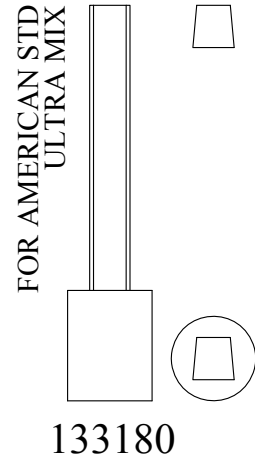
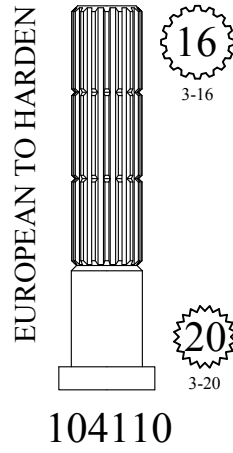
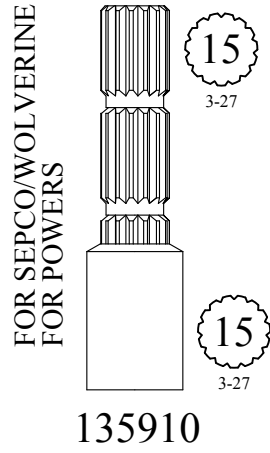
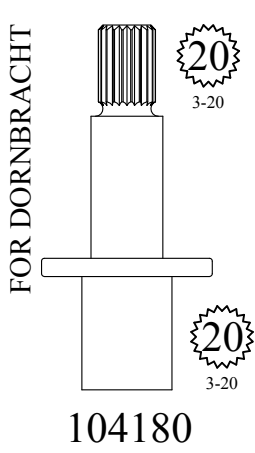

STEM EXTENSIONS & HANDLE ADAPTERS

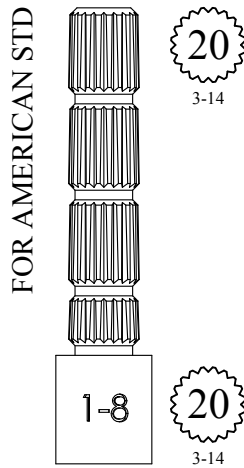

120840

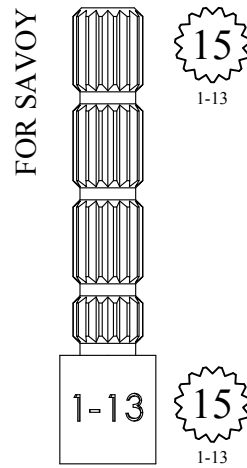

120910

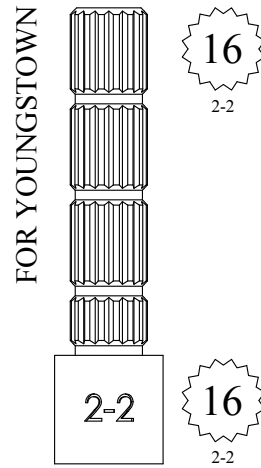

120980

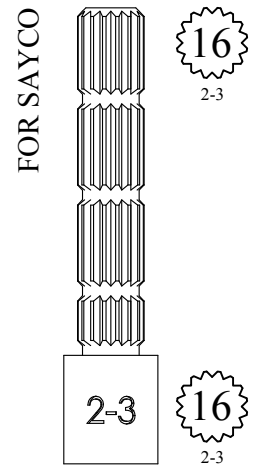

121050

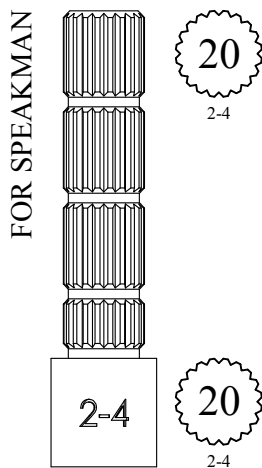

121120

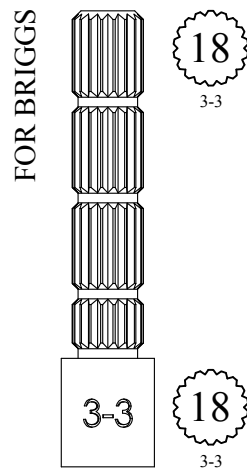

121190

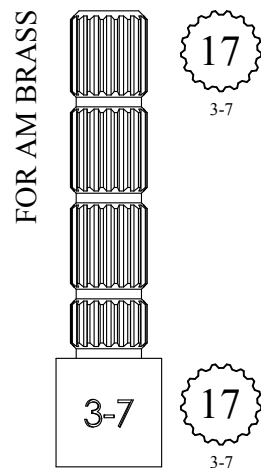

121330

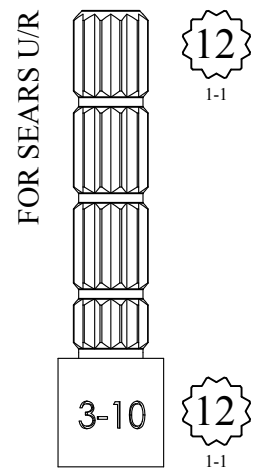

121400

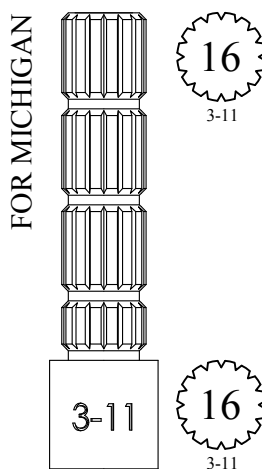

121470

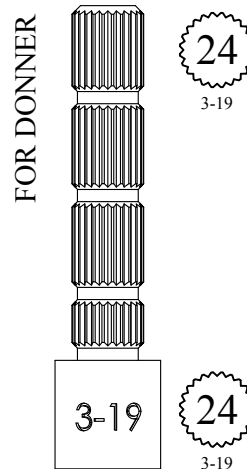

130890

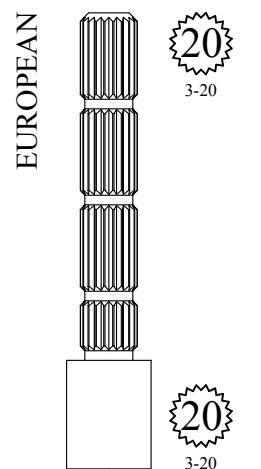

160400

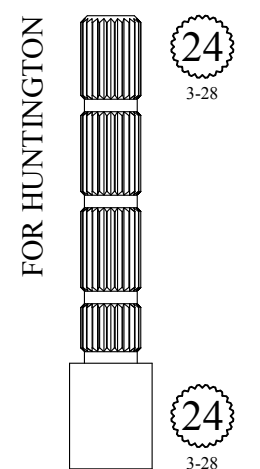

102240

STEM EXTENSIONS & HANDLE ADAPTERS

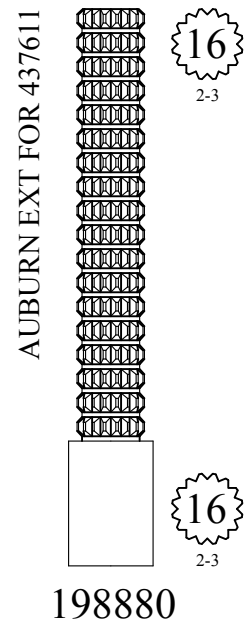
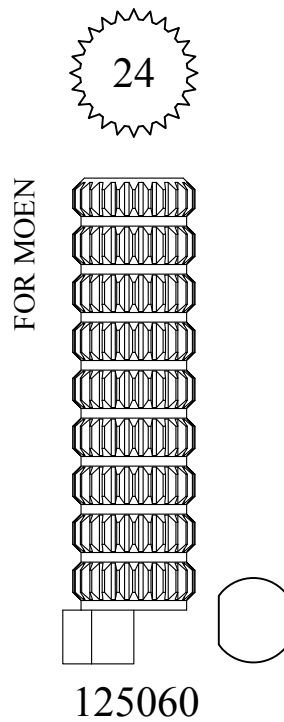
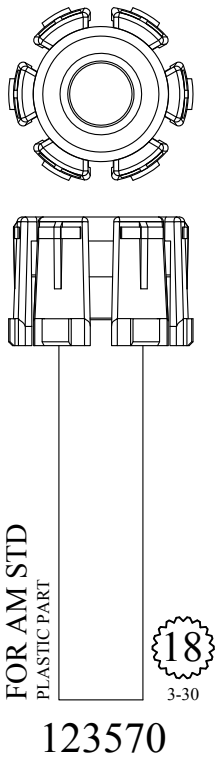
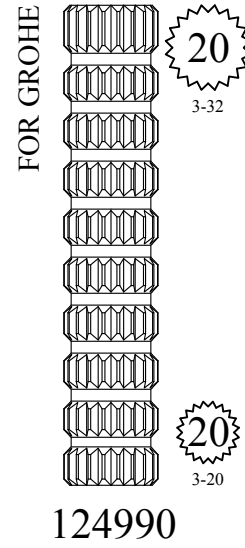
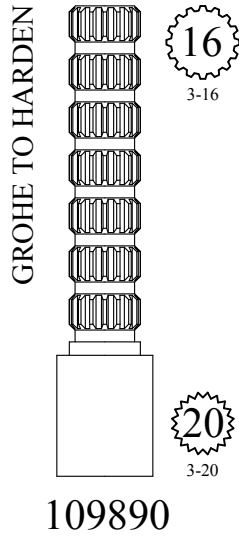
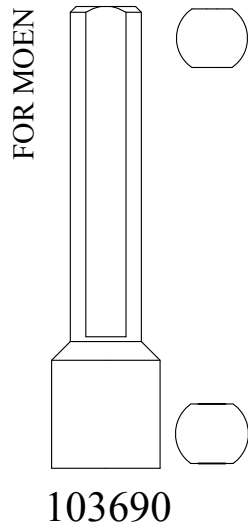

STEM EXTENSIONS & HANDLE ADAPTERS

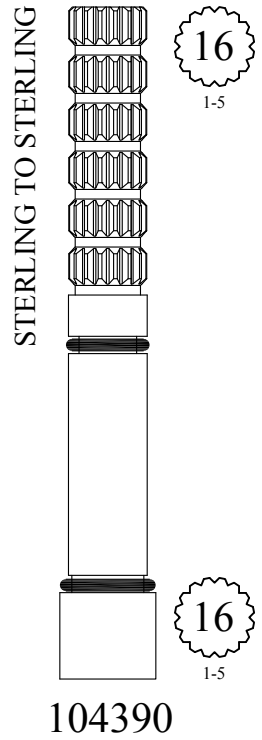
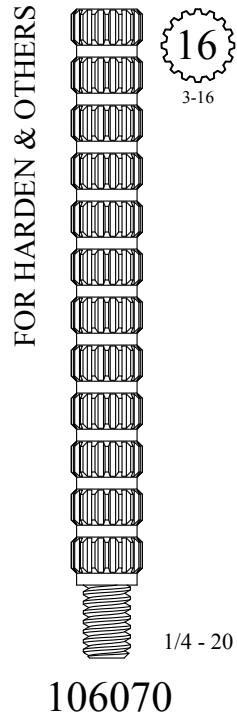
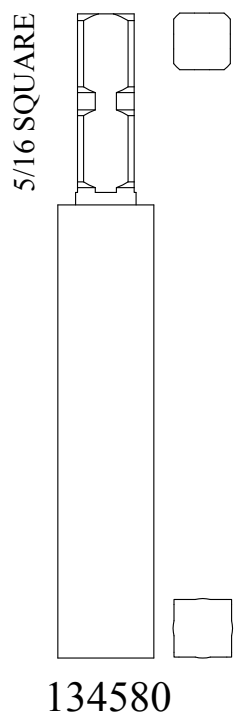
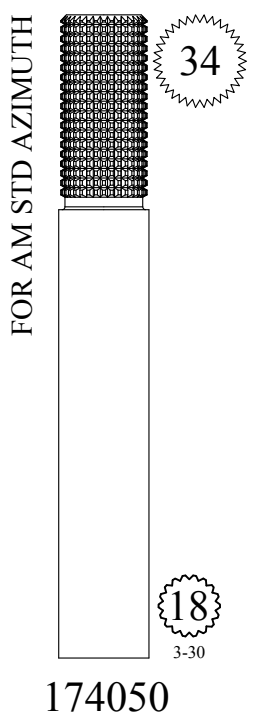
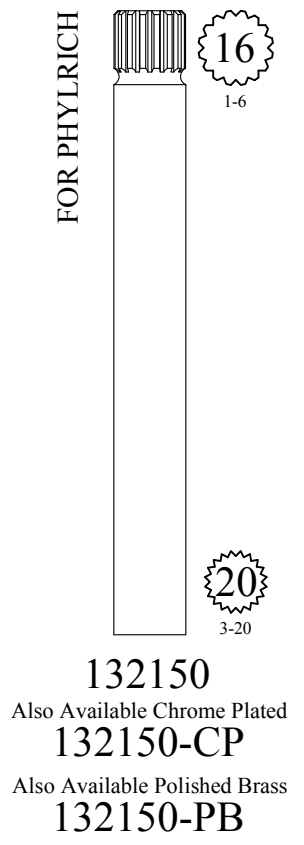
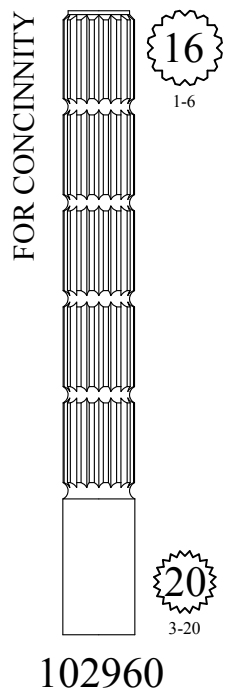
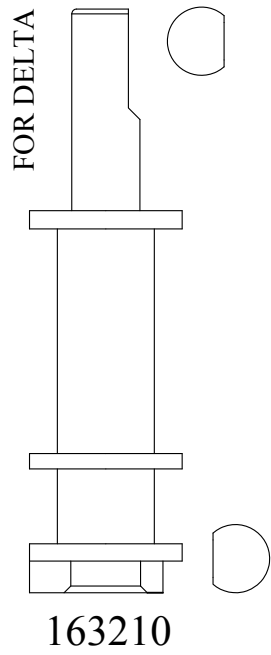
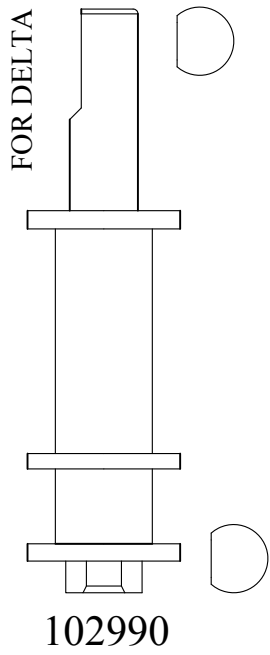

STEM EXTENSIONS & HANDLE ADAPTERS

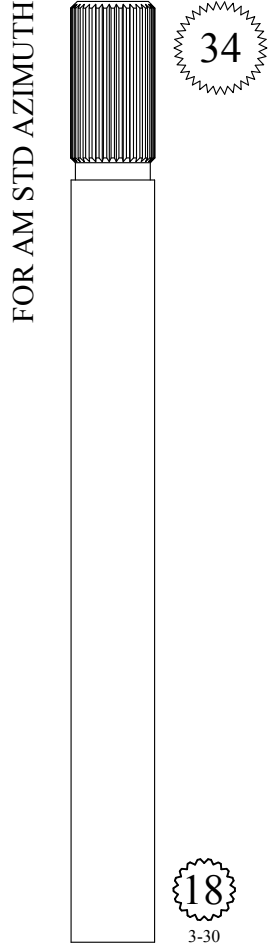
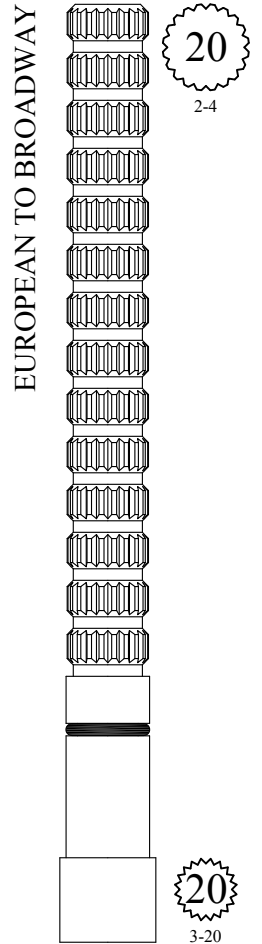
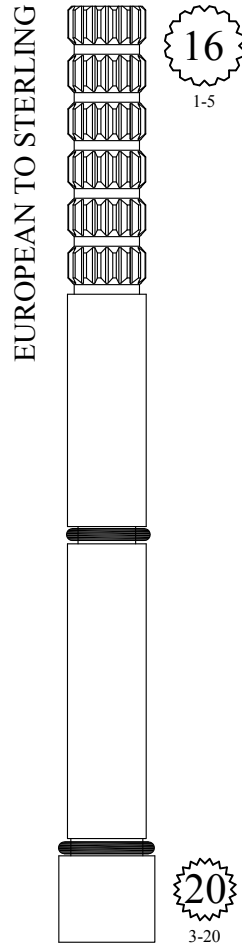
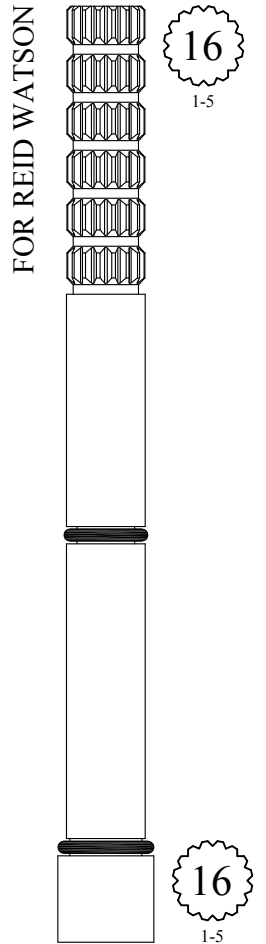
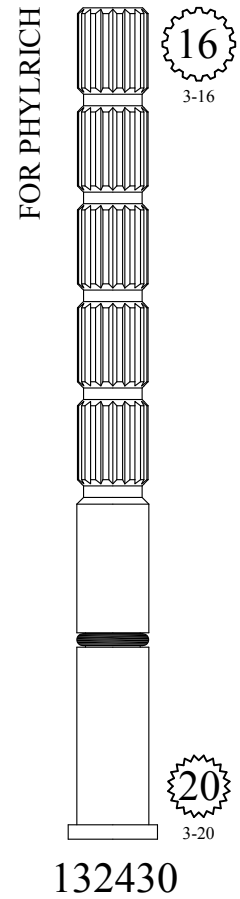
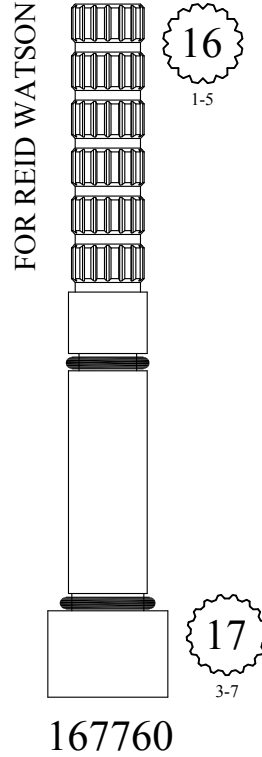
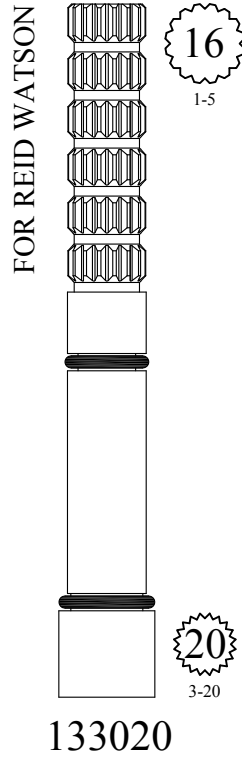
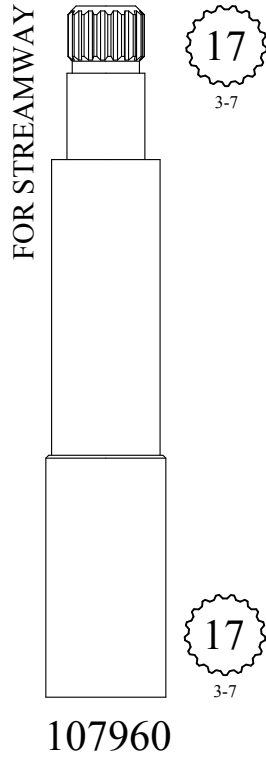

STEM EXTENSIONS & HANDLE ADAPTERS

EUROPEAN TO GERBER

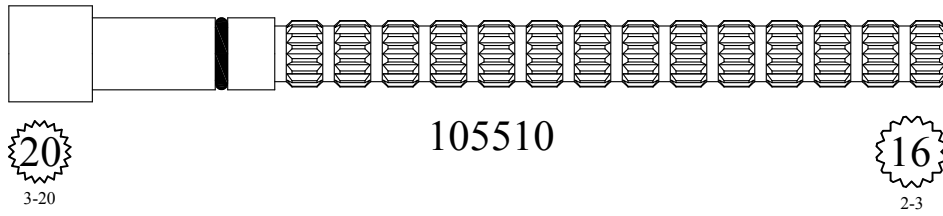

EUROPEAN TO HARDEN

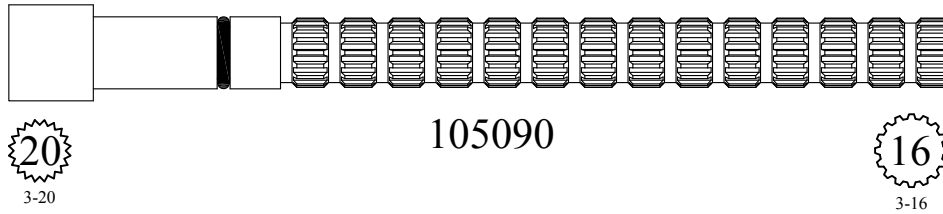

EUROPEAN TO EUROPEAN

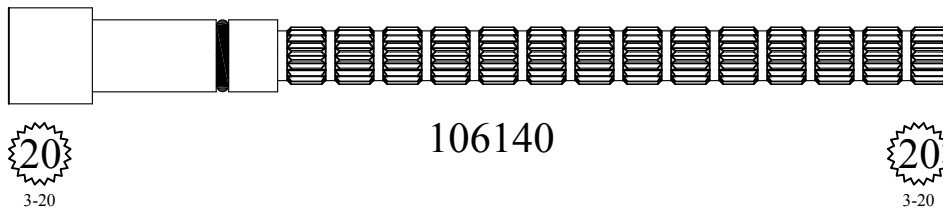

EUROPEAN TO PRICE PFISTER

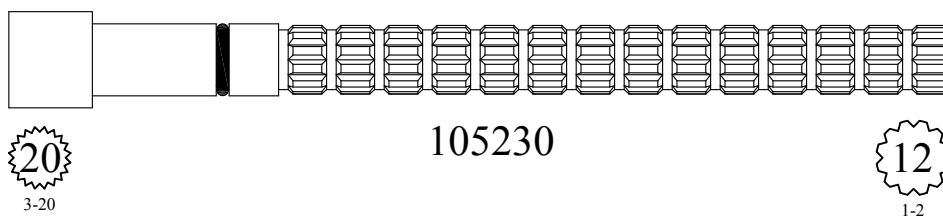

HARDEN BROACH

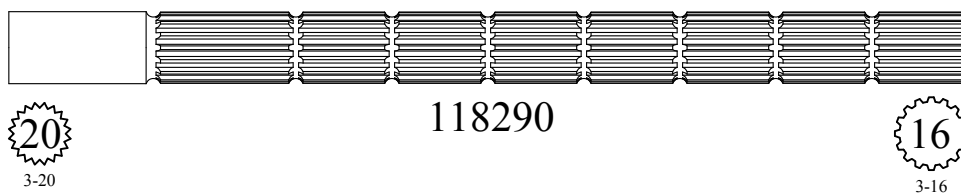

CENTRAL BRASS BROACH

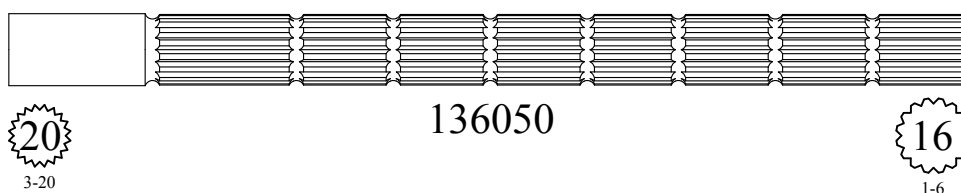

STEM EXTENSION KITS

FOR AM STD AZIMUTH

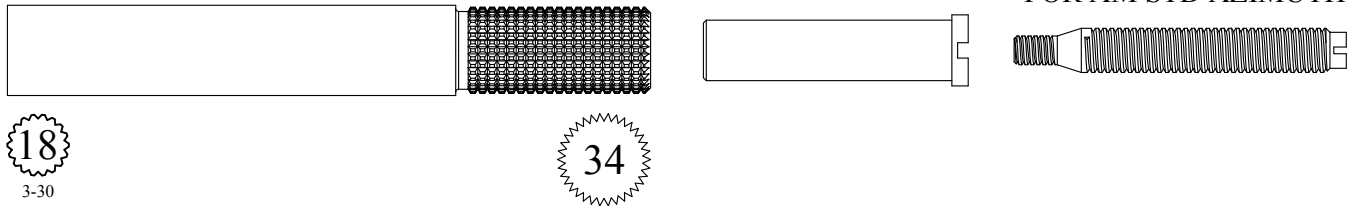

173350

FOR AM STD



FOR AM STD AZIMUTH

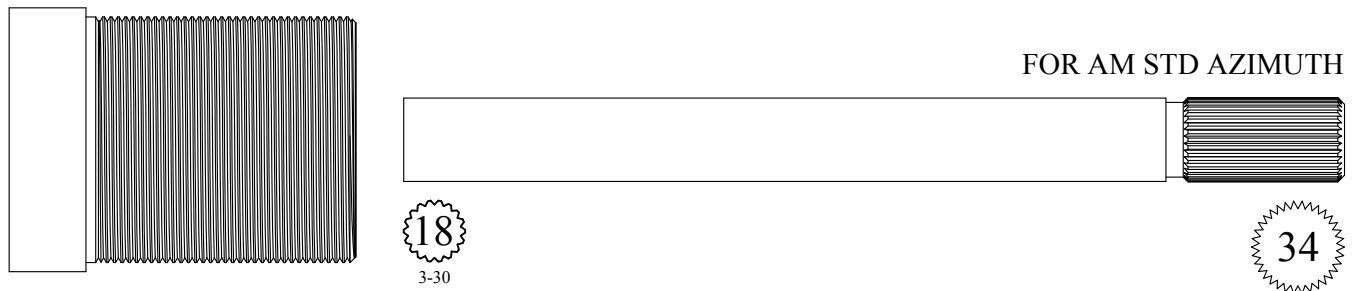

123780

BARRY E.  WALTER SR. CO.

STEM EXTENSION KITS

FOR AM STD ULTRA-MIX
WITH VOLUME CONTROL STEM

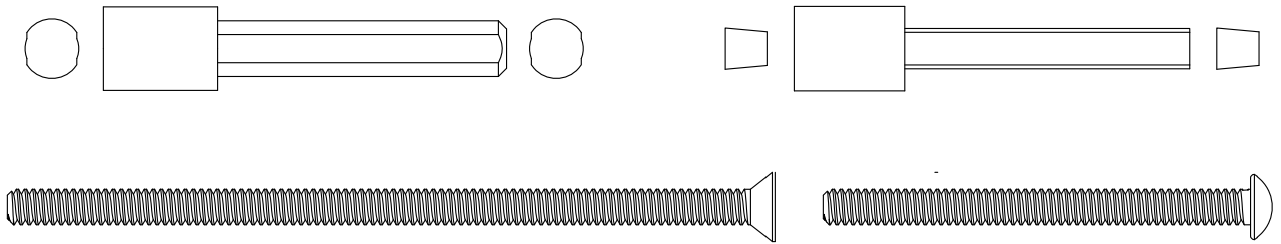

168530

FOR AM STD ULTRA MIX
LESS VOLUME CONTROL STEM

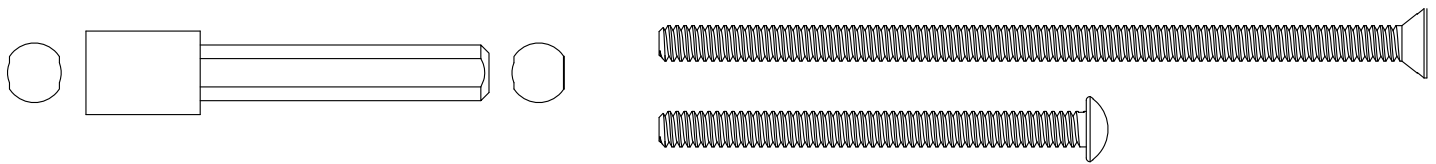

157180

FOR CENTRAL

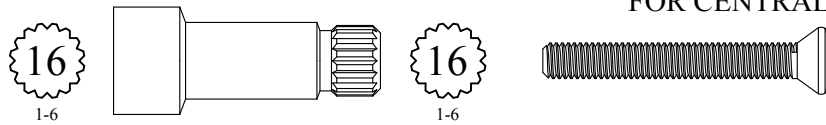

149910

Part numbers 156140 and 156280 used together to make one
handle adapter

FOR CIFIAL

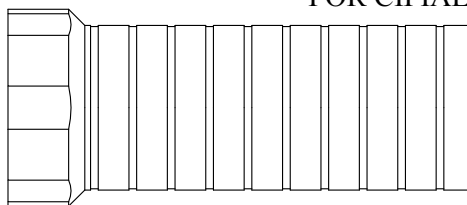

156140

FOR CIFIAL

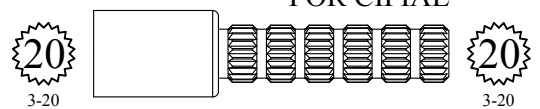

156280

STEM EXTENSION KITS

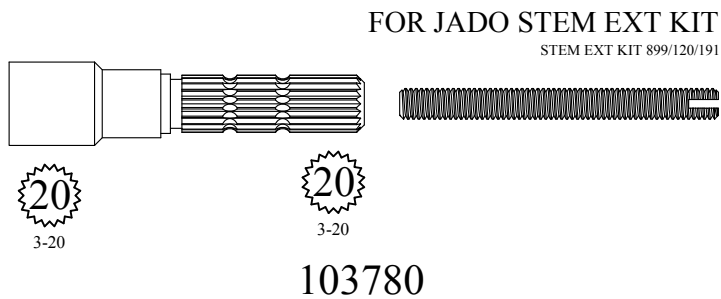
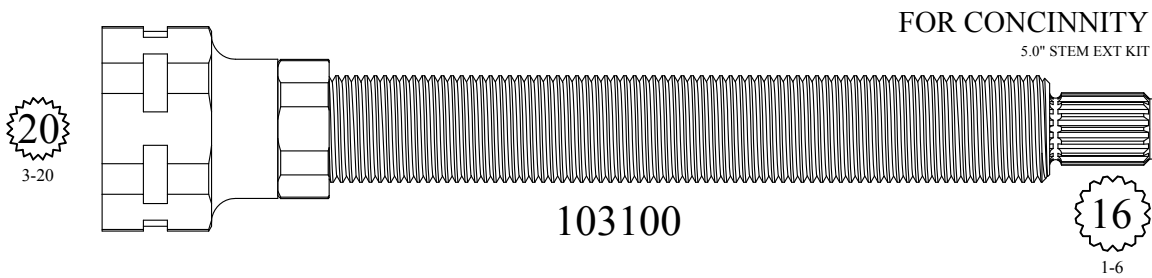
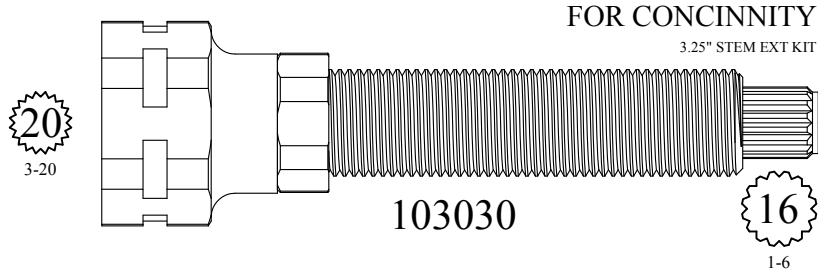

BARRY E.  WALTER  SR. CO.

STEM EXTENSION KITS

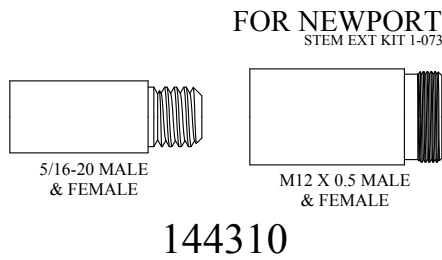
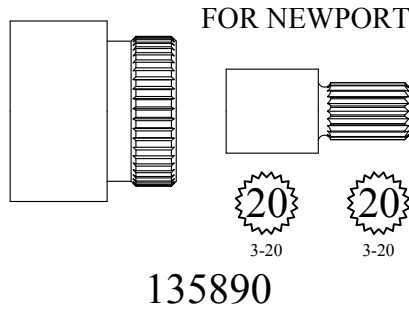
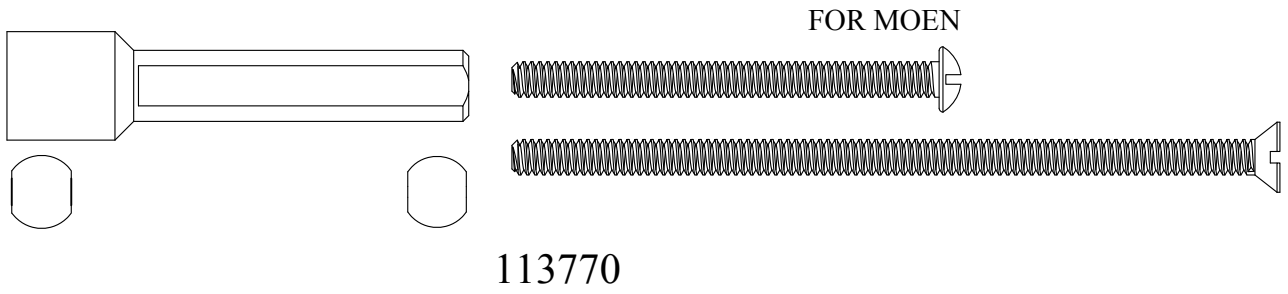

BARRY E.  ALTER SR. CO.

STEM EXTENSION KITS

FOR PRICE PFISTER
STEM EXT W/SCREW ADAPTER

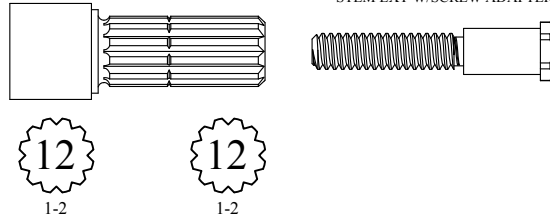

129050

FOR PRICE PFISTER
STEM EXT KIT 910-007
FOR CERAMIC UNIT

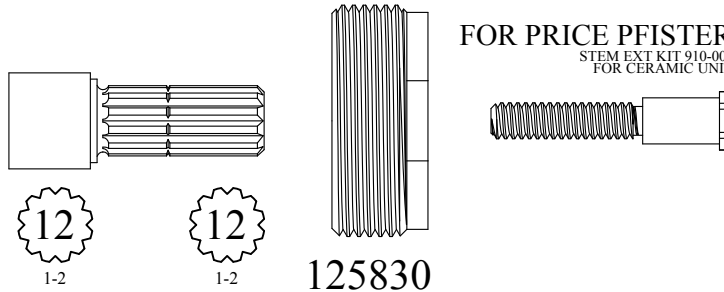

125830

FOR PRICE PFISTER
STEM EXT KIT 910-682

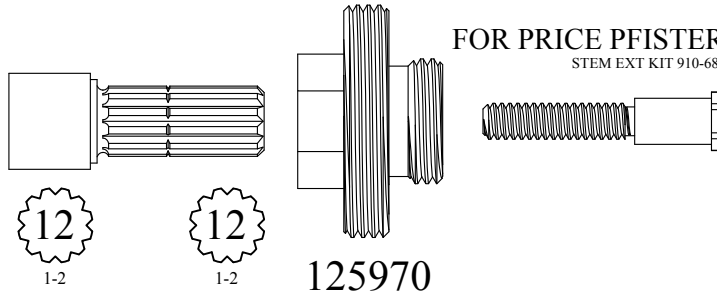

125970

FOR PRICE PFISTER
STEM EXT KIT 910-561

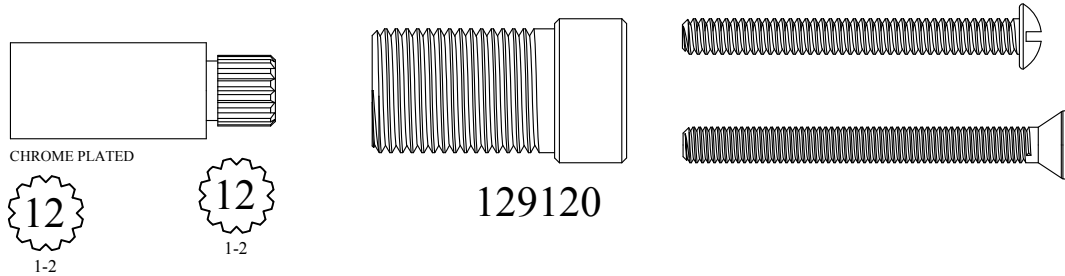

129120

FOR PRICE PFISTER

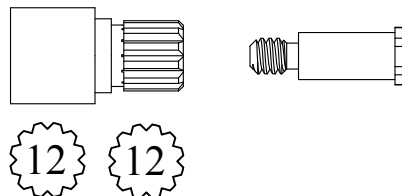

186310

STEM EXTENSION KITS

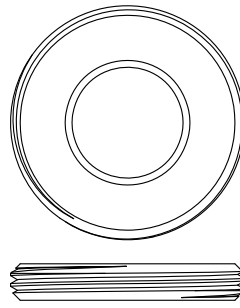
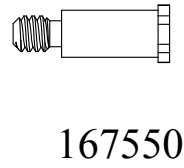
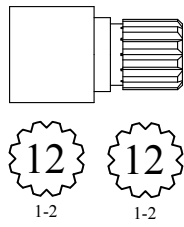

FOR PRICE PFISTER

167550

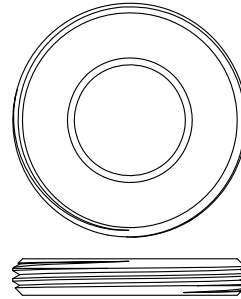
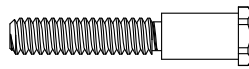
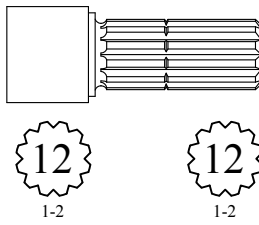

FOR PRICE PFISTER

167620

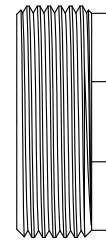
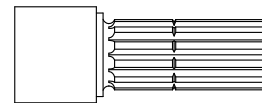
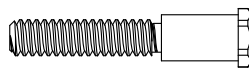
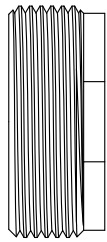
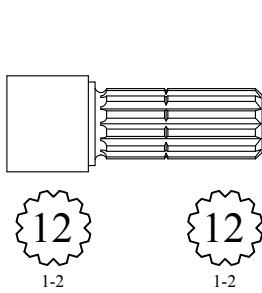

FOR PRICE PFISTER

910-007
2X 125830

2X

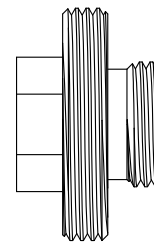
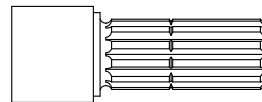
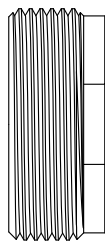
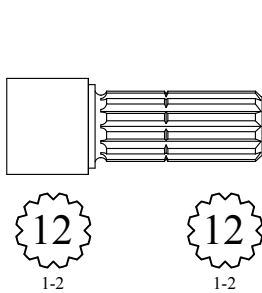

FOR PRICE PFISTER

910-005
2X 125830 & 125970

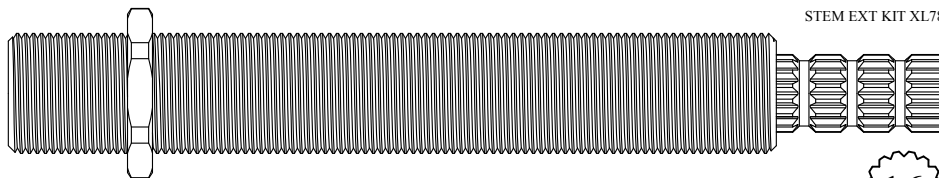

FOR REID WATSON
STEM EXT KIT XL78



128280

Send Your Orders To:

BARRY E.  SR. CO.

E-mail: orderdesk@barrywalter.com

Fax: 1.800.886.9831

Phone: 1.800.767.5552

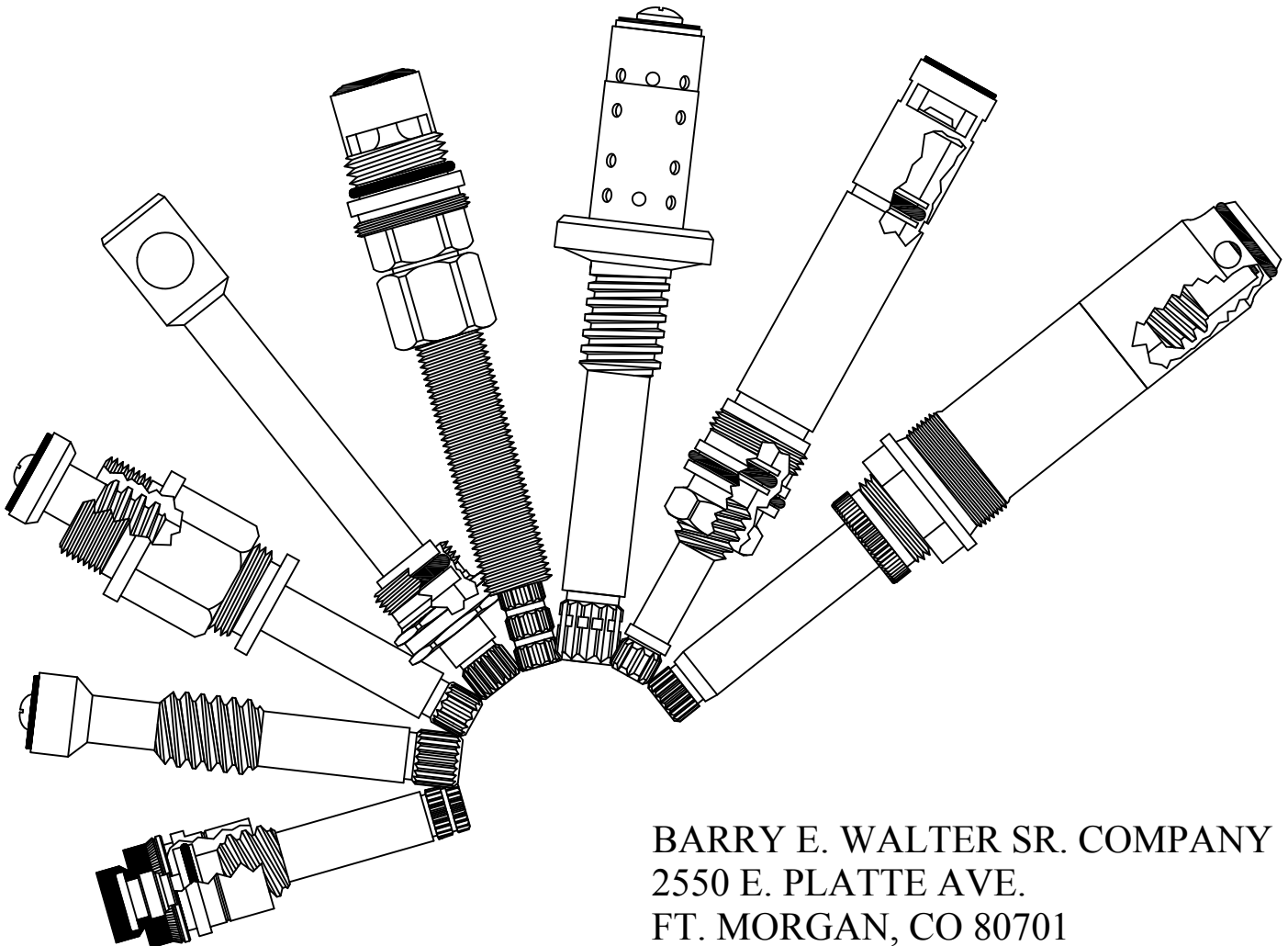

BARRY E. WALTER SR. COMPANY
2550 E. PLATTE AVE.
FT. MORGAN, CO 80701

HANDLE ADAPTERS FOR FIT-ALL HANDLES

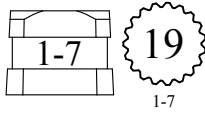

139550
Fits KOHLER

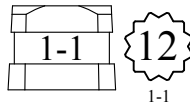

140670
Fits CRANE-REPCAL

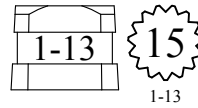

140740
Fits SAVOY

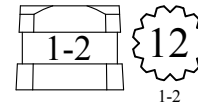

141020
Fits PRICE PFISTER

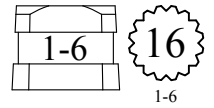

141300
Fits CENTRAL

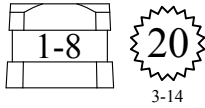

141650
Fits AM STD 3/8"

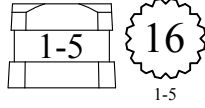

142000
Fits STERLING

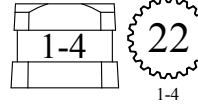

142140
Fits AM STD 7/16"

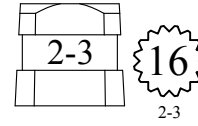

140880
Fits SAYCO

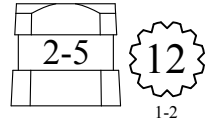

141160
Fits PRICE PFISTER

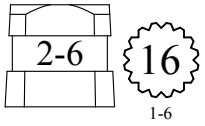

141370
Fits CENTRAL

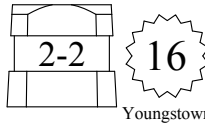

142210
Fits YOUNGSTOWN

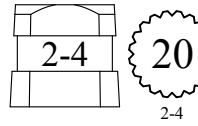

142280
Fits SPEAKMAN

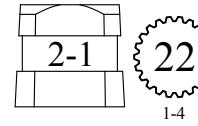

176920
Fits AM STD 7/16"

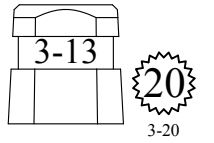

109360
Fits 20pt European

Same as 116710
w/ 4 set screws

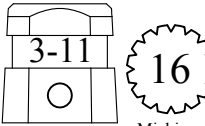

110060
FIT-ALL

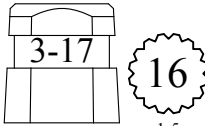

116570
Fits STERLING

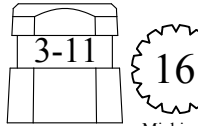

116710
Fits MICHIGAN / STERLING

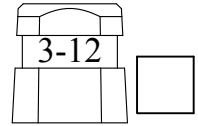

116780
Fits CHICAGO

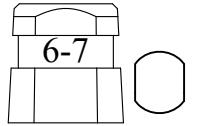

128070
Fits UNIVERSAL RUNDLE

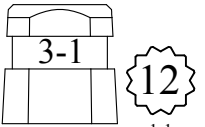

140810
Fits CRANE-REPCAL

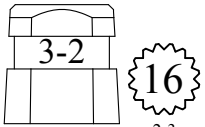

140950
Fits SAYCO

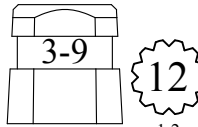

141230
Fits PRICE PFISTER

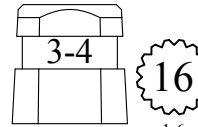

141510
Fits CENTRAL

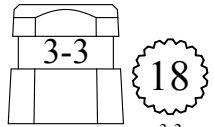

141580
Fits BRIGGS

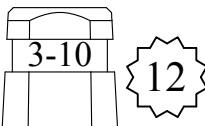

141720
Fits SEARS

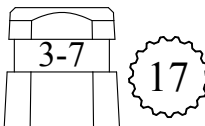

142070
Fits AM BRASS / STREAMWAY

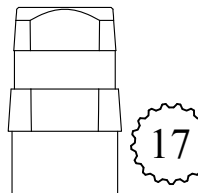

135610
Fits AM BRASS / STREAMWAY

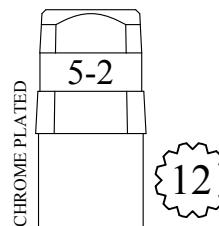

116500
Fits CRANE

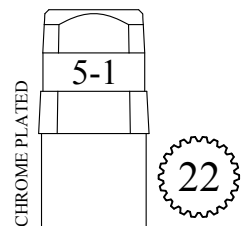

116640
Fits AM STD

PORCELAIN HANDLE ADAPTERS

These solid brass inserts convert the OEM or Walter Equivalent Porcelain handles to the stem listed below the part number

For Price Pfister style replacement handles
See pg.148

These adapters are also listed on pg.148

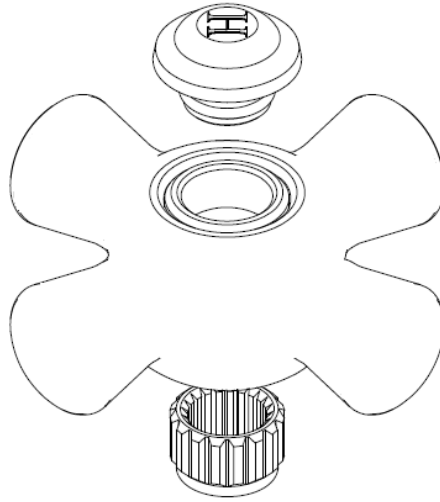

External
18

Internal

122420
Fits DELTA

External
18

Internal
22

1-4

129680
Fits AM STD

External
18

Internal
15

1-13

135120
Fits SAVOY

External
18

Internal
18

3-3

137990
Fits BRIGGS

External
18

Internal
16

1-6

138060
Fits CENTRAL

External
18

Internal
19

1-7

138130
Fits KOHLER

External
18

Internal
15

3-27

138270
Fits WOLVERINE

External
18

Internal
20

2-4

139320
Fits SPEAKMAN

External
18

Internal
20

3-20

139390
Fits 20pt European

External
18

Internal
16

2-3

141000
Fits SAYCO

External
18

Internal
12

1-1

141070
Fits CRANE DIALEZE

External
18

Internal
16

1-5

141140
Fits STERLING

External
18

Internal
12

3-10

141280
Fits CRANE / UR

PORCELAIN HANDLE ADAPTERS

These inserts adapt to the OEM stem listed below the part number, and attaches with a set screw

For Price Pfister style replacement handles
See pg.148

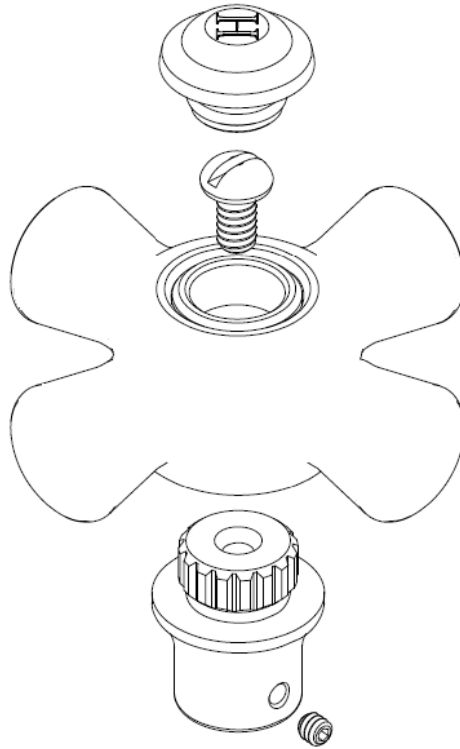

These adapters are also listed on pg.149

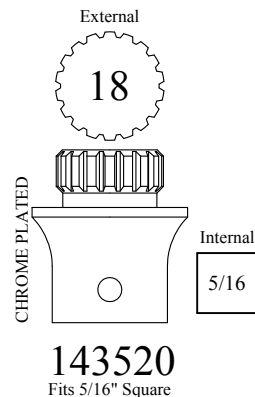
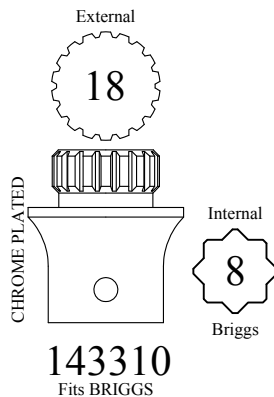
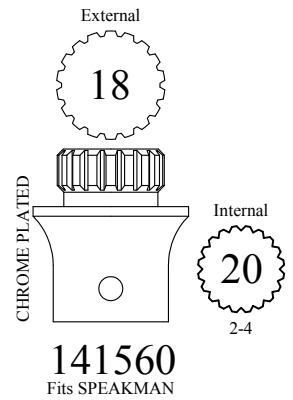
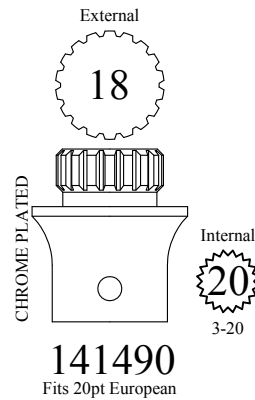
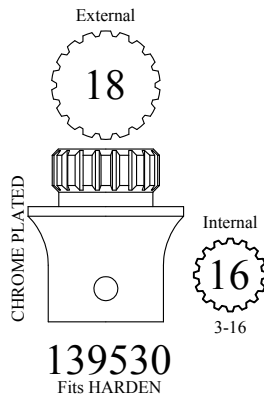
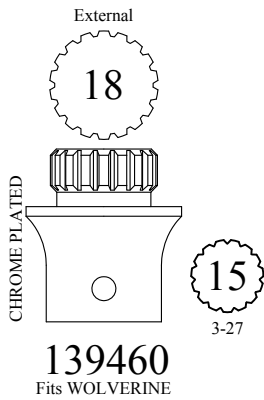

PORCELAIN HANDLE ADAPTERS

These inserts adapt to the OEM stem listed below the part number.
Does not use a set screw. Comes with appropriate long screw.

For Price Pfister style replacement handles
See pg.148

These adapters are also displayed on pg.149

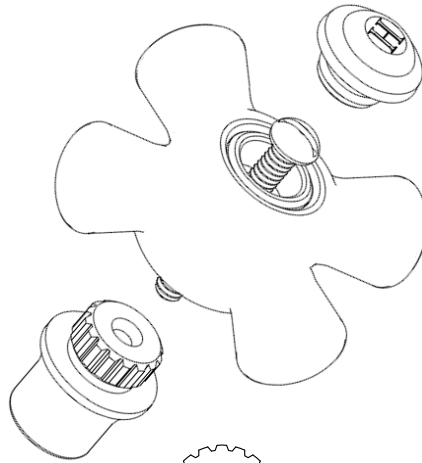

External
18

CHROME PLATED

Internal
5/16

102750
Fits 5/16" Square

External
18

CHROME PLATED

Internal

122140
Fits DELTA

External
18

CHROME PLATED

Internal
12
1-2

143590
Fits PRICE PFISTER

External
18

CHROME PLATED

Internal
18
3-3

143660
Fits BRIGGS

External
18

CHROME PLATED

Internal
22
1-4

143800
Fits AM STD

External
18

CHROME PLATED

Internal
16
1-6

143940
Fits CENTRAL

External
18

CHROME PLATED

Internal
15
1-13

144080
Fits SAVOY

External
18

CHROME PLATED

Internal
19
1-7

144430
Fits KOHLER

External
18

CHROME PLATED

Internal
20
2-4

144500
Fits SPEAKMAN

Also available in Polished Brass
144500-PB

External
12
1-2

FOR ARTISTIC BRASS
POLISHED BRASS

Internal
12
1-2

126830
Use with #135960 on pg.146

Also Available Chrome Plated
126830-CP

FOR ARTISTIC BRASS
CHROME PLATED

External
12
1-2

Internal
12
1-2

122210
Use with #135960 on pg.146

FOR ARTISTIC BRASS
CHROME PLATED

External
12
1-2

Internal
12
1-2

122280
Use with #135960 on pg.146

FOR AM STD CADET
CHROME PLATED

External
18

Internal
16
1-6

114240

FOR AM STD CADET
CHROME PLATED

External
18

Internal
16
1-6

116240

BARRY E.  WALTER SR. CO.

HANDLES

HOT & COLD INDEXED PORCELAIN HANDLES



Indexed Handle shown to the left attaches with a set screw

HOT	COLD	DIVERTER	FITS
101210	101280	126410	American Standard 7/16 22pt
101350	101420	125710	5/16 Square
102450	102590	104600	European 20pt
147090	147230	125780	Crane Pre-War 12pt
147440	147510	125850	Briggs Republic 8pt
147580	147790	125920	Briggs 18pt
148280	148350	125990	Central / Harden 16pt
105020	105160	105300	Price Pfister 12pt

***For polished brass, add -PB to the end of the part number. i.e. 101210-PB**

2 DIFFERENT STYLES OF INDEXED HANDLES.
CHOOSE WHAT WILL WORK WITH YOUR STEM.



Indexed Handles shown above attach with a handle nut

HOT	COLD	DIVERTER	FITS
101910	101980	126060	Speakman / Broadway 20pt
102050	102120	126130	Briggs 8pt
102190	102260	126200	Central / Harden 16pt
102330	102400	126270	Wolverine 15pt
102470	102540	126340	Savoy 15pt
110310	110380	104670	American Standard 22pt
110450	110520	104880	5/16 Square
128120	128190	128260	Kohler 19pt
148080	146130	146150	Price Pfister 12pt

***For polished brass, add -PB to the end of the part number. i.e. 101910-PB**

PORCELAIN CROSS HANDLES

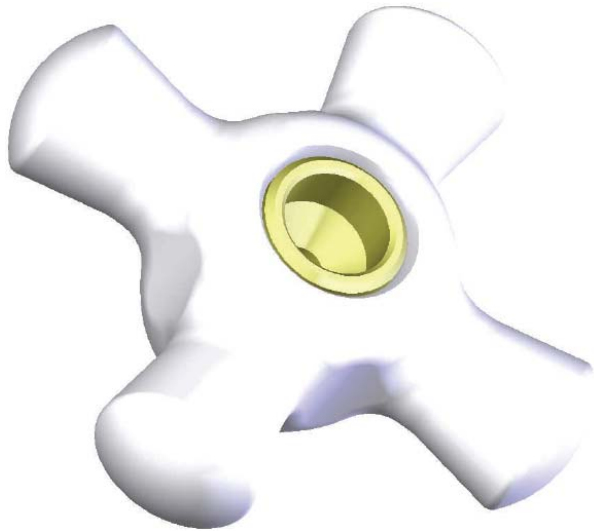

**Replacements for Price Pfister
#940-985 / 986 and #940-980 / 981**

Large - # 138620
Small - # 138550

Also Available:
Large w/ 3/8 12pt Broach - # 138480
Small w/ 3/8 12pt Broach - # 135960

**Replacement Porcelain
buttons for Price Pfister
#941-475, #941-476 and #941-477**

	Chrome Plated	Polished Brass
Cold	139670	139670-PB
Hot	139740	139740-PB
Arrow	139810	139810-PB



**Solid brass inserts convert the OEM or Walter
Equivalent Porcelain handles for any of these stems:**

- # 122420 - Adapts to Delta 'D' broach
- # 129680 - Adapts to American Standard 7/16 22pt
- # 135120 - Adapts to Savoy 15pt
- # 137990 - Adapts to Briggs 18pt
- # 138060 - Adapts to Central / Harden 16pt
- # 138130 - Adapts to Kohler 19pt
- # 138270 - Adapts to Wolverine 15pt
- # 139320 - Adapts to Speakman 20pt
- # 139390 - Adapts to European 20pt
- # 141000 - Adapts to Sayco / Gerber 16pt
- # 141070 - Adapts to Crane Dial-Eze 12pt
- # 141140 - Adapts to Sterling 16pt
- # 141280 - Adapts to Crane / Universal Rundle 12pt

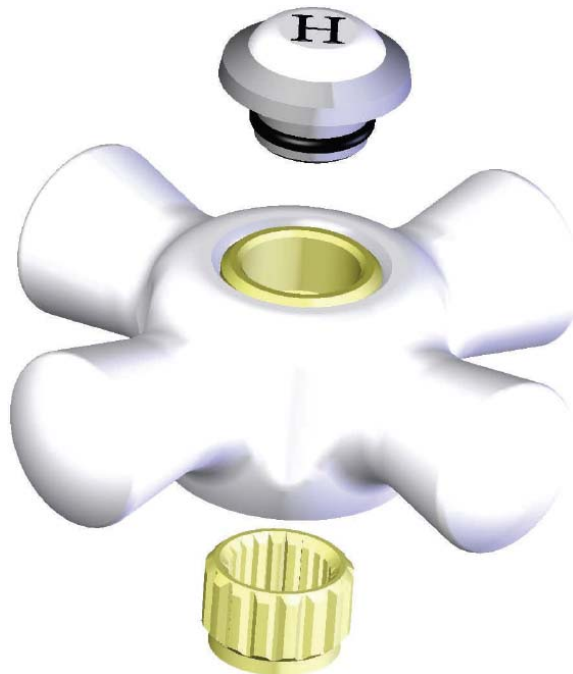

**These adapters are also
pictured on pg.142**

**Use the basic Solid Brass insert to adapt to any of the
listed broaches OR turn those handles into a classic
look with the Old Style Chrome Plated inserts listed on
the next page.**

Old Style Chrome Plated Solid Brass Inserts for Porcelain Cross Handles

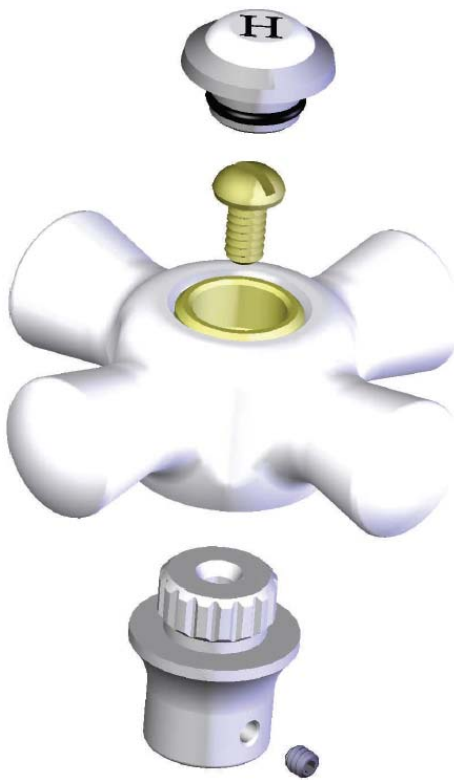

This insert adapts to OEM listed below and attaches with a set screw.

- # 139460 - Adapts to Wolverine 15pt
- # 139530 - Adapts to Harden 16pt
- # 141490 - Adapts to European 20pt
- # 141560 - Adapts to Speakman 20pt
- # 143310 - Adapts to Briggs Republic 8pt
- # 143520 - Adapts to 5/16 Square

These adapters are also pictured on pg.143

Exploded view with Old Style Insert, supplied with set screw to attach to the stem. A screw is supplied to attach the handle to the insert.

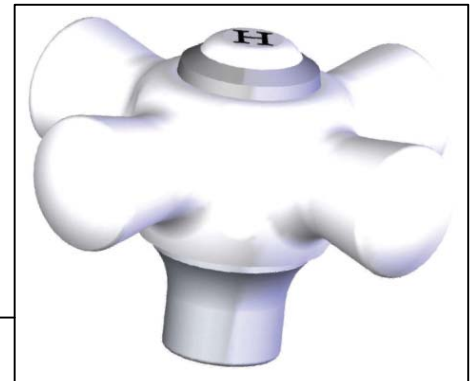

This insert adapts to OEM listed below without set screw. Long screw included.

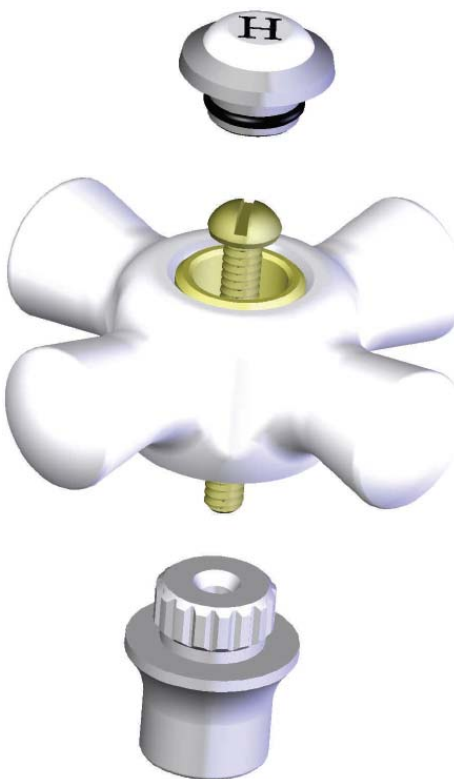

- # 102750 - Adapts to Chicago Square
- # 122140 - Adapts to Delta 'D' broach
- # 143590 - Adapts to Price Pfister 12pt
- # 143660 - Adapts to Briggs 18pt
- # 143800 - Adapts to American Standard 7/16 22pt
- # 143940 - Adapts to Central 16pt
- # 144080 - Adapts to Savoy 15pt
- # 144430 - Adapts to Kohler 19pt
- # 144500 - Adapts to Speakman 20pt
- # 114240 - Adapts to American Standard Cadet 1-9/16" long
- # 116240 - Adapts to American Standard Cadet 2" long

Use Handles with 12pt PP broach. #138480 or #135960 on pg.146

- # 126830 - Adapts to Artistic Brass
- # 122210 - Adapts to Artistic Brass
- # 122280 - Adapts to Artistic Brass

These adapters are also pictured on pg.144

Exploded view with Old Style Insert, supplied with long screw to attach handle, insert and stem together.



BROADWAY TRIM

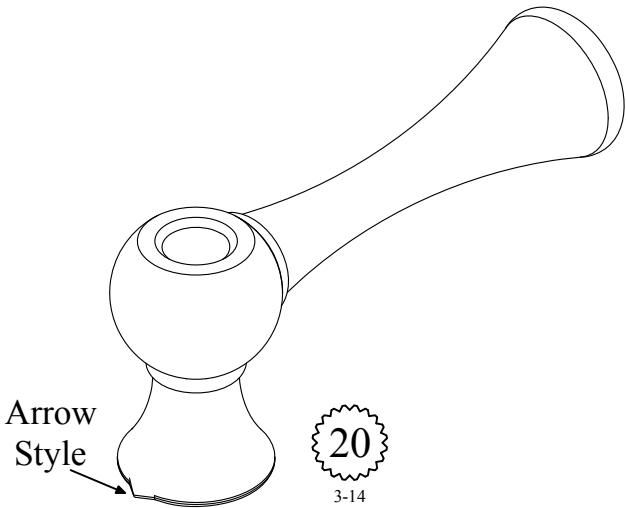

108210-PB	Polished Brass
108210-CP	Chrome Plated

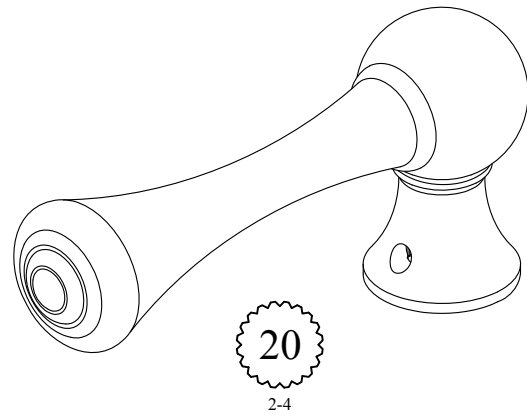

109610-PB	Polished Brass
109610-CP	Chrome Plated

Clip & Handle Nut Included with Handle
109680-PB & 109680-CP

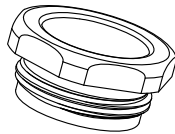
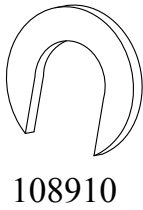

116540-PB	Polished Brass
116540-CP	Chrome Plated

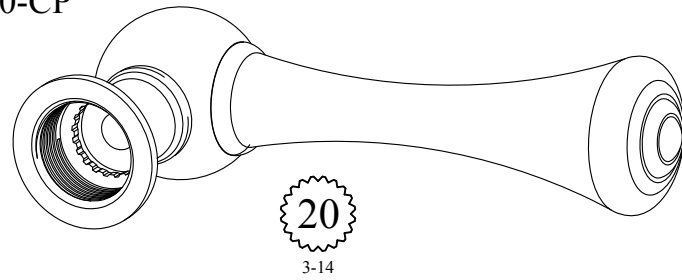

109680-PB	Polished Brass
109680-CP	Chrome Plated

Flange Ring

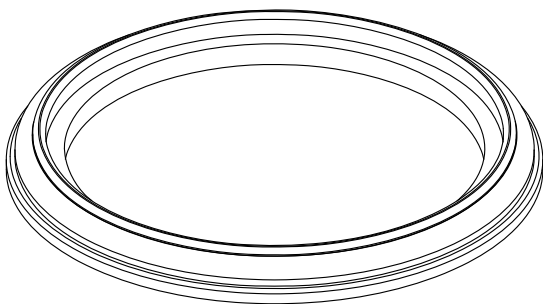

110730-PB	Polished Brass
110730-CP	Chrome Plated

Flange

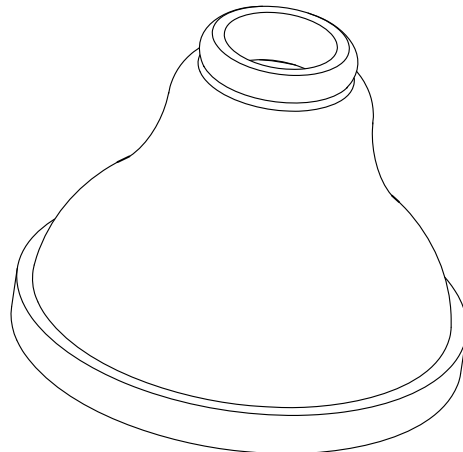

110660-PB	Polished Brass
110660-CP	Chrome Plated

MISC. HANDLES

FOR SPHINX
HANDLE KNOB

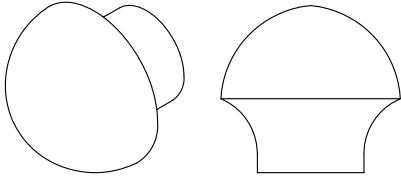

178320 Chrome Plated

FOR MUELLER
DIVERter KNOB

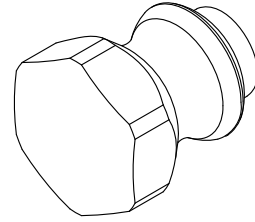

138200 Chrome Plated

FOR AM STD
INDEXED HANDLE SCREW

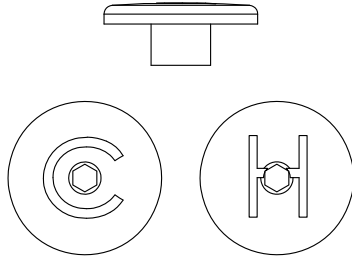

148720 Cold
149280 Hot
Chrome Plated

FOR KOHLER
PUSH-PULL
DIVERter KNOB

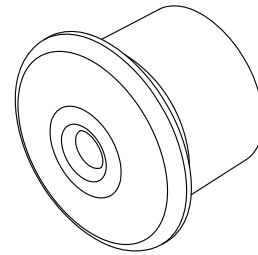

116850 Chrome Plated

FOR KOHLER
PUSH-PULL
DIVERter KNOB

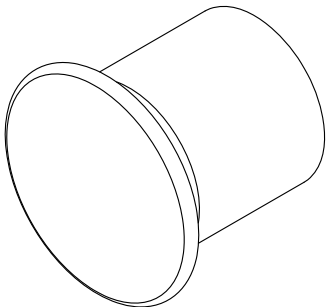

117550 Chrome Plated

FOR CONCINNITY
DIVERter HANDLE
WITH STOP

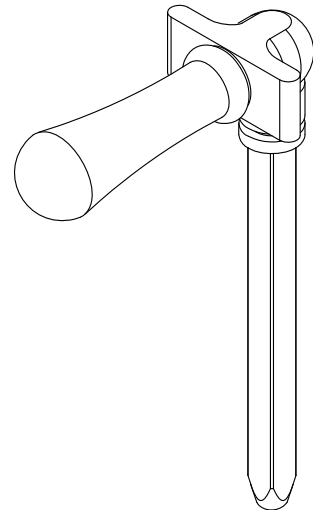

119650-CP Chrome Plated

MISC. HANDLES

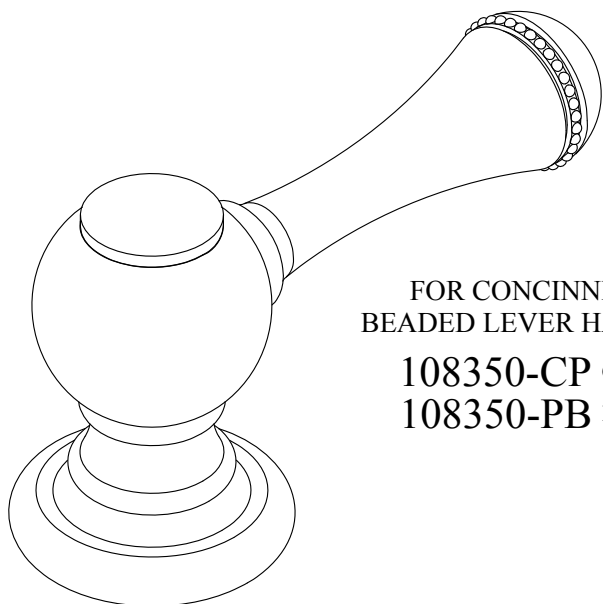

FOR CONCINNITY
BEADED LEVER HANDLE

108350-CP Chrome Plated

108350-PB Polished Brass

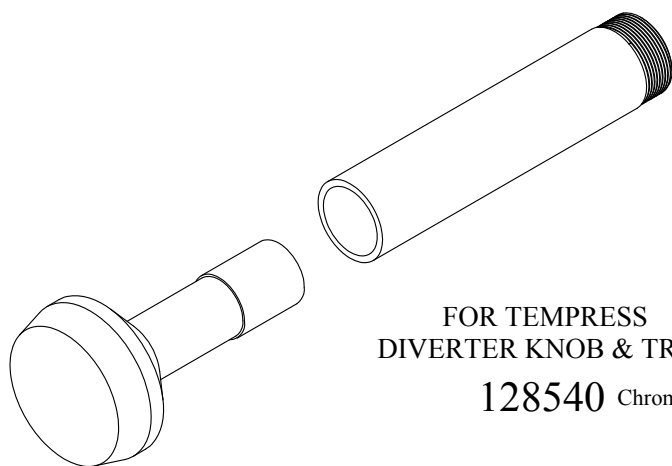

FOR TEMPRESS
DIVERTER KNOB & TRIM

128540 Chrome Plated

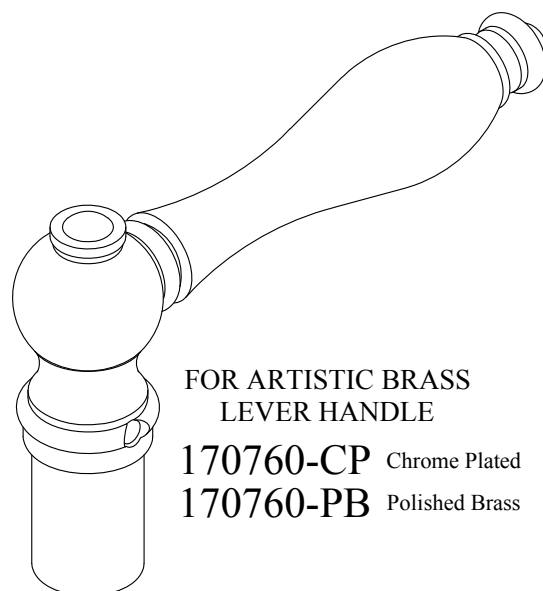

FOR ARTISTIC BRASS
LEVER HANDLE

170760-CP Chrome Plated

170760-PB Polished Brass

BARRY E.  SR. CO.

NIPPLES

THREADED EXTENSIONS

ESCUTCHEON ADAPTERS

ESCUTCHEON EXTENSIONS

ESCUTCHEON HOLDERS

ESCUTCHEON TUBES

ESCUTCHEONS

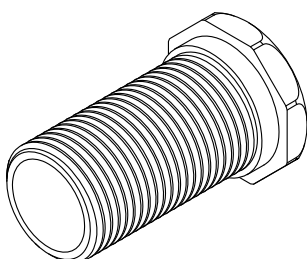
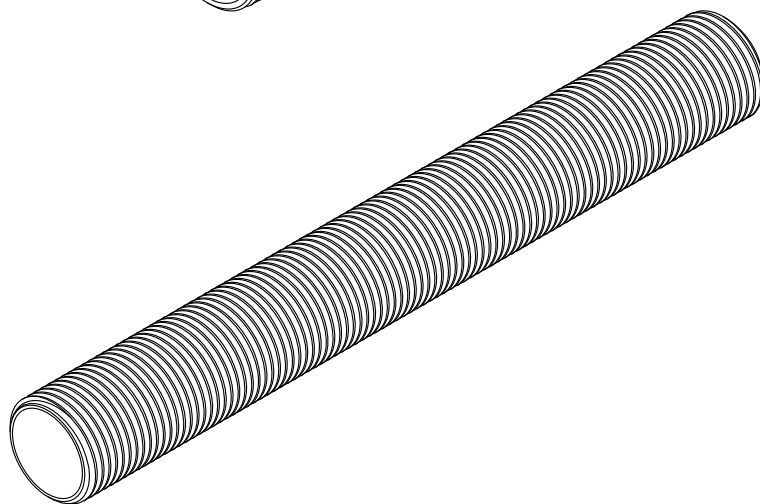
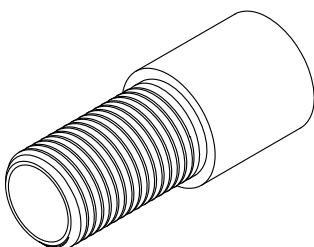
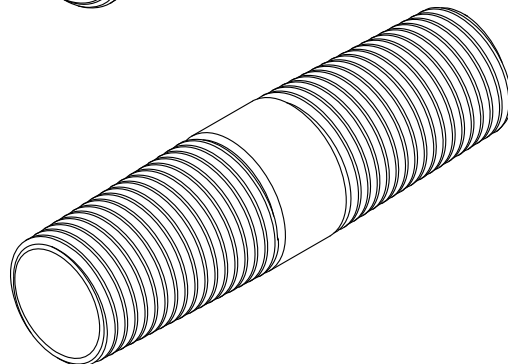
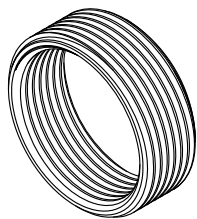
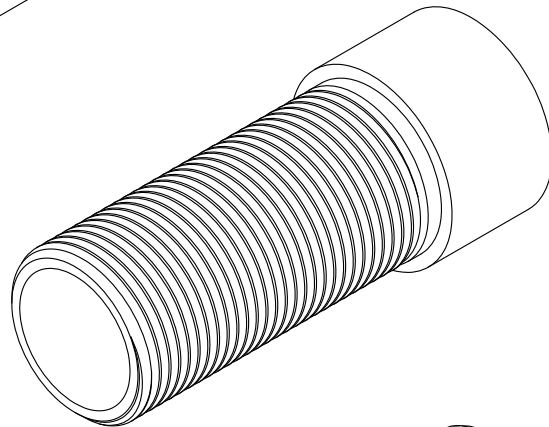
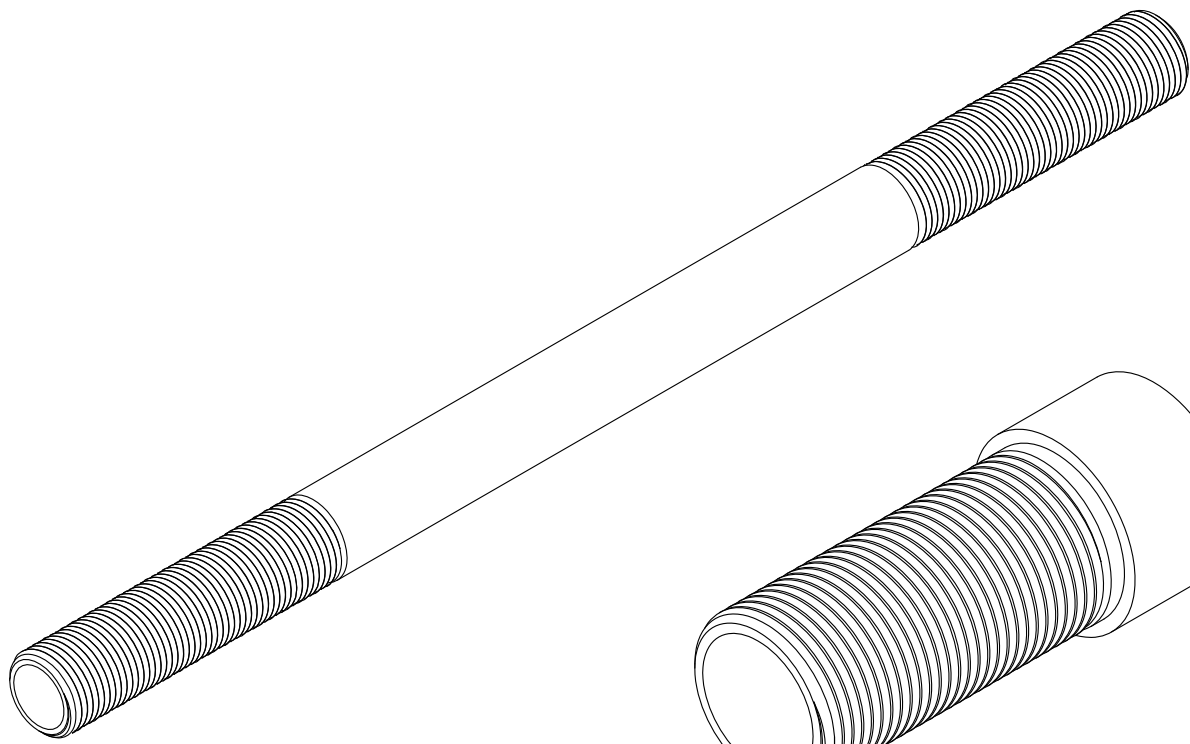

NIPPLES & THREADED EXTENSIONS

ESCUTCHEONS NIPPLES

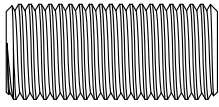

1/2-19

150750	1.10"
--------	-------

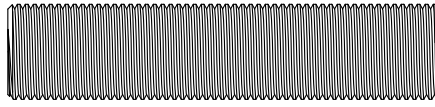

1/2-24

101240	0.50"	160960	2.25"
140090	0.75"	170340	2.50"

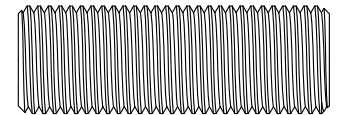

9/16-18

159150	1.62"
161030	2.25"

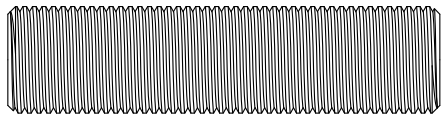

9/16-20

107980	0.56"	108260	2.00"
198460	0.625"	159920	2.25"
198250	0.75"	198040	2.56"
107700	0.875"	153050	3.00"
116820	1.00"	132500	3.687"
158660	1.25"	144030	3.80"
166500	1.50"	132950	4.00"
159290	1.75"	161810	6.00"
113250	1.875"	158800	12.00"

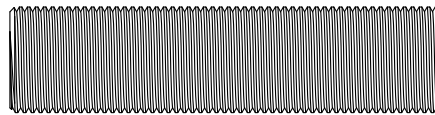

9/16-24

982610	1.62"
161100	2.25"
159220	2.625"
158870	12.00"

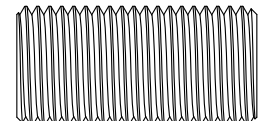

5/8-16

117150	0.875"
171530	1.25"
159080	2.00"
158940	12.00"

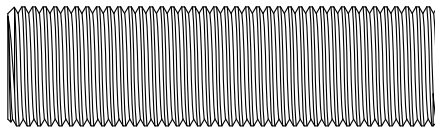

5/8-18

w/ .515 hole thru

159500	1.25"
164050	1.75"
159360	2.25"
160890	3.50"
134280	5.00"

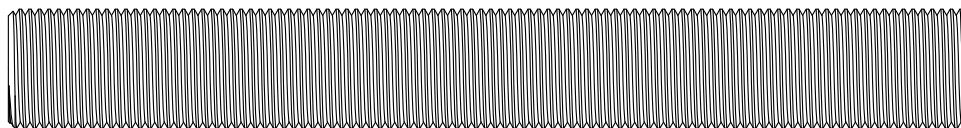

5/8-20

134350	5.00"
--------	-------

NIPPLES & THREADED EXTENSIONS

ESCUTCHEONS NIPPLES

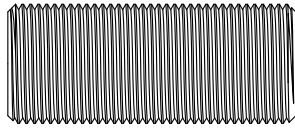

5/8-24

167900	1.187"	197970	2.375"
143050	1.375"	176990	2.687"
192580	1.50"	192510	3.00"
196850	2.00"	131310	6.00"
159430	2.25"	148790	12.00"

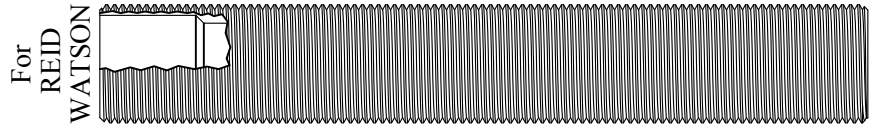

5/8-24

128210	4.00"
--------	-------

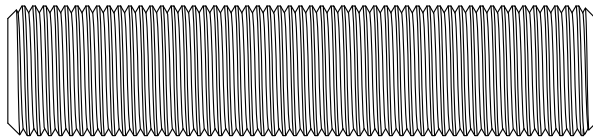

11/16-18

148230	3.062"
--------	--------

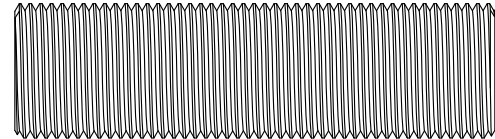

.700-18

133230	2.50"
--------	-------

STEP NIPPLES

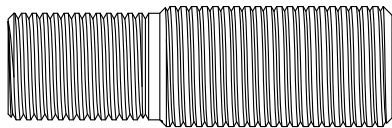

9/16-18 x 21/32-18

982140	2.00"
--------	-------

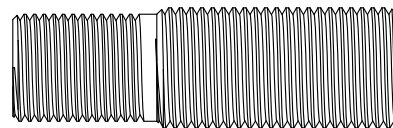

9/16-20 x 21/32-18

982120	2.00"
--------	-------

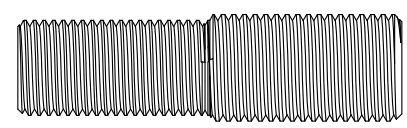

1/2-24 x 9/16-20

108050	2.00"
--------	-------

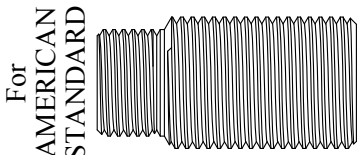

9/16-20 x .700-18

189940*	1.35"
147810	1.85"
*OEM# 1166-05	

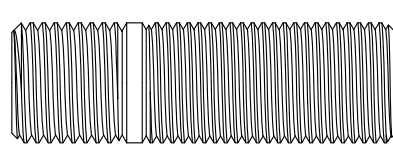

5/8-16 x 21/32-18

982150	2.00"
--------	-------

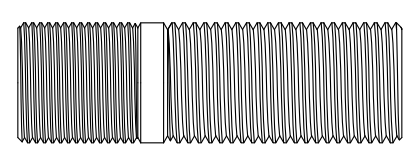

5/8-24 x 21/32-18

982130	2.00"
105860	4.35"

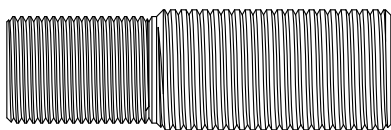

9/16-24 x 21/32-18

982110	2.00"
--------	-------

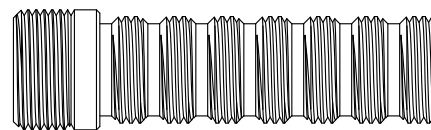

5/8-24 x 9/16-20

150190	1.65"
105860	2.20"

NIPPLES & THREADED EXTENSIONS

FIT-ALL NIPPLES

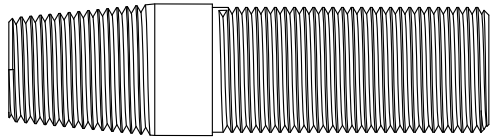

3/8-18 NPS x 18 TPI
TAPERED

140650	2.50"
--------	-------

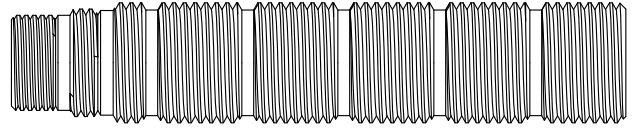

5/8-18 x 9/16-20 x 1/2-24
SOLID BRASS

113420	3.20"
--------	-------

ADAPTER NIPPLES

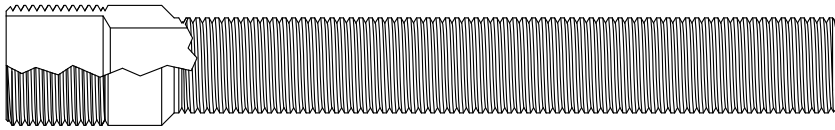

All 4.32" in length

Slips over stem extensions found on p.132-133

105720	5/8-24 x 1/2-24
105790	5/8-24 x 9/16-20
105860	5/8-24 x 5/8-18
105930	5/8-24 x 11/16-24
106280	5/8-24 x 5/8-24

NIPPLE EXTENSION ADAPTER

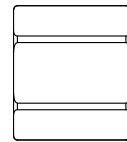

9/16-20 x 9/16-20

611270	0.60"
--------	-------

NIPPLE EXTENSIONS

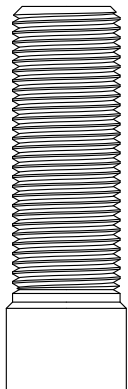

9/16-20

118320	0.875"
135260	2.00"
106000	3.00"

FOR BROADWAY / SPEAKMAN

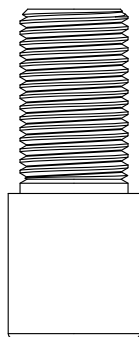

9/16-18

641300	1.715"
641310	2.215"

FOR KOHLER

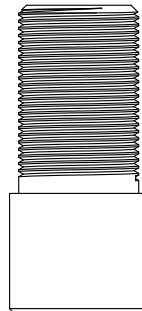

5/8-27

641340	1.60"
--------	-------

FOR PRICE PFISTER

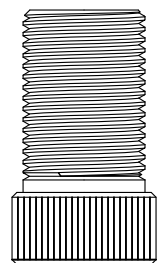

21/32-18

641330	1.325"
PP OEM# 973-090	

Nickel Plated

NIPPLES & THREADED EXTENSIONS

DRINKING FOUNTAIN NIPPLES

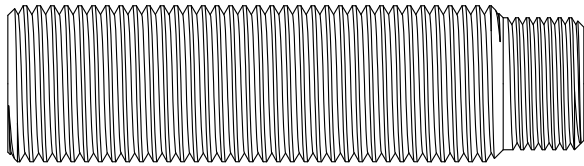

1/2-14 NPS x 3/8-18 NPT

LF641260	3.00"
LF641270	4.00"

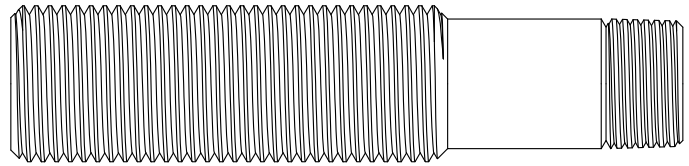

1/2-14 NPS x 3/8-18 NPT

128840	3.50"	Stainless Steel
LF641280	3.50"	
LF641290	4.50"	

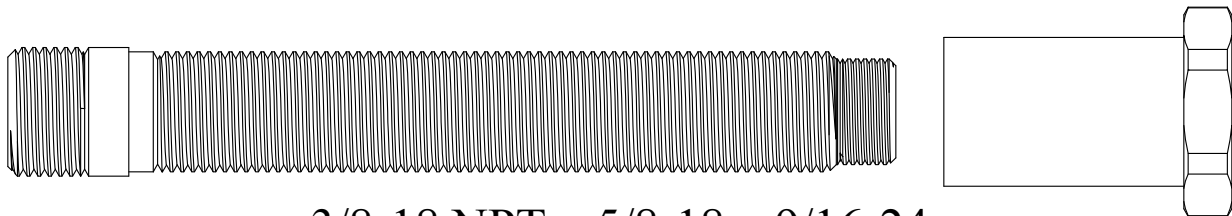

3/8-18 NPT x 5/8-18 x 9/16-24

LF184420	4.625"
----------	--------

DRINKING FOUNTAIN NIPPLE WITH NUT KIT

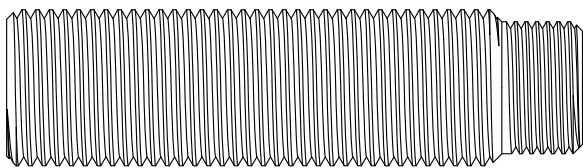

1/2-14 NPS x 3/8-18 NPT

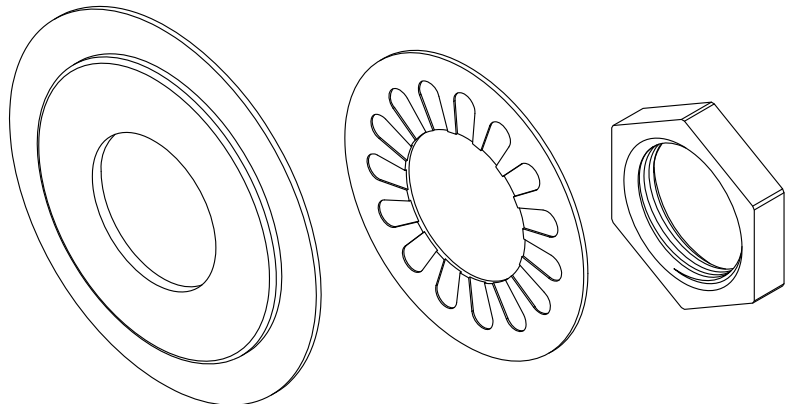

LF116430

DRINKING FOUNTAIN FLANGE & SHANK KIT

NIPPLES & THREADED EXTENSIONS

PIPE NIPPLES

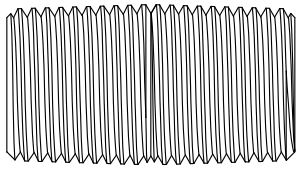

1/2-14 NPT x 1/2-14 NPT

LF111880	1.50"
----------	-------

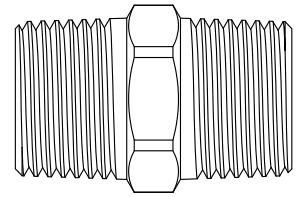

1/2-14 NPT x 1/2-14 NPT

LF134040	1.44"
----------	-------

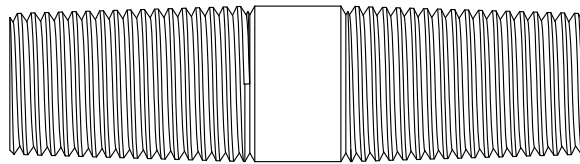

1/2-14 NPT x 1/2-14 NPT

LF119790	3.00"
----------	-------

SPOUT NIPPLES

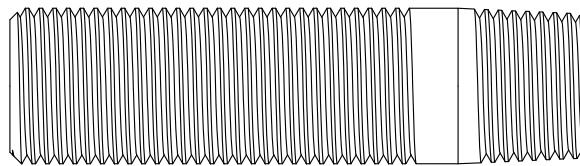

1/2-14 NPS x 1/2-14 NPT

LF138640	3.00"
LF105620	4.00"

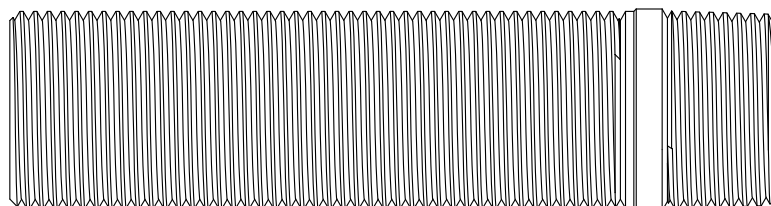

3/4-14 NPS x 3/4-14 NPT

102820	4.00"
--------	-------

NIPPLES & THREADED EXTENSIONS

SPOUT TUBES

FOR P.E. GUERIN



1/2-18 x 1/2-24

LF156350 5.365"

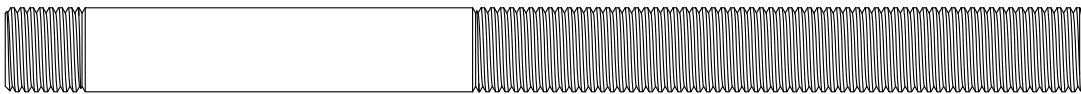

7/16-20 x 7/16-20

LF118970 5.625"

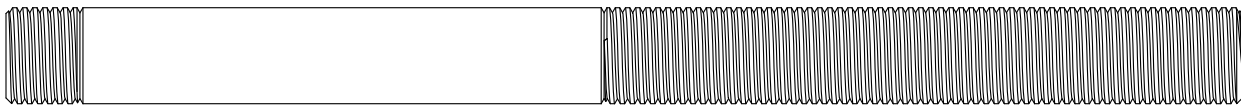

33/64-19 x 33/64-19

LF132410 6.44"

FOR AUBURN



7/16-20 x 1/8-27 NPT

LF198810 6.53"

FOR ARTISTIC BRASS



7/16-20 x 7/16-20

LF117080 6.80"

NIPPLES & THREADED EXTENSIONS

SPOUT TUBES

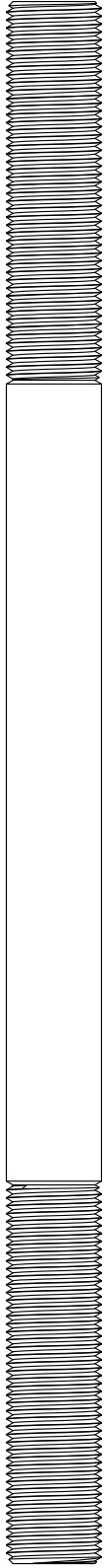

1/2-24 x 1/2-24

LF131570 | 8.25"



25/64-27 x 25/64-27

LF132460 | 8.625"

FOR CONCINITY

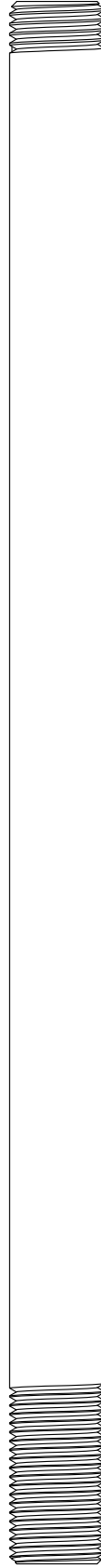

1/4-18 NPT X 17/32-20

LF142090 | 8.75"

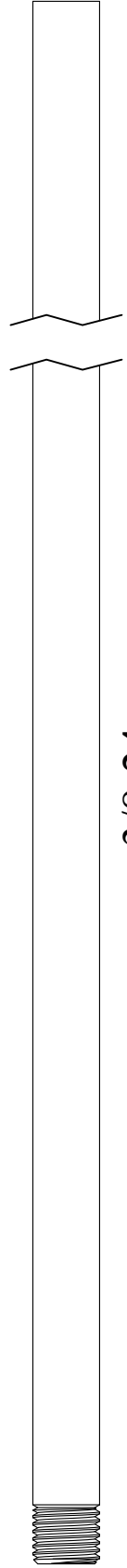

3/8-24

LF132480 | 9.625"

NIPPLES & THREADED EXTENSIONS

SHANK EXTENDERS

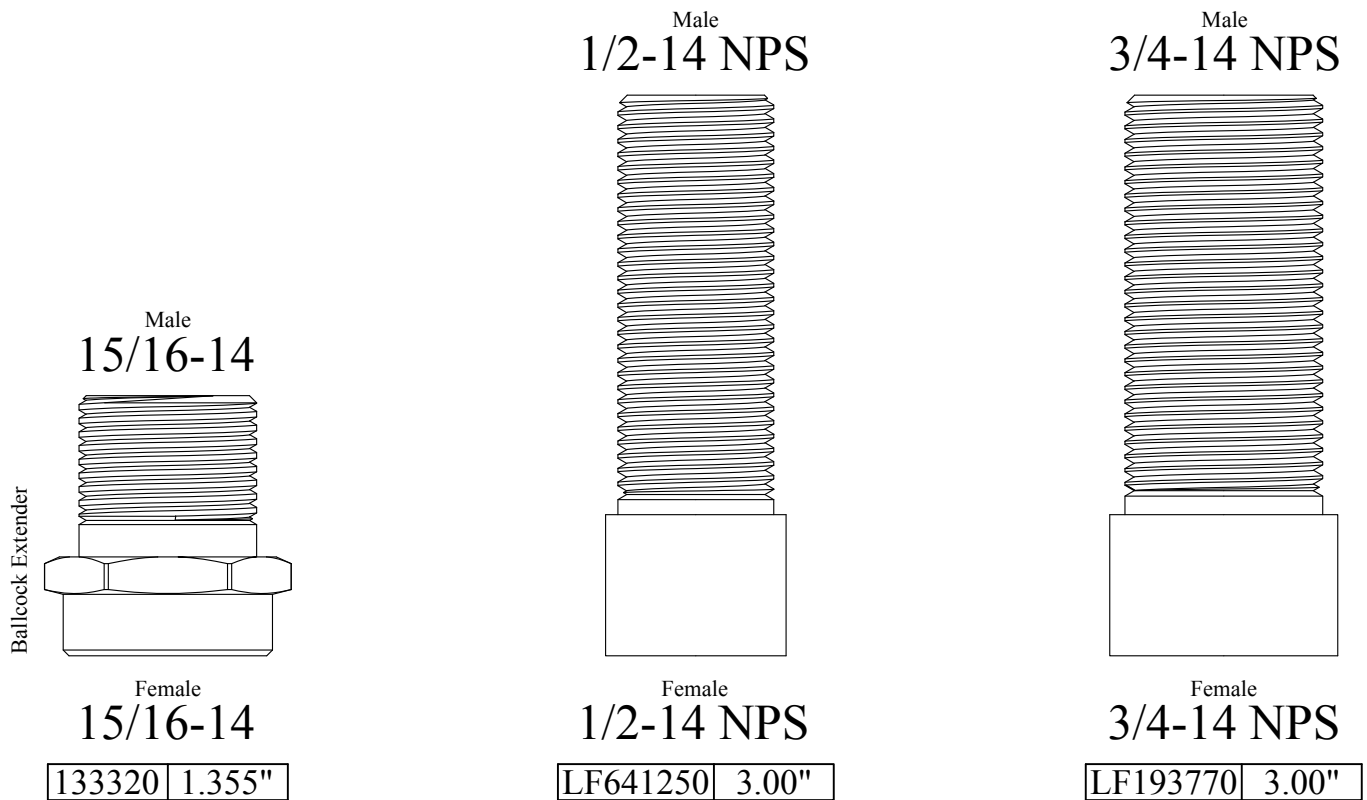

Send Your Orders To:

BARRY E.  SR. CO.

E-mail: orderdesk@barrywalter.com

Fax: 1.800.886.9831

Phone: 1.800.767.5552

ESCUTCHEON ADAPTERS

FOR STERLING

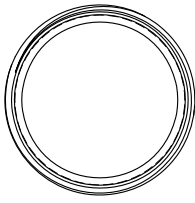

FOR 402411 & 430181



INTERNAL THREAD: 7/8 - 14 TPI
EXTERNAL THREAD: 1" - 20 TPI

124410

FOR PRICE PFISTER

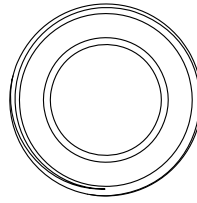

INTERNAL THREAD: 21/32 - 18 TPI
EXTERNAL THREAD: 1" - 18 TPI

641020

FOR SAYCO

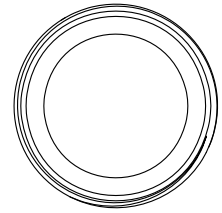

EXTERNAL THREAD: 1-1/16 - 20 TPI

907200

Also available with gasket 895100
149070

FOR STERLING

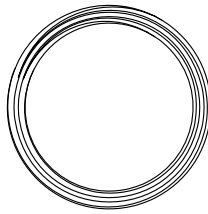

FOR 401111 & 401112

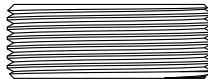

INTERNAL THREAD: 15/16 - 20 TPI
EXTERNAL THREAD: 1-1/16 - 20 TPI

183720

FOR HARCRAFT

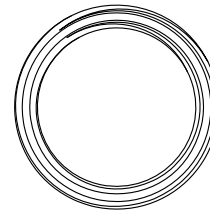

INTERNAL THREAD: 7/8 - 20 TPI
EXTERNAL THREAD: 1-1/16 - 20 TPI

113720

FOR MILWAUKEE

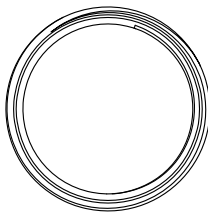

INTERNAL THREAD: 15/16 - 18 TPI
EXTERNAL THREAD: 1-1/16 - 20 TPI

113860

FOR SAYCO

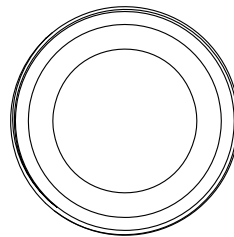

EXTERNAL THREAD: 1-3/16 - 26 TPI

909600

Also available with 1" Top Gasket
147670

FOR KOHLER

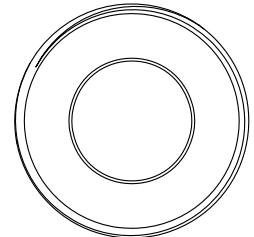

INTERNAL THREAD: 5/8 - 16 TPI
EXTERNAL THREAD: 1-7/32 - 18 TPI

115470

FOR KOHLER SHOREMAN
TO PRICE PFISTER

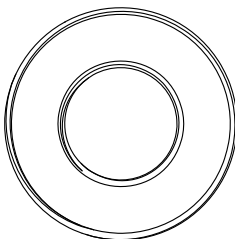

INTERNAL THREAD: 5/8 - 27 TPI
EXTERNAL THREAD: 1-7/32 - 18 TPI

178740

FOR PRICE PFISTER

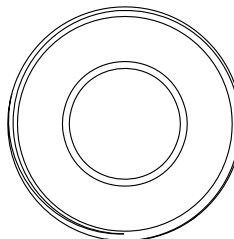

INTERNAL THREAD: 21/32 - 18 TPI
EXTERNAL THREAD: 1-7/32 - 18 TPI

641010

FOR AM STD
TO PRICE PFISTER

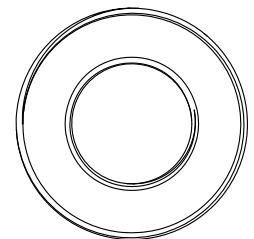

INTERNAL THREAD: 21/32 - 32 TPI
EXTERNAL THREAD: 1-7/32 - 18 TPI

176780

ESCUTCHEON ADAPTERS

FOR SAYCO
TO PRICE PFISTER

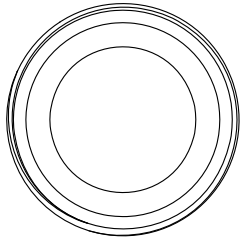

EXTERNAL THREAD: 1-7/32 - 18 TPI

171040

FOR HARCRAFT

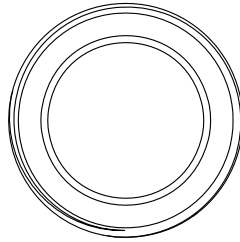

INTERNAL THREAD: 13/16 - 18 TPI
EXTERNAL THREAD: 1-7/32 - 18 TPI

641040

FOR STERLING
TO PRICE PFISTER

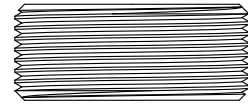
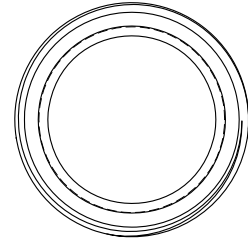

INTERNAL THREAD: 7/8 - 14 TPI
EXTERNAL THREAD: 1-7/32 - 18 TPI

122910

FOR PRICE PFISTER

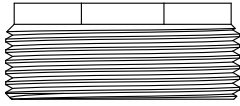
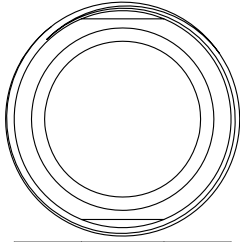

INTERNAL THREAD: 7/8 - 18 TPI
EXTERNAL THREAD: 1-7/32 - 18 TPI

125270

FOR ELJER TO
PRICE PFISTER

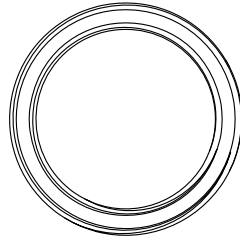

INTERNAL THREAD: 15/16 - 20 TPI
EXTERNAL THREAD: 1-7/32 - 18 TPI

178670

FOR PRICE PFISTER

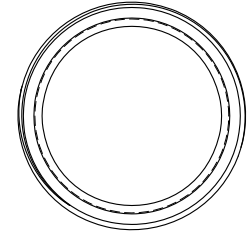

INTERNAL THREAD: 1" - 20 TPI
EXTERNAL THREAD: 1-7/32 - 18 TPI

641030

FOR AM STD

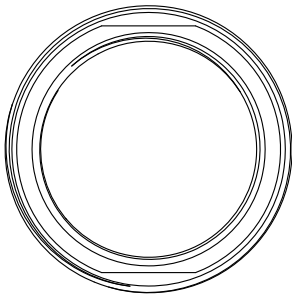

INTERNAL THREAD: 1-1/2 - 24
EXTERNAL THREAD: 1-1/8 - 24

25173-04

Chrome Plated

FOR SIGMA

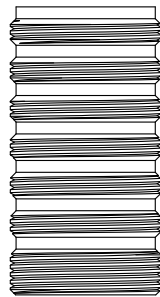

INTERNAL THREAD: M17 X 1.25
EXTERNAL THREAD: M20 X 1.00

129030

UNKNOWN

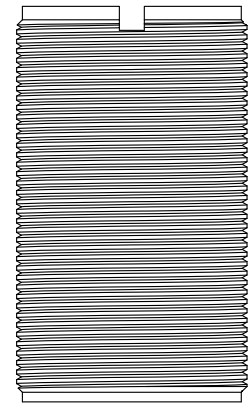

INTERNAL THREAD: M27 x 1.25
EXTERNAL THREAD: M31 x 1.25

131150

ESCUTCHEON ADAPTERS

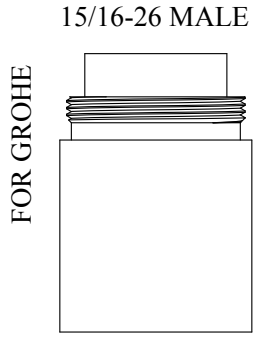

15/16-26 MALE

7/8-26 FEMALE

151310

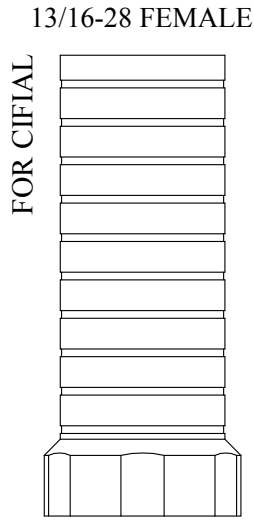

13/16-28 FEMALE

M24 x 1.00 FEMALE

156140

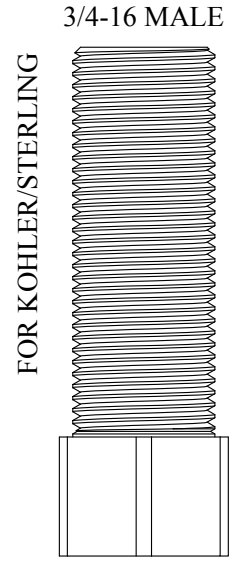

3/4-16 MALE

5/8-27 FEMALE

119040

All Plastic Part

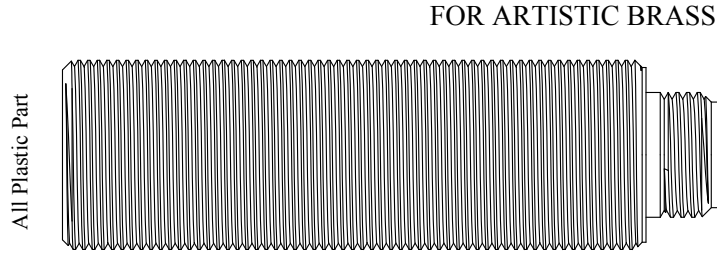

All Plastic Part

63/64-20 x 21/32-18

112460

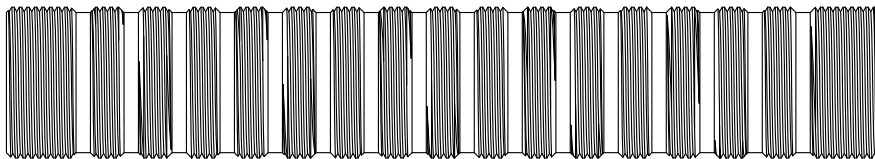

M20 X 1.00 MALE X M17 X 1.00 FEMALE

127840

ESCUTCHEON ADAPTERS

5/8-24 FEMALE

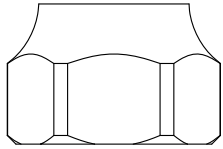

M24 X 1.00 FEMALE

105580

FOR CONCINNY

9/16-20 FEMALE

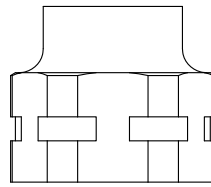

M24 X 1.00 FEMALE

103170

FOR HARCRAFT

3/8-18 FEMALE

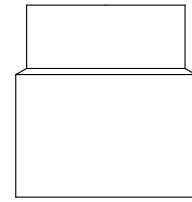

7/8-20 FEMALE

152630

FIT-ALL

21/32-18 FEMALE

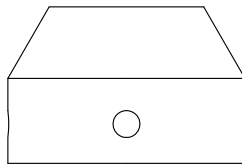

141700

FOR MILWAUKEE

M12-1.00 FEMALE

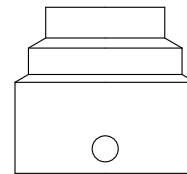

124940

FOR SAYCO TO
TO PRICE PFISTER

1"-20 MALE

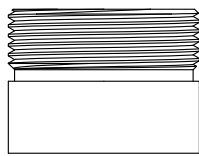

7/16-20 FEMALE

101170

FOR REID WATSON

9/16-20 FEMALE

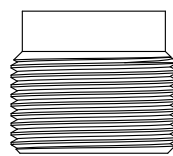

7/8-20 MALE

602660

FOR PRICE PFISTER

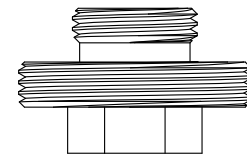

1-7/32-18 x 3/8-18 NPS

125340

ESCUTCHEON EXTENSIONS

FOR SAVOY

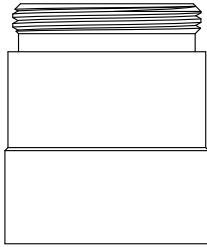

INTERNAL THREAD: 1" - 20
EXTERNAL THREAD: 1" - 20

119830

FOR GROHE

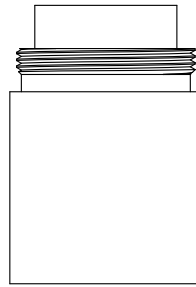

INTERNAL THREAD: M24 X 1.00
EXTERNAL THREAD: M24 X 1.00

151310

FOR AM STD AZIMUTH

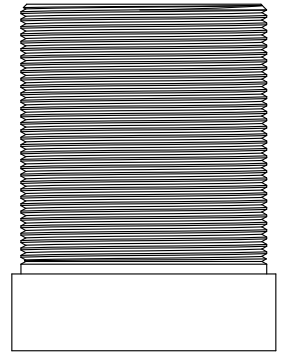

INTERNAL THREAD: 1-9/32 - 26
EXTERNAL THREAD: 1-9/32 - 26

174120

FOR AM STD CADET

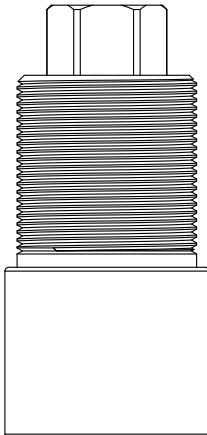

INTERNAL THREAD: 15/16 - 24
EXTERNAL THREAD: 15/16 - 24

129540

FOR KOHLER

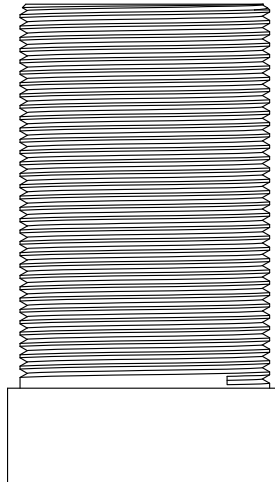

INTERNAL THREAD: M33 X 1.50
EXTERNAL THREAD: M33 X 1.50

151440

WATERWORKS

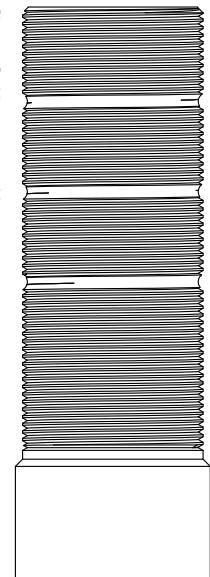

INTERNAL THREAD: M24 X 1.00
EXTERNAL THREAD: M24 X 1.00

127350

FOR DORNBRACHT

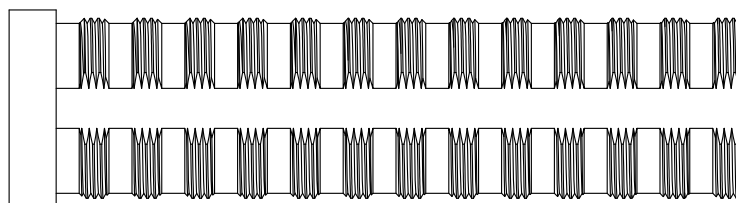

INTERNAL THREAD: M24 X 1.00
EXTERNAL THREAD: M24 X 1.00

125080

ESCUTCHEON HOLDERS

FOR GERBER

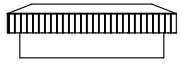

Chrome Plated

5/8 - 24
941120

FOR SAYCO



Chrome Plated

11/16 - 24
941160

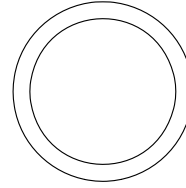

Nickel Plated

INTERNAL DIA.:
3/4"
136120

FOR AM STD

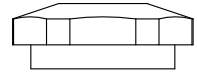

Chrome Plated

9/16 - 20
941130

FOR REPCAL



Chrome Plated

5/8 - 18
941190

FOR REPCAL

For Integral Stop
No hole through



Chrome Plated

5/8 - 20
941200

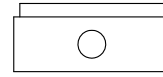
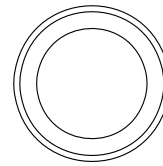

Nickel Plated

INTERNAL DIA.:
9/16"
103360

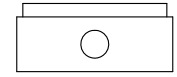
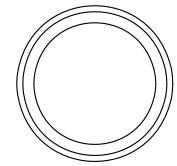

Nickel Plated

INTERNAL DIA.:
5/8"
111060

FOR CENTRAL

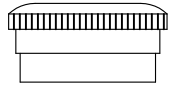

Chrome Plated

9/16 - 20
941210

FOR SPEAKMAN

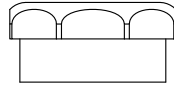

9/16 - 18
110010

FOR LOGAN

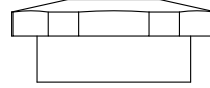

Chrome Plated

9/16 - 20
941180

FOR PRICE PFISTER

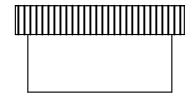

Chrome Plated

21/32 - 18
941100

FOR BRIGGS

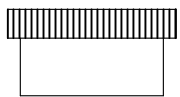

Chrome Plated

5/8 - 24
941110

FOR ELJER



Chrome Plated

9/16 - 24
941140

FOR SPEAKMAN
& CRANE

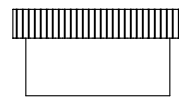

Chrome Plated

9/16 - 18
941170

FOR PRICE PFISTER

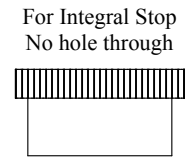

Chrome Plated

For Integral Stop
No hole through
21/32 - 18
941220

ESCUTCHEON HOLDERS

FOR CHICAGO

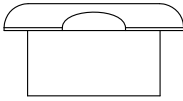

Chrome Plated

5/8 - 20
941290

FOR GLAUBER

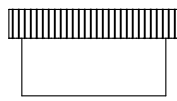

Chrome Plated

5/8 - 20
941230

FIT-ALL

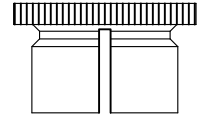

Chrome Plated

1/2 - 18 X 9/16 - 18
116290

FOR KOHLER

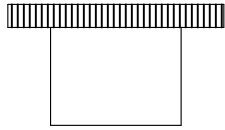

Chrome Plated

5/8 - 16
941150

FOR AUBURN

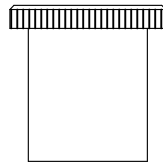

Chrome Plated

1/2 - 24
189730

FOR SPEAKMAN

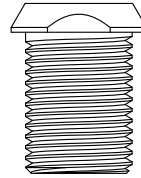

Chrome Plated

9/16 - 18
143380

FOR CRANE
PRE-WAR

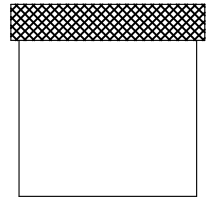

Chrome Plated

7/8 - 16
941250

FOR SPEAKMAN

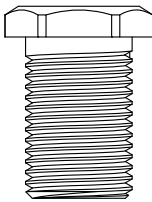

Chrome Plated

EXTERNAL THREAD:
9/16 - 18 TPI
941260

FOR SPEAKMAN

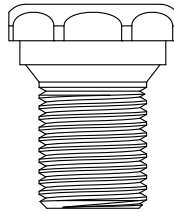

Chrome Plated

EXTERNAL THREAD:
9/16 - 18 TPI
941280

FOR SPEAKMAN

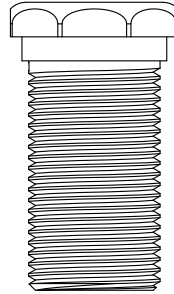

Chrome Plated

EXTERNAL THREAD:
11/16 - 18 TPI
941240

FOR SPEAKMAN/
BROADWAY

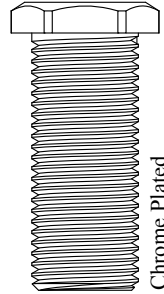

Chrome Plated

EXTERNAL THREAD:
9/16 - 18 TPI
941270

Also available in polished brass
941270-PB

FOR SPEAKMAN/
BROADWAY



Also available with in polished brass

108120-PB

9/16 - 18
108120

ESCUTCHEON TUBES

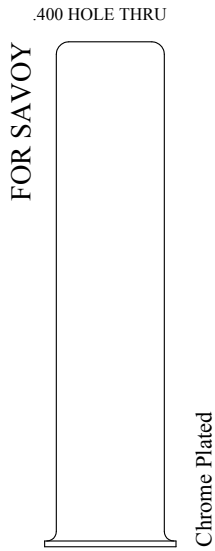

912800

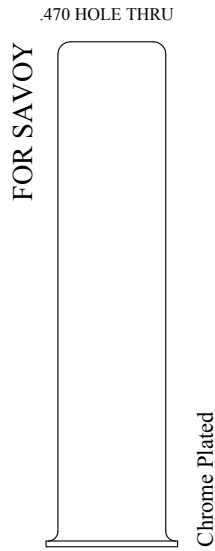

922710

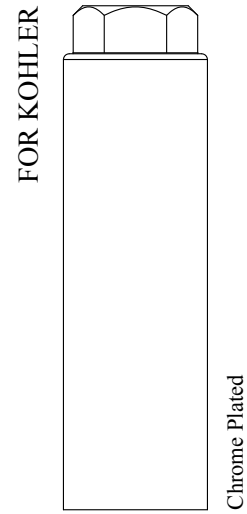

5/8 - 27 FEMALE

111460

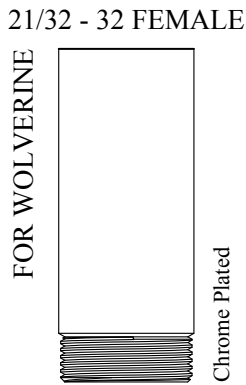

11/16 - 27 MALE

907900

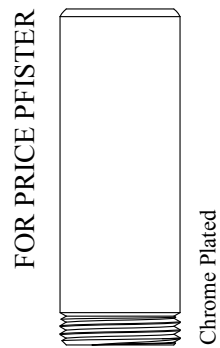

3/8 - 18 NPS MALE

912900

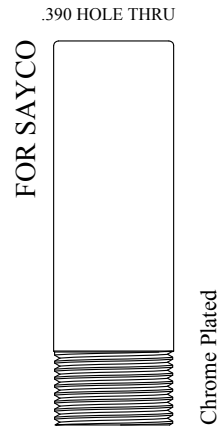

5/8 - 24 MALE

909800

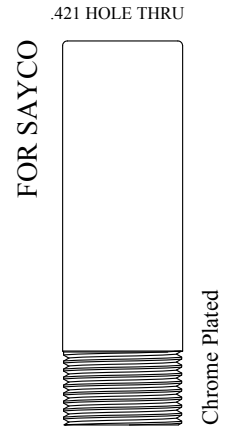

5/8 - 24 MALE

924410

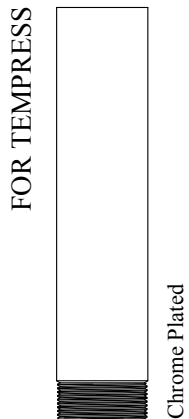

M12 x 0.5 MALE

128610

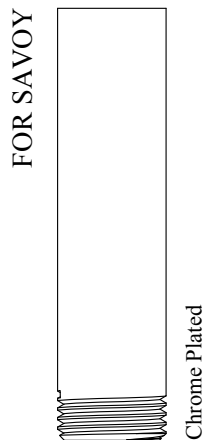

9/16 - 20 MALE

108630

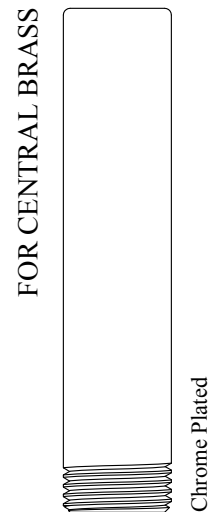

9/16 - 20 MALE

167340

ESCUTCHEON TUBES

FOR ELJER

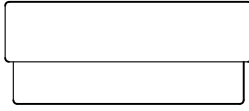

Chrome Plated

1-1/8 - 20 FEMALE

119390

FOR CRANE



Chrome Plated

1-5/16 - 16 FEMALE

143070

FOR CRANE

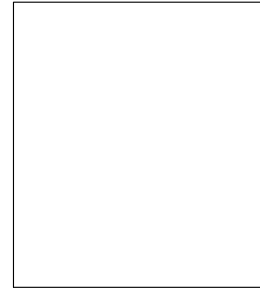

Chrome Plated

NO INTERNAL THREAD

142860

FOR ELJER

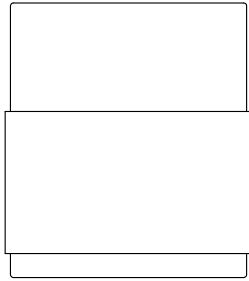

Chrome Plated

1-1/8 - 20 FEMALE

116360

FOR AM STD

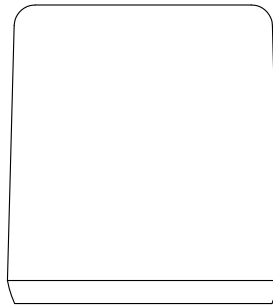

Chrome Plated

1-11/64 - 24 FEMALE

901550

FOR CRANE

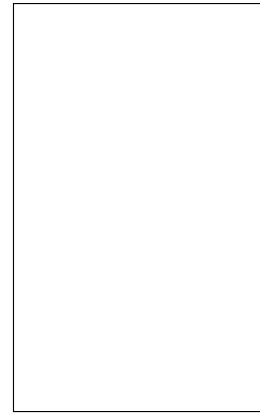

NO INTERNAL THREAD

142020

FOR SPEAKMAN

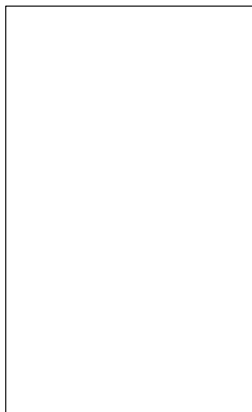

Chrome Plated

1-1/8 - 18 FEMALE

122730

FOR MILWAUKEE



Chrome Plated

15/16 - 27 FEMALE

194120

FOR ELJER

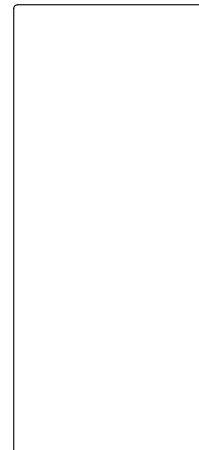

Chrome Plated

1" - 20 FEMALE

904220

ESCUTCHEON TUBES

Chrome Plated

FOR ELJER



1" - 20 FEMALE

907800

Chrome Plated

FOR ELJER / STERLING



15/16 - 20 FEMALE

1" - 24 MALE

199300

Chrome Plated

FOR CENTRAL



1-13/64 - 20 FEMALE

915810

Chrome Plated

FOR CRANE

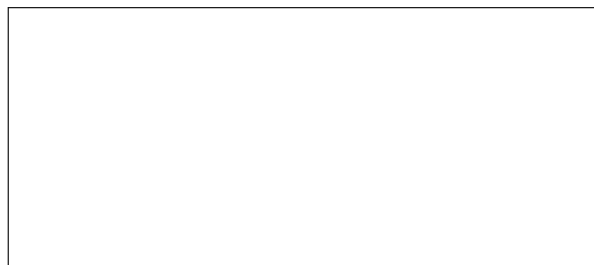

1-21/64 - 28 FEMALE

106350

ESCUTCHEONS

- 110660-BN Nickel Plated
- 110660-CP Chrome Plated
- 110660-PB Polished Brass

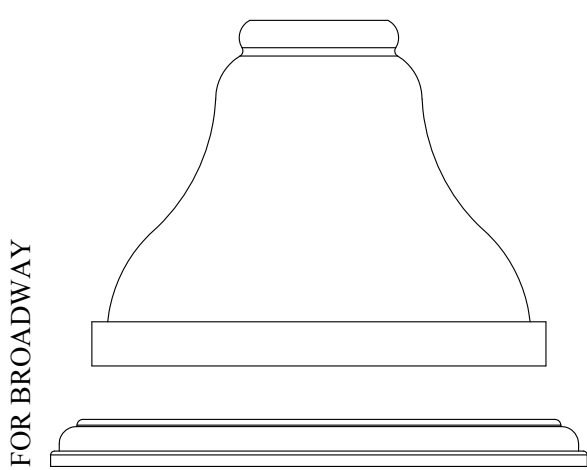

- 110730-BN Nickel Plated
- 110730-CP Chrome Plated
- 110730-PB Polished Brass

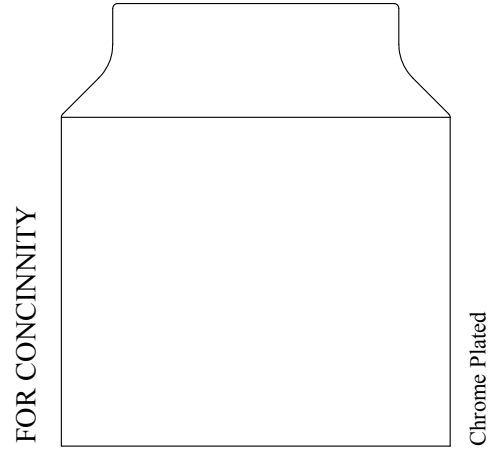

3/4" - 20 FEMALE
133970

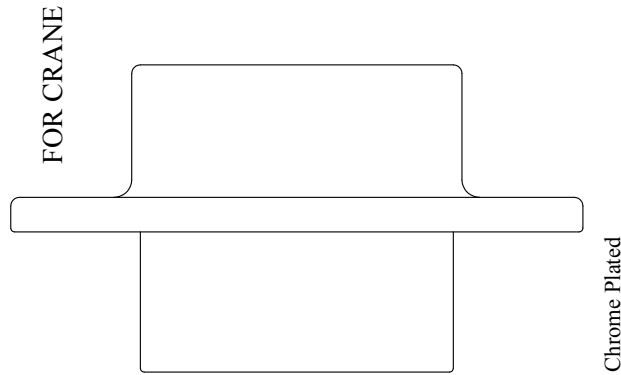

1-9/16 - 16 FEMALE
130290

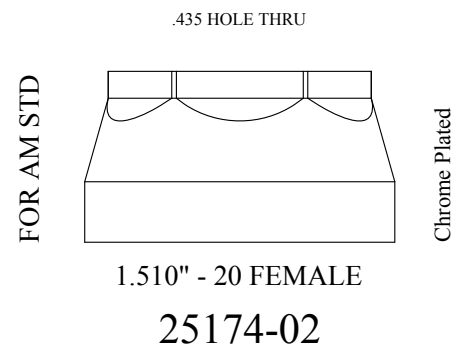
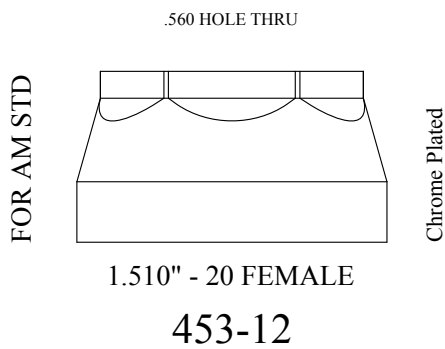

ESCUTCHEONS

FOR CONCINITY

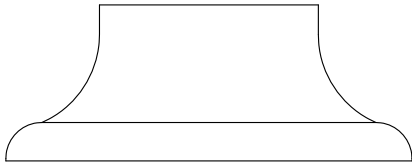

Chrome Plated

1-1/64 - 20 FEMALE

113460

FOR CRANE

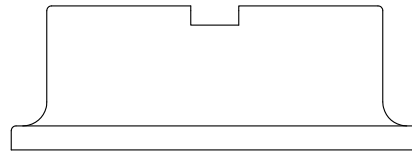

Chrome Plated

1-5/16 - 16 FEMALE

134650

OEM#: F13243
OEM#: F11743

FOR CRANE

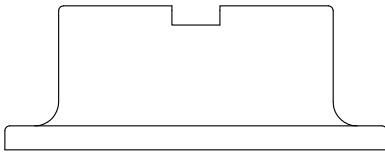

Chrome Plated

1-5/16 - 16 FEMALE

143000

OEM#: F11743

FOR VALLEY

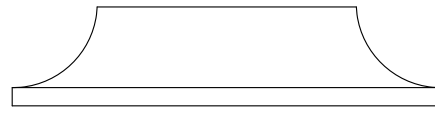

Chrome Plated

1-1/4 - 20 FEMALE

155930

FOR CRANE

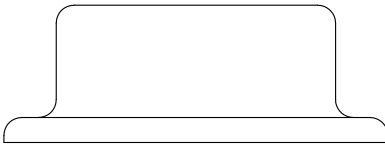

Chrome Plated

1-5/16 - 16 FEMALE

142510

OEM#: F11945, F14920, 300550

FOR CRANE

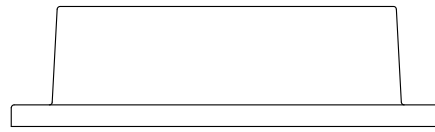

Chrome Plated

1-1/2 - 16 FEMALE

107750

OEM#: F12126

FOR CRANE

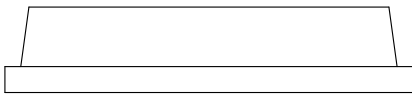

Chrome Plated

1-13/16 - 16 FEMALE

139600

OEM#: F10701

FOR ELJER

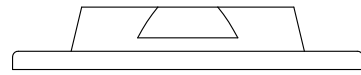

Chrome Plated

1" - 20 FEMALE

111690



1" - 20 FEMALE

175240



1-3/32 - 18 FEMALE

176710

*We are always adding
new parts. Check our
website for updates.*

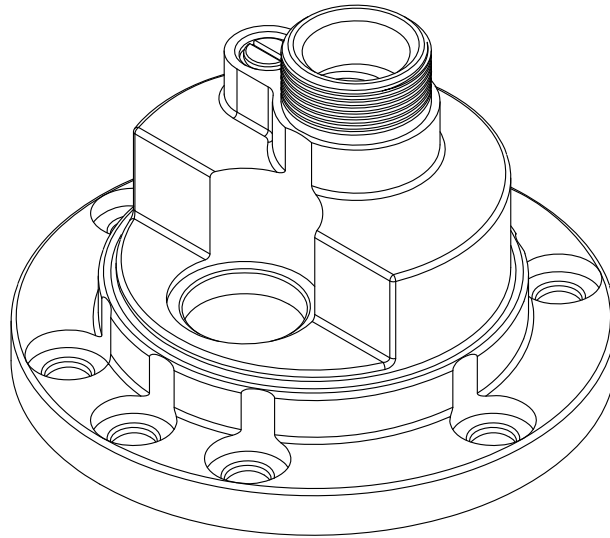

BARRY E.  SR. CO.

Send Your Orders To:

BARRY E.  SR. CO.

E-mail: orderdesk@barrywalter.com

Fax: 1.800.886.9831

Phone: 1.800.767.5552



Quality Replacement Parts

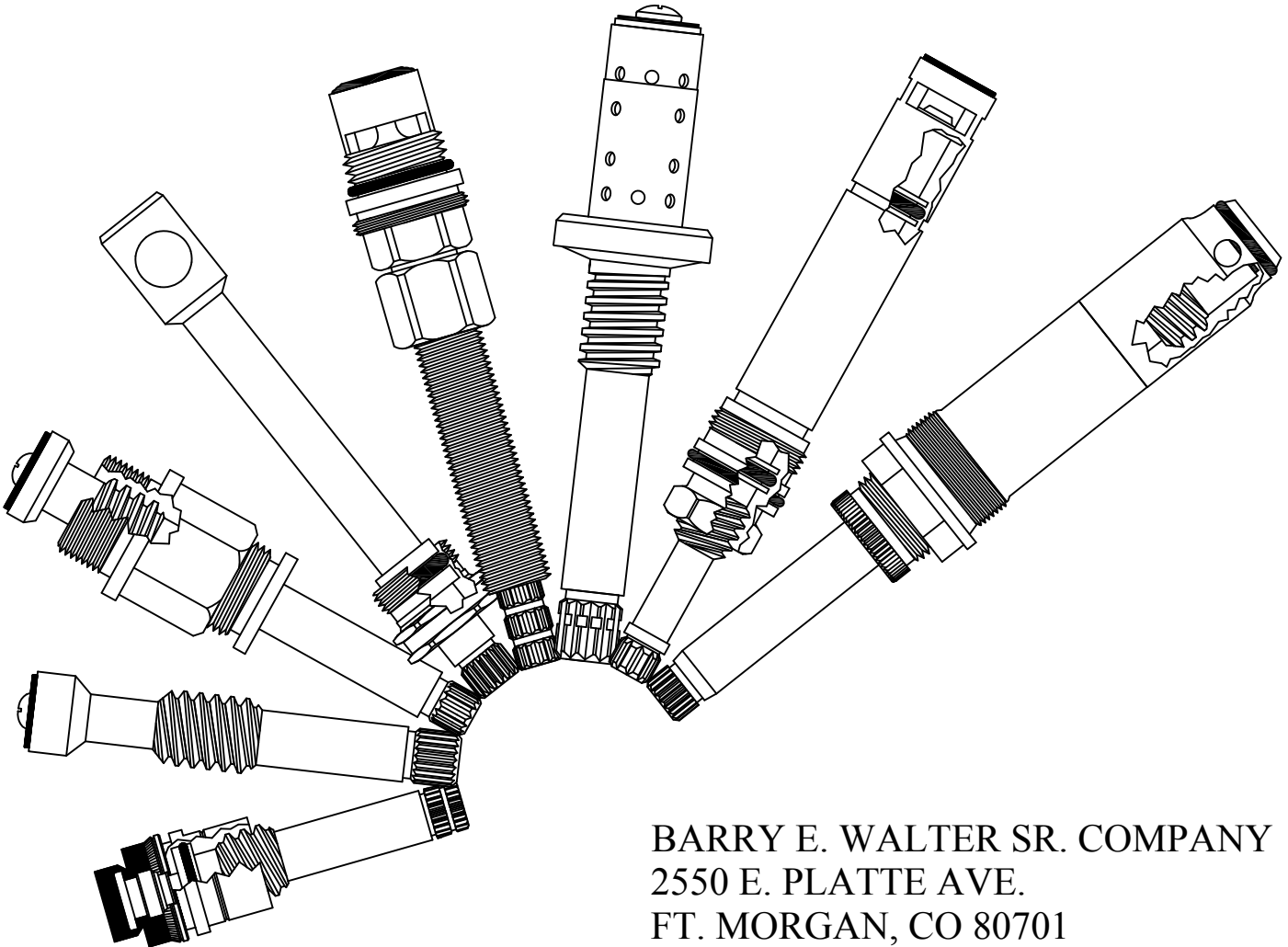

BARRY E. WALTER SR. COMPANY
2550 E. PLATTE AVE.
FT. MORGAN, CO 80701

BARRY E.  WALTER SR. CO.

SHOWER HEADS & COMPONENTS

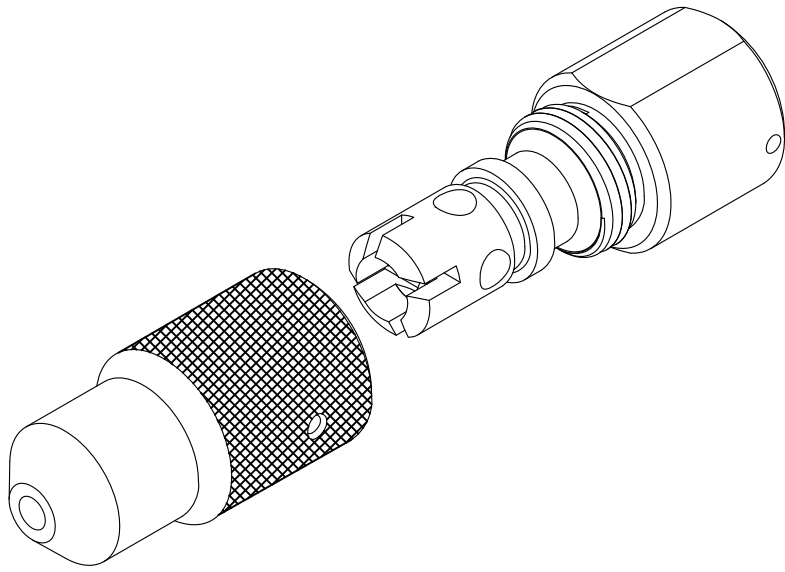

SHOWER HEADS

FOR ACORN
Female

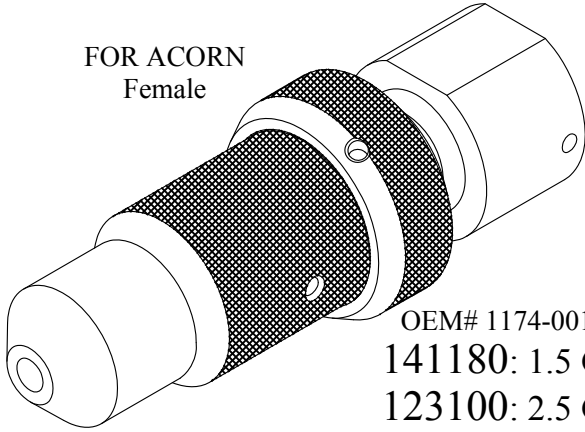

OEM# 1174-001-001
141180: 1.5 GPM
123100: 2.5 GPM

FOR ACORN
Female Rigid

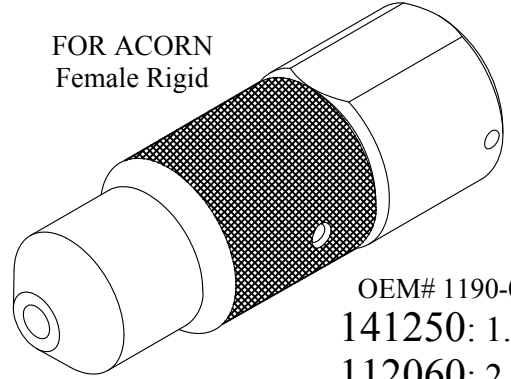

OEM# 1190-010-001
141250: 1.5 GPM
112060: 2.5 GPM

FOR ACORN
Male

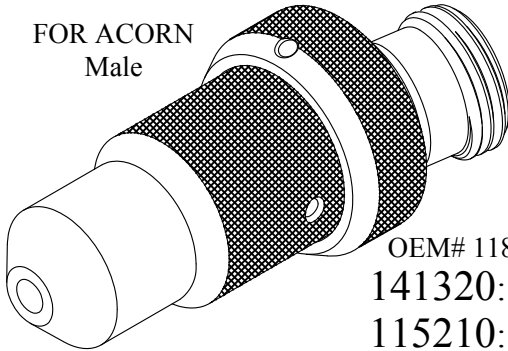

OEM# 1180-001-001
141320: 1.5 GPM
115210: 2.5 GPM

FOR ACORN
Male Rigid

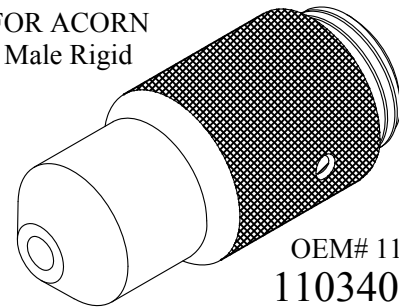

OEM# 1192-010-001
110340: 1.5 GPM
115350: 2.5 GPM

FOR ACORN
Female

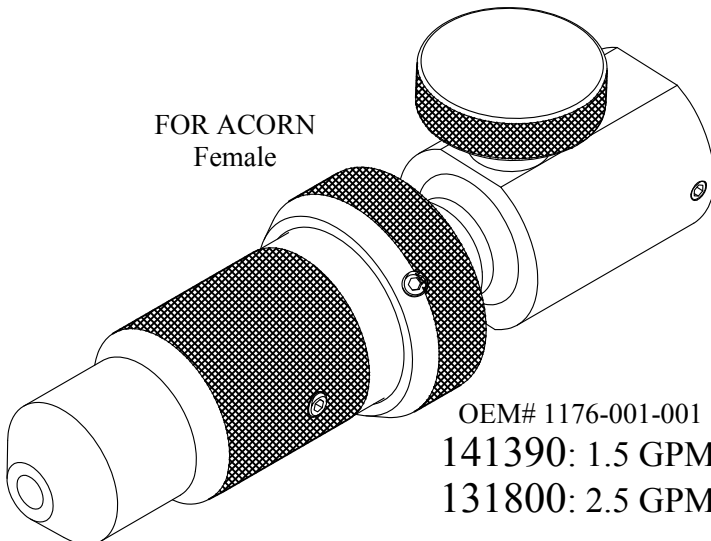

OEM# 1176-001-001
141390: 1.5 GPM
131800: 2.5 GPM

FOR ACORN
Male Rigid

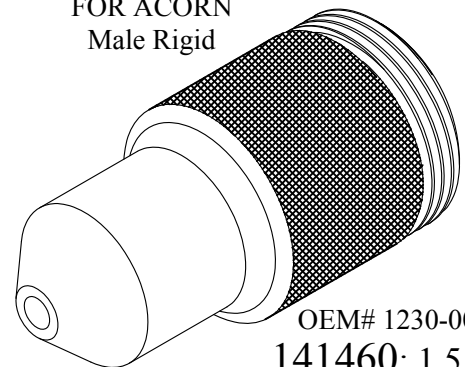

OEM# 1230-000-001
141460: 1.5 GPM
123750: 2.5 GPM

SHOWER HEADS

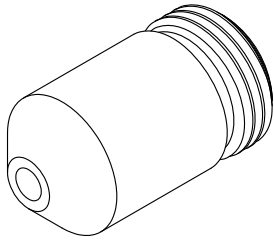

For
Acorn Male
OEM# 1241-001-001
120320: 1.5 GPM
120390: 2.5 GPM

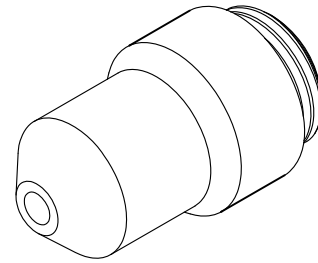

For
Acorn Male
OEM# 1187-000-001
141670: 1.5 GPM
103220: 2.5 GPM

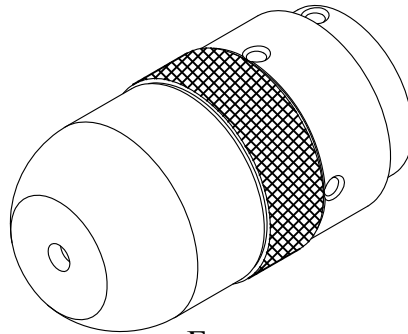

For
Bradley Female
3/8-18 NPT
OEM# S24-008
141600: 1.5 GPM
130870: 2.5 GPM

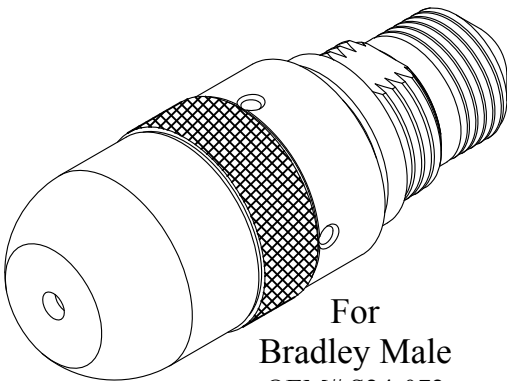

For
Bradley Male
OEM# S24-072
112450: 1.5 GPM
112130: 2.5 GPM
122380: 3.0 GPM

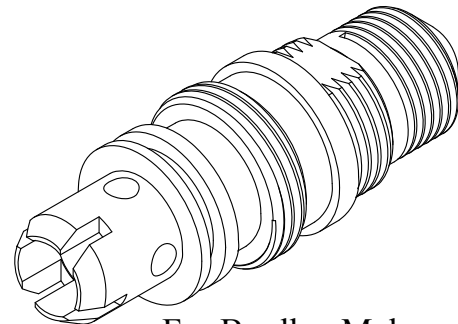

For Bradley Male
Chrome Plated Solid Brass
(Not Plastic)
OEM# S88-067 / 111810: 1.5 GPM
OEM# S88-001 / 122310: 2.5 GPM
OEM# S88-003 / 122520: 3.0 GPM

SHOWER HEADS

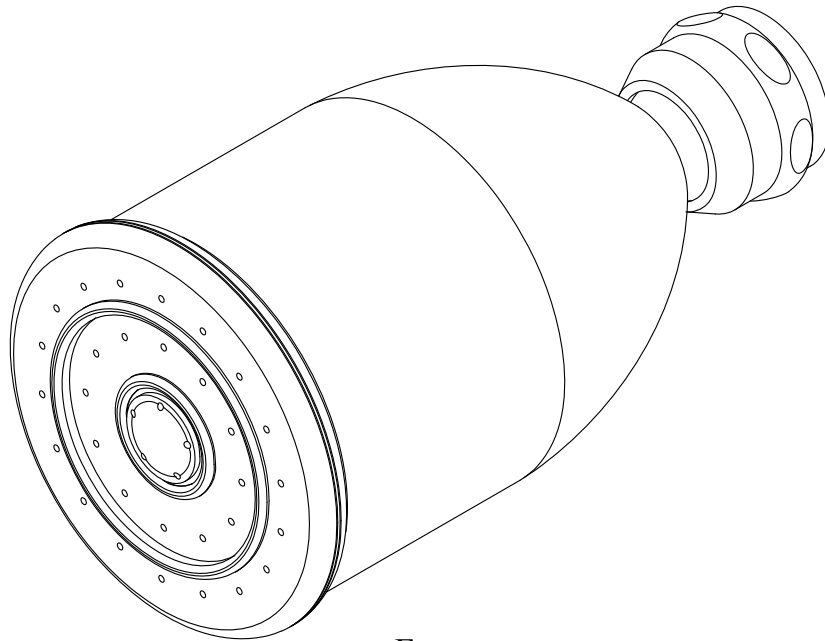

For
Concinnity
132620

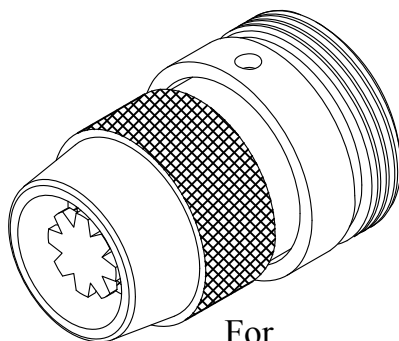

For
Symmons "Free-Flo"
OEM# FF-1A1.5
110270: 1.5 GPM
OEM# FF-1A
131190: 2.5 GPM

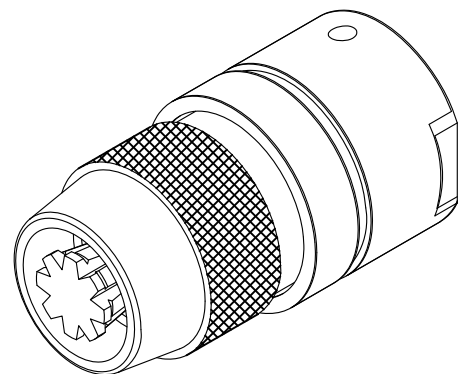

For
Symmons "Free-Flo" Rigid
OEM# 4-285F
112620: 2.5 GPM
141740: 1.5 GPM

SHOWER HEAD COMPONENTS

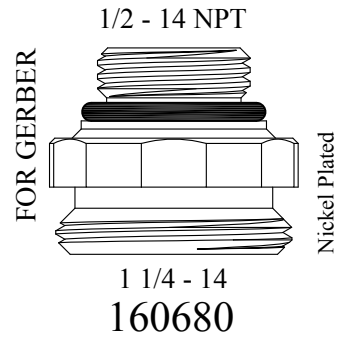
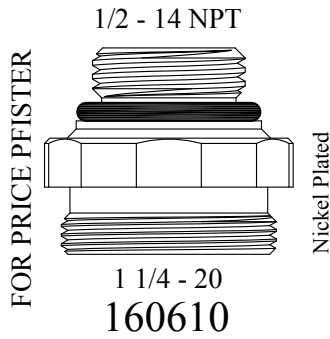
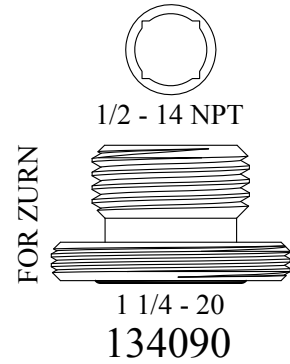
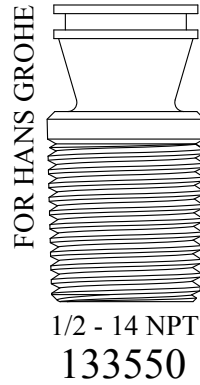
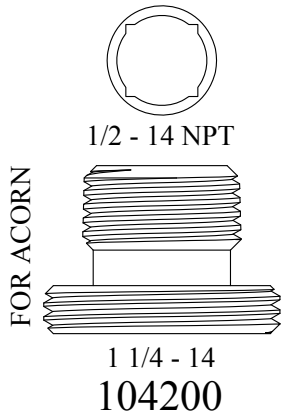

PIVOT BALL
FOR WATERPICK

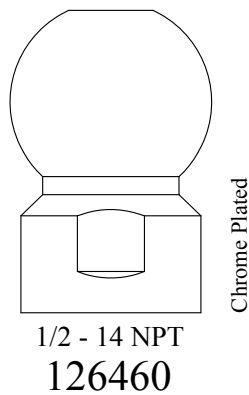

SHOWER MIXER
FOR POWERS

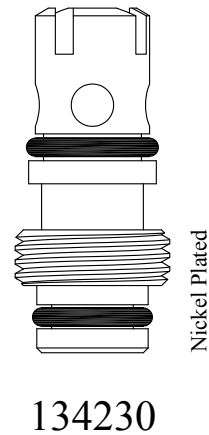

BARRY E.  WALTER SR. CO.

REPAIR KITS

REPAIR KITS

FOR ACORN B5 LF103870

PACKING NUT

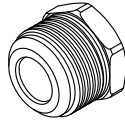

SPRING

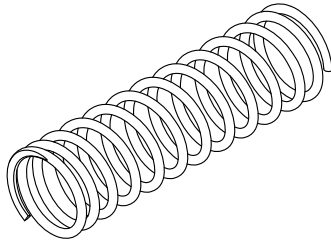

.437 x .250 x .094
O-RING



.437 x .250
BACK-UP RING



1.030 x .875 x .062
GASKET

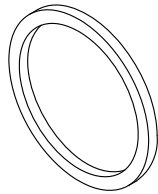

CAP NUT

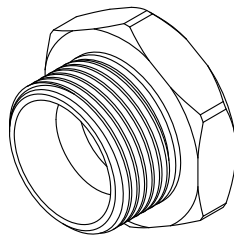

STEM ASSEMBLY

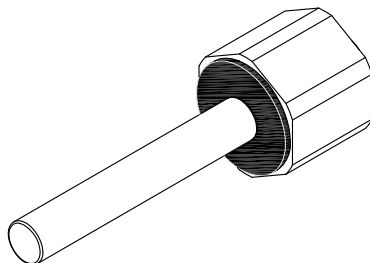

1/2-27 SEAT

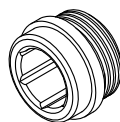

FOR AMERICAN STANDARD COLONY DIVERTER 115540

.745 x .375 x .047
PHENOLIC WASHER



PACKING



PACKING SEAL



DIVERTER WASHER

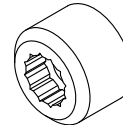

.750 x .625 x .062
O-RING



.750 x .390 x .040
BRASS WASHER



WAVE WASHER



8-32 x 3/8
BIBB SCREW



1/2-20 SEAT

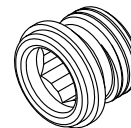

REPAIR KITS

FOR AMERICAN STANDARD COLONY
SHOWER VALVE REPAIR KIT
115330

FOR BRADLEY REPAIR KIT S45-048A
130170

.745 x .375 x .047
PHENOLIC WASHER

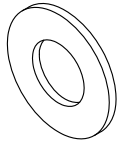

RETAINER CUP

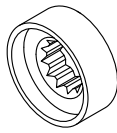

PACKING



PACKING SEAL



.750 x .390 x .040
BRASS WASHER

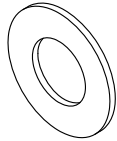

WAVE WASHER



BIBB WASHER



8-32 x 3/8
BIBB SCREW



1/2-20 SEAT

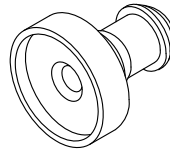
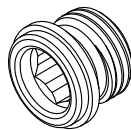

RETAINER &
SCREW WASHER



.812 x .625 x .094
O-RING

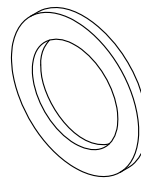

.937 x .630 x .062
FIBRE WASHER

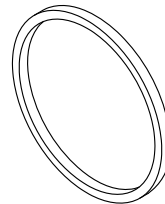

1.100 x 1.000 x .062
GASKET

REPAIR KITS

FOR BROADWAY DIVERTER
REPAIR KIT 26.50792 000
136190

DIVERTER WASHER



.590 x .468 x .032
BRASS WASHER

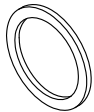

.625 x .437 x .187
STEM PACKING



3/8L BIBB WASEHR



10-24 X 3/8
BIBB SCREW



FOR BROADWAY 478891
REPAIR KIT 26.50196 000
135680

.875 x .750 x .062
O-RING



.625 x .437 x .187
STEM PACKING



.625 x .450 x .050
BRASS WASHER



3/8 BIBB WASHER



10-24 X 3/8
BIBB SCREW



9/16 -27 SEAT

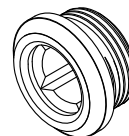

REPAIR KITS

FOR ELJER PRISON VALVE REPAIR KIT

LF132080

SECURITY SEAT WASHER

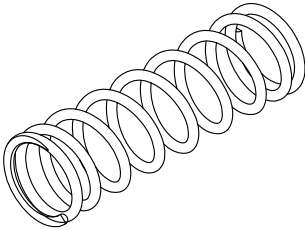

SPRING

SECURITY COLLAR

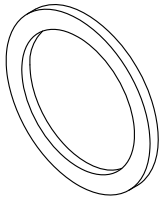

GASKET

SECURITY COLLAR

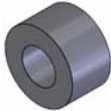

PACKING

PACKING NUT

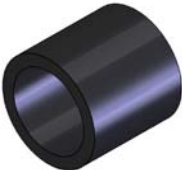
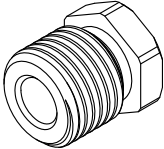

RUBBER GASKET

CAP

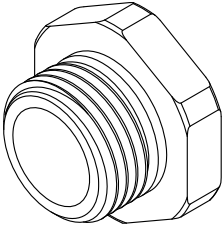

GASKET

VALVE HEAD

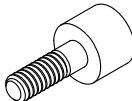
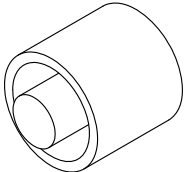

VALVE STEM

REPAIR KITS

FOR CHICAGO REPAIR KIT 124870



FOR KOHLER PRISON VALVE REPAIR KIT LF115100

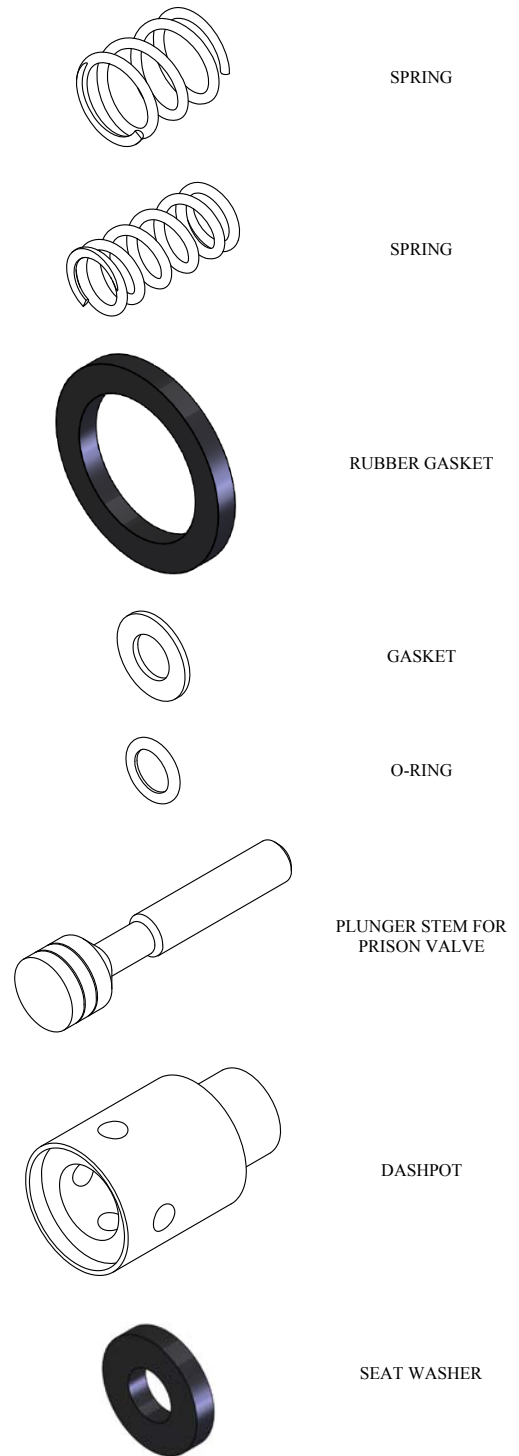

REPAIR KIT #134180 ALSO AVAILABLE
LESS LEAD FREE DASHPOT

REPAIR KITS

FOR PRICE PFISTER 452801/2 REPAIR KIT
135140



CLIP

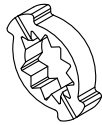

STOP RING



CERAMIC DISC
1/4 TURN



CERAMIC DISC
1/4 TURN



SMALL SEAL

REPAIR KITS

FOR SAVOY DIVERTER 438901
RETAINER KIT
148090

RETAINER

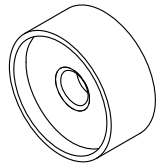

BIBB WASHER x 2



1/4-20 BRASS NUT



FOR SYMMONS C-5 KIT-B
102310

1/4"-20 x 1/2"
SET SCREW
STAINLESS STEEL



2.25 x 2.00 x .062
GASKET

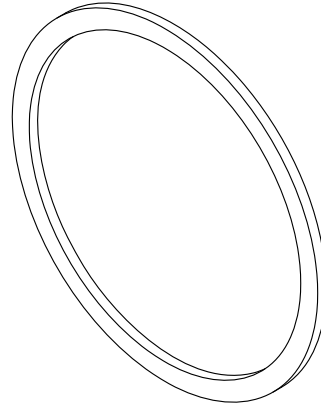

.812 x .500 x .562
STEM PACKING

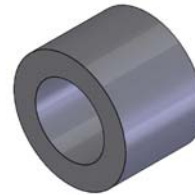

HOT WASHER
T-6



COLD WASHER
T-8



10-32 x 5/16"
BIBB SCREW



RETAINER RING
T-7

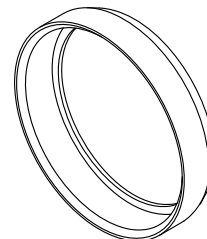

REPAIR KITS

FOR SYMMONS TA-10 KIT TA-9
108470

1.562 x 1.375 x .062
GASKET

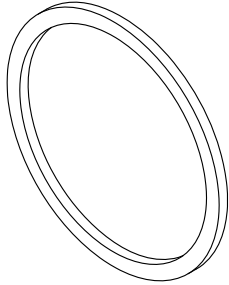

HOT WASHER
T-6



COLD WASHER
T-8

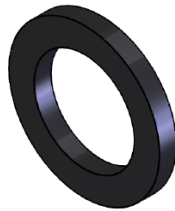

10-32 x 5/16"
BIBB SCREW



RETAINER RING
T-7

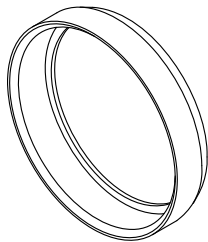

FOR SYMMONS MONO-MIXER
REPAIR KIT
113810

LARGE SEAT WASHER



SMALL SEAT WASHER



1.030 x .875 x .062
GASKET

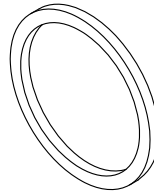

1.218 x 1.062 x .062
GASKET

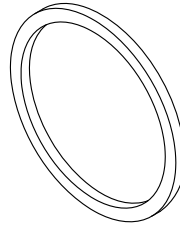

1.562 x 1.375 x .062
GASKET

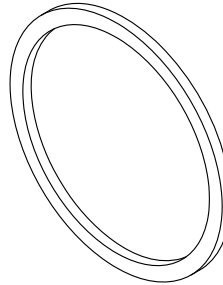

.750 x .500 x .313
STEM PACKING



8-32 x 1 1/4
BIBB SCREW

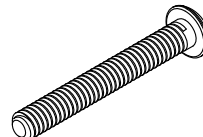

REPAIR KITS

FOR SYMONS SHOWER-OFF
REBUID KIT NS-13R

134110

SEAT
NS-7

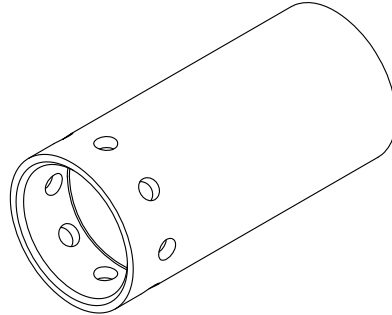
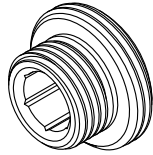

CAGE CYLINDER
NS-6

BUSHING GUIDE
NUT WASHER
NS-14



.375 x .250 x .062
O-RING

SCREW NS-9

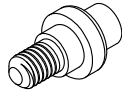

.750 x .562 x .094
O-RING

STAINLESS ROD
NS-16

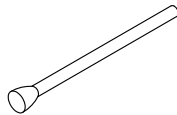

1.312 x 1.125 x .094
O-RING

SPRING
NS-13

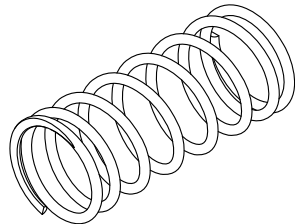

1.25 x 1.00 x .125
O-RING

RETAINER PISTON
NS-8

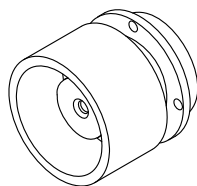

.687 x .562 x .032
GASKET



BIBB WASHER
NS-11

REPAIR KITS

FOR SYMMONS TA-16 REPAIR KIT
123850

FOR T & S 238A REPAIR KIT
120350

.625 x .437 x .094
O-RING



.687 x .437 x .312
STEM PACKING

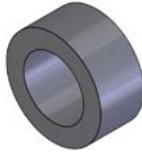

.625 x .450 x .050
BRASS WASHER

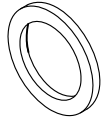

.687 x .453 x .032
BRASS WASHER

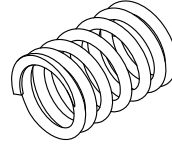
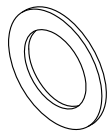

SPRING



BIBB WASHER
.343 HOLE



.250 x .125 x .062
O-RING



.375 x .250 x .062
O-RING



.437 x .312 x .062
O-RING



.687 x .500 x .094
O-RING

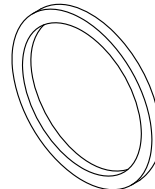

1.030 x .875 x .062
GASKET

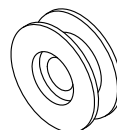

U-CUP HOLDER

REPAIR KITS

VALVE PLUG STEM KIT
FOR PLUGGING VALVE BODY
WHILE STEM IS REMOVED
103130

SPRING

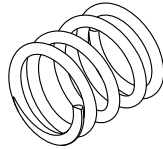

.860 x .468 x .050
BRASS WASHER

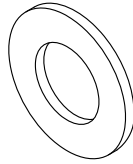

VALVE PLUG STEM

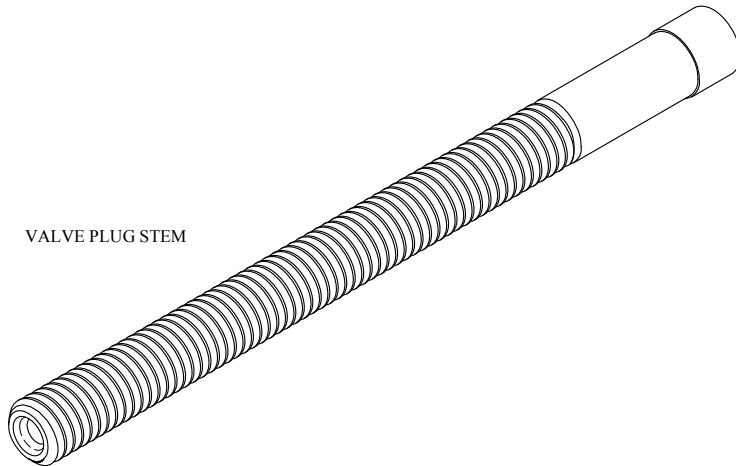

KNURLED NUT



3/8M RETAINER

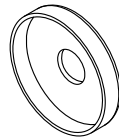

3/8M BIBB WASHER

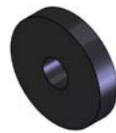

10-24 X 3/8
BIBB SCREW



Send Your Orders To:

BARRY E.  WALTER SR. CO.

E-mail: orderdesk@barrywalter.com

Fax: 1.800.886.9831

Phone: 1.800.767.5552



BRASS
AMERICA
Quality Replacement Parts

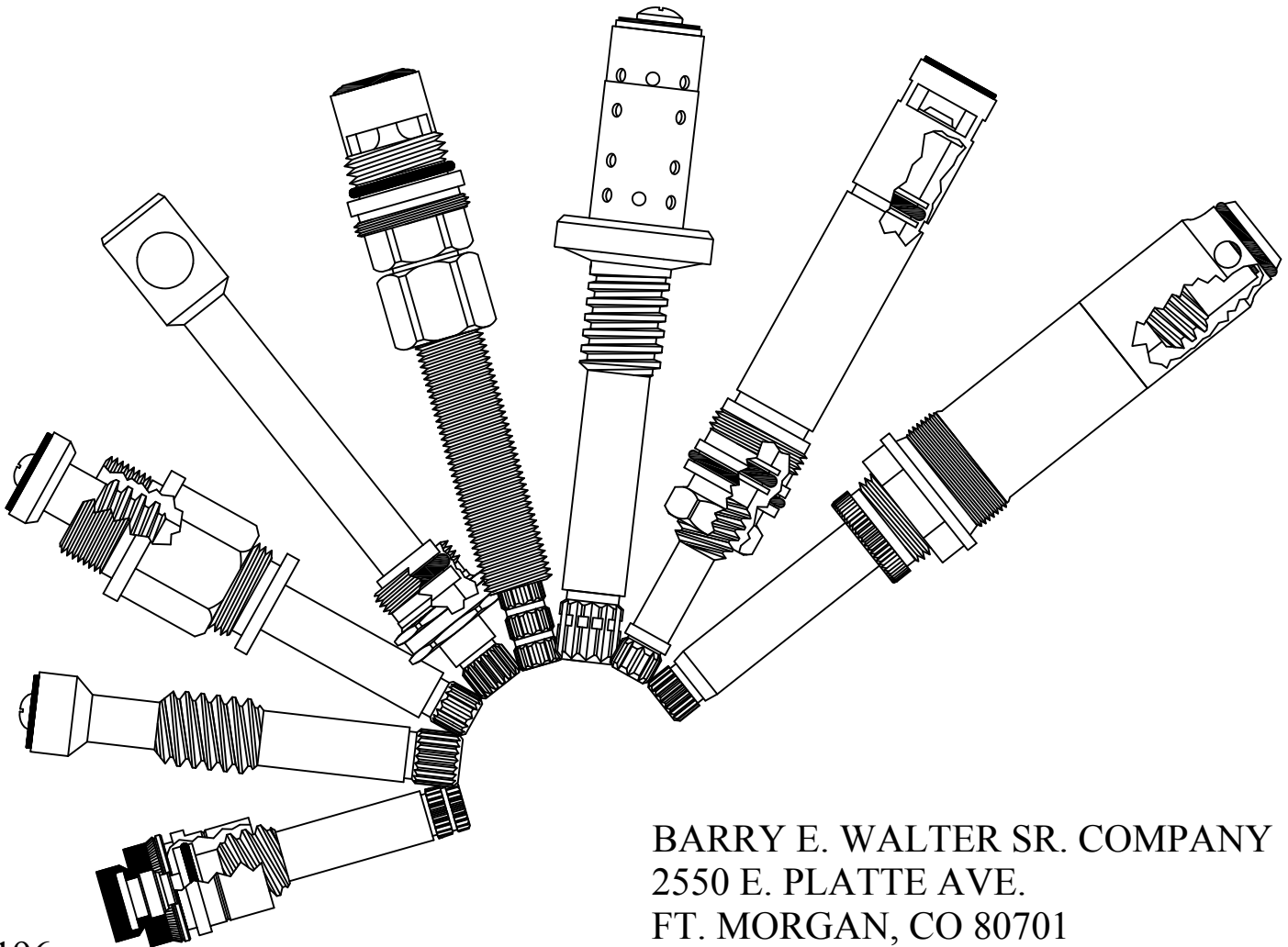

BARRY E. WALTER SR. COMPANY
2550 E. PLATTE AVE.
FT. MORGAN, CO 80701

BARRY E.  WALTER SR. CO.

MISC. PARTS

FLUSHOMETER

FRICTION WASHERS

BALANCING SPOOLS

TOP GASKETS

REPLACEMENT
BONNETS FOR KOHLER

PACKINGS

SPOUT POSTS & NUTS

DIVERTER WASHERS

DRAIN COMPONENTS

BIBB WASHERS

STEM & HANDLE ID
GAUGES

SPECIAL WASHERS

O-RINGS

CERAMIC SEALS & DISC
SETS

CAP GASKETS

SCREWS

SEAT WRENCHES & TOOLS

FLUSHOMETER PARTS

FOR COYNE DELANEY

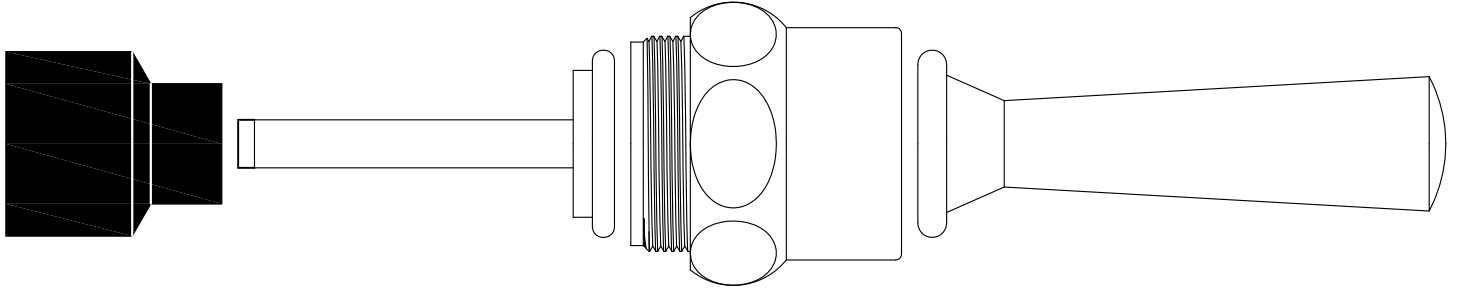

119900
Replaces OEM# F333A
Includes:
118080 137920
137850 161650

119970
Replaces OEM# F333A-C
Includes:
118080 137920
137850 134420

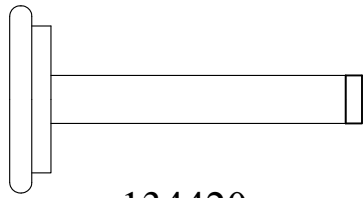

134420
Replaces:
OEM# F186

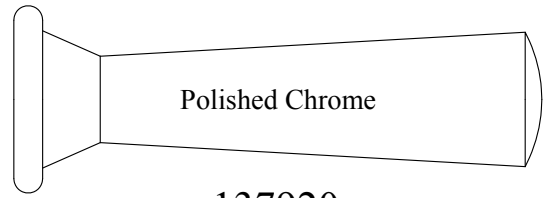

137920
Replaces:
OEM# F-36



161650
Replaces:
OEM# F223-2

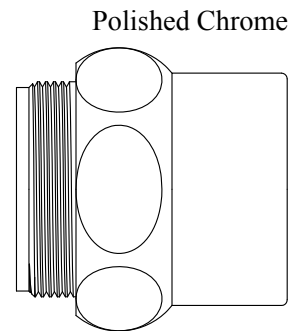

137850
Replaces:
OEM# F-224

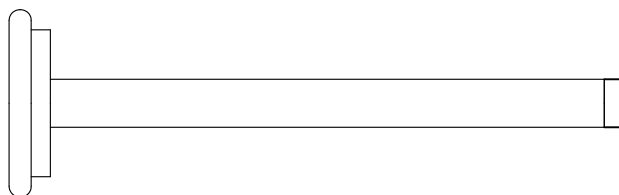

117450
Replaces:
OEM# F368
For Push Button Style

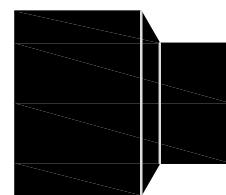

118080
Replaces:
OEM# F222-3

FLUSHOMETER PARTS

FOR COYNE DELANEY

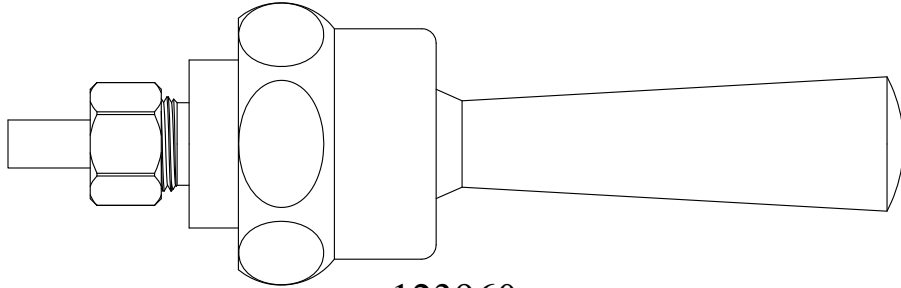

123960
Replaces:
OEM# F35A

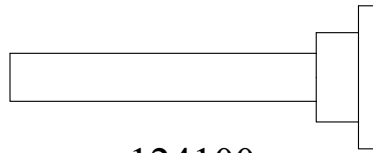

124100
Replaces:
OEM# F33

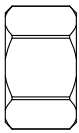

124240
Replaces:
OEM# F28L

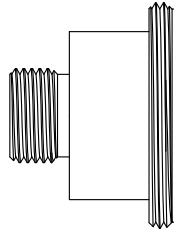

124170
Replaces:
OEM# F29

Polished Chrome

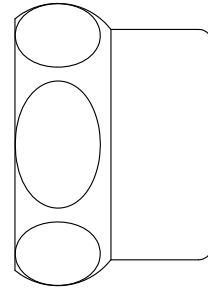

124030
Replaces:
OEM# F34

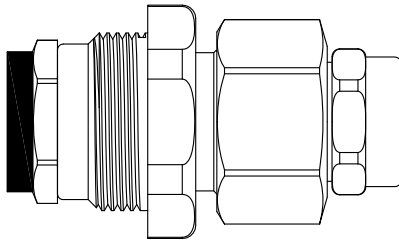

460302
Replaces:
OEM# F89A-J

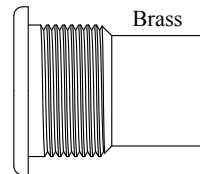

Brass

138340
Replaces:
OEM# R-16, F-16, P-16

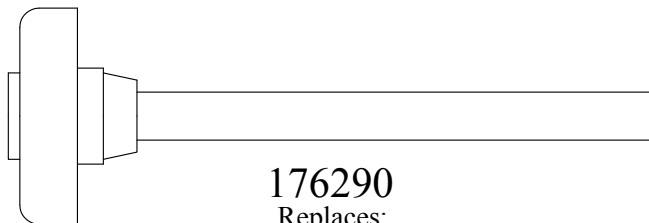

176290
Replaces:
OEM# F20

FLUSHOMETER PARTS

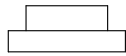

LFF11445
FOR CRANE
Bushing

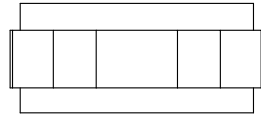

118830
FOR CRANE
Handle Ring for Flush Valve
Replaces OEM# F3438

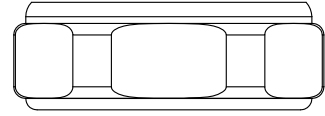

F11447
FOR CRANE
Handle Eccentric Ring
for Flush Valve

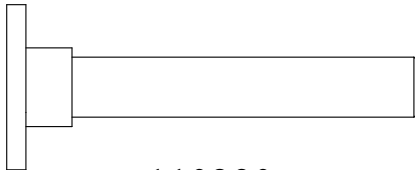

110290
FOR CRANE
Plunger Assembly

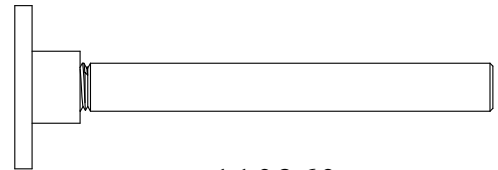

110360
FOR CRANE
2-1/2" Plunger Assembly

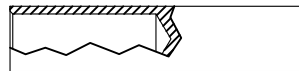

125320
FOR LAWLER
Push Rod

Chrome Plated Sleeve & Push Button

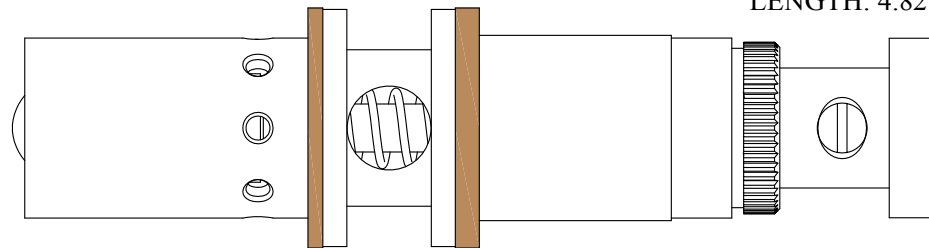

LENGTH: 4.82"

475700
GASKET: 894650 INCLUDED
FOR PILOT
Flush Valve

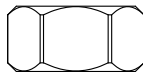

B-13
FOR SLOAN
Packing Nut
Replaces: OEM# B-13

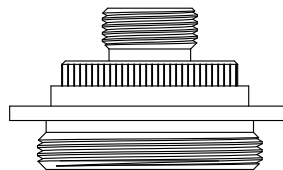

B-5
FOR SLOAN
Handle Bushing
Replaces: OEM# B-5

Brass

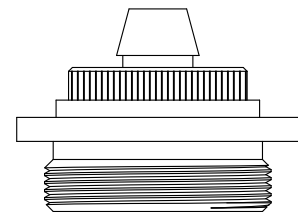

152290
FOR SLOAN
Bushing
Replaces: OEM# B-41

Brass

FLUSHOMETER PARTS

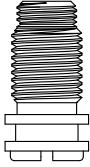

186240
FOR SPEAKMAN
Spindle
OEM# 03-0295

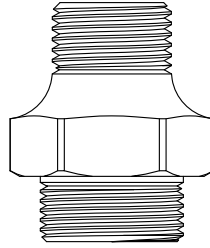

06-0064
FOR SPEAKMAN
Gland for Urinal Stop

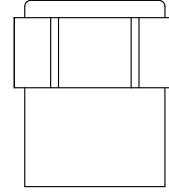

01-0422
FOR SPEAKMAN
Packing Nut for Urinal Stop

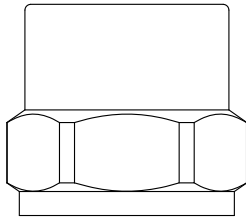

Polished Chrome

125290
FOR SPEAKMAN
Flush Valve Handle Nut
OEM# 01-0569

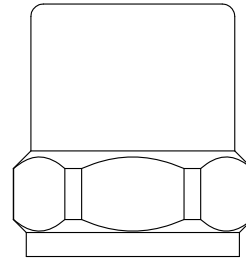

Polished Chrome

01-0420
FOR SPEAKMAN
Flush Valve Handle Nut

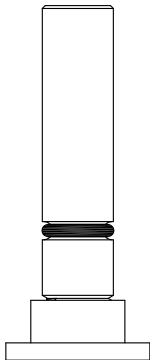

G05-0394
FOR SPEAKMAN
Plunger



G05-0397
FOR SPEAKMAN
Plunger Assembly

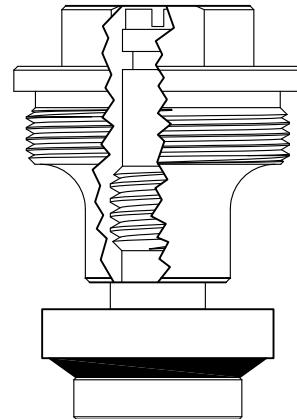

460401
FOR SPEAKMAN
Stop Unit Assembly

BALANCING SPOOLS

FOR MOEN

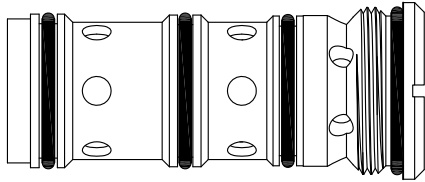

PART# 152920

Stainless Steel Piston & Body
Solid Brass Slotted Hub
Replacement for Moen 1423
Balancing Spool

FOR AMERICAN
STANDARD
& DELTA

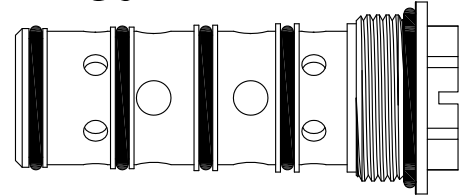

PART# 153340

Stainless Steel Piston & Body
Solid Brass Slotted Hub
Replacement for Am. Std.
10532-07 Balancing Spool
Replacement for Delta 574
Balancing Spool

FOR SPEAKMAN

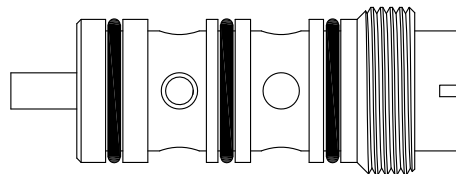

PART# 140970

Brass Sleeve & Plunger

REPLACEMENT BONNETS for KOHLER

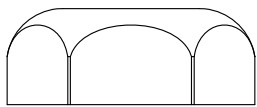

Chrome Plated

759040

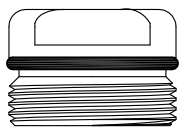

LF760050
LF760050-P
Nickel Plated

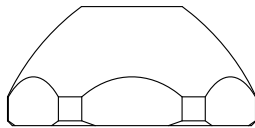

Chrome Plated

763150

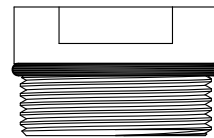

Nickel Plated

LF172580

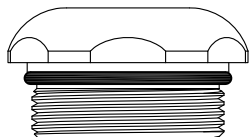

Chrome Plated

LF759100

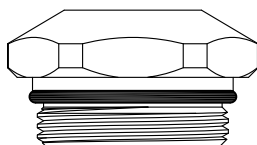

Chrome Plated

LF132900

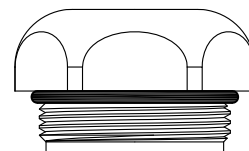

Chrome Plated

LF758040

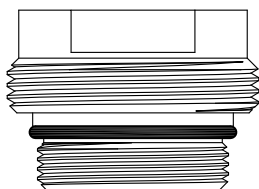

Nickel Plated

120580

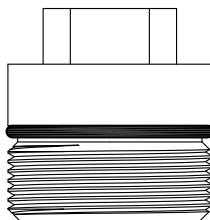

Nickel Plated

116100

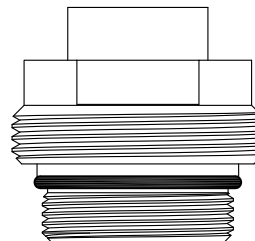

178960

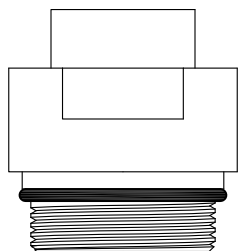

LF113320

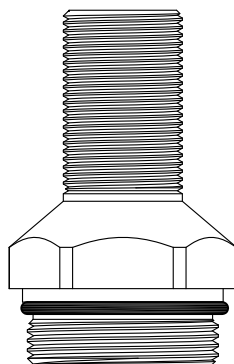

LF770720

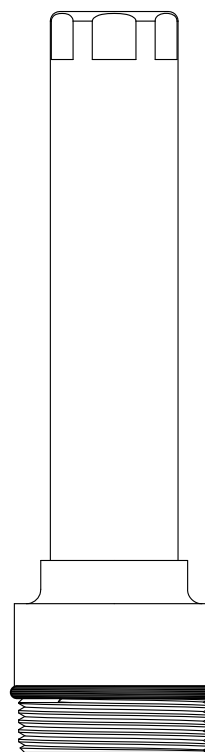

Chrome Plated

707000

SPOUT POSTS & NUTS

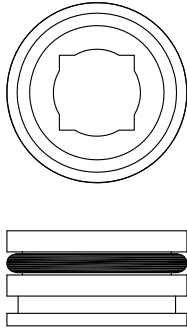

SPOUT POST
FOR GERBER
OEM #: 98-230

LF147390

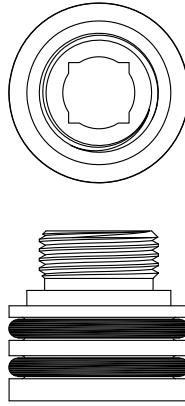

SPOUT POST
FOR GERBER
OEM #: 98-210

LF185890

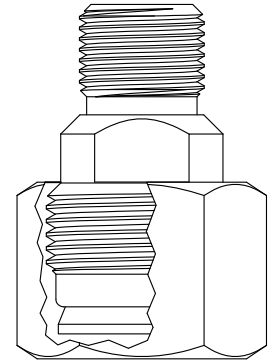

GOOSE NECK
SPOUT ADAPTER

LF114650

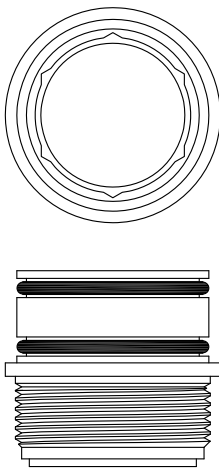

SPOUT POST
FOR GERBER
OEM #: 92-642

LF190220

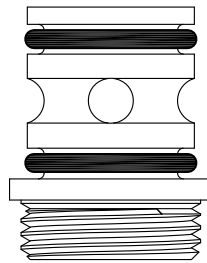

SPOUT POST
FOR KOHLER
OEM #: 34311

LF183510

Nickel Plated

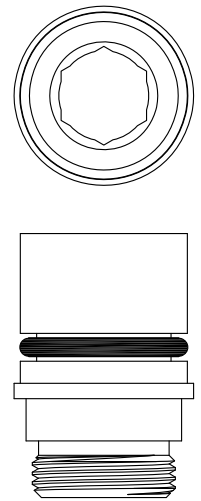

SPOUT POST
FOR PRICE PFISTER
OEM #: 970-180-12

LF189180

SPOUT COMPONENTS

FOR CRANE

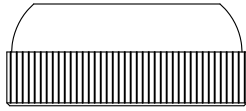

SPOUT NUT
107560

FOR P E GUERIN

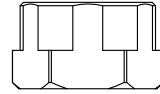

SPOUT TUBE NUT
125410

FOR CONCINITY

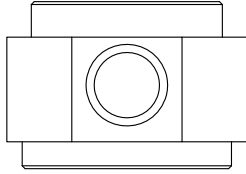

TEE
117760

FOR BRIGGS

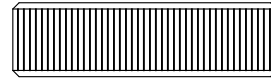

SPOUT NUT
125410

Send Your Orders To:

BARRY E.  WALTER  SR. CO.

E-mail: orderdesk@barrywalter.com

Fax: 1.800.886.9831

Phone: 1.800.767.5552

DRAIN COMPONENTS

COMPLETE POP-UP DRAIN ASSEMBLY FOR CONCINNITY

CHROME PLATED
30334CH

SATIN NICKEL
30334SN

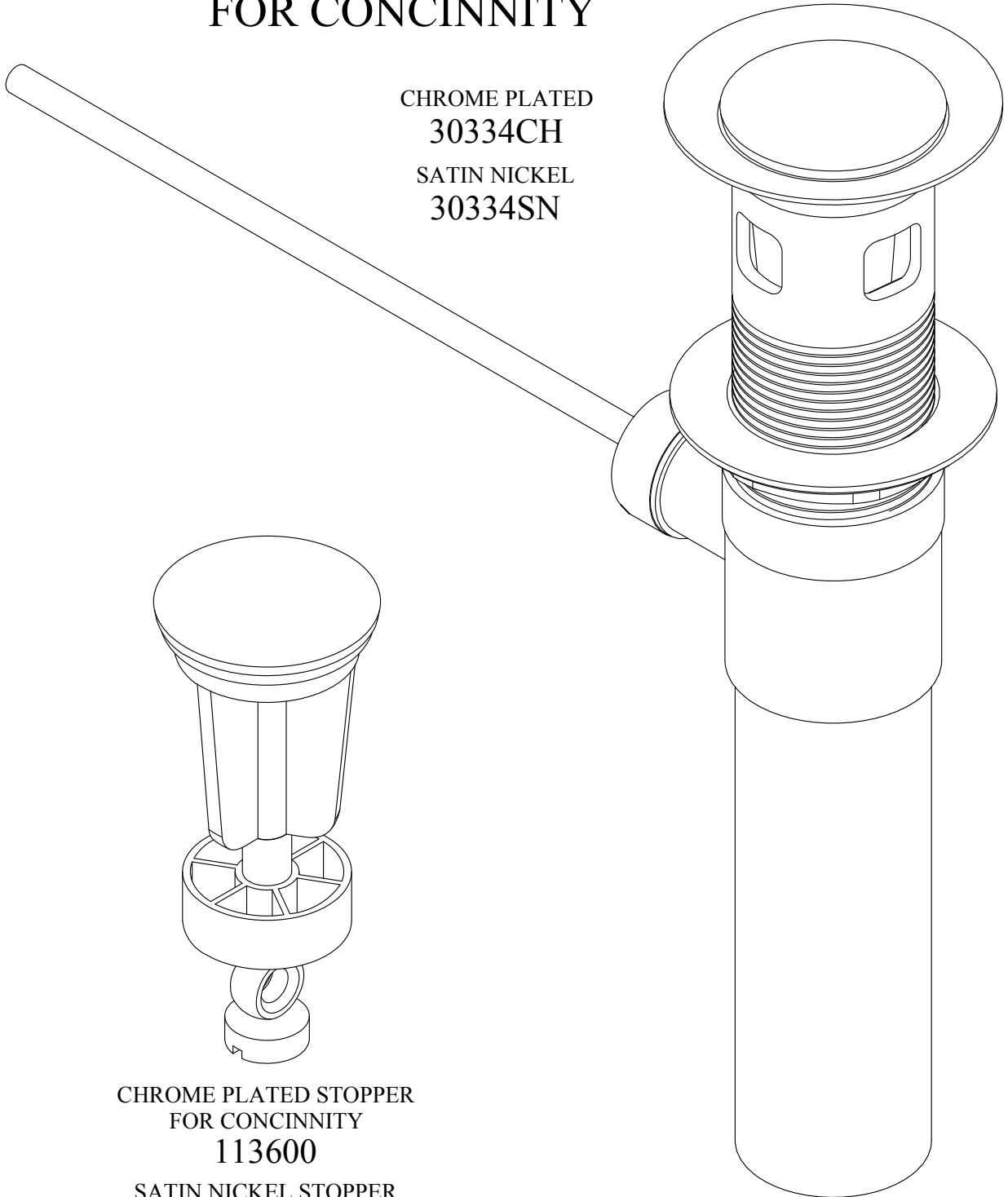

CHROME PLATED STOPPER
FOR CONCINNITY
113600

SATIN NICKEL STOPPER
FOR CONCINNITY
109820

DRAIN COMPONENTS

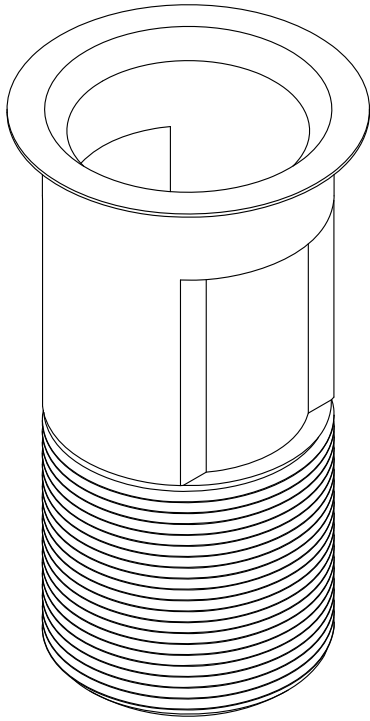

1-7/8" - 11.5 TPI

POLISHED CHROME DRAIN
FOR CRANE
140160-CP

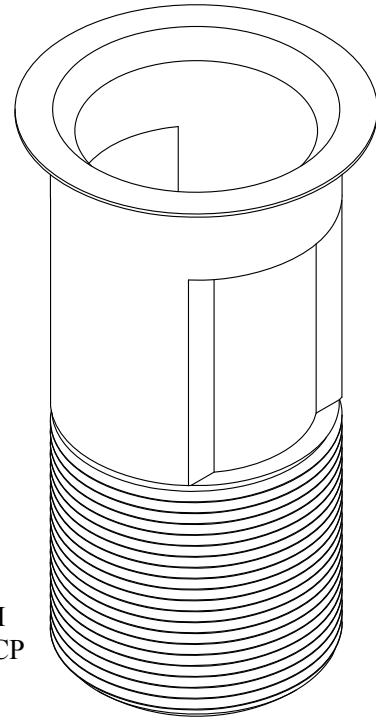

1-13/16" - 14 TPI
Fits with 122630-CP
(Original nut)

POLISHED CHROME DRAIN
FOR CRANE
142930-CP

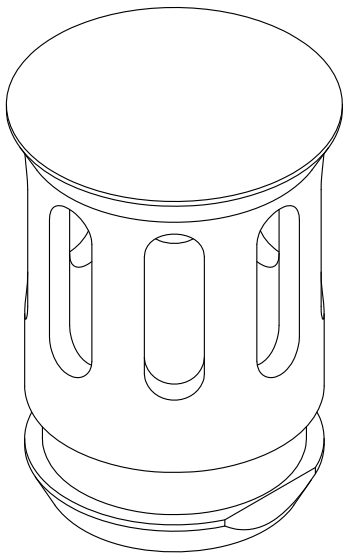

POLISHED CHROME STOPPER
FOR CRANE
140230-CP

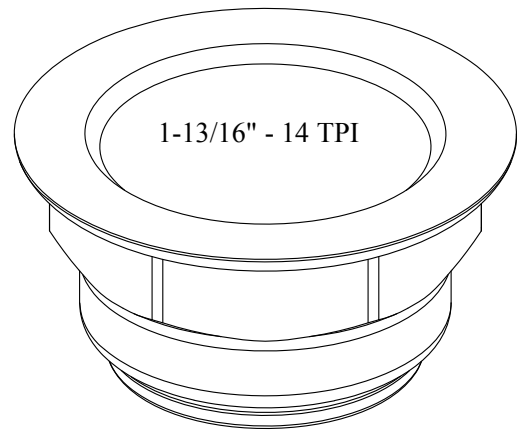

1-13/16" - 14 TPI

POLISHED CHROME DRAIN NUT
FOR CRANE
122630-CP

DRAIN COMPONENTS

POP-UP RODS

Chrome Plated Rod & Plastic Ball

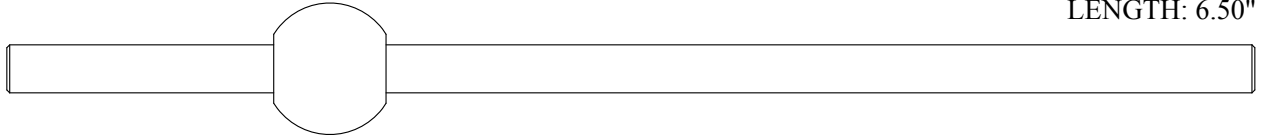

LENGTH: 6.50"

HORIZONTAL POP-UP ROD FOR HARDEN
133390

LENGTH: 6.85"

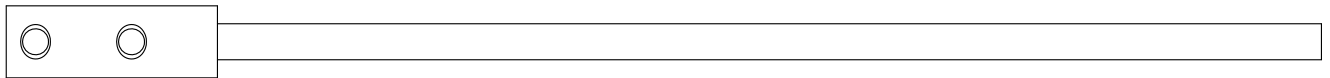

POP-UP LIFT ROD EXTENSION KIT
127670

Polished Brass



LENGTH: 13.88"

POP-UP ROD FOR PRICE PFISTER
119440

DRAIN COMPONENTS

PIVOT NUTS

FOR UNION BRASS

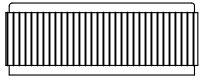

7/8 - 20 FEMALE

161880

FOR SPEAKMAN

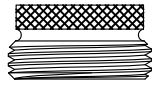

13/16 - 20 MALE

163630

FOR AM STD

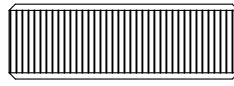

1-1/16 - 20 FEMALE

162160

Nickel Plated

FOR MOEN

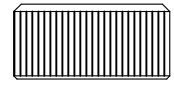

3/4 - 27 FEMALE

162230

FOR KOHLER

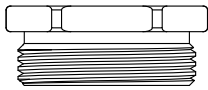

15/16 - 20 MALE

164190

Nickel Plated

FOR SAYCO

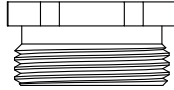

13/16 - 20 MALE

162020

FOR GERBER

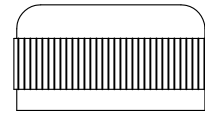

7/8 - 20 FEMALE

167060

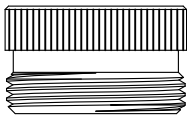

15/16 - 20 MALE

118410

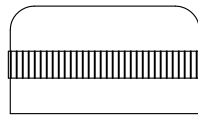

7/8 - 16 FEMALE

117920

FOR MILWAUKEE

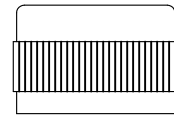

3/4 - 24 FEMALE

194540

Nickel Plated

STEM & HANDLE ID GAUGES



Male & Female

All of our ID gauges are
nickel plated brass!!!

Purchase individually
or by the set

Short Set - 122170

Long Set - 122100

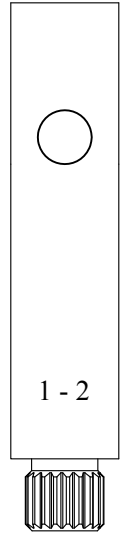

S
E
T

Stamp	Part #	
	Short	Long

Crane - Reocal	1-1	145690	145760
Price Pfister / Harcraft	1-2	145200	143730
American Standard 7/16"	1-4	145410	142400
Sterling	1-5	145340	142470
Central / Kohler (Trend)	1-6	141840	143870
Kohler	1-7	144920	142540
American Standard 3/8"	1-8	141910	142610
Savoy	1-13	141980	142680
Youngstown	2-2	142050	142750
Sayco / Gerber	2-3	144990	142820
Speakman	2-4	142120	142890
Briggs	3-3	145060	142960
Am. Brass / Streamway	3-7	145130	143030
Univesal Rundle	3-10	142190	143100
Michigan (Large)	3-11	142260	143170

Other
Avail.
ID's

Chicago	3-12	105950	
Sterling Brass / Cleveland	3-17	142330	
Delta	5-1	160260	
Valley	5-2	160330	
Sears	5-3	106020	
Sterling (Square)	5-5	106230	
Moen	4-5	101260	

BROACH I.D. GAUGE

2" x 1.5" area
for custom printing
or sticker

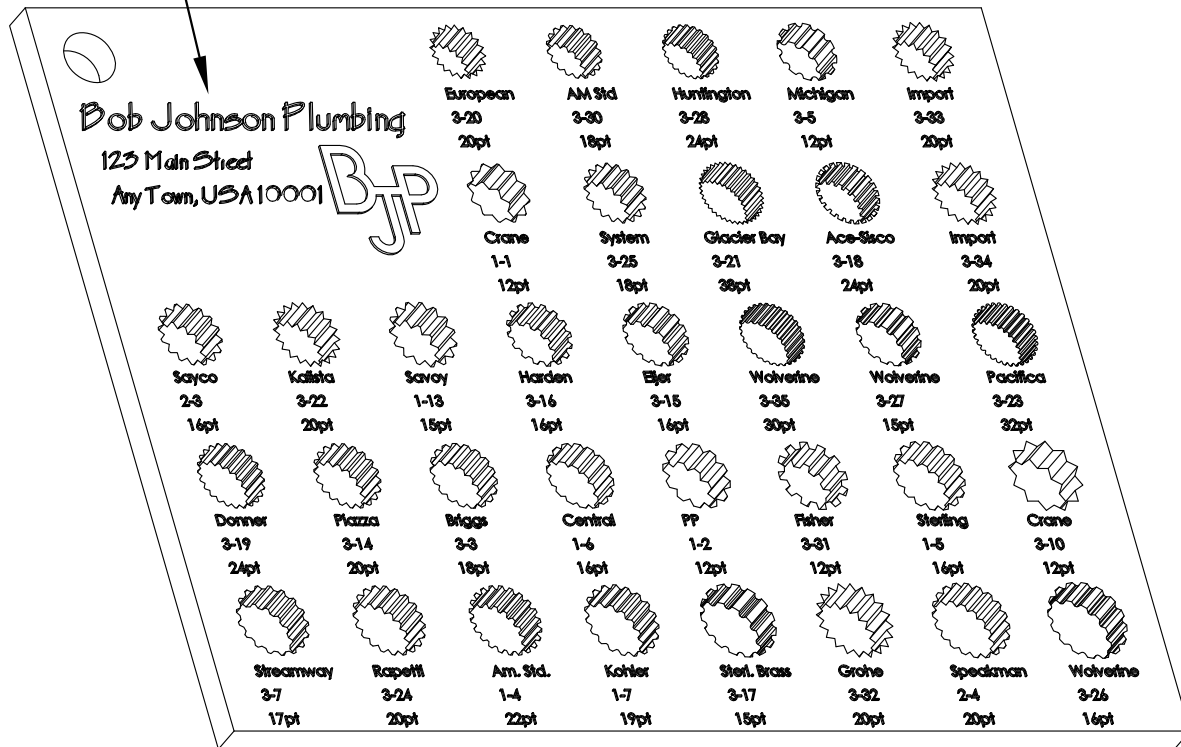

PART # 113740

This conveniently sized gauge (5.75" x 4.25") includes the following broaches, each labeled with the information listed below:

MANUFACTURER	ID #	POINTS	MANUFACTURER	ID #	POINTS	MANUFACTURER	ID #	POINTS
European	3-20	20	Savoy	1-13	15	Fisher	3-31	12
Am. Std.	3-30	18	Harden	3-16	16	Sterling	1-5	16
Huntington	3-28	24	Eljer	3-15	16	Crane	3-10	12
Michigan	3-5	12	Wolverine	3-35	30	Streamway	3-7	17
Import: 5/16	3-33	20	Wolverine	3-27	15	Eljer Rapetti	3-24	20
Crane	1-1	12	Pacifica	3-23	32	Am. Std.	1-4	22
System	3-25	18	Donner	3-19	24	Kohler	1-7	19
Glacier Bay	3-21	38	Am. Std. Piazza	3-14	20	Sterling Brass	3-17	15
Ace - Sisco	3-18	24	Briggs	3-3	18	Grohe	3-32	20
Import: 11/32	3-34	20	Central	1-6	16	Speakman	2-4	20
Sayco / Gerber	2-3	16	Price Pfister	1-2	12	Wolverine	3-26	16
Kalista	3-22	20						

O-RINGS

1/16" THICKNESS

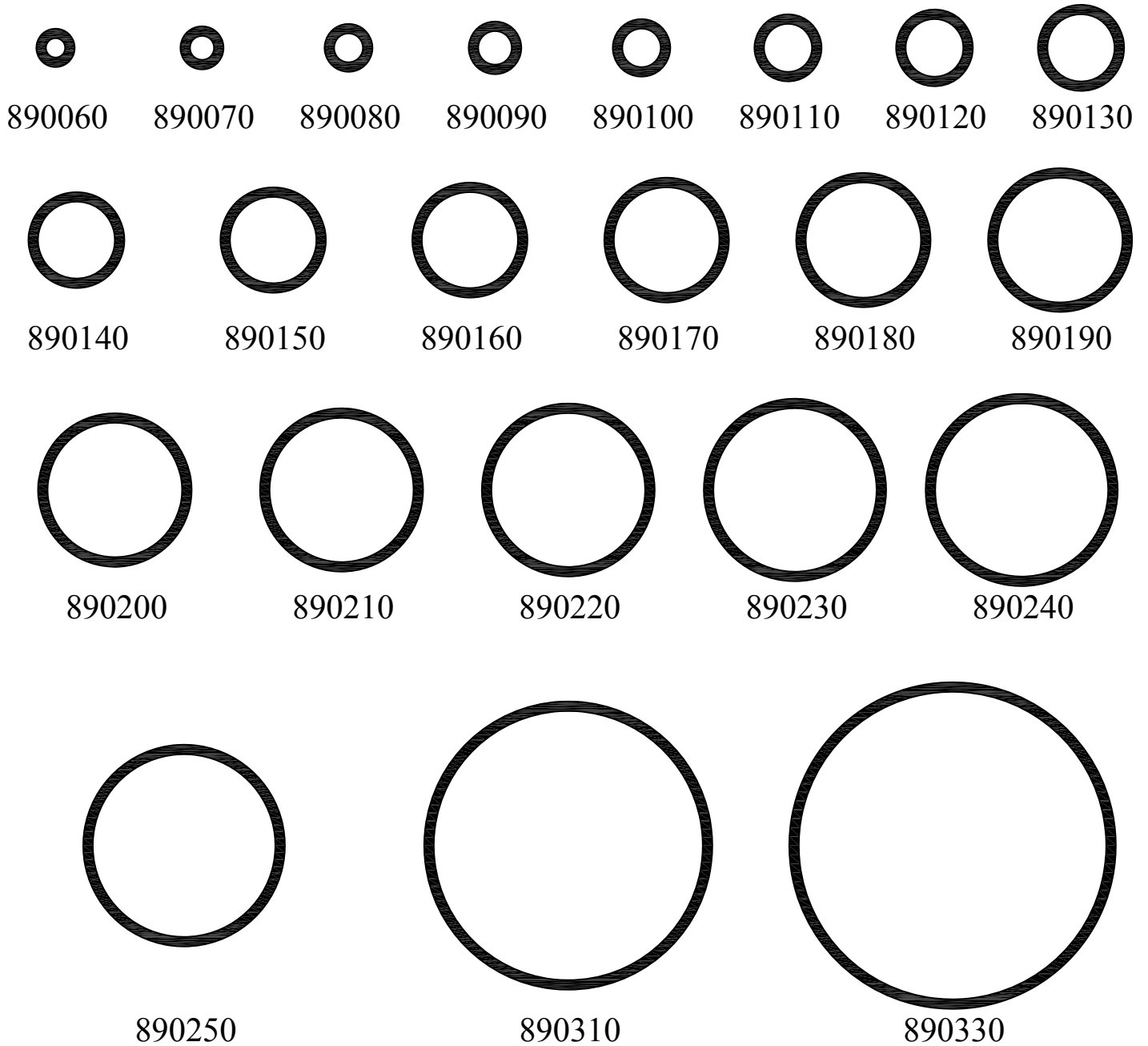

1/16" THICKNESS

PART #	O.D.	I.D.
890060	.250	.125
890070	.281	.156
890080	.312	.187
890090	.343	.218
890100	.375	.250
890110	.437	.312
890120	.500	.375
890130	.562	.437

PART #	O.D.	I.D.
890140	.625	.500
890150	.687	.562
890160	.750	.625
890170	.812	.687
890180	.875	.750
890190	.937	.812
890200	1.000	.875
890210	1.062	.937

PART #	O.D.	I.D.
890220	1.125	1.000
890230	1.187	1.062
890240	1.250	1.125
890250	1.312	1.187
890310	1.875	1.750
890330	2.125	2.000

O-RINGS

3/32" THICKNESS



891040



891080



891090



891100



891110

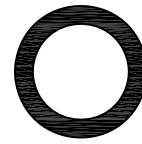

891120

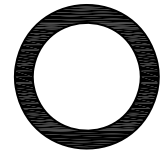

891130

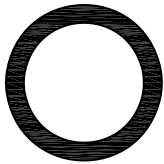

891140

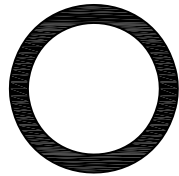

891150

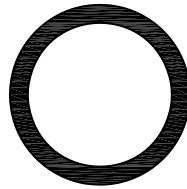

891160

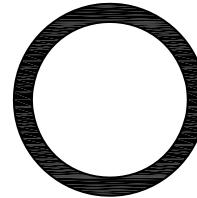

891170

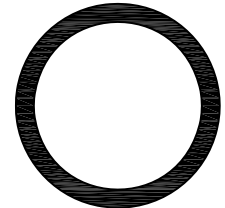

891180

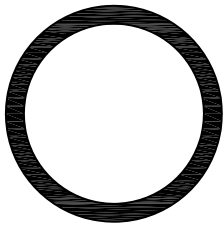

891190

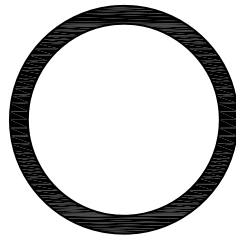

891200

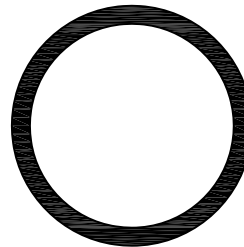

891210

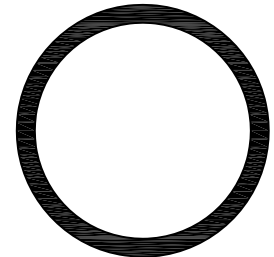

891220

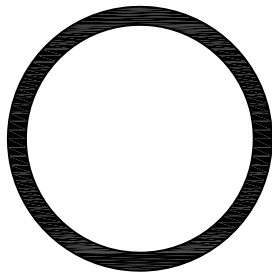

891230

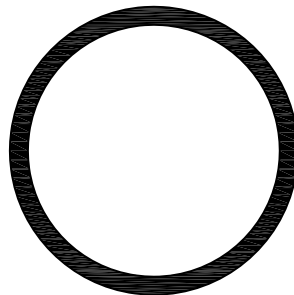

891250

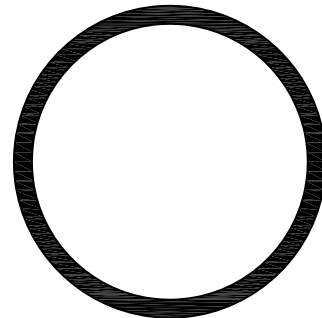

891270

3/32" THICKNESS

PART #	O.D.	I.D.
891040	.312	.125
891080	.437	.250
891090	.500	.312
891100	.562	.375
891110	.625	.437
891120	.687	.500
891130	.750	.562

PART #	O.D.	I.D.
891140	.812	.625
891150	.875	.687
891160	.937	.750
891170	1.000	.812
891180	1.062	.875
891190	1.125	.937
891200	1.187	1.000

PART #	O.D.	I.D.
891230	1.375	1.187
891250	1.500	1.312
891270	1.625	1.437
891210	1.250	1.062
891220	1.312	1.125

O-RINGS

1/8" THICKNESS



892030



892040

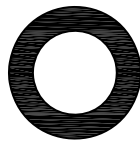

892050

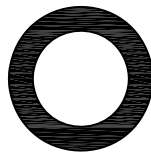

892060

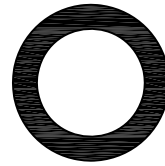

892070

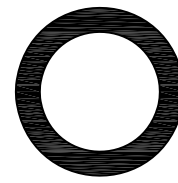

892080

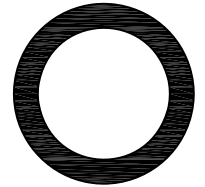

892090

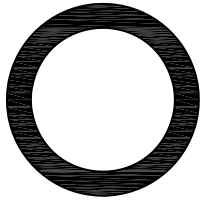

892100

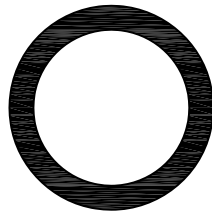

892110

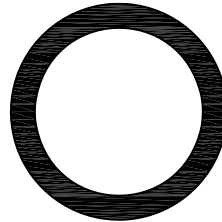

892120

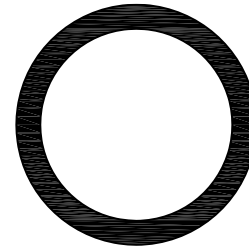

892140

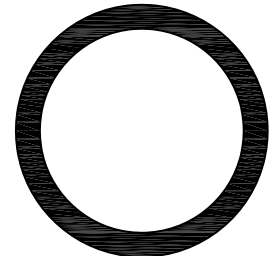

892150

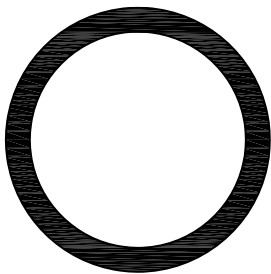

892160

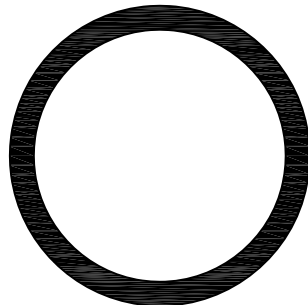

892190

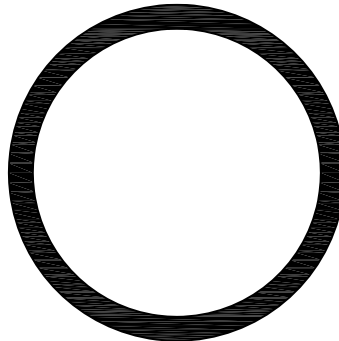

892220



893260

METRIC

SPECIAL



894030



894020



894040



894050



894010



894060

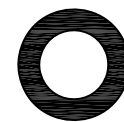

197690
.109 thickness



116170
.055 thickness

1/8" THICKNESS

3/16" THICKNESS

METRIC in mm

PART #	O.D.	I.D.
892030	.562	.312
892040	.625	.375
892050	.687	.437
892060	.750	.500
892070	.812	.562
892080	.875	.625
892090	.937	.687
892100	1.000	.750

PART #	O.D.	I.D.
892110	1.062	.812
892120	1.125	.875
892140	1.250	1.000
892150	1.312	1.062
892160	1.375	1.125
892190	1.562	1.312
892220	1.750	1.500

PART #	O.D.	I.D.
893260	2.000	1.625

SPECIAL

PART #	O.D.	I.D.
197690	.578	.359
116170	.599	.489

PART #	O.D.	I.D.
894010	10.0	12.0
894020	5.5	7.1
894030	5.0	7.0
894040	8.0	10.0
894050	8.5	11.0
894060	12.5	15.5

CAP GASKETS

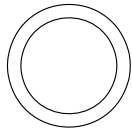

.500 x .640 x .062
895010

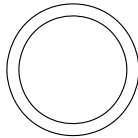

.562 x .687 x .032
895040



.625 x .695 x .032
199930

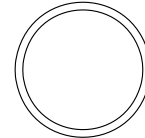

.625 x .705 x .062
895050

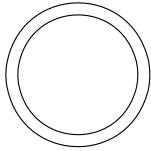

.625 x .750 x .032
895060

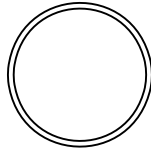

.690 x .750 x .032
894670

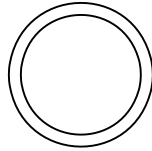

.625 x .750 x .062
895230

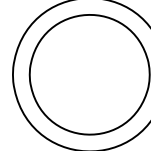

.625 x .800 x .062
895240

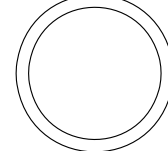

.690 x .820 x .032
895110

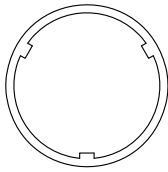

.760 x .845 x .065
895190

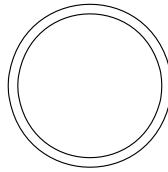

.750 x .850 x .062
895100

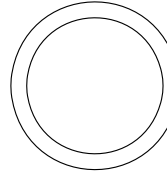

.710 x .875 x .062
895120

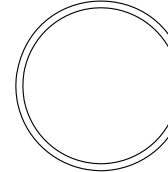

.812 x .885 x .062
895140

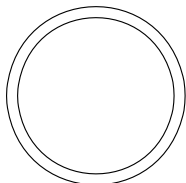

.815 x .930 x .062
895150

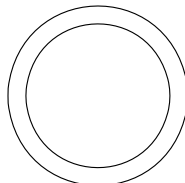

.750 x .937 x .032
895270

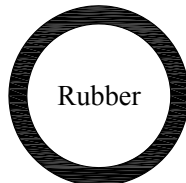

.750 x .937 x .125
895260

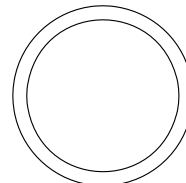

.793 x .937 x .040
895170

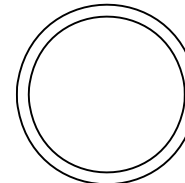

.813 x .937 x .032
895280

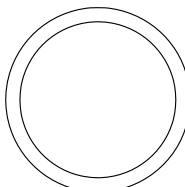

.812 x .960 x .062
895160

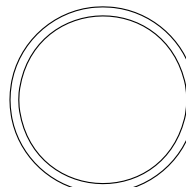

.875 x .968 x .062
895180

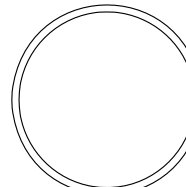

.915 x .990 x .125
861020

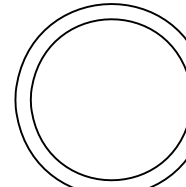

.840 x 1.000 x .062
895380

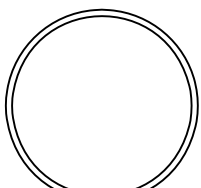

.935 x 1.000 x .032
895300

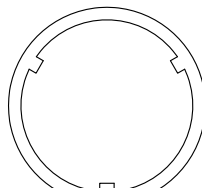

.895 x 1.025 x .065
895390

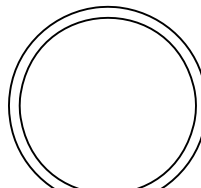

.918 x 1.030 x .030
895290

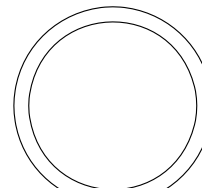

.875 x 1.030 x .062
895400

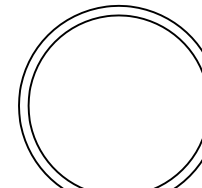

.940 x 1.040 x .062
895310

Dimensions listed as I.D. x O.D. x Thickness, with the part number listed below.

CAP GASKETS

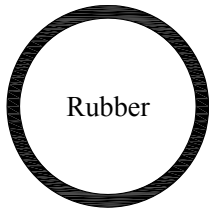

.920 x 1.050 x 1.000
818010

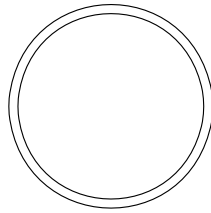

.968 x 1.062 x .062
895330

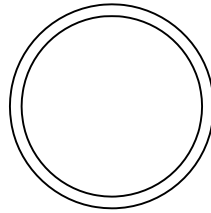

.940 x 1.062 x .062
895320

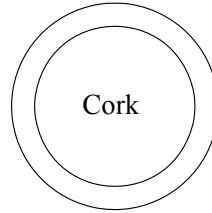

.835 x 1.075 x .094
895200

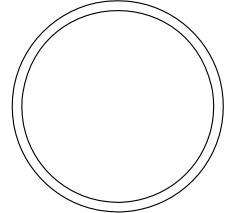

1.000 x 1.100 x .062
895340

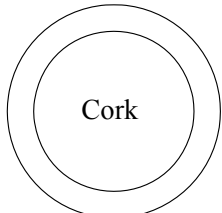

.835 x 1.110 x .135
895250

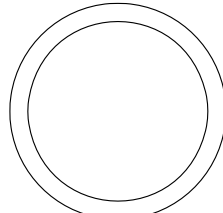

.937 x 1.125 x .062
895370

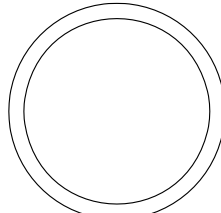

.968 x 1.125 x .062
895350

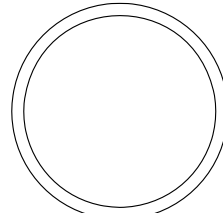

1.000 x 1.125 x .062
895550

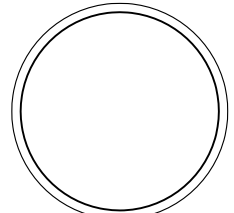

1.032 x 1.125 x .062
895540

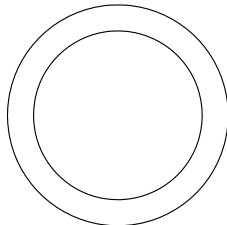

.879 x 1.150 x .062
895410

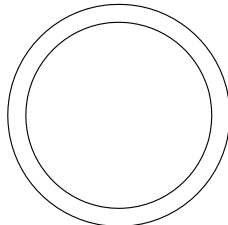

.968 x 1.156 x .062
199510

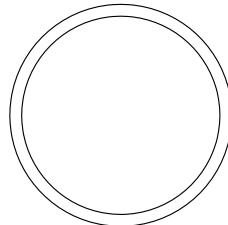

1.032 x 1.156 x .062
895560

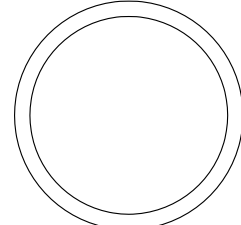

1.030 x 1.190 x .062
895570

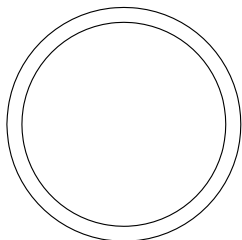

1.062 x 1.218 x .062
895440

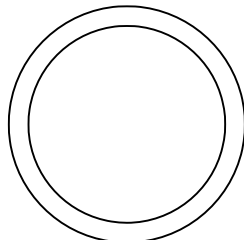

1.025 x 1.230 x .062
895420

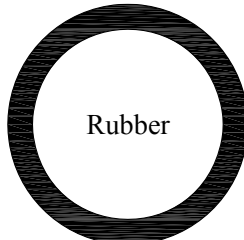

.993 x 1.250 x .125
818000

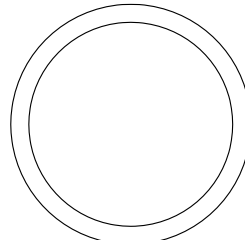

1.062 x 1.250 x .062
895430

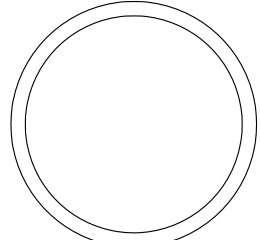

1.130 x 1.280 x .062
895450

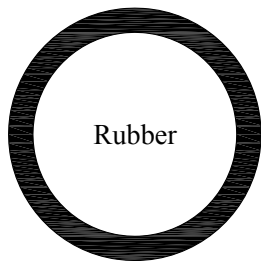

1.062 x 1.315 x .135
824600

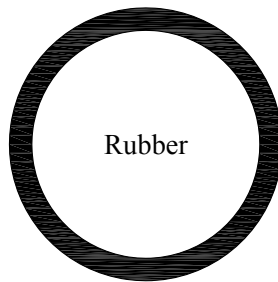

1.187 x 1.421 x .062
895460

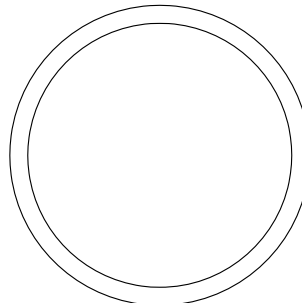

1.375 x 1.562 x .062
895500

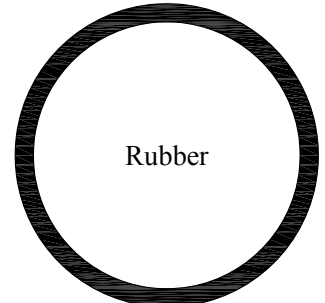

1.390 x 1.580 x .093
895480

Dimensions listed as I.D. x O.D. x Thickness, with the part number listed below.
Material may vary unless otherwise noted.

CAP GASKETS

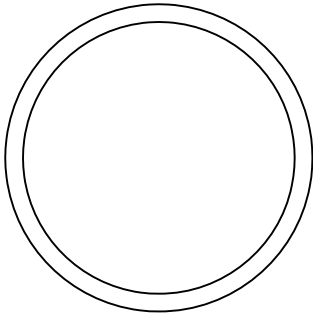

1.415 x 1.600 x .062
895520

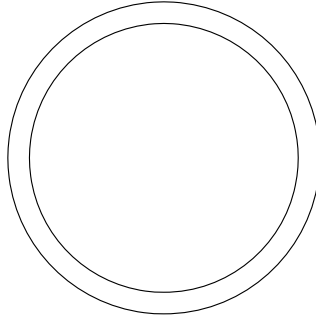

1.400 x 1.625 x .062
895510

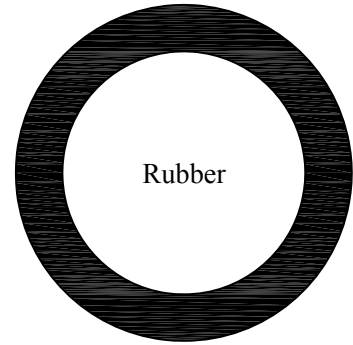

1.750 x 1.265 x .125
894680

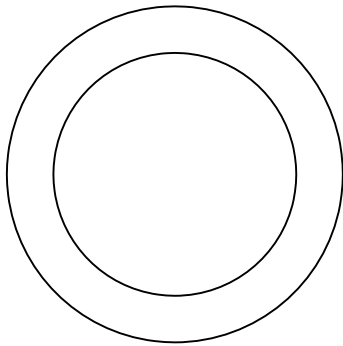

1.750 x 1.265 x .093
895530

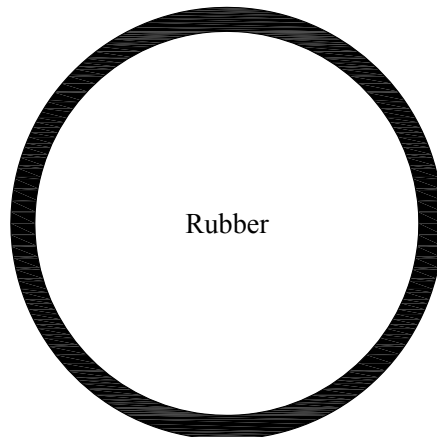

2.000 x 2.250 x .062
895490

Send Your Orders To:

BARRY E.  SR. CO.

E-mail: orderdesk@barrywalter.com

Fax: 1.800.886.9831

Phone: 1.800.767.5552

Dimensions listed as I.D. x O.D. x Thickness, with the part number listed below.

FRICION WASHERS



895860



895910



895850



895950



895590



895600

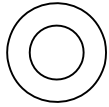

895790

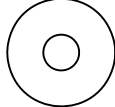

895880

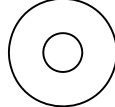

895800

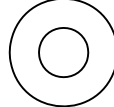

895810

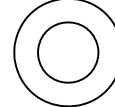

895940

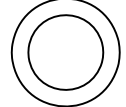

895820

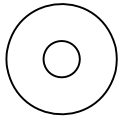

895840

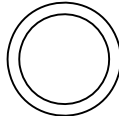

895580

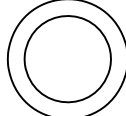

897000

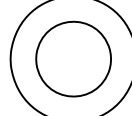

895610

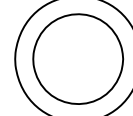

897020

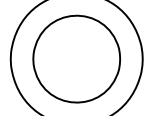

897010

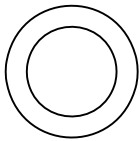

895630

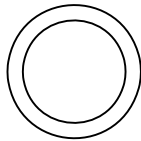

895620

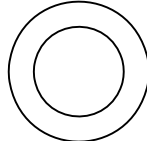

895660

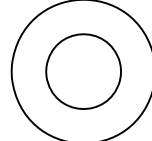

895650

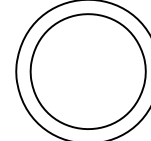

895640

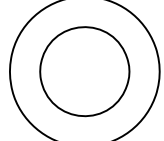

895670

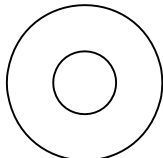

895730

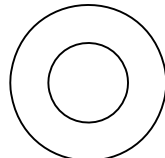

895700

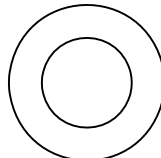

895680

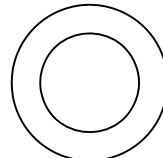

895690

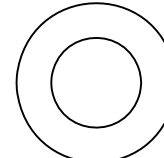

895710

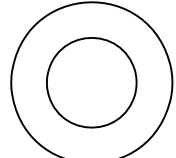

895830

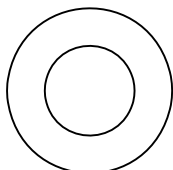

895720

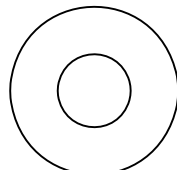

895890

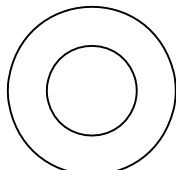

895870

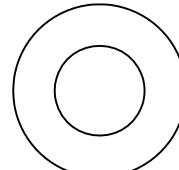

895740

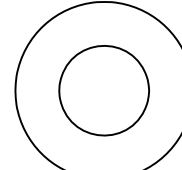

895750

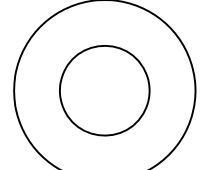

895760

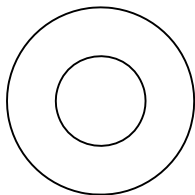

895770

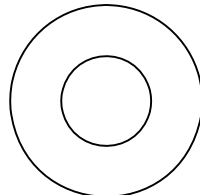

895780

Part #	O.D.	I.D.	Height
895860	.312	.203	.035
895910	.340	.160	.036
895850	.375	.290	.032
895950	.375	.125	.020
895590	.468	.390	.032
895600	.500	.375	.030
895790	.515	.281	.040
895880	.562	.187	.032

Part #	O.D.	I.D.	Height
895800	.562	.203	.062
895810	.562	.257	.062
895940	.562	.315	.090
895820	.562	.390	.025
895840	.575	.189	.050
895580	.590	.468	.032
897000	.625	.450	.050
895610	.656	.390	.040
897020	.656	.468	.030
897010	.687	.453	.032
895630	.687	.468	.030
895620	.695	.535	.032
895660	.730	.468	.050
895650	.750	.390	.040
895640	.750	.600	.050

Part #	O.D.	I.D.	Height
895670	.780	.468	.050
895730	.810	.328	.050
895700	.812	.415	.030
895680	.812	.468	.030
895690	.812	.515	.050
895710	.830	.468	.050
895830	.840	.468	.050
895720	.860	.468	.050
895890	.875	.380	.075
895870	.875	.468	.062
895740	.900	.468	.050
895750	.925	.468	.050
895760	.945	.468	.050
895770	.975	.468	.050
895780	1.000	.468	.050

TOP GASKETS

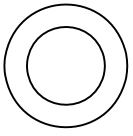

.640 x .406 x .052
894830

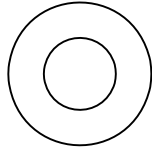

.745 x .375 x .047
124220

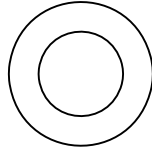

.750 x .442 x .062
894850

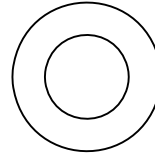

.775 x .437 x .087
894840

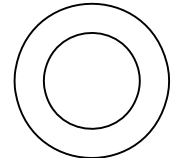

.805 x .500 x .062
894660

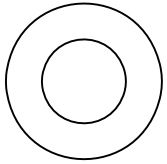

.812 x .437 x .031
894870

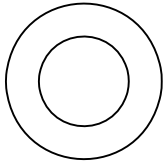

.812 x .468 x .062
894880

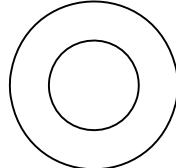

.875 x .468 x .062
894890

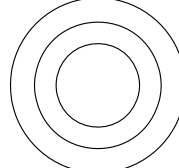
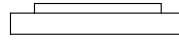

.910 x .435 x .160
894700
Delrin

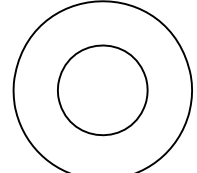

.930 x .468 x .062
894910

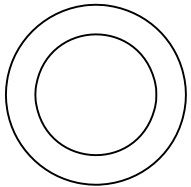

.937 x .630 x .062
894900

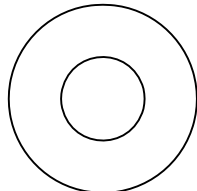

.980 x .435 x .087
894920

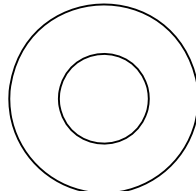

.985 x .468 x .062
894930

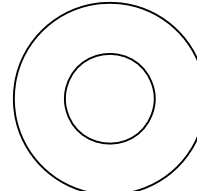

1.000 x .468 x .062
894940

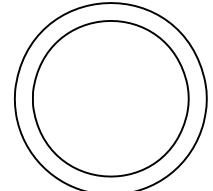

1.000 x .815 x .062
161390

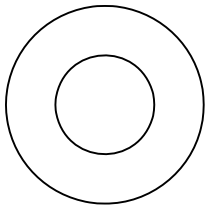

1.030 x .515 x .062
894860

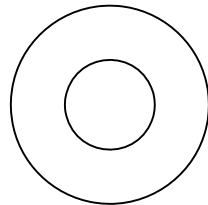

1.032 x .468 x .062
894950

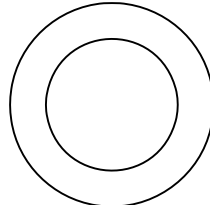

1.060 x .687 x .062
894820

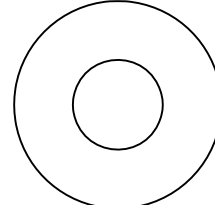

1.080 x .468 x .062
894960

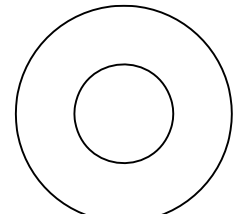

1.125 x .515 x .062
155290

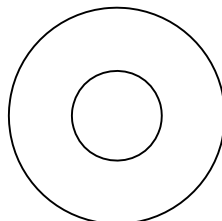

1.125 x .468 x .062
894970

PACKINGS

<p>31/64 O.D.</p> <p>3/8"</p> <p>1/4"</p> <p>896010</p>	<p>11/32"</p> <p>9/16 O.D.</p> <p>17/64"</p> <p>896130</p>	<p>3/8"</p> <p>3/16"</p> <p>896410</p>	<p>3/8"</p> <p>1/4"</p> <p>896050</p>	<p>3/8"</p> <p>3/8"</p> <p>896060</p>
<p>7/32"</p> <p>9/32"</p> <p>FOR T&S PRE-RINSE 896430</p>	<p>5/16"</p> <p>19/32 O.D.</p> <p>3/16"</p> <p>896420</p>	<p>3/8"</p> <p>5/8 O.D.</p> <p>7/32"</p> <p>896240</p>	<p>7/16"</p> <p>7/32"</p> <p>896020</p>	<p>5/16"</p> <p>1/4"</p> <p>896350</p>
<p>3/8"</p> <p>5/16"</p> <p>896030</p>	<p>3/8"</p> <p>15/32"</p> <p>896150</p>	<p>13/32"</p> <p>3/16"</p> <p>FOR CHICAGO 896600</p>	<p>13/32"</p> <p>21/32 O.D.</p> <p>1/4"</p> <p>896080</p>	<p>27/64"</p> <p>1/4"</p> <p>896110</p>
<p>11/16 O.D.</p> <p>13/32"</p> <p>1/4"</p> <p>896120</p>	<p>13/32"</p> <p>5/16"</p> <p>896140</p>	<p>3/8"</p> <p>5/16"</p> <p>896070</p>	<p>27/64"</p> <p>17/64"</p> <p>896310</p>	<p>7/16"</p> <p>5/16"</p> <p>896040</p>
<p>29/64"</p> <p>1/8"</p> <p>896190</p>	<p>3/8"</p> <p>23/32 O.D.</p> <p>7/32"</p> <p>FOR AM STD COLONY 896750</p>	<p>3/8"</p> <p>47/64 O.D.</p> <p>23/64"</p> <p>FOR SCHAIBLE 896760</p>	<p>13/32"</p> <p>3/4 O.D.</p> <p>5/16"</p> <p>896100</p>	<p>3/8"</p> <p>5/16"</p> <p>896090</p>
<p>7/16"</p> <p>5/16"</p> <p>896180</p>	<p>13/32"</p> <p>19/64"</p> <p>FOR STERLING 896440</p>	<p>15/32"</p> <p>3/8"</p> <p>896170</p>	<p>1/2"</p> <p>3/16"</p> <p>896250</p>	<p>1/2"</p> <p>5/16"</p> <p>896160</p>
<p>37/64"</p> <p>9/32"</p> <p>896550</p>	<p>19/32"</p> <p>25/32 O.D.</p> <p>11/32"</p> <p>896200</p>	<p>13/32"</p> <p>13/16 O.D.</p> <p>1/4"</p> <p>896220</p>	<p>7/16"</p> <p>5/16"</p> <p>896280</p>	<p>1/2"</p> <p>9/16"</p> <p>896230</p>
<p>27/32 O.D.</p> <p>3/8"</p> <p>5/32"</p> <p>896300</p>	<p>3/8"</p> <p>55/64 O.D.</p> <p>5/16"</p> <p>FOR SCHAIBLE 896770</p>	<p>3/8"</p> <p>7/8 O.D.</p> <p>3/8"</p> <p>896270</p>	<p>5/8"</p> <p>13/64"</p> <p>896500</p>	<p>3/8"</p> <p>9/32"</p> <p>FOR 455121 896610</p>
<p>57/64 O.D.</p> <p>1/2"</p> <p>3/8"</p> <p>896260</p>	<p>7/16"</p> <p>29/32 O.D.</p> <p>5/16"</p> <p>896290</p>	<p>27/64"</p> <p>31/32 O.D.</p> <p>21/64"</p> <p>FOR SCHAIBLE 896780</p>		

DIVERTER WASHERS

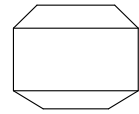
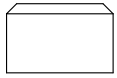
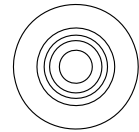
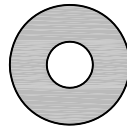
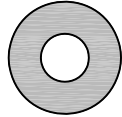

FOR AM STD
72840-07

FOR SEARS
157250

FOR SAYCO
137940

FOR KOHLER
101310
OEM# 22942

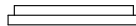
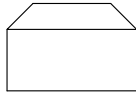
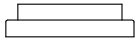
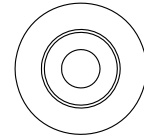
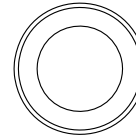
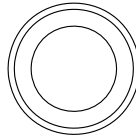
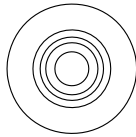
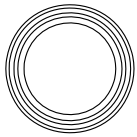

FOR AM STD
830440

FOR HELVEX
109050

FOR ELJER
831000

FOR KOHLER
833180

FOR PRICE PFISTER
151580
OEM# 949-260

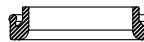
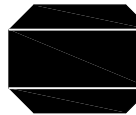
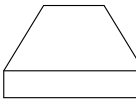
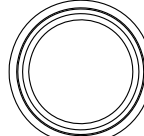
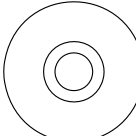
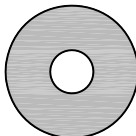
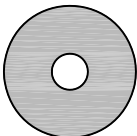

FOR SPEAKMAN
833000

FOR SAVOY
144640

FOR SYMMONS
830720

FOR MUELLER
838200

FOR AM STD
830660

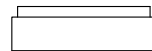
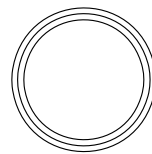
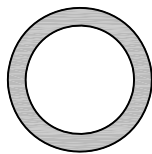
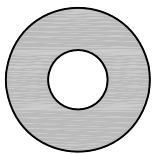

FOR SAVOY
839120

FOR DICK BROTHERS
830610

FOR KOHLER
103340

FOR WOLVERINE
831070

FOR ELJER
830190

DIVERTER WASHERS

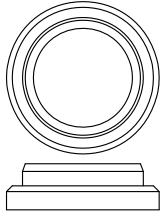

FOR HARDEN
839720

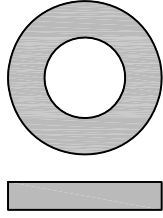

FOR AM. BRASS
838700

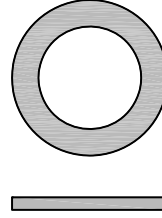

FOR CENTRAL BRASS
830400

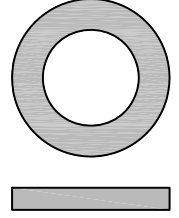

FOR SYMMONS
833280

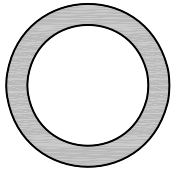

FOR DICK BROTHERS
835300

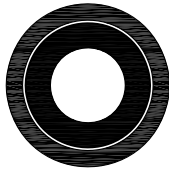

FOR AM STD
134370

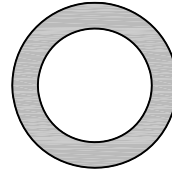

FOR BRIGGS
831500

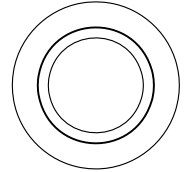

FOR KOHLER
101380
OEM# 22927

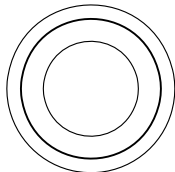

FOR STERLING
830800

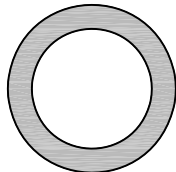

FOR REPCAL
831900

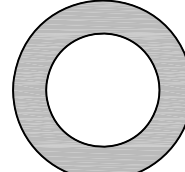

FOR SPEAKMAN
833200

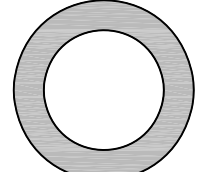

FOR PRICE PFISTER
830300

BARRY E.  SR. CO.

BIBB WASHERS

STANDARD



1/8
898000



000
898130



00
898010
SOFT: 898170



0
898020
SOFT: 898200



1/4
898030
SOFT: 898230



1/4L
898040



3/8
898050
HARD: 898250



3/8M
898060



3/8L
898070
HARD: 898270
SOFT: 898190



1/2
898080
HARD: 898280



1/2L
898090



5/8
898100

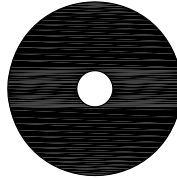

5/8L
898110

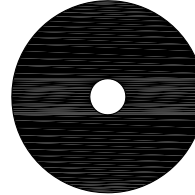

3/4
898120

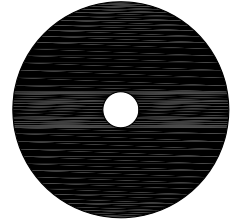

1 1/8
898140

BEVELED



00
898310



0
898320



1/4
898330



3/8M
898360



1/2
898380

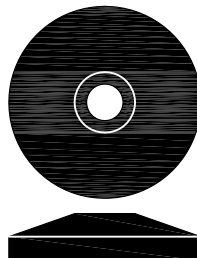

3/4
898420

SPECIAL WASHERS



FOR AM. STD.
156200



FOR CHICAGO
865040



FOR PRICE PFISTER
857200
OEM# 949-360



FOR SYMMONS-HOT
898150

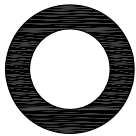

FOR PRICE PFISTER
858070



FOR AM. STD.
103270

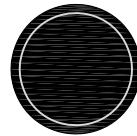

FOR AM. STD.
853020

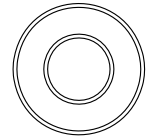

FOR T&S
862400

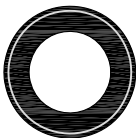

FOR BRIGGS
853030

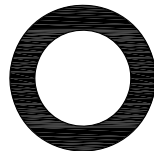

FOR CENTRAL
862050

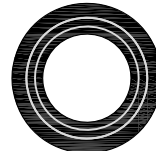

FOR CRANE
862010
HARD: 865120
SOFT: 865150

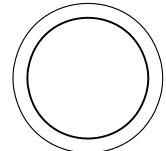

FOR CRANE
858700

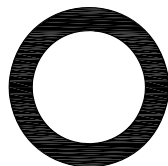

FOR T&S
138570

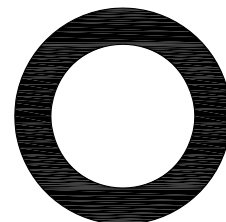

FOR SYMMONS-COLD
898160

CERAMIC SEALS

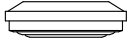
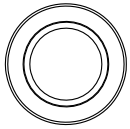

898500

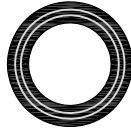

898540 for PP
OEM# 950-985

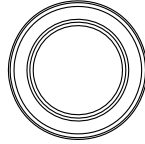

898600

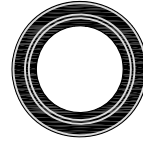

898510

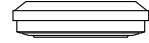
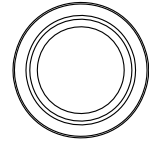

898510-W

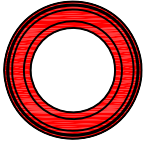

898570-R

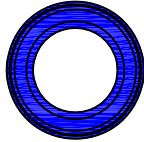

898570-B

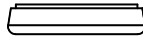
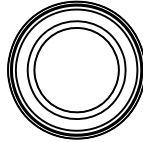

898570-W

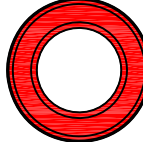

898580-R

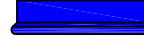
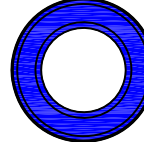

898580-B

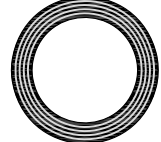

898550 for PP
OEM# 950-980

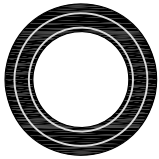

898590

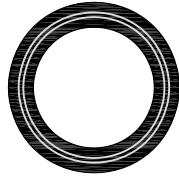

898530

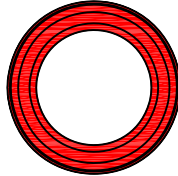

898610-R

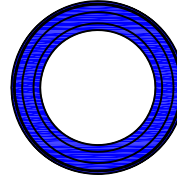

898610-B

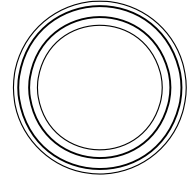

898520

CERAMIC DISC SETS

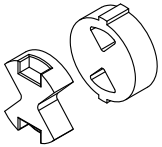

125390-PKG

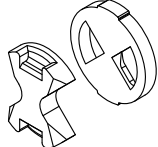

112530-PKG

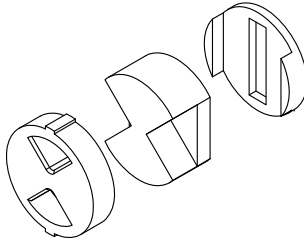

115520-PKG

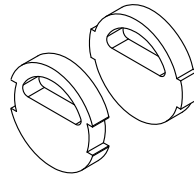

124290-PKG

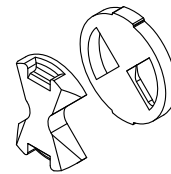

151380-PKG

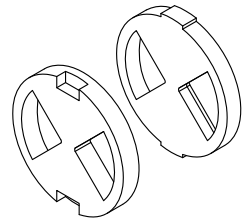

109850-PKG

CERAMIC DISC & SEAL KITS

132810

KIT INCLUDES:

- (1) 109850-PKG
- (1) 895050 GASKET
- (1) 898520 SEAL

143700

KIT INCLUDES:

- (1) 124290-PKG
- (1) 895180 GASKET
- (1) 898570-R SEAL

143750

KIT INCLUDES:

- (1) 151380-PKG
- (1) 898510-W SEAL

143820

KIT INCLUDES:

- (1) 124290-PKG
- (1) 898550 SEAL

SCREWS

Chrome Plated Brass Handle Screws

8-32 x 1/4" Oval	899390
8-32 x 1/2" Oval	899540
8-32 x 1/2" Round	899660
8-32 x 3/4" Oval	899550
8-32 x 3/4" Round	899670
8-32 x 1" Oval	899560
8-32 x 1" Round	899680
10-24 x 1/2" Oval	899570
10-24 x 1/2" Round	899690
10-24 x 3/4" Oval	899580
10-24 x 3/4" Round	899700
10-24 x 1" Oval	899590
10-24 x 1" Round	899710
10-28 x 1/2" Oval	899600
10-28 x 1/2" Round	899720
10-28 x 3/4" Oval	899610
10-28 x 3/4" Round	899730
10-28 x 1" Oval	899620
10-28 x 1" Round	899740
10-32 x 1/2" Oval	899630
10-32 x 1/2" Round	899750
10-32 x 3/4" Oval	899640
10-32 x 3/4" Round	899760
10-32 x 1" Oval	899650
10-32 x 1" Round	899770

Oval Head



Round Head

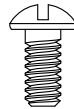

Brass Bibb Screws - Phillips Head

8-32 x 1/4" Bibb	899130
8-32 x 3/8" Bibb	899010
8-32 x 1/2" Bibb	899410
10-24 x 3/8" Bibb	899020
10-24 x 1/2" Bibb	899420
10-28 x 3/8" Bibb	899040
10-28 x 1/2" Bibb	899440
10-32 x 3/8" Bibb	899030
10-32 x 1/2" Bibb	899430



Brass Screws

8-32 x 1-1/4" Bibb	899080
10-24 x 1-1/2" Bibb	899090
10-32 x 1-1/2" Bibb	899100

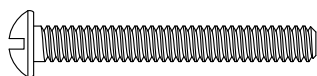

Round Head

10/32 x 1/2"
Stainless Steel
Philister Head

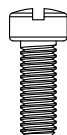

899210

Stainless Steel Handle Screws

10-24 x 1/2"	192090
10-24 x 3/4"	899380
10-24 x 1-3/4"	199580

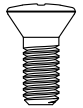

Oval Head

Stainless Steel Screws

6-32 x 1/4"	899270
8-32 x 1/2"	173560
8-32 x 1-1/2"	899460
10/24 x 1-1/4"	899530
10/32 x 1/2"	155720

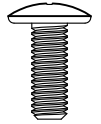

Truss Head

Stainless Steel Screws

6-32 x 3/16"	899350
10/24 x 1/2"	899140
10/24 x 5/8"	159990
10/32 x 5/16"	899150
10/32 x 1-1/4"	169920
1/4-20 x 1"	899360



Pan Head

Stainless Steel Screws

8-32 x 1-3/8"	899450
10/24 x 1"	899300
10/24 x 1-1/2"	899310
10/24 x 4"	133250



Flat Head

Stainless Steel Bibb Screws

6-32 x 1/4"	899110
6-32 x 3/8"	156410

Stainless Steel Screws

8-32 x 2-3/8"	121820
8-32 x 3"	899120
10/24 x 5/8"	899400
10/24 x 3/4"	899480
10/24 x 1-3/4"	104040
10/24 x 2-1/4"	102430
10/32 x 1-1/2"	899330

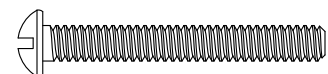

Round Head

SEAT WRENCHES

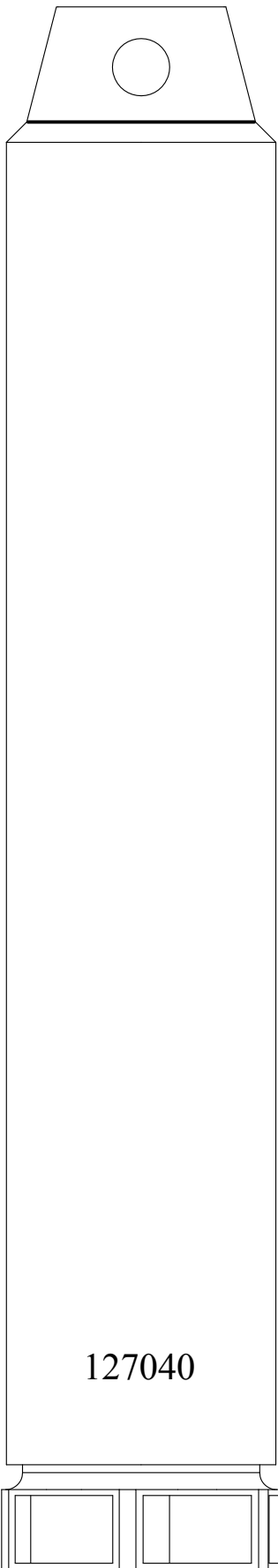

127040

Packaging Tube

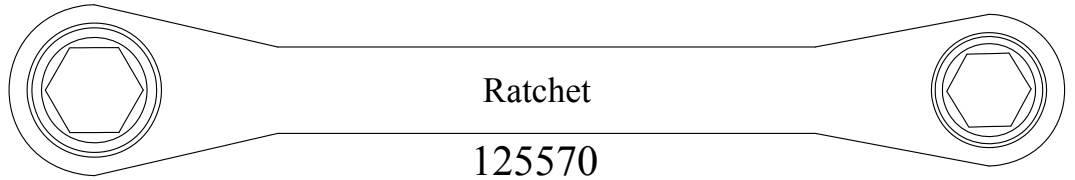

Ratchet

125570

THESE TOOLS ARE ALL HARDENED & COATED WITH BLACK OXIDE WITH THE EXCEPTION OF THE RATCHET

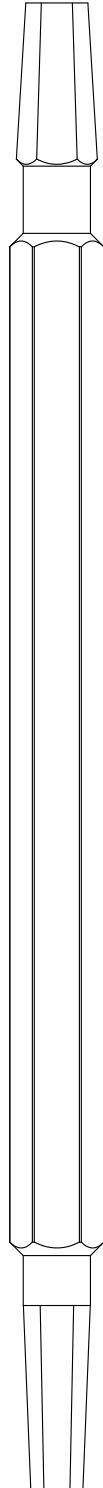

121580

Hex Wrench

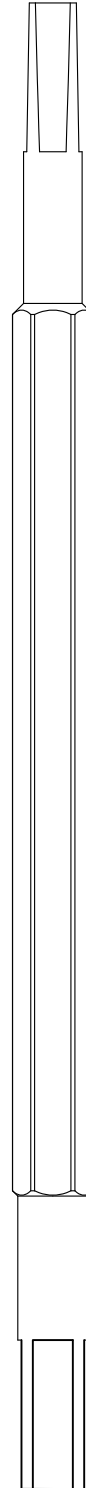

121510

Small Square Wrench

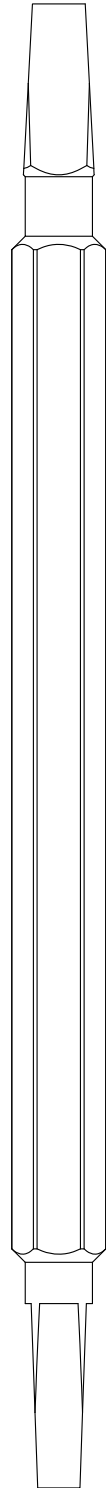

121440

Large Square Wrench

SEAT WRENCHES

THESE TOOLS ARE ALL HARDENED
& COATED WITH BLACK OXIDE

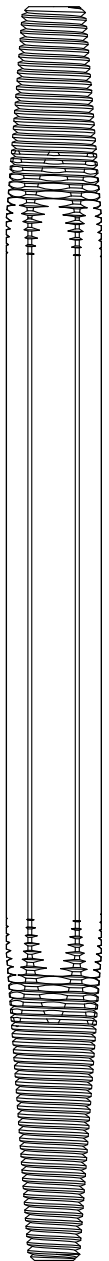

Easy-Out Wrench

134790

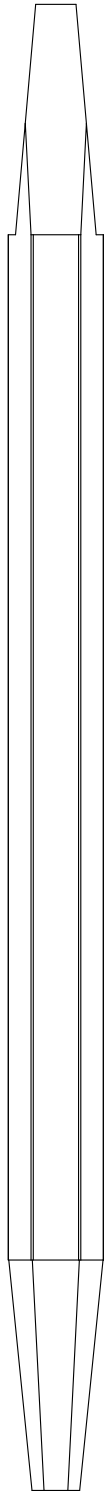

Squex Wrench

121650



Mobile Home Wrench

192790

Available Wrench Kits

125500 - Kit Includes:
Packaging Tube with
Hex Wrench
Small Square Wrench
Large Square Wrench
and Ratchet Wrench

132850 - Kit Includes:
All items from 125500
+ Easy-Out Wrench

132920 - Kit Includes:
All items from 125500
+ Squex Wrench

132990 - Kit Includes:
All items from 125500
+ Easy-Out Wrench
and Squex Wrench

SEAT WRENCHES

THESE TOOLS ARE ALL HARDENED & COATED WITH BLACK OXIDE

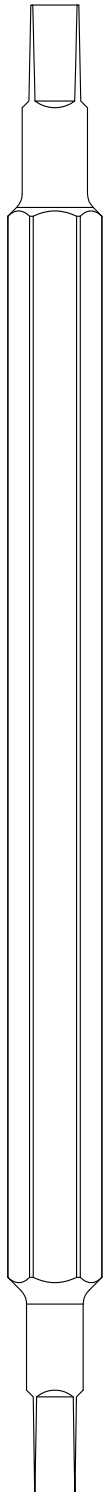

Small Square Wrench

116450

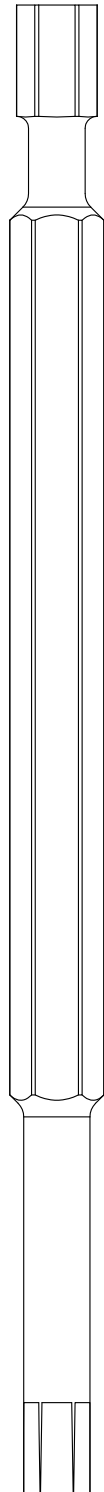

Small Hex Wrench

116730

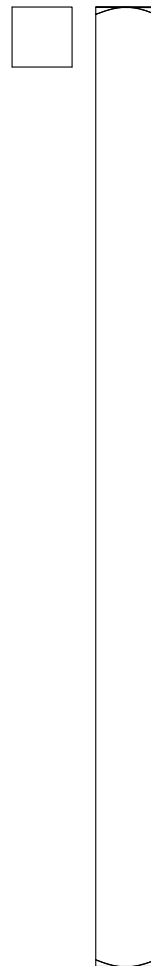

Symmons Hot Seat Wrench

123220

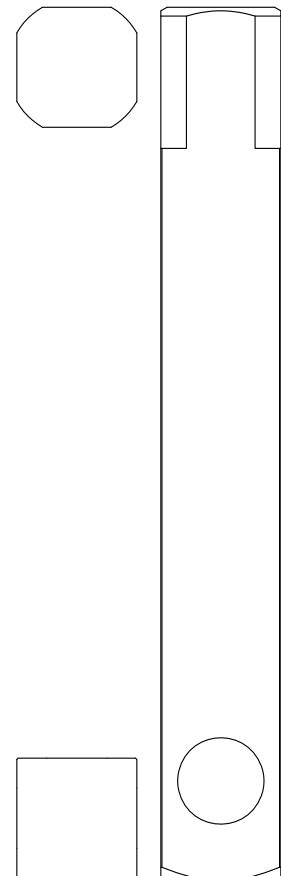

Symmons Hot Cold Wrench

123240

Available Wrench Kits

123150 - Kit Includes:
Symmons Hot Seat Wrench
Symmons Cold Seat Wrench

SEAT WRENCHES

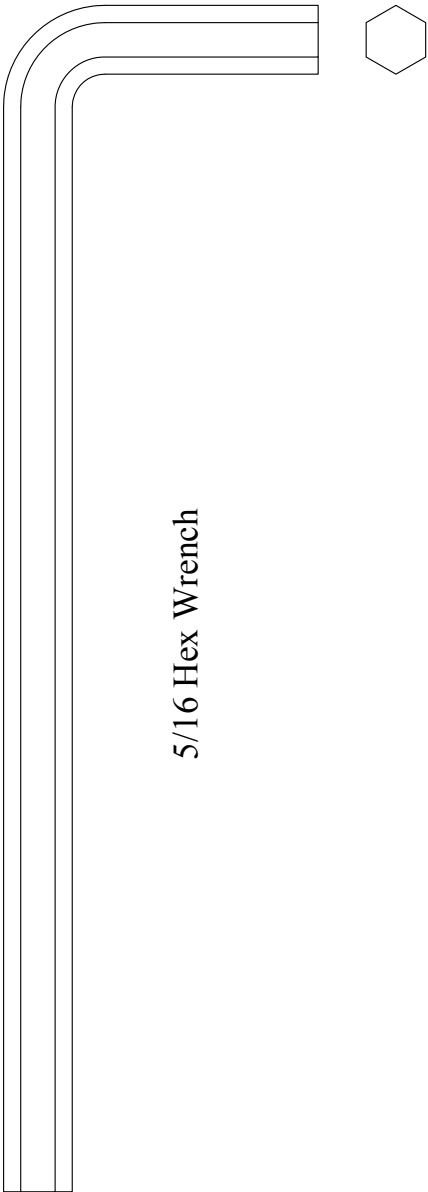

5/16 Hex Wrench

127720

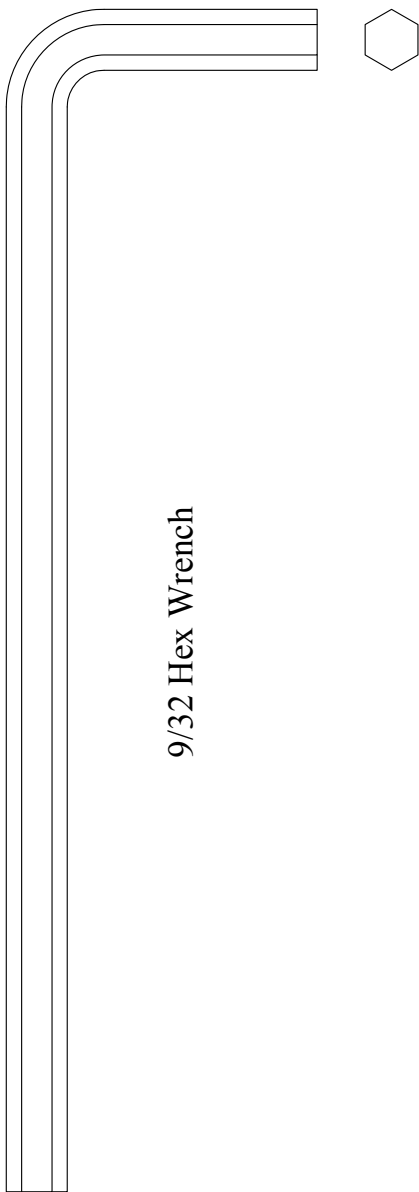

9/32 Hex Wrench

127790

Send Your Orders To:

BARRY E.  ALTER SR. CO.

E-mail: orderdesk@barrywalter.com

Fax: 1.800.886.9831

Phone: 1.800.767.5552

ONA PULLER

FOR EXTRACTING MOEN VALVE CARTRIDGES

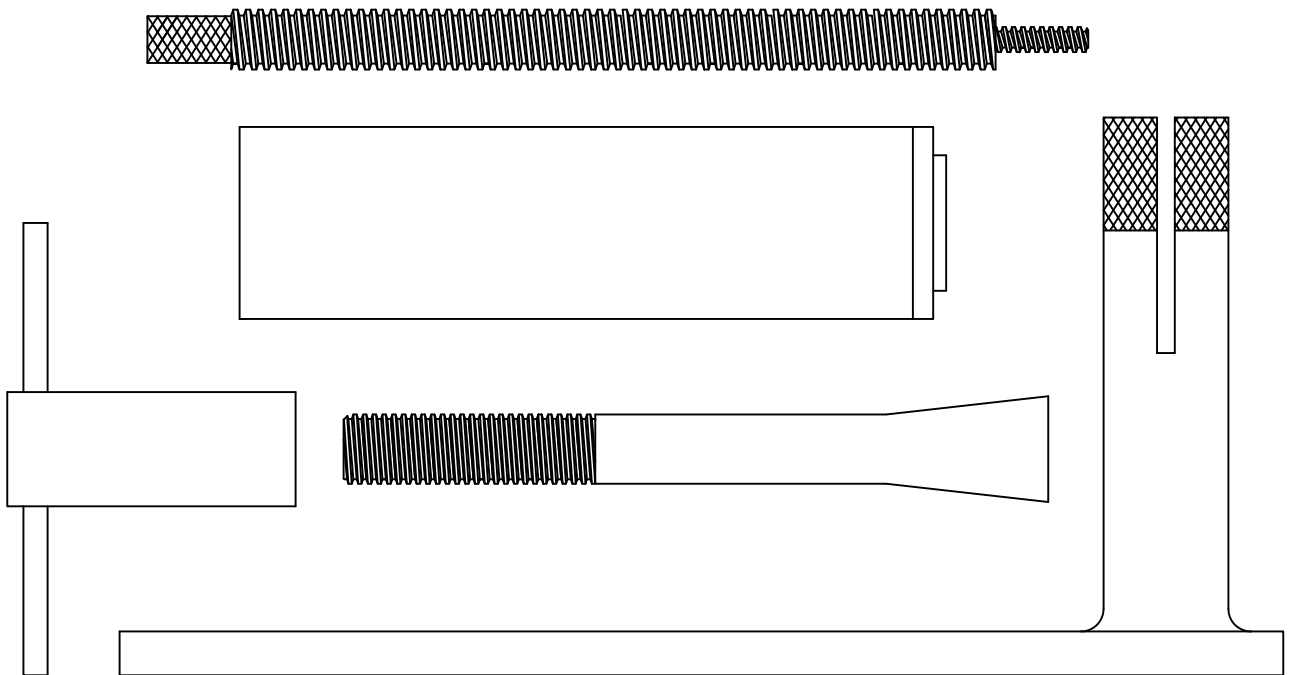
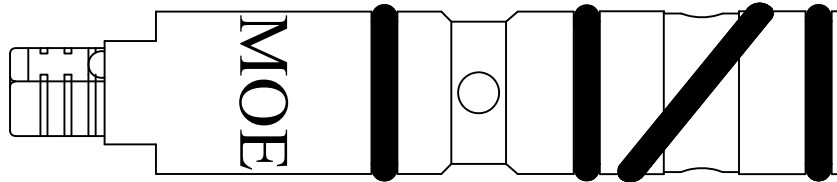

PART# 999150

ALL TOOLS ARE DRAWN TO SCALE
ALL TOOLS ARE HARDENED & COATED WITH BLACK OXIDE

WASTE SHOE REMOVAL TOOL

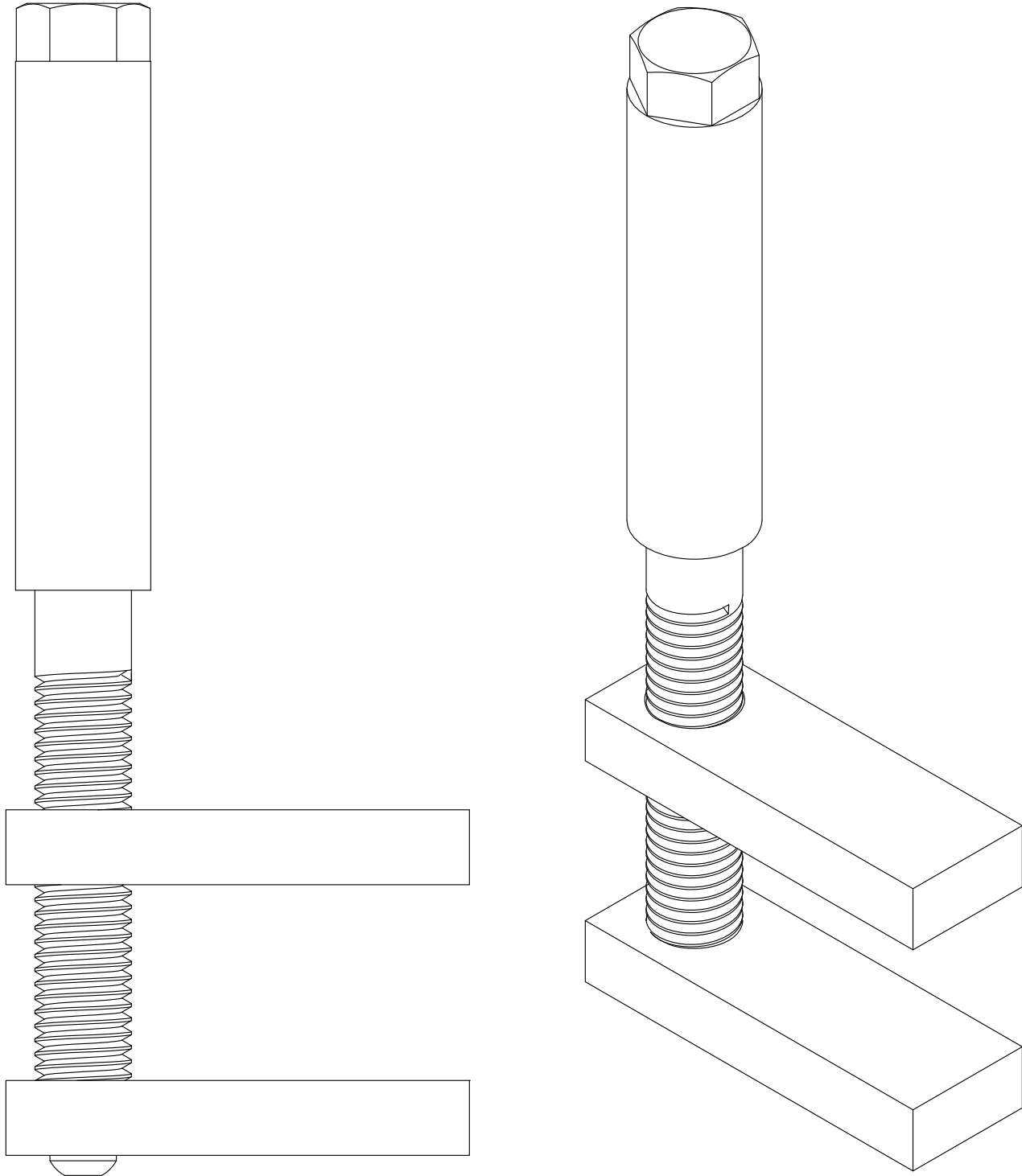

PART# 120670

THIS TOOL IS HARDENED & COATED WITH BLACK OXIDE

T-HANDLE FOR STOP STEMS

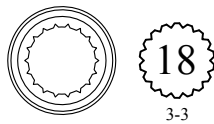
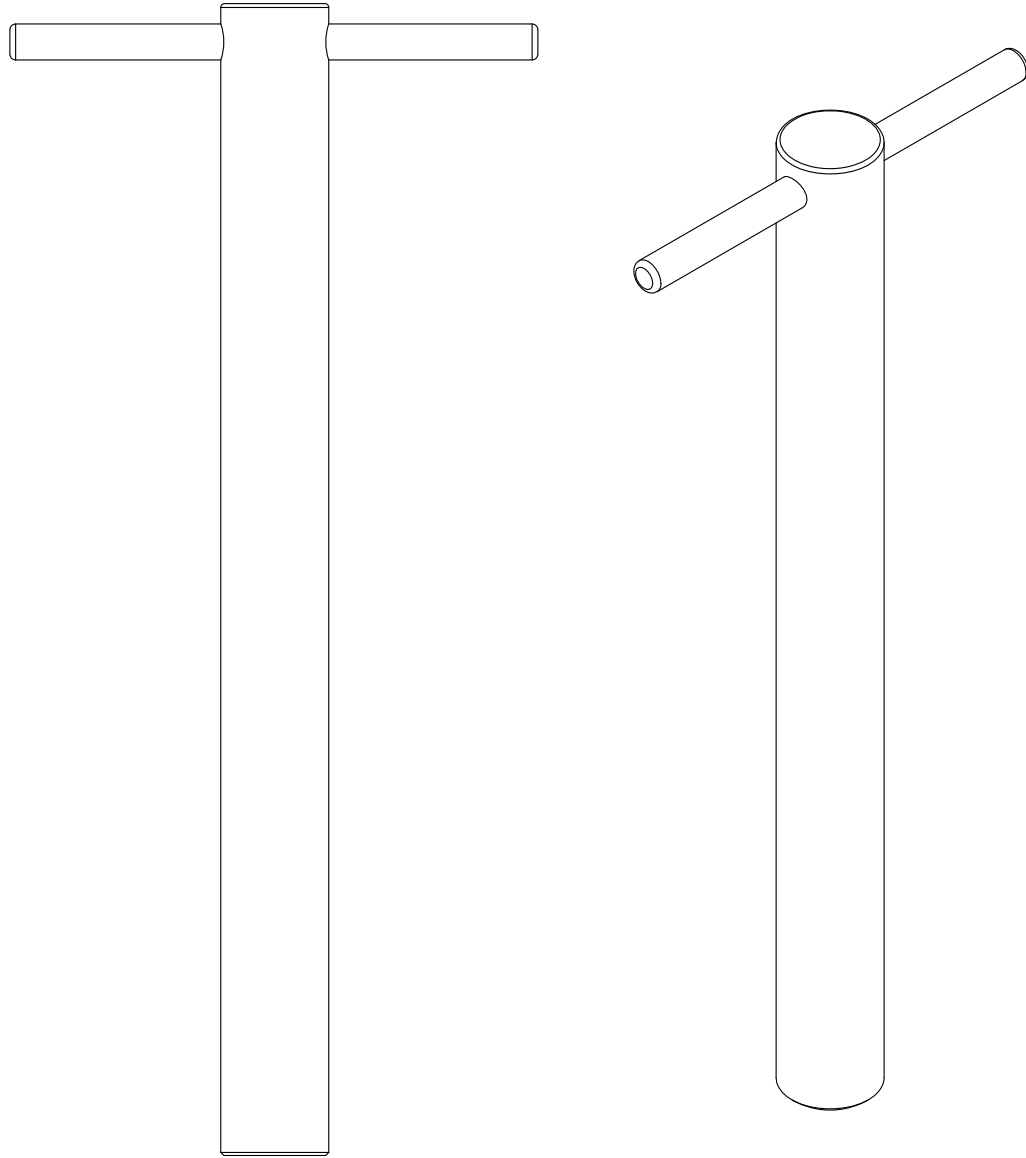

PART# 999010

SLOAN NIPPLE WRENCH

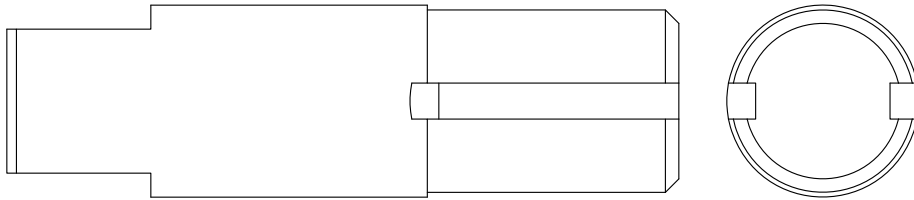
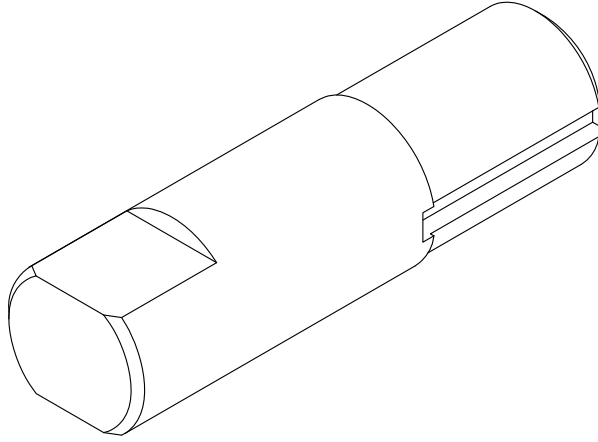

PART# 141810
Stainless Steel

Send Your Orders To:

BARRY E.  **WALTER**  SR. CO.

E-mail: orderdesk@barrywalter.com

Fax: 1.800.886.9831

Phone: 1.800.767.5552

BARRY E.  WALTER SR. CO.

ADAPTERS

ADAPTERS

Compression Hose Adapters

3/8 Compression Male

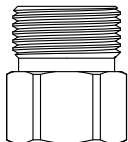

1/4 Compression Female
LF126900

3/8 Compression Male

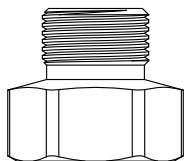

16mm x 1.25 Female
LF102920

3/8 Compression Male

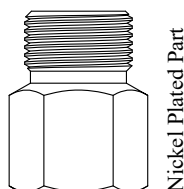

3/8 Compression Female
(Flare Style)
LF134980

Nickel Plated Part

1/4 Compression Male

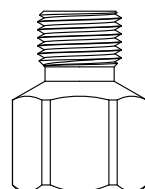

3/8 Compression Female
(Flare Style)
LF135050

Nickel Plated Part

3/8 Compression Male

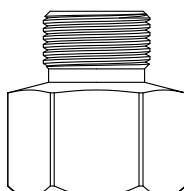

1/2 Compression Female
(Flare Style)
LF122840

Nickel Plated Part

3/8 - 18 NPT Male

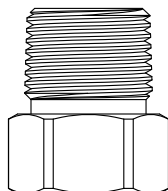

3/8 Compression Female
LF171110

Nickel Plated Part

3/8 Compression Male

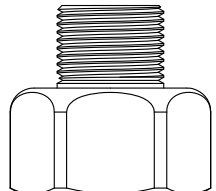

1/2 - 14 NPS Female
LF149200

Nickel Plated Part

3/8 Compression Male

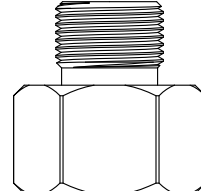

1/2 Compression Female
LF105060

Also Available
Chrome Plated
LF105060-CP

1/2 Compression Male

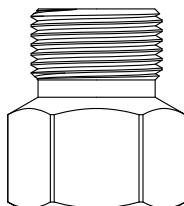

1/2 Flare Female
LF133340

1/2 - 14 NPS Male

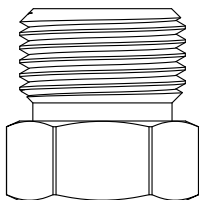

3/8 Compression Female
LF104920

1/2 - 14 NPS Male

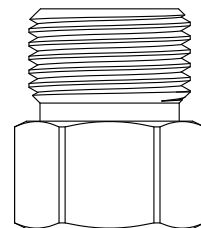

1/2 Compression Female
LF104990

Also Available
Chrome Plated
LF104990-CP

3/8 Compression Male

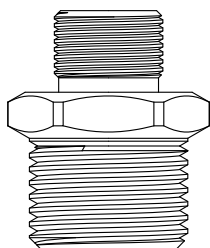

1/2 - 14 NPT Male
LF115940

Nickel Plated Part

5/16 Compression Male

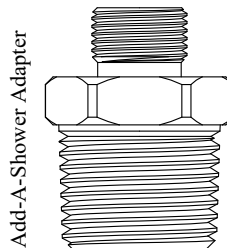

1/2 - 14 NPT Male
171180

Add-A-Shower Adapter

ADAPTERS

Supply Hose Adapters

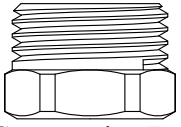
1/2 - 14 NPS Male

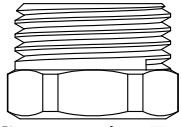
 Nickel Plated
 1/4 Compression Female
LF180080

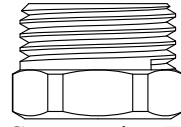
1/2 - 14 NPS Male

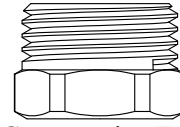
 Nickel Plated
 3/8 Compression Female
LF180150

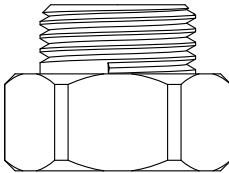
1/2 - 14 NPS Male

 Nickel Plated
 7/16 Compression Female
LF180220

1/2 - 14 NPS Male

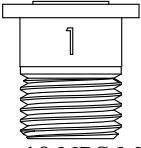
 Nickel Plated
 1/2 Compression Female
LF180290

1/2 - 14 NPS Male

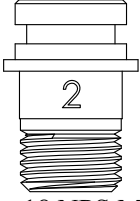
 Nickel Plated Part
 15/16-24 Female
 Fits Ballcock Shank
180360

Pull-Out Hose Adapters

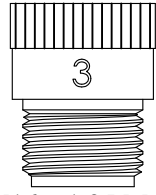
FOR KWC

 Nickel Plated
 1/4 - 18 NPS Male
LF182810

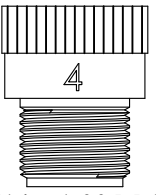
FOR GROHE

 Nickel Plated
 1/4 - 18 NPS Male
LF182880

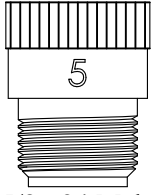
5/8 - 18 Female

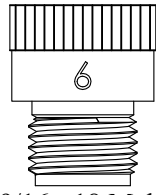
 Nickel Plated
 M16 x 1.25 Male
LF182950

5/8 - 18 Female

 Nickel Plated
 FOR GROHE
 M14 x 1.00 Male
LF183020

5/8 - 18 Female

 Nickel Plated
 FOR DELTA
 5/8 - 24 Male
LF186520

5/8 - 18 Female

 Nickel Plated
 FOR PRICE PFISTER
 9/16 - 18 Male
LF186590

ADAPTERS

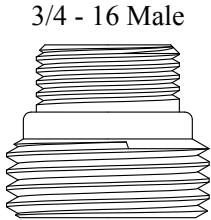
3/4" Hose Adapters

FOR CLAYTON MARK
YARD HYDRANT



3/4 - 16 Male

3/4 Hose Male

109500

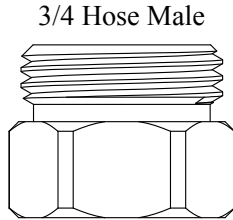

3/4 Hose Male

15-16 - 14 Female
Fits Ballcock Shank

115420

FOR NIBCO

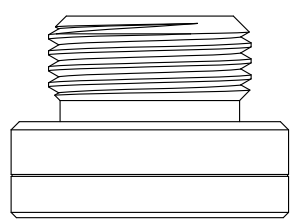

3/4" Hose Male

1-5/16 - 18 Female

134000

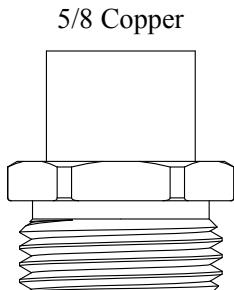

5/8 Copper

3/4 Hose Male

123940

FOR NIBCO

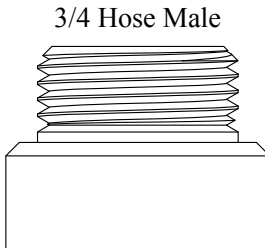

3/4 Hose Male

1-1/4 - 18 Female

133930

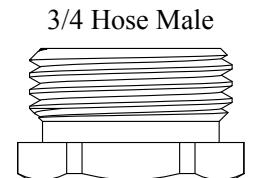

3/4 Hose Male

1/2 - 14 NPT Female

176640

FOR ARROWHEAD BRASS

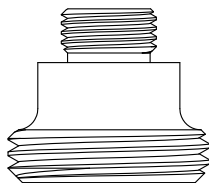

1/2 - 20 Male

3/4 Hose Male

189320

FOR U.S. BRASS

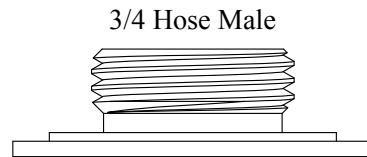

3/4 Hose Male

1-1/2 SLIP JOINT NUT

176010

ADAPTERS

Hose Adapters

FOR ALSON

3/8 - 18 NPS Male

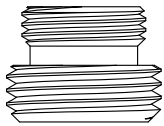

13/16 - 18 Male

131620

Chrome Plated

BEAUTY PARLOR
HOSE ADAPTER

1/4 - 18 NPT Female

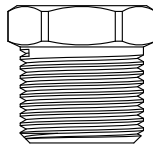

16MM X 1.25 Male

131830

PIPE ADAPTER

1 1/16 - 18 Female

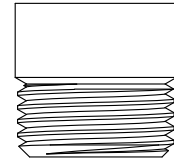

1/2 - 14 NPT Male

LF120180

1/4 - 18 NPT Male

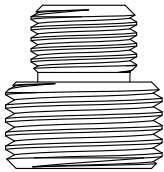

1/2 - 14 NPT Male

LF151090

9/16 - 18 Male

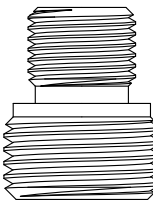

1/2 - 14 NPS Male

104340

Chrome Plated

FOR T & S BEDPAN HOSE

3/4 - 14 Male

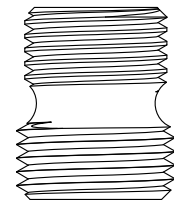

1/2 - 14 NPT Male

130030

Chrome Plated

1/2 - 14 NPT Male

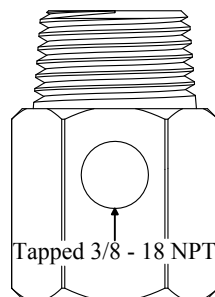

1/2 - 14 NPS Female

LF142490

Chrome Plated

ADAPTERS

Spout Adapters

FOR T & S SPOUT

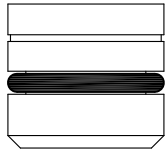

5/8 - 27 Female
LF113020

SPOUT ADAPTER FOR
UNIVERSAL RUNDLE

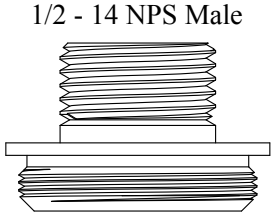

1/2 - 14 NPS Male
1 1/4 - 24 Male
131130

Chrome Plated

SPOUT ADAPTER
FOR PERLICK

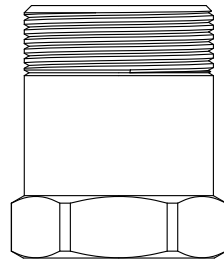

1" - 20 Male
13/16 - 18 Female
LF133950

Chrome Plated

FOR CRANE TUB SPOUT

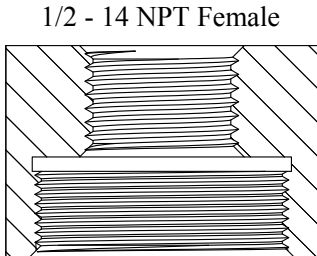

1/2 - 14 NPT Female
1 5/16 - 20 Female
102360

FOR CRANE TUB SPOUT

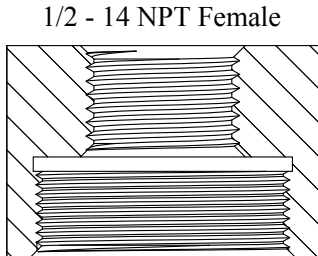

1/2 - 14 NPT Female
1 1/4 - 16 Female
116470

SPOUT ADAPTER FOR
UNIVERSAL RUNDLE

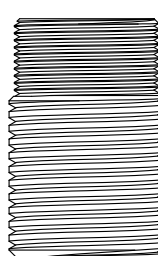

3/4 - 27 Male
1/2 - 14 NPS Male
LF106580

FOR CRANE SPOUT

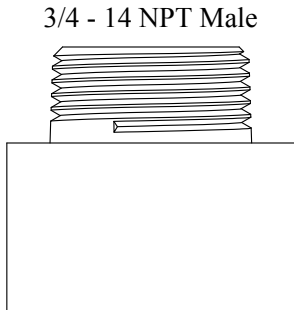

3/4 - 14 NPT Male
1 1/4 - 16 Female
124200

GOOSE NECK SPOUT ADAPTER

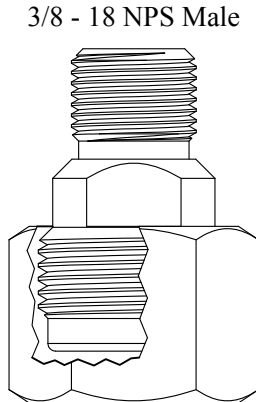

3/8 - 18 NPS Male
LF114650

Chrome Plated

ADAPTERS

Shower Head Adapters

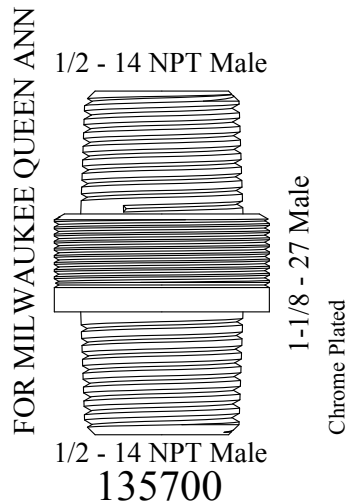
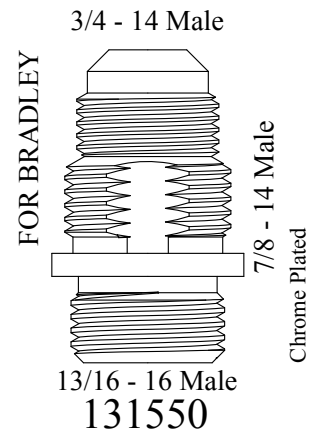
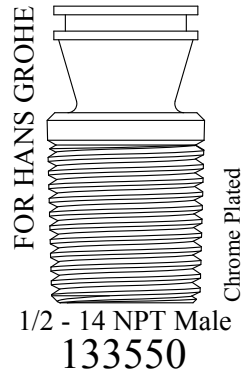
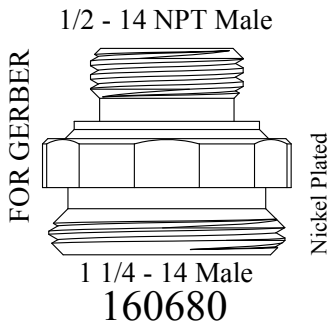
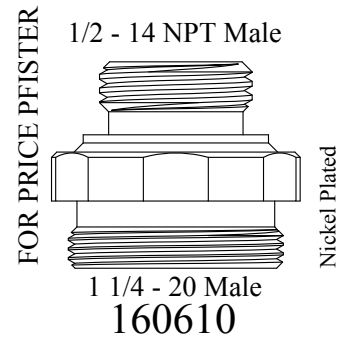
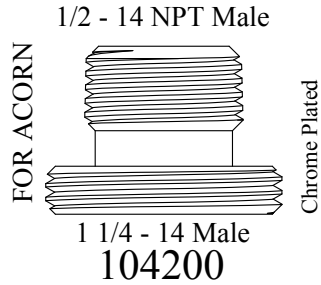
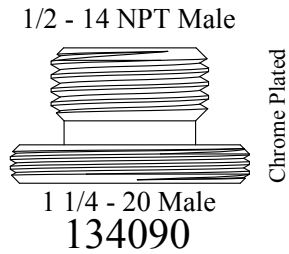

ADAPTERS

Pipe to Flare Adapters

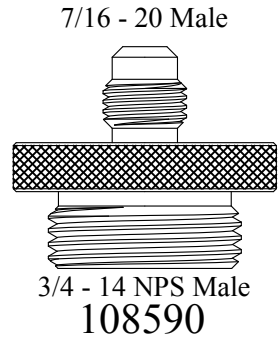
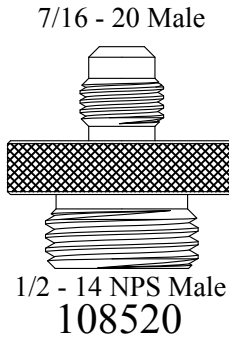
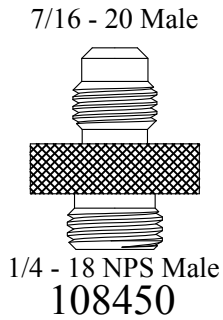

Pipe to Pipe Adapters

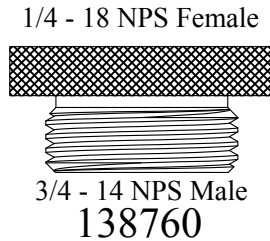
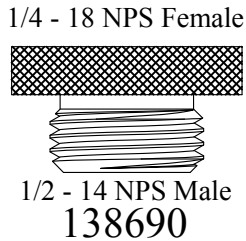

ADAPTERS

Miscellaneous Adapters

FACE BUSHING

Chrome Plated
3/8 - 18 NPS Female

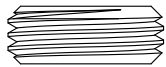

1/2 - 14 NPS Male
122560

FOR ELKAY
BUBBLER

1/2 - 20 Female

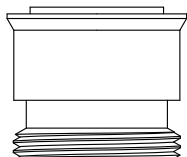

Chrome Plated

7/8 - 20 Male
LF107000

BRADLEY TO
ACORN ADAPTER

1 1/8 - 18 Male

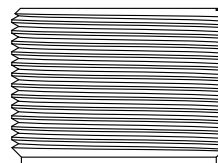

195730

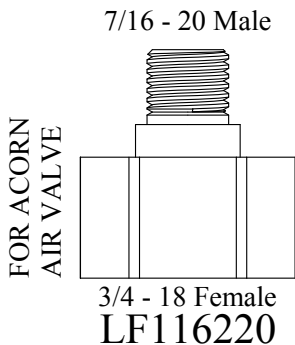

FOR ARROWHEAD
BRASS

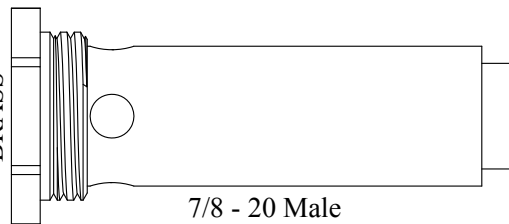

7/8 - 20 Male
11/16 - 20 Female
132670

Waste Shoe Bushings

1-5/8 - 16 Female

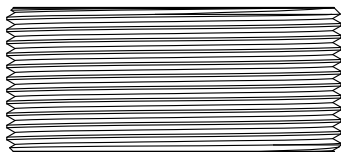

1-3/4 - 16 Male
182250

1-5/8 - 16 Female

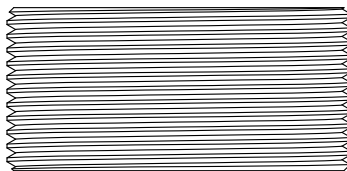

1-13/16 - 14 Male
120930

1-5/8 - 16 Female

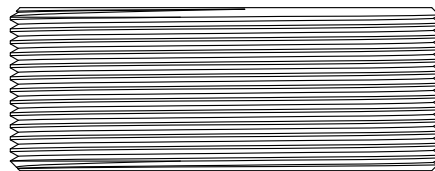

2-1/4 - 16 Male
106510

Miscellaneous Bushings

OVERFLOW BUSHING

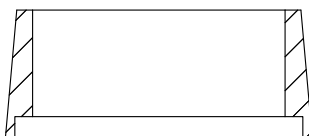

169710

ADAPTERS

Aerator Adapters

13/16 - 20 Male

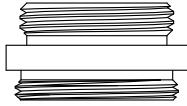

55/64 - 27 Male

LF105320

55/64 - 27 Male

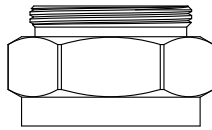

1/2 - 14 IPS Female

LF126320

15/16 - 27 Male

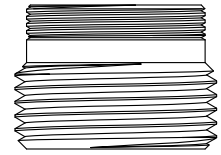

15/16 - 11.5 Male

Hose Thread

LF133460

13/16 - 27 Male

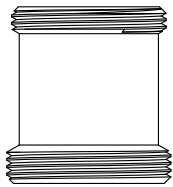

7/8 - 27 Male

LF116330

1/4 - 18 IPT Female

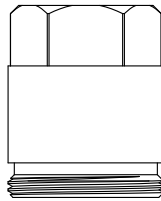

13/16 - 27 Male

LF110900

Snap Hose

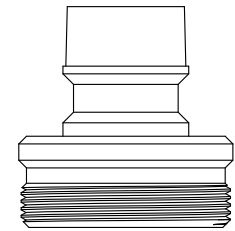

28mm X 1.00 Male

LF135980

Send Your Orders To:

BARRY E.  WALTER SR. CO.

E-mail: orderdesk@barrywalter.com

Fax: 1.800.886.9831

Phone: 1.800.767.5552

Send Your Orders To:

BARRY E.  SR. CO.

E-mail: orderdesk@barrywalter.com

Fax: 1.800.886.9831

Phone: 1.800.767.5552



BRASS
AMERICA
Quality Replacement Parts

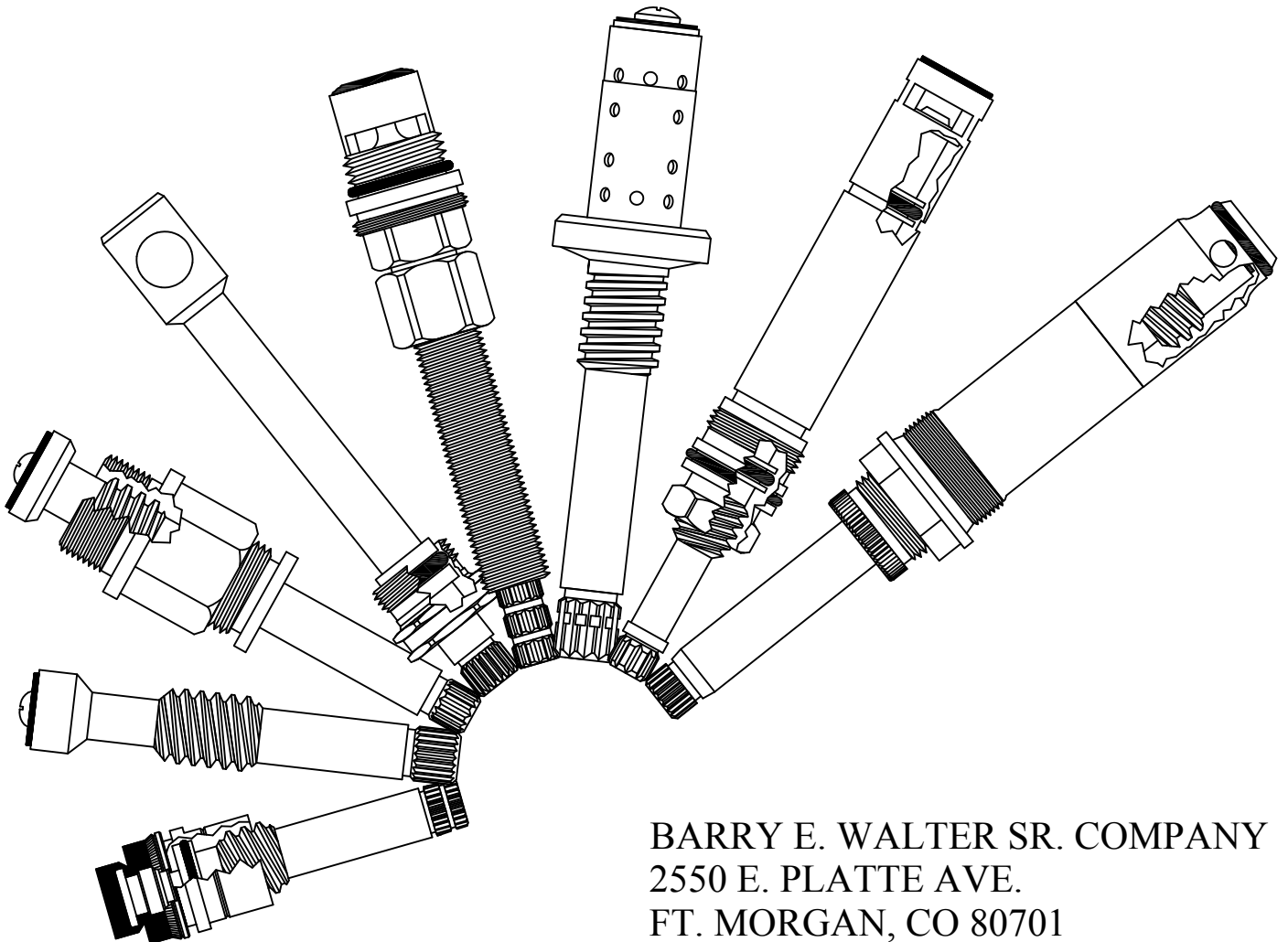

BARRY E. WALTER SR. COMPANY
2550 E. PLATTE AVE.
FT. MORGAN, CO 80701

BARRY E.  ALTER SR. CO.

BALLCOCK PLUNGERS & COMPONENTS

BALLCOCK PLUNGERS

REPLACEMENT FOR
AMERICAN STANDARD

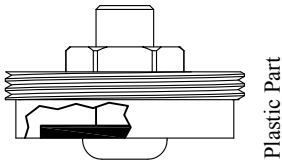

70422-07

REPLACEMENT FOR
AMERICAN STANDARD

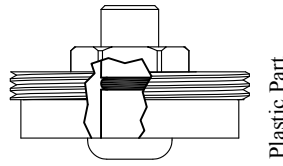

73071-07

REPLACEMENT FOR
AMERICAN STANDARD

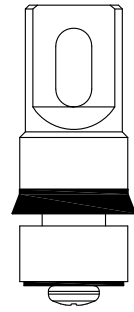

640010
OEM# 8339-07
SEAT: 649370

REPLACEMENT FOR CASE

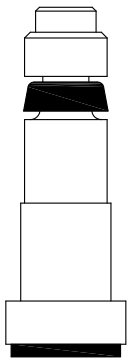

640050
OEM# 5025
SEAT: 647240

REPLACEMENT FOR CASE

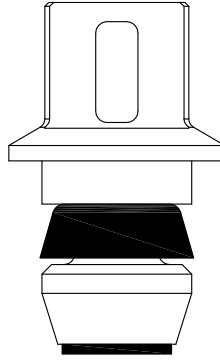

640320
OEM# 50
SEAT: 647980

REPLACEMENT FOR CASE

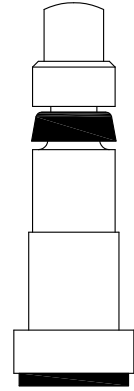

640250
OEM# 5034
SEAT: 647240

REPLACEMENT FOR CASE

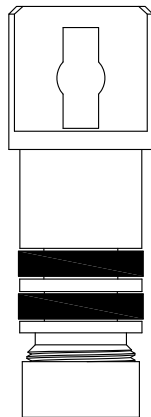

640300
OEM# 41 5/8"

REPLACEMENT FOR CASE

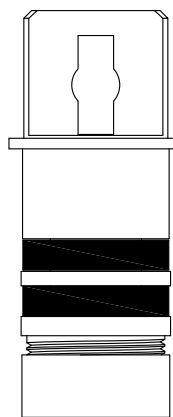

640310
OEM# 41 3/4"
SEAT: 647240

BALLCOCK PLUNGERS

REPLACEMENT FOR
BRIGGS & INDIANA

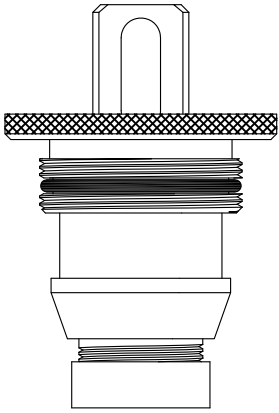

640020

Briggs OEM# SA76-E4A
Indiana OEM# 4197
SEAT: 647860

REPLACEMENT FOR ELJER

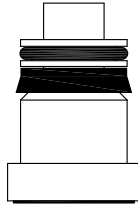

640420

OEM# 480-0604-00
SEAT: 647860

REPLACEMENT FOR KOHLER

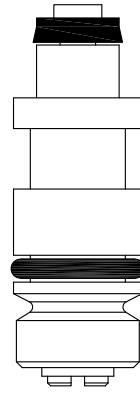

640220

OEM# 51226
SEAT: 647160

REPLACEMENT FOR MANSFIELD

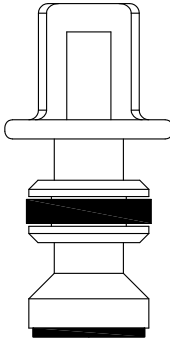

640240
OEM# 333

REPLACEMENT FOR SCOVILL

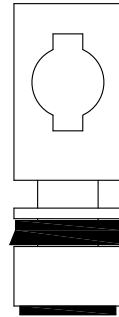

640350

OEM# 8729
SEAT: 649970

REPLACEMENT FOR UNIVERSAL RUNDLE

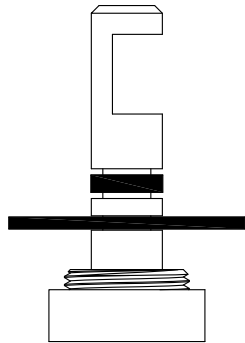

640400

OEM# A369
SEAT: 647830

REPLACEMENT FOR UNIVERSAL RUNDLE

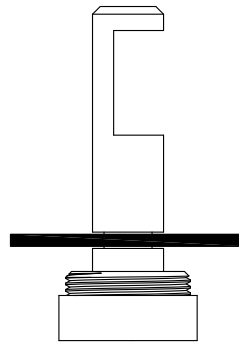

640410

OEM# A317
SEAT: 647830

BALLCOCK COMPONENTS



CUP FOR CASE 62-12A
BALLCOCK

141770



CUP FOR CASE 50
BALLCOCK

840320-2



5/8" BALLCOCK
SEAT WASHER
FOR CASE

840300

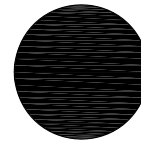

BALLCOCK
SEAT WASHER
FOR CASE

840310

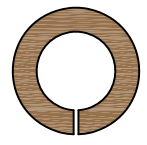

5/8" BALLCOCK
LEATHER PACKING
FOR CASE

840300-2



3/4" BALLCOCK
LEATHER PACKING
FOR CASE

840310-2

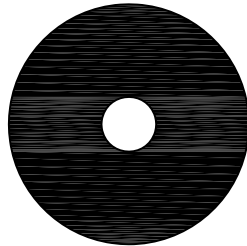

DIAPHRAGM WASHER
FOR SEAR-U/R

840400-1



BALLCOCK
LEATHER PACKING
FOR SEARS-U/R

840400-2



BIBB WASHER
FOR SEARS-U/R

840220



TANK LEVER
NUT

160410

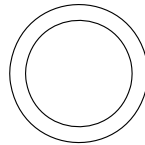

BALLCOCK CAP
FOR BRIGGS

940020

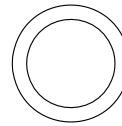

5/8" BALLCOCK CAP
FOR CASE

940300

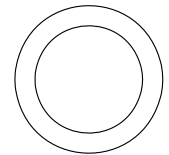

BALLCOCK
RETAINER CUP

940310

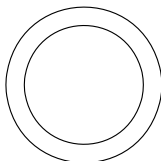

BALLCOCK CAP
FOR SEARS-U/R

940400

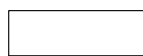
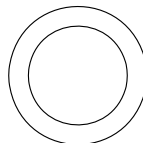

BALLCOCK CAP
FOR SEARS-U/R

940410

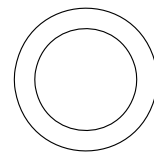

BALLCOCK CAP
FOR SCOVILL

012-8227

BARRY E.  WALTER SR. CO.

INSTITUTIONAL & SECURITY REPAIR PARTS

INSTITUTIONAL & SECURITY REPAIR PARTS

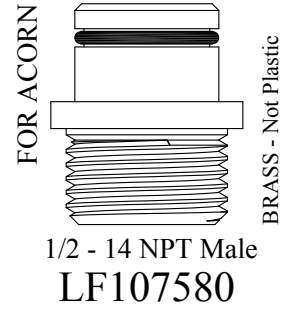
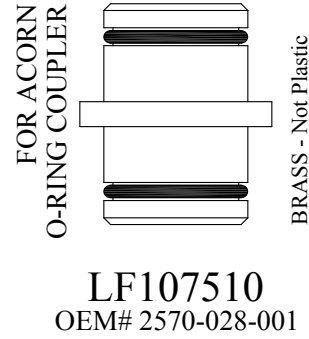
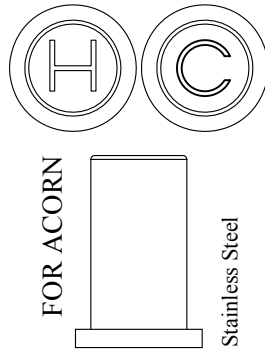
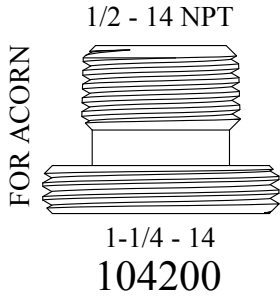

127530 Hot
OEM# 4010-001-199
127600 Cold
OEM# 4010-002-199

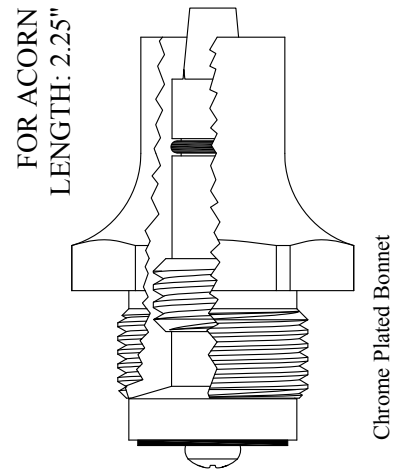
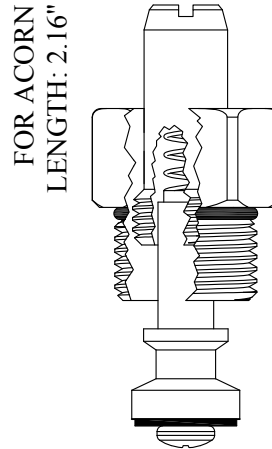
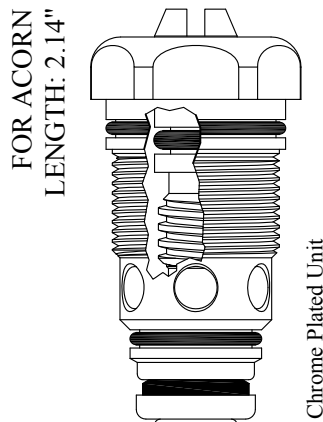
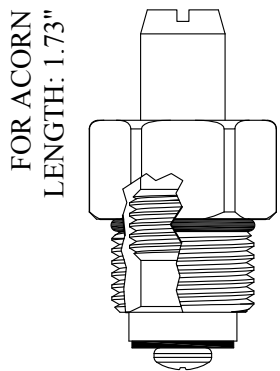
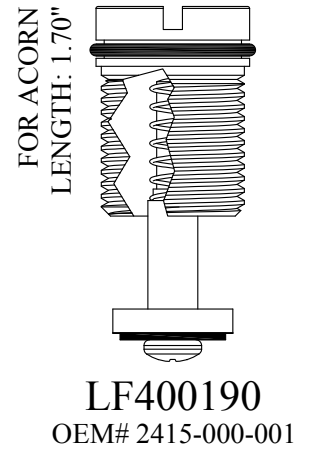
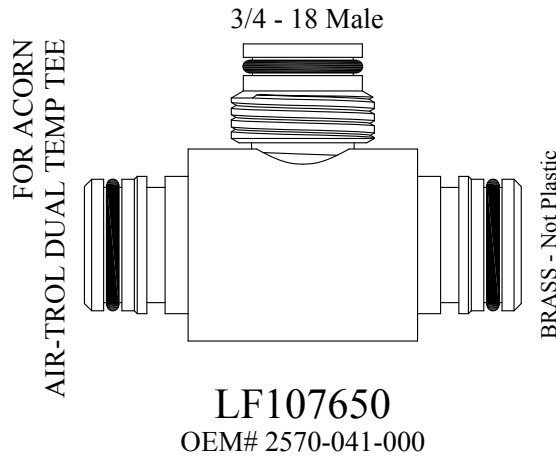
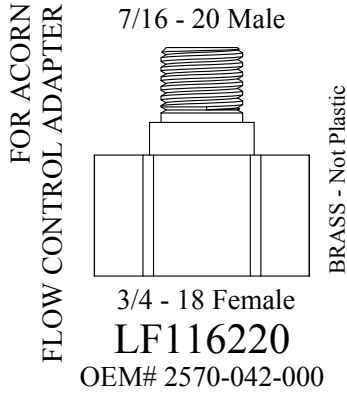

GASKET: 890160 O-RING INCLUDED

LF454071
OEM# 2755-000-002
LF254071 Stem Only

461922
OEM# 0528-000-002

GASKET: 890160 O-RING INCLUDED

LF400571
OEM# 2755-005-002
LF200571 Stem Only

GASKET: 895570

483121
OEM# 0485-000-002

INSTITUTIONAL & SECURITY REPAIR PARTS

Also available less bonnet
LF463260
 OEM# 2304-001-001

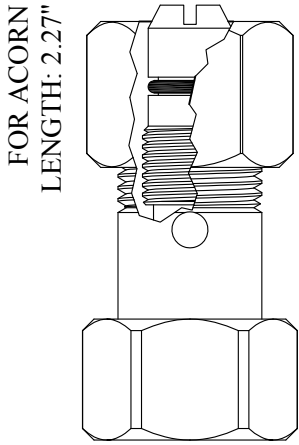

LF138921
 OEM# 2366-031-001
LF136401 Stem Only

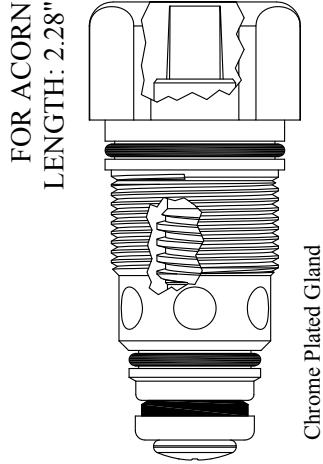

462702
 OEM# 0525-000-002

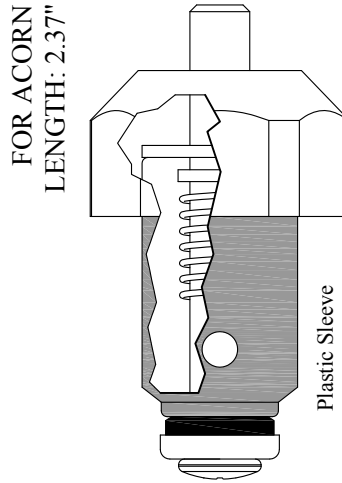

LF463270
 OEM# 2304-000-001

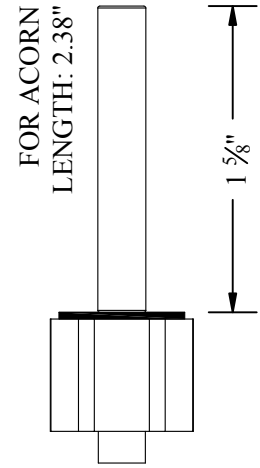

LF158310
 OEM# 2358-003-001

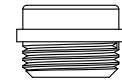

SEAT USED: LF647560

Also available less bonnet
464542
 OEM# 2260-001-002

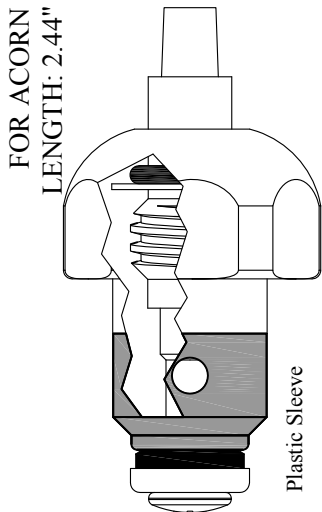

464552
 OEM# 2366-031-001

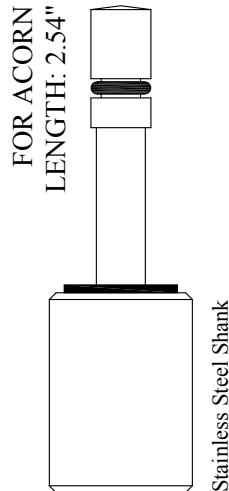

LF138990
 OEM# 2366-011-002

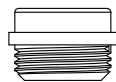

SEAT USED: LF647560

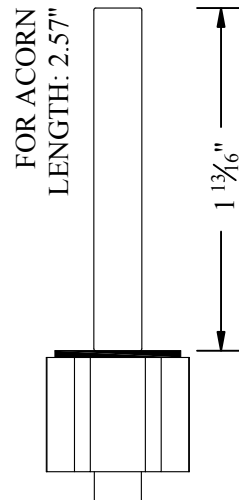

LF130680

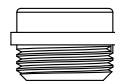

SEAT USED: LF647560

Also available less bonnet
LF117621

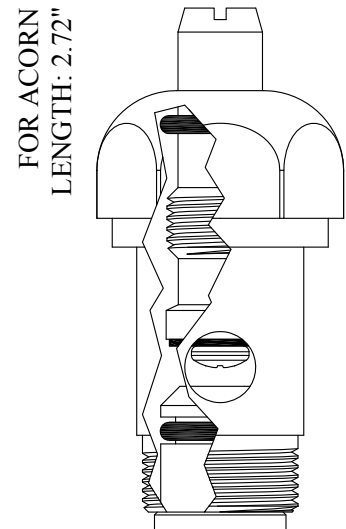

GASKET: 895400
 SEAT INCLUDED: LF601780

LF401781
 OEM# 2767-010-002
LF254071 Stem Only

INSTITUTIONAL & SECURITY REPAIR PARTS

Also available less bonnet
LF466490

FOR ACORN
 LENGTH: 3.13"

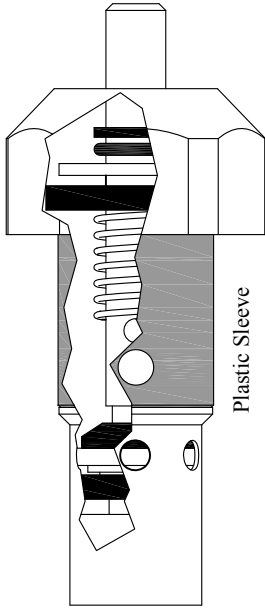

Plastic Sleeve

LF466500
 OEM# 2305-050-003

FOR ACORN
 LENGTH: 3.24"

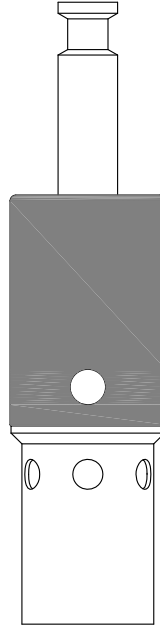

Plastic Sleeve

468490
 OEM# 2305-001-001

FOR ACORN
 LENGTH: 3.50"

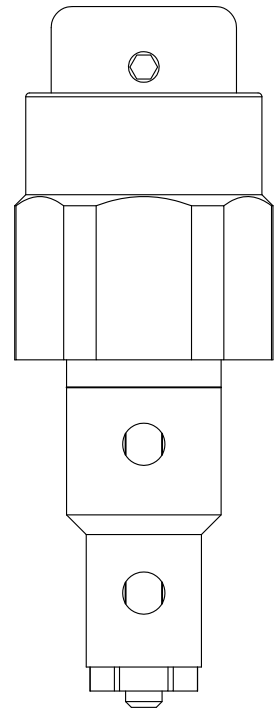

LF402880

FOR ACORN
 LENGTH: 4.00"

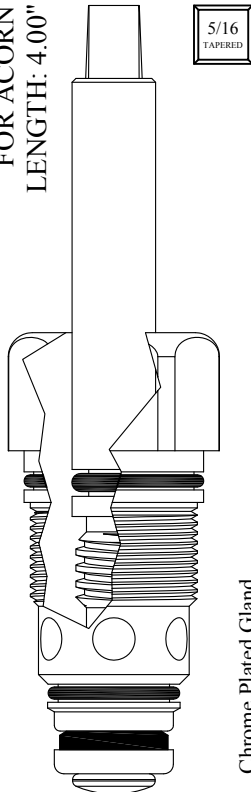

Chrome Plated Gland

469702
 OEM# 0526-000-001

5/16
 TAPERED

FOR ACORN
 LENGTH: 4.00"

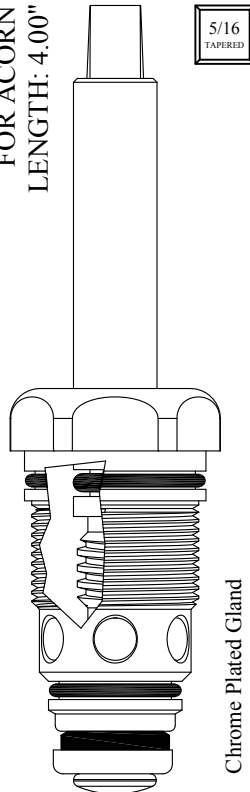

Chrome Plated Gland

469712

5/16
 TAPERED

FOR ACORN
 LENGTH: 4.49"

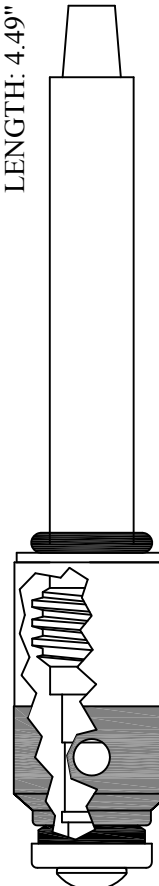

Plastic Sleeve

470052
270052 Stem Only

5/16
 TAPERED

FOR ACORN

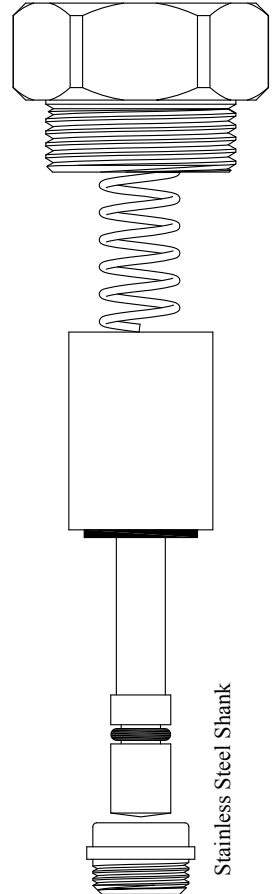

Stainless Steel Shank

GASKET INCLUDED: 895550
 SEAT INCLUDED: LF647560
LF138220
 OEM# 2366-021-001

INSTITUTIONAL & SECURITY REPAIR PARTS

FOR ACORN
Male

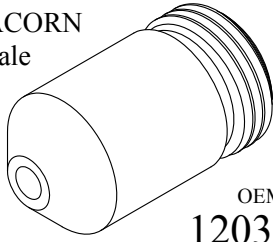

OEM# 1241-001-001
120320: 1.5 GPM
120390: 2.5 GPM

FOR ACORN
Male

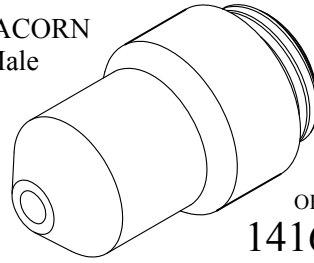

OEM# 1187-000-001
141670: 1.5 GPM
103220: 2.5 GPM

FOR ACORN
Female

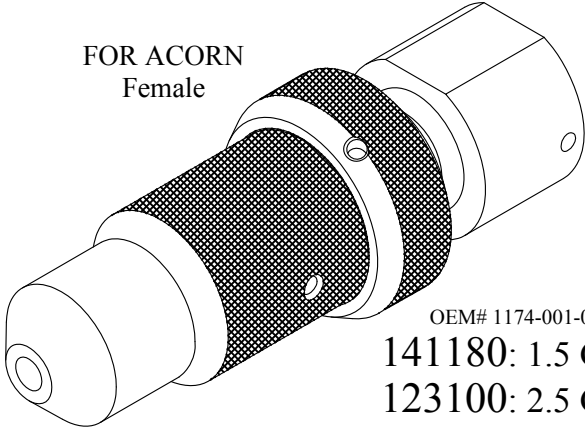

OEM# 1174-001-001
141180: 1.5 GPM
123100: 2.5 GPM

FOR ACORN
Female Rigid

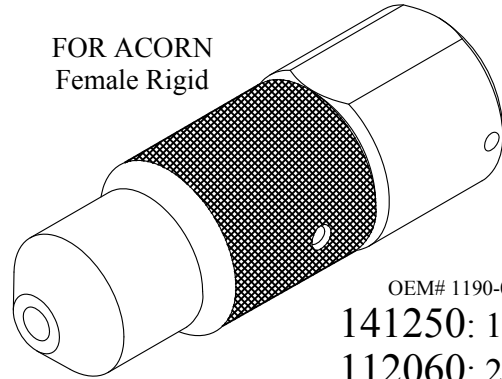

OEM# 1190-010-001
141250: 1.5 GPM
112060: 2.5 GPM

FOR ACORN
Male

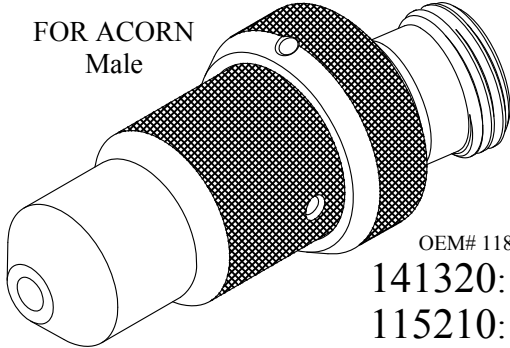

OEM# 1180-001-001
141320: 1.5 GPM
115210: 2.5 GPM

FOR ACORN
Male Rigid

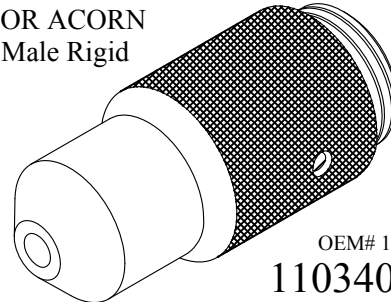

OEM# 1192-010-001
110340: 1.5 GPM
115350: 2.5 GPM

FOR ACORN
Female

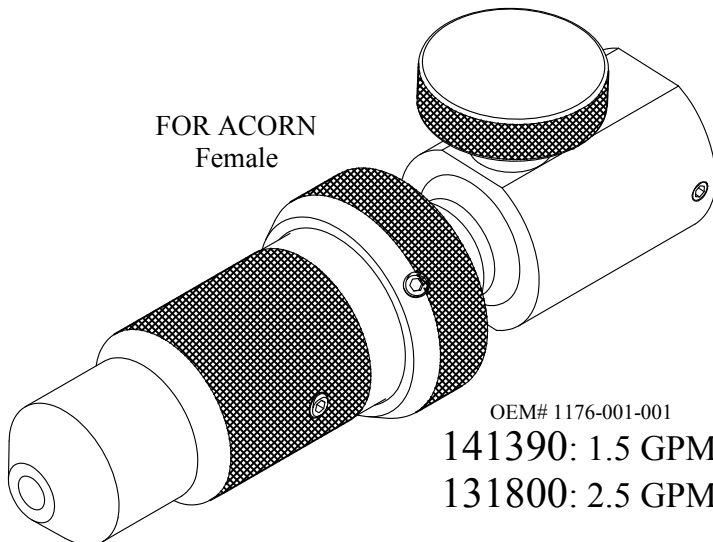

OEM# 1176-001-001
141390: 1.5 GPM
131800: 2.5 GPM

FOR ACORN
Male Rigid

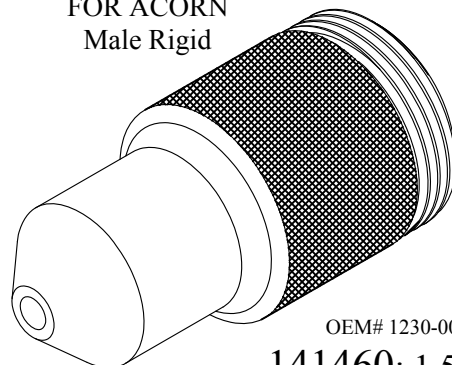

OEM# 1230-000-001
141460: 1.5 GPM
123750: 2.5 GPM

INSTITUTIONAL & SECURITY REPAIR PARTS

FOR ACORN B5

LF103870

158100

PACKING NUT

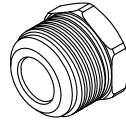

SPRING

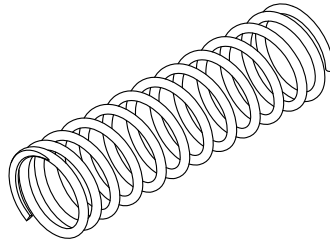

.437 x .250 x .094
O-RING



.437 x .250
BACK-UP RING



1.030 x .875 x .062
GASKET

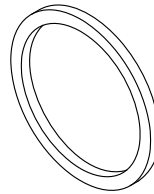

LF158240

CAP NUT

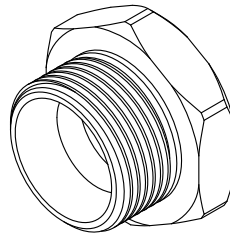

LF158310

STEM ASSEMBLY

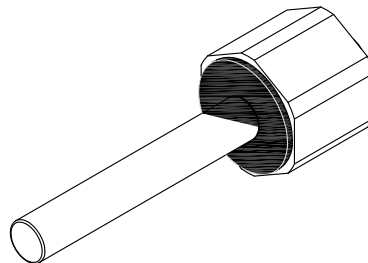

LF647560

1/2-27 SEAT

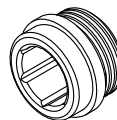

INSTITUTIONAL & SECURITY REPAIR PARTS

SUPPLY TUBE FOR AMERICAN STANDARD PRISON

STEM ASSEMBLY FOR AMERICAN STANDARD PRISON

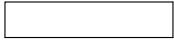

COLLAR
39628



BUSHING
139780

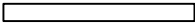

WASHER
140270



NUT
129520

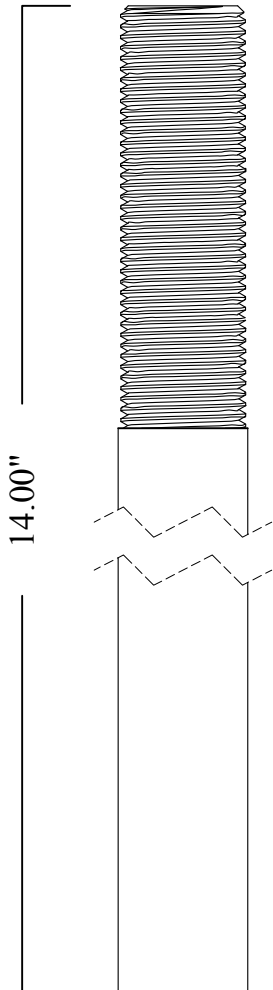

TUBE
140830

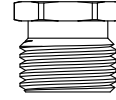

PACKING NUT
25009-07



PACKING
124590

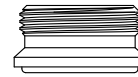

SEAT
LF649870

STEM LENGTH: 2.36"

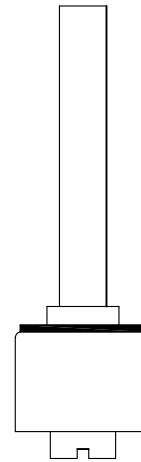

STEM
LF152150



SPRING
124520

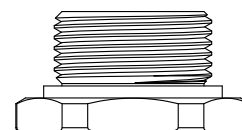

CAP
LF60053-07
895150 Gasket Included

LF124660 Repair Kit

INSTITUTIONAL & SECURITY REPAIR PARTS

FOR AMERICAN STANDARD PRISON

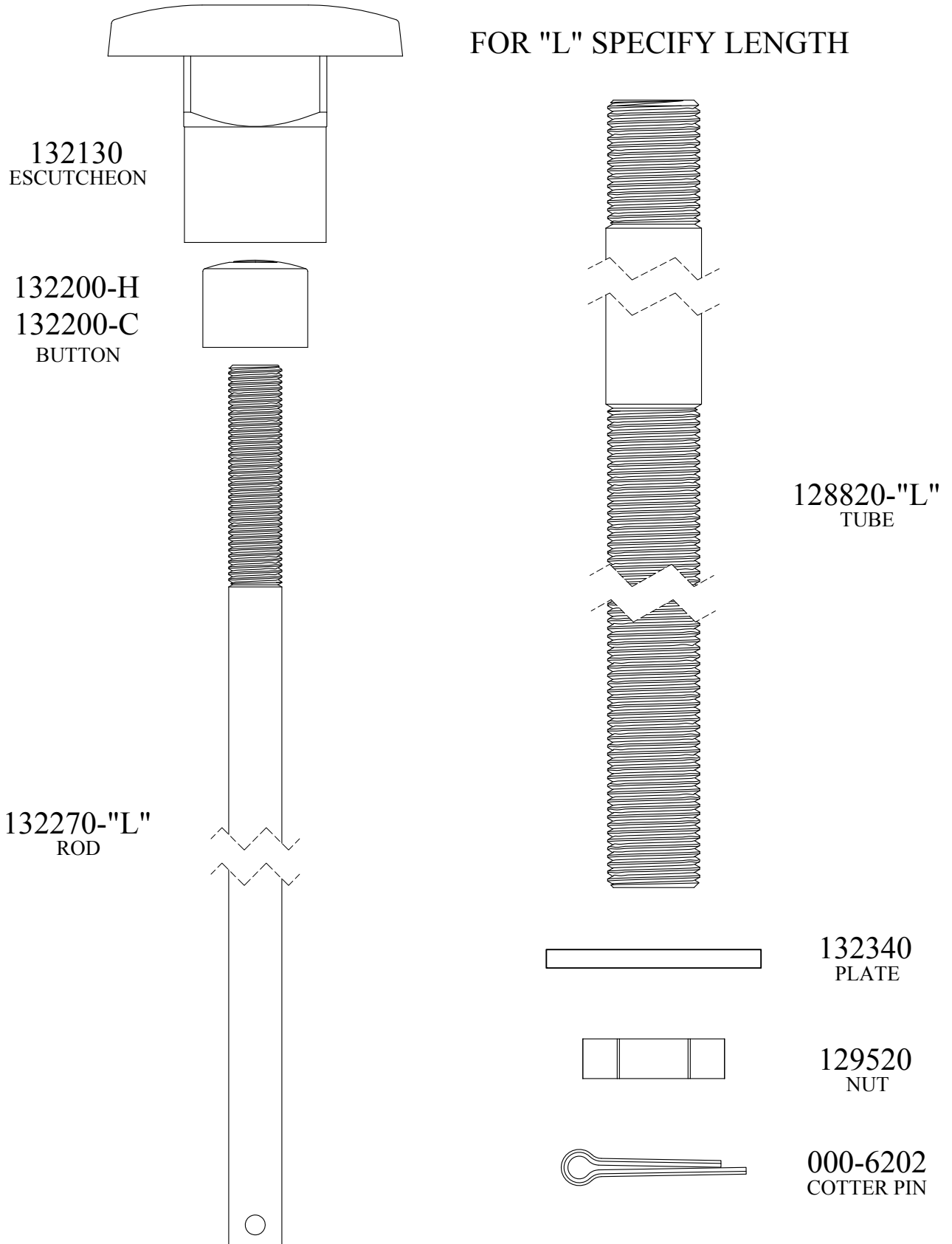

INSTITUTIONAL & SECURITY REPAIR PARTS

FOR BRADLEY
Male

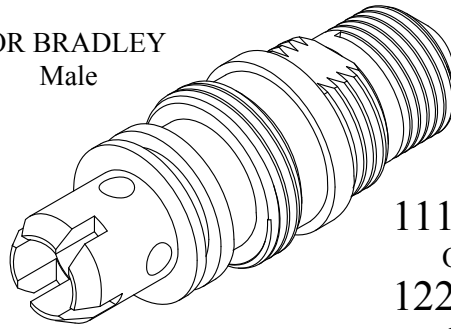

CHROME PLATED SOLID
BRASS (NOT PLASTIC)

111810: 1.5 GPM
OEM# S88-067
122310: 2.5 GPM
OEM# S88-001
122520: 3.0 GPM
OEM# S88-003

FOR BRADLEY
Male

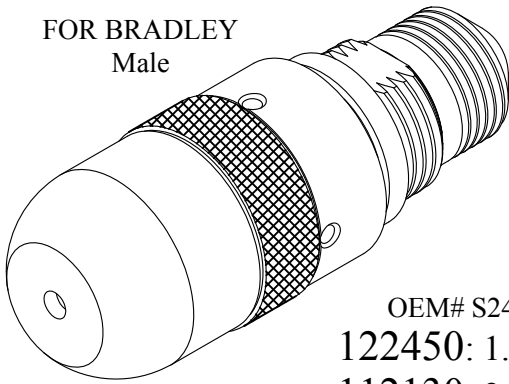

OEM# S24-072
122450: 1.5 GPM
112130: 2.5 GPM
122380: 3.0 GPM

FOR BRADLEY
3/8 - 18 NPT Female

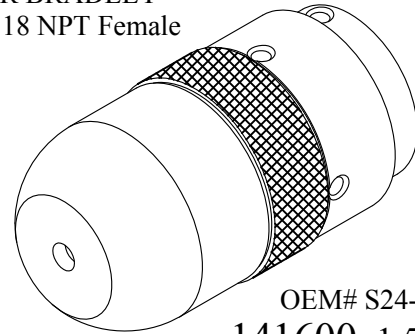

OEM# S24-008
141600: 1.5 GPM
130870: 2.5 GPM

FOR BRADLEY
LENGTH: 1.50"

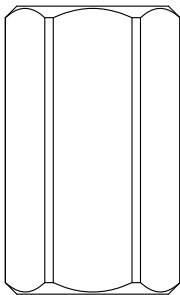

CONNECTION BODY WITH
FLOW CONTROL (0.5 GPM)

126580
OEM# S88-028

FOR BRADLEY
LENGTH: 2.44"

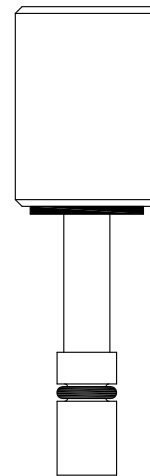

LF173770
OEM# S21-046

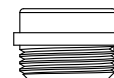

SEAT USED: LF647560

INSTITUTIONAL & SECURITY REPAIR PARTS

FOR BRADLEY
LENGTH: 2.19"

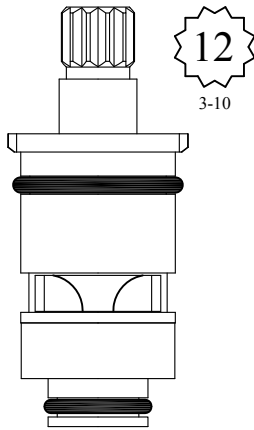

DISC SET: 151380-PKG

LF461071
LF461072

FOR BRADLEY
LENGTH: 2.46"
STEM LENGTH: 1.22"

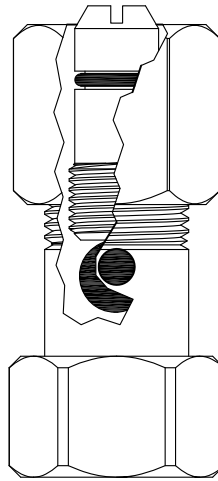

GASKET: 895100 INCLUDED

LF126480
LF126551 Stem Only
OEM# S21-047

FOR BRADLEY
LENGTH: 2.98"

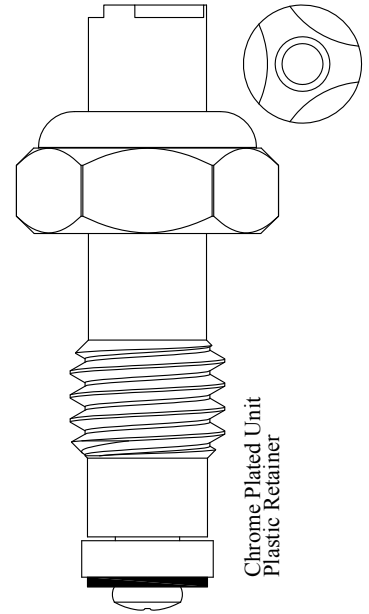

Chrome Plated Unit
Plastic Retainer

401731
201731 Stem Only
OEM# S21-020

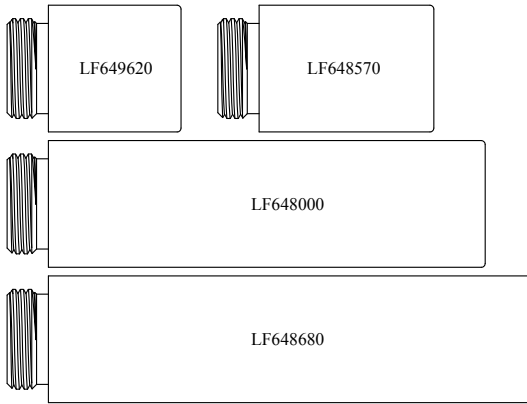

SEATS USED: LF648000, LF648570, LF648680 & LF649620

LOCKNUT
F10583

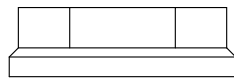

FOR CRANE
PRISON VALVE
LENGTH: 1.81"
STEM LENGTH: 1.00"

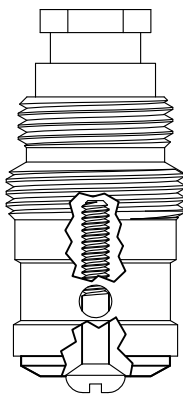

GASKET: 895250

LF458700
OEM# 355174
LF258700 Stem Only

Shorter version stem available

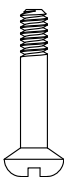

LF103990
STEM LENGTH: 0.87"

FOR CRANE
VALVE BODY

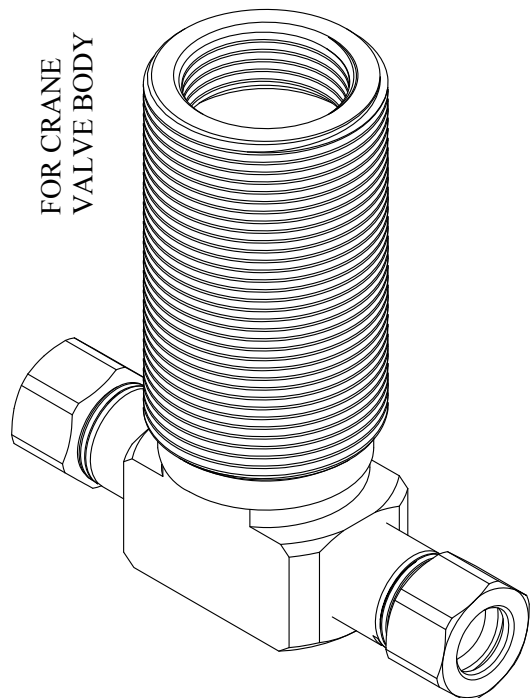

LF142650

INSTITUTIONAL & SECURITY REPAIR PARTS FOR CRANE PRISON

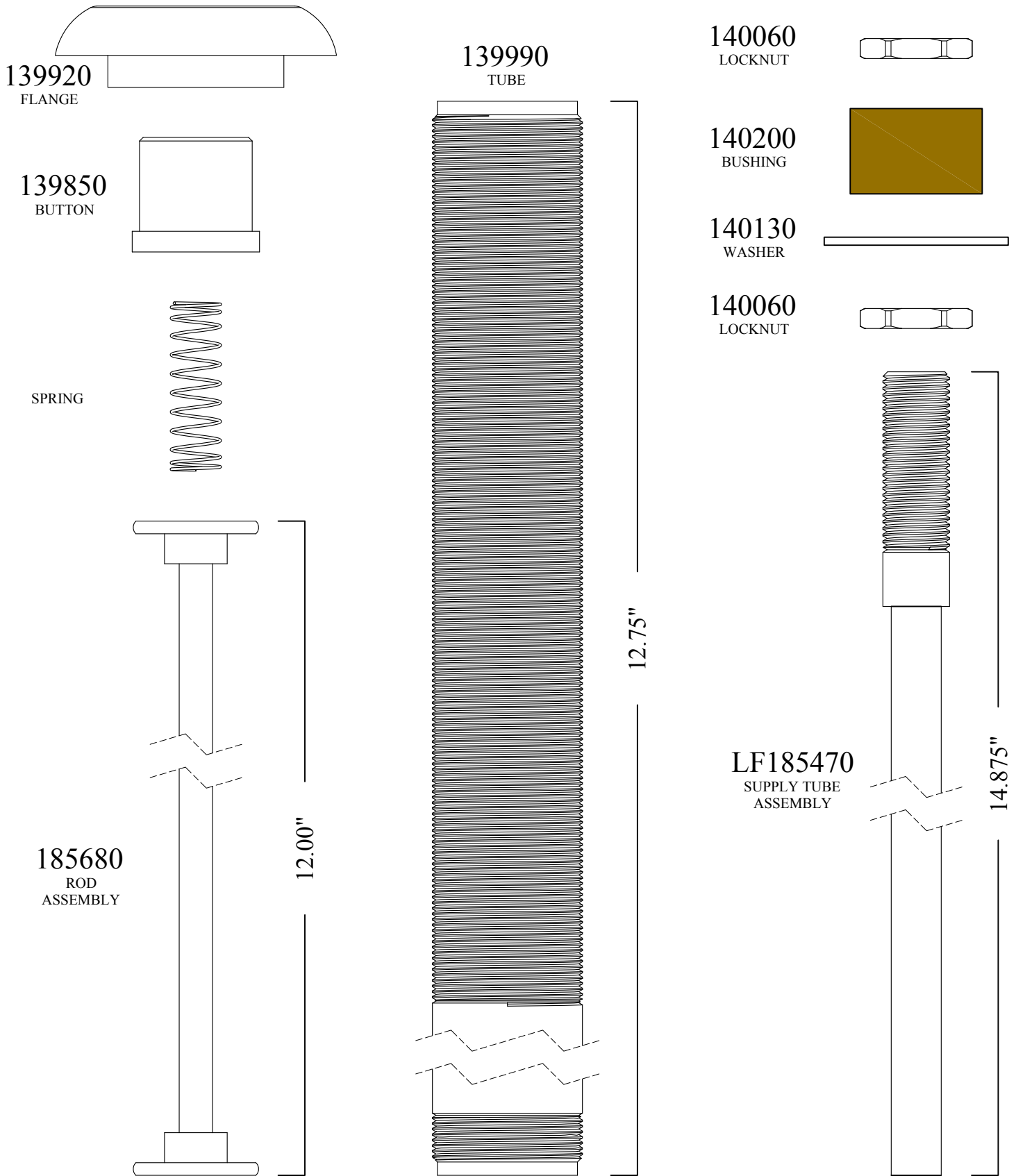

INSTITUTIONAL & SECURITY REPAIR PARTS FOR ELJER PRISON VALVE

REPAIR KIT
LF132080

SECURITY
SEAT WASHER



SPRING

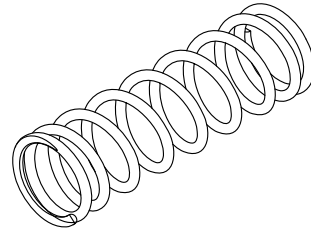

SECURITY
COLLAR



GASKET

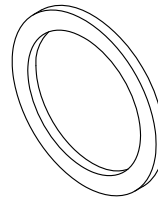

SECURITY
COLLAR

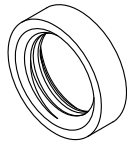

PACKING

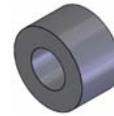

PACKING NUT

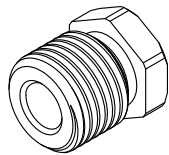

RUBBER GASKET

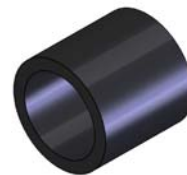

CAP

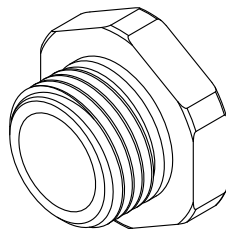

GASKET



VALVE HEAD

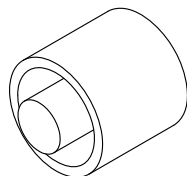

VALVE STEM

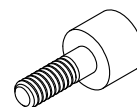

INSTITUTIONAL & SECURITY REPAIR PARTS

FOR KOHLER PRISON

129310
ESCUTCHEON

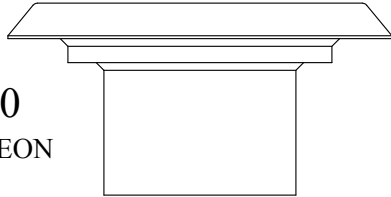

131710-H
131710-C
BUTTON

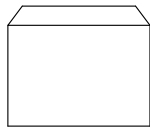

132060
3 1/2" LONG

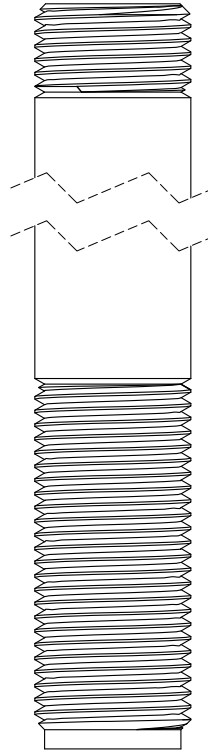

139500
8 1/2" LONG
TUBE

131780 - 4 1/2" LONG
131850 - 9 1/2" LONG
ROD

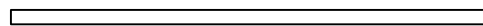
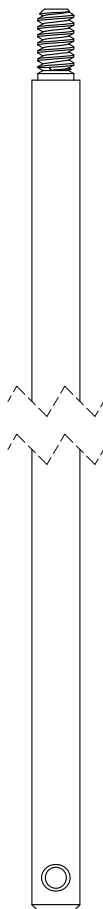

131900
WASHER



131920
NUT

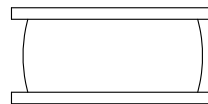

131990
COLLAR



000-6202
COTTER PIN

INSTITUTIONAL & SECURITY REPAIR PARTS

SUPPLY TUBE FOR KOHLER PRISON

FOR KOHLER PRISON VALVE REPAIR KIT

LF115100

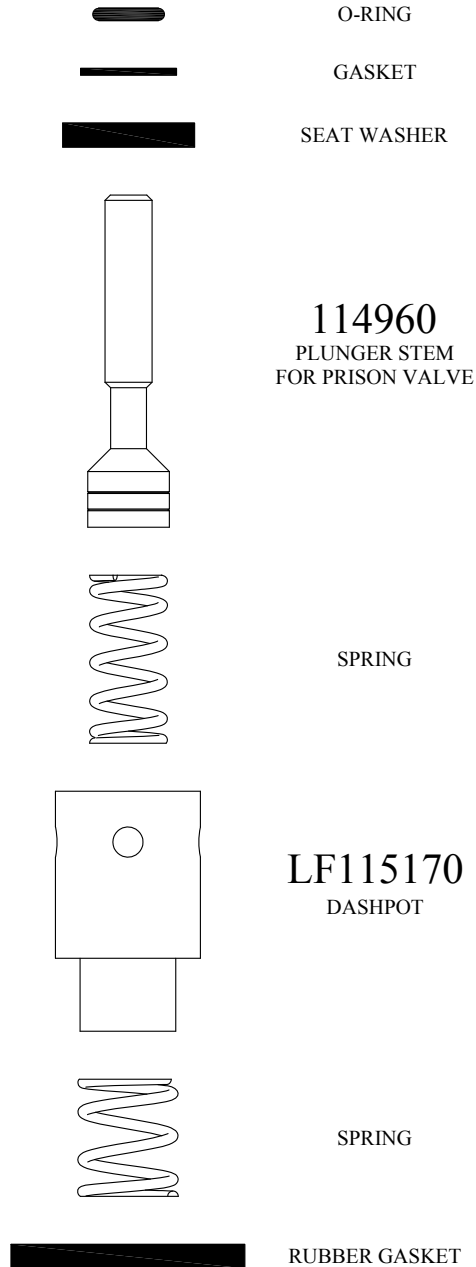
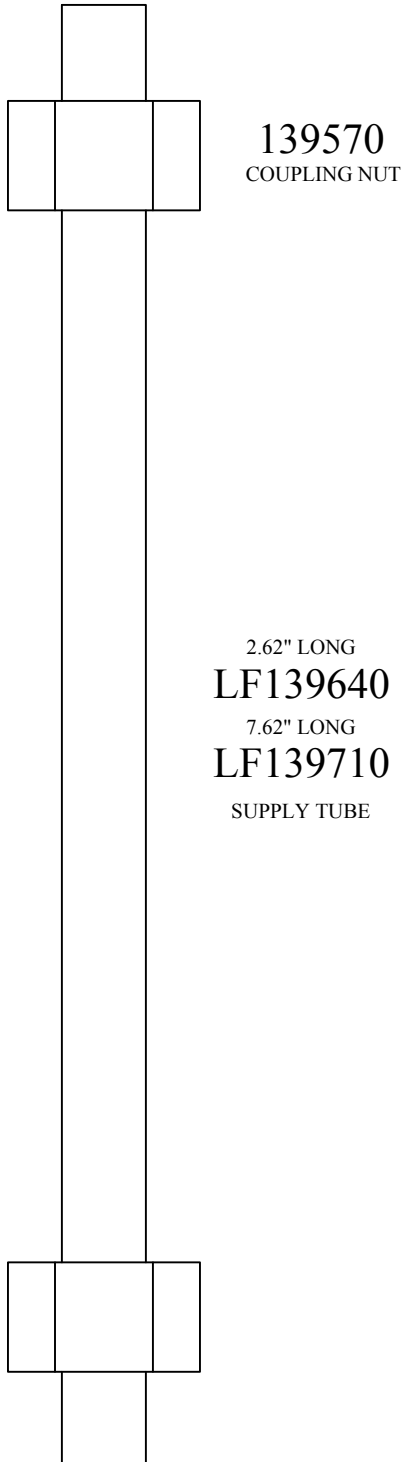

REPAIR KIT #134180 ALSO AVAILABLE
LESS LEAD FREE DASHPOT

INSTITUTIONAL & SECURITY REPAIR PARTS

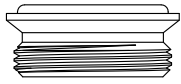

SEAT FOR LEONARD
53/64 - 24 X 3/8" HIGH

647840

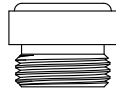

SEAT FOR LEONARD
1/2 - 27 X 7/16" HIGH

LF648860

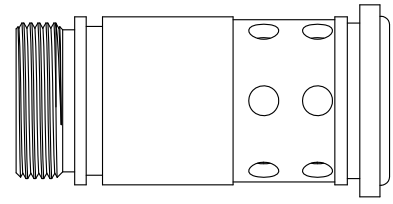

STAINLESS STEEL
SEAT FOR LEONARD

646860

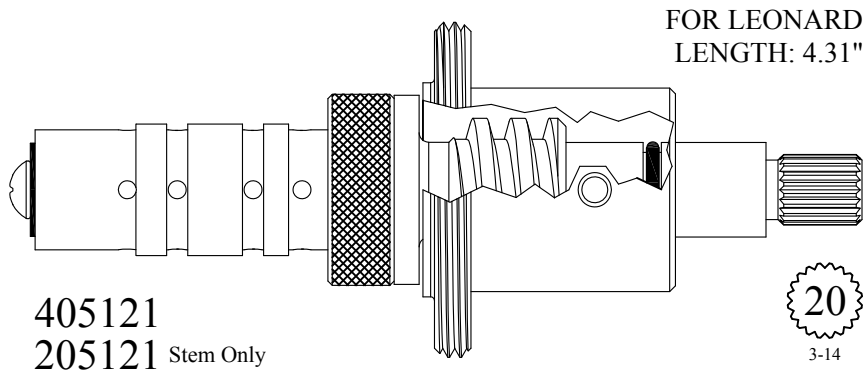

405121

205121 Stem Only

20
3-14

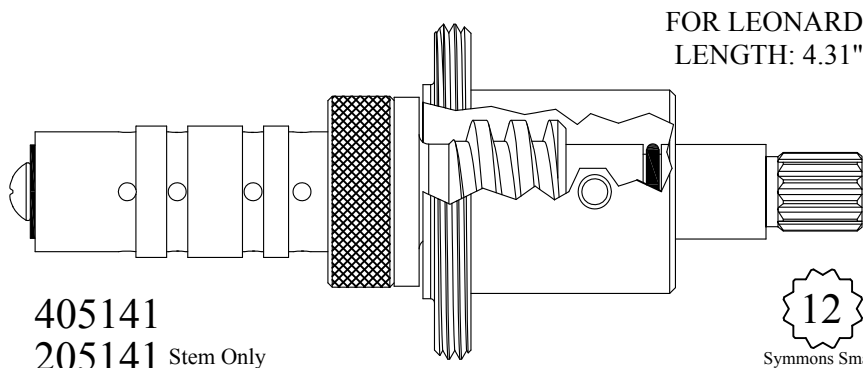

405141

205141 Stem Only

12
Symmons Small

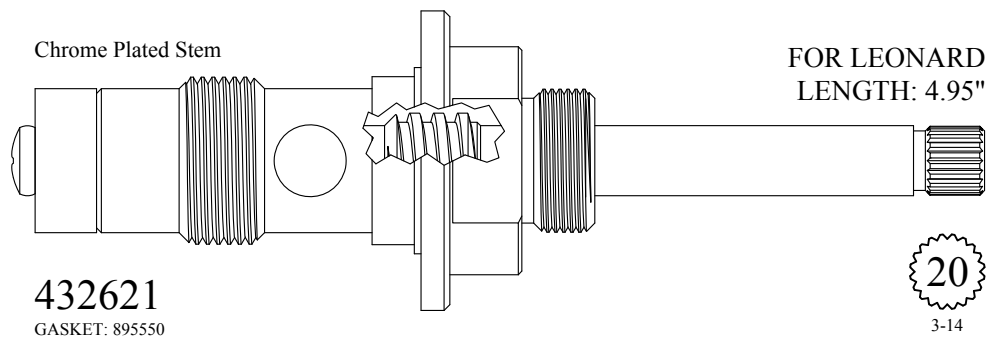

432621

GASKET: 895550

20
3-14

INSTITUTIONAL & SECURITY REPAIR PARTS

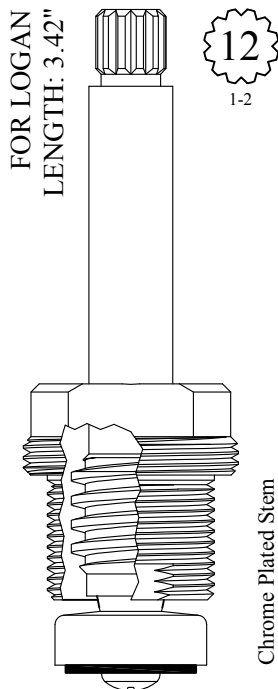

GASKET: 895400

402811
202811 Stem Only

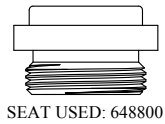

SEAT USED: 648800

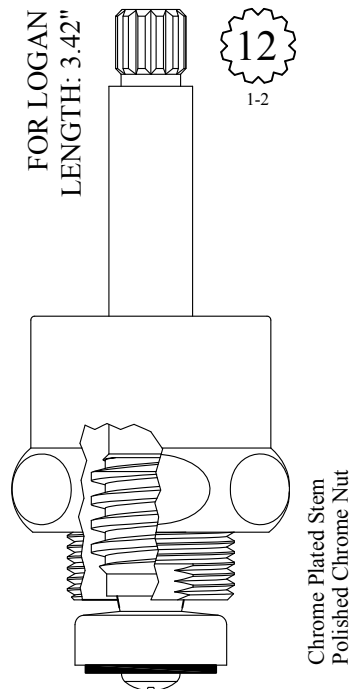

GASKET: 895400 INCLUDED

402811-N
202811 Stem Only



SEAT USED: 648800

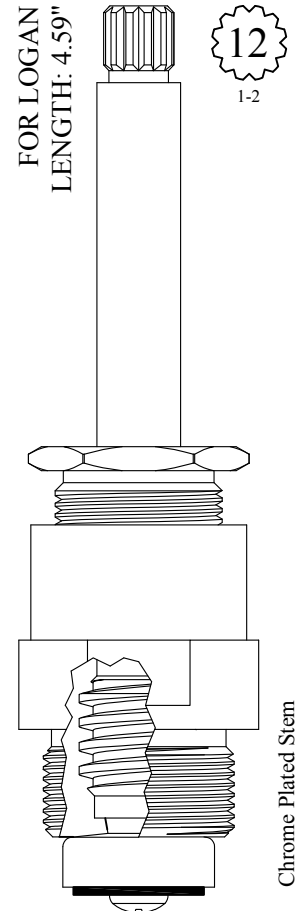

GASKET: 895430

410011
210011 Stem Only

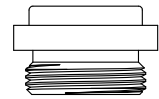

SEAT USED: 648800

INSTITUTIONAL & SECURITY REPAIR PARTS

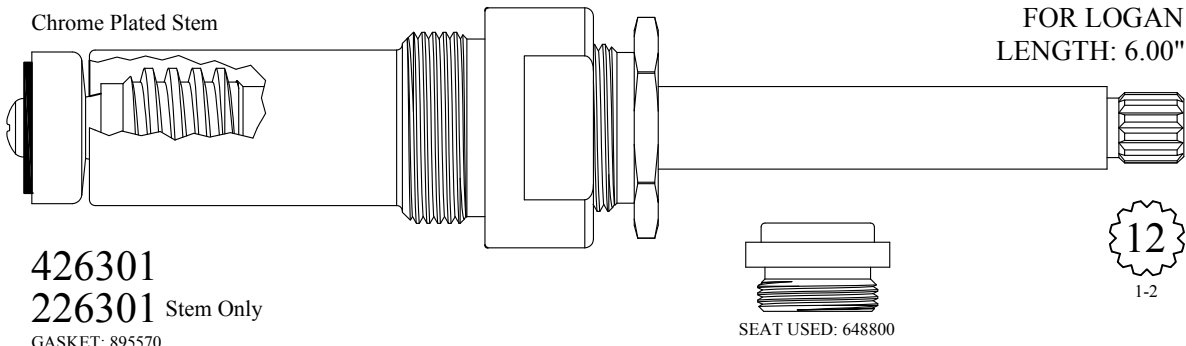

426301
226301 Stem Only
GASKET: 895570

Also available in the following lengths:

THESE STEMS ARE ALL CHROME PLATED

UNIT	STEM ONLY	LENGTH
427201	227201	6.50"
427501	227501	7.00"
428301	228301	8.00"
428401	228401	9.50"
429301	229301	12.00"
429501	229501	14.00"
429601	229601	16.00"
429701	229701	18.00"

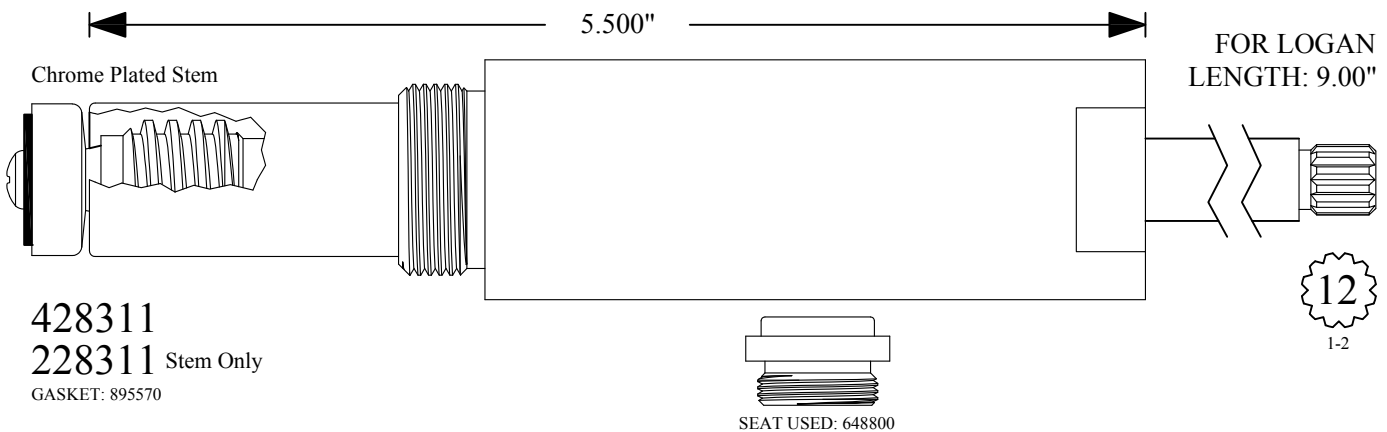

428311
228311 Stem Only
GASKET: 895570

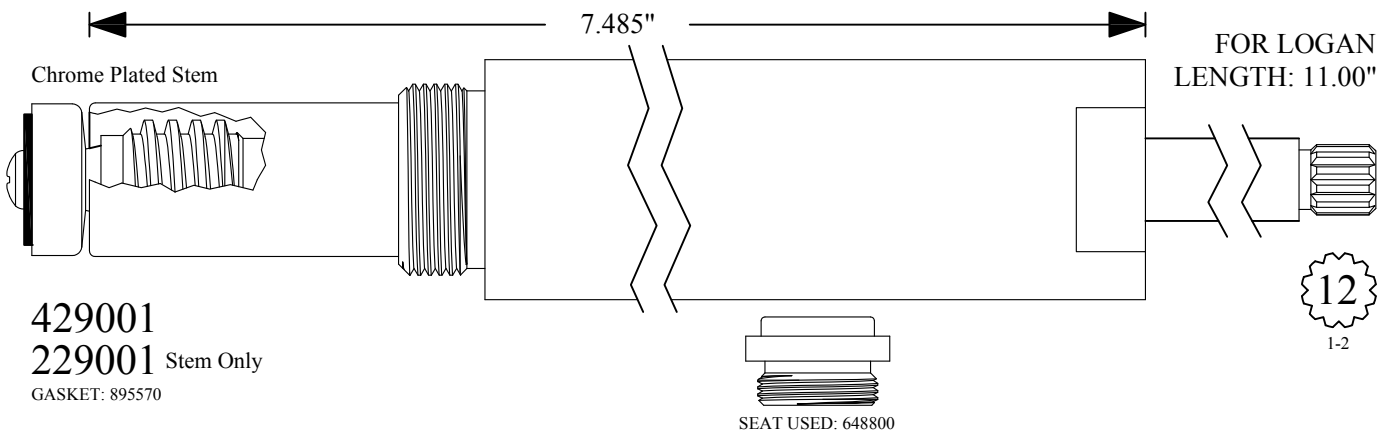

429001
229001 Stem Only
GASKET: 895570

INSTITUTIONAL & SECURITY REPAIR PARTS

FOR METCRAFT
LENGTH: 2.05"

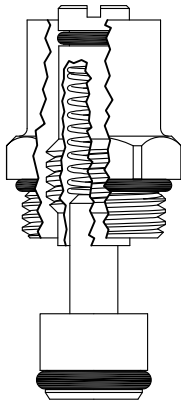

GASKET: 890170 O-RING INCLUDED

LF400751

FOR METCRAFT
LENGTH: 2.10"

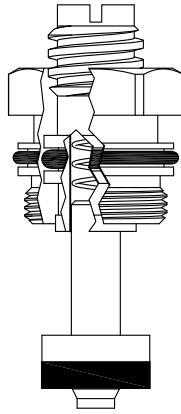

LF400441

FOR METCRAFT
LENGTH: 2.10"

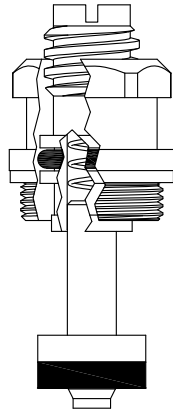

GASKET: 895100 INCLUDED

LF400461

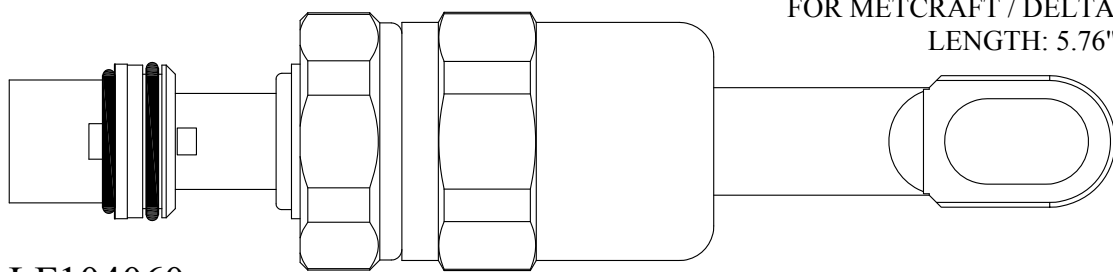

FOR METCRAFT / DELTA
LENGTH: 5.76"

LF104060

106160 Bonnet Only

104550 Lever Handle Only

FOR METCRAFT / DELTA
LENGTH: 2.85"

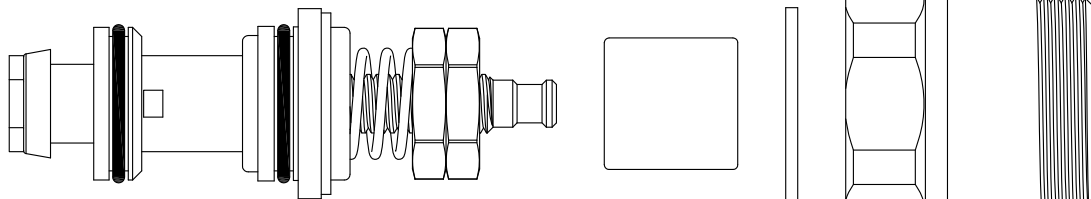

LF128000

LF130850 Cartridge Only

FOR METCRAFT / DELTA
LENGTH: 3.46"

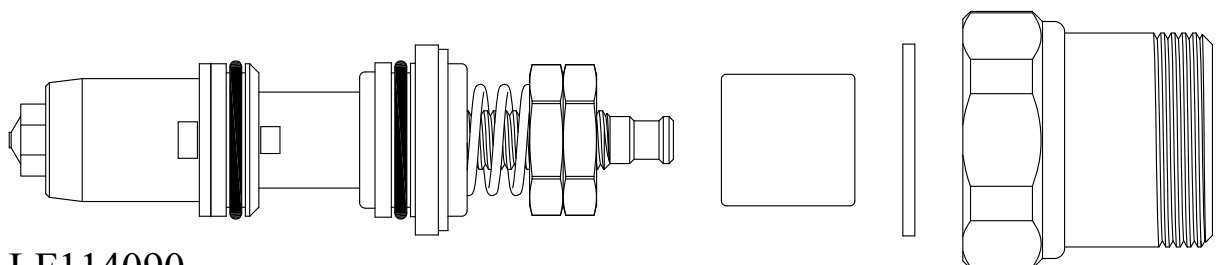

LF114090

LF114020 Cartridge Only

INSTITUTIONAL & SECURITY REPAIR PARTS

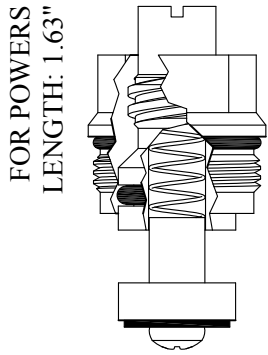

FOR POWERS
LENGTH: 1.63"

GASKET: 890180 O-RING INCLUDED

400261

FOR POWERS
LENGTH: 1.73"

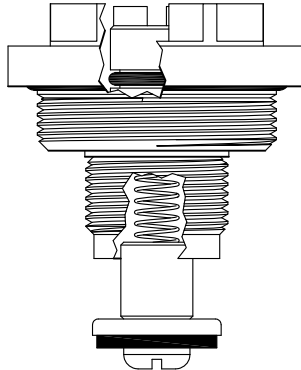

GASKET: 891230 O-RING INCLUDED

400471

200471 Stem Only

500470-KIT Retainer & Spring Only

Also available as chrome plated unit
400471-CP
200471-CP Stem Only

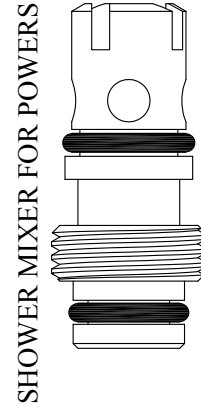

SHOWER MIXER FOR POWERS

Nickel Plated

134230

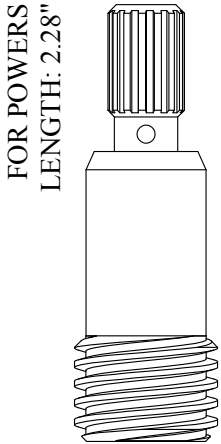

FOR POWERS
LENGTH: 2.28"



201181
OEM# 227-234

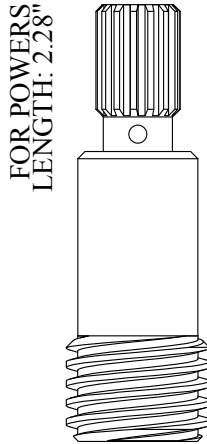

FOR POWERS
LENGTH: 2.28"



201201
OEM# 420-122

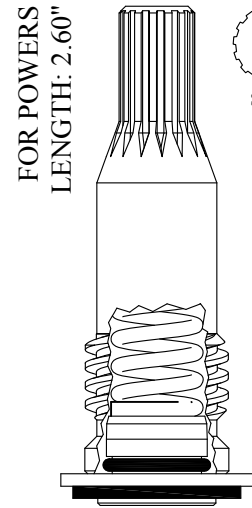

FOR POWERS
LENGTH: 2.60"



201531
OEM# 420-139

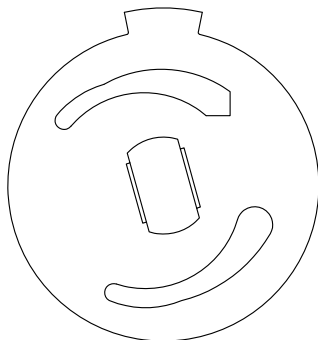

Brass Plate
Chrome Plated Stem

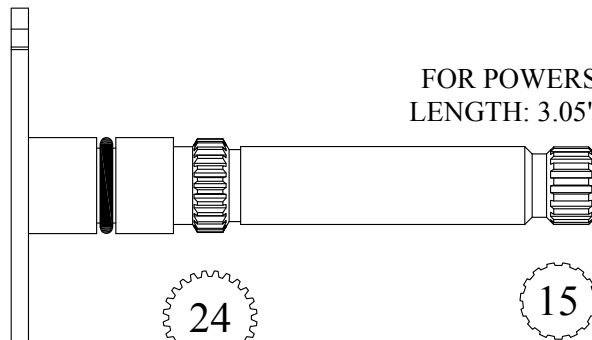

FOR POWERS
LENGTH: 3.05"



201870

INSTITUTIONAL & SECURITY REPAIR PARTS

For Symmons
"Free-Flo"

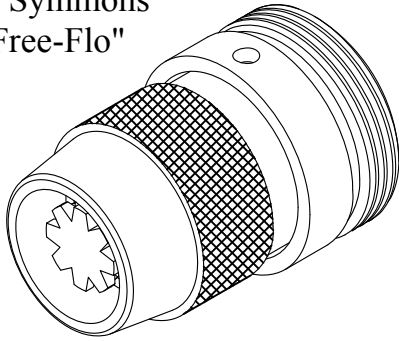

110270: 1.5 GPM
OEM# FF-1A1.5
131190: 2.5 GPM
OEM# FF-1A

For Symmons
"Free-Flo" Rigid

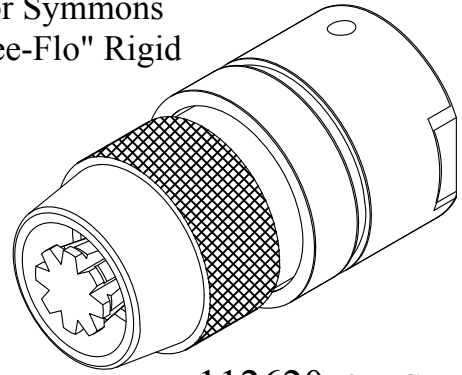

112620: 2.5 GPM
OEM# 4-285F

FOR SYMMONS
LENGTH: 1.75"



400661
OEM# T-52
200661 Stem Only

Chrome Plated Gland & Push Button

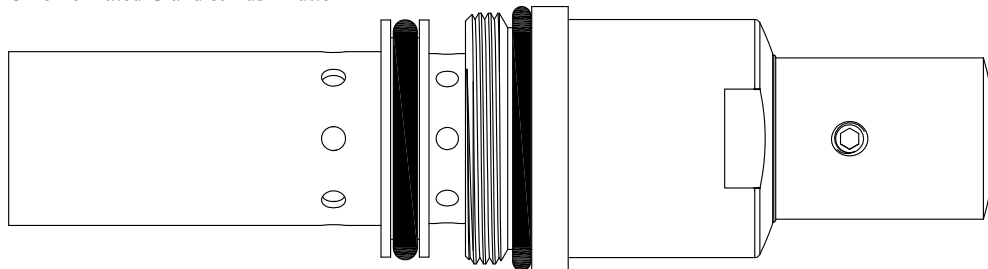

FOR SYMMONS
LENGTH: 5.12"

415410
OEM# NS-1

INSTITUTIONAL & SECURITY REPAIR PARTS

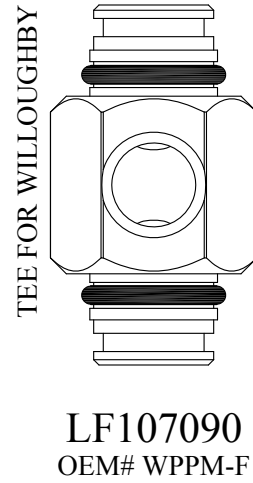
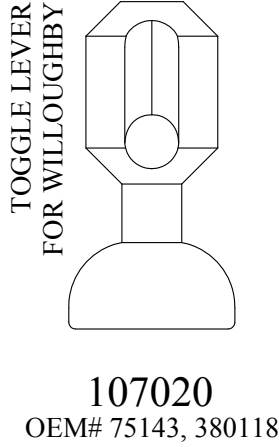
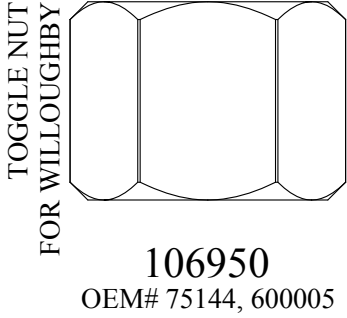

REPAIR KIT AVAILABLE
145450
KIT INCLUDES:
BEVELED BIBB WASHER
15.5MM x 3MM O-RING
.312 x .187 x .062 O-RING
.84 x .625 x .105 WASHER
6-32 x 1/4" BIBB SCREW

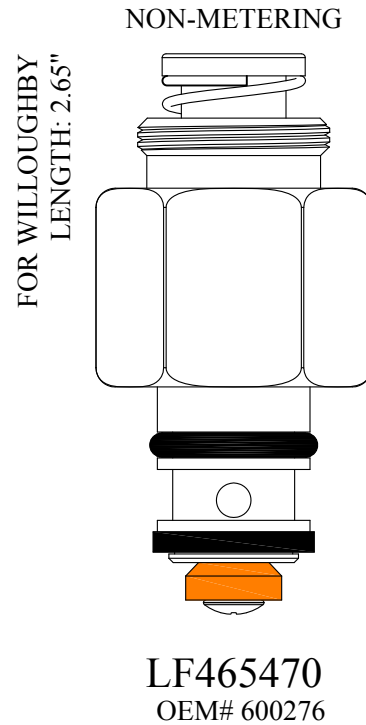
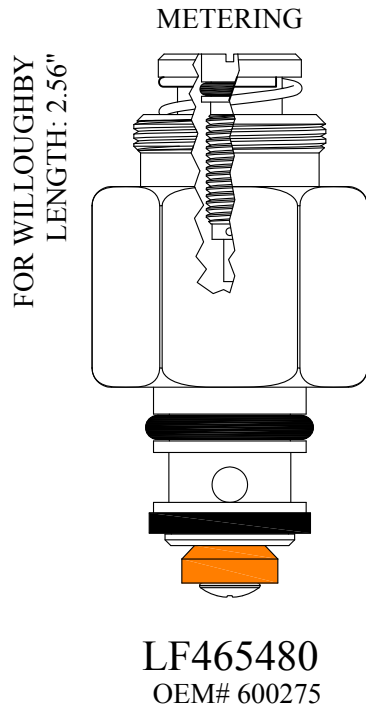
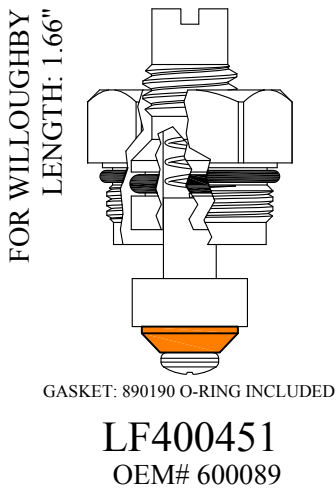

BARRY E.  ALTER SR. CO.

VALVE BODIES, BODY EXTENSIONS & COMPONENTS

VALVE BODIES

DRINKING FOUNTAIN
RETRO KIT

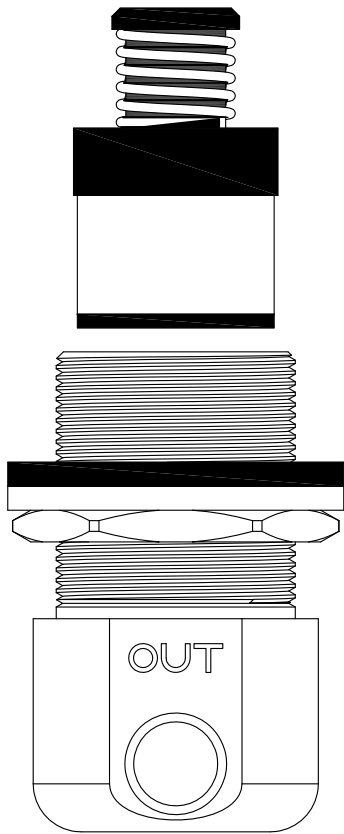

Includes Locknut
LF124640
LF124620

With Cartridge
W/O Cartridge

FOR CRANE PRE-WAR

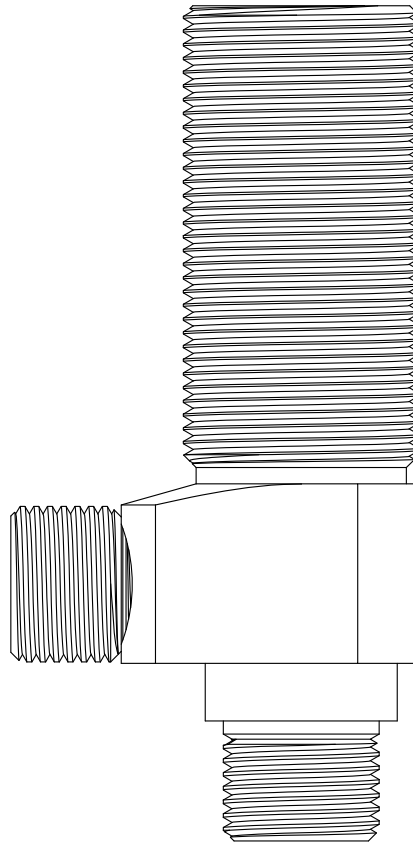

LF132640

FOR CRANE DIAL-EZE

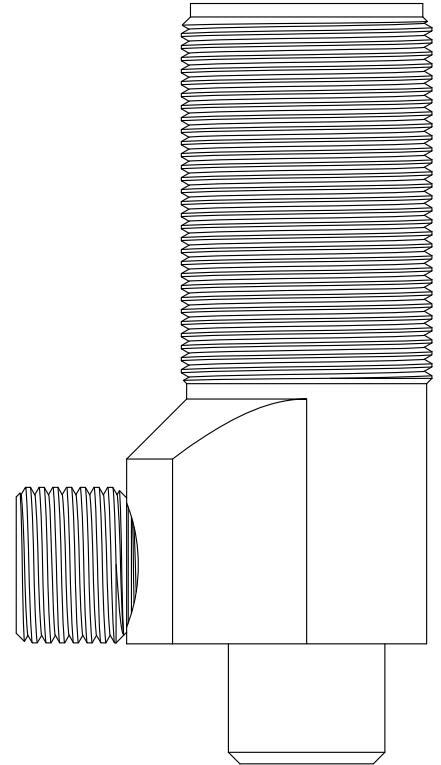

LF122490

FOR CONCINNITY
WIDE SPREAD LAV

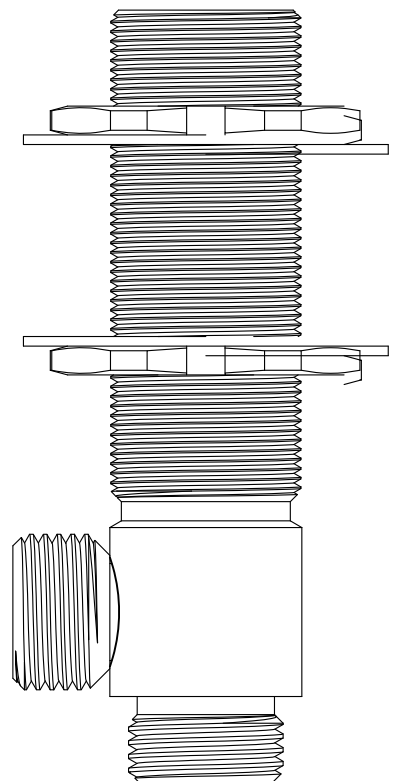

LF189460

279

FOR CRANE DIAL-EZE

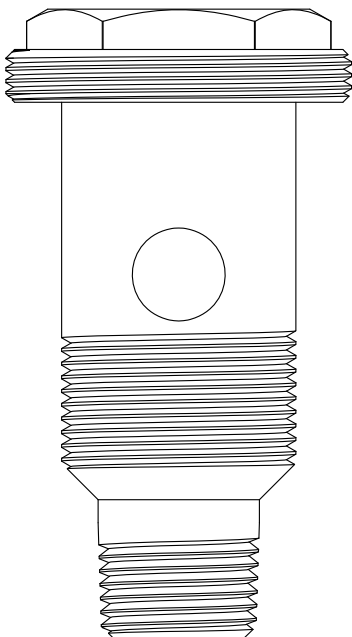

LFF10697

FOR CRANE

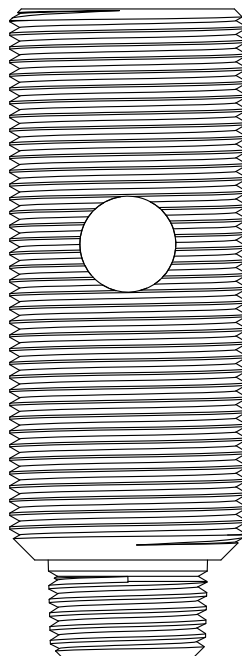

LF115610

VALVE BODIES

FOR TUB ONLY

LF139220 FOR LEVER HANDLES
LF139290 FOR CROSS HANDLES

11" ON CENTER

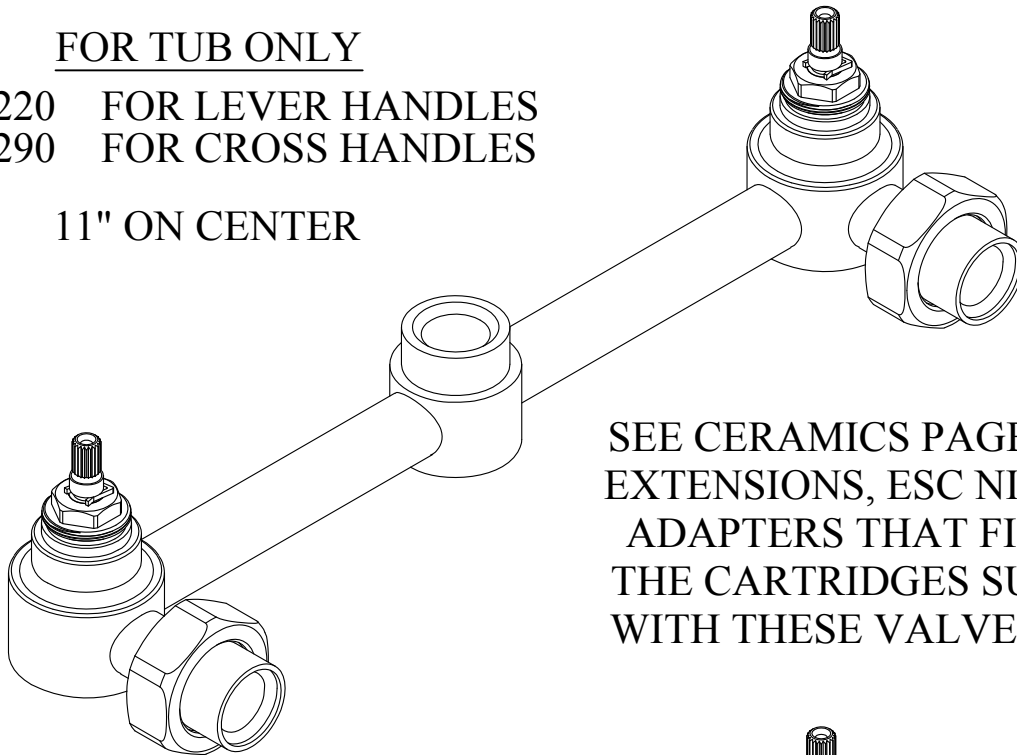

SEE CERAMICS PAGE 62 FOR
EXTENSIONS, ESC NIPPLES &
ADAPTERS THAT FIT WITH
THE CARTRIDGES SUPPLIED
WITH THESE VALVE BODIES

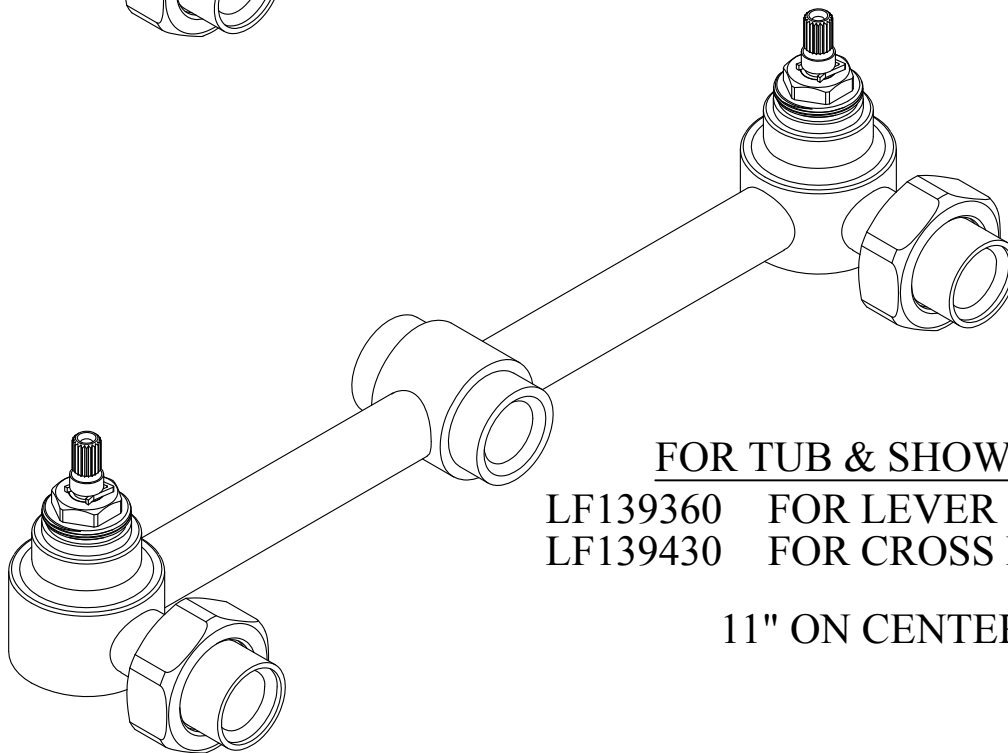

FOR TUB & SHOWER

LF139360 FOR LEVER HANDLES
LF139430 FOR CROSS HANDLES

11" ON CENTER

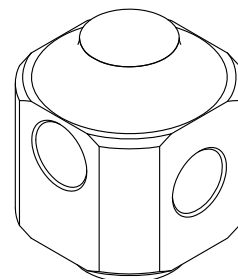

113390

FOR I.W. DIVERTER BODY

VALVE BODY COMPONENTS

FOR CONCINITY
OEM#: VB-1251

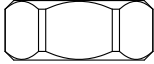

17/32 - 20 Female
117900

FOR CONCINITY

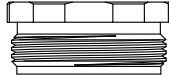

13/16 - 27 Male
127320

FOR CONCINITY

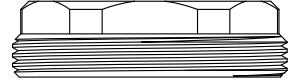

1-7/16 - 20 Male
127180

FOR CONCINITY OEM#: 6840-6

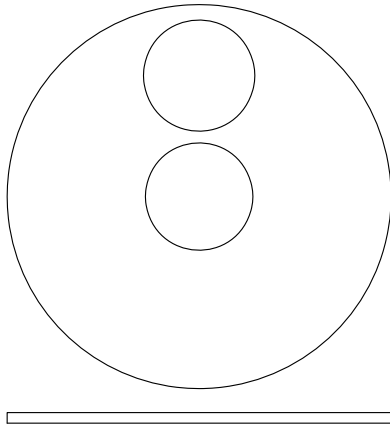

125040

FOR CRANE
OEM#: F11671

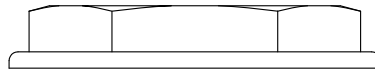

1-7/32 - 14 Female
134300

FOR KOHLER / CONCINITY
OEM#: 78090-RP / 30334-11



1-19/64 - 14 Female
119860

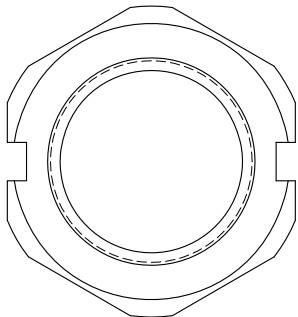

1" - 20 Female
127490



1/2 - 14 NPT Female
118880

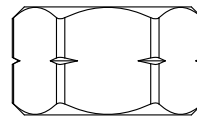

1/2 - 14 NPS Female
104130

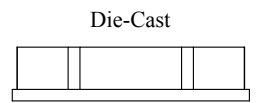

Die-Cast
1/2 - 14 NPS Female
102780

BODY EXTENSIONS

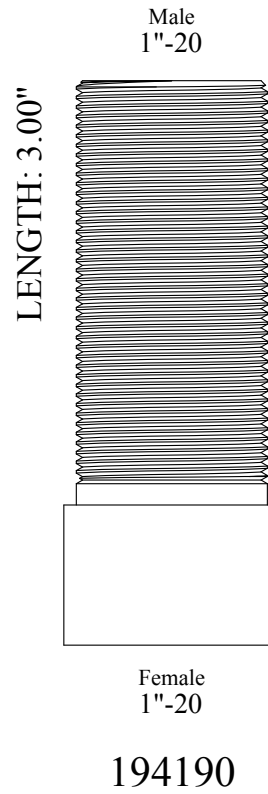
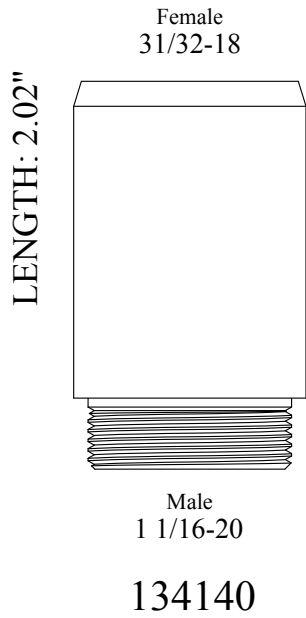

AM STD RELIANT S/L CARTRIDGE EXTENSION KIT

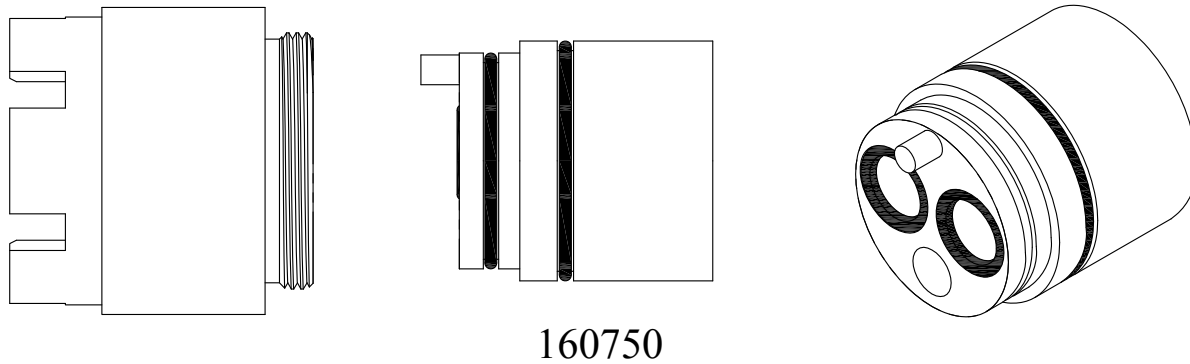

FOR KOHLER VALVETTE

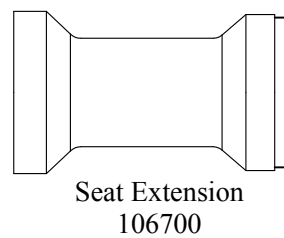
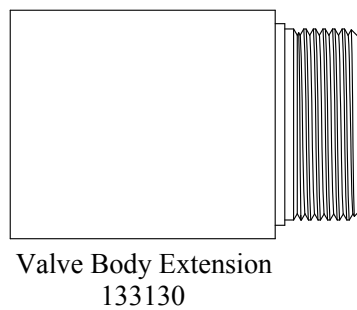

Extension Kit
133060

BARRY E.  SR. CO.

OEM PARTS

MISC. REPAIR PARTS BY MFG.

FOR AMERICAN STANDARD

Large Hole

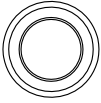

PACKING ADAPTER
FOR SHOWER VALVE
29103-07

Large Hole

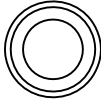

PACKING
FOR SHOWER VALVE
29104-07

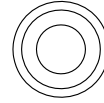

V PACKING
FOR LAV FAUCET
29312-07

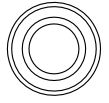

PACKING ADAPTER
FOR LAV FAUCET
LF29313-07

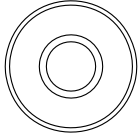

LOCKNUT
FOR LAV FAUCET
20900-07

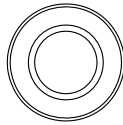

GLAND
FOR EXPOSED SHOWER
LF33897-07

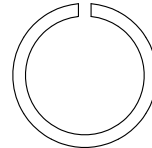

WAVE WASHER
AM STD COLONY
897110
OEM# 72852-0700



108730
OEM# 66353-07

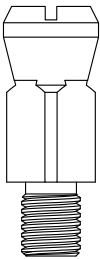

COLD WATER CHOKE
FOR 1/2" MIXING VALVE
1383-27

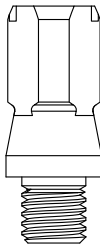

HOT WATER CHOKE
FOR 1/2" MIXING VALVE
1397-27

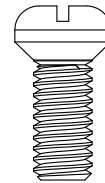

CAP SCREW
FOR 1/2" MIXING VALVE
21779-07

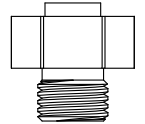

REGULATING SCREW CAP
FOR 1/2" MIXING VALVE
106980
OEM# 851-17

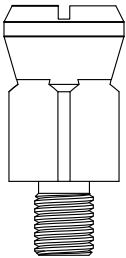

COLD WATER CHOKE
FOR 3/4" MIXING VALVE
27341-07

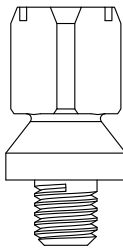

HOT WATER CHOKE
FOR 3/4" MIXING VALVE
27342-07

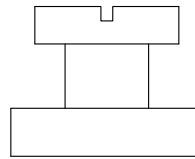

SEAT WASHER HOLDER
FOR 3/4" MIXING VALVE
27343-07 COLD
27344-07 HOT

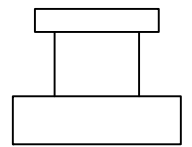

SEAT WASHER HOLDER
FOR 1/2" MIXING VALVE
1399-27 COLD
1400-27 HOT

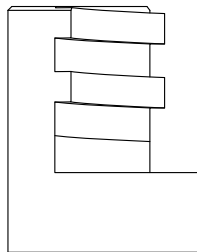

PLUNGER
FOR MIXING VALVE
11306-07 HOT
27208-07 COLD

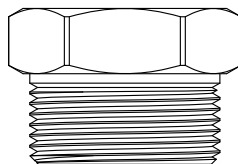

PACKING NUT
FOR MIXING VALVE
24476-07

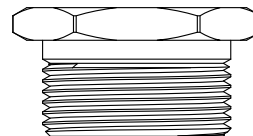

PACKING NUT
FOR MIXING VALVE
305930
OEM# 65497-070

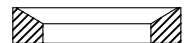

PACKING GLAND
FOR MIXING VALVE
33894-07

MISC. REPAIR PARTS BY MFG.

FOR AMERICAN STANDARD

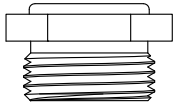

PEDAL VALVE SEAT

LF649710
 OEM# 65626-0040A
LF649710-N
 NICKEL PLATED

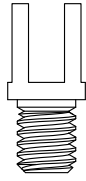

PEDAL VALVE STEM GUIDE

20836-07

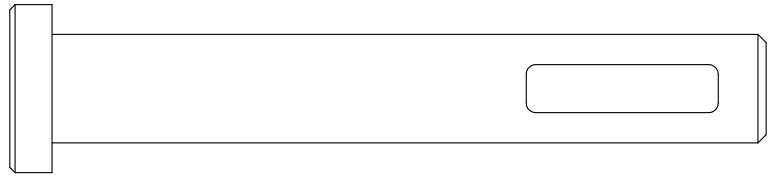

PEDAL VALVE STEM

65183-07

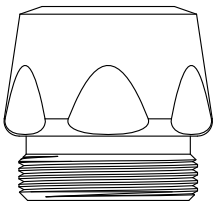

HANDLE BONNET
 FOR WALL MOUNT SINK

139880
 OEM# 28343-02

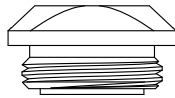

VALVE PLUG
 FOR PUSH-PULL SHOWER VALVE

29109-07

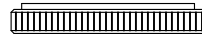

LOCK RING
 FOR DRINKING FOUNTAIN

187-27

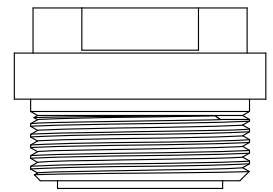

SPRING HOUSING
 FOR DRINKING FOUNTAIN

LF519-22



PACKING NUT
 FOR PRISON VALVE

25009-07

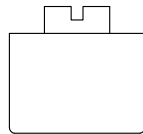

SEAT WASHER HOLDER
 FOR PRISON VALVE

LF60055-07

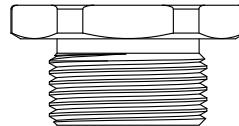

CAP NUT
 FOR PRISON VALVE

LF60053-07

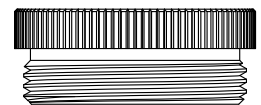

PACKING NUT
 FOR BEDPAN CLEANER

119160

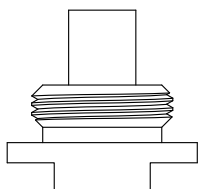

GUIDE PLUG
 FOR BEDPAN CLEANER

132390

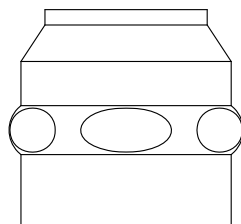

HOSE CONNECTION
 FOR BEDPAN CLEANER

106650
 OEM# 655-12

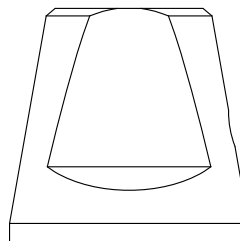

CAP NUT
 FOR BEDPAN CLEANER

33704-02

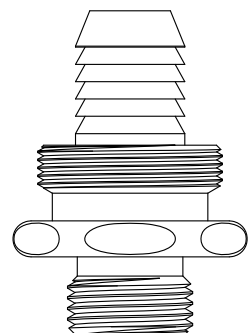

MALE HOSE CONNECTION
 FOR BEDPAN CLEANER

105440
 OEM# 654-12

MISC. REPAIR PARTS BY MFG.

FOR AMERICAN STANDARD

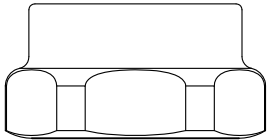
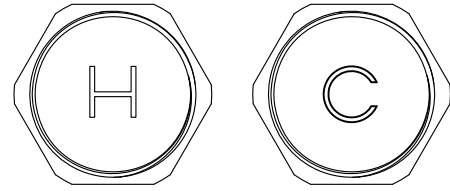
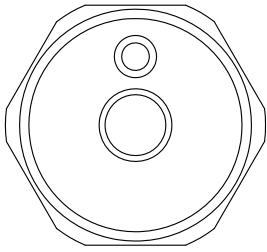

Polished Chrome

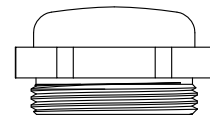

Polished Chrome

111410
OEM# 364-12

143140 Hot OEM# 23329-0230
111550 Cold OEM# 23329-0210
111670 Blank OEM# 23329-Blank

FOR BRADLEY

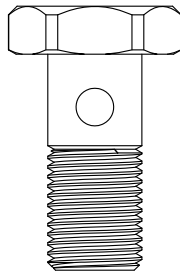

BUBBLER CONNECTION PLUG
FOR PRISON VALVE

LF118180
OEM# 153-183

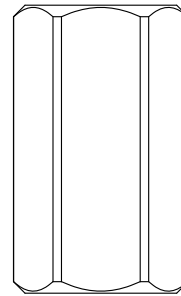

CONNECTION BODY WITH
FLOW CONTROL (0.5 GPM)
FOR PRISON VALVE

126580
OEM# S88-028

FOR CENTRAL

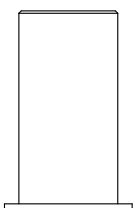

DASHPOT
SLOW-CLOSE FAUCET

LF170-E



RETAINER
FOR SLOW-CLOSE FAUCET

LF170-D

FOR CHICAGO



VACUUM BREAKER SEAT GUIDE

LF118620

Brass Part

MISC. REPAIR PARTS BY MFG. FOR CONCINNITY

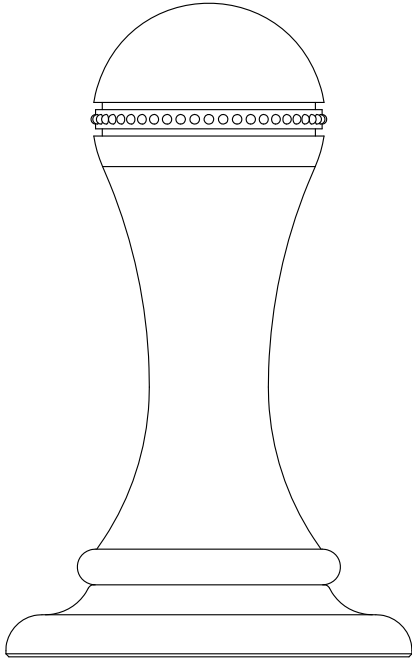

ROBE HOOK
121680

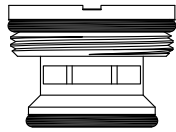

SPRAY DIVERTER
LF103380
OEM# 30820-42

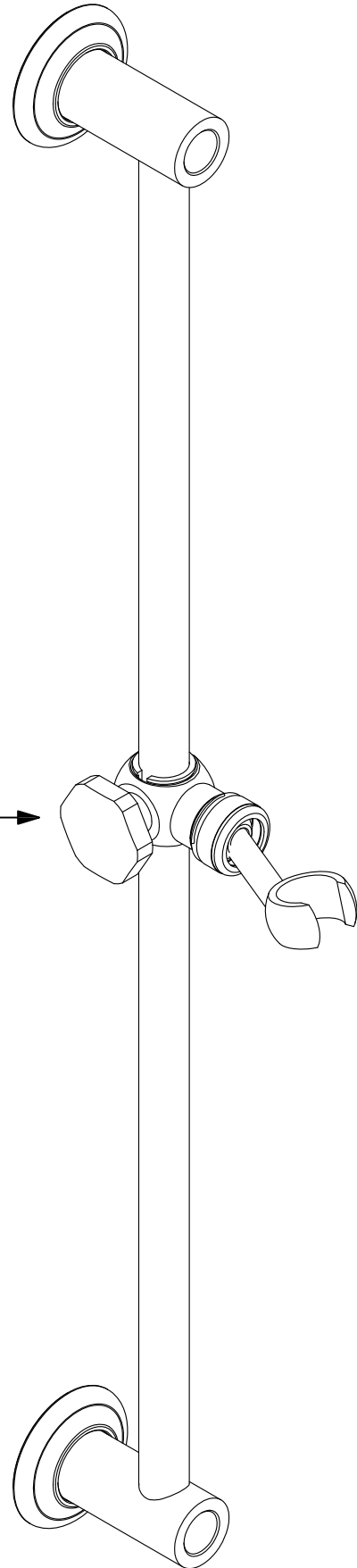

103940 →
OEM# 30791-HCL
CLUTCH
ASSEMBLY
ONLY

117660
OEM# 2916

MISC. REPAIR PARTS BY MFG. FOR CRANE

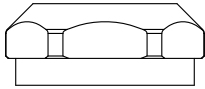

CAP NUT
FOR MAGIC CLOSE
F11993

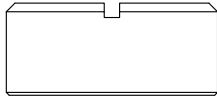

RETAINER NUT
108960

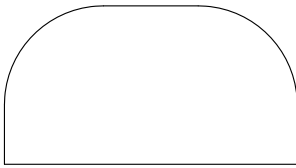

CHROME PLATED COVER
FOR POP-UP
F11619

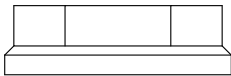

LOCKNUT
FOR DIAL-ESE
F10583 Brass
F10584 Chrome

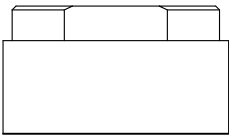

LOCKNUT
FOR DIAL-ESE
F10715 Brass
F10716 Chrome

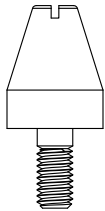

HOT WATER PLUNGER
FOR MIXING VALVE
FB1756

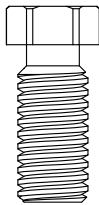

LOCKING RING SCREW
FOR WASTE FITTING
F13521

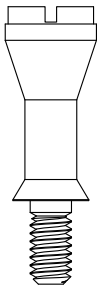

COLD WATER PLUNGER
FOR MIXING VALVE
FB1759

MISC. REPAIR PARTS BY MFG.

FOR DELTA

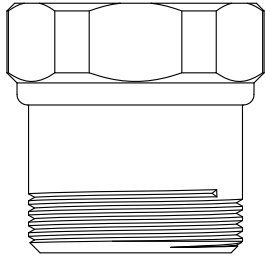

BONNET NUT
FOR METERING VALVE

130240

Also available chrome plated
130240-CP

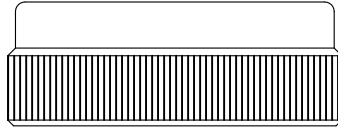

BONNET

140760

REPLACES: OEM# RP6079

Chrome Plated

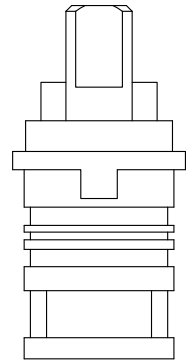

SEAT WASHER HOLDER

DL1740

All Plastic Unit

FOR ELJER

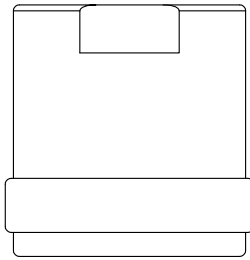

SLEEVE

180640

REPLACES: OEM# 490-8142-01

Chrome Plated

FOR ELKAY/ HALSEY TAYLOR

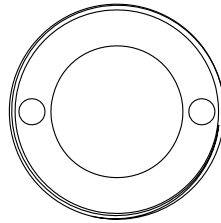

LOCK RING
FOR DRINKING FOUNTAIN

130820

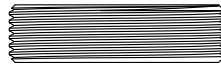

FOR HALSEY TAYLOR

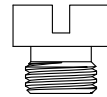

BUSHING
FOR DRINKING FOUNTAIN

LF151450

OEM# 1189

FOR HAWS

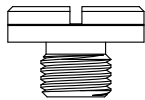

SEAT WASHER HOLDER
FOR DRINKING FOUNTAIN

LF171320

OEM# 1153

FOR KOHLER



PACKING NUT
FOR NIEDECKEN

21974

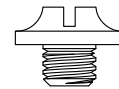

SCREW
FOR MIXING VALVE

21960

FOR MIXET

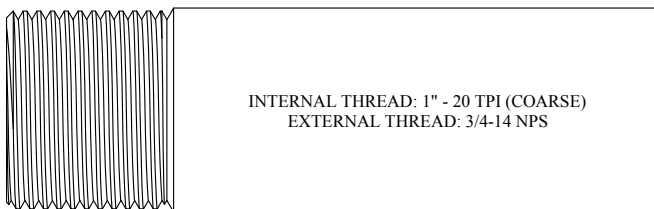

INTERNAL THREAD: 1" - 20 TPI (COARSE)
EXTERNAL THREAD: 3/4-14 NPS

SLEEVE

115450

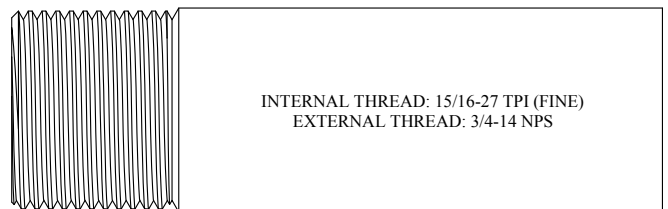

INTERNAL THREAD: 15/16-27 TPI (FINE)
EXTERNAL THREAD: 3/4-14 NPS

SLEEVE

155510

MISC. REPAIR PARTS BY MFG. FOR PARAMOUNT

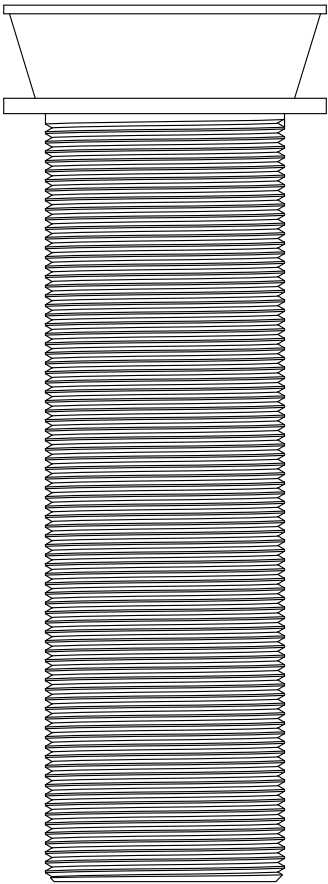

DECK SPOUT HOUSING
105900
OEM# 12702-1

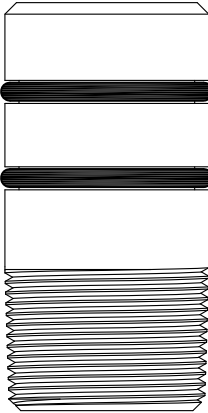

DECK SPOUT SHANK
105970
OEM# 12702-2

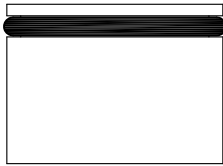

WALL SPOUT FITTING
105830
OEM# 30282

FOR PRICE PFISTER

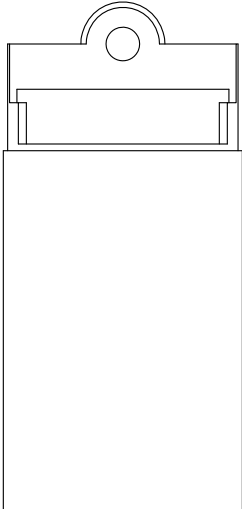

WASTE & OVERFLOW PLUNGER
150530

MISC. REPAIR PARTS BY MFG.

FOR ROYAL BRASS

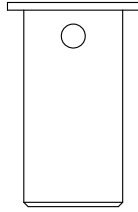

DASHPOT
FOR SELF-CLOSING VALVE
LF18-119



METERING SCREW
FOR SELF-CLOSING VALVE
LF02-110

FOR SPEAKMAN



CHAMBER NUT
FOR METERING VALVE
LF01-0713

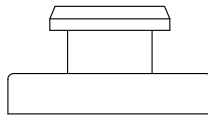

WASHER HOLDER
FOR MIXOMETER VALVE
05-0427 COLD
05-0426 HOT

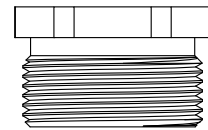

PACKING NUT
FOR MIXOMETER VALVE
01-0352

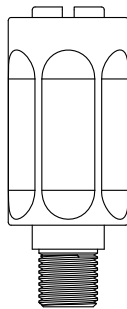

COLD PLUNGER
FOR MIXOMETER VALVE
05-0244

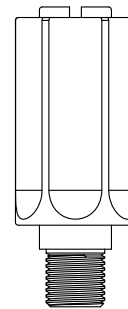

HOT PLUNGER
FOR MIXOMETER VALVE
05-0243

MISC. REPAIR PARTS BY MFG. FOR SPEAKMAN

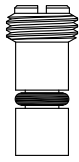

TEMPERATURE LIMIT SCREW
FOR SENTINEL VALVE

03-0305



PLUNGER RETAINER PIN
FOR SENTINAL VALVE

51-0029

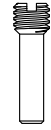

PLUNGER VALVE PIN
FOR SENTINAL VALVE

51-0053

LENGTH: 2.20"

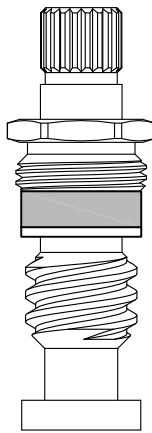

Chrome Plated Stem



STEM UNIT
FOR SENTINEL VALVE

401131

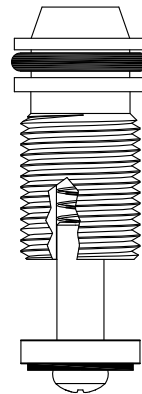

STOP UNIT
FOR SENTINEL VALVE

400390

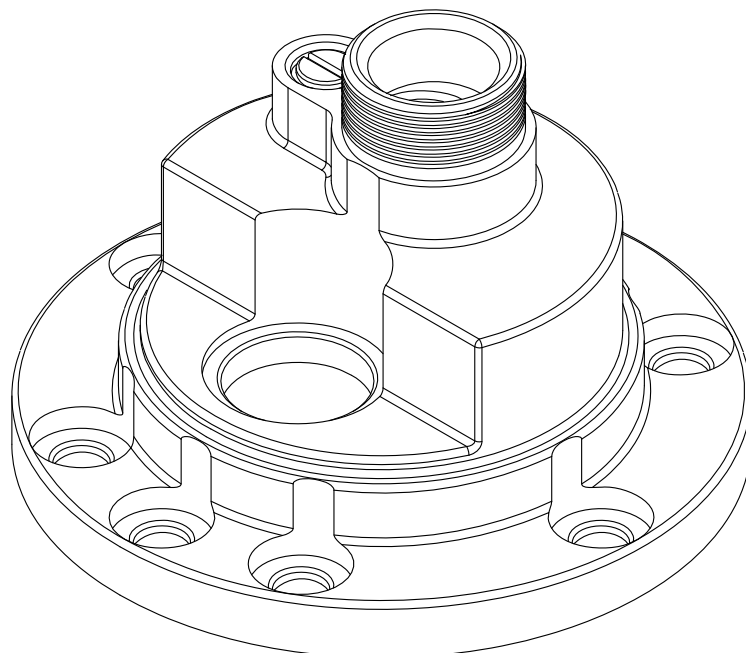

SENTINEL HUB
G06-0021-MO

MISC. REPAIR PARTS BY MFG. UNKNOWN

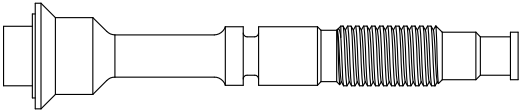

METERING VALVE STEM
STM8906M

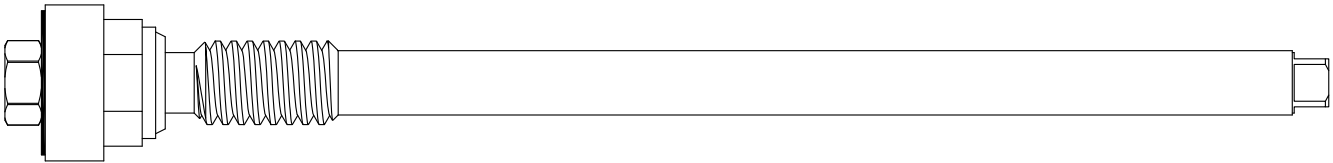

HYDRANT STEM
187361

FOR VALLEY

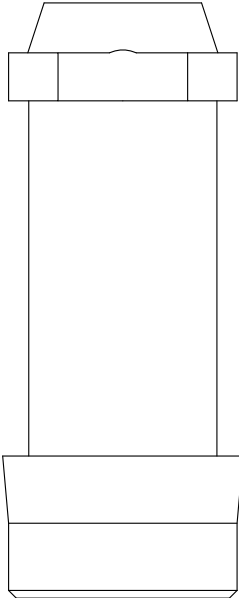

Chrome Plated

SLEEVE
182320
OEM# VA4715