



2550 EAST PLATTE AVE.
FORT MORGAN, CO 80701

800-767-5552
HELPDESK@BARRYWALTER.COM

WWW.BARRYWALTER.COM



HELPDESK

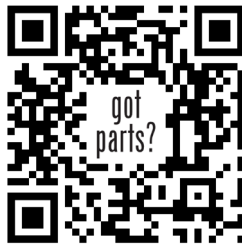

WEBSITE



TABLE OF CONTENTS

1	POP UP WASTE and ASSEMBLIES
23	SHOWER HEADS and ACCESSORIES
47	TUB SPOUTS and ACCESSORIES
69	KITCHEN and ACCESSORIES
75	TOOLS
85	VARIOUS ITEMS



POP-UP WASTE and ASSEMBLIES



SECTION 1







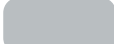

COLOR **PART #** **UPC #** **DESCRIPTION**

ONE PIECE PLASTIC POP-UP SINK DRAIN. EASY ASSEMBLY, WITH STAINLESS STEEL CLAD WASTE SEAT AND PLUNGER. COMES COMPLETE WITH LIFT ROD AND LINKAGE.

-  600S 10002 • PLASTIC **WITH OVERFLOW**
-  600S2 10000 • PLASTIC **NO OVERFLOW**











1/2 X 1/2 POP-UP WITH OVERFLOW • TWO PIECE BRASS TOP, PLASTIC BOTTOM, POP-UP SINK DRAIN WITH OVERFLOW. COMES COMPLETE WITH LIFT ROD AND LINKAGE.

-  630D1 10003 • CHROME SEAT WITH STAINLESS STEEL CLAD TOP & PLUNGER
-  630D2 10004 • CHROME
-  630D4W 10006 • WHITE
-  630DS4W 10009 • WHITE WITH SOLID BRASS STOPPER





ALL BRASS POP-UP SINK DRAIN WITH OVERFLOW AND TAILPIECE WITH FREE ROTATING CONNECTOR NUT. COMES COMPLETE WITH LIFT ROD AND LINKAGE.

-  630E2 10011 • CHROME
-  630E1 10010 • CHROME PLATED BRASS STAINLESS STEEL CLAD PLUNGER
-  630B3PBRPVD 10030 • POLISHED BRASS PVD
-  630E3SP 10210 • SATIN NICKEL PVD
-  630E3ORB 14048 • OIL RUBBED BRONZE
-  C630E1 80188 • CHROME CARDED
-  C630B3PBRPVD 80184 • POLISHED BRASS PVD CARDED
-  C630E3SP 80182 • SATIN NICKEL PVD CARDED
-  C630E3ORB 80189 • OIL RUBBED BRONZE CARDED



COLOR **PART #** **UPC #** **DESCRIPTION**

2-PIECE **ALL BRASS** POP-UP SINK DRAIN, NO OVERFLOW. FEATURES TAILPIECE WITH FREE ROTATING CONNECTOR NUT. COMES COMPLETE WITH LIFT ROD AND LINKAGE.

-  630E8 10036 • CHROME
-  630B8SNPVD 10211 • SATIN NICKEL
-  C630B8SNPVD 80178 • SATIN NICKEL CARDED



3-PIECE **ALL BRASS** POP-UP SINK DRAIN WITH CAST BRASS CENTER SECTION (NO CSA). COMES COMPLETE WITH LIFT ROD AND LINKAGE.





-  6450 10024 • CHROME
-  6451PBRPVD 10025 • POLISHED BRASS PVD
-  C6450 80191 • CHROME CARDED

PLATE TOP FLANGE REPLACEMENT FOR 6450 (CHROME) AND 6451 (POLISHED BRASS) SERIES DRAINS

-  64508 10070 • CHROME
-  64518PBRPVD 10176 • POLISHED BRASS PVD





3-PIECE POP-UP REPLACEMENT KIT FOR 6450 (CHROME) AND 6451 (POLISHED BRASS) SERIES POP-UP DRAINS.

-  64501 10026 • HARDWARE KIT

3-PIECE KIT ONLY FOR 6450 & 6451PBR











COLOR	PART #	UPC #	DESCRIPTION
ALL BRASS SUPER HEAVY DUTY POP-UP SINK DRAIN NO OVERFLOW. COMES COMPLETE WITH LIFT ROD AND LINKAGE.			

	7740	10240	• CHROME
	7740SNPVD	10241	• SATIN NICKEL











PUSH & LOCK CLICKER STYLE POP UP SINK DRAIN WITH OVERFLOW. REPLACEABLE CLICKER STOPPERS AVAILABLE IN OTHER STYLES AND FINISHES, PAGES 8-9.

	6800	10254	• CHROME
	6800SNPVD	14238	• SATIN NICKEL
	6800ORB	14236	• OIL RUBBED BRONZE
	6800MB	14308	• MATTE BLACK
	C6800	80194	• CARDED CHROME
	C6800SNPVD	80193	• CARDED SATIN NICKEL
	C6800ORB	80192	• CARDED OIL RUBBED BRONZE
	C6800MB	80257	• CARDED MATTE BLACK



ALL BRASS PUSH AND LOCK SINK DRAIN NO OVERFLOW. REPLACEABLE CLICKER STOPPERS AVAILABLE IN OTHER STYLES AND FINISHES, PAGES 8-9.

	6840	10256	• CHROME
	6840SNPVD	14239	• SATIN NICKEL
	6840ORB	14237	• OIL RUBBED BRONZE
	6840MB	14309	• MATTE BLACK
	C6840	80195	• CARDED CHROME
	C6840SNPVD	80196	• CARDED SATIN NICKEL
	C6840ORB	80197	• CARDED OIL RUBBED BRONZE
	C6840MB	80258	• CARDED MATTE BLACK

COLOR	PART #	UPC #	DESCRIPTION
			PLASTIC POP-UP WITH POLISHED 304 STAINLESS STEEL CLAD TOP AND PLUNGER • PUSH AND LOCK (CLICKER) SINK DRAIN. 6" LONG PLASTIC TAILPIECE. CONVERTS TO A GRID DRAIN USING (10286) 600CL11 CENTER GRID DRAIN, PAGE 9. REPLACEMENT CLICKER STOPPERS ALSO AVAILABLE, PAGES 8-9.



600CLB 10265 • 304 STAINLESS STEEL CLAD

ONE UNIT TO FIT BOTH STYLE SINKS WITH AND WITHOUT OVERFLOW.

			POLISHED 304 STAINLESS STEEL PUSH & LOCK (CLICKER) POP-UP DRAIN SINK DRAIN WITH OVERFLOW HOLES AND 6" TAILPIECE. CONVERTS TO GRID DRAIN BY REPLACING THE CLICKER STOPPER USING A GRID INSERT (10286 - 600CL11), PAGE 9. REPLACEMENT CLICKER STOPPERS ALSO AVAILABLE, PAGES 8-9.
--	--	--	--



7800 10282 • 304 STAINLESS STEEL

			POLISHED 304 STAINLESS STEEL PUSH AND LOCK SINK DRAIN NO OVERFLOW. LOOKING FOR A GRID DRAIN? CHECK OUT THE 7849. CONVERTS TO A GRID DRAIN USING (10286) 600CL11 , PAGE 9. REPLACEMENT CLICKER STOPPERS ALSO AVAILABLE, PAGES 8-9.
--	--	--	--



7840 10284 • 304 STAINLESS STEEL



COLOR	PART #	UPC #	DESCRIPTION
			POLISHED 304 STAINLESS STEEL GRID DRAIN WITH OVERFLOW, 6" TAILPIECE, AND REMOVABLE CENTER GRID. CONVERT TO CLICKER BY REPLACING THE GRID INSERT WITH 78001 CLICKER STOPPER (10297), PAGES 8-9.

	7809	10283	• POLISHED 304 STAINLESS STEEL
---	------	-------	--------------------------------



			POLISHED 304 STAINLESS STEEL GRID DRAIN NO OVERFLOW, 6" TAILPIECE, AND REMOVABLE CENTER GRID. CONVERT TO CLICKER BY REPLACING THE GRID INSERT WITH 78001 CLICKER STOPPER (10297), PAGES 8-9.
--	--	--	---

	7849	10295	• POLISHED 304 STAINLESS STEEL
---	------	-------	--------------------------------



			ALL BRASS GRID DRAIN WITH OVERFLOW, 6" TAILPIECE AND REMOVABLE CENTER GRID. THE FORGED BRASS FACE FEATURES A CONCAVE DESIGN FOR POSITIVE DRAINAGE LEAVING LITTLE STANDING WATER. SIMPLE TO REMOVE WITH A HEX WRENCH FOR EASY CLEAN OUT. REPLACEMENT GRID INSERT 64091(10289), PAGE 9.
--	--	--	--

	6409	10288	• CHROME WITH REMOVABLE CENTER
---	------	-------	--------------------------------





7800 STAINLESS STEEL LAV. SINK DRAINS

INTERCHANGEABLE CLICKER STYLE PLUNGER CAN BE EASILY REMOVED TO CHANGE THE LOOK OF THE DRAIN

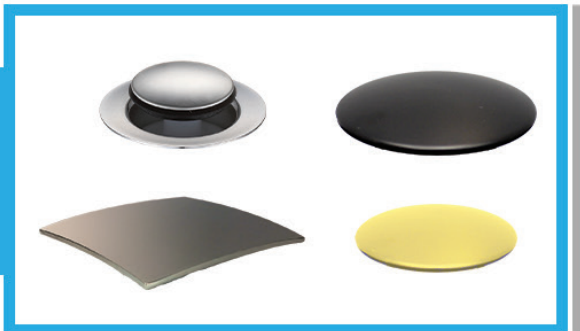



AVAILABLE IN VARIOUS FINISHES, SIZES, and SHAPES.
CHECK OUR CATALOG FOR MORE OPTIONS.





COLOR **PART #** **UPC #** **DESCRIPTION**

ALL BRASS TOP, PUSH AND LOCK (CLICKER) POP-UP STOPPER WITH PLASTIC ASSEMBLY. REPLACEMENT FOR 6800 SERIES POP-UP DRAINS.

-  68001 10255 • CHROME
-  68001SNPVD 14240 • SATIN NICKEL PVD
-  68001ORB 14241 • OIL RUBBED BRONZE



ALL BRASS TOP, 2-3/4" DIAMETER PUSH AND LOCK ROUND DOME WITH PLASTIC ASSEMBLY. STOPPERS FIT 6800, 7800 SERIES & 600CLB.

-  780070CP 14264 • CHROME
-  780070PBRPVD 14281 • POLISHED BRASS
-  780070SNPVD 14265 • SATIN NICKEL
-  780070ORB 14266 • OIL RUBBED BRONZE
-  780070MB 14280 • MATTE BLACK



SOLID BRASS 2-3/4" DIAMETER FIXED POSITION ROUND DOME STOPPERS. FITS 6800, 7800 SERIES & 600CLB.

-  780070CPF 14270 • CHROME
-  780070SNPVDF 14271 • SATIN NICKEL PVD
-  780070ORBF 14272 • OIL RUBBED BRONZE



POLISHED STAINLESS STEEL STOPPER ASSEMBLY REPLACEMENT FOR (7800 | 10282) PUSH AND LOCK POP-UP DRAIN.

-  78001 10297 • POLISHED STAINLESS STEEL TOP

COLOR PART # UPC # DESCRIPTION

DECORATIVE CLICKER PLUNGER WITH 59MM OD BRASS CLAD DOME TOP. FITS 6800 & 7800 SERIES DRAINS.



	780059SS	10326	• POLISHED STAINLESS STEEL
	780059SN	10327	• SATIN NICKEL
	780059ORB	10329	• OIL RUBBED BRONZE
	C780059SS	80233	• CARDED POLISHED STAINLESS STEEL
	C780059SN	80234	• CARDED SATIN NICKEL
	C780059ORB	80236	• CARDED OIL RUBBED BRONZE

2-3/4" SQUARE BRASS TOP DECORATIVE CLICKER PLUNGER FITS 6800 OR 7800 SERIES POP-UP DRAINS.



	78007070CP	14267	• CHROME
	78007070SNPVD	14268	• SATIN NICKEL PVD
	78007070ORB	14269	• OIL RUBBED BRONZE

PLUNGER SEAL FOR ALL 6800 & 7800 SERIES POP DRAINS.



68005	10252	• FITS PLUNGER FOR 6800 & 7800 SERIES POP-UP DRAIN
-------	-------	--

POLISHED STAINLESS STEEL CENTER GRID DRAIN CONVERSION INSERT REPLACEMENT CAP. FITS 600CLB & 7800 SERIES DRAINS.



	600CL11	10286	• POLISHED STAINLESS STEEL
--	---------	-------	----------------------------



CHROME PLATED 9-HOLE CENTER GRID DRAIN REPLACEMENT INSERT (O-RING INCLUDED).



	64091	10289	• REPLACEMENT CENTER FOR THE 6409 & 6439
--	-------	-------	--











COLOR **PART #** **UPC #** **DESCRIPTION**
ALL BRASS LAVATORY **FLAT** GRID DRAIN WITH OVERFLOW. CHROME PLATED, CAST BRASS FACEPLATE WITH FLAT DESIGN. 6" OR 8" 17 GAUGE TAILPIECES AVAILABLE.

-  6425 10027 • CHROME
-  6426 10032 • CHROME WITH AN **8 INCH TAILPIECE**











ALL BRASS LAVATORY **CONCAVE** GRID DRAIN, WITH OVERFLOW, WITH 6" LENGTH / 17 GAUGE TAILPIECE. FORGED BRASS FACE FEATURES CONCAVE DESIGN FOR POSITIVE DRAINAGE LEAVING LITTLE STANDING WATER. AVAILABLE WITH ALTERNATE GRID DESIGN AND STAINLESS STEEL FACE.

-  6427 10130 • CHROME
-  6428 10131 • CHROME WITH AN **8 INCH TALL PIECE**
-  6429 10137 • CHROME WITH **LARGE CENTER HOLE**
-  6429SS 14157 • CHROME BODY WITH SS FACE & **LARGE CENTER HOLE**
-  6427SSCP 10245 • CHROME BODY WITH SS FACE
-  6427PBRPVD 14103 • POLISHED BRASS
-  6427SN 14105 • SATIN NICKEL
-  C6427SN 80239 • SATIN NICKEL CARDED



LAVATORY **CONCAVE** GRID DRAIN NO OVERFLOW, WITH 6" LENGTH / 17 GAUGE TAILPIECE. FORGED BRASS FACE FEATURES CONCAVE DESIGN FOR POSITIVE DRAINAGE LEAVING LITTLE STANDING WATER. AVAILABLE WITH ALTERNATE GRID DESIGN AND STAINLESS STEEL FACE.

-  6440 10133 • CHROME
-  6442 10134 • CHROME WITH AN **8 INCH TALL PIECE**
-  6419SS 14159 • CHROME BODY WITH SS FACE & **LARGE CENTER HOLE**
-  6440PVD 14104 • POLISHED BRASS
-  6440SN 14106 • SATIN NICKEL
-  6440ORB 14109 • OIL RUBBED BRONZE
-  C6440 80237 • CHROME CARDED
-  C6440SN 80238 • SATIN NICKEL CARDED



COLOR PART # UPC # DESCRIPTION

ALL BRASS LAVATORY **FLAT** GRID DRAIN WITH OVERFLOW. CHROME PLATED, CAST BRASS FACEPLATE WITH FLAT DESIGN. OFFSET 17 GAUGE TAILPIECE FOR WHEELCHAIR ACCESS.



 6430 10028 • CHROME

ALL BRASS LAVATORY **CONCAVE** GRID DRAIN WITH OVERFLOW. CHROME PLATED, FORGED BRASS FACEPLATE WITH CONCAVE DESIGN FOR POSITIVE DRAINAGE LEAVING LITTLE STANDING WATER. OFFSET 17 GAUGE TAILPIECE FOR WHEELCHAIR ACCESS.



 6432 10132 • CHROME

 6439 10299 • CHROME WITH **REMOVABLE CENTER**

 6443 14198 • CHROME WITH **LARGE CENTER HOLE**

 6444 10135 • CHROME **NO OVERFLOW**



ALL BRASS, LIFT AND TURN SINK DRAIN WITH OVERFLOW



 6417 14043 • CHROME

 6417PBRPVD 14045 • POLISHED BRASS

 6417SNPVD 14047 • SATIN NICKEL

 64151 14040 • CHROME STOPPER FOR 6415 & 6417

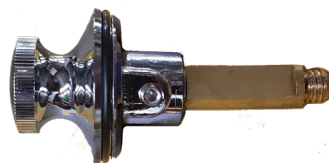

REPLACEMENT STOPPER FOR 6415 & 6417

*ALREADY INCLUDED IN DRAIN ASSEMBLY

COLOR PART # UPC # DESCRIPTION

ALL BRASS, LIFT AND TURN SINK DRAIN NO OVERFLOW



6415 14042 • CHROME



6415PBRPVD 14044 • POLISHED BRASS



6415SNPVD 14046 • SATIN NICKEL



64151 14040 • CHROME STOPPER FOR 6415 & 6417

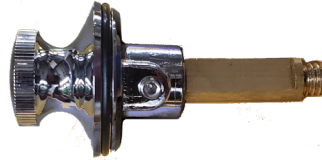

REPLACEMENT STOPPER FOR 6415 & 6417

*ALREADY INCLUDED IN DRAIN ASSEMBLY

ALL BRASS, LAUNDRY / UTILITY ROOM SINK DRAIN, PLUG ASSEMBLY WITH STOPPER, NO OVERFLOW.



COP130 14185 • CHROME

S81 20102 • REPLACEMENT DRAIN STOPPER



HOLLOW STOPPER 1-1/8" WITH RING.
REPLACEMENT FOR COP130 & POP131.

*ALREADY INCLUDED IN DRAIN ASSEMBLY

ALL BRASS, LAUNDRY / UTILITY ROOM SINK DRAIN, PLUG ASSEMBLY WITH STOPPER, WITH OVERFLOW.



POP131 14186 • CHROME

S81 20102 • REPLACEMENT DRAIN STOPPER



HOLLOW STOPPER 1-1/8" WITH RING.
REPLACEMENT FOR COP130 & POP131.

*ALREADY INCLUDED IN DRAIN ASSEMBLY

COLOR PART # UPC # DESCRIPTION
 GRID DRAIN ESCUTCHEON KIT • FITS **GRID DRAINS**, AND **LIFT AND TURN DRAINS**.



6400

14050 • CHROME



6400PVD

14051 • POLISHED BRASS PVD



6400SNPVD

14052 • SATIN NICKEL PVD



GRID DRAIN SHANK EXTENSION KIT • EXTENDS THE SHANK BY 1 1/4 INCHES.



GDX6000

10248 • FOR GRID DRAINS **FITS TO OD**



CGDX6000

80204 • CARDED KIT FOR GRID DRAINS **FITS TO OD**

GRID DRAIN SHANK EXTENSION KIT • EXTENDS THE SHANK BY 1 1/4 INCHES.



GDX6010

10290 • FOR GRID DRAINS **FITS TO ID**

POP-UP DRAIN SHANK EXTENSION KIT • EXTENDS THE SHANK BY 1 1/4 INCHES.



630POPX

10291 • FOR POP-UP DRAINS **FITS TO OD**



C630POPX

80205 • CARDED KIT FOR POP-UP DRAINS **FITS TO OD**



COLOR PART # UPC # DESCRIPTION

BRASS THREAD CONVERSION TAILPIECE • CONVERTS STANDARD GRID DRAIN FROM 1 1/4" X 1 1/2" 6" 17 GAUGE.



TP2550 20142 • CHROME

POLISHED STAINLESS STEEL U-SHAPED DECORATIVE COVER FOR EXPOSED DRAIN PIPES UNDER COMMERCIAL SINKS.



U8013 14173 • POLISHED STAINLESS STEEL

ATTACHES TO PIPE WITH NON-SLIP RUBBERIZED CLIPS ON THE BACK



LIFT & ACTUATOR ROD EXTENSION KIT.



RX07 10207 • CHROME



CRX07 80216 • CARDED CHROME

EXTENDS BOTH LIFT ROD & ACTIVATING ROD UP TO 7"

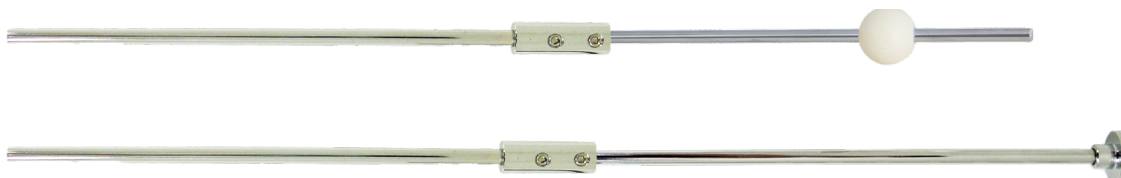

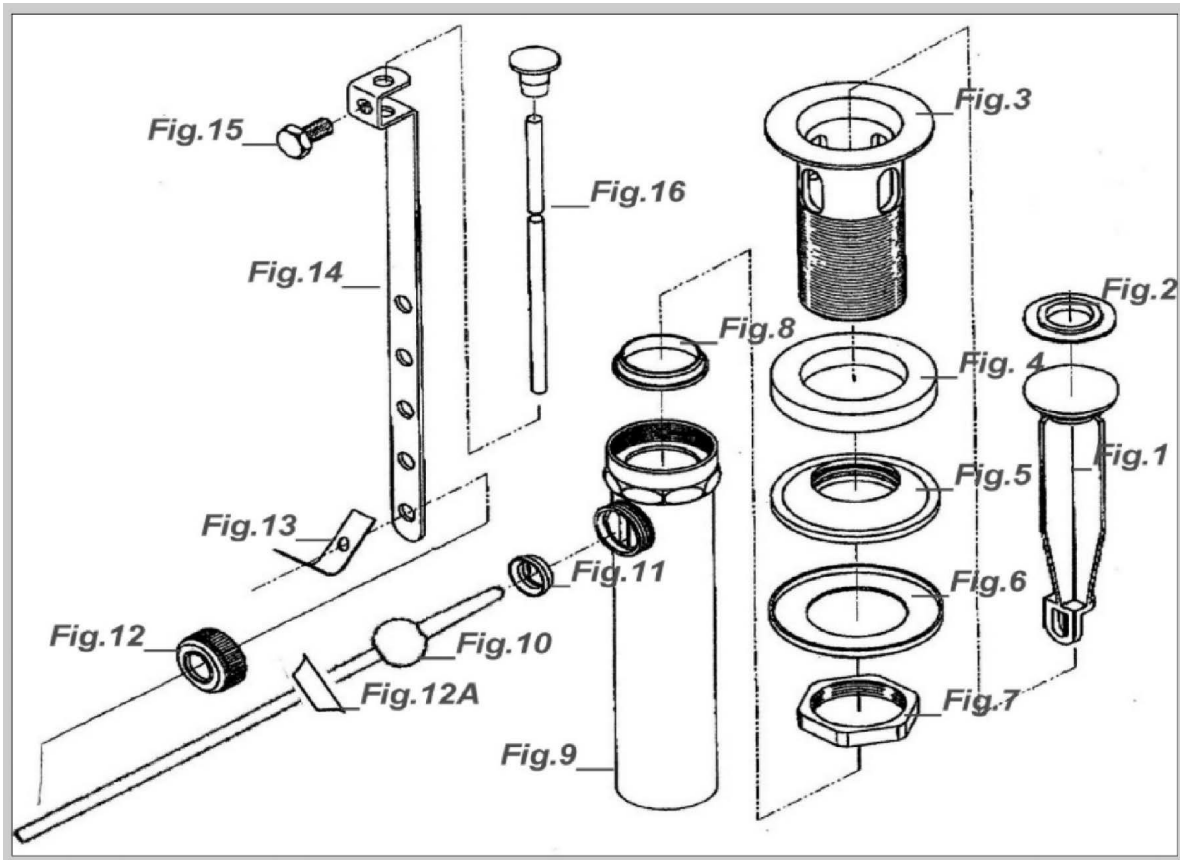

FIGURE









NAME

FIGURE 1	POP-UP PLUNGERS
FIGURE 2	POP-UP PLUNGER SEAL
FIGURE 3	POP-UP WASTE SEAT
FIGURE 4	POP-UP FOAM WASHER
FIGURE 5	POP-UP RUBBER GASKET
FIGURE 6	POP-UP METAL WASHER
FIGURE 7	POP-UP MOUNTING NUT
FIGURE 8	POP-UP SEAL WASHER
FIGURE 9	POP-UP TAILPIECE ASSEMBLY
FIGURE 10	POP-UP PIVOT ROD
FIGURE 11	POP-UP PIVOT ROD SEAL
FIGURE 12	POP-UP PIVOT NUT
FIGURE 12A	POP-UP PIVOT NUT SEAL
FIGURE 13	POP-UP SPRING CLAMP
FIGURE 14	POP-UP DRAIN STRAP
FIGURE 15	POP-UP TUMB SCREWS

SEE THE FOLLOWING PAGES FOR PART NUMBERS AND UPC CODES FOR FIGURES 1 THRU 15

COLOR PART # UPC # DESCRIPTION

FIGURE 1: PLUNGER FOR VARIOUS POP-UP DRAINS

	630016CP		630016CP	10059	• CHROME DIAMETER: 1-1/4" LENGTH: 5-1/4"
	620004		620004	10044	• CHROME FITS 620A05 MOEN DIAMETER: 1-1/4" LENGTH: 5"
	620056		620056	10052	• CHROME FITS 630D1 DIAMETER: 1-1/4" LENGTH: 4-1/4"
	620058CP		620058CP	10056	• CHROME FITS 630DS2 630ES2 DIAMETER: 1-1/4" LENGTH: 4-1/4"
	620070		620070	10053	• CHROME FITS 630D2 DIAMETER: 1-1/4" LENGTH: 4-1/4"
	620070PBR		620070PBR	10054	• POLISHED BRASS DIAMETER: 1-1/4" LENGTH: 4-1/4"
	620070PBRPVD		620070PBRPVD	10043	• POLISHED BRASS FITS 630B3PBRPVD DIAMETER: 1-1/4" LENGTH: 4-1/4"
	620070SNPVD		620070SNPVD	10270	• SATIN NICKEL FITS 630B8SNPVD & 630E3SP DIAMETER: 1-1/4" LENGTH: 4-1/4"
	620070ORB		620070ORB	10212	• OIL RUBBED BRONZE FITS 630B3ORB DIAMETER: 1-1/4" LENGTH: 4-1/4"
	620070PW		620070PW	10055	• WHITE FITS 630D4W DIAMETER: 1-1/4" LENGTH: 4-1/4"
	600B28		600B28	10051	• STAINLESS STEEL FITS 600S & 600S2 DIAMETER: 1-3/8" LENGTH: 4-1/4"
	64502		64502	10065	• CHROME SOLID BRASS TOP FITS 6450 DIAMETER: 1-3/16" LENGTH: 3-3/4"
	64512PBRPVD		64512PBRPVD	10066	• POLISHED BRASS PVD SOLID BRASS TOP FITS 6451 DIAMETER: 1-3/16" LENGTH: 3-3/4"

COLOR PART # UPC # DESCRIPTION

FIGURE 2: POP-UP PLUNGER SEAL



	600008	10096	• FITS PLUNGER FOR 600S & 600S2
	620002	10074	• FITS PLUNGER FOR 630D1, 630D2, 630D4W, 630DS4W

FIGURE 3: BRASS WASTE SEAT FOR POP-UP DRAINS. CONVERTS OVERFLOW TYPES







	620016	10080	• CHROME 630D1, 630D2, 630E1, 630E2
	620016PBR	10081	• POLISHED BRASS
	620016PBRPVD	10041	• POLISHED BRASS PVD
	620016W	10082	• WHITE 630D4W 630DS4W

FIGURE 4: FOAM POP-UP WASHER



	620039	10087	• 600S, 600S2, COP130, POP131 & 630 SERIES I.D.: 1-1/8"
	600029	10071	• 6400, 6800 & 7800 SERIES I.D.: 1-1/4"

FIGURE 5: RUBBER POP-UP GASKET



	600B05	10242	• 600S, 600S2, 6409, 6427, 6428, 6429, 6432, 6439, 6440, 6442, 6800 SERIES & 7800 SERIES O.D.: 2-1/8" I.D.: 1-1/4"
	600B30	10099	• O.D.: 2-1/4" I.D.: 1-1/8"
	620B02	10090	• POP130, COP131 & 630 SERIES O.D.: 2-1/8" I.D.: 1-1/8"
	645003	10243	• 6415, 6417, 6425, 6426, 6430, 6450 & 6451 O.D.: 2-3/16" I.D.: 1-7/16"

COLOR	PART #	UPC #	DESCRIPTION
-------	--------	-------	-------------

FIGURE 6: POP-UP WASHER



620085

10089

• POP130, COP131 & 630 SERIES
I.D.: 1-1/4"

642506

10306

• ALL 6400 & 6800 SERIES DRAINS.
I.D.: 1-1/2"



620051

10045

• SPACER FOR 630 SERIES



620A05

10047

• PLASTIC 600S, 600S2, 6450, 6451

FIGURE 7: POP-UP MOUNTING NUT



600B06

10097

• PLASTIC 600S, 600S



620B04

10091

• BRASS FOR 630 SERIES



642504

10304

• ALL 6400 SERIES GRID DRAINS.

FIGURE 8: PLASTIC POP-UP SEAL WASHER



630028

10095

• 630D1, 630D2, 630D4W, 630DS4W, 630E2, 630E1, 630E8

COLOR PART # UPC # DESCRIPTION

FIGURE 9: POP-UP DRAIN TAIL PIECE ASSEMBLY



620069 10048 • 630D1, 630D2, 630D4W, 630DS4W

630024A 10182 • COP130, POP131



630026 10069 • ALL 630E & 630B SERIES

FIGURE 10: POP-UP PIVOT ROD ASSEMBLY



600K03 10073 • 600S, 600S2 • BALL: 3/4" LENGTH: 6-3/4" (LEFT)

620010 10075 • 630D1, 630D2, 630D4W, 630DS4W (CENTER)

630013 10093 • 630E2, 630E1, 630E8 • BALL: 5/8" LENGTH: 6-3/4" (RIGHT)

COLOR PART # UPC # DESCRIPTION

FIGURE 11: POP-UP PIVOT ROD SEAL



620011 10076 • 630D1, 630D2, 630D4W, 630DS4W

630027 10094 • 630E2, 630E1, 630E8

FIGURE 12: POP-UP PIVOT NUT



600B07 10072 • 600S, 600S2

630009 10092 • 630E2, 630E1, 630E8



620012 10040 • 630D1, 630D2, 630D4W, 630DS4W

Fits Moen

FIGURE 12A: POP-UP PIVOT NUT SEAL



620071 10088 • 630D1, 630D2, 630D4W, 630DS4W

KIT REPLACEMENTS



630D1K 10301

INCLUDES:
620010 (10075) • PIVOT ROD
620011 (10076) • PIVOT ROD SEAL
620012 (10040) • PIVOT NUT

630E1K 10302

INCLUDES:
620013 (10093) • PIVOT ROD
620009 (10092) • PIVOT NUT
620015 (10079) • SPRING CLAMP



COLOR	PART #	UPC #	DESCRIPTION
-------	--------	-------	-------------

FIGURE 13: POP-UP SPRING CLAMP



	620015	10079	• FOR ALL POP-UPS
--	--------	-------	-------------------

FIGURE 14: POP-UP DRAIN ROD STRAP

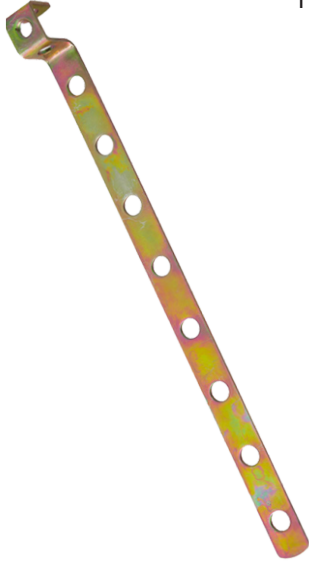

	620013	10077	• FOR ALL POP-UPS
--	--------	-------	-------------------

FIGURE 15: POP-UP THUMB SCREW







	620014	10078	• HEX HEAD - FOR ALL POP-UPS
--	--------	-------	------------------------------



	620014TH	20038	• SPADE HEAD - FOR ALL POP-UPS
--	----------	-------	--------------------------------

FIGURE 16: LIFT ROD & KNOB ASSEMBLY



	620025	10083	• CHROME LENGTH: 8-1/2"
	620029PBR	10085	• POLISHED BRASS LENGTH: 8-3/8"
	620029PBRPVD	10042	• SATIN NICKEL LENGTH: 8-3/8"
	620029SN	10258	• SATIN NICKEL LENGTH: 8-3/8"
	620029W	10086	• MATTE BLACK LENGTH: 8-3/8"



POP UP WASTE ASSEMBLIES

Tailpiece with captured, free rotating connector nut. [Fig. 1] Pat. Pending

- **Saves Time for the Professional!**
- **Installation made simple**
- **Rotating Connector Nut**

Eliminates the difficulty of positioning the linkage port alignment. No more fine threaded tailpiece which is easily cross threaded. Quick and easy connection. [Fig. 1]

- **All Units Are CSA Approved**
- **All Brass Two Piece Design**

One less connection & one less leak problem than the conventional three piece unit.

- **Gasket Washer With Retainer Lip**

When the gasket is compressed, it is forced to hug the threaded seat portion ensuring a leak proof seal. [Fig. 3] Pat. Pending

- **Poly Tailpiece Washer**

A sure seal without the use of pipe joint compound. No messy clean up. Fast easy connection. [Fig. 4]

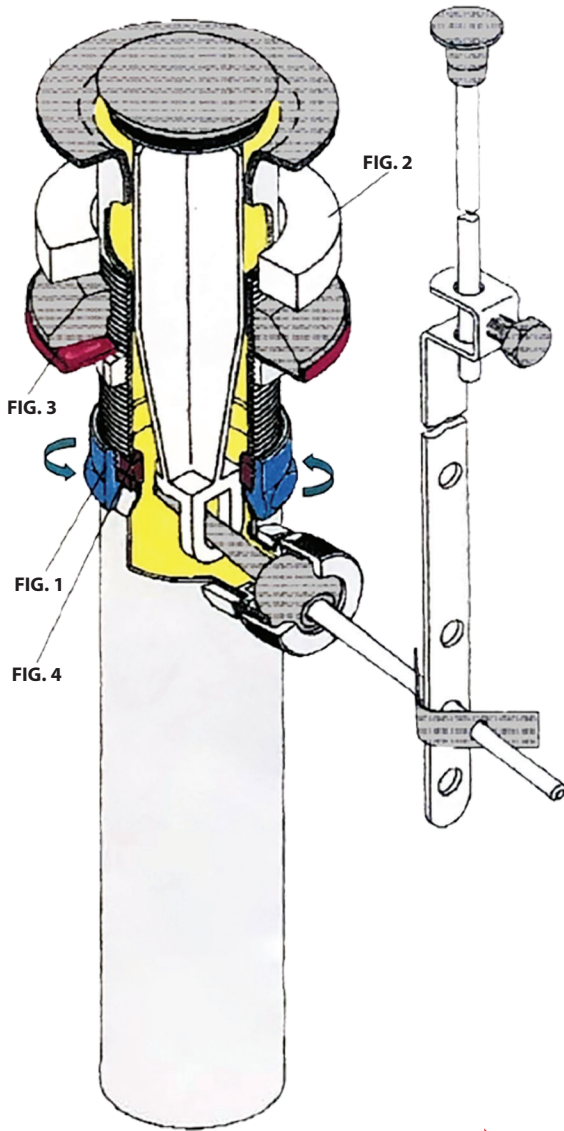

PROVE IT TO YOURSELF! INSTALL ONE!



6450 - 10024



630E8 - 10036



630E2 - 10011

OVER 20 DIFFERENT MODELS TO CHOOSE FROM!

SHOWER HEADS and ACCESSORIES



SECTION 2



COLOR PART # UPC # DESCRIPTION

PLASTIC ECONOMY CHROME PLATED SHOWER HEAD WITH SWIVEL BALL JOINT, ADJUSTABLE SPRAY, AND 2" DIAMETER FACE. 1.8 GPM



S100B 20111 • CHROME

PLASTIC WITH BRASS BALL JOINT CHROME PLATED SHOWER HEAD, WITH ADJUSTABLE SPRAY ANGLE, AND BLACK FACE PLATE. 1.8 GPM



S101 12111 • CHROME

PLASTIC WITH BRASS BALL JOINT CHROME PLATED SHOWER HEAD, WITH ADJUSTABLE SPRAY ANGLE, AND WHITE FACE PLATE. 2.0 GPM



S10120 12146 • CHROME

PLASTIC WITH BRASS BALL JOINT SATIN NICKEL SHOWER HEAD, WITH ADJUSTABLE SPRAY ANGLE, AND BLACK FACE PLATE. 2.5 GPM



S10125SN 12147 • SATIN NICKEL

PLASTIC SINGLE FUNCTION CHROME PLATED SHOWER HEAD, WITH BLACK SPRAY FACE CONNECTOR NUT AND ADJUSTABLE SPRAY. 2.5 GPM



S103 12118 • CHROME

COLOR PART # UPC # DESCRIPTION

CHROME PLATED PLASTIC 3-POSITION SHOWER HEAD WITH ADJUSTABLE MASSAGE FUNCTION SPRAY. BALL JOINT, AND BLACK FACE PLATE. 1.8 GPM



S115 11055 • CHROME

WHITE AND CLEAR PLASTIC SHOWER HEAD WITH ADJUSTABLE SPRAY ANGLE AND CHROME BRASS BALL JOINT. 1.5 GPM



S116 11111 • WHITE

PLASTIC SHOWER HEAD, WITH WATER SAVING AIR INTAKE FEATURE, BRASS BALL JOINT AND CLOG RESISTANT FACEPLATE. 1.75 GPM



S117 11107 • CHROME

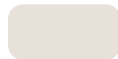

S117W 11112 • WHITE

CHROME PLATED PLASTIC SHOWER HEAD WITH DUO FUNCTION SPRAY AND **ALL BRASS** BALL JOINT. 1.5 GPM



S118 11108 • CHROME

CHROME PLATED PLASTIC SHOWER HEAD **WITH 5 SPRAY FUNCTIONS**, BRASS BALL JOINT, AND BLACK FACEPLATE. 2.0 GPM



S152 11100 • CHROME



CS152 80163 • CHROME CARDED

COLOR PART # UPC # DESCRIPTION



CHROME PLATED PLASTIC WATER SAVING SHOWER HEAD WITH AIR INTAKE FEATURE, BRASS BALL JOINT. AND CLOG RESISTANT FACEPLATE. 1.75 GPM

 S175 11106 • CHROME



CHROME PLATED PLASTIC SHOWER HEAD, WITH BRASS BALL JOINT, AND BLACK FACE PLATE WITH CLOG RESISTANT NOZZLES. 1.8 GPM

 S187 11037 • CHROME



PLASTIC SINGLE FUNCTION SHOWER HEAD WITH BRASS BALL JOINT. FEATURING A REPLACEABLE CLOG RESISTANT FACEPLATE 2.5 GPM. **SEE S168 REPLACEMENT RINGS BELOW AND S188 REPLACEMENT FACEPLATES ON THE FOLLOWING PAGE.**

 S168 11153 • CHROME

 S168W 11155 • WHITE



PLASTIC SINGLE FUNCTION SHOWER HEAD WITH BRASS BALL JOINT. FEATURING A REPLACEABLE CLOG RESISTANT FACEPLATE 2.5 GPM.
REPLACEMENT FACEPLATES AVAILABLE ON FOLLOWING PAGE: S1881, S18803A, S18803W

 S168BCP 11156 • CHROME

REPLACEMENT CHROME PLATED PLASTIC RINGS TO FIT S168 SERIES SHOWER HEADS.



 S168R 14062 • STANDARD CHROME RING REPLACEMENT



 S168BR 14063 • FLOWER DESIGN CHROME RING REPLACEMENT / UPGRADE

ALL BRASS SINGLE FUNCTION SHOWER HEAD WITH BRASS BALL JOINT AND REPLACEABLE CLOG RESISTANT FACEPLATES 1.8 GPM. **SEE S188 FACEPLATES AND RINGS ON THE FOLLOWING PAGE.**



COLOR	PART #	UPC #	DESCRIPTION
	S188	11040	• CHROME
	S188PBRPVD	11041	• POLISHED BRASS PVD
	S188SNPVD	11053	• SATIN NICKEL PVD
	S188ORB	11135	• OIL RUBBED BRONZE
	S188MB	14304	• MATTE BLACK
	S188GG	11044	• GOLD
	S188CPBRPVD	11046	• CHROME & POLISHED PVD
	S188CG	11042	• CHROME & GOLD
	S188WPBRPVD	11047	• WHITE & POLISHED BRASS PVD
	S188BPBRPVD	11048	• BLACK & POLISHED BRASS PVD
	S188WG	11043	• WHITE & GOLD
	CS188	80034	• CHROME CARDED
	CS188PBRPVD	80035	• POLISHED BRASS PVD CARDED
	CS188SNPVD	80040	• SATIN NICKEL PVD CARDED
	CS188ORB	80207	• OIL RUBBED BRONZE CARDED
	CS188MB	80254	• MATTE BLACK CARDED
	CS188CPBRPVD	80041	• CHROME & POLISHED PVD CARDED

JEWEL SERIES EXAMPLES



ALL BRASS SINGLE FUNCTION SHOWER HEAD WITH MODERN RING DESIGN, BRASS BALL JOINT, AND REPLACEABLE CLOG RESISTANT FACEPLATES. SEE S188 FACEPLATES AND RINGS ON THE FOLLOWING PAGE. 1.8 GPM





	S188M	11051	• CHROME
--	-------	-------	----------

COLOR PART # UPC # DESCRIPTION



REPLACEMENT FACEPLATES TO FIT S168 & S188 SERIES SHOWER HEADS. 1.8 GPM



	S18803A	11113	• CHARCOAL FACE PLATE WITH LIGHT GRAY TIPS
	S1881	11039	• CHARCOAL FACEPLATE WITH BLUE TIPS
	S18803W	11114	• WHITE FACEPLATE WITH BLUE TIPS





CHROME PLATED **SOLID BRASS** REPLACEMENT RINGS TO FIT S188 SERIES SHOWER HEADS.



	S188R	14079	• STANDARD CHROME RING REPLACEMENT
	S188MR	14066	• MODERN DESIGN CHROME RING REPLACEMENT

CHROME PLATED **ALL BRASS** SHOWER HEAD, FEATURING FLOW CONTROL BUTTON AND SWIVEL ACTION BALL JOINT. 1.8 GPM



	S383	11011	• CHROME NARROW OD
	S385	11012	• CHROME MID OD
	S387	11013	• CHROME WIDE OD
	S382	11010	• CHROME NO FLOW CONTROL NARROW OD

WASHER FOR S382, S383, S385, S387 SHOWER HEADS (ABOVE) AND S170 SWIVEL JOINT (PAGE 40)



S3870	20170	• WASHER
-------	-------	----------

CHROME PLATED BRASS BODY WITH ADJUSTABLE SPRAY PATTERN, BRASS BALL JOINT, AND WHITE 2" PLASTIC FACEPLATE. 1.8 GPM





	S180	11000	• CHROME
---	------	-------	----------

COLOR PART # UPC # DESCRIPTION

CHROME PLATED **ALL BRASS** SHOWER HEAD WITH ADJUSTABLE SPRAY, BALL JOINT, AND 1-3/4" DIAMETER FACE. AVAILABLE WITH T OR L HANDLE. 1.8 GPM



L HANDLE

	S181	11001	• CHROME T-HANDLE
	S181A	11002	• CHROME L-HANDLE

CHROME PLATED **ALL BRASS** SHOWER HEAD WITH ADJUSTABLE SPRAY, BALL JOINT, AND 2-1/4" DIAMETER FACE. AVAILABLE WITH T OR L HANDLE AND MULTIPLE FINISH OPTIONS. 1.8 GPM



T HANDLE

	S182	11003	• CHROME T-HANDLE
	S182A	11004	• CHROME L-HANDLE
	S182PBRPVD	11031	• POLISHED BRASS PVD L-HANDLE
	S182SNPVD	11033	• SATIN NICKEL PVD L-HANDLE
	S182WG	11015	• WHITE GOLD L-HANDLE
	S182BG	11017	• BLACK GOLD L-HANDLE
	S182CG	11014	• CHROME GOLD L-HANDLE
	CS182	80025	• CHROME T-HANDLE CARDED
	CS182A	80026	• CHROME L-HANDLE CARDED
	CS182CG	80029	• CHROME GOLD L-HANDLE CARDED
	CS182PBRPVD	80019	• POLISHED BRASS PVD L-HANDLE CARDED
	CS182SNPVD	80028	• SATIN NICKEL PVD L-HANDLE CARDED





S182BG

S182CG

CHROME PLATED **ALL BRASS** SHOWER HEAD WITH ADJUSTABLE SPRAY, BALL JOINT, AND 3" DIAMETER FACE. AVAILABLE WITH T OR L HANDLE. CEC CERTIFIED. 1.8 GPM



L HANDLE

	S183	11005	• CHROME T-HANDLE
	S183A	11006	• CHROME L-HANDLE

COLOR	PART #	UPC #	DESCRIPTION
CHROME PLATED BRASS SHOWER HEAD WITH 6 ADJUSTABLE JETS TO SELECT SPRAY PATTERN. 1.8 GPM			
	S606	11126	• CHROME



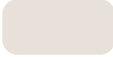

PLASTIC SINGLE FUNCTION 6" DIAMETER SHOWER HEAD WITH BRASS BALL JOINT AND LARGE CLOG RESISTANCE FACE. 1.8 GPM			
	S1070W	11103	• WHITE





CHROME PLATED PLASTIC WATER SAVING SHOWER HEAD WITH 5 SPRAY FUNCTIONS , BRASS BALL JOINT, AND 5" DIAMETER FACE. 1.75 GPM			
	S1205	11085	• CHROME







PLASTIC RAIN STYLE SHOWER HEAD WITH BRASS BALL JOINT, AND 7-1/2" CLOG RESISTANT FACE. 2.0 GPM			
	S1201	11119	• CHROME
	S1201SN	11116	• SATIN NICKEL







PLASTIC RAIN STYLE WATER SAVING SHOWER HEAD WITH BRASS BALL JOINT, AND 7" FULLY FINISHED FACE WITH CLOG RESISTANT NOZZLES. 1.8 GPM			
	S1204	11184	• CHROME
	S1204SN	11185	• SATIN NICKEL





COLOR	PART #	UPC #	DESCRIPTION
PLASTIC 7" LONG SINGLE FUNCTION SPRAY HANDHELD SHOWER HEAD WITHOUT FLOW CONTROL. 1.5 GPM			
	PSC110C	11061	• CHROME
	PSC100W	11060	• WHITE
	CPSC110C	80011	• CHROME CARDED
	CPSC100W	80010	• WHITE CARDED





PLASTIC 7" LONG SINGLE FUNCTION SPRAY HANDHELD SHOWER HEAD WITH FLOW CONTROL. 1.5 GPM			
	PSC210C	11063	• CHROME
	PSC200W	10062	• WHITE
	CPSC210C	80013	• CHROME CARDED
	CPSC200W	80012	• WHITE CARDED

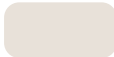

PLASTIC SINGLE FUNCTION SPRAY SHOWER HEAD WITHOUT FLOW CONTROL, WITH CLOG RESISTANT NOZZLES. 1.8 GPM			
	PSC300C	11684	• CHROME
	PSC300W	11092	• WHITE

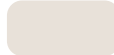

PLASTIC SINGLE FUNCTION SPRAY SHOWER HEAD WITH FLOW CONTROL AND CLOG RESISTANT NOZZLES. 1.8 GPM			
	PSC307C	11685	• CHROME
	PSC307W	11087	• WHITE
	CPSC307W	80165	• WHITE CARDED







COLOR PART # UPC # DESCRIPTION

PLASTIC WATER SAVING HANDHELD SHOWER HEAD WITH MULTIPLE SPRAY FUNCTIONS, 3-POSITION MASSAGE FEATURE, AND PLASTIC FACE. 1.5 GPM

	PSC308C	11094	• CHROME
	PSC308SN	11095	• SATIN NICKEL
	CPSC308C	80153	• CHROME CARVED



PLASTIC HAND HELD SHOWER HEAD WITH 5 ADJUSTABLE SPRAY FUNCTIONS AND PLASTIC FACE. 1.75 GPM

	PSC450	11097	• CHROME
	PSC450SN	11159	• SATIN NICKEL
	CPSC450	80164	• CHROME CARVED
	CPSC450SN	80242	• SATIN NICKEL CARVED



RUBBER WASHER FOR 1/2" PIPE AND SHOWER HOSE CONNECTION WITH STAINLESS STEEL SCREEN

L295S	20039	• RUBBER WASHER WITH SCREEN
-------	-------	-----------------------------









RUBBER SHOWER HOSE WASHER WITH 3/4" OD FOR 1/2" PIPE, SHOWER HOSE AND SHOWER HEAD CONNECTION. 1/4" - 1/8" - 1/16" THICKNESS OPTIONS

L90	20040	• 1/4" THICK
L290	20041	• 1/8" THICK
L334	20042	• 1/16" THICK
SCW15	10300	• VARIETY PACK 5 OF EACH 1/4" - 1/8" - 1/16"

COLOR PART # UPC # DESCRIPTION



59" SHOWER HEAD HOSE FEATURING DOUBLELOCK WITH CHROME PLATED NUT.



	PSH59BCP	11058	• CHROME
	PSH59SN	14111	• SATIN NICKEL
	PSH59SS	11059	• STAINLESS STEEL
	PSH59VCN	11070	• WHITE VINYL
	CPSH59BCP	80014	• CHROME CARDED
	CPSH59SN	80243	SATIN NICKEL CARDED
	CPSH59VCN	80017	• WHITE VINYL CARDED



POLISHED STAINLESS STEEL SHOWER HOSE • STRETCHES 59" TO 80"



	PSH5980SS	11057	• STAINLESS STEEL
	CPSH5980SS	80158	• STAINLESS STEEL CARDED

69" SHOWER HEAD HOSE FEATURING DOUBLELOCK WITH CHROME PLATED SOLID BRASS NUT.



	PSH69BCP	11068	• BRASS CHROME PLATED
	PSH69SS	11069	• STAINLESS STEEL
	CPSH69BCP	80015	• BRASS CHROME PLATED CARDED

80" STAINLESS STEEL SHOWER HEAD HOSE FEATURING DOUBLELOCK WITH CHROME PLATED SOLID BRASS NUT.

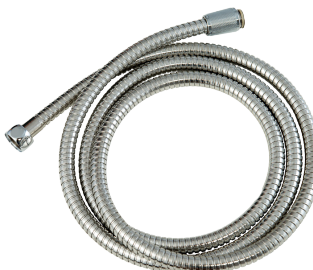

	PSH80SS	11072	• STAINLESS STEEL
---	---------	-------	-------------------

COLOR	PART #	UPC #	DESCRIPTION
			ARM MOUNT SHOWER KIT WHITE • PERSONAL SHOWER KIT INCLUDES: (PSC100W) SINGLE FUNCTION WHITE HAND HELD SHOWER HEAD, (PSH59VCN) 59" WHITE VINYL SHOWER HOSE WITH CHROME PLATED TAPERED NUT, (PSC401W) WHITE SHOWER ARM MOUNT. 1.5 GPM



	CPS1000	80001	• WHITE
---	---------	-------	---------

			ARM MOUNT SHOWER KIT WHITE WITH FLOW CONTROL • PERSONAL SHOWER KIT INCLUDES: (PSC200W) WHITE HANDHELD SHOWER HEAD WITH FLOW CONTROL, (PSH59VCN) 59" WHITE VINYL HOSE, (PSC401W) WHITE SHOWER ARM MOUNT WITH HOSE CONNECTION. 1.5 GPM
--	--	--	--



	CPS1100	80002	• WHITE
---	---------	-------	---------

			ARM MOUNT SHOWER KIT CHROME • PERSONAL SHOWER KIT INCLUDES: (PSC110C) HAND HELD SHOWER HEAD, (PSH59BCP) 59" CHROME PLATED BRASS HOSE, AND (PSC401C) CHROME PLATED SHOWER ARM MOUNT. 1.5 GPM
--	--	--	---



	CPS1200	80003	• CHROME
---	---------	-------	----------

			ARM MOUNT SHOWER KIT CHROME WITH FLOW CONTROL • PERSONAL SHOWER KIT INCLUDES: (PSC210C) HAND HELD SHOWER HEAD WITH PAUSE FEATURE, (PSH59SN) 59" SATIN NICKEL HOSE, (PSC401C) CHROME PLATED. 1.5 GPM
--	--	--	---



	CPS1400	80004	• CHROME
---	---------	-------	----------

COLOR	PART #	UPC #	DESCRIPTION
-------	--------	-------	-------------



ARM MOUNT CHROME & WHITE SHOWER KIT WITH FLOW CONTROL • PERSONAL SHOWER KIT INCLUDES: (PSC200W) WHITE HAND HELD SHOWER HEAD, (PSH69BCP) 69" CHROME PLATED BRASS HOSE, (PSC402C) CHROME PLATED SHOWER ARM MOUNT. 1.5 GPM

	CPS1500WG	80005	• WHITE
---	-----------	-------	---------



ARM MOUNT CHROME SHOWER KIT WITH FLOW CONTROL • PERSONAL SHOWER KIT INCLUDES: (PSC210C) CHROME HAND HELD SHOWER HEAD WITH FLOW CONTROL, (PSH69BCP) 69" CHROME PLATED BRASS HOSE, (PSC402C) CHROME PLATED SHOWER ARM MOUNT. 1.5 GPM

	CPS1600	80006	• CHROME
---	---------	-------	----------



WALL MOUNT SHOWER KIT CHROME • PERSONAL SHOWER KIT INCLUDES: (PSC210C) CHROME PLATED HAND HELD SHOWER HEAD, (PSH59SS) 59" STAINLESS STEEL HOSE, (S338) CHROME SHOWER DIVERTER, (WB10) CHROME PLATED WALL BRACKET. 1.5 GPM

	CPS2100	80171	• CHROME
---	---------	-------	----------



ARM MOUNT WATER SAVING SHOWER KIT • PERSONAL SHOWER KIT INCLUDES: (PSC450 / PSC450SN) WATER SAVING HAND HELD SHOWER HEAD, (PSC402C / PSC402SN) SHOWER ARM MOUNT, (PSH5980SS / PSH59SN) SHOWER HOSE ALL PACKED IN A BLISTER PACK WITH PRODUCT CARD. 1.75 GPM

	CPS3800	80008	• CHROME
---	---------	-------	----------

	CPS3800SN	80018	• SATIN NICKEL
---	-----------	-------	----------------





COLOR	PART #	UPC #	DESCRIPTION
ARM MOUNT SHOWER KIT CHROME WITH STRETCH HOSE • PERSONAL SHOWER KIT INCLUDES: (PSC308) CHROME PLATED HANDHELD SHOWER HEAD, (PSH5980SS) STAINLESS STEEL STRETCH HOSE, (PSC402C) CHROME PLATED SHOWER ARM MOUNT. 1.5 GPM			

	CPS3805	80009	• CHROME
---	---------	-------	----------



SHOWER ARM FLANGE • .7/8" ID (.875") FOR 1/2" NOMINAL PIPE SIZE.



	F120	11120	• STAINLESS STEEL
	F120PBRPVD	11121	• POLISHED BRASS
	F120G	11025	• GOLD
	F120SN	20167	• SATIN NICKEL



DIE-CAST SHOWER ARM FLANGE **WITH SET SCREW** • 7/8" ID (.875) FOR 1/2" NOMINAL PIPE SIZE.



	F122	11122	• CHROME
	CF122	80052	• CHROME CARDED



DIE-CAST SHOWER ARM FLANGE **WITH SET SCREW** • 13/16" ID (.812) FOR 1/2" NOMINAL PIPE SIZE. FITS SNUGLY ON SHOWER ARMS.



	F122S	11125	• CHROME
	F122SSN	14262	• SATIN NICKEL
	CF122S	80157	• CHROME CARDED
	CF122SSN	80147	• SATIN NICKEL CARDED

COLOR PART # UPC # DESCRIPTION
ALL BRASS 6"L SHOWER ARM (.056" / 1.40MM WALL THICKNESS).

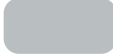

	S614	20014	• CHROME
	S614PBRPVD	20015	• POLISHED BRASS PVD

ALL BRASS 6" SHOWER ARM (.056" / 1.40MM WALL THICKNESS) AND MATCHING FLANGE.



	090N	11022	• CHROME
	090NPBR	11030	• POLISHED BRASS
	090NPBRPVD	11032	• POLISHED BRASS PVD
	090NSN	11035	• SATIN NICKEL
	090NORB	11136	• OIL RUBBED BRONZE
	090NMB	14305	• MATTE BLACK
	090NWG	11024	• WHITE AND GOLD
	090NBG	11026	• BLACK AND GOLD
	090NG	11025	• GOLD
	C090N	80044	• CHROME CARDED
	C090NPBRPVD	80045	• POLISHED BRASS CARDED
	C090NSN	80051	• SATIN NICKEL CARDED
	C090NORB	80177	• OIL RUBBED BRONZE CARDED
	C090NMB	80255	• MATTE BLACK CARDED









090NWG

090NBG

ALL BRASS 8"L SHOWER ARM (.056" / 1.40MM WALL THICKNESS).



	S814	20016	• CHROME
	S814PBRPVD	20017	• POLISHED BRASS
	S814SN	20168	• SATIN NICKEL
	CS814	80245	• CHROME CARDED
	CS814PBRPVD	80247	• POLISHED BRASS CARDED
	CS814SN	80246	• SATIN NICKEL CARDED

COLOR PART # UPC # DESCRIPTION

CHROME PLATED **ALL BRASS** S-SHAPED SHOWER ARM, LIFTS SHOWER HEAD 4"



S504 20028 • CHROME



ALL BRASS S-SHAPED SHOWER ARM FITS CLOSE TO WALL, LIFTS SHOWER HEAD 8"



S508 20019 • CHROME



S508SN 20169 • SATIN NICKEL



CHROME PLATED **ALL BRASS** S-SHAPED SHOWER ARM FITS CLOSE TO WALL, LIFTS SHOWER HEAD 10"



S510 20020 • CHROME



CS510 80218 • CHROME CARDED



CHROME PLATED **ALL BRASS** S-SHAPED SHOWER ARM 10.5"H TO THE WALL, LIFTS SHOWER HEAD 8"







S507 20018 • CHROME

COLOR PART # UPC # DESCRIPTION



S-SHAPED RAIN SHOWER ARM, 9"H X 18"W, WITH AND WITHOUT MATCHING FLANGE.



	S918	11147	• CHROME WITH FLANGE
	S918SN	11149	• SATIN NICKEL WITH FLANGE
	S9181	11146	• CHROME
	S9181SN	11148	• SATIN NICKEL

U-SHAPED SHOWER ARM EXTENSION 8"H X 16"W X 4"T



	SU16	14260	• CHROME
	SU16SN	14261	• SATIN NICKEL



SHOWER ARM FOR LARGER RAIN SHOWER HEADS.





	S1100PVD	11082	• POLISHED BRASS PVD
---	----------	-------	----------------------

18" SHOWER ARM WALL SUPPORT FOR LONG SHOWER ARMS.



	WCS18	14250	• CHROME
	WCS18SN	14251	• SATIN NICKEL



COLOR	PART #	UPC #	DESCRIPTION
HIGH-LOW ADJUSTABLE HEIGHT SHOWER ARM WITH WING NUT LOCKS, 9" LONG.			
	S518	11118	• CHROME
	CS518	80240	• CHROME CARDED



6" STRAIGHT BRASS SHOWER ARM, 1/2" IPS MALE X 1/2" IPS FEMALE 1.40MM WALL THICKNESS.

	SR06	14255	• CHROME
	SR06SN	14257	• SATIN NICKEL

4" STRAIGHT BRASS SHOWER ARM, 1/2" IPS MALE X 1/2" IPS MALE 1.40MM WALL THICKNESS



	S40M	14258	• CHROME
	S40MSN	14259	• SATIN NICKEL

BRASS DOUBLE SWIVEL JOINT CONNECTION FITS ALL STANDARD SHOWER HEADS, AND ALLOWS THE SHOWER HEAD TO SWING TWICE THE DISTANCE.





	S170	11049	• CHROME
	CS170	80221	• CHROME CARDED
	S3870	20170	• WASHER REPLACEMENT



COLOR PART # UPC # DESCRIPTION

BRASS DUAL SHOWER ARM WITH DIVERTER.



	S1200	11142	• CHROME
	S1200SN	11143	• SATIN NICKEL

ALL BRASS WATER-SAVING FLOW CONTROL AND SHUT OFF BUTTON FOR SHOWER HEAD
1/2" IPS MALE X 1/2" IPS FEMALE.



	S335	11007	• CHROME
---	------	-------	----------

ALL BRASS WATER-SAVING TWIST KNOB FLOW CONTROL AND SHUT OFF VALVE FOR SHOWER HEAD
1/2" IPS MALE X 1/2" IPS FEMALE.



	S336	11008	• CHROME
	S336PBR	11029	• POLISHED BRASS
	S336SN	11133	• SATIN NICKEL
	S336WG	11019	• WHITE GOLD



S336WG





S336BG

	S336BG	11021	• BLACK GOLD
	CS336	80146	• CHROME CARDED
	CS336PBR	80168	• POLISHED BRASS CARDED
	CS336SN	80150	• SATIN NICKEL CARDED

COLOR PART # UPC # DESCRIPTION





ALL BRASS SHOWER DIVERTER WITH TWIST KNOB FLOW DIVERTER FEATURE
1/2" IPS MALE X 1/2" IPS MALE X 1/2" IPS FEMALE.

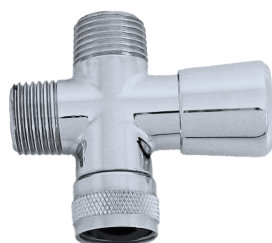

	S337	11009	• CHROME
	S337SN	11134	• SATIN NICKEL
	CS337	80021	• CHROME CARDED
	CS337SN	80033	• SATIN NICKEL CARDED



ALL BRASS PUSH-PULL FLOW SHOWER DIVERTER WITH 1/2" IPS FEMALE SHOWER ARM OUTLET AND TWO 1/2" IPS MALE CONNECTIONS FOR SHOWER HOSE AND SHOWER HEAD.



	S338	11027	• CHROME
	S338SNPVD	11034	• SATIN NICKEL
	CS338	80020	• CHROME CARDED
	CS338SNPVD	80145	• SATIN NICKEL PVD CARDED



CHROME PLATED **ALL BRASS** WALL HOOK WITH INCLUDED HARDWARE.



	PSC377C	11064	• CHROME
	CPSC377C	80023	• CHROME CARDED

CHROME PLATED **ALL BRASS** DELUXE 90 DEGREE SWIVEL JOINT CONNECTOR WITH HOSE CONNECTION.





	PSC378C	11065	• CHROME
	CPSC378C	80022	• CHROME CARDED

COLOR PART # UPC # DESCRIPTION

CHROME PLATED SHOWER ARM MOUNT WITH PIN AND HOSE CONNECTION.



	PSC390C	11066	• CHROME
	CPSC390C	80024	• CHROME CARDED



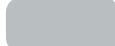

CHROME PLATED **ALL BRASS** 110 DEGREE SWIVEL JOINT ELBOW. ARM MOUNT SWIVEL CONNECTOR.



	PSC478C	11093	• CHROME
	CPSC478C	80215	• CHROME CARDED



PERSONAL SHOWER ARM MOUNT WITH HOSE CONNECTION

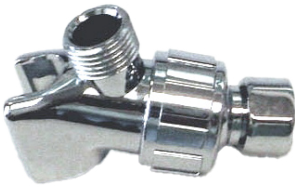

	PSC401C	11075	• CHROME
	PSC401W	11074	• WHITE
	CPSC401C	80076	• CHROME CARDED
	CPSC401W	80077	• WHITE CARDED

PERSONAL SHOWER ARM MOUNT WITH BRASS BALL JOINT AND HOSE CONNECTION.







	PSC402C	11076	• CHROME
	PSC402SN	11096	• SATIN NICKEL
	CPSC402C	80078	• CHROME CARDED
	CPSC402SN	80079	• SATIN NICKEL CARDED

COLOR	PART #	UPC #	DESCRIPTION
-------	--------	-------	-------------

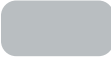
UNIVERSAL FIT WALL MOUNT 90 DEGREE SHOWER SUPPLY ELBOW.





	SE350	11130	• CHROME
	SE350PBRPVD	11131	• POLISHED BRASS PVD
	SE350SNPVD	11132	• SATIN NICKEL PVD
	CSE350	80154	• CHROME CARDED
	CSE350SNPVD	80156	• SATIN NICKEL PVD CARDED



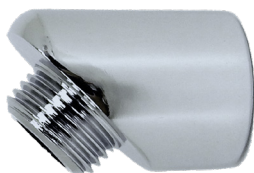

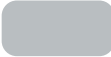
SHOWER ARM ELBOW WITH 45 DEGREE ANGLE
1/2" IPS MALE X 1/2" IPS FEMALE.



	SE45	14252	• CHROME
	SE45SN	14253	• SATIN NICKEL

CHROME PLATED PLASTIC WALL MOUNT BRACKET /CRADLE FOR PERSONAL HAND HELD SHOWER HEAD.



	WB10	14263	• CHROME
	CWB10	80214	• CHROME CARDED

CHROME PLATED PLASTIC WALL BRACKET /CRADLE WITH SUCTION CUP FOR PERSONAL HAND HELD SHOWER HEAD.







	PSC145	11091	• CHROME
---	--------	-------	----------

COLOR PART # UPC # DESCRIPTION

SOLID BRASS SHOWER VACUUM BREAKER FOR PERSONAL SHOWER HOSE.



	PSC143	11077	• CHROME
	PSC143SN	14097	• SATIN NICKEL
	CPSC143	80148	• CHROME CARDED
	CPSC143SN	80149	• SATIN NICKEL CARDED

VACUUM BREAKER REPAIR KIT • REPAIR KIT FOR PSC143 SERIES VACUUM BREAKERS.



PSC143RK	11117	• REPAIR KIT
----------	-------	--------------

SHOWER HEAD FLOW RESTRICTORS FOR VARIOUS SHOWER HEAD STYLES.



	FR15	20144	• SCREW IN - GREEN - 1.5 GPM
	FR10	20139	• SCREW IN - WHITE - 2.5 GPM

SHOWER HEAD FLOW RESTRICTORS FOR VARIOUS SHOWER HEAD STYLES.



S115FR	20137	• FITS S115 SHOWER HEADS - GREEN - 1.5 GPM
--------	-------	--

SHOWER HEAD FLOW RESTRICTORS FOR VARIOUS SHOWER HEAD STYLES.



S188FR	20138	• FITS S188 SHOWER HEADS - ORANGE - 1.5 GPM
--------	-------	---

S188FR18	20107	• FITS S188 SHOWER HEADS - BLUE - 1.8 GPM
----------	-------	---



S188FR25		• FITS S188 SHOWER HEADS - WHITE - 2.5 GPM
----------	--	--









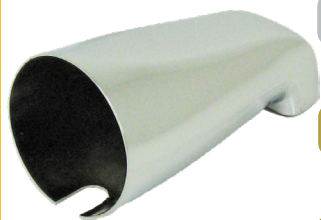



TUB SPOUTS and ACCESSORIES

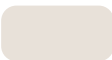

SECTION 3





COLOR	PART #	UPC #	DESCRIPTION
5 1/4" NOSE MOUNT 1/2" IPS • ZINC TUB SPOUT WITH 1/2" IPS NOSE MOUNT.			
	TS137	10104	• CHROME
	TS137PBR	10119	• POLISHED BRASS
	TS137PBRPVD	10147	• POLISHED BRASS PVD
	TS137SN	14131	• SATIN NICKEL
	TS137ORB	10237	• OIL RUBBED BRONZE
	TS137MB	14300	• MATTE BLACK
	TS137W	10114	• WHITE
	TS137B	10120	• BLACK
	TS137G	10113	• GOLD
	CTS137	80104	• CHROME CARDED
	CTS137PBRPVD	80106	• POLISHED BRASS CARDED
	CTS137SN	80110	• SATIN NICKEL CARDED
	CTS137ORB	80161	• OIL RUBBED BRONZE CARDED
	CTS137MB	80250	• MATTE BLACK CARDED
	CTS137BK	80109	• POLISHED BLACK CARDED
	CTS137W	80107	• WHITE CARDED

COLOR PART # UPC # DESCRIPTION

5 1/4" NOSE MOUNT 3/4" IPS • ZINC TUB SPOUT 3/4" IPS NOSE MOUNT.
INCLUDES PLASTIC REDUCER BUSHING



TS147 10153 • CHROME

5 1/4" NOSE MOUNT 1/2" IPS WITH DIVERTER • ZINC TUB SPOUT WITH FRONT DIVERTER & 1/2" IPS NOSE MOUNT.



TS134 10101 • CHROME



TS134PBR 10108 • POLISHED BRASS



TS134PBRPVD 10146 • POLISHED BRASS PVD



TS134SN 14130 • SATIN NICKEL



TS134ORB 10238 • OIL RUBBED BRONZE



TS134MB 14301 • MATTE BLACK



TS134BG



TS134BG 10122 • BLACK GOLD



CTS134 80090 • CHROME CARDED



CTS134PBR 80091 • POLISHED BRASS CARDED



CTS134PBRPVD 80092 • POLISHED BRASS PVD CARDED



CTS134SN 80098 • SATIN NICKEL CARDED



CTS134ORB 80162 • OIL RUBBED BRONZE CARDED



CTS134MB 80251 • MATTE BLACK CARDED

COLOR PART # UPC # DESCRIPTION

5 1/4" NOSE MOUNT 3/4" IPS WITH DIVERTER • ZINC TUB SPOUT WITH FRONT DIVERTER 3/4" IPS NOSE MOUNT.



 TS144 10148 • CHROME

5 1/4" SLIP FIT 5/8" • ZINC TUB SPOUT FOR 5/8" SLIP FIT OD COPPER TUBE.

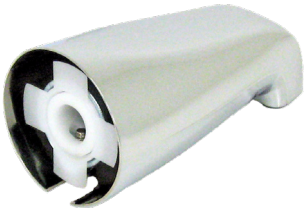

 TS132 10106 • CHROME

 TS132PBR 10107 • POLISHED BRASS

 CTS132 80080 • CHROME CARDED

 CTS132PBR 80081 • POLISHED BRASS CARDED

5 1/4" SLIP FIT 5/8" WITH DIVERTER • ZINC TUB SPOUT WITH FRONT DIVERTER & SLIP 5/8" OD COPPER TUBE.



 TS133 10100 • CHROME

 TS133PBR 10117 • POLISHED BRASS

 TS133SN 10220 • SATIN NICKEL

 TS133ORB 10236 • OIL RUBBED BRONZE



TS133PBR



TS133BG

 TS133BG 10121 • BLACK GOLD

 CTS133 80082 • CHROME CARDED

 CTS133PBR 80083 • POLISHED BRASS CARDED

 CTS133SN 80206 • SATIN NICKEL CARDED

COLOR PART # UPC # DESCRIPTION
 TUB SPOUT DIVERTER REPAIR KIT • FITS THE TS133 AND TS134 ON PREVIOUS PAGES



	TS100RK	10149	• CHROME	
	TS100RKPBR	10233	• POLISHED BRASS	
	TS100RKSN	10267	• SATIN NICKEL	
	TS100RKORB	10266	• OIL RUBBED BRONZE	
	TS100RK1	10274	• WASHER ONLY	

5 1/4" SLIP FIT 5/8" WITH DIVERTER AND SHOWER CONNECTION • ZINC TUB SPOUT, FRONT DIVERTER, SLIP FIT, WITH HAND HELD SHOWER HOSE OUTLET.



	TS139	10216	• CHROME
--	-------	-------	----------

5 1/4" REAR MOUNT WITH DIVERTER • ZINC TUB SPOUT WITH DIVERTER, REAR MOUNT. 1/2" OR 3/4" IPS.



	TS136	10103	• CHROME
	TS136PBR	10115	• POLISHED BRASS
	TS136W	10116	• WHITE
	CTS136	80101	• CHROME CARDED
	CTS136PBR	80102	• POLISHED BRASS CARDED
	CTS136W	80103	• WHITE CARDED

5 1/4" SLIP FIT 5/8" WITH DIVERTER • ZINC TUB SPOUT WITH FRONT DIVERTER & SLIP 5/8" OD COPPER TUBE.



	TS135	10102	• CHROME
	CTS135	80099	• CHROME CARDED

COLOR PART # UPC # DESCRIPTION

5 1/4" REAR MOUNT WITH DIVERTER & BOTTOM SHOWER CONNECTION • ZINC TUB SPOUT REAR DIVERTER, REAR MOUNT 1/2 OR 3/4" IPS WITH BOTTOM OUTLET FOR PERSONAL SHOWER CONNECTION.



TS138 10105 • CHROME



CTS138 80111 • CHROME CARDED

5 1/4" REAR MOUNT WITH DIVERTER AND SHOWER OUTLET • ZINC TUB SPOUT WITH REAR DIVERTER MOUNT AND TOP OUTLET.



TS145 10156 • CHROME

5 1/4" **ALL BRASS** NOSE MOUNT 1/2 IPS • ALL BRASS TUB SPOUT WITH NOSE MOUNT 1/2" IPS.



TS157 10166 • CHROME

5 1/4" **ALL BRASS** NOSE MOUNT WITH DIVERTER • ALL BRASS TUB SPOUT WITH FRONT DIVERTER NOSE MOUNT.



TS154 10165 • CHROME

5 1/4" **ALL BRASS** REAR MOUNT WITH DIVERTER • ALL BRASS TUB SPOUT REAR DIVERTER AND MOUNT.



TS156 10180 • CHROME

COLOR PART # UPC # DESCRIPTION

5 1/4" MIXET® STYLE • ZINC TUB SPOUT WITH MIXET® STYLE MOUNT FOR 1/2 IN. NOMINAL COPPER PIPE (5/8 IN. OD) CONNECTIONS.

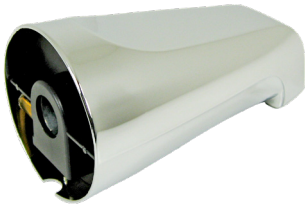

TS232

10232 • CHROME



CTS232

80175 • CHROME CARDED

5 1/4" MIXET® STYLE WITH DIVERTER • ZINC TUB SPOUT WITH FRONT DIVERTER (MIXET® STYLE 4) AND FOR USE ON 1/2 IN. NOMINAL COPPER PIPE (5/8 IN. OD) CONNECTIONS.

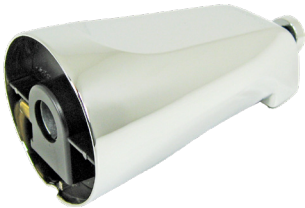

TS233

10234 • CHROME



TS233SN

10231 • SATIN NICKEL

5 1/4" TELESCOPING ADJUSTABLE REAR MOUNT • ZINC TUB SPOUT DIVERTER SPOUT REAR MOUNT TELESCOPING ADJUSTABLE FEATURE. ONE INCH OF TRAVEL.



TS174

10174 • CHROME



TS174SP

10228 • CHROME (SHORT ADAPTER)

5 1/4" TELESCOPING ADJUSTABLE REAR MOUNT • ZINC TUB SPOUT REAR MOUNT WITH TELESCOPING ADJUSTABLE FEATURE. ONE INCH OF TRAVEL.



TS177

10177 • CHROME



COLOR PART # UPC # DESCRIPTION

6" MODERN LUXURY SLIP FIT WITH DIVERTER • ZINC TUB SPOUT WITH LUXURY DESIGN, SLIP FIT 5/8" OD COPPER TUBE, AND FRONT DIVERTER.

 TS333 10262 • CHROME

7" NOSE MOUNT 1/2" IPS • ZINC TUB SPOUT WITH 1/2" IPS NOSE MOUNT.



 TS127 10197 • CHROME

 TS127PBR 10199 • POLISHED BRASS

 TS127PBRPVD 10198 • POLISHED BRASS PVD

 TS127SN 10225 • SATIN NICKEL

 TS127ORB 10260 • OIL RUBBED BRONZE

 CTS127 80225 • CHROME CARDED

 CTS127PBRPVD 80170 • POLISHED BRASS PVD CARDED

 CTS127SN 80143 • SATIN NICKEL CARDED

 CTS127ORB 80211 • OIL RUBBED BRONZE CARDED

7" NOSE MOUNT 1/2" IPS WITH DIVERTER • TUB SPOUT WITH FRONT DIVERTER 1/2" IPS NOSE MOUNT

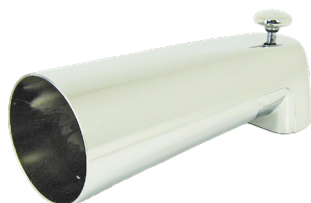

 TS124 10194 • CHROME

 TS124PBR 10196 • POLISHED BRASS

 TS124PBRPVD 10195 • POLISHED BRASS PVD

 TS124SN 10224 • SATIN NICKEL

 TS124ORB 10259 • OIL RUBBED BRONZE

 CTS124 80224 • CHROME CARDED

 CTS124PBRPVD 80169 • POLISH BRASS PVD CARDED

 CTS124SN 80142 • SATIN NICKEL CARDED

 CTS124ORB 80210 • OIL RUBBED BRONZE CARDED

COLOR PART # UPC # DESCRIPTION
 7" SLIP FIT • ZINC TUB SPOUT SLIP FIT 5/8" OD COPPER TUBE.



 TS122 10192 • CHROME

7" SLIP FIT FLUSH MOUNT • ZINC TUB SPOUT. SLIP FIT 5/8" OD COPPER PIPE, FLUSH MOUNT.



 TS122FM 10218 • CHROME

7" SLIP FIT WITH DIVERter • ZINC TUB SPOUT WITH FRONT DIVERter SLIP FIT 5/8" OD COPPER TUBE



 TS123 10193 • CHROME

7" FLUSH MOUNT SLIP FIT WITH DIVERter • ZINC TUB SPOUT 5/8" OD FLUSH MOUNT SLIP FIT WITH FRONT DIVERter.



 TS123FM 10217 • CHROME

COLOR PART # UPC # DESCRIPTION

ALL BRASS 8-1/2" LONG TUB SPOUT WITH REAR MOUNT.



 TS187 10168 • CHROME

 TS187PBRPVD 10179 • POLISHED BRASS PVD

 TS187SNPVD 10223 • SATIN NICKEL PVD

CHROME PLATED **ALL BRASS** 8-1/2" LONG TUB SPOUT WITH REAR DIVERTER & MOUNT



 TS186 10167 • CHROME

 TS186PBRPVD 10178 • POLISHED BRASS PVD

TUB SPOUT REDUCER BUSHING • TUB SPOUT REDUCER BUSHING, 1/2" TO 3/4"



TD3412BR 20035 • BRASS

1-4-ALL ASSEMBLY

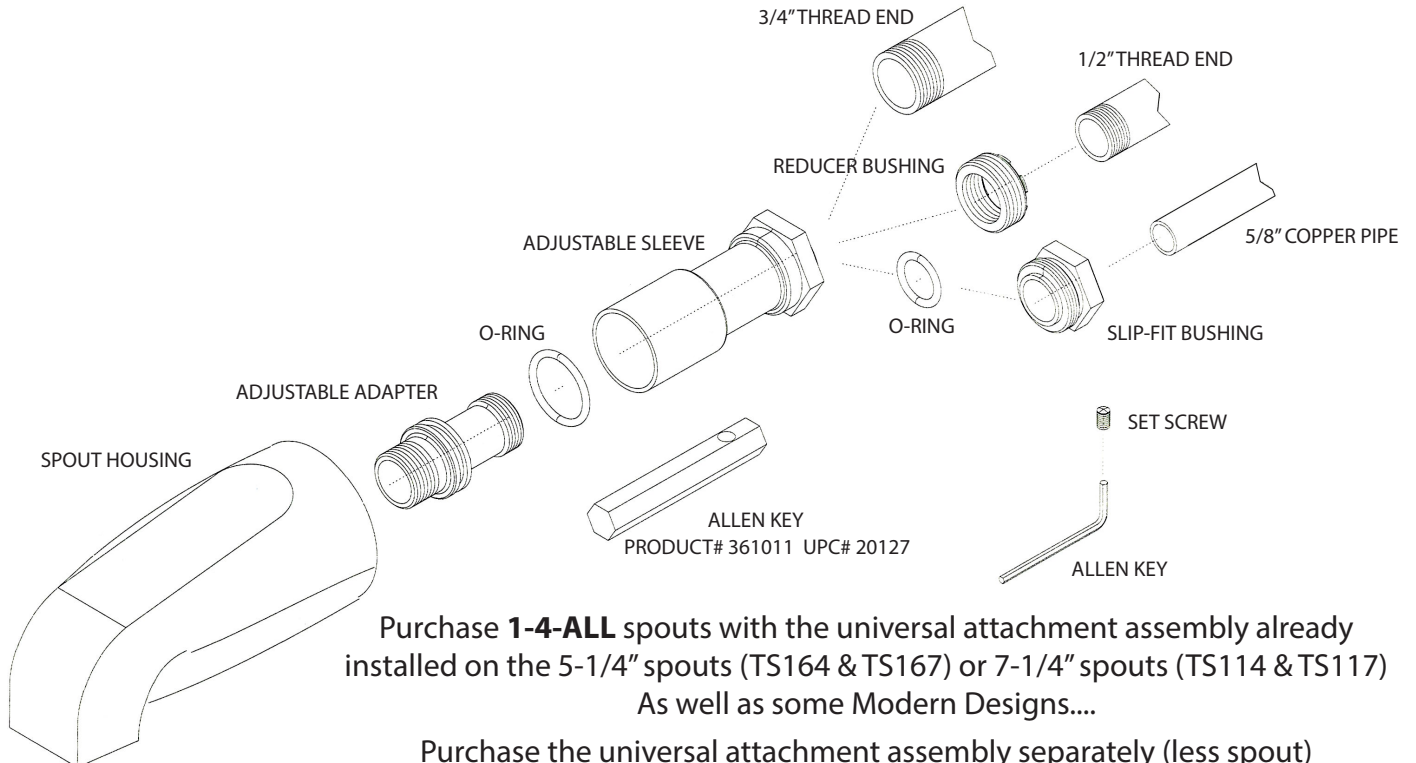

Purchase **1-4-ALL** spouts with the universal attachment assembly already installed on the 5-1/4" spouts (TS164 & TS167) or 7-1/4" spouts (TS114 & TS117) As well as some Modern Designs....

Purchase the universal attachment assembly separately (less spout) Product #S1400 (5-1/4") or #S1407 (7-1/4")

COLOR PART # UPC # DESCRIPTION
 5 1/4" 1-4-ALL • ZINC TUB SPOUT WITH 1-4-ALL UNIVERSAL FIT / ADJUSTABLE ASSEMBLY.



COLOR	PART #	UPC #	DESCRIPTION
	TS167	10169	• CHROME
	TS167PBR	10170	• POLISHED BRASS
	TS167PBRPVD	14132	• POLISHED BRASS PVD
	TS167SN	14128	• SATIN NICKEL
	TS167ORB	14135	• OIL RUBBED BRONZE
	TS167MB	14234	• MATTE BLACK
	TS167W	10171	• WHITE
	CTS167	80121	• CHROME CARDED
	CTS167PBR	80122	• POLISHED BRASS CARDED
	CTS167PBRPVD	80123	• POLISHED BRASS PVD CARDED
	CTS167SN	80127	• SATIN NICKEL CARDED
	CTS167ORB	80069	• OIL RUBBED BRONZE CARDED
	CTS167MB	80260	• MATTE BLACK CARDED
	CTS167W	80124	• WHITE CARDED

DON'T FORGET
 1-4-ALL HEX WRENCH
 1/2" X 2-1/2" L



361011
 20127

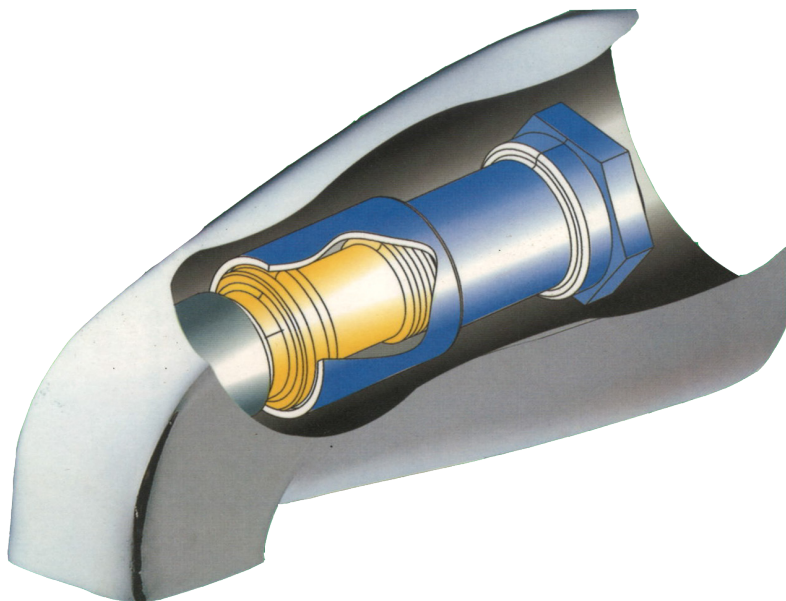

1-4-ALL ASSEMBLY

Fully universal and adjustable
 for various nipple lengths

Fits 1/2" or 3/4" pipe nipple
 and slip-fit on 5/8" tube

Designed to be error free on
 installation leaking problem

Simple and easy to install

COLOR	PART #	UPC #	DESCRIPTION
5 1/4" 1-4-ALL WITH DIVERTER • ZINC TUB SPOUT WITH FRONT DIVERTER, AND 1-4-ALL UNIVERSAL FIT / ADJUSTABLE ASSEMBLY.			
	TS164	10158	• CHROME
	TS164PBR	10159	• POLISHED BRASS
	TS164PBRPVD	14133	• POLISHED BRASS PVD
	TS164SN	14129	• SATIN NICKEL
	TS164ORB	14134	• OIL RUBBED BRONZE
	TS164MB	14233	• MATTE BLACK
	CTS164	80112	• CHROME CARDED
	CTS164PBR	80113	• POLISHED BRASS CARDED
	CTS164PBRPVD	80114	• POLISHED BRASS PVD CARDED
	CTS164SN	80120	• SATIN NICKEL CARDED
	CTS164ORB	80089	• OIL RUBBED BRONZE CARDED
	CTS164MB	80259	• MATTE BLACK CARDED



REMEMBER...

1-4-ALL HEX WRENCH
1/2" X 2-1/2" L



361011
20127



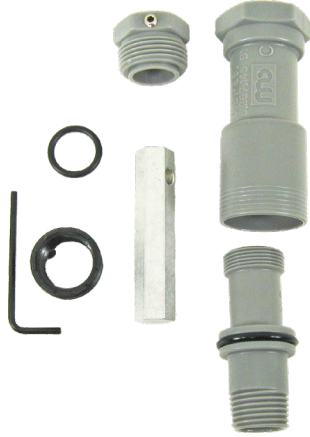

COLOR	PART #	UPC #	DESCRIPTION
			TUB SPOUT 1-4-ALL KIT • 1-4-ALL UNIVERSAL TUB SPOUT ATTACHMENT KIT FOR 5" NOSE MOUNT SPOUTS. FITS TS134 & TS137
	S1400	10190	• KIT THAT FITS TS134 & TS137
	CS1400	80202	• S1400 PACKED IN CLAMSHELL
	361011	20127	• 1-4-ALL HEX WRENCH 1/2" X 2-1/2" L



6" MODERN LUXURY **1-4-ALL** • ZINC TUB SPOUT WITH 1-4-ALL UNIVERSAL FIT.

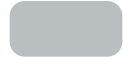

TS467	10269	• CHROME
361011	20127	• 1-4-ALL HEX WRENCH 1/2" X 2-1/2" L



6" MODERN LUXURY **1-4-ALL** WITH DIVERTER • ZINC MODERN LUXURY TUB SPOUT WITH FRONT DIVERTER AND 1-4-ALL UNIVERSAL FIT.

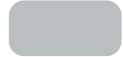

TS464	10268	• CHROME
361011	20127	• 1-4-ALL HEX WRENCH 1/2" X 2-1/2" L



1-4-ALL PARTS • A FEW OF THE PARTS IN OUR 1-4-ALL KIT. THESE ARE THE ONLY ITEMS WE SELL ON THEIR OWN. IF YOU ARE LOOKING FOR THE KITS, CHECK OUT S1400 - 10190 AND S1407 - 14107



TS3412	20121	• REDUCER BUSHING
361010	20126	• 3/32 ALLEN KEY

COLOR PART # UPC # DESCRIPTION

7" ZINC TUB SPOUT, **1-4-ALL** UNIVERSAL FIT.



TS117 14123 • CHROME



TS117PVD 14125 • POLISHED BRASS



TS117SN 10226 • SATIN NICKEL



TS117ORB 14127 • OIL RUBBED BRONZE



CTS117ORB 80213 • OIL RUBBED BRONZE CARDED

361011 20127 • 1-4-ALL HEX WRENCH 1/2" X 2-1/2" L



7" ZINC DIVERTER TUB SPOUT **1-4-ALL** UNIVERSAL FIT.



TS114 14120 • CHROME



TS114PBR 14121 • POLISHED BRASS



TS114PBRPVD 14122 • POLISHED BRASS PVD



TS114SN 10227 • SATIN NICKEL



TS114ORB 14126 • OIL RUBBED BRONZE



CTS114ORB 80212 • OIL RUBBED BRONZE CARDED

361011 20127 • 1-4-ALL HEX WRENCH 1/2" X 2-1/2" L



TUB SPOUT **1-4-ALL** KIT • 1-4-ALL UNIVERSAL TUB SPOUT ATTACHMENT KIT FOR 7" NOSE MOUNT SPOUTS. FITS TS124 & TS127

S1407 14107 KIT THAT FITS TS124 & TS127

CS1407 80203 • S1407 PACKED IN CLAMSHELL

361011 20127 • 1-4-ALL HEX WRENCH 1/2" X 2-1/2" L



COLOR PART # UPC # DESCRIPTION

Provides water leak protection
between the spout plate and wall

And around the pipe
protruding from the wall



Covers unsightly stains or marks
from prior installation

Quick and easy to install



GAP PROBLEM?

OR

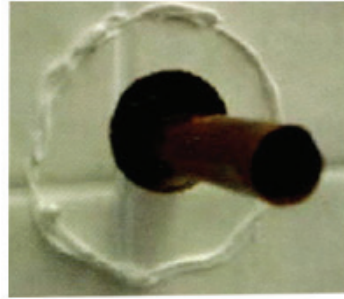

BEFORE PLATE

AND



PROBLEM SOLVED!















ONE PLATE FITS ALL THESE TUB SPOUT APPLICATIONS





FIVE DIFFERENT
FINISH OPTIONS
BELOW

TUB SPOUT TRIM PLATE WITH WATER SEAL • TUB SPOUT TRIM PLATE / ESCUTCHEON WITH WATER SEAL

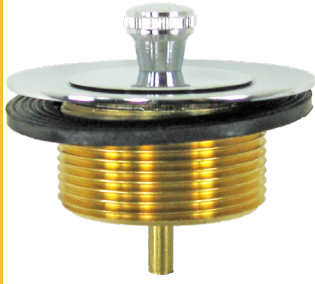

	SS150	14021 • CHROME
	SS150PBRPVD	14022 • POLISHED BRASS PVD
	SS150SNPVD	14023 • SATIN NICKEL PVD
	SS150ORB	14024 • OIL RUBBED BRONZE
	SS150MB	14307 • MATTE BLACK
	SS130	14018 • CHROME NO WATER SEAL
	CSS150	80054 • CHROME CARDED
	CSS150PBRPVD	80055 • POLISHED BRASS CARDED
	CSS150SNPVD	80056 • SATIN NICKEL CARDED
	CSS150ORB	80059 • OIL RUBBED BRONZE
	CSS150MB	80256 • MATTE BLACK CARDED
	CSS130	80057 • CHROME NO WATER SEAL CARDED



COLOR	PART #	UPC #	DESCRIPTION
ALL BRASS LIFT & TURN TUB DRAIN. 1-1/4" (FINE THREAD) AND 1-1/2" (COARSE THREAD). UNIT COMES WITH CONVERSION BUSHING.			
	TD3812	10185	• CHROME
	TD2512PBRPVD	10201	• POLISHED BRASS PVD
	TD2512SNPVD	10200	• SATIN NICKEL PVD
	TD2512ORB	14054	• OIL RUBBED BRONZE
	TD2512MB	14306	• MATTE BLACK

LIFT & TURN STOPPER WITH 3/8" THREAD.



	TD25121SNPVD	10213	• SATIN NICEKL STOPPER ONLY WITH 3/8" THREAD
---	--------------	-------	--

ALL BRASS LIFT & TURN TUB DRAIN. 1-1/4" (FINE THREAD) NO BUSHING.



	TD2500	10188	• CHROME
---	--------	-------	----------

ALL BRASS LIFT & TURN TUB DRAIN. 1-1/2" (COARSE THREAD) NO BUSHING



	TD5000	10189	• CHROME
---	--------	-------	----------

COLOR PART # UPC # DESCRIPTION

ALL BRASS BODY PUSH & LOCK TUB DRAIN. FINE 1-1/4" THREAD

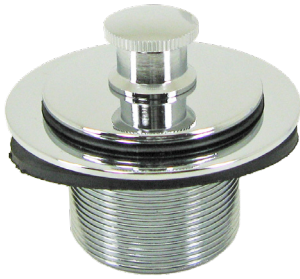

 TD2505 10184 • CHROME

ALL BRASS BODY PUSH & LOCK TUB DRAIN. COARSE 1-1/2" THREADS



 TD5005 10191 • CHROME

 TD5005SN 10239 • SATIN NICKEL

ALL BRASS BODY PUSH & LOCK TUB DRAIN. STOPPER ONLY WITH 3/8" THREAD



 TD25051 10204 • CHROME

 TD25051SNPVD 10235 • SATIN NICKEL

ALL BRASS BODY PUSH & LOCK TUB DRAIN. WIDE STOPPER ONLY WITH DUEL THREADED POST FITS 3/8" AND 1/4"



 TD25401 10275 • CHROME

 CTD25401 80200 • CHROME CARDED

COLOR PART # UPC # DESCRIPTION

POST CONVERTS STOPPERS TO 1/4" THREAD

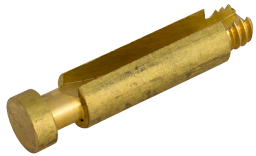

TD25005 10209 • FOR LIFT AND TURN



TD25055 10214 • FOR PUSH AND LOCK

RUBBER SEAT WASHER FOR LIFT AND TURN AND PUSH AND LOCK



TD38121 10186 • FOR BOTH LIFT AND TURN DRAINS & PUSH AND LOCK DRAINS, O.D.: 2-11/16" • I.D.: 1-11/16"

CHROME PLATED BRASS BODY ROTATING SWIVEL TUB DRAIN STOPPER 1-1/4" FINE THREAD & 1-1/2" COARSE THREAD BRASS BUSHING.



TD6812 10205 • CHROME



TD6812SC 10281 • SUCTION CUP STOPPER REMOVAL TOOL



CHROME PLATED BRASS CLICKER TUB DRAIN WITH PLASTIC TIP-TOE STOPPER. INCLUDES PLASTIC CONVERSION BUSHING 1-1/4" FINE THREAD AND 1-1/2" COARSE THREAD.



TD1500 10138 • CHROME

COLOR PART # UPC # DESCRIPTION

CONVERSION KIT WITH TOP-TOE DRAIN • KIT COMES WITH TIP-TOE TUB DRAIN, PLASTIC CONVERSION BUSHING, AND SINGLE HOLE FACE PLATE WITH HARDWARE. ALL PACKAGED IN BLISTER CLAMSHELL WITH PRODUCT CARD.



CTD2900 80131 • CHROME

CONVERSION KIT WITH LIFT & TURN DRAIN • KIT COMES WITH BRASS LIFT & TURN TUB DRAIN, BRASS CONVERSION BUSHING, AND SINGLE HOLE FACE PLATE WITH HARDWARE. PACKAGED IN BLISTER CLAMSHELL WITH PRODUCT CARD.



CTD3000 80128 • CHROME CARDED



CTD3000PBRPVD 80129 • POLISHED BRASS PVD CARDED



CTD3000SN 80130 • SATIN NICKEL CARDED



CTD3000ORB 80136 • OIL RUBBED BRONZE CARDED



CTD3000MB 80248 • MATTE BLACK CARDED

CONVERSION KIT WITH LIFT & TURN DRAIN • KIT COMES WITH BRASS LIFT & TURN TUB DRAIN, BRASS CONVERSION BUSHING, AND TWO HOLE FACE PLATE WITH HARDWARE. PACKAGED IN BLISTER CLAMSHELL WITH PRODUCT CARD.



CTD3200 80132 • CHROME CARDED



CTD3200PBRPVD 80133 • POLISHED BRASS PVD CARDED



CTD3200SNPVD 80134 • SATIN NICKEL CARDED



CTD3200ORB 80137 • OIL RUBBED BRONZE CARDED



CTD3200MB 80249 • MATTE BLACK CARDED

CONVERSION KIT WITH PUSH & LOCK DRAIN • KIT COMES WITH CHROME PLATED BRASS PUSH & LOCK TUB DRAIN, BRASS CONVERSION BUSHING, AND SINGLE HOLE FACE PLATE WITH HARDWARE. PACKAGED IN BLISTER CLAMSHELL WITH PRODUCT CARD..



CTD4000 80135 • CHROME

COLOR PART # UPC # DESCRIPTION
 TUB DRAIN BRASS BUSHING CONVERTS TUB DRAIN FROM, 1-1/4" FINE THREAD TO 1-1/2" COARSE
 THREAD.



TD1000 10187 • 1-1/4" FINE TO 1-1/2" COARSE

TUB DRAIN BRASS BUSHING CONVERTS TUB DRAIN FROM, 1-1/2" COARSE THREAD TO 2" FINE THREAD.



TD2000 14020 • FOR BOTH LIFT AND TURN DRAINS

RUBBER FEATHER EDGED STOPPER SEAL WASHER FOR TD-1500



TD15001 20024 • 1-1/2" COARSE THREAD TO 2" FINE THREAD

CHROME PLATED TUB OVERFLOW FACEPLATE WITH 2 HOLES AND SQUARE DESIGN TRIP LEVER
 (INCLUDES 2 MATCHING BRASS SCREWS)

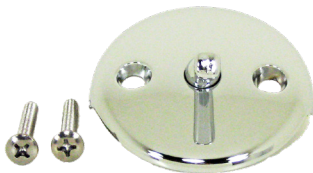

FP140 10139 • CHROME



CFP140 80060 • CHROME CARDED

COLOR PART # UPC # DESCRIPTION
 TUB OVERFLOW FACEPLATE WITH 2 HOLES & TRIP LEVER (INCLUDES 2 MATCHING BRASS SCREWS)

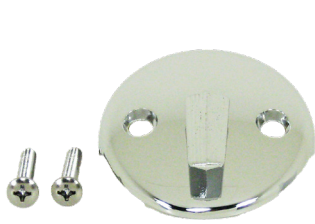

	FP141	10110	• CHROME
	FP141PBR	10111	• POLISHED BRASS
	FP141SN	10208	• SATIN NICKEL
	FP141W	10112	• WHITE
	FP141G	10125	• GOLD
	FP141WG	10141	• WHITE AND GOLD
	FP141BG	10126	• BLACK AND GOLD
	FP141CG	10140	• CHROME AND GOLD
	CFP141	80061	• CHROME CARDED
	CFP141PBR	80062	• POLISHED BRASS CARDED
	CFP141W	80063	• WHITE CARDED
	CFP141WG	80065	• WHITE AND GOLD CARDED

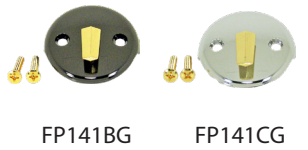

TUB OVERFLOW FACEPLATE WITH 2 HOLES (INCLUDES 2 MATCHING BRASS SCREWS)



	FP142	10154	• CHROME
	FP142PBR	11150	• POLISHED BRASS
	FP142SN	10202	• SATIN NICKEL
	FP142ORB	14055	• OIL RUBBED BRONZE
	FP142MB	14302	• MATTE BLACK
	CFP142	80070	• CHROME CARDED
	CFP142PBR	80071	• POLISHED BRASS CARDED
	CFP142SN	80072	• SATIN NICKEL CARDED
	CFP142MB	80252	• MATTE BLACK CARDED

COLOR PART # UPC # DESCRIPTION







TUB OVERFLOW FACEPLATE WITH 1 HOLE (INCLUDES A MATCHING BRASS SCREW)



	FP143	10155	• CHROME
	FP143PBR	11151	• POLISHED BRASS
	FP143SN	10203	• SATIN NICKEL
	FP143ORB	14056	• OIL RUBBED BRONZE
	FP143MB	14303	• MATTE BLACK
	CFP143	80073	• CHROME CARDED
	CFP143PBR	80074	• POLISHED BRASS CARDED
	CFP143SN	80075	• SATIN NICKEL CARDED
	CFP143MB	80253	• MATTE BLACK CARDED

SOLID BRASS SCREWS FOR TUB OVERFLOW FACEPLATE. 1/4-20 WITH PHILLIPS HEAD.



	FP1413	20029	• CHROME 2"
	FP1413PBR	20045	• POLISHED BRASS 2"
	FP1413SN	20043	• SATIN NICKEL 2"
	FP1413ORB	20044	• OIL RUBBED 2"
	FP1412W	20200	• WHITE 2"
	FP1412	20022	• CHROME 1-3/4"
	FP1412PBR	20025	• POLISHED BRASS 1-3/4"
	FP1412ORB	20032	• OIL RUBBED BRONZE 1-3/4"

ALUMINUM BRACKET • CONVERTS BATHROOM TUB FACEPLATE FROM TWO HOLE TO ONE HOLE.



TD30001	20030	• CONVERSION BRACKET
---------	-------	----------------------

KITCHEN and ACCESSORIES



SECTION 4





COLOR PART # UPC # DESCRIPTION
 CHROME PLATED **ALL BRASS** DUPLEX STRAINER ASSEMBLY.



SA103 12163 • CHROME



SA104 12164 • STAINLESS STEEL



SA1041 12165 • BASKET ONLY



POLISHED STAINLESS STEEL DUPLEX STRAINER ASSEMBLY WITH FLANGE STRAINER & NUTS.



SA106 12166 • STAINLESS STEEL

POLISHED STAINLESS STEEL DRAIN, WITH DOME GRID STRAINER. 1 1/2" COARSE THREAD.



SA109 12169 • STAINLESS STEEL

ALL BRASS GRID DRAIN ASSEMBLY FOR KITCHEN SINK. 1-1/4" FINE THREAD.



SA113 12167 • CHROME

COLOR PART # UPC # DESCRIPTION

ALL STAINLESS STEEL KITCHEN STRAINER ASSEMBLY. FITS 3-1/2" TO 4" OPENING.



SA151 12171 • STAINLESS STEEL



SA1512 12172 • STAINLESS STEEL BASKET ONLY



POLISHED STAINLESS STEEL KITCHEN SINK STRAINER ASSEMBLY WITH DEEP CUP BASKET, POST, GASKET & NUTS.



SA160 12176 • STAINLESS STEEL

POLISHED STAINLESS STEEL MODERN 'SPIN & SEAL' KITCHEN SINK STRAINER ASSEMBLY.



SA171 12178 • CHROME

STAINLESS STEEL BASKET STRAINER WITH DIE-CAST SLIP JOINT NUT.



SA172 12179 • STAINLESS STEEL

CHROME PLATED BRASS BODY HEAVY INDUSTRIAL GAUGE KITCHEN SINK STRAINER.



SA250 12174 • CHROME

COLOR PART # UPC # DESCRIPTION

CHROME PLATED 4-1/2"D **ALL BRASS** KITCHEN STRAINER ASSEMBLY.



SA275 12180 • CHROME



SA2751 12181 • BASKET ONLY WITH RUBBER STOPPER



SA2751B 12182 • BASKET ONLY WITH **SOLID BRASS** CHROME PLATED STOPPER



HOLLOW STOPPERS WITH RING. MULTIPLE DIAMETERS AVAILABLE.



S81 20102 • 1-1/8" WITH RING

S82 20048 • 1-1/4" WITH RING

S83 20105 • 1-3/8" WITH RING

S84 20106 • 1-1/4" WITH RING

COUNTER TOP RINSE & SPRAY HEADS. HOSES ALSO SOLD INDIVIDUALLY.



RS333 12190 • CHROME



RS300W 12152 • WHITE



RS330W 12160 • WHITE WITH HOSE



RS300 12150 • BLACK



RS330 12158 • BLACK WITH HOSE



RS300A 12151 • ALMOND



KITCHEN SINK SPRAY HEAD FOR PULL OUT FAUCET. (1.8 GPM)



ET53104 12115 • CHROME



ET53104SN 12119 • SATIN NICKEL



ET53103 12114 • WHITE



ET53101 12109 • WHITE WITH BLACK



CET53104 80167 • CHROME CARDED



CET53104SN 80217 • SATIN NICKEL CARDED

COLOR PART # UPC # DESCRIPTION

COUNTER TOP KITCHEN SINK RINSE SPRAY HOSE WITH BRASS ADAPTER AND CLEAR VINYL HOSE.



RS320 12156 • CLEAR

RS3202 12161 • WASHERS KIT



COUNTER TOP RINSE & SPRAY ATTACHMENT KIT FOR KITCHEN SINK PULL OUT ASSEMBLY
TWO RUBBER WASHERS AND ONE SPRING CLIP

KITCHEN SINK FAUCET PULL OUT HOSE. ADAPTER KIT INCLUDES THREE SIZE ADAPTERS, FIBER WASHERS AND RUBBER O-RINGS. **SPRAY HEADS SOLD SEPARATELY.**



ET53102 12110 • HOSE ONLY

ET53102K 12116 • ADAPTER KIT ONLY

ET531022 12122 • HOSE & ADAPTER KIT

COUNTER TOP PULL-OUT SPRAY HOSE GUIDE ASSEMBLY WITH STAINLESS STEEL TRIM.



RS310 12153 • BLACK



RS310W 12155 • WHITE



RS310A 12154 • ALMOND



RS340 12191 • CHROME FOR RS333

AIR GAP CAP.



AG81C 12112 • CHROME

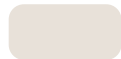

AG81W 12105 • WHITE



AG81A 12106 • ALMOND



COLOR PART # UPC # DESCRIPTION

COUNTER TOP AERATOR DISPLAY • 9 TUBES, 6 PER TUBE.
DUAL THREAD MALE 15/16" X 27 & FEMALE 55/64" X 27.

 FA200D1.2 12078 • 1.2 GPM, CHROME

 FA200D 12102 • 2.2 GPM, CHROME

DISPLAY DESIGN MAY VARY

FAUCET AERATORS • DUAL THREAD MALE 15/16" X 27 AND FEMALE 55/64" X 27.



 FA200T12 12123 • 1.2 GPM, CHROME TUBE OF 6

 FA200T15 12073 • 1.5 GPM, CHROME TUBE OF 6

 FA200T22 12101 • 2.2 GPM, CHROME TUBE OF 6



 FA20012PBRPVD 12117 • 1.2 GPM, POLISHED BRASS SINGLE

FAUCET AERATORS • THREAD FEMALE, 13/16" X 24 (FITS CHICAGO FAUCETS).



 FA22012 12056 • 1.2 GPM, CHROME SINGLE

 FA22022 12054 • 2.2 GPM, CHROME SINGLE

DRINKING WATER GLASS FILLER FAUCET SPOUT FOR COMMERCIAL / MEDICAL USE



 BF157 14141 • CHROME 6"

 BF159 14143 • CHROME 8"

TOOLS

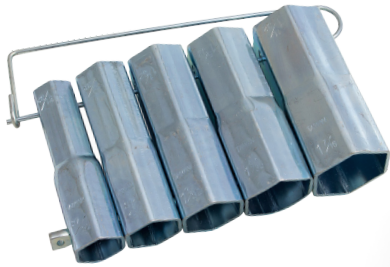

SECTION 5



COLOR PART # UPC # DESCRIPTION
 FAUCET SEAT WRENCHES IN DIFFERENT STYLES. HEX AND SQUARE ENDS FIT MOST FAUCET SEATS.



SW1016 12003 • TAPERED L SHAPE

SW1015 12002 • STEPPED L SHAPE



SW1017 12009 • TAPERED STRAIGHT • SQUARE SHAFT, USE WITH WRENCH



LARGE ADJUSTABLE SPUD WRENCH. STEEL CONSTRUCTION WITH RUBBER GRIP.



SW109B 10296 • SPUD WRENCH

TELESCOPIC ADJUSTABLE BASIN WRENCH (SHANK ADJUSTS FROM 10"-17" AND JAW CAPACITY 1-1/4" AND 2")



BW1003 12004 • 1.25" JAW CAPACITY

BW1004 12024 • 2" JAW CAPACITY

P.O. PLUG WRENCH. MALLEABLE IRON KEEPS P.O. PLUG AND BASKET STRAIGHT AND IN PLACE DURING INSTALLATION.



PW70 12014 • PLUG WRENCH

COLOR PART # UPC # DESCRIPTION

GARBAGE DISPOSAL WRENCH



DW1037 12148 • DISPOSAL WRENCH

WRENCH FOR STRAINER NUT OR SPANNER



SW1038 12015 • STRAINER NUT WRENCH

STRAINER WRENCH



SW1040 12011 • STRAINER WRENCH

BASKET AND TUB STRAINER WRENCH PACKAGED IN BLISTER CLAMSHELL WITH PRODUCT LABEL OR BULK PACKAGED NO CLAMSHELL, NO LABEL.



SW1044 12088 • PACKED IN CLAMSHELL

SW1044BULK 12048 • BULK UNPACKAGED

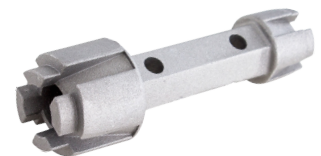

COLOR	PART #	UPC #	DESCRIPTION
-------	--------	-------	-------------

SOCKET WRENCH SET WITH 10 SIZES • SINGLE SOCKETS AVAILABLE
 21/32", 27/32", 29/32", 31/32", 1-1/32", 1-3/32", 1-5/32", 1-9/32", 1-11/32", 1-7/16"



	SW1035	12010	• 10 PIECE SET
	SW10351	12141	• SINGLE SOCKET 21/32" & 27/32"
	SW10352	12018	• SINGLE SOCKET 29/32" & 31/32" (MOST POPULAR)
	SW10353	12142	• SINGLE SOCKET 1-1/32" & 1-3/32"
	SW10354	12143	• SINGLE SOCKET 1-5/32" & 1-9/32"
	SW10355	12144	• SINGLE SOCKET 1-11/32" & 1-7/16"

SOCKET WRENCH 21/32" AND 27/32" (MINI JACO FITTING SOCKET WRENCH)



	SW1057	12097	• SINGLE SOCKET WRENCH
--	--------	-------	------------------------

IMPACT FAUCET & VALVE HANDLE PULLER



	HP1043	12012	• HANDLE PULLER
--	--------	-------	-----------------

FAUCET & VALVE HANDLE PULLER



	HP1045	12087	• HANDLE PULLER
--	--------	-------	-----------------

PVC PIPE CUTTER ALUMINUM CONSTRUCTION (CUTS 1/2" TO 1-1/4" OD).



	CP42	12001	• PIPE CUTTER
--	------	-------	---------------

	CP421	12005	• REPLACEMENT BLADES
--	-------	-------	----------------------



COLOR PART # UPC # DESCRIPTION



PROFESSIONAL HEAVY DUTY PIPE CUTTER. CUTS PVC PIPE 3-45MM ALUMINUM BODY.
 CP45 12089 • PIPE CUTTER



PVC PIPE CUTTER WITH ALUMINUM BODY AND HIGH CARBON STEEL BLADE. EASY SINGLE HAND OPERATION (1/4" TO 2-1/2").

CP63A 12076 • PIPE CUTTER

CP63A1 12077 • REPLACEMENT BLADE



PVC PIPE CUTTER WITH ALUMINUM BODY AND HIGH CARBON STEEL BLADE. CUTS UP TO 2" SCHEDULE 40 PVC. TWO HAND OPERATION (1/2" TO 2-1/2" OD).

CP65 12065 • PIPE CUTTER

CP501 12039 • REPLACEMENT BLADE



HEAVY DUTY WIRE CABLE CUTTER. FOR COPPER AND ALUMINUM ONLY. CUTS UP TO 3/4" DIAMETER. HEAT TREATED CUTTING EDGE.

CC1128 12023 • CABLE CUTTERS

COLOR PART # UPC # DESCRIPTION
 HEAVY DUTY HOSE CUTTER.



HC32 12021 • HOSE CUTTER

TIN SNIPS • TIN SHEET CUTTER. HEAT TREATED CUTTING EDGE. CONVENIENT SWING AWAY SPRING
 ALLOWS FOR COMPACT STORAGE.



TC1127 12022 • TIN SHEET CUTTERS

MINI TUBE CUTTER 1/8" TO 5/8" OD WITH ROLLERS.



TC1021 12017 • MINI TUBE CUTTER

METAL PIPE CUTTER 1/8" TO 1-1/8" DIAMETER CAPACITY FOR COPPER, BRASS, ALUMINUM, AND
 THIN-WALL CONDUIT TUBING WITH ADJUSTABLE TELESCOPING FEATURE.



TC1025 12008 • PIPE CUTTER

COLOR PART # UPC # DESCRIPTION
 QUICK RELEASE TUBING CUTTER WITH ALUMINUM BODY AND CARBON STEEL BLADE, 1' CAPACITY.



TC22 12093 • PIPE CUTTER

PIPE & TUBE CUTTER BY MAXCLAW 1/8" TO 1-1/4" DIAMETER CAPACITY WITH ATTACHED DEBURRING TOOL.



TC220 12028 • PIPE CUTTER

TC2202 12034 • REPLACEMENT DEBURRING BLADE



AUTOMATIC PIPE CUTTER FOR 1/2" (15MM) **OR** 3/4" (22MM) OD TUBE.



TC50 12090 • FOR 1/2" OD PIPE

TC75 12091 • FOR 3/4" OD PIPE

TUBING CUTTER, 2 IN ONE SPRING LOADED MECHANISM, 1/4' - 1 1/8'



TCR155 12084 • TUBING CUTTER

TCR1551 12085 • REPLACEMENT BLADE





COLOR **PART #** **UPC #** **DESCRIPTION**

INSIDE PLASTIC PIPE CUTTER • HEAT TREATED STEEL BLADE WITH ZINC PLATED HEX SHANK DRILL BIT PACKAGED IN BLISTER CLAMSHELL AND PRODUCT CARD. REPLACEMENT BLADES PACKAGED INDIVIDUALLY IN RESEALABLE BAGS. BULK OPTIONS DO NOT INCLUDE PACKAGING.

PC100 12029 • PIPE CUTTER PACKED IN BLISTER AND CARD

PC100BULK 20026 • PIPE CUTTERS BULK LOOSE PACKAGED



PC100B 12030 • REPLACEMENT BLADE INDIVIDUALLY PACKED & LABELED

PC100BBULK 20027 • REPLACEMENT BLADES BULK (QUANTITIES 50+)

DT300



DE-BURRING TOOL WITH REPLACEMENT BLADE, PLASTIC OR ALUMINUM BODY.

DT300 12031 • DEBURRING TOOL ALUMINUM CONSTRUCTION

DT100 12032 • DEBURRING TOOL PLASTIC CONSTRUCTION



DT1001PB 12062 • REPLACEMENT BLADES 5 PACK

DT1001 12035 • REPLACEMENT BLADES BULK (QUANTITIES OF 50+)



JAWS WRENCH • 10" LONG POWER JAWS WRENCH WITH 1-1/2" JAW CAPACITY.

J1010 12025 • JAWS



CURVED JAW PLIERS. DESIGNED FOR HARD TO HOLD AND DELICATE FINISH SURFACES. INCLUDES PROTECTIVE COVERS FOR THE JAWS.

PP20 12020 • PIPE PLIERS



COLOR PART # UPC # DESCRIPTION
 WATER PUMP PLIERS WITH NON-MAR JAWS.

PP624 12027 • PLIERS

P6241 12041 • REPLACEMENT JAWS

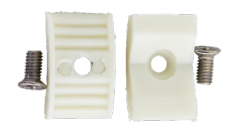

DELUXE FLARING TOOL.

FT100 12007 • FLARING TOOL



HASSLE-FREE PROFESSIONAL COMPRESSION SLEEVE PULLER.

CSP103 12081 • COMPRESSION SLEEVE PULLER



CARTRIDGE PULLER (CAN BE USED ON MOEN CARTRIDGES).

MCP110 12043 • CARTRIDGE PULLER



MOEN CARTRIDGE PULLER.

MCP120 12086 • MOEN CARTRIDGE PULLER

COLOR PART # UPC # DESCRIPTION

NIPPLE EXTRACTOR SET WITH POUCH.
TOTAL OF 6 NIPPLES: 1/8" - 1/4" - 3/8" - 1/2" - 5/8" - 3/4"



NE167 12044 • NIPPLE EXTRACTORS SET OF 6

SPUD CHUCK (NIPPLE EXTRACTOR) WITH 1" TO 2" CAPACITY. EXPANDS WITH ECCENTRIC ACTION OF TWIN JAWS WITH KNURLED GRIPPING FACES.



SC102 12094 • SPUD CHUCK

4-IN-1 HARDENED STEEL SILL COCK KEY. FITS MOST SILL COCKS.



SK41 12013 • SILL COCK KEY

HYDRANT KEY • HYDRANT KEY 8MM OR 5/16" AND 10 MM OR 13/32" SQUARE BROACH (FITS ZURN UNIT)



HK02 12042 • HYDRANT KEY

AERATOR KEY • UNIVERSAL AERATOR KEY FITS 13 SIZES

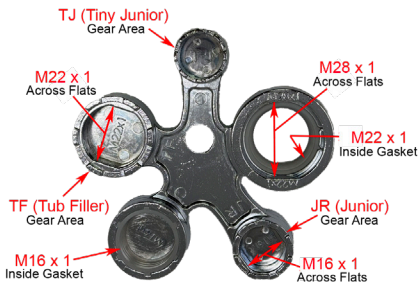

AK13 12055 • AERATOR KEY

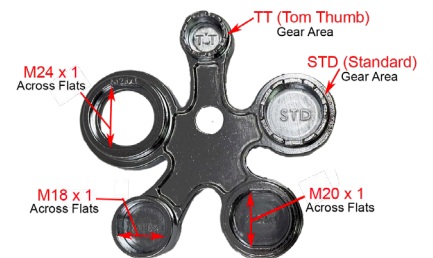

VARIOUS ITEMS



SECTION 6



COLOR PART # UPC # DESCRIPTION

UNIVERSAL FIT TOILET TANK LEVER PACKAGED IN CLEAR POLY BAG.



TL8 12100 • CHROME



TL8PBR 12108 • POLISHED BRASS



TL8S 20109 • CHROME SLEEK DESIGN



SOLID BRASS VACUUM BREAKER FOR OUTDOOR GARDEN HOSE BIBB.



VB125 12058 • VACUUM BREAKER

BIBB CHEST OF BEVELED RUBBER FAUCET WASHERS IN VARIOUS SIZES, BLACK OR COLORED.
WK190B IS MADE FROM BUNA-N (NITRILE), AN FDA APPROVED MATERIAL.

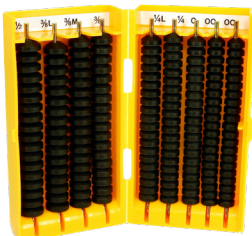

WK200B 12052 • BEVELED

WK190B 12050 • BEVELED NITRILE (FDA APPROVED MATERIAL)

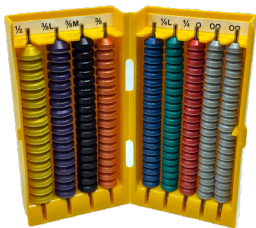

WK200BCL 12074 • COLORED BEVELED



COLOR PART # UPC # DESCRIPTION

BIBB CHEST OF FLAT RUBBER FAUCET WASHERS IN VARIOUS SIZES, BLACK OR COLORED.
WK350F IS MADE FROM BUNA-N (NITRILE), AN FDA APPROVED MATERIAL.



WK400F	12075	• FLAT
WK350F	12051	• FLAT NITRILE (FDA APPROVED MATERIAL)
WK400FCL	12053	• COLORED FLAT

FLAT FAUCET WASHERS • 00 TRADE SIZE THROUGH 1/2"
 MADE FROM FDA GRADE NITRILE (BUNA-N / NBR) PACKAGED IN RESEALABLE
 BAG OF 50 OR 100 WITH PRODUCT LABEL. (BULK OPTIONS AVAILABLE UPON REQUEST)



FW2908100	10308	• 00 TRADE SIZE 100 PACK
FW2909100	10309	• 0 TRADE SIZE 100 PACK
FW2910100	10310	• 1/4" 100 PACK
FW2911100	10311	• 1/4L TRADE SIZE 100 PACK
FW2912100	10312	• 3/8" 100 PACK
FW291350	10313	• 3/8M TRADE SIZE 50 PACK
FW291450	10314	• 3/8L TRADE SIZE 50 PACK
FW291550	10315	• 1/2" 50 PACK

BEVELED FAUCET WASHERS • 00 TRADE SIZE THROUGH 1/2"
 MADE FROM FDA GRADE NITRILE (BUNA-N / NBR) PACKAGED IN RESEALABLE
 BAG OF 50 OR 100 WITH PRODUCT LABEL. (BULK OPTIONS AVAILABLE UPON REQUEST)



FW1699100	10318	• 00 TRADE SIZE 100 PACK
FW1699A100	10319	• 0 TRADE SIZE 100 PACK
FW1700100	10320	• 1/4" 100 PACK
FW1701100	10321	• 1/4L TRADE SIZE 100 PACK
FW1702100	10322	• 3/8" 100 PACK
FW170350	10323	• 3/8M TRADE SIZE 50 PACK
FW170450	10324	• 3/8L TRADE SIZE 50 PACK
FW170550	10325	• 1/2" 50 PACK

CRACK YOU UP

Because even when life's a drain, these jokes flow free.

