

CHECK STOP STEM UNITS

FOR SPEAKMAN

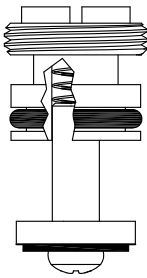

400220

FOR PRICE PFISTER



GASKET: 891130 O-RING INCLUDED

400501
OEM # 910-014

FOR ALTMANS



For 6000 Series Valve Body

GASKET: 890170 O-RING INCLUDED

400551H Hot, Red

400551C Cold, Blue
OEM # 9-TH-CHECK (HOT & COLD)

FOR ALTMANS



For HF9000

GASKET: 890170 O-RING INCLUDED

400561
400561-P Pair

FOR AMERICAN
STANDARD



GASKET: 890160 O-RING INCLUDED

400481
OEM # 23566.07.007

FOR DANZE, TOTO



GASKET: 890150 O-RING INCLUDED

400881
DANZE OEM # THU4125

FOR GLACIER BAY

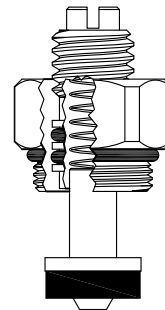

GASKET: 890150 O-RING INCLUDED

400231

FOR B&K,
ADVANCED TABCO

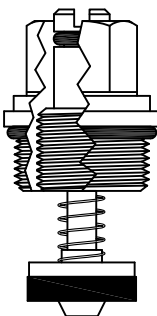

GASKET: 890170 O-RING INCLUDED

400241

FOR ALTMANS



For THEXCART

GASKET: 891150 O-RING INCLUDED

400631

FOR POWERS



GASKET: 890180 O-RING INCLUDED

400831
OEM # 141.000

CHECK STOP STEM UNITS

FOR SIGMA



GASKET: 890150 O-RING INCLUDED

400681
OEM # 18.30.156

FOR SEARS

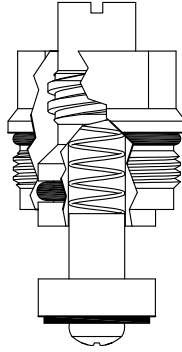

GASKET: 890180 O-RING INCLUDED

400261
OEM # 32406L

FOR MIXET

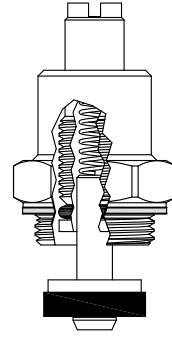

GASKET: 895060 INCLUDED

400371
OEM # MCHK

FOR NEWPORT



GASKET: 891170 O-RING INCLUDED

400791
OEM # 1-103

FOR SAYCO

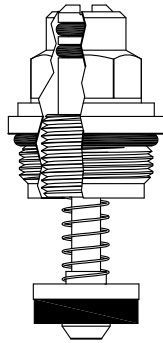

Nickel Plated Stem

GASKET: 890160 O-RING INCLUDED

400121
OEM # 8C 516887

FOR MOEN

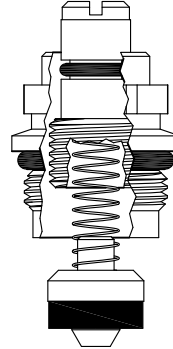

Nickel Plated Stem

GASKET: 891140 O-RING INCLUDED

400421
OEM # 12318

FOR MOEN

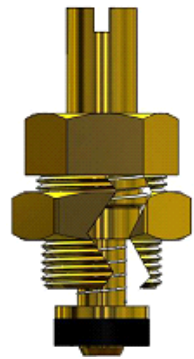

GASKET: 895110 INCLUDED

400531

FOR AM STD

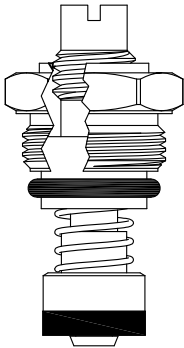

GASKET: 891130 O-RING INCLUDED

400171
OEM # 10527-0070A

FOR DELTA

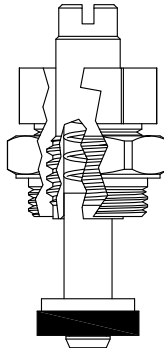

GASKET: 895060 INCLUDED

400151
OEM # RP2090

FOR WILLOUGHBY

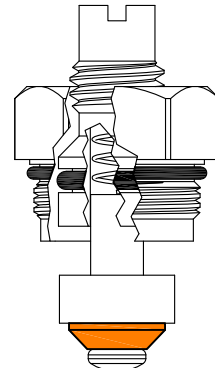

GASKET: 890190 O-RING INCLUDED

LF400451
OEM # 600089

CHECK STOP STEM UNITS

FOR ACORN

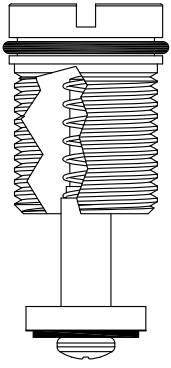

LF400190
OEM # 2415-000-001

FOR POWERS

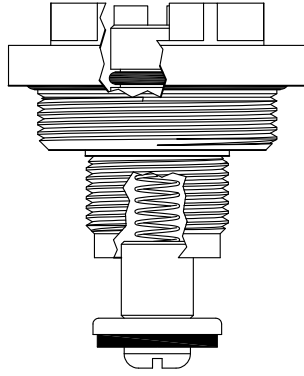

GASKET: 891230 O-RING INCLUDED

400471
200471 Stem Only
500470-KIT Retainer & Spring Only
OEM # 230-079

Also available as chrome plated unit
400471-CP
200471-CP Stem Only

FOR NEWPORT



400701
400701-P Pair

FOR SPEAKMAN

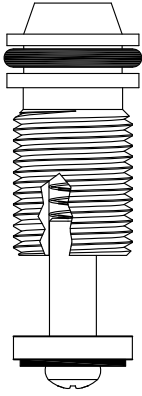

400390

FOR METCRAFT

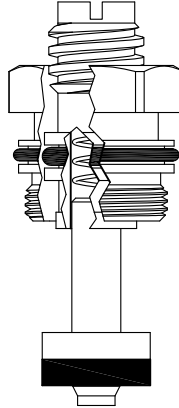

GASKET: 890160 O-RING INCLUDED

LF400441
OEM # 060282A

FOR METCRAFT

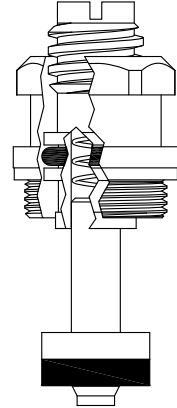

GASKET: 895100 INCLUDED

LF400461

FOR METCRAFT

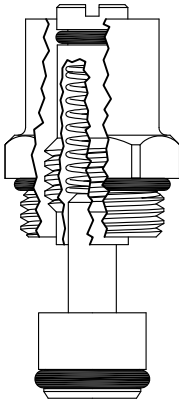

GASKET: 890170 O-RING INCLUDED

LF400751

FOR MIXET

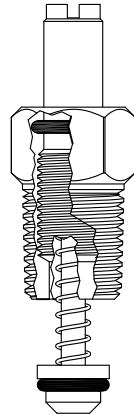

400731
OEM # MSPC

FOR ACORN

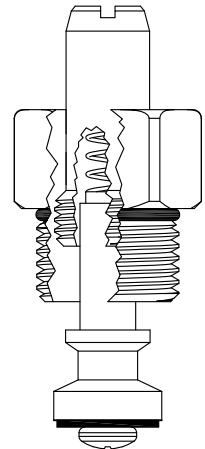

GASKET: 890160 O-RING INCLUDED

LF400571
OEM # 2755-005-002
LF200571 Stem Only

CHECK STOP STEM UNITS

FOR AMERICAN STANDARD

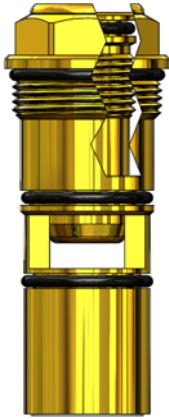

R510 Valve

GASKET: 890170 O-RING INCLUDED

400540H
OEM # 953951-0070a

FOR AMERICAN STANDARD

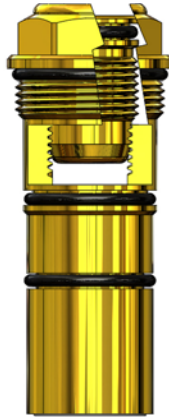

R510 Valve

GASKET: 890170 O-RING INCLUDED

400540C
OEM # 953950-007a

FOR MIXET



400901

FOR AM STD

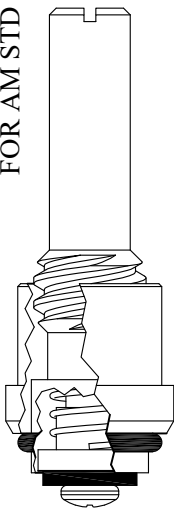

Chrome Plated Stem

GASKET: 8911300-RING INCLUDED

464221
OEM # 521-34
264221 Stem Only
OEM # 25317-04

FOR AMERICAN STANDARD



Hot, Red R530 3/4" Valve

GASKET: 8911300-RING INCLUDED

400580H
OEM # A953972-0070A

FOR AMERICAN STANDARD



Cold, Blue R530 3/4" Valve

GASKET: 8911300-RING INCLUDED

400580C
OEM # A953971-0070A

FOR CRANE
LENGTH: 3.71"

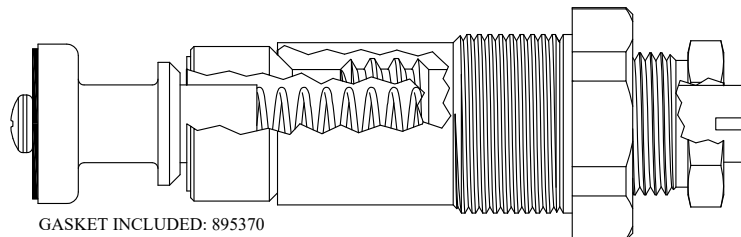

GASKET INCLUDED: 895370

402731 OEM # FB8368 or 355764
202731 Stem Only

STOP STEM & UNITS

FOR ELJER
STEM LENGTH: 1.05"

GASKET: 895060

400101

FOR SPEAKMAN
LENGTH: 1.07"

Nickel Plated Stem
Chrome Plated Pkg. Nut

LF400111
OEM # G03-0206 & 01-0513
LF200111 Stem Only
OEM # G03-0206

FOR KOHLER
LENGTH: 1.13"

400691

FOR KOHLER,
DELTA
LENGTH: 1.14"

147250
INCLUDES 400691 & 400671
KOHLER OEM # 77148

400671
DELTA OEM # RP16213

FOR DELTA
LENGTH: 1.15"

200141

FOR CRANE
LENGTH: 1.15"

400201
200201 Stem Only
OEM # F12078

FOR CRANE
LENGTH: 1.15"

GASKET: 890160 O-RING INCLUDED

400211
OEM # FB9238
200201 Stem Only
OEM # F12078

FOR GERBER
LENGTH: 1.19"

GASKET: 895150

400381
OEM # 98-660

FOR STERLING
LENGTH: 1.21"

400851

FOR SYMMONS
LENGTH: 1.24"

Stop Unit for C-5
Replacement for
C32-11 & C32B-11

400521

FOR STERLING FAUCET
LENGTH: 1.24"

GASKET: 895110

400181

STOP STEMS & UNITS

FOR ELJER
LENGTH: 1.25"

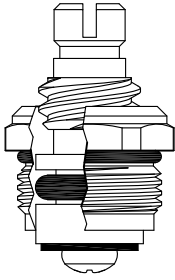

GASKET: 890160 O-RING INCLUDED

400131

FOR PRICE PFISTER
STEM LENGTH: 1.26"

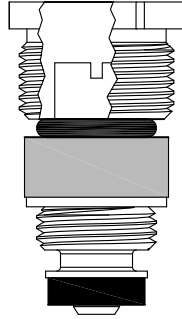

400301
OEM # 910-671
200301 Stem Only

FOR MOEN
LENGTH: 1.265"



Nickel Plated Stem

GASKET INCLUDED: 891140

400541

UNKNOWN
LENGTH: 1.29"



400781

FOR SAVOY
LENGTH: 1.31"

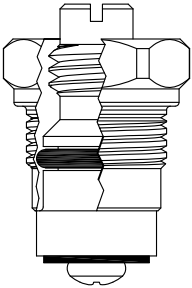

GASKET INCLUDED: 895100

400291

FOR SAYCO
LENGTH: 1.37"

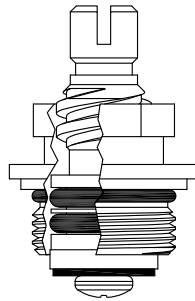

Nickel Plated Gland

GASKET: 890160 O-RING INCLUDED

400271

FOR SAYCO
LENGTH: 1.37"

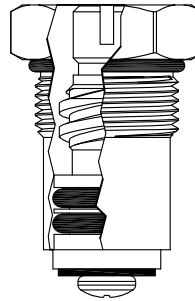

GASKET: 890170 O-RING INCLUDED

400281

FOR ELJER
LENGTH: 1.37"

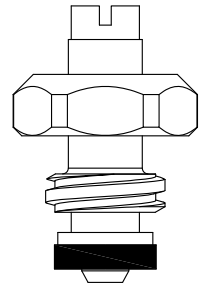

400251

FOR ELJER
LENGTH: 1.38"

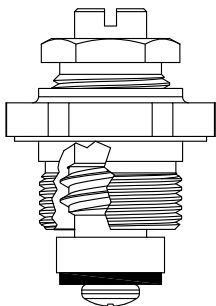

GASKET INCLUDED: 895100

400331
200331

OEM # 490-5725-00

FOR LEONARD
LENGTH: 1.39"



LF400771
LF400771-P

UNKNOWN
STEM LENGTH: 1.39"



GASKET INCLUDED: 895110

400761

STOP STEMS & UNITS



UNKNOWN
STEM LENGTH: 1.39"

GASKET INCLUDED: 895110

400761

FOR ELJER
LENGTH: 1.56"

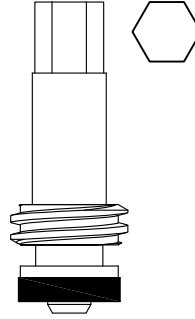

200351

FOR CRANE
LENGTH: 1.57"

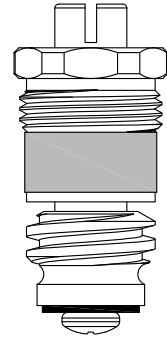

452821

252821 Stem Only
OEM # FB9301

FOR MIXET
LENGTH: 1.60"

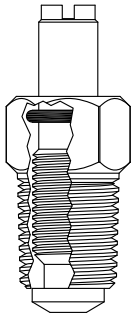

400721
OEM # MCSVS

FOR SPEAKMAN
LENGTH: 1.64"

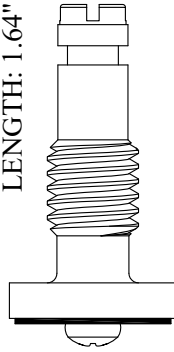

Chrome Plated Stem

252911
OEM # G03-0205

UNKNOWN
LENGTH: 1.66"

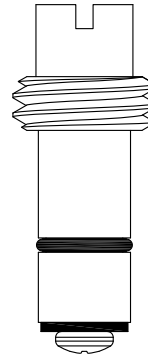

200611

FOR AM STD
LENGTH: 1.69"

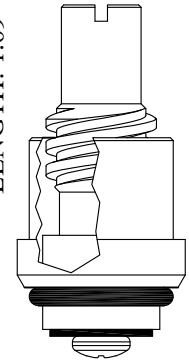

GASKET: 891130 O-RING INCLUDED

453181

253181 Stem Only
OEM # 1011-14

FOR SYMMONS
LENGTH: 1.69"

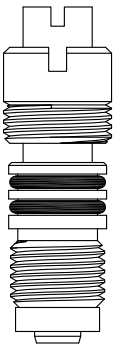

400661
200661 Stem Only

OEM # T-52
OEM # T-52A or NS-18

FOR AM STD
LENGTH: 1.71"

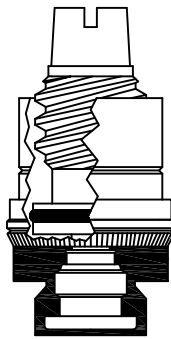

453191

OEM # 72948-04

FOR ACORN
LENGTH: 1.73"

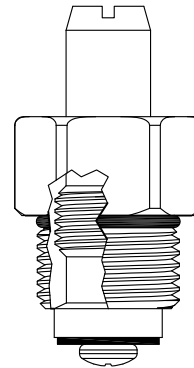

GASKET: 890160 O-RING INCLUDED

LF454071

LF254071 Stem Only

OEM # 2755-000-002
OEM # 2755-000-001

FOR PRICE PFISTER
LENGTH: 1.77"

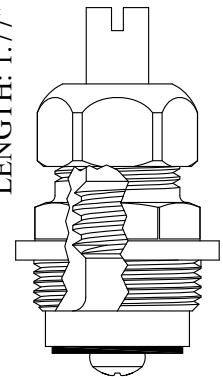

GASKET: 895400

400741

200741 Stem Only

OEM # 910-192
OEM # 910-191

STOP STEMS & UNITS

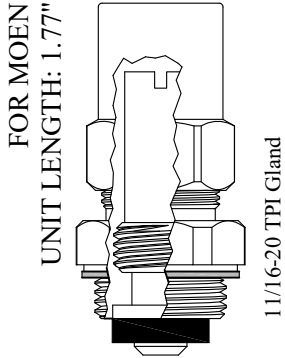

GASKET: 895110 INCLUDED

400311

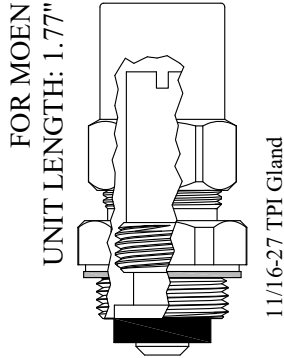

GASKET: 895110 INCLUDED

400321

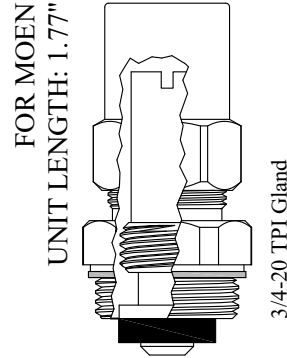

GASKET: 895110 INCLUDED

400341

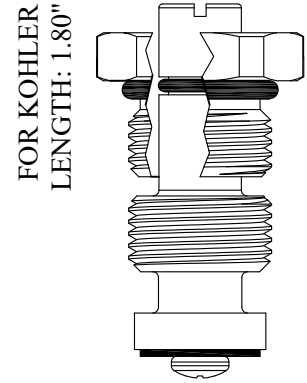

GASKET: 891140 O-RING INCLUDED

400921

200921 Stem Only



200841

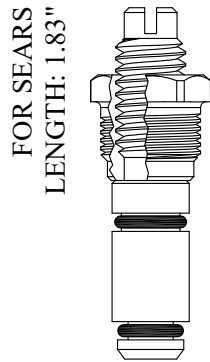

400361

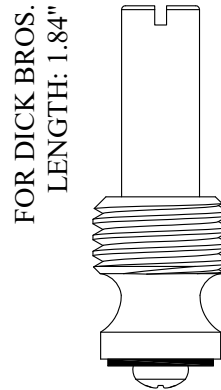

LF257001

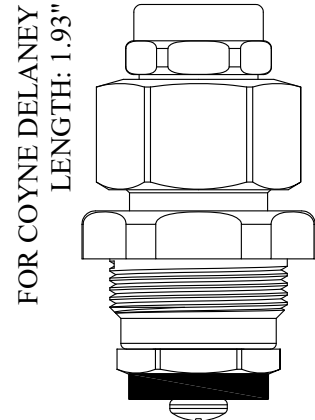

GASKET INCLUDED: 895370

460302

OEM # 89A-J

Chrome Plated Unit

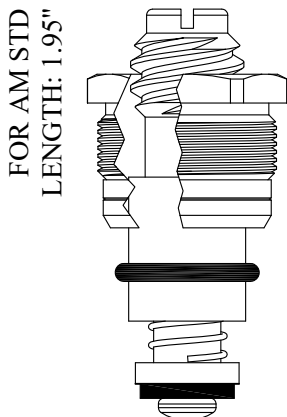

GASKET: 891130 O-RING INCLUDED

400591

200591 Stem Only

OEM # 25318-07

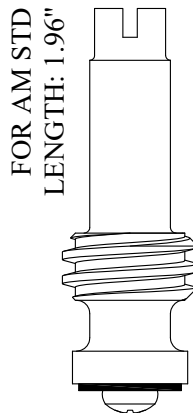

257351

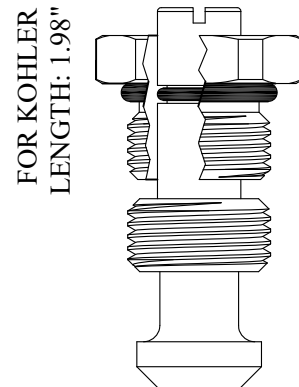

GASKET: 891140 O-RING INCLUDED

400911

200911 Stem Only

STOP STEMS & UNITS

FOR BRIGGS
LENGTH: 2.08"

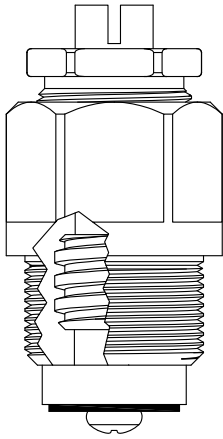

GASKET: 895370

401461

201461 Stem Only

OEM # 3573

FOR MUELLER
LENGTH: 2.15"

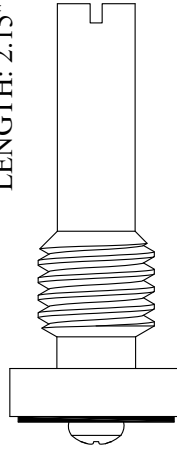

Chrome Plated Stem

201141

FOR SPEAKMAN
LENGTH: 2.15"

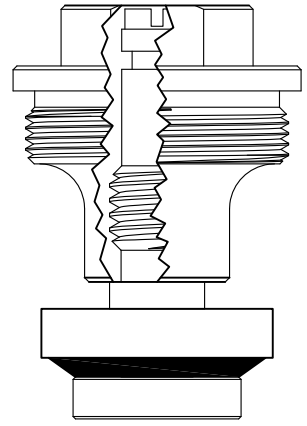

460401

LENGTH: 2.20"

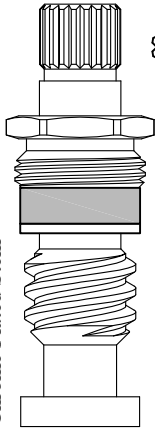

Chrome Plated Stem

20
2-4

STEM UNIT FOR SENTINEL VALVE

401131

OEM # 03-0257

FOR NIBCO
LENGTH: 2.24"

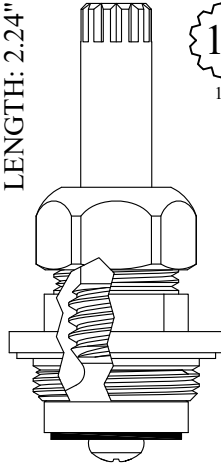

12
1-2

GASKET: 895400

191041

FOR ACORN
LENGTH: 2.25"

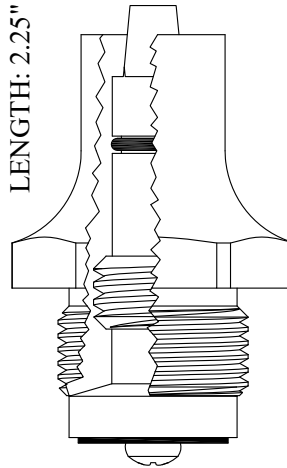

Chrome Plated Bonnet

GASKET: 895570

483121

OEM # 0485-000-002

FOR AM STD
LENGTH: 2.28"

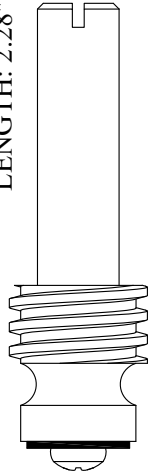

Nickel Plated Stem

261131

OEM # 19422-07 or 31290-07

FOR AM STD
LENGTH: 2.28"

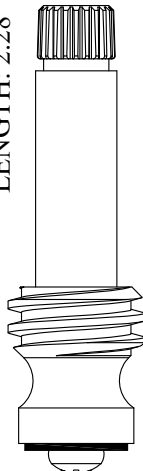

22
1-4

263281

OEM # 63370-04

FOR ACORN
LENGTH: 2.27"

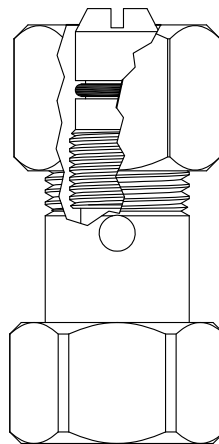

GASKET: 895100 INCLUDED

LF138921

OEM # 2366-031-001

LF136401 Stem Only

OEM # 2366-034-199

FOR TANNER
LENGTH: 2.29"

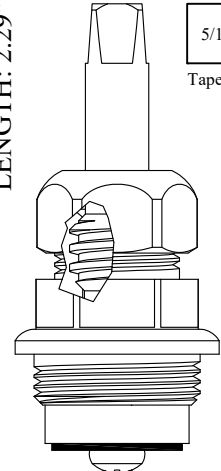

5/16
Tapered

GASKET: 895400

462561

STOP STEMS & UNITS

FOR BRADLEY
LENGTH: 2.46"

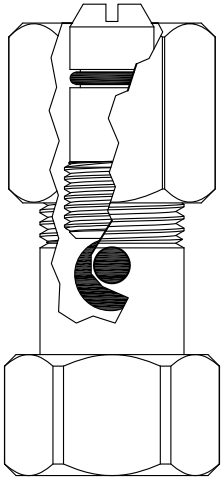

GASKET: 895100 INCLUDED

LF126480

FOR AM STD
LENGTH: 2.50"

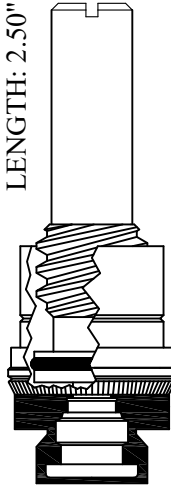

401551
OEM # 72964-04

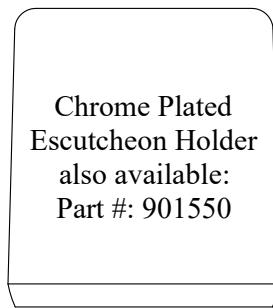

Chrome Plated
Escutcheon Holder
also available:
Part #: 901550

FOR GERBER
LENGTH: 2.56"

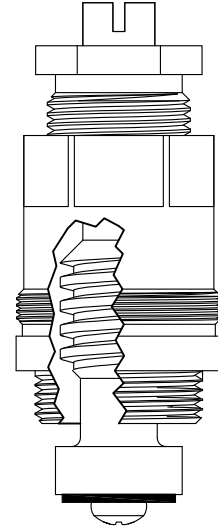

GASKET: 895400

401241
201241 Stem Only
OEM # 98-671

FOR CENTRAL
LENGTH: 2.66"

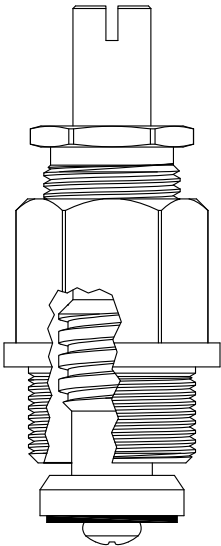

GASKET: 895400

401611
201611 Stem Only

FOR CENTRAL
LENGTH: 2.66"

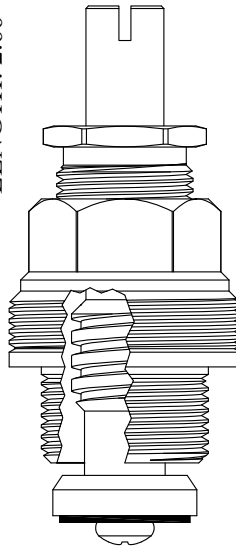

GASKET: 895400

401621
201611 Stem Only

FOR SPEAKMAN
LENGTH: 2.63"

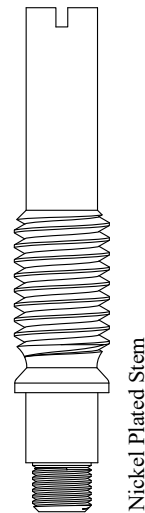

Nickel Plated Stem

264331
OEM # 03-0237

STOP STEMS & UNITS

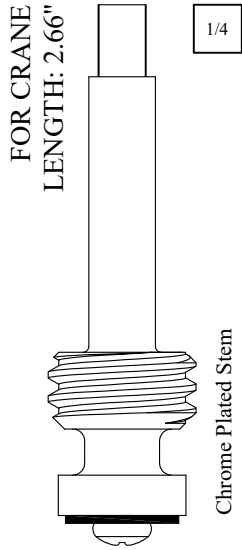

FOR CRANE
LENGTH: 2.66"

1/4

Chrome Plated Stem

LF264461

FOR ACORN
LENGTH: 2.72"
STEM LENGTH: 1.72"

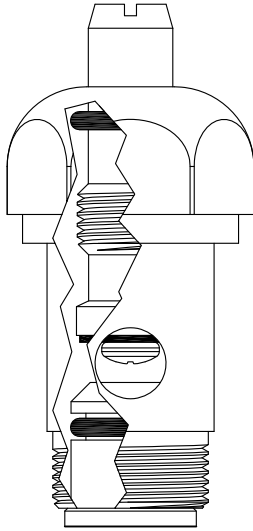

GASKET: 895400 INCLUDED
SEAT INCLUDED: LF601780

LF401781
LF254071 Stem Only

OEM # 2767-010-002
OEM # 2767-010-001

FOR AM STD
LENGTH: 2.78"

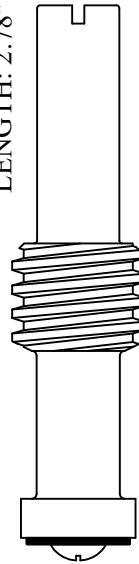

Chrome Plated Stem

201711

OEM # 21183-02

FOR CRANE
LENGTH: 2.80"



Chrome Plated Unit

LF464461

FOR AM STD
LENGTH: 2.88"

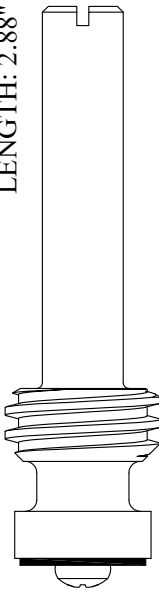

Chrome Plated Stem

265611
OEM # 31347-05

LENGTH: 3.02"

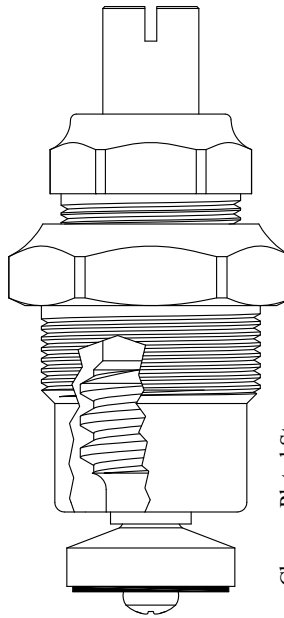

Chrome Plated Stem

GASKET: 895450

402071
OEM # G05-0158
202071 Stem Only
OEM # G03-0113

FOR SPEAKMAN
LENGTH: 3.06"

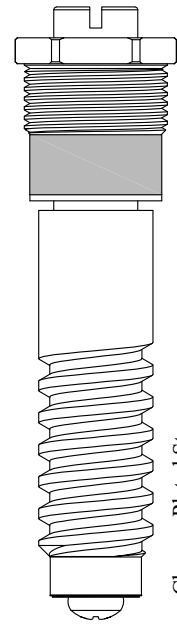

Chrome Plated Stem

401901
201901 Stem Only
OEM # G03-0187

STOP STEMS & UNITS

FOR PRICE PFISTER
LENGTH: 3.22"

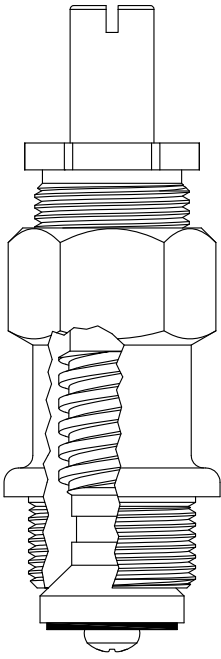

GASKET: 895400

402621
202621 Stem Only

FOR PRICE PFISTER
LENGTH: 3.22"

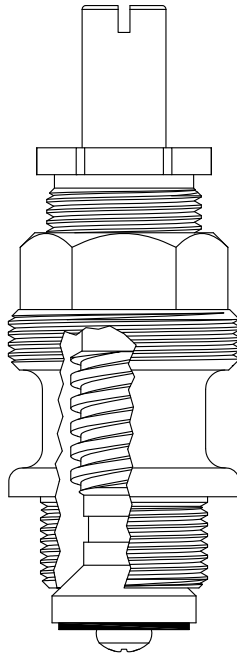

GASKET: 895400

402671
202621 Stem Only
OEM # 910-033

FOR ILLINOIS
LENGTH: 3.24"

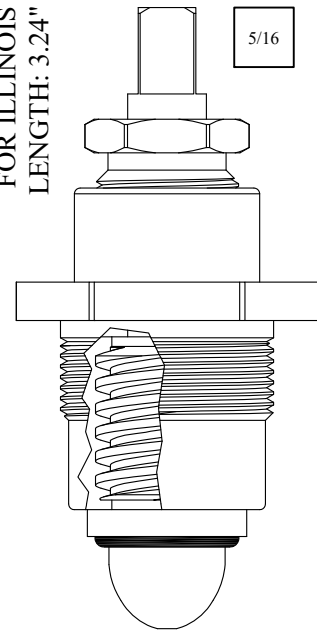

483421

FOR BRIGGS
LENGTH: 3.25"

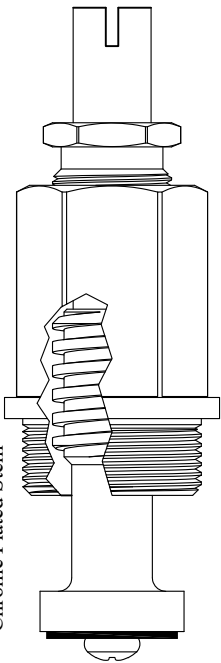

Chrome Plated Stem

GASKET: 895370

402611
202611 Stem Only
OEM # 6734

FOR SAVOY
LENGTH: 3.47"

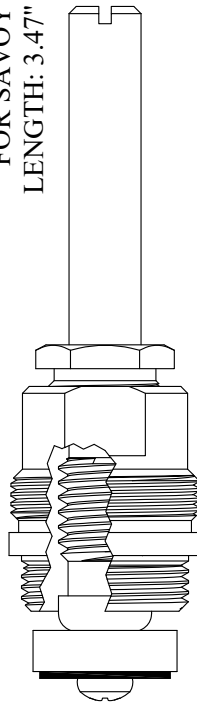

GASKET: 895400

402831
OEM # 02-A60 (A-60)

FOR KOHLER
LENGTH: 3.50"

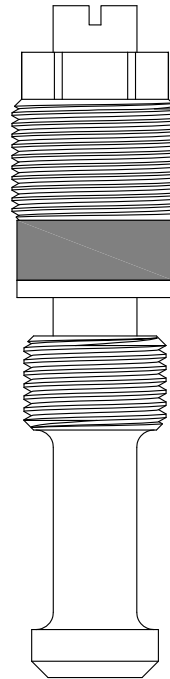

402991
202991 Stem Only

STOP STEMS & UNITS

FOR GLAUBER WEST COAST
STEM LENGTH: 3.65"

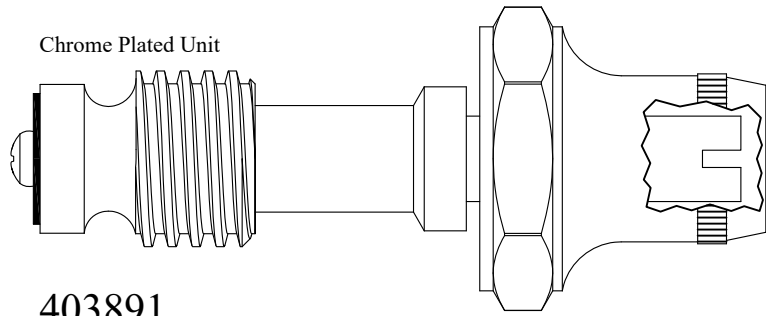

403891
203891 Stem Only

FOR CRANE
LENGTH: 3.66"

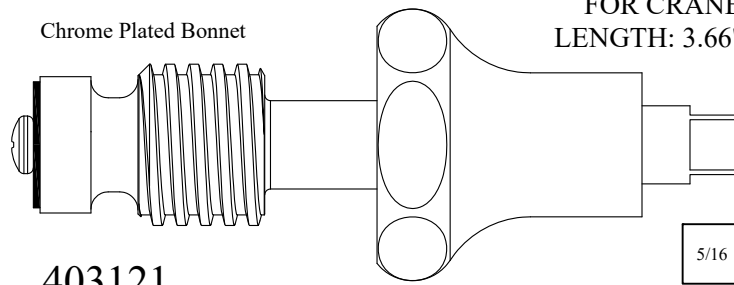

403121
203121 Stem Only

FOR SAVOY
LENGTH: 4.14"

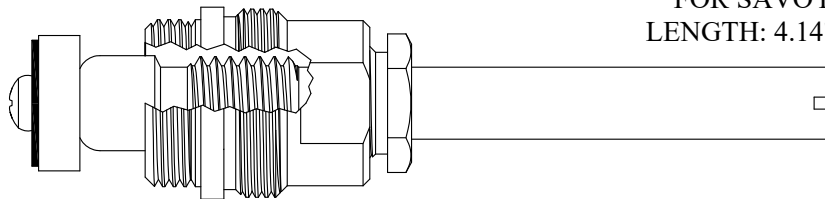

GASKET INCLUDED: 895400

405521

FOR BRIGGS
LENGTH: 4.17"

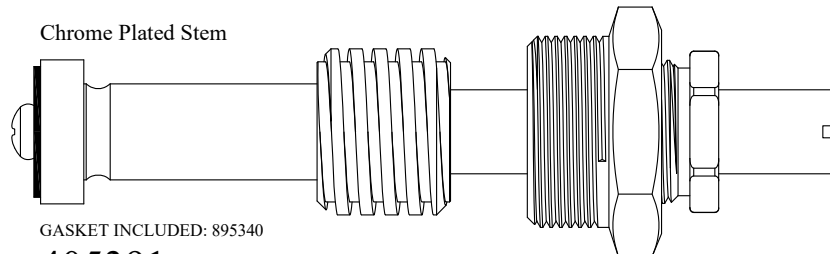

GASKET INCLUDED: 895340

405391
205391 Stem Only

STOP STEMS & UNITS

