

# CHECK STOP STEM UNITS

FOR POWERS

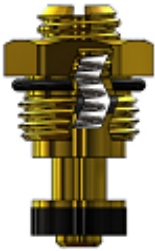

GASKET: 890150 O-RING INCLUDED  
**402111**  
 OEM # 900-050

FOR SPEAKMAN

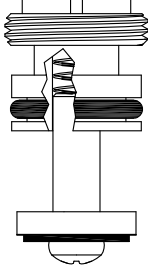

**400220**

FOR PRICE PFISTER



GASKET: 891130 O-RING INCLUDED  
**400501**  
 OEM # 910-014

FOR ALTMANS



For 6000 Series Valve Body

GASKET: 890170 O-RING INCLUDED

**400551H** Hot, Red  
**400551C** Cold, Blue  
 OEM # 9-TH-CHECK (HOT & COLD)

FOR ALTMANS



For HF9000

GASKET: 890170 O-RING INCLUDED

**400561**  
**400561-P** Pair

FOR AMERICAN STANDARD



GASKET: 890160 O-RING INCLUDED

**400481**  
 OEM # 23566.07.007

FOR DANZE, TOTO



GASKET: 890150 O-RING INCLUDED

**400881**  
 DANZE OEM # THU4125

FOR GLACIER BAY

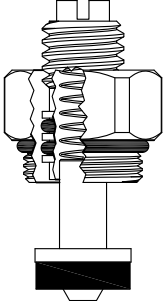

GASKET: 890150 O-RING INCLUDED

**400231**

FOR B&K,  
 ADVANCED TABCO

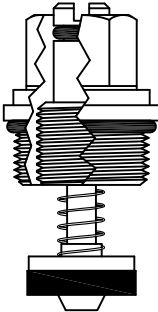

GASKET: 890170 O-RING INCLUDED

**400241**

FOR ALTMANS



For THEXCART

GASKET: 891150 O-RING INCLUDED

**400631**

FOR POWERS



GASKET: 890180 O-RING INCLUDED

**400831**  
 OEM # 141.000

# CHECK STOP STEM UNITS

FOR SIGMA



GASKET: 890150 O-RING INCLUDED

**400681**  
OEM # 18.30.156

FOR SEARS

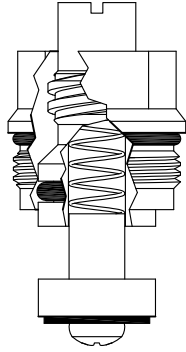

GASKET: 890180 O-RING INCLUDED

**400261**  
OEM # 32406L

FOR MIXET

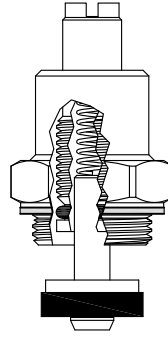

GASKET INCLUDED: 895060

**400371**  
OEM # MCHK

FOR NEWPORT



GASKET: 891170 O-RING INCLUDED

**400791**  
OEM # 1-103

FOR GROHE



GASKET: 891160 O-RING INCLUDED

**142790**  
OEM # 08.213

FOR SAYCO

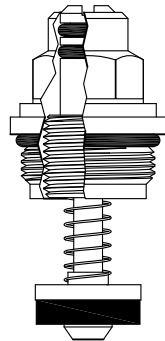

GASKET: 890160 O-RING INCLUDED

**400121**  
OEM # 8C 516887

Nickel Plated Stem

FOR MOEN

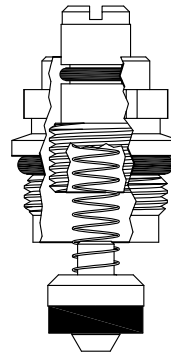

GASKET: 891140 O-RING INCLUDED

**400421**  
OEM # 12318

Nickel Plated Stem

FOR MOEN

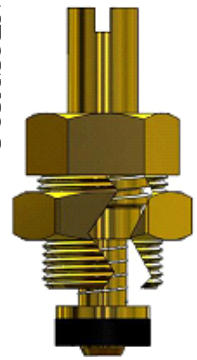

GASKET INCLUDED: 895110

**400531**

FOR AM STD

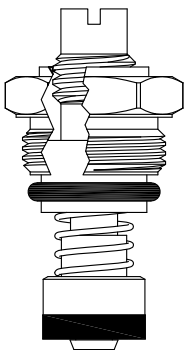

GASKET: 891130 O-RING INCLUDED

**400171**  
OEM # 10527-0070A

FOR DELTA

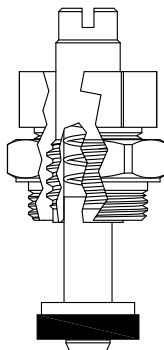

GASKET INCLUDED: 895060

**400151**

OEM # RP2090

FOR WILLOUGHBY

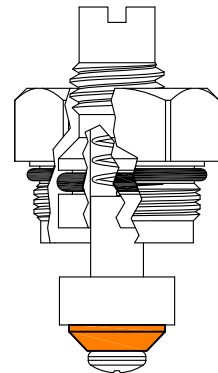

GASKET: 890190 O-RING INCLUDED

**LF400451**

OEM # 600089

# CHECK STOP STEM UNITS

FOR ACORN

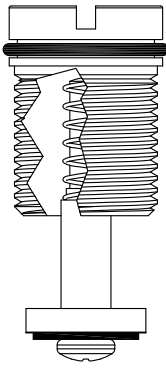

GASKET: 890170 O-RING INCLUDED

**LF400190**  
OEM # 2415-000-001

FOR POWERS

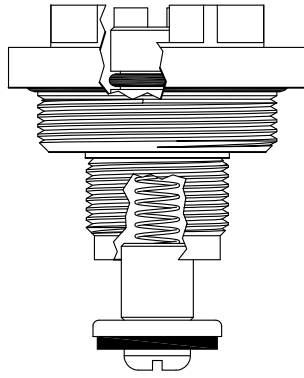

GASKET: 891230 O-RING INCLUDED

**400471**  
**200471** Stem Only  
**500470-KIT** Retainer & Spring Only  
OEM # 230-079

Also available as chrome plated unit  
**400471-CP**  
**200471-CP** Stem Only

FOR LEONARD



**LF400701**  
**LF400701-P** Pair

FOR SPEAKMAN

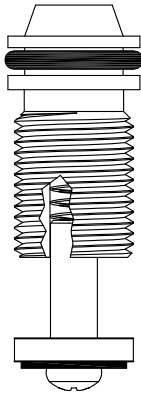

**400390**

FOR METCRAFT

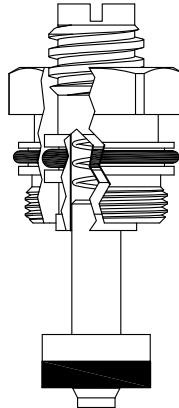

GASKET: 890160 O-RING INCLUDED

**LF400441**  
OEM # 060282A

FOR METCRAFT

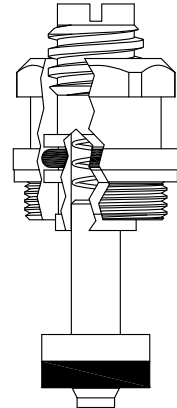

GASKET INCLUDED: 895100

**LF400461**

FOR METCRAFT

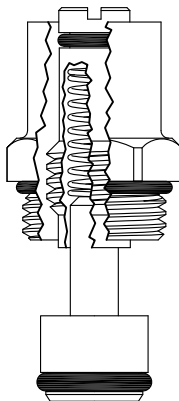

GASKET: 890170 O-RING INCLUDED

**LF400751**

FOR MIXET

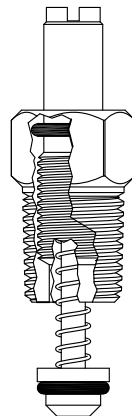

**400731**  
OEM # MSPC

FOR ACORN

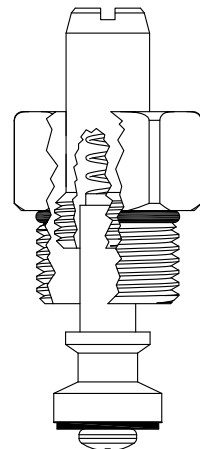

GASKET: 890160 O-RING INCLUDED

**LF400571**  
OEM # 2755-005-002  
**LF200571** Stem Only

# CHECK STOP STEM UNITS

FOR AMERICAN STANDARD

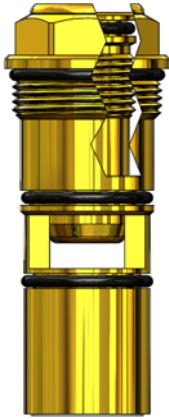

R510 Valve

GASKET: 890170 O-RING INCLUDED

**400540H**  
OEM # 953951-0070a

FOR AMERICAN STANDARD

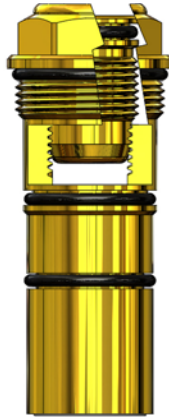

R510 Valve

GASKET: 890170 O-RING INCLUDED

**400540C**  
OEM # 953950-007a

FOR MIXET



**400901**

FOR AM STD

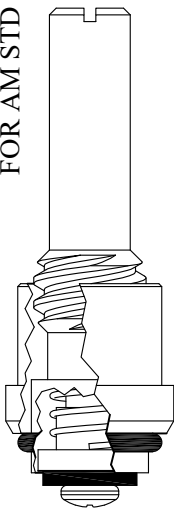

Chrome Plated Stem

GASKET: 8911300-RING INCLUDED

**464221**  
OEM # 521-34  
**264221** Stem Only  
OEM # 25317-04

FOR AMERICAN STANDARD



Hot, Red R530 3/4" Valve

GASKET: 8911300-RING INCLUDED

**400580H**  
OEM # A953972-0070A

FOR AMERICAN STANDARD



Cold, Blue R530 3/4" Valve

GASKET: 8911300-RING INCLUDED

**400580C**  
OEM # A953971-0070A

FOR CRANE  
LENGTH: 3.71"

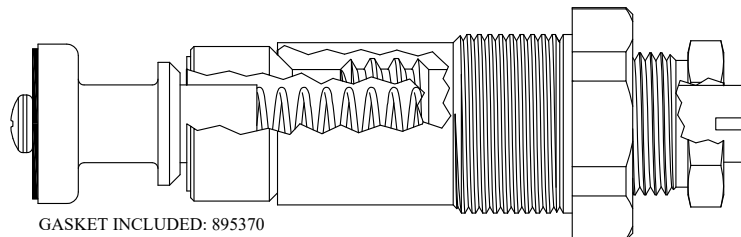

GASKET INCLUDED: 895370

**402731** OEM # FB8368 or 355764  
**202731** Stem Only

# STOP STEM & UNITS

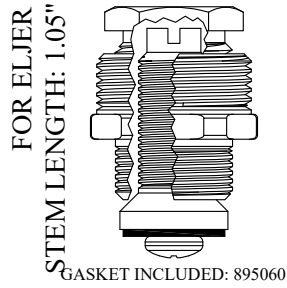

400101

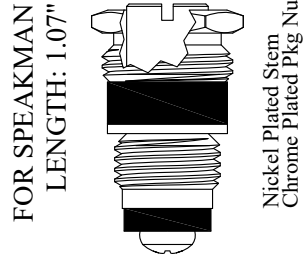

LF400111

OEM # G03-0206 & 01-0513

LF200111 Stem Only

OEM # G03-0206

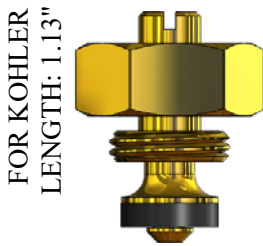

147250

INCLUDES 400691 & 400671  
KOHLER OEM # 77148

400691

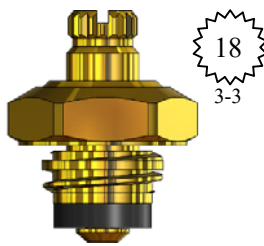

400671

DELTA OEM # RP16213

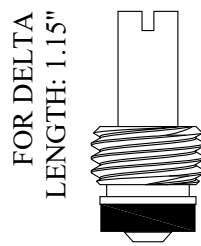

200141

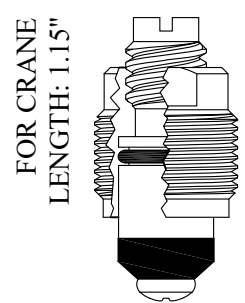

400201

200201 Stem Only

OEM # F12078

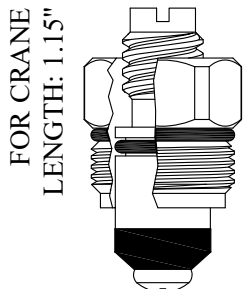

GASKET: 890160 O-RING INCLUDED

400211

OEM # FB9238

200201 Stem Only

OEM # F12078

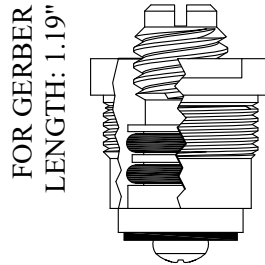

GASKET INCLUDED: 895150

400381

OEM # 98-660



401001



400851



400521

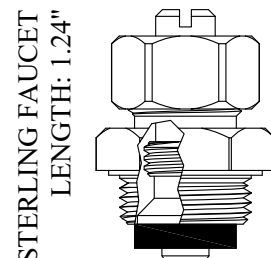

GASKET INCLUDED: 895110

400181

# STOP STEMS & UNITS

FOR ELJER  
LENGTH: 1.25"

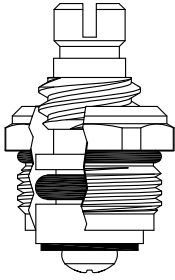

GASKET: 890160 O-RING INCLUDED

400131

FOR PRICE PFISTER  
STEM LENGTH: 1.26"

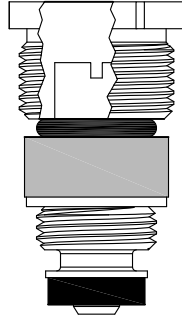

400301  
OEM # 910-671  
200301 Stem Only

FOR MOEN  
LENGTH: 1.265"



Nickel Plated Stem

GASKET INCLUDED: 891140

400541

UNKNOWN  
LENGTH: 1.29"



400781

FOR SAVOY  
LENGTH: 1.31"

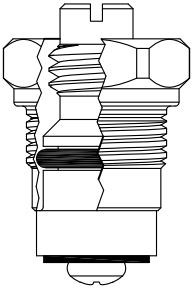

GASKET INCLUDED: 895100

400291

FOR SAYCO  
LENGTH: 1.37"

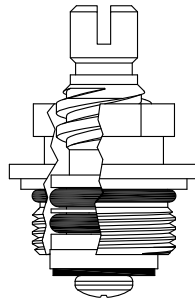

Nickel Plated Gland

GASKET: 890160 O-RING INCLUDED

400271

FOR SAYCO  
LENGTH: 1.37"

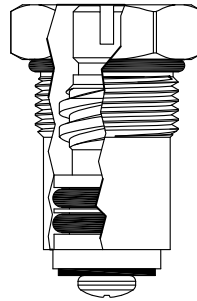

GASKET: 890170 O-RING INCLUDED

400281

FOR ELJER  
LENGTH: 1.37"

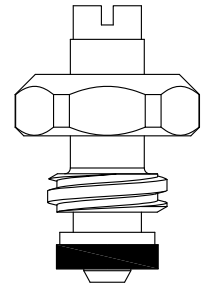

400251

FOR ELJER  
LENGTH: 1.38"

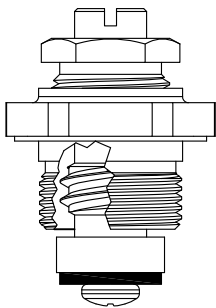

GASKET INCLUDED: 895100

400331  
200331

OEM # 490-5725-00

FOR LEONARD  
LENGTH: 1.39"



LF400771  
LF400771-P

UNKNOWN  
STEM LENGTH: 1.39"



18  
3-3

GASKET INCLUDED: 895110

400761



# STOP STEMS & UNITS



GASKET INCLUDED: 895110  
**400761**

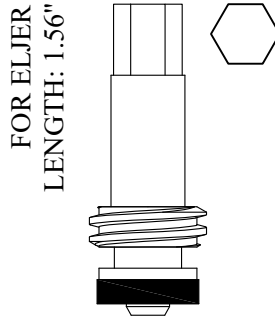

**200351**

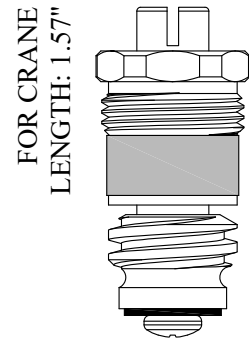

**452821**  
**252821** Stem Only  
 OEM # FB9301

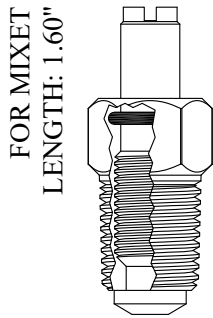

**400721**  
 OEM # MCSVS

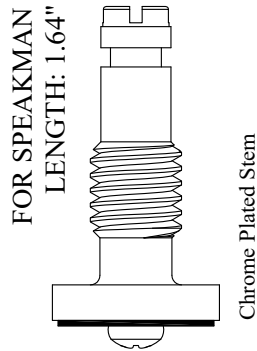

**252911**  
 OEM # G03-0205

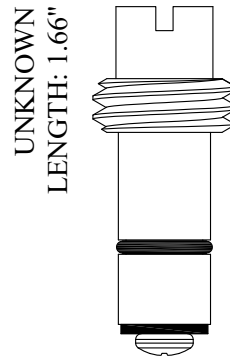

**200611**

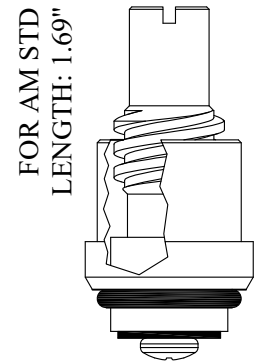

GASKET: 891130 O-RING INCLUDED  
**453181**  
**253181** Stem Only  
 OEM # 1011-14

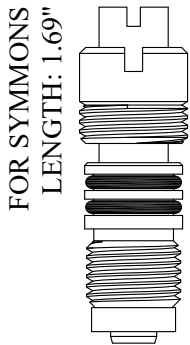

**400661**  
**200661** Stem Only  
 OEM # T-52  
 OEM # T-52A or NS-18



**453191**  
 OEM # 72948-04

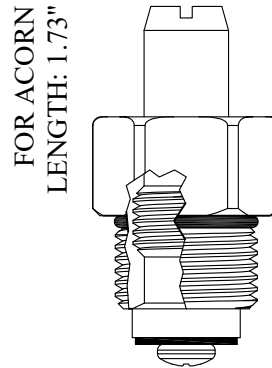

GASKET: 890160 O-RING INCLUDED  
**LF454071**  
**LF254071** Stem Only  
 OEM # 2755-000-002  
 OEM # 2755-000-001

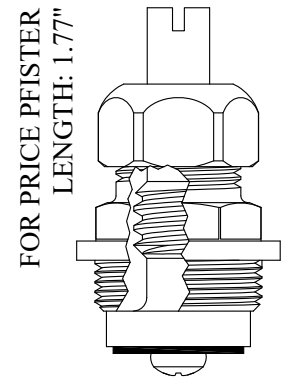

GASKET INCLUDED: 895400  
**400741**  
**200741** Stem Only  
 OEM # 910-192  
 OEM # 910-191

# STOP STEMS & UNITS

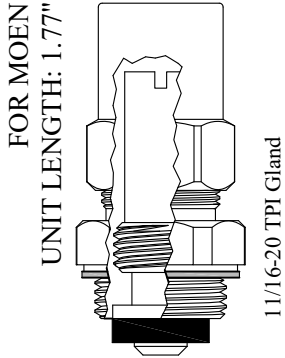

GASKET INCLUDED: 895110

400311

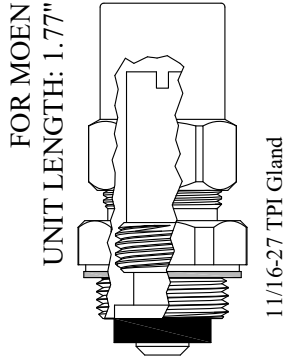

GASKET INCLUDED: 895110

400321

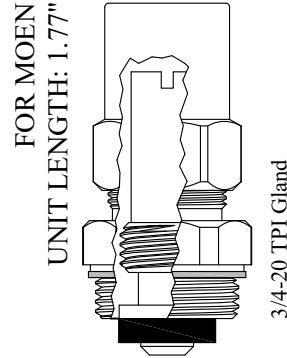

GASKET INCLUDED: 895110

400341

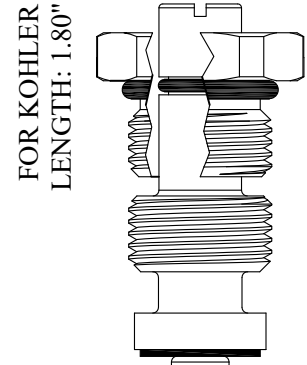

GASKET: 891140 O-RING INCLUDED

400921

200921 Stem Only



200841

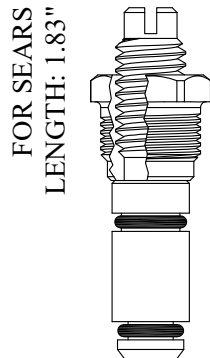

400361

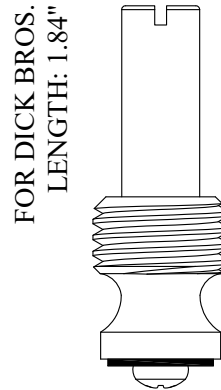

LF257001

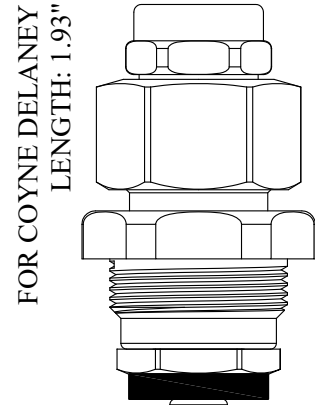

GASKET INCLUDED: 895370

460302

OEM # 89A-J

Chrome Plated Unit

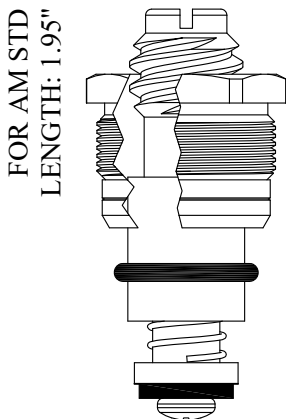

GASKET: 891130 O-RING INCLUDED

400591

200591 Stem Only

OEM # 25318-07

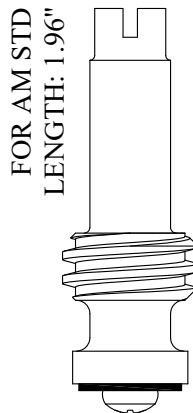

257351

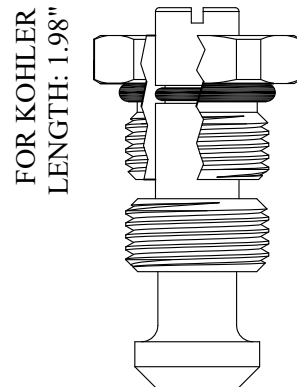

GASKET: 891140 O-RING INCLUDED

400911

200911 Stem Only



# STOP STEMS & UNITS

FOR BRIGGS  
LENGTH: 2.08"

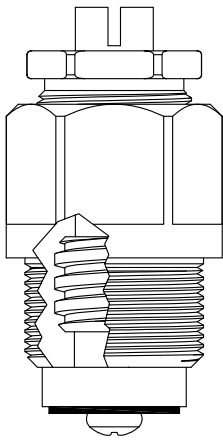

GASKET INCLUDED: 895370

**401461**

**201461** Stem Only  
OEM # 3573

FOR MUELLER  
LENGTH: 2.15"

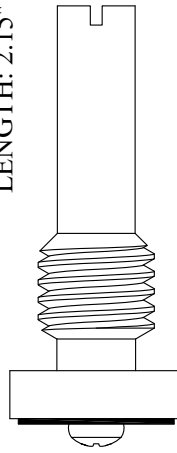

Chrome Plated Stem

**201141**

FOR SPEAKMAN  
LENGTH: 2.15"

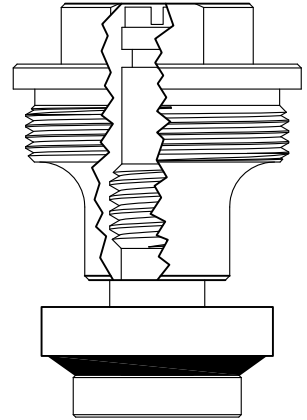

**460401**

LENGTH: 2.20"

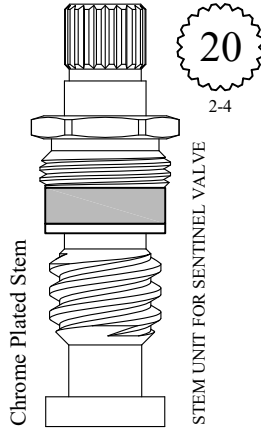

Chrome Plated Stem

20  
2-4

STEM UNIT FOR SENTINEL VALVE

**401131**  
OEM # 03-0257

FOR NIBCO  
LENGTH: 2.24"

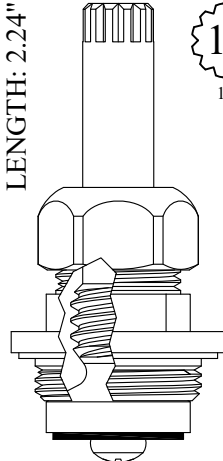

12  
1-2

GASKET INCLUDED: 895400

**191041**

FOR ACORN  
LENGTH: 2.25"

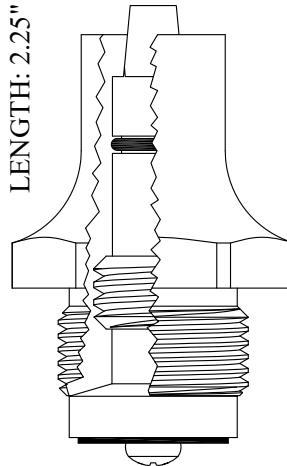

Chrome Plated Bonnet

GASKET INCLUDED: 895570

**483121**  
OEM # 0485-000-002

FOR AM STD  
LENGTH: 2.28"

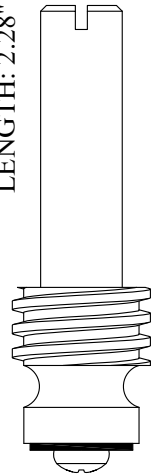

Nickel Plated Stem

**261131**  
OEM # 19422-07 or 31290-07

FOR AM STD  
LENGTH: 2.28"

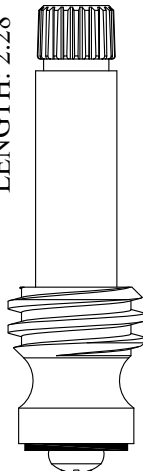

22  
1-4

**263281**  
OEM # 63370-04

FOR ACORN  
LENGTH: 2.27"

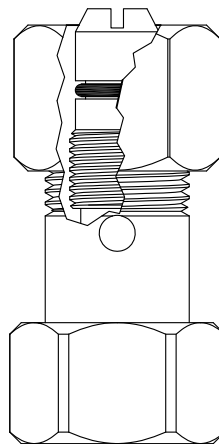

GASKET INCLUDED: 895100

**LF138921**  
OEM # 2366-031-001

**LF136401** Stem Only  
OEM # 2366-034-199

FOR TANNER  
LENGTH: 2.29"

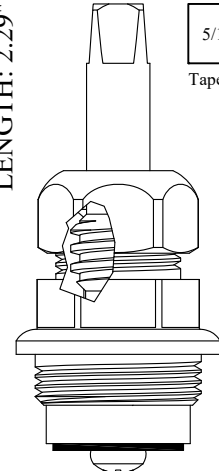

5/16  
Tapered

GASKET INCLUDED: 895400

**462561**

# STOP STEMS & UNITS

FOR BRADLEY  
LENGTH: 2.46"

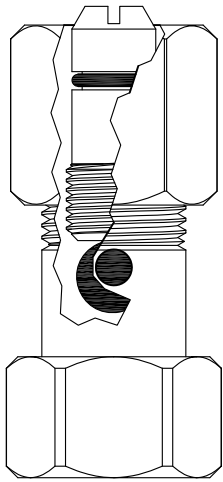

GASKET INCLUDED: 895100

**LF126480**

FOR AM STD  
LENGTH: 2.50"

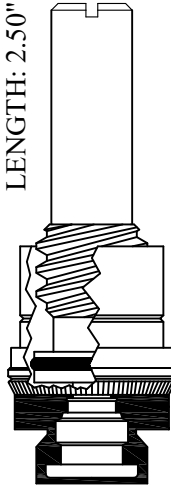

**401551**  
OEM # 72964-04

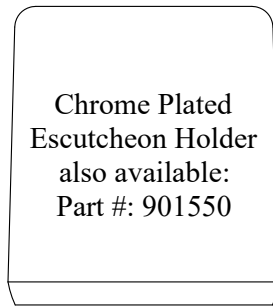

Chrome Plated  
Escutcheon Holder  
also available:  
Part #: 901550

FOR GERBER  
LENGTH: 2.56"

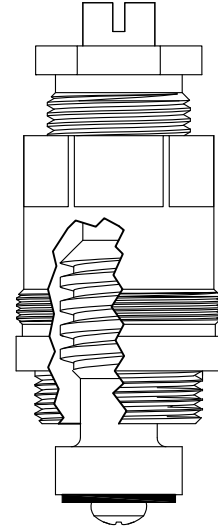

GASKET INCLUDED: 895400

**401241**  
**201241** Stem Only  
OEM # 98-671

FOR CENTRAL  
LENGTH: 2.66"

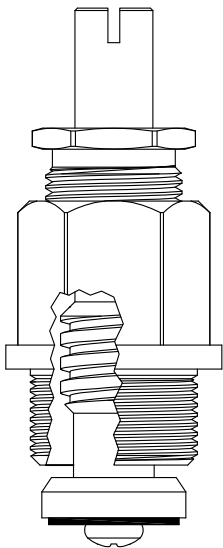

GASKET INCLUDED: 895400

**401611**  
**201611** Stem Only

FOR CENTRAL  
LENGTH: 2.66"

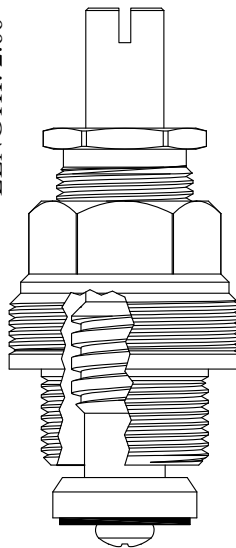

GASKET INCLUDED: 895400

**401621**  
**201611** Stem Only

FOR SPEAKMAN  
LENGTH: 2.63"

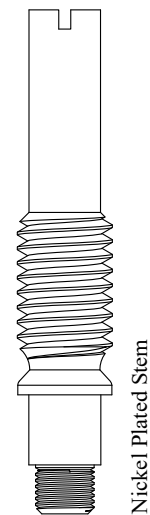

Nickel Plated Stem

**264331**  
OEM # 03-0237

# STOP STEMS & UNITS

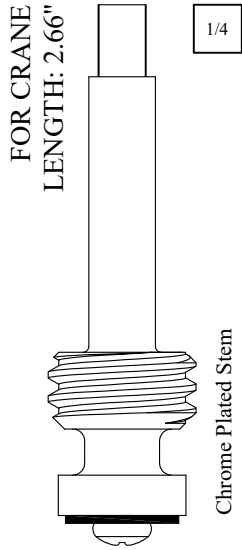

FOR CRANE  
LENGTH: 2.66"

1/4

Chrome Plated Stem

LF264461

FOR ACORN  
LENGTH: 2.72"  
STEM LENGTH: 1.72"

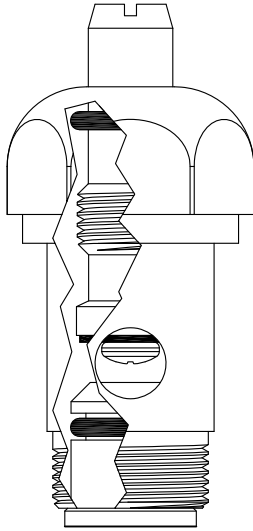

Also available less gland  
LF117621  
Stem & Seat Only

GASKET INCLUDED: 895400  
SEAT INCLUDED: LF601780

LF401781  
LF254071 Stem Only

OEM # 2767-010-002  
OEM # 2767-010-001

FOR AM STD  
LENGTH: 2.78"

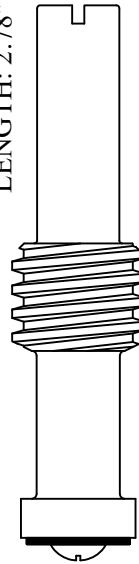

Chrome Plated Stem

201711

OEM # 21183-02

FOR CRANE  
LENGTH: 2.80"



Chrome Plated Unit

LF464461

FOR AM STD  
LENGTH: 2.88"

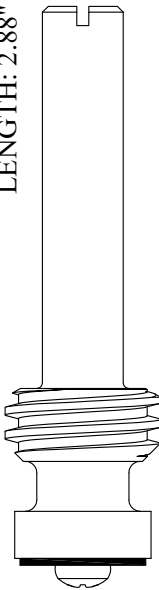

Chrome Plated Stem

265611

OEM # 31347-05

LENGTH: 3.02"

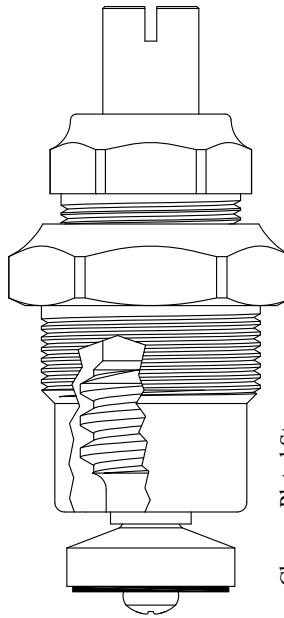

Chrome Plated Stem

GASKET INCLUDED: 895450

402071  
OEM # G05-0158  
202071 Stem Only  
OEM # G03-0113

FOR SPEAKMAN  
LENGTH: 3.06"

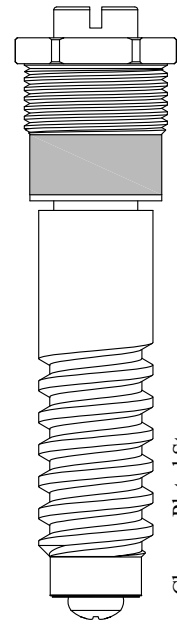

Chrome Plated Stem

401901  
201901 Stem Only  
OEM # G03-0187

# STOP STEMS & UNITS

FOR PRICE PFISTER  
LENGTH: 3.22"

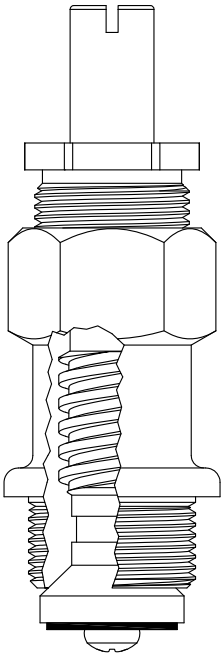

GASKET INCLUDED: 895400

**402621**  
**202621** Stem Only

FOR PRICE PFISTER  
LENGTH: 3.22"

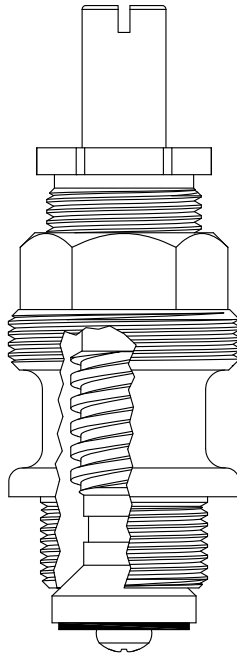

GASKET INCLUDED: 895400

**402671**  
**202621** Stem Only  
OEM # 910-033

FOR ILLINOIS  
LENGTH: 3.24"

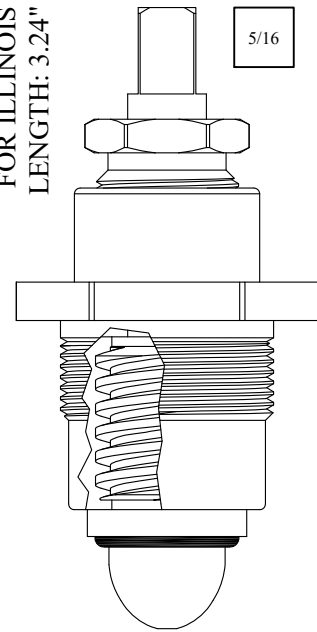

**483421**

FOR BRIGGS  
LENGTH: 3.25"

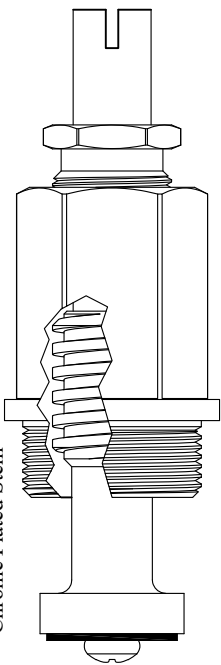

Chrome Plated Stem

GASKET INCLUDED: 895370

**402611**  
**202611** Stem Only  
OEM # 6734

FOR SAVOY  
LENGTH: 3.47"

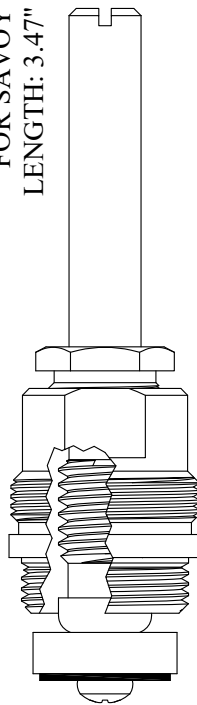

GASKET INCLUDED: 895400

**402831**  
OEM # 02-A60 (A-60)

FOR KOHLER  
LENGTH: 3.50"

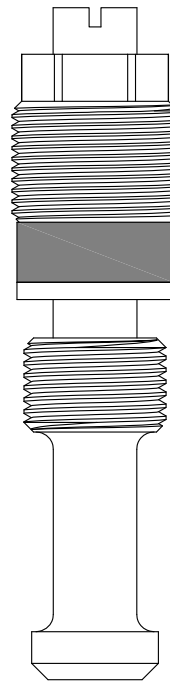

**402991**  
**202991** Stem Only

# STOP STEMS & UNITS

FOR GLAUBER WEST COAST  
STEM LENGTH: 3.65"

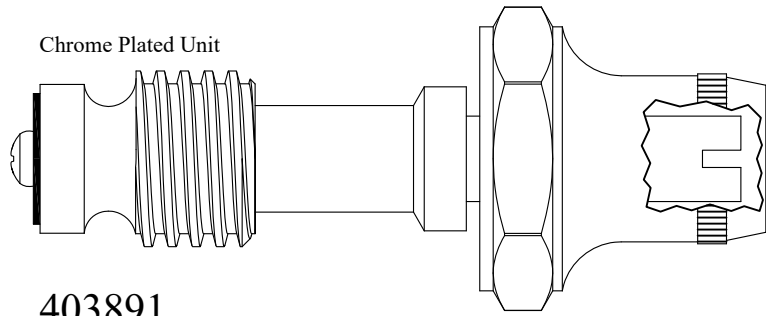

403891  
203891 Stem Only

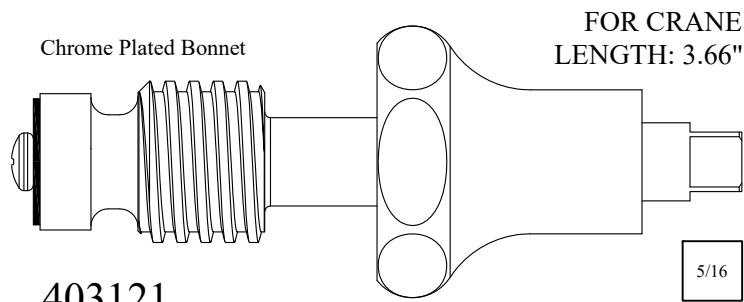

403121  
203121 Stem Only

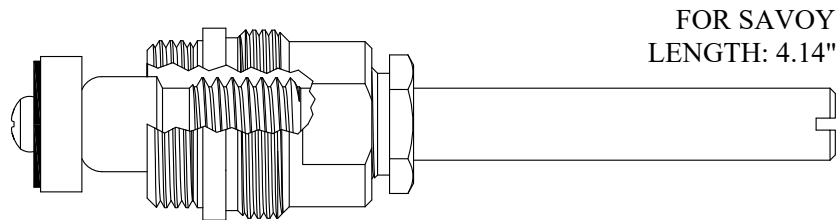

GASKET INCLUDED: 895400

405521

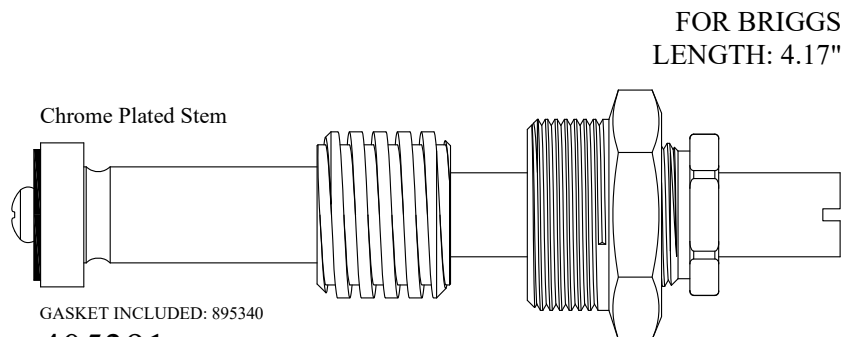

GASKET INCLUDED: 895340

405391  
205391 Stem Only

# STOP STEMS & UNITS

