

BARRY E. SR. CO.

Stems and stem units illustrated are shown actual size unless otherwise noted. Where it is necessary to illustrate stems and stem units other than actual size, the stem shank is shown as broken and the overall length is indicated.

Stem and stem units listed alphabetically by OEM. Within each OEM listing, stems and stem unit are illustrated in overall size order

Behind the stem and stem unit section of the catalog are ceramic disc stem units listed in overall size order. Most stems in this section will also be listed in their OEM sections.

Periodically Barry E. Walter Sr. Company will send out updates to replace existing pages. We will also continue to work on other sections to add to the back of the Catalog. Over time we expect to add seats with a listing of the stems and stem units that use them. Other various items will also be added, such as id gauges, handle bushings, stem extensions, tools, adapters, ballcocks, escutcheon nipples, packings, washers, o-rings, gaskets, and screws.

Order the stems or stem units needed using the part numbers shown for the illustration. Particular attention should be paid when determining if a right hand or left hand stem or stem unit is needed.

The right hand threaded stem or stem unit is generally more popular. To identify a right hand stem, hold the stem in an upright position. The appearance of the threads will be to rise from the left side of the stem to the right side, as shown below. The last number of the part number will indicate a right hand (1) or left hand (2) thread. The first number of the part number will indicate a stem only (2) or any stem unit (4). See the following chart below:

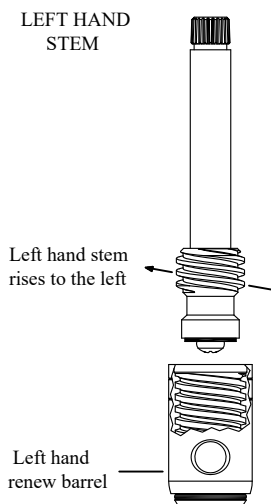

Example Part Number	First & Last Digit	Will be Identified As	Usually This Will Be
268061	2 & 1	Right hand Stem	Hot
268062	2 & 2	Left hand Stem	Cold
468061	4 & 1	Right hand Stem unit	Hot
468062	4 & 2	Left hand Stem unit	Cold

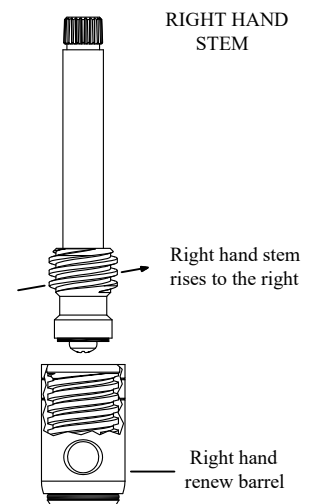

Any usage of original manufactures' names or numbers, product names, and model names or numbers on invoices, quotes, or packing slips are strictly for descriptive and identification purposes. All drawing representations or depictions of original manufactures' products in Barry E. Walter Sr. Co. catalogs or faxes are strictly for identification purposes, and are used to determine the proper Barry Walter Co. replacement part. They are not meant to imply that the parts are manufactured by the original equipment manufacturer.

FOR ACME BRASS

LENGTH: 2.88"

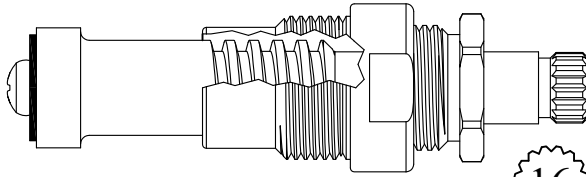

LF465301/ LF465302

GASKET INCLUDED: 895100

16
1-6

LENGTH: 4.17"

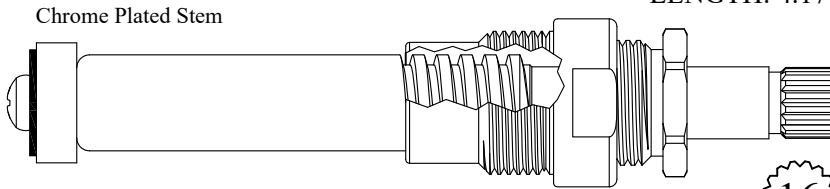

LF469801

GASKET INCLUDED: 895100

LF269801 Stem Only

16
1-6

LENGTH: 4.91"

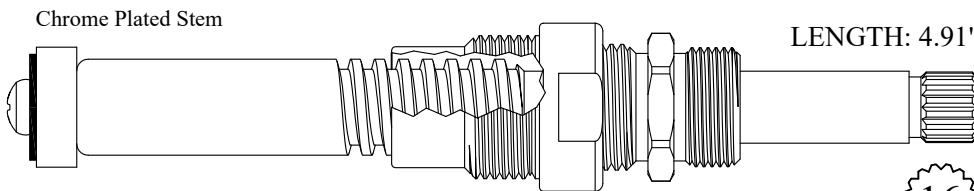

LF475001

GASKET INCLUDED: 895100

LF275001 Stem Only

16
1-6

LENGTH: 5.19"

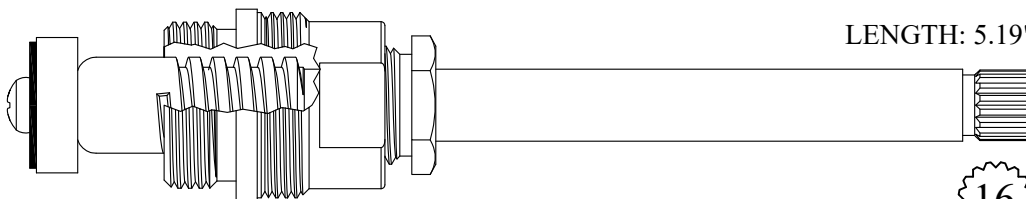

416911

GASKET INCLUDED: 895180

216911 Stem Only

16
1-6

FOR ACME BRASS

Chrome Plated Stem & Sleeve

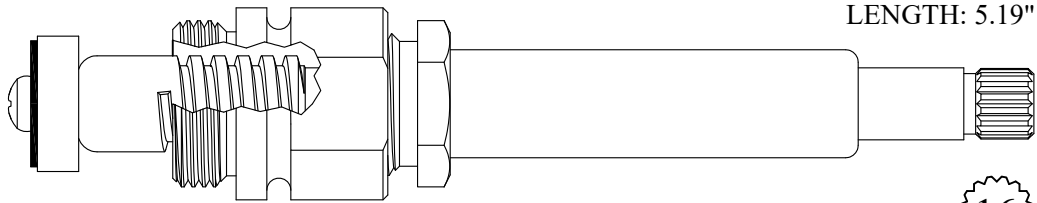

LENGTH: 5.19"

414621
GASKET INCLUDED: 895180
214621 Stem Only



Chrome Plated Sleeve

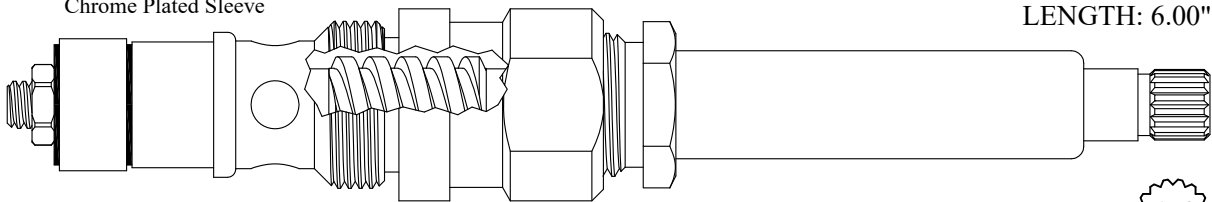

LENGTH: 6.00"

438611
GASKET INCLUDED: 895180
238611 Stem Only

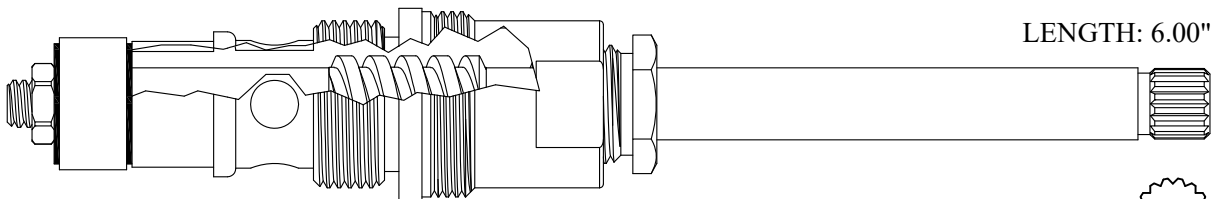

LENGTH: 6.00"

438621
GASKET INCLUDED: 895180
238611 Stem Only



FOR ACORN

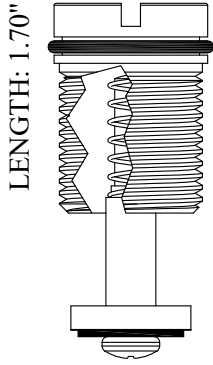

LF400190
OEM # 2415-000-001

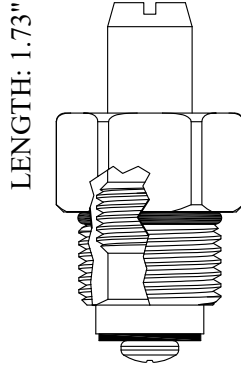

GASKET: 890160 O-RING INCLUDED

LF454071
OEM # 2755-000-002
LF254071 Stem Only
OEM # 2755-000-001

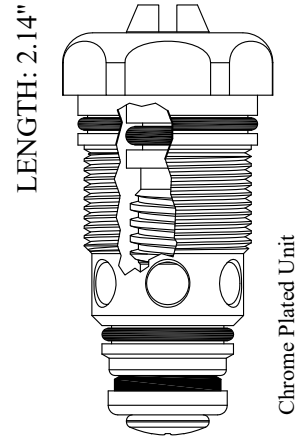

461922
OEM # 0528-000-002

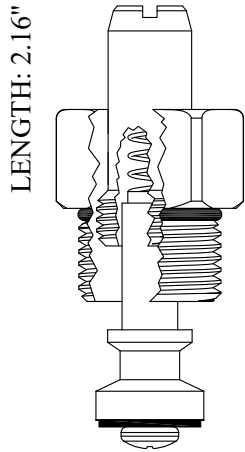

GASKET: 890160 O-RING INCLUDED

LF400571
OEM # 2755-005-002
LF200571 Stem Only
OEM # 2755-005-002

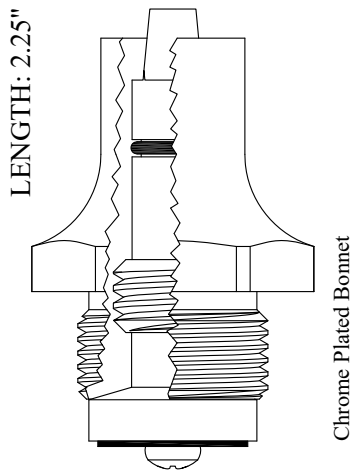

GASKET INCLUDED: 895570

483121
OEM # 0485-000-002

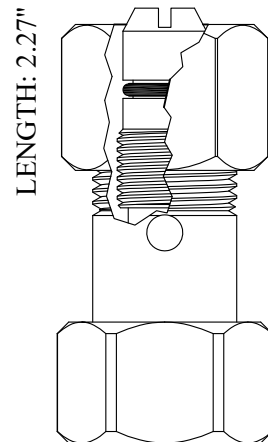

LF138921
OEM # 2366-031-001
LF136401 Stem Only
OEM # 2366-034-199

FOR ACORN

LENGTH: 2.28"

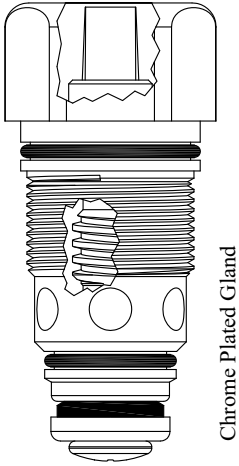

Chrome Plated Gland

462702
OEM # 0525.011.002

Also available less bonnet

LF463260
OEM # 2304-001-001

LENGTH: 2.37"

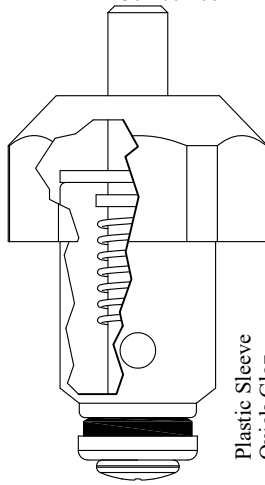

Plastic Sleeve
Quick-Cloz

LF463270
OEM # 2304-000-001

LENGTH: 2.37"

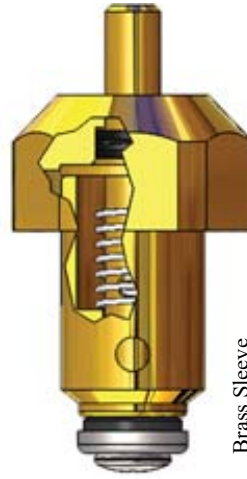

Brass Sleeve
Quick-Cloz

LF463270-B
OEM # 2304-000-001
with Brass Sleeve

LENGTH: 2.38"

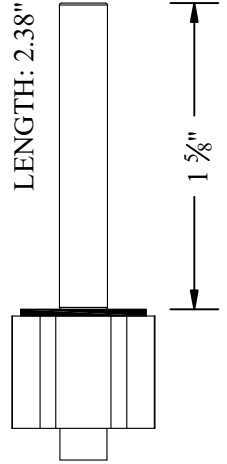

LF158310
OEM # 2358-003-001



SEAT USED: LF647560

Also available less bonnet

464542

LENGTH: 2.44"

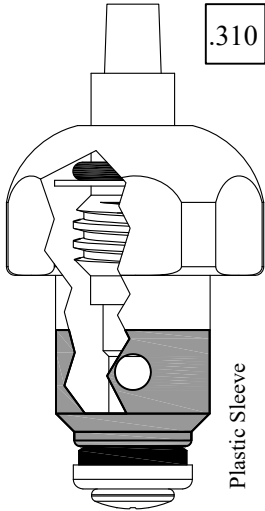

Plastic Sleeve

464552
OEM # 2260-001-003

LENGTH: 2.44"



Flo-Cloz

464582
OEM # FC611

LENGTH: 2.54"

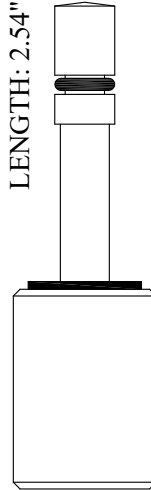

Stainless Steel Shank

LF138990
OEM # 2366-011-002



SEAT USED: LF647560

LENGTH: 2.57"

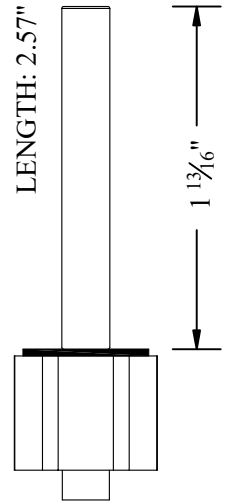

LF130680

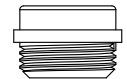

SEAT USED: LF647560

FOR ACORN

Also Available Stem & Bonnet only

LF117621

LENGTH: 2.72"

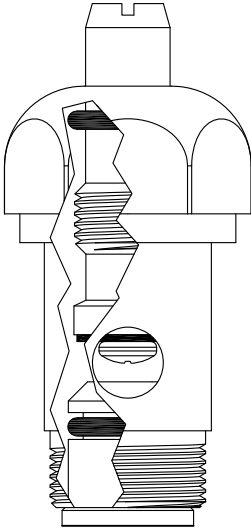

SEAT INCLUDED: LF601780
GASKET INCLUDED: 895400

LF401781

OEM # 2767-010-002

LF254071 Stem Only

OEM # 2755-000-001

Also Available without Bonnet

LF466490

OEM # 2305-011-001

LENGTH: 3.13"

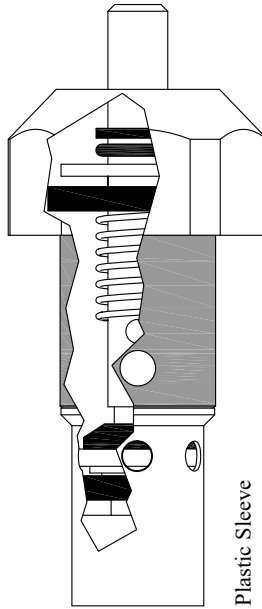

Plastic Sleeve

LENGTH: 3.24"

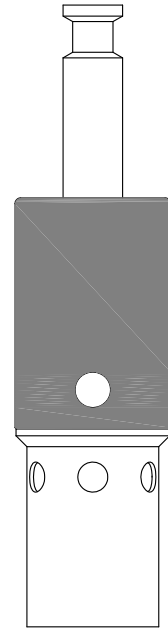

Plastic Sleeve

LF466500

OEM # ACN-2305-050-003

468490

OEM # 2305-001-001 or AC602

LENGTH: 3.65"

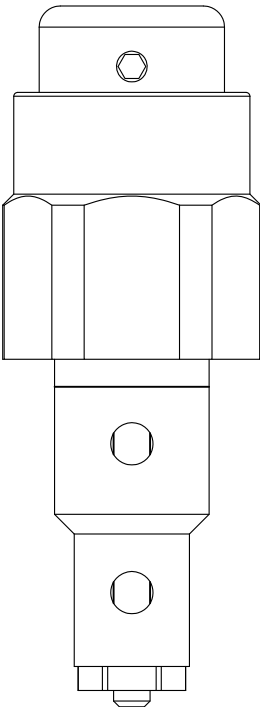

LF402880

LENGTH: 4.00"

5/16
TAPERED

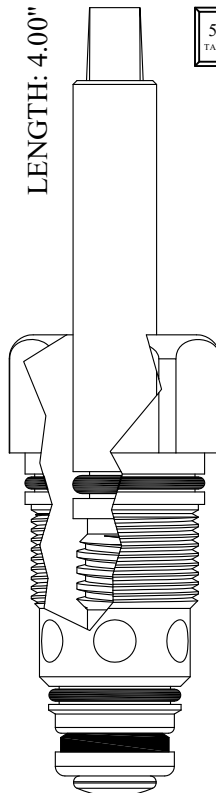

Chrome Plated Gland

469702

OEM # 0526-000-001

LENGTH: 4.00"

5/16
TAPERED

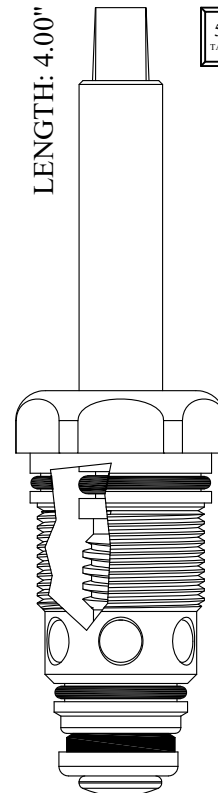

Chrome Plated Gland

469712

OEM # 0526-000-001

FOR ACORN

Plastic Sleeve

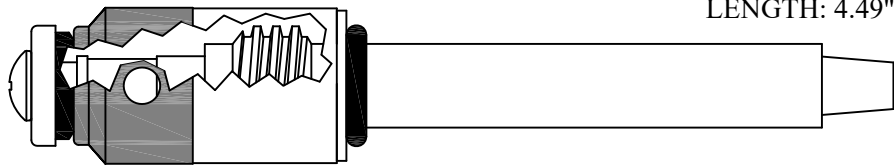

LENGTH: 4.49"

470052

270052 Stem Only

Chrome Plated Stem

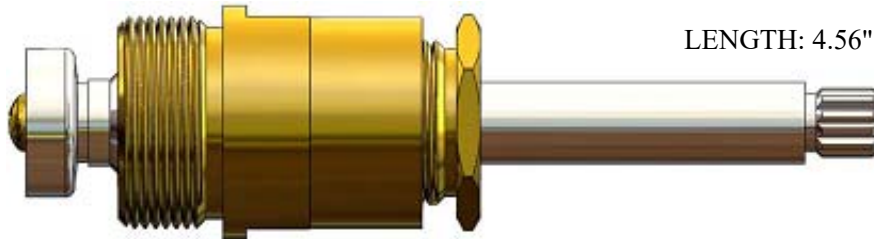

LENGTH: 4.56"

410041

GASKET INCLUDED: 894620

Symmons C-5 Spindle for Acorn

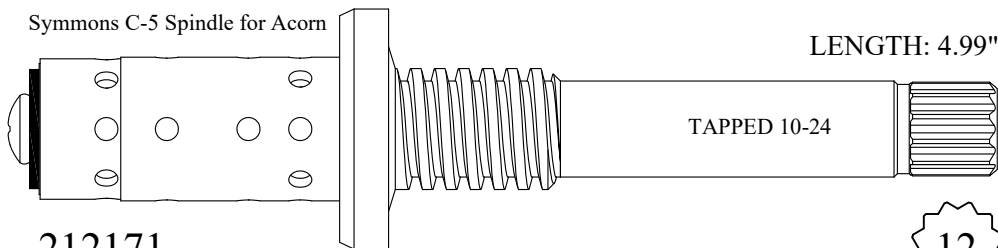

LENGTH: 4.99"

TAPPED 10-24

212171

OEM # 2450-103-199

12

Symmons Large

Stainless Steel Shank

SEAT INCLUDED:
LF647560

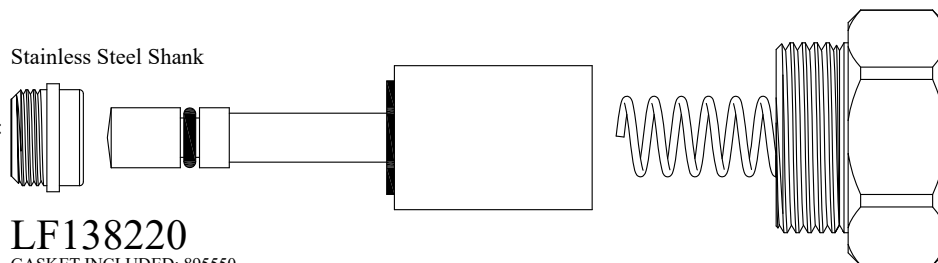

LF138220

GASKET INCLUDED: 895550

OEM # 2366-021-001

FOR ADVANCED TABCO / B & K

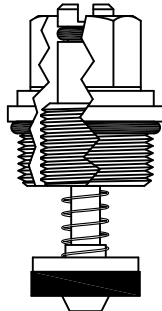

GASKET: 890170 O-RING INCLUDED

400241

Gland turns
clockwise
into valve body

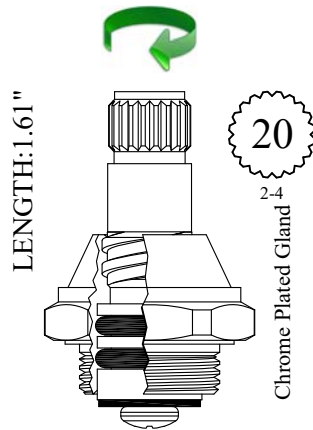

GASKET INCLUDED: 895100

LF455411
LF455412

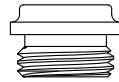

SEAT USED: LF648270

Gland turns
counter-clockwise
into valve body

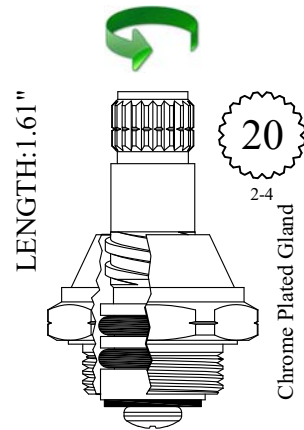

GASKET INCLUDED: 895100

LF455462

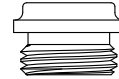

SEAT USED: LF648270

Gland turns
clockwise
into valve body



Knurled lock ring also available

952900

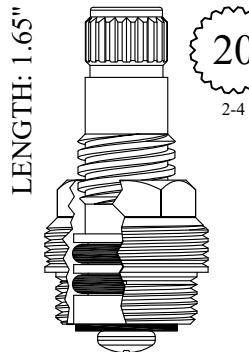
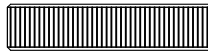

GASKET INCLUDED: 895100

LF452901
OEM # 456000007
LF452902
OEM # 456000008



SEAT USED: LF648270

Also available as chrome plated unit

LF452901-CP/ LF452902-CP

Gland turns
counter-clockwise
into valve body

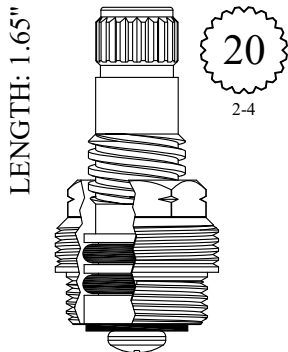

GASKET INCLUDED: 895100

LF452922

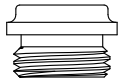

SEAT USED: LF648270

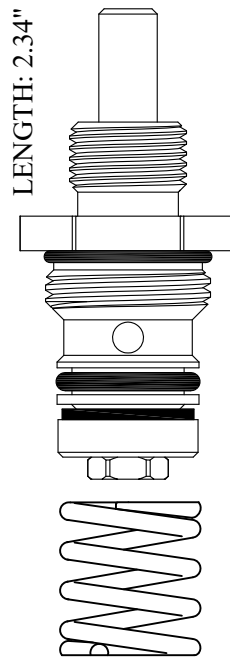

GASKET: 890180 O-RING INCLUDED

LF464450

OEM # 1061L

LF264450 Stem Only

Plastic Button

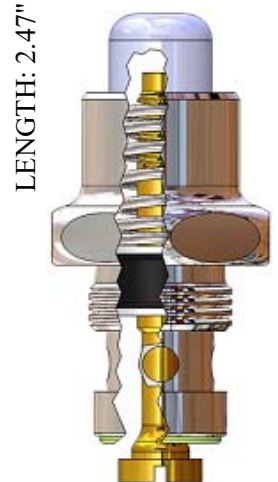

LF462300

OEM # K-01

FOR ALTMANS

FOR ALTMANS



For 6000 Series Valve Body

GASKET: 890170 O-RING INCLUDED

400551H Hot, Red

400551C Cold, Blue

OEM # 9-TH-CHECK (HOT & COLD)

FOR ALTMANS



For HF9000

GASKET: 890170 O-RING INCLUDED

400561

400561-P Pair

FOR ALTMANS



For THEXCART

GASKET: 891150 O-RING INCLUDED

400631

LENGTH: 2.45"



Push/Pull Diverter

GASKET: 890180 & 890170 O-RING INCLUDED

431730

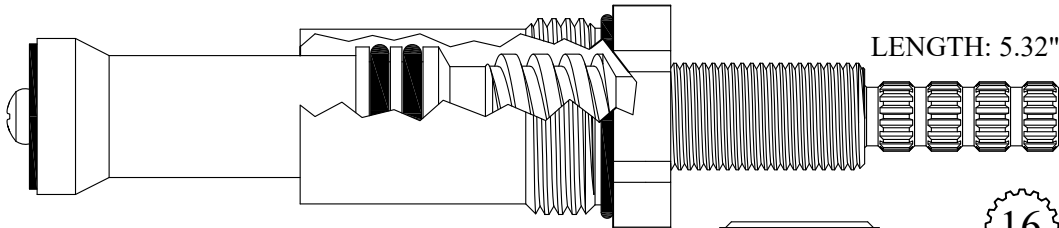

LENGTH: 5.32"

418811/ 418812

GASKET: 890210 O-RING INCLUDED
OEM # 0DC3JK / 0DC4JK

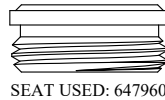

SEAT USED: 647960



16
3-16

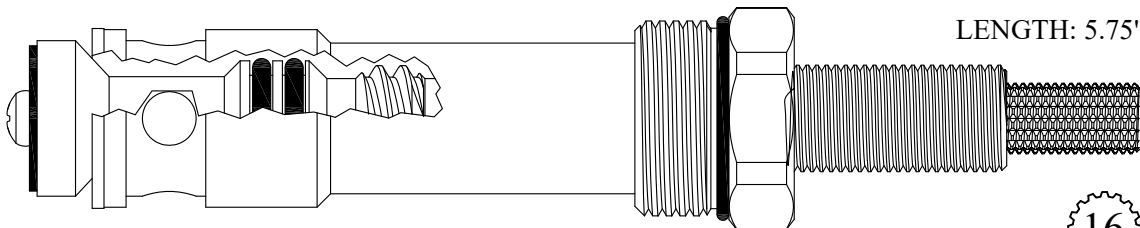

LENGTH: 5.75"

435841

GASKET: 890210 O-RING INCLUDED
OEM # ODC8JK



SEAT USED: 647960



16
3-16

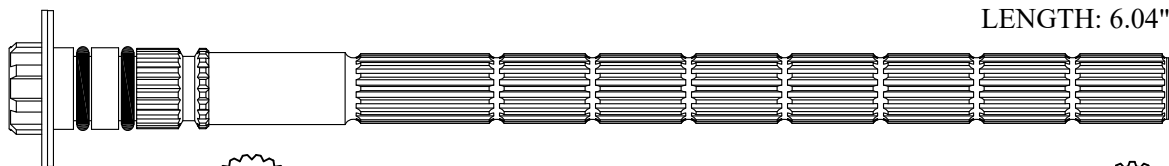

LENGTH: 6.04"

225730



20
2-4



16
3-16

FOR ALTMANS

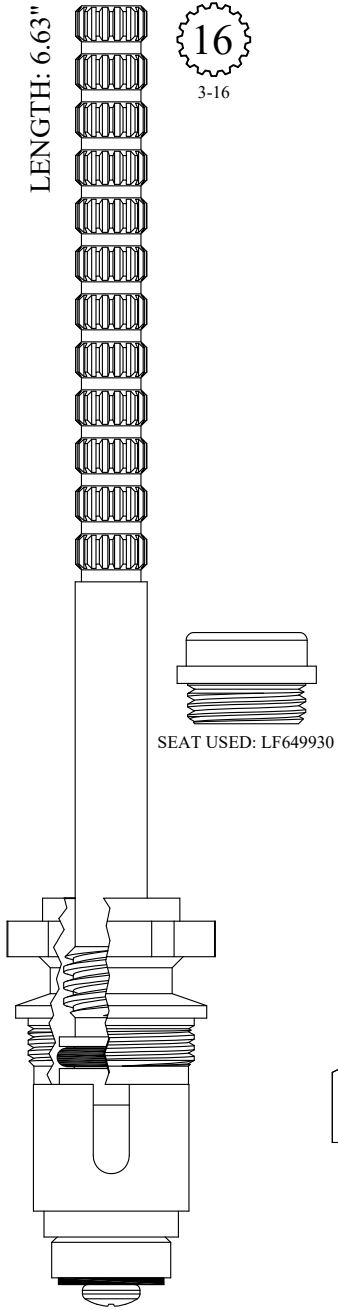

GASKET INCLUDED: 895180

439181

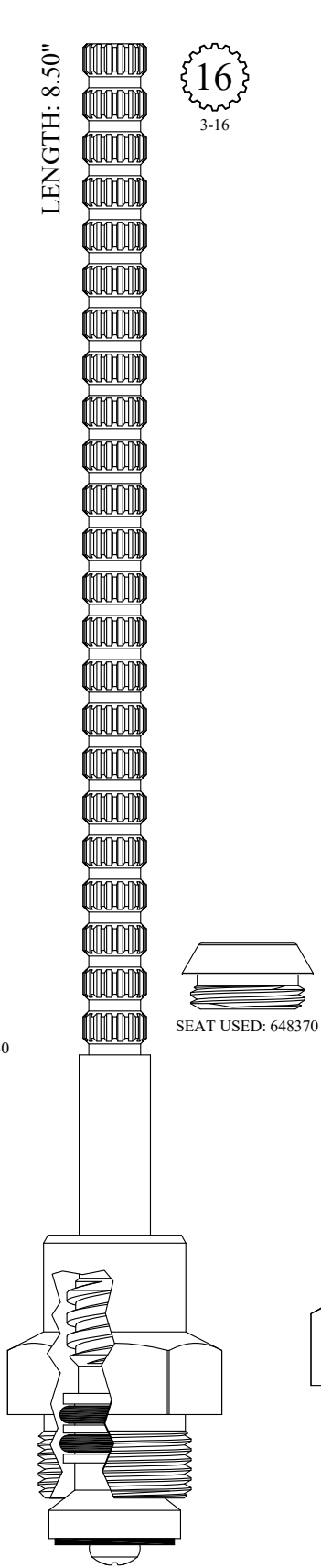

GASKET INCLUDED: 895390

428271
428272

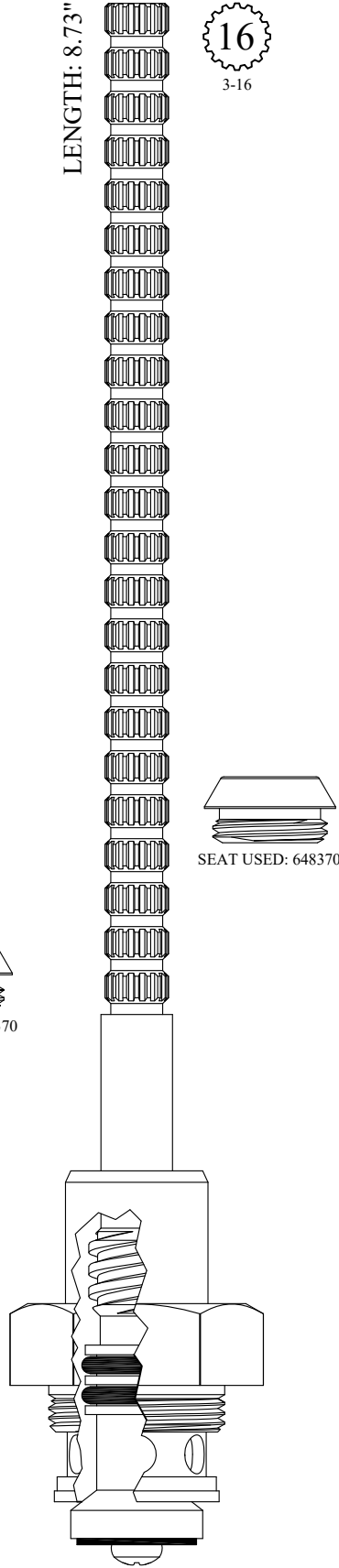

GASKET INCLUDED: 895550

439771

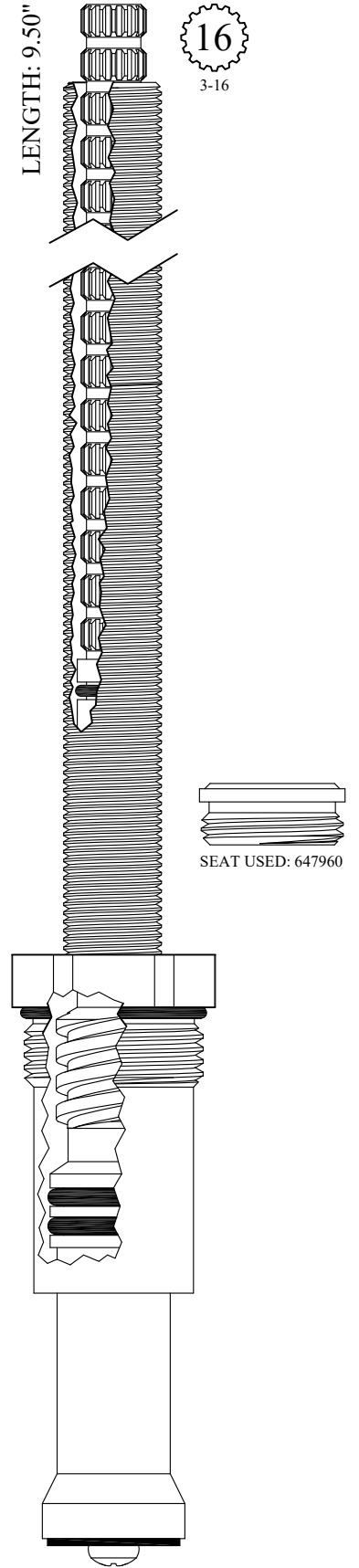

GASKET: 890210 O-RING INCLUDED

428451
428452

FOR AMERICAN BRASS

LENGTH: 1.55"

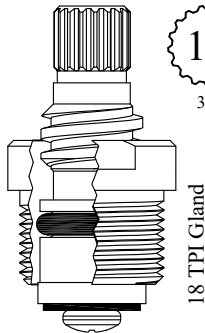

17
3-7

18 TPI Gland

GASKET INCLUDED: 895100

LF451111
LF451112

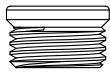

SEAT USED: LF648410

LENGTH: 1.55"

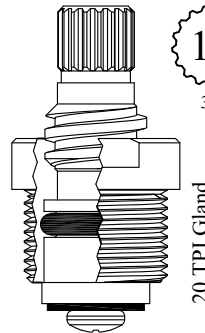

17
3-7

20 TPI Gland

GASKET INCLUDED: 895100

LF451161
OEM # 960-0
LF451162
OEM # 5-118-0 LH

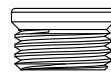

SEAT USED: LF648410

LENGTH: 1.55"

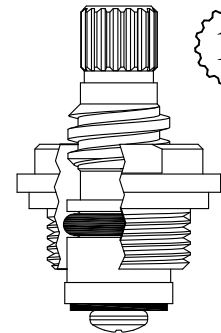

17
3-7

18 TPI Gland

GASKET INCLUDED: 895100

LF452071
LF452072

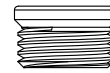

SEAT USED: LF648410

LENGTH: 2.08"

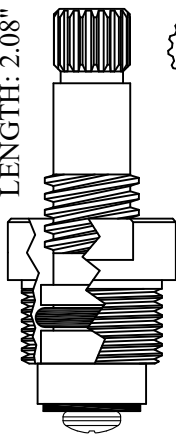

17
3-7

GASKET INCLUDED: 895100

LF458141
LF458142

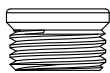

SEAT USED: LF648410

LENGTH: 2.08"

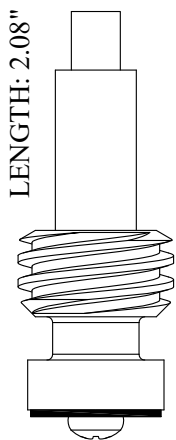

Chrome Plated Stem

LF260501

LENGTH: 2.14"

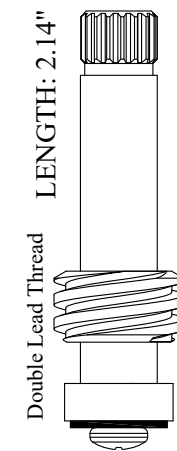

17
3-7

Double Lead Thread

Chrome Plated Stem

LF260011
LF260012

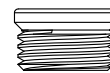

SEAT USED: LF648410

FOR AMERICAN BRASS

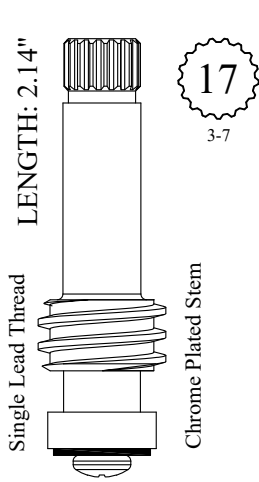

LF260211
LF260212

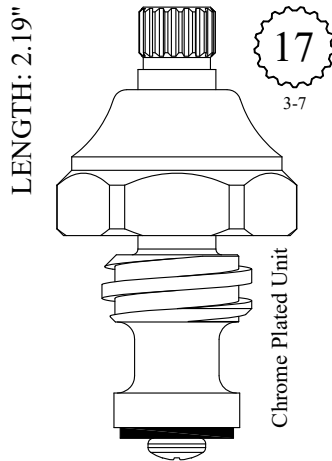

LF460241
LF460242
LF260241 Stem Only
LF260242 Stem Only

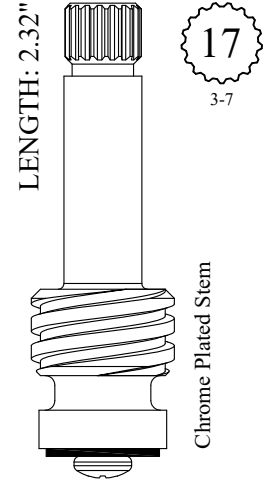

LF262021
LF262022

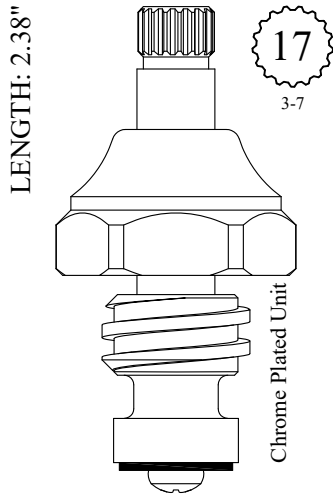
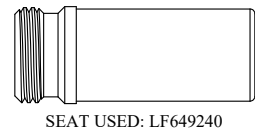

LF464211
LF464212
LF264211 Stem Only
LF264212 Stem Only

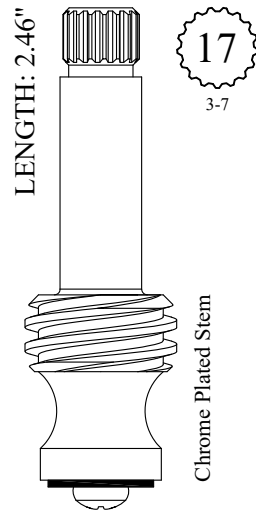

LF264271
LF264272

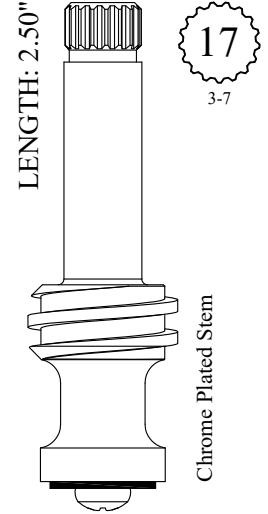

LF264261

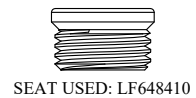

FOR AMERICAN BRASS

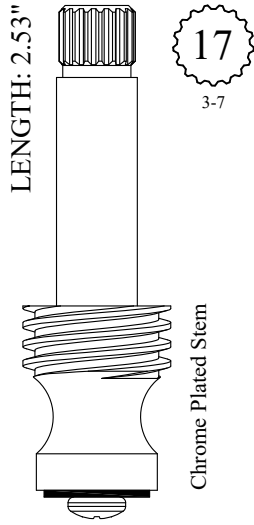

LF264291

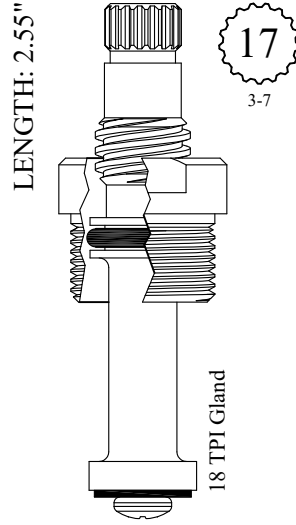

GASKET INCLUDED: 895100

LF463981
LF463982

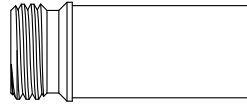

SEAT USED: LF648140

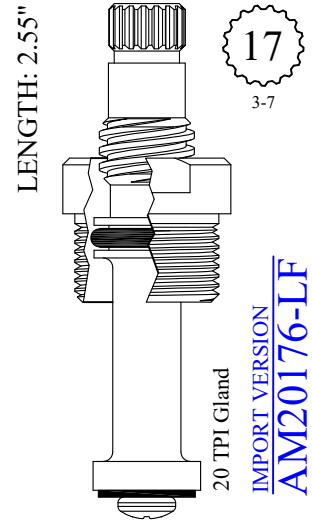

GASKET INCLUDED: 895100

LF464001
LF464002

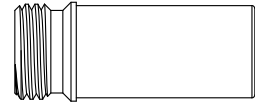

SEAT USED: LF648140

IMPORT VERSION
AM20176-LF

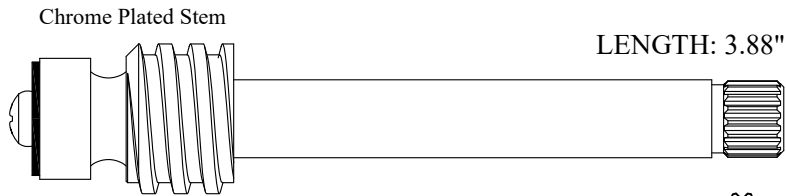

LF269161/ LF269162

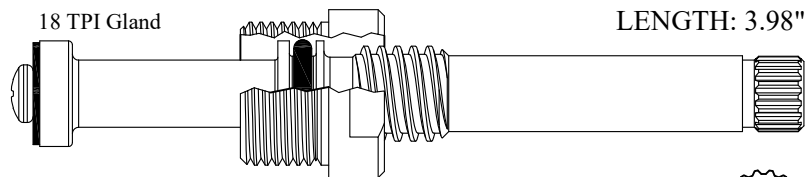

403601 / 403602

GASKET INCLUDED: 895100

17

3-7

FOR AMERICAN BRASS

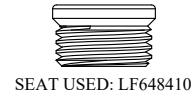
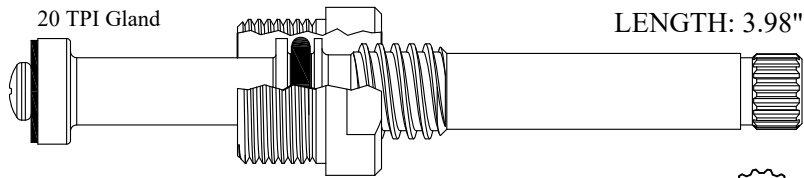

403611/ 403612
GASKET INCLUDED: 895100

17
3-7

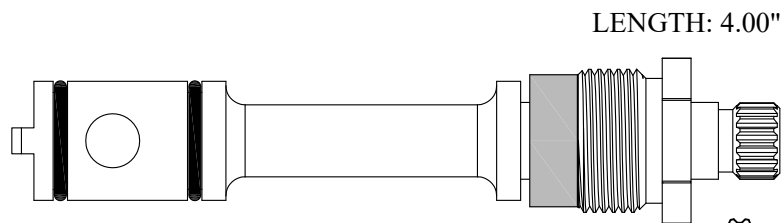

430350
230350 Stem Only

IMPORT VERSION
AM20177

17
3-7

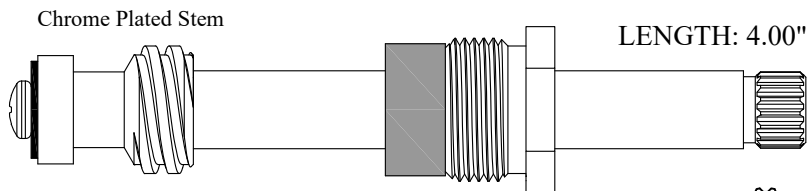

LF470021/ LF470022
LF270021/ LF270022 Stem Only

17
3-7

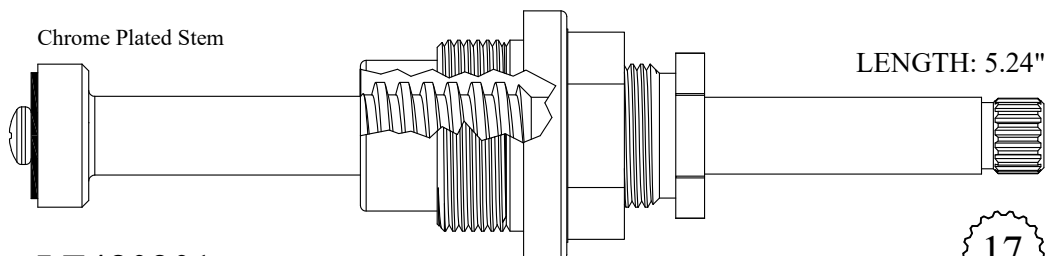

LF480201
LF280201 Stem Only
GASKET INCLUDED: 895550

17
3-7

FOR AMERICAN BRASS

Chrome Plated Stem

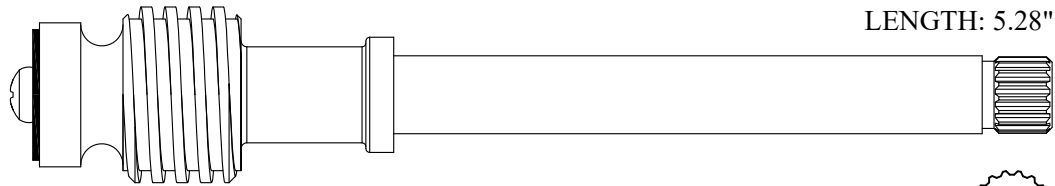

LENGTH: 5.28"

214761



Chrome Plated Stem

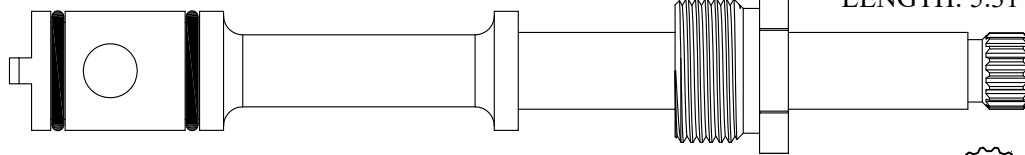

LENGTH: 5.31"

432800

232800 Stem Only



Chrome Plated Stem

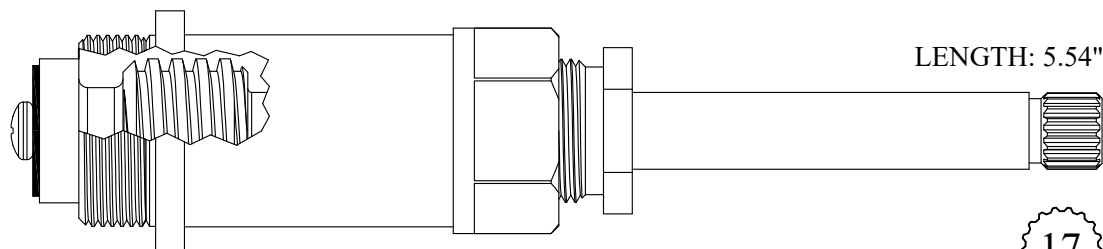

LENGTH: 5.54"

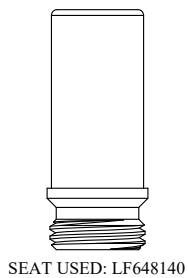

SEAT USED: LF648140

421201

GASKET INCLUDED: 895550

221201 Stem Only



FOR AMERICAN BRASS

Chrome Plated Stem

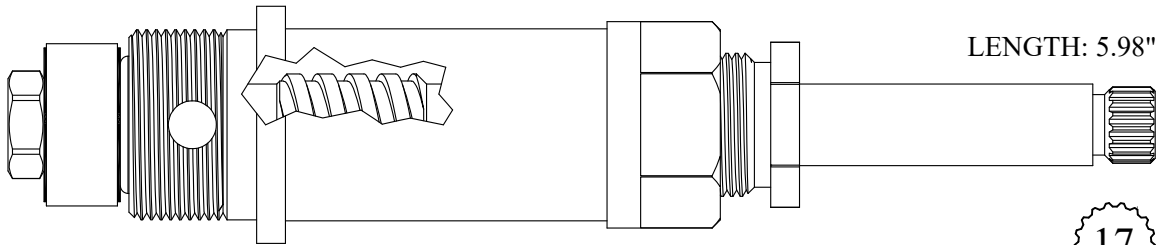

438701
GASKET INCLUDED: 895550
238701 Stem Only



Chrome Plated Stem

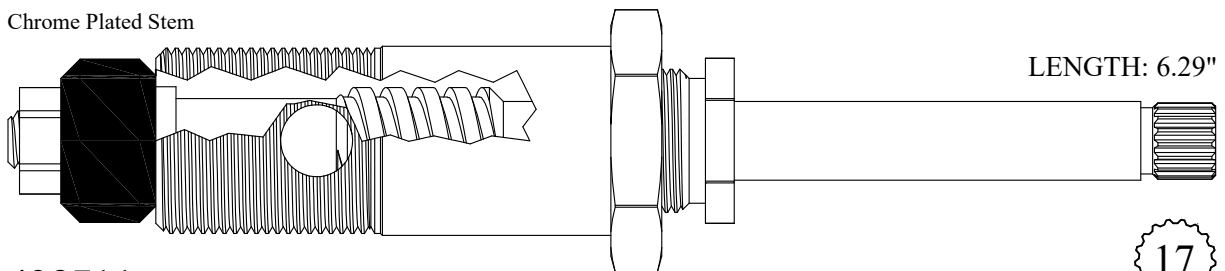

438711
GASKET INCLUDED: 895550
238711 Stem Only



BARRY E.  ALTER  SR. CO.

**Have technical questions?
Need something identified?
helpdesk@barrywalter.com
or Text: 1.970.867.3858**

**Place an order?
orderdesk@barrywalter.com
Fax: 1.800.886.9831
Phone: 1.800.767.5552**

FOR AMERICAN KITCHEN

LENGTH: 1.87"

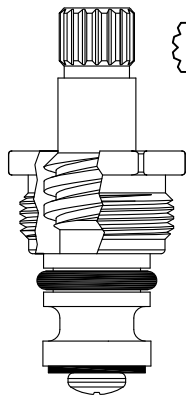

16
1-5

LF457091
LF457092

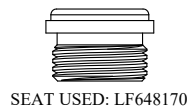

SEAT USED: LF648170

LENGTH: 1.95"



16
1-6

LF458021
LF458022
LF258021 Stem Only
OEM # 5771
LF258022 Stem Only
OEM # 5772



SEAT USED: LF647000

LENGTH: 2.54"



16
1-6

Chrome Plated Stem

LF464091
LF464092
LF264091 Stem Only
OEM # 4272
LF264092 Stem Only
OEM # 4271

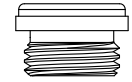

SEAT USED: LF647000

Send Your Orders To:

BARRY E.  WALTER SR. CO.

E-mail: orderdesk@barrywalter.com

Fax: 1.800.886.9831

Phone: 1.800.767.5552

FOR AMERICAN STANDARD



400481
OEM # 23566.07.007

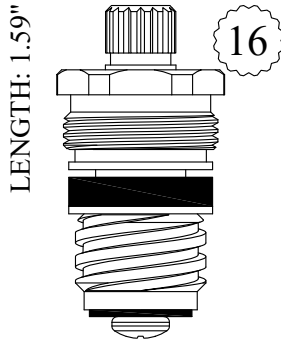

LF452011
LF452012
LF252081 Stem Only
OEM # 64803-07
LF252082 Stem Only
OEM # 50636-07

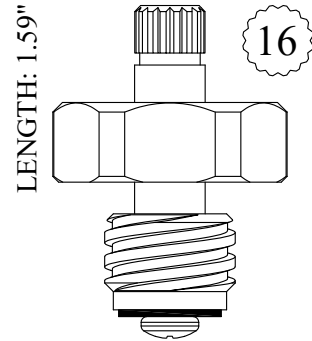

LF452081
LF452082
LF252081 Stem Only
OEM # 64803-07
LF252082 Stem Only
OEM # 50636-07

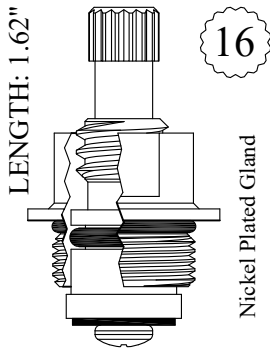

GASKET: 890160 O-RING INCLUDED

LF453041
OEM # 61268-04
LF453042
OEM # 61261-04

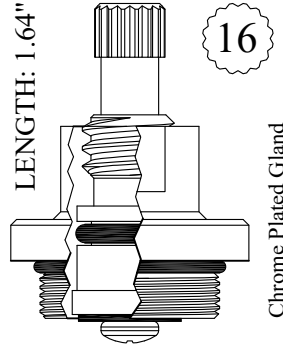

GASKET: 890200 O-RING INCLUDED

LF453141
OEM # 61509-04

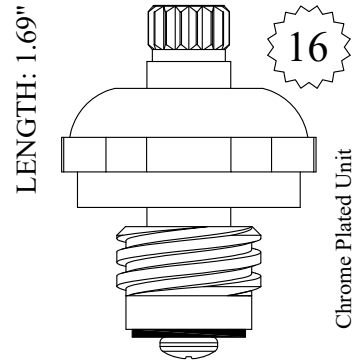

LF454011
LF454012
LF254011 Stem Only
OEM # 54156-04
LF254012 Stem Only
OEM # 54157-04



FOR AMERICAN STANDARD

Complete unit available with locknut:

LF453091-N
LF453092-N

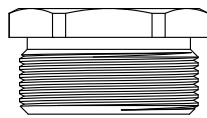

LOCKNUT
653020
IMPORT VERSION
AS10105

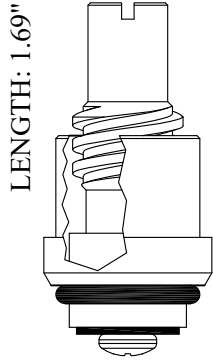

LENGTH: 1.69"

GASKET INCLUDED: 891130

453181
253181 Stem Only
OEM # 1011-14

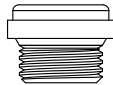

SEAT USED: LF648990

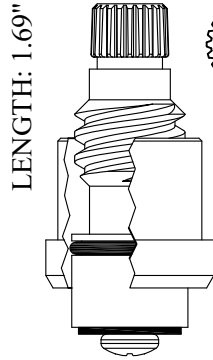

LENGTH: 1.69"

GASKET INCLUDED: 891130

LF453091
LF453092



SEAT USED: LF648990



IMPORT VERSION
AS10103-LF
AS10104-LF

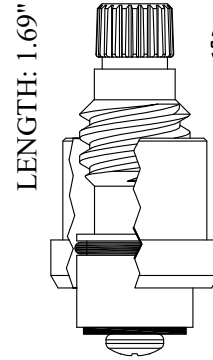

LENGTH: 1.69"

GASKET INCLUDED: 891130

LF453101
LF453102

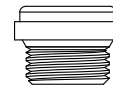

SEAT USED: LF648990



Chrome Plated Stem

Also available with stainless steel knurled ring:
LF453021-SS / LF453022-SS
Also available with locknut:
LF453021-N / LF453022-N

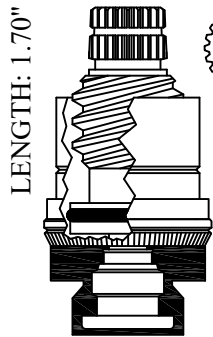
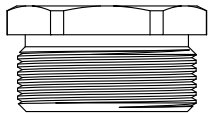

LENGTH: 1.70"

LF453021
OEM # 72950-17
LF453022
OEM # 72951-17

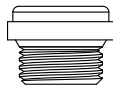

SEAT USED: LF648990



IMPORT VERSION
AS10101-LF
AS10102-LF

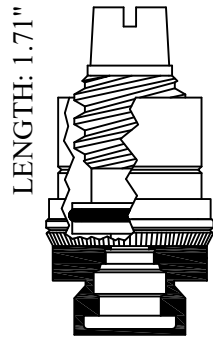

LENGTH: 1.71"

453191
OEM # 72948-04

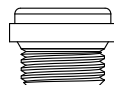

SEAT USED: LF648990

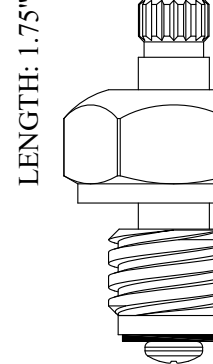

LENGTH: 1.75"

LF455081
LF455082
LF255081 Stem Only
LF255082 Stem Only
OEM # 57767-04



SEAT USED: LF648350



Chrome Plated Unit

FOR AMERICAN STANDARD

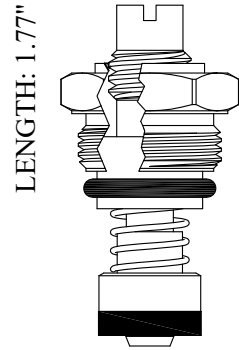
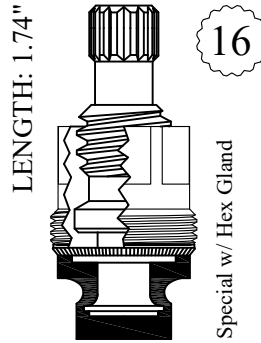

LF453001

OEM # 44261-07

LF453002

OEM # 34597-07

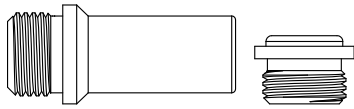

SEAT USED: LF647910 or LF649650

452991



SEAT USED: LF647910 or LF649650

400171

OEM # 10527-0070A

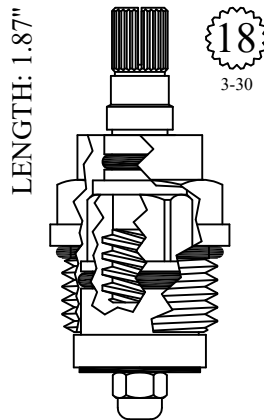
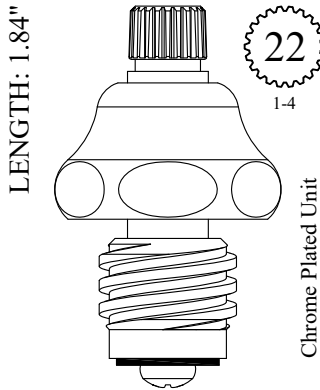

GASKET: 890180 O-RING INCLUDED

LF456302

OEM # 29352-07

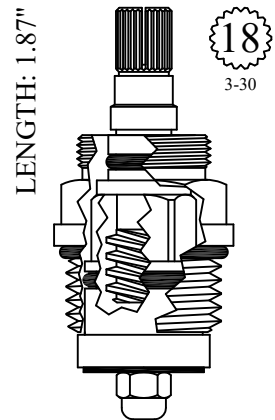

GASKET: 890180 O-RING INCLUDED

LF456312

LF456021

LF456022

LF256021 Stem Only

OEM # 25535-02

LF256022 Stem Only

OEM # 25536-02



SEAT USED: LF648220

FOR AMERICAN STANDARD

LENGTH: 1.91"

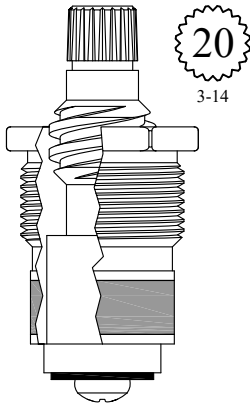

LF457101

OEM # 7616-07

LF457102

OEM # 7617-07

LF257101 Stem Only

OEM # 712-27

LF257102 Stem Only

OEM # 711-17



SEAT USED: LF648220

LENGTH: 1.95"

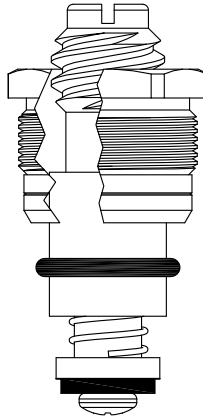

400591

200591 Stem Only

OEM # 25318-07

LENGTH: 1.96"



257351

LENGTH: 2.11"

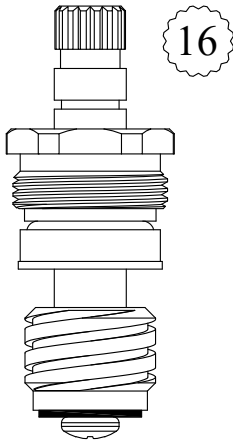

LF459121

LF459122

LF259121 Stem Only

OEM # 64702-07

LF259122 Stem Only

OEM # 50669-07



SEAT USED: LF648350

LENGTH: 2.12"

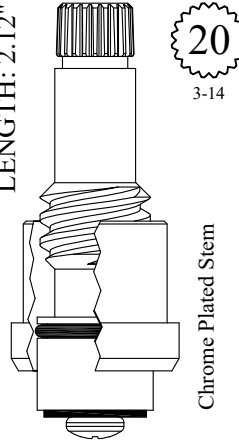

GASKET INCLUDED: 891130

LF460121

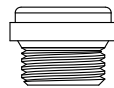

SEAT USED: LF648990

LENGTH: 2.13"

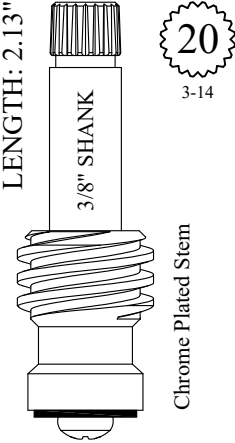

USES BARREL: LF647021/LF647022

LF260031

OEM # 19249-02

LF260032

OEM # 19449-02

FOR AMERICAN STANDARD

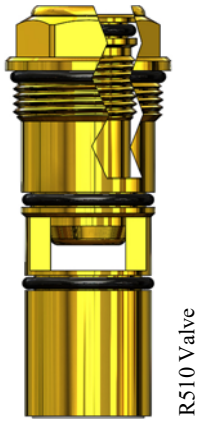

R510 Valve

GASKET: 890170 O-RING INCLUDED

400540H
OEM # 953951-0070a

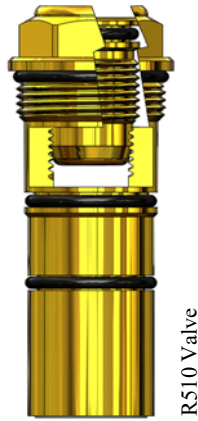

R510 Valve

GASKET: 890170 O-RING INCLUDED

400540C
OEM # 953950-007a

LENGTH: 2.13"

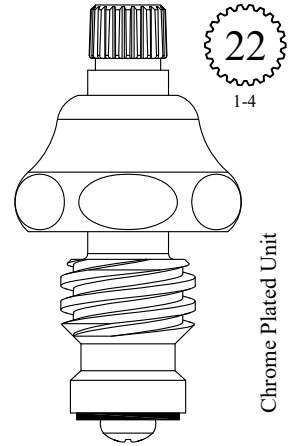

Chrome Plated Unit

LF460021
LF460022
LF260021 Stem Only
OEM # 63377-04
LF260022 Stem Only
OEM # 63378-04

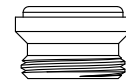

SEAT USED: LF648360

LENGTH: 2.25"

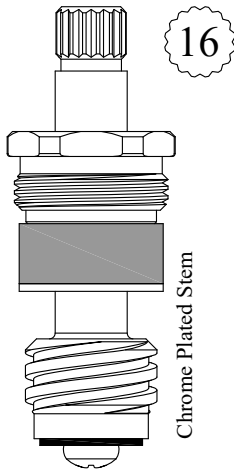

Chrome Plated Stem

LF461091
LF461092
LF261091 Stem Only
OEM # 55546-04
LF261092 Stem Only
OEM # 55547-04

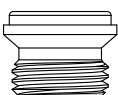

SEAT USED: LF648350

STEM LENGTH: 2.25"

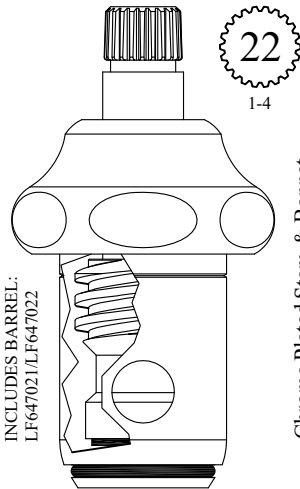

Chrome Plated Stem & Bonnet

INCLUDES BARREL:
LF647021/LF647022

GASKET: 861020 INCLUDED

LF461021
LF461022
LF261021 Stem Only
OEM # 63381-04 or 63377-04
LF261022 Stem Only
OEM # 63375-04 or 21451-02

LENGTH: 2.28"

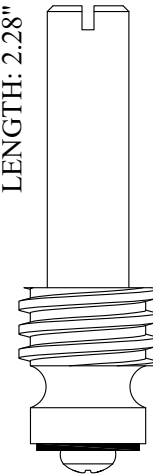

Nickel Plated Stem

261131
OEM # 19422-07 or 31290-07

FOR AMERICAN STANDARD

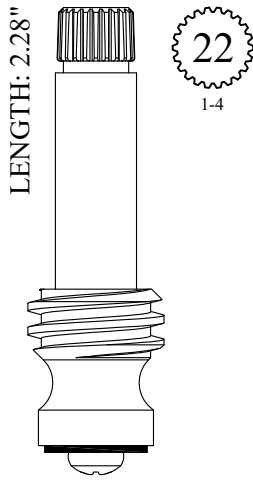

263281
OEM # 63370-04

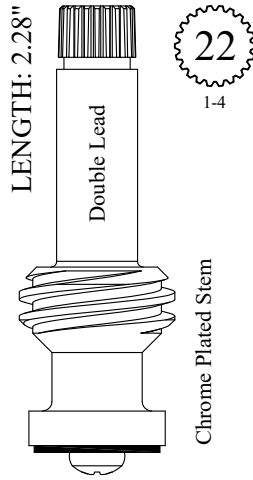

LF263231
OEM # 31286-04
LF263232

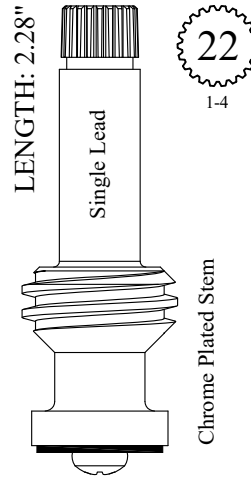

LF263241
OEM # 63372-04

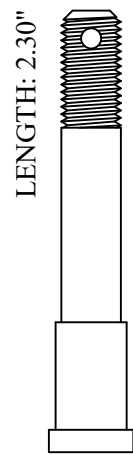

LF261120
OEM # 1710-07

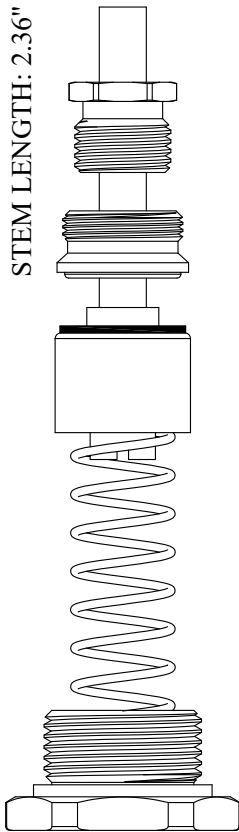

SEAT INCLUDED: LF649870

LF152150 Stem Only
LF124660 Repair Kit
OEM # 66298-0070A

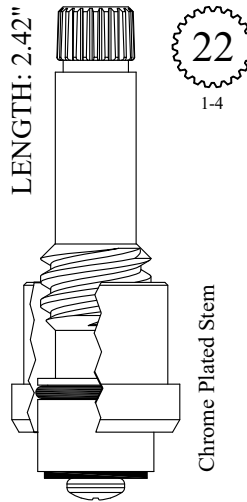

GASKET: 891130 O-RING INCLUDED

LF464011
OEM # 703-24
LF464012
OEM # 702-34

LF264011 Stem Only
LF264012 Stem Only



SEAT USED: LF648990

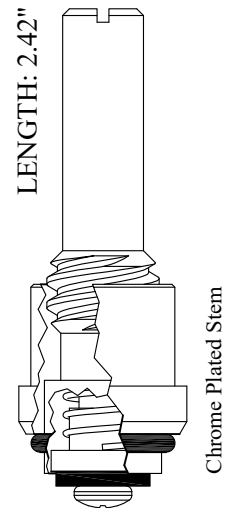

464221
OEM # 521-34
264221 Stem Only
OEM # 25317-04



SEAT USED: LF648990

FOR AMERICAN STANDARD

FOR AMERICAN STANDARD



Hot, Red R530 3/4" Valve

GASKET: 8911300-RING INCLUDED

400580H
OEM # A953972-0070A

FOR AMERICAN STANDARD



Cold, Blue R530 3/4" Valve

GASKET: 8911300-RING INCLUDED

400580C
OEM # A953971-0070A

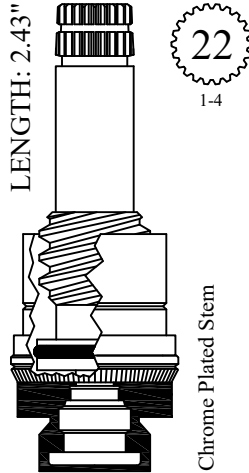

LENGTH: 2.43"

22
1/4

Chrome Plated Stem

LF463131
OEM # 72971-04
LF463132
OEM # 72977-04

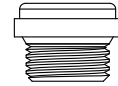

SEAT USED: LF648990

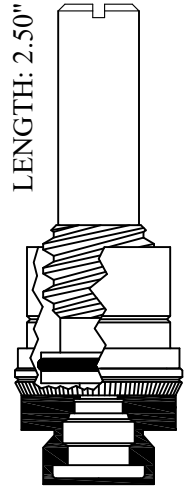

LENGTH: 2.50"

401551
OEM # 72964-04

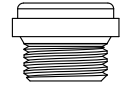

SEAT USED: LF648990

Chrome Plated
Escutcheon Holder
also available:
Part #: 901550

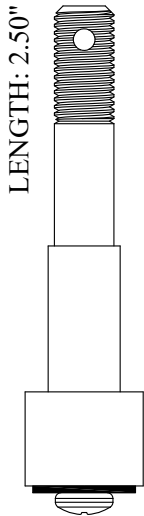

LENGTH: 2.50"

LF264300
OEM # 5026-07

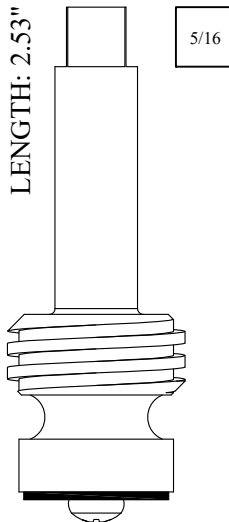

LENGTH: 2.53"

5/16

264851
OEM # 31281-05

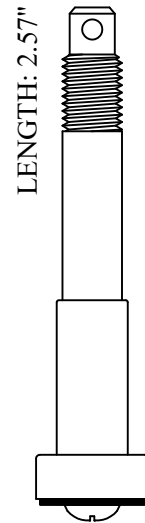

LENGTH: 2.57"

LF264250
OEM # 21189-07 or 63374-07

FOR AMERICAN STANDARD

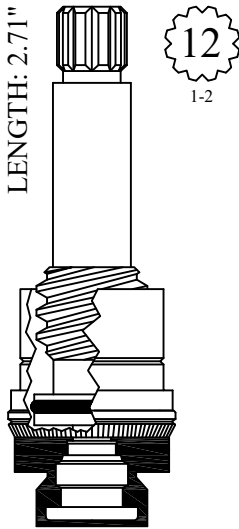

LF464901
LF464902



SEAT USED: LF648990

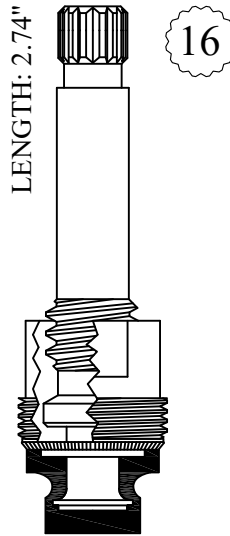

401631
401632

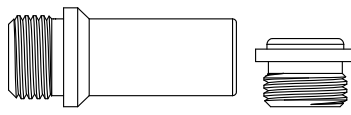

SEAT USED: LF647910 or LF649650

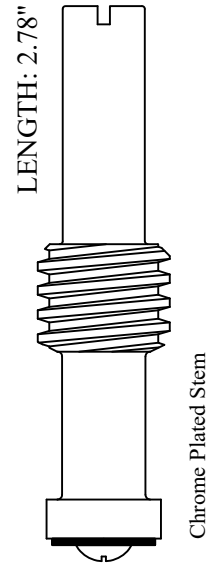

201711
OEM # 21183-02

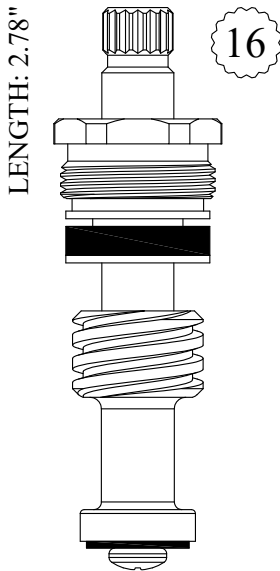

LF465101
LF465102
LF265101
OEM # 64859-07
LF265102
OEM # 64865-07



SEAT USED: LF648350

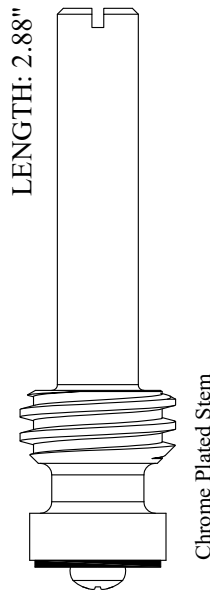

265611
OEM # 31347-05

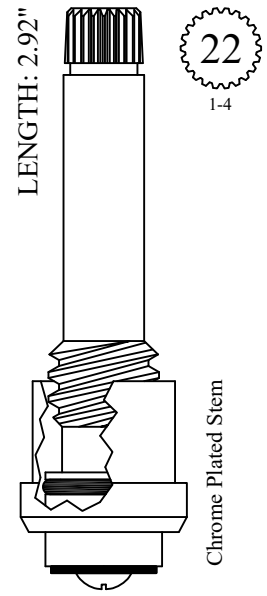

GASKET INCLUDED: 891130

LF466041
LF466042

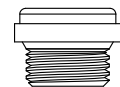

SEAT USED: LF648990

FOR AMERICAN STANDARD

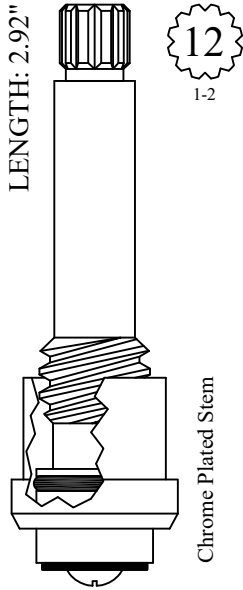

GASKET: 891130 O-RING INCLUDED

LF466141
LF466142

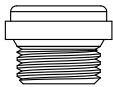

SEAT USED: LF648990

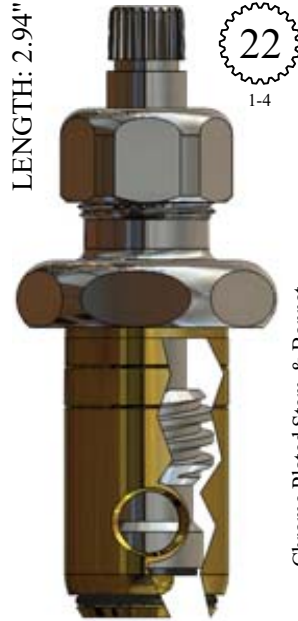

INCLUDES BARREL: LF647021/ LF647022

LF466171
LF466172
LF266171
OEM # 31295-04
LF266172
OEM # 31309-04

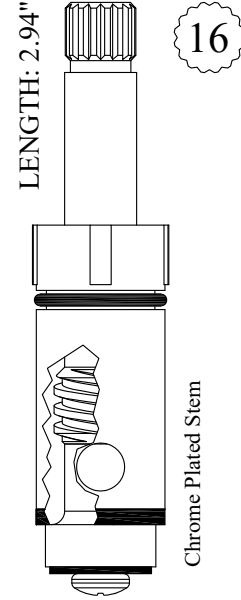

430442
OEM # 066285-0070A

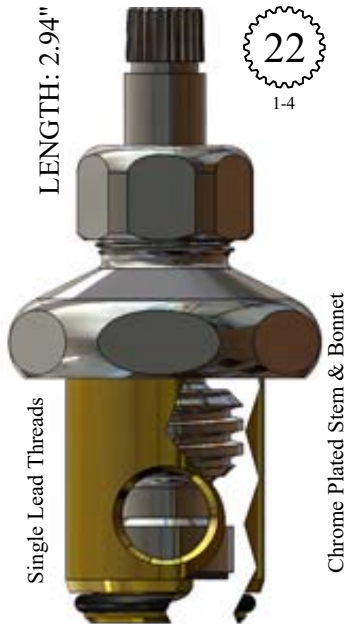

INCLUDES BARREL: LF647031

LF466031
LF266031 Stem Only
OEM # 31284-04

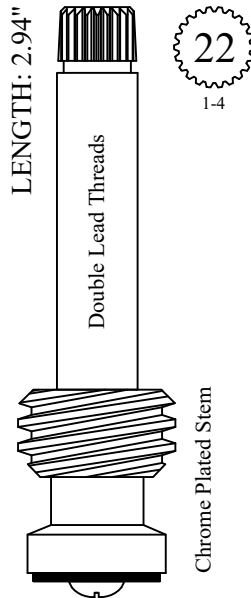

USES BARREL: LF647041/ LF647042

LF266151
OEM # 21289-02 or 31305-04
LF266152
OEM # 21290-07 or 31306-04

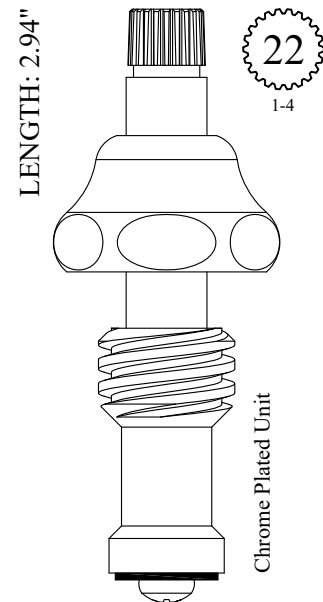

LF466081
LF266081
OEM # 21883-02 or 31322-04

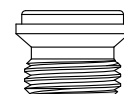

SEAT USED: LF648350

FOR AMERICAN STANDARD

Also available with locknut:
LF466011-N / LF466012-N

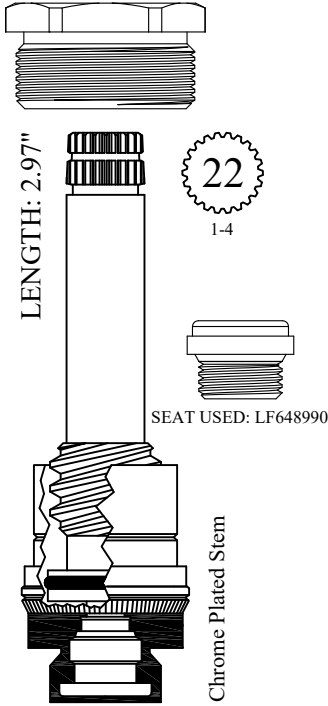

LF466011
OEM # 72978-04
LF466012
OEM # 72980-04

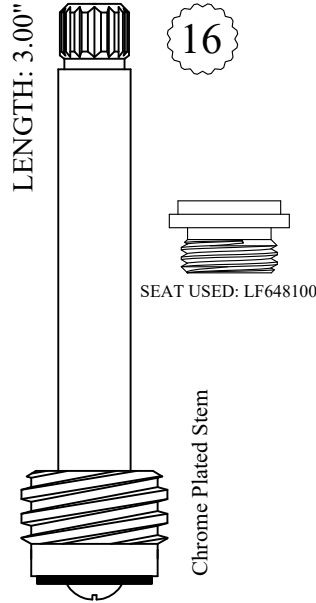

LF266071
OEM # 56628-04
LF266072
OEM # 56629-04

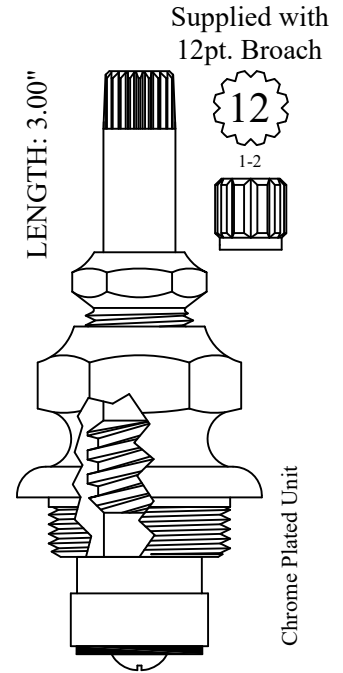

LF466301

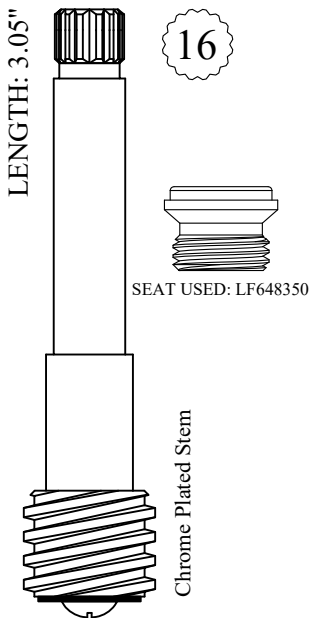

LF267021
OEM # 55838-04
LF267022
OEM # 55839-04

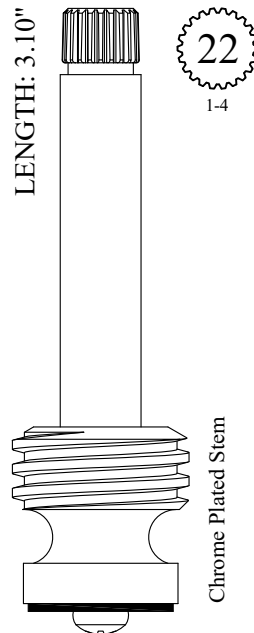

LF266381
OEM # 31285-04
LF266382

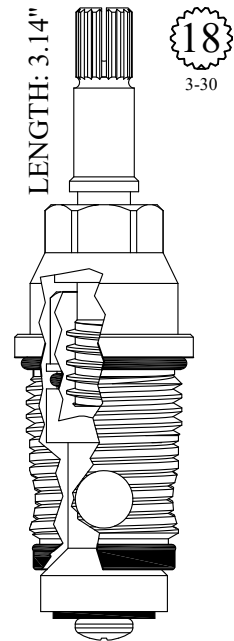

430022
OEM # 954559-0070A

GASKET: 890170 O-RING INCLUDED

FOR AMERICAN STANDARD

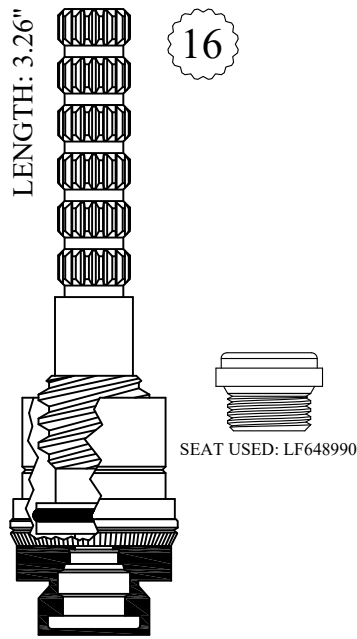

402321
 402322
 202321 Stem Only
 202322 Stem Only

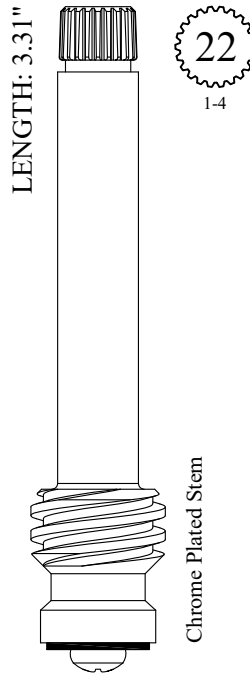

LF268041
 LF268042

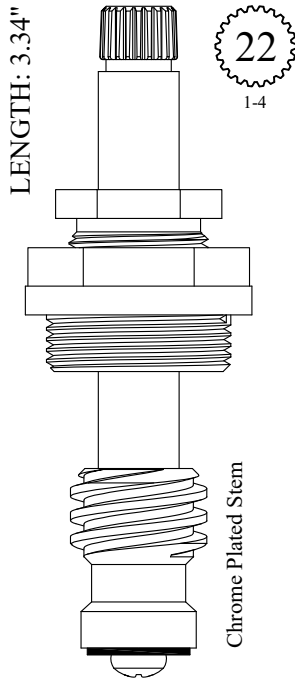

GASKET INCLUDED: 818010

LF468261
 LF468262
 LF268061 Stem Only
 OEM # 21195-02 or 31301-04
 LF268062 Stem Only
 OEM # 21668-02 or 31312-04

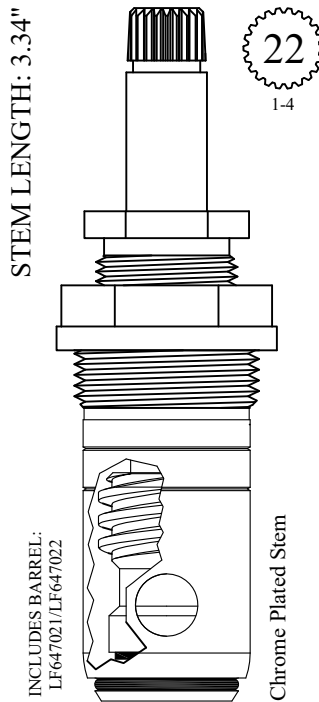

GASKET INCLUDED: 818010

LF468061
 OEM # 14145-02
 LF468062
 OEM # 14146-02
 LF268061 Stem Only
 OEM # 21195-02 or 31301-04
 LF268062 Stem Only
 OEM # 21668-02 or 31312-04

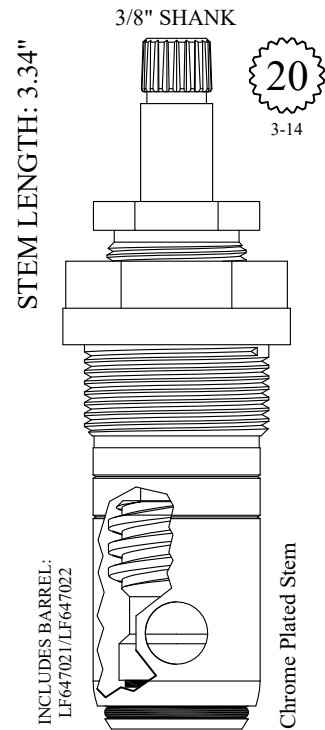

GASKET INCLUDED: 818010

LF468701
 LF468702
 LF268701 Stem Only
 LF268702 Stem Only

FOR AMERICAN STANDARD

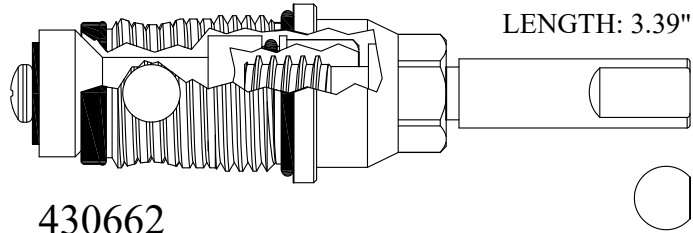

430662
OEM # 950070-0070A

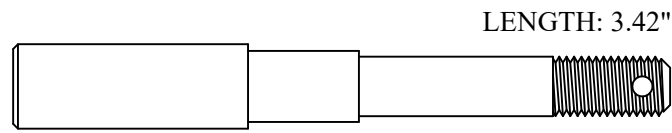

LF268300
OEM # 1711-07

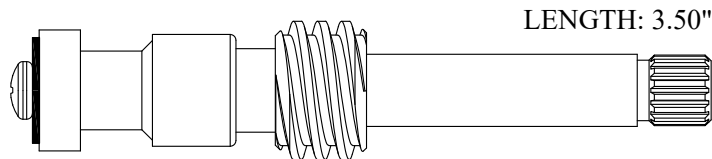

LF268121

12
1-2

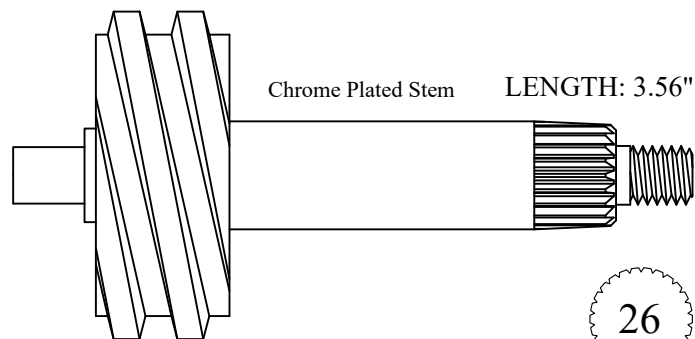

203131
OEM # 27212-02

26

FOR AMERICAN STANDARD

STEM LENGTH: 3.56"

Chrome Plated Stem

INCLUDES BARREL:
LF647021/LF647022

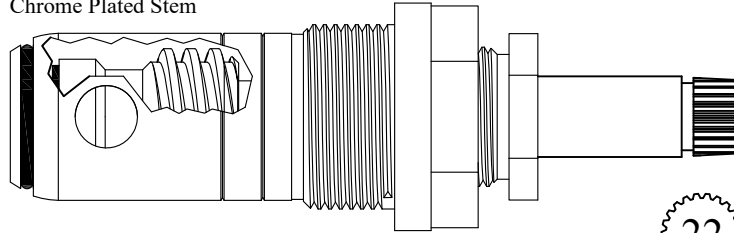

LF468081/ LF468082

GASKET INCLUDED: 818010

OEM # 4782-02

LF268081/ LF268082 Stem Only

OEM # 19376-04 or 32188-04/ 21453-02 or 31310-04

LENGTH: 3.57"

Chrome Plated Unit

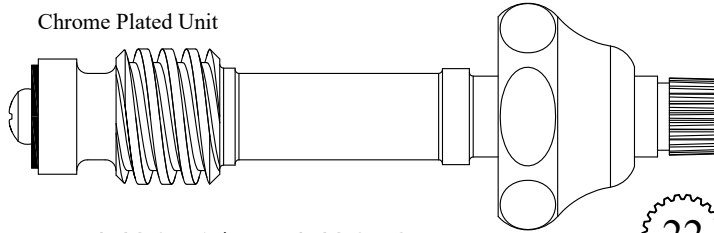

LF468071/ LF468072

LF268071/ LF268072 Stem Only

OEM # 21705-02/ 21706-02

LENGTH: 3.59"

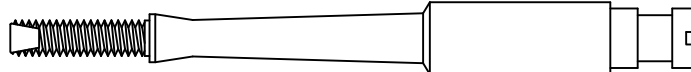

LF268310

OEM # 22983-07

LENGTH: 3.60"

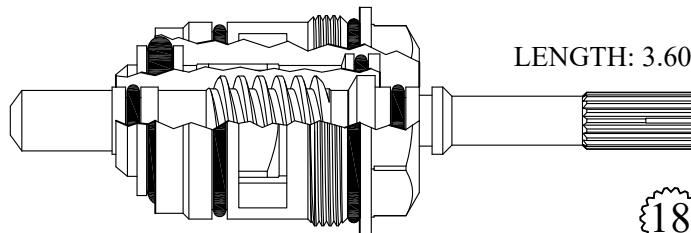

431681

GASKET: 890210 O-RING INCLUDED

OEM # 28647-0070A

FOR AMERICAN STANDARD

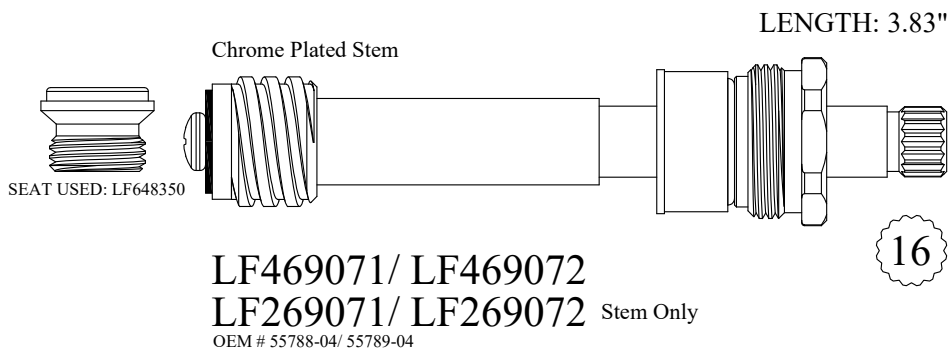
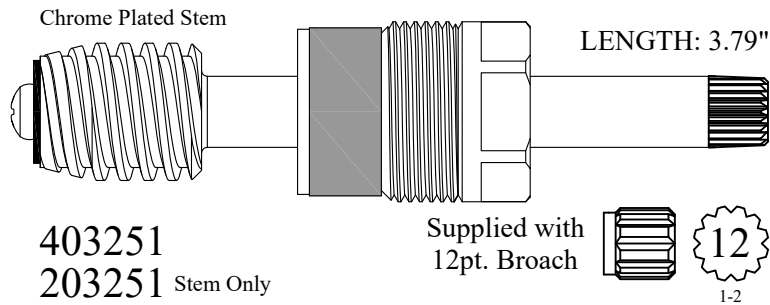
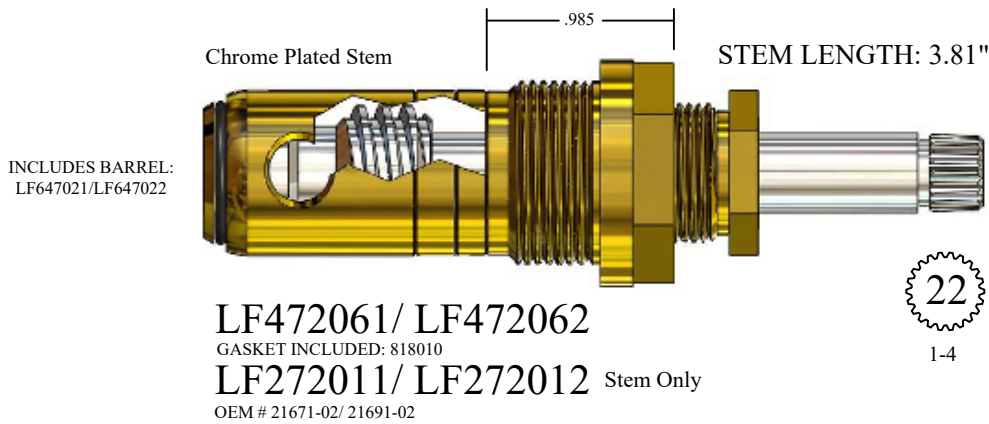
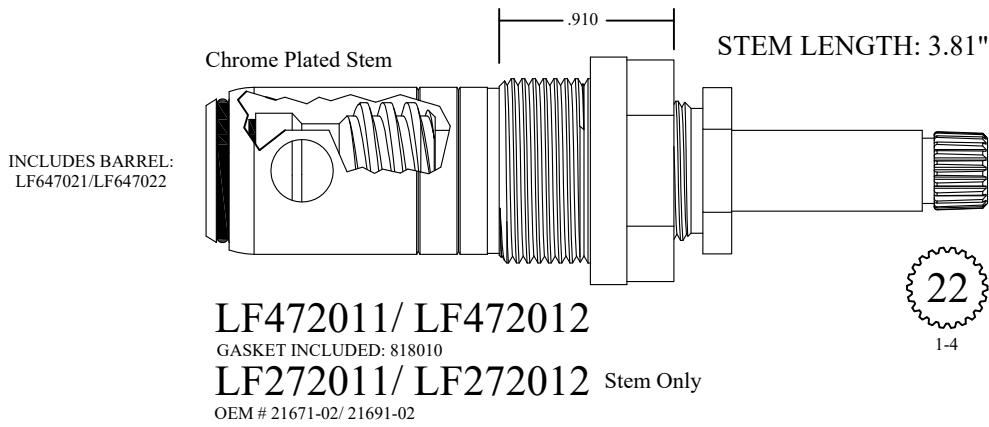

FOR AMERICAN STANDARD

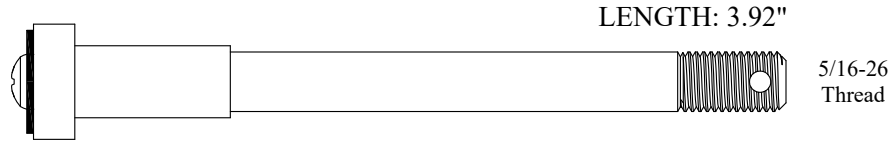

LF270030
OEM # 31331-07

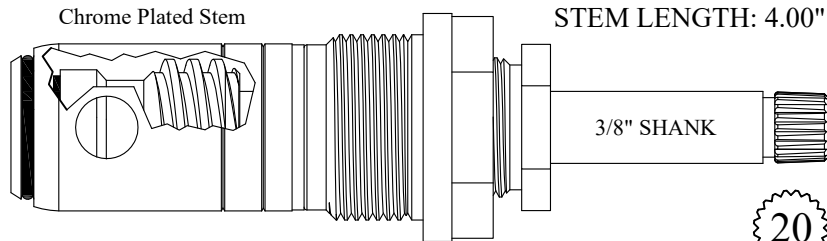

INCLUDES BARREL:
LF647021/LF647022

LF470201/ LF470202

GASKET INCLUDED: 818010

LF270201/ LF270202 Stem Only

OEM # 19348-02



LF470231/LF470232

LF270201/ LF270202 Stem Only

OEM # 19348-02

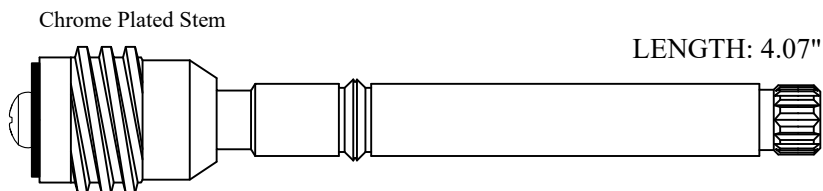

LF271021/ LF271022

OEM # 56618-04/ 56619-04



FOR AMERICAN STANDARD

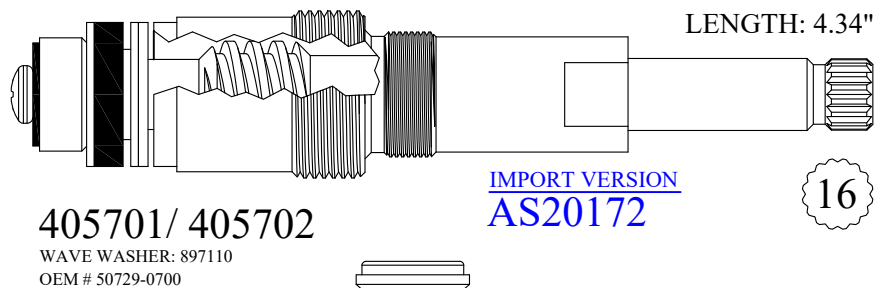
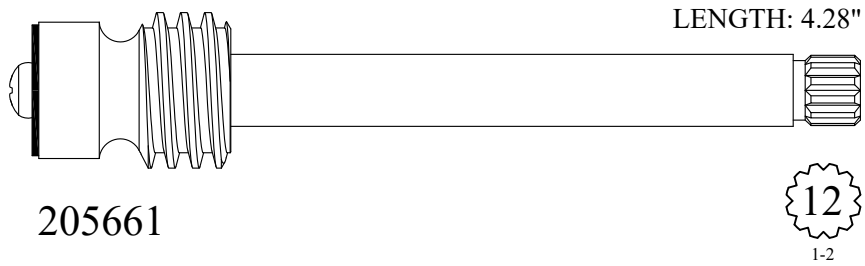
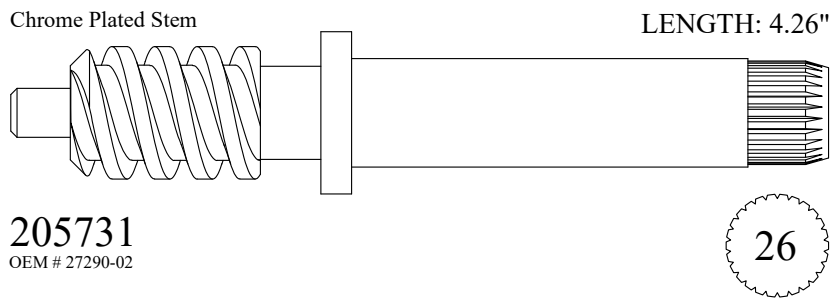
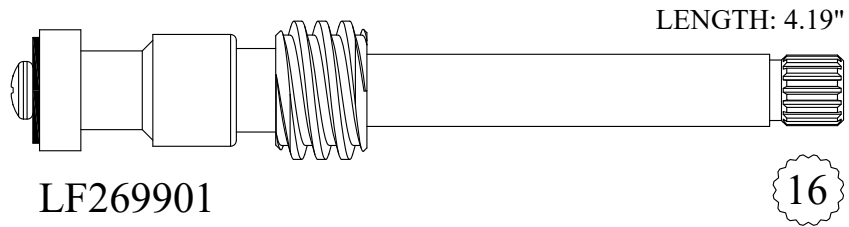

FOR AMERICAN STANDARD

Chrome Plated Stem

LENGTH: 4.38"

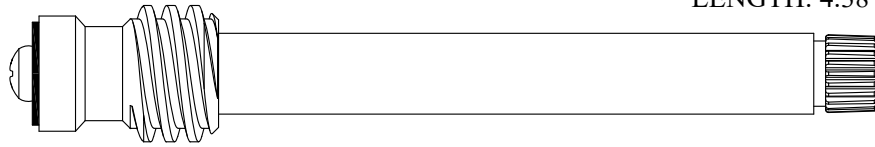

LF272071/ LF272072

OEM # 21292-02 or 31307-04

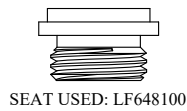

SEAT USED: LF648100

Chrome Plated Stem

LENGTH: 4.44"

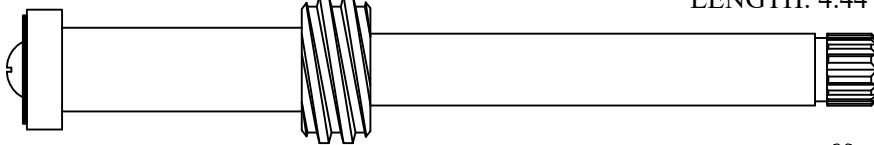

LF274041/ LF274042



SEAT USED: LF648220

LENGTH: 4.44"

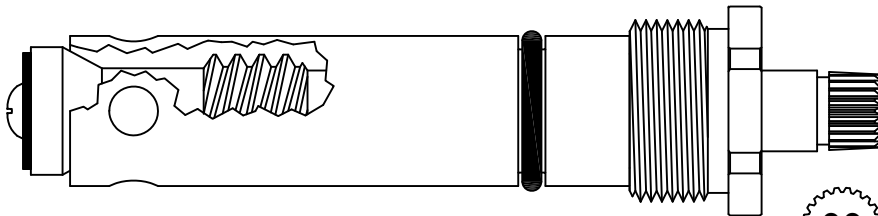

430602

OEM # 6052-07

230602 Stem Only

OEM # 25301-07

IMPORT VERSION
AS20101

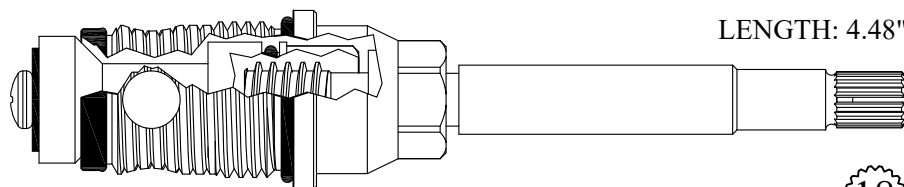

LENGTH: 4.48"

430692

GASKET: 890170 O-RING INCLUDED
OEM # 012316-0070A



FOR AMERICAN STANDARD

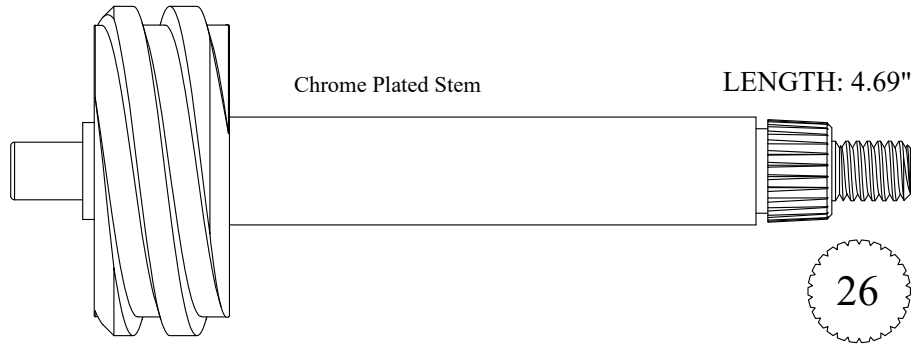

208811
OEM # 27213-02

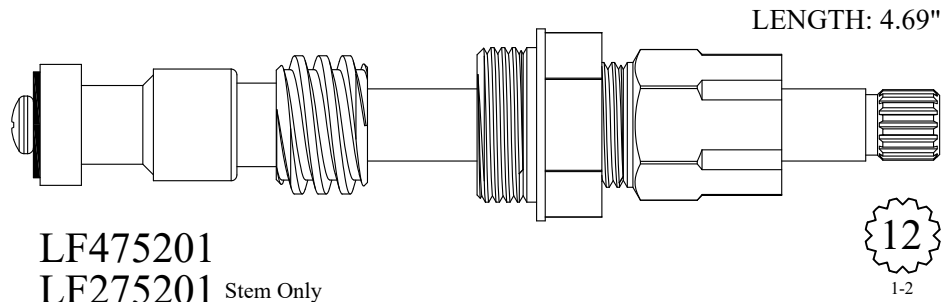

LF475201
LF275201 Stem Only

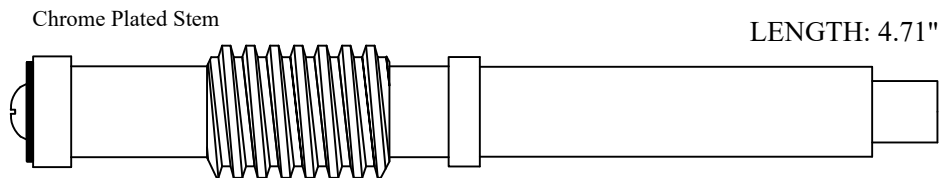

208951

Supplied with
12pt. Broach



1-2



208511
OEM # 27217-02

FOR AMERICAN STANDARD

Chrome Plated Stem

STEM LENGTH: 4.81"

INCLUDES BARREL:
LF647021/LF647022

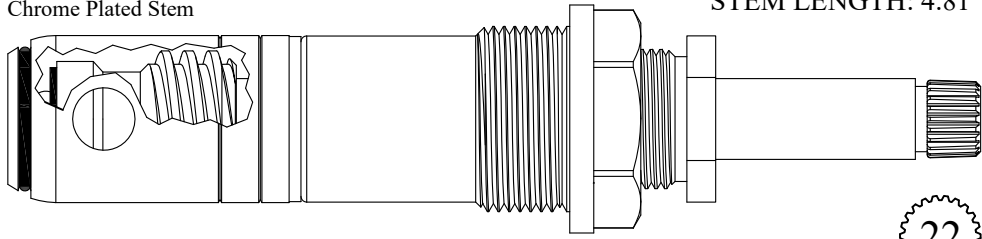

LF476031/ LF476032

GASKET INCLUDED: 818010

LF276031/ LF276032 Stem Only

OEM # 21186-02 or 31299-04/ 21674-02 or 31314-04

Also available less barrel
LF476231/ LF476232



Chrome Plated Stem

STEM LENGTH: 4.81"

INCLUDES BARREL:
LF647021/LF647022

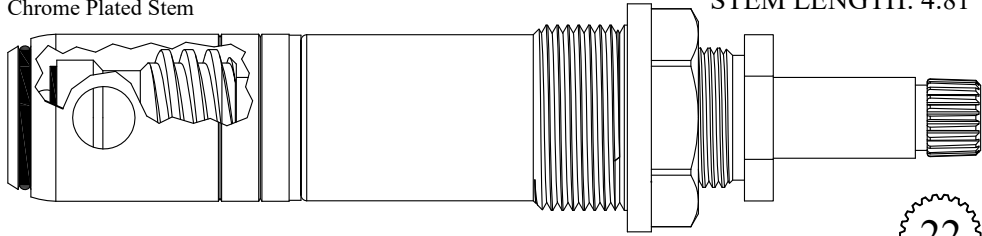

LF476041/ LF476042

GASKET INCLUDED: 818010

OEM # 18625-0200/ 13733-0200

LF276031/ LF276032 Stem Only

OEM # 21186-02 or 31299-04/ 21674-02 or 31314-04

Also available less barrel
LF476241/ LF476242



Chrome Plated Stem

STEM LENGTH: 4.81"

INCLUDES BARREL:
LF647021/LF647022

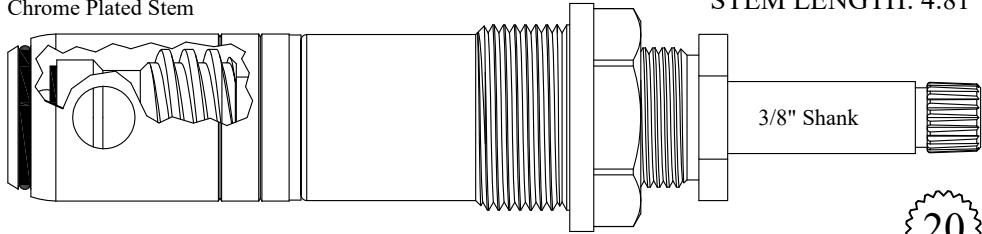

LF476131/ LF476132

GASKET INCLUDED: 818010

LF276131/ LF276132 Stem Only

OEM # 19279-02/ 20778-02

Also available less barrel
LF476331/ LF476332



Chrome Plated Stem

STEM LENGTH: 4.81"

INCLUDES BARREL:
LF647021/LF647022

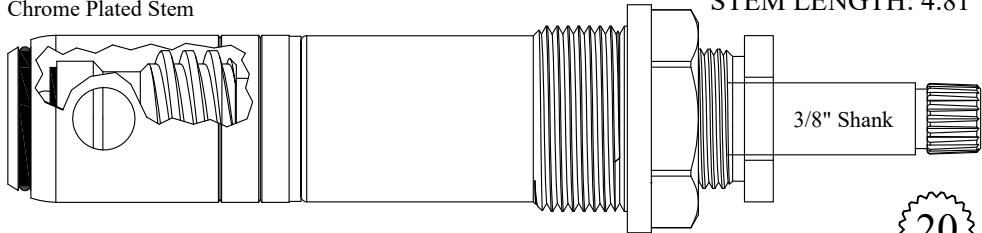

LF476141/ LF476142

GASKET INCLUDED: 818010

LF276131/ LF276132 Stem Only

OEM # 19279-02/ 20778-02

Also available less barrel
LF476341/ LF476342



FOR AMERICAN STANDARD

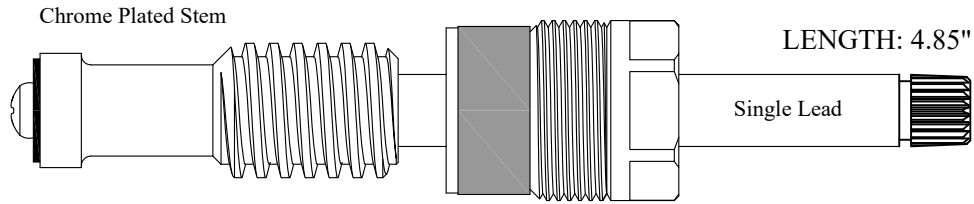

410351
210351

Supplied with
12pt. Broach

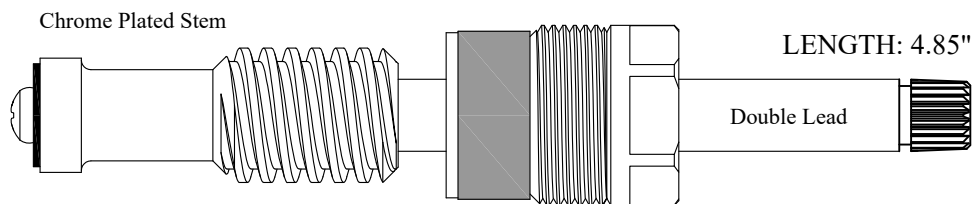
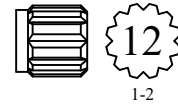

410361
210361

Supplied with
12pt. Broach

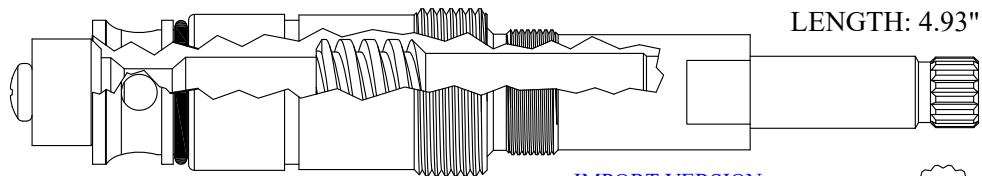
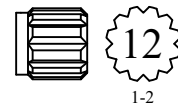

431601
INCLUDES WAVE WASHER: 897110
OEM # 50772-0700

IMPORT VERSION
AS20173

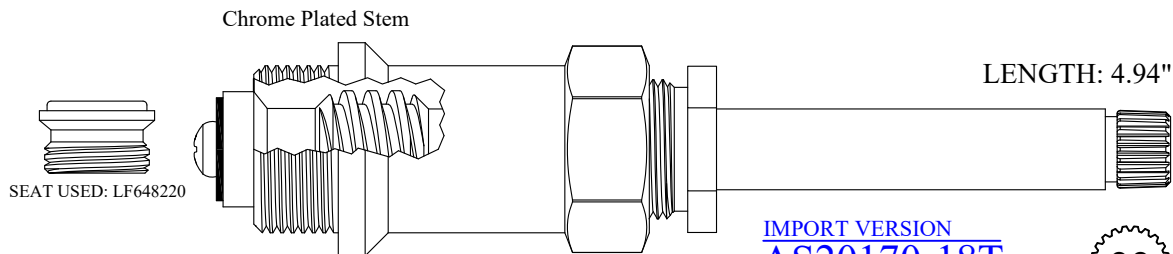

SEAT USED: LF648220

412301
GASKET INCLUDED: 895400
OEM # 9806-02
212301 Stem Only
OEM # 25509-02

IMPORT VERSION
AS20170-18T



FOR AMERICAN STANDARD

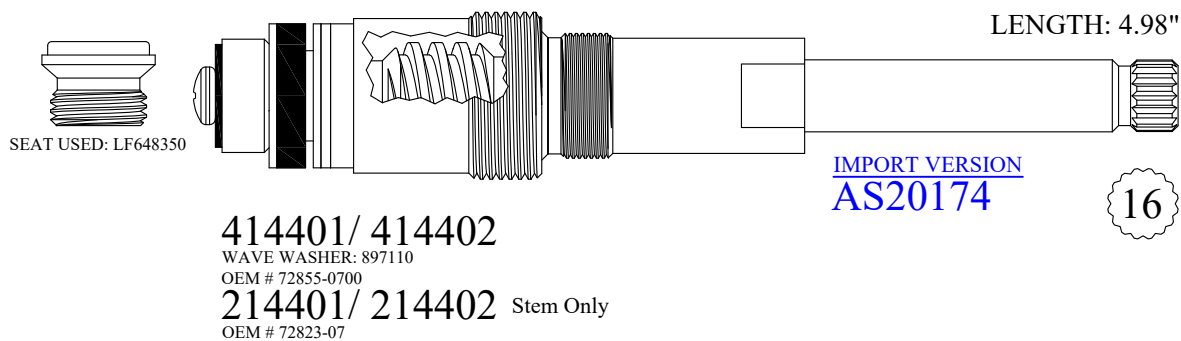
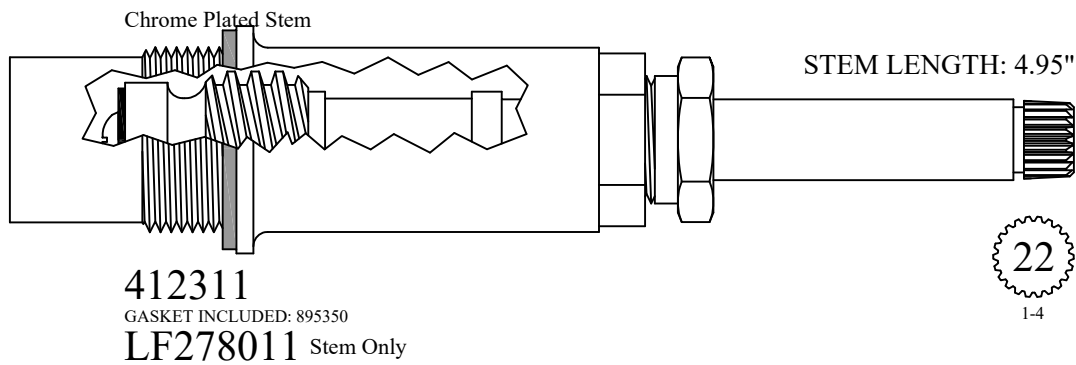
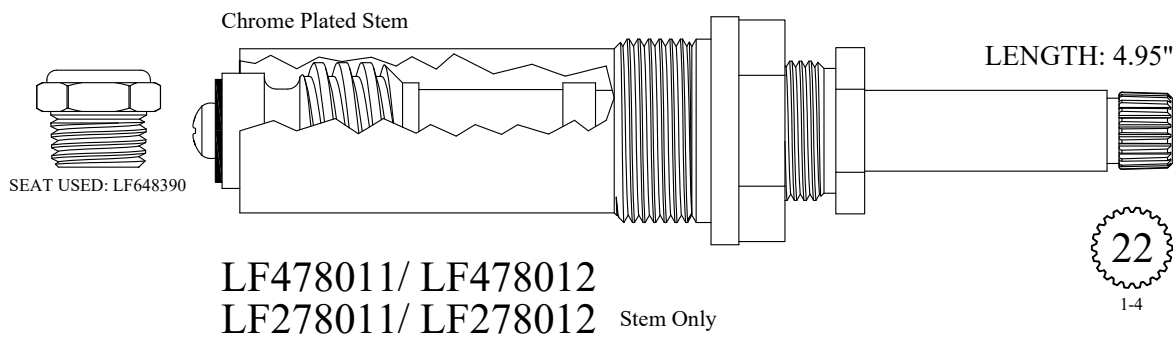
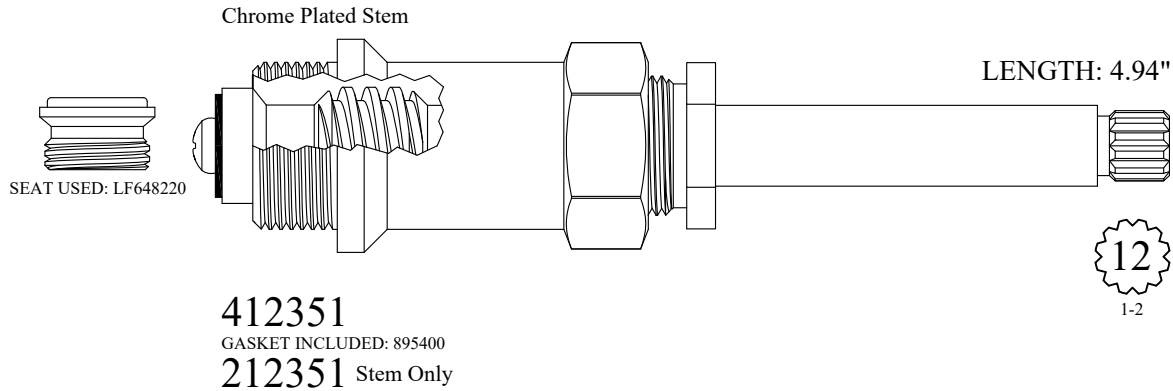

FOR AMERICAN STANDARD

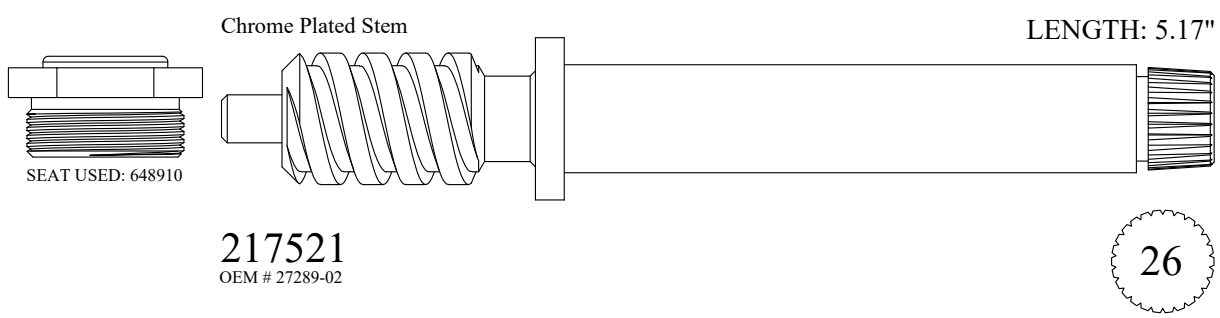
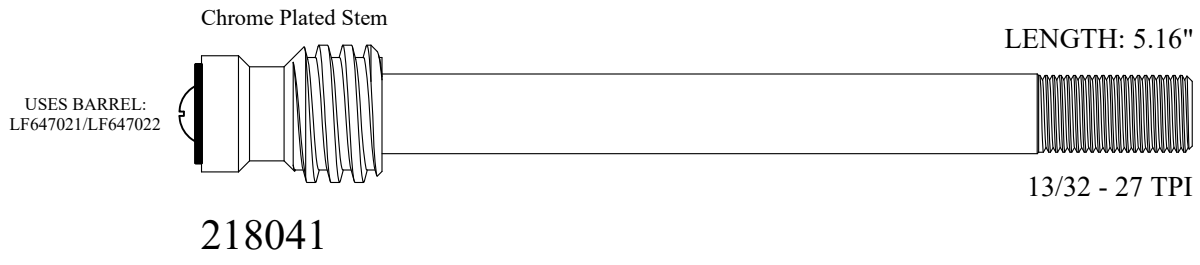
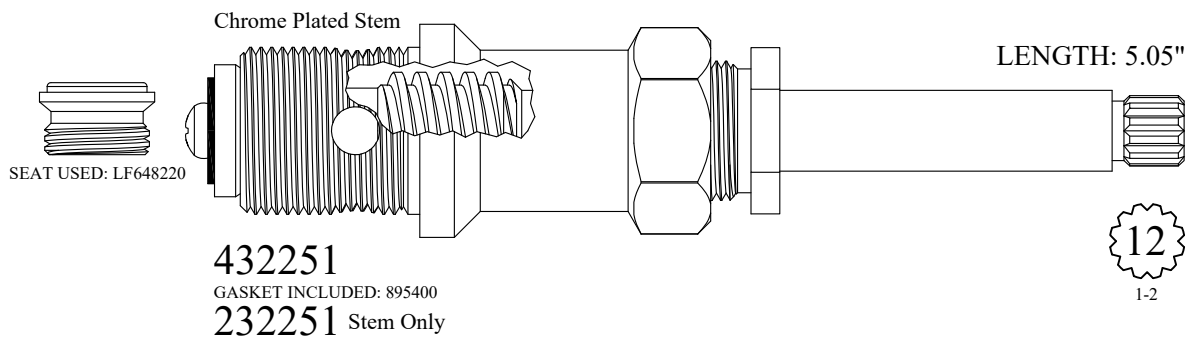
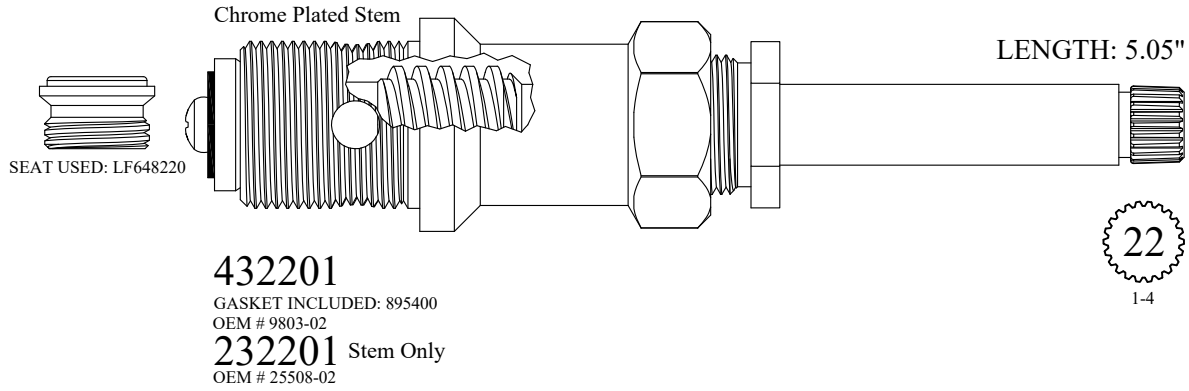

FOR AMERICAN STANDARD

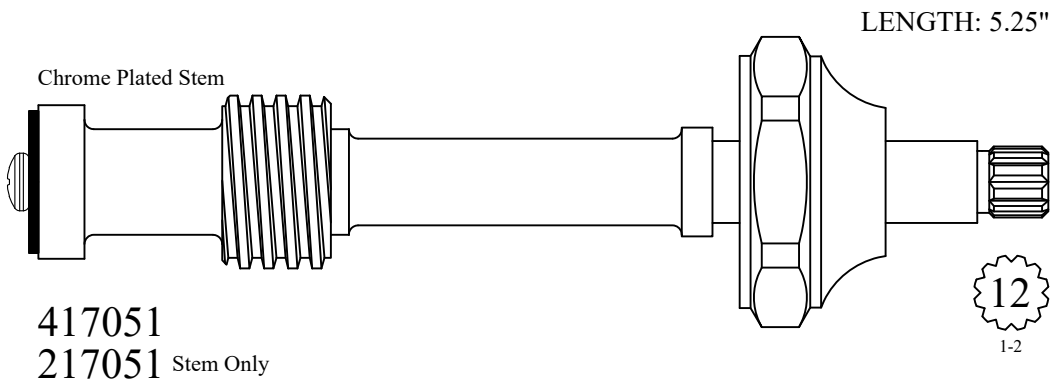
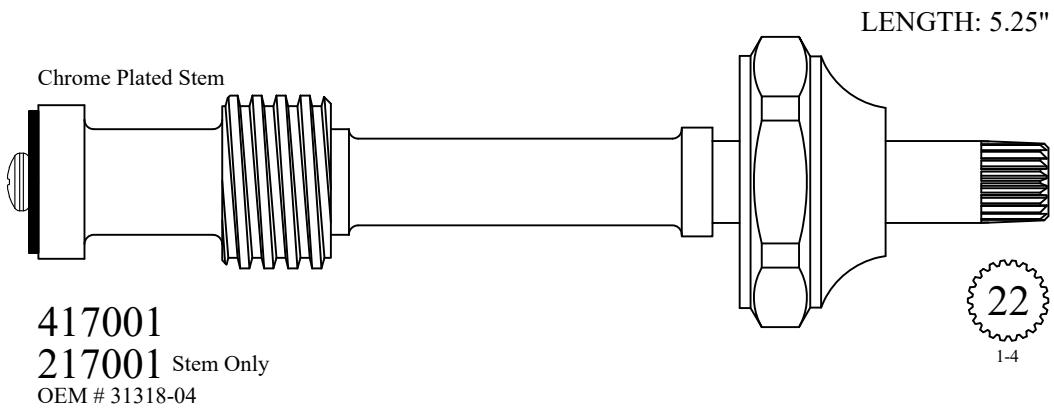
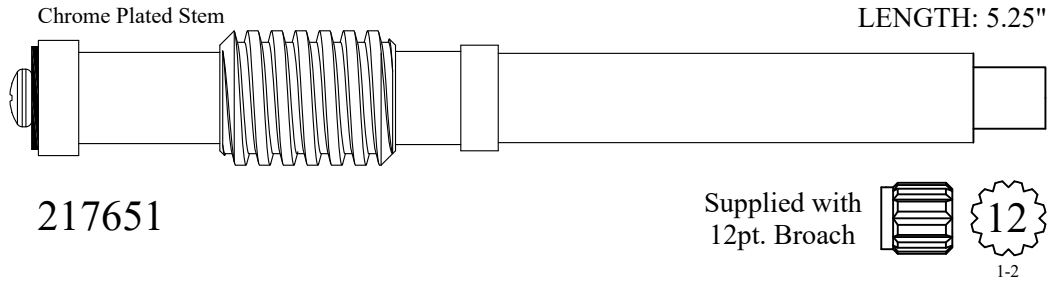
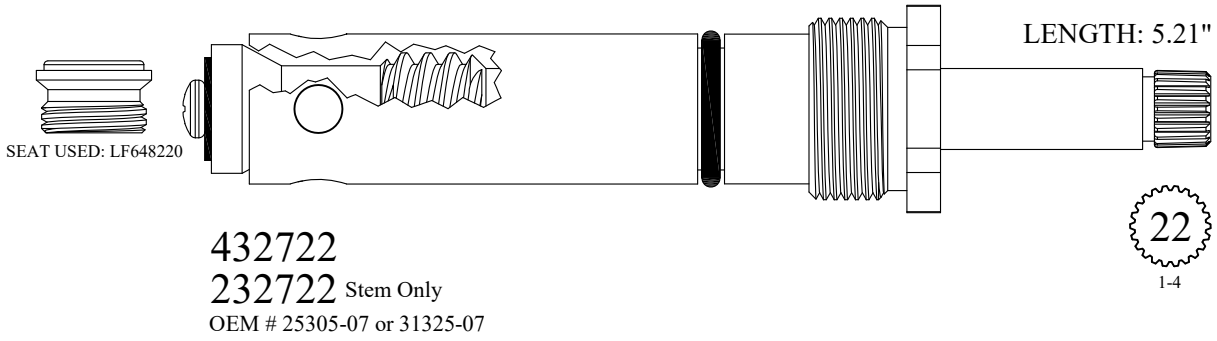

FOR AMERICAN STANDARD

Chrome Plated Stem

LENGTH: 5.30"

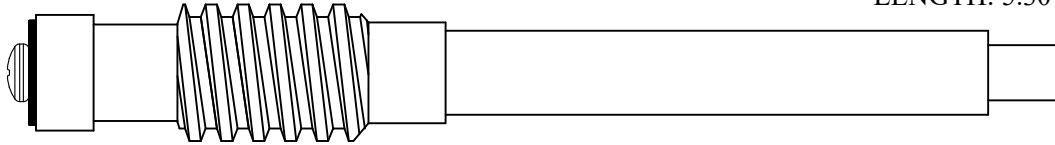

225151

Supplied with
12pt. Broach



1-2

Chrome Plated Stem

Also available less barrel
199651/ 199652

STEM LENGTH: 5.31"

INCLUDES BARREL:
LF647021/LF647022

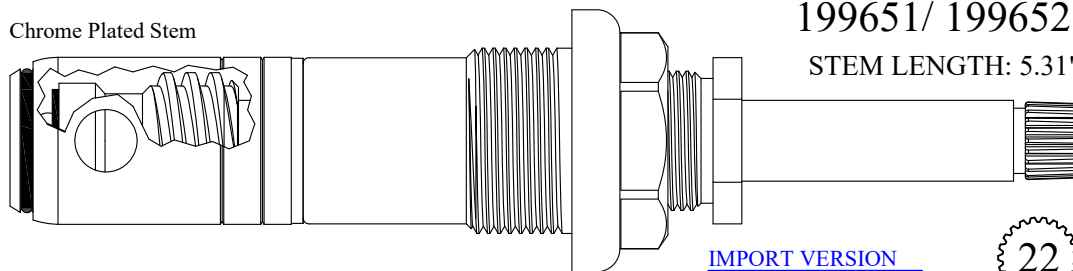

418001/ 418002

GASKET INCLUDED: 818000
OEM # 18293-0200

218001/ 218002 Stem Only

OEM # 31321-07 or 31344-04/ 21666-02

IMPORT VERSION
AS20186-15



1-4

Chrome Plated Stem

STEM LENGTH: 5.31"

INCLUDES BARREL:
LF647021/LF647022

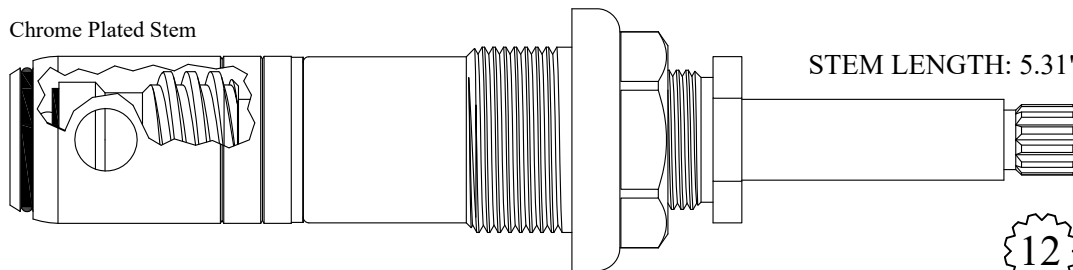

418051/ 418052

GASKET INCLUDED: 818000

218051/ 218052 Stem Only



1-2

Chrome Plated Stem

STEM LENGTH: 5.31"

INCLUDES BARREL:
LF647021/LF647022

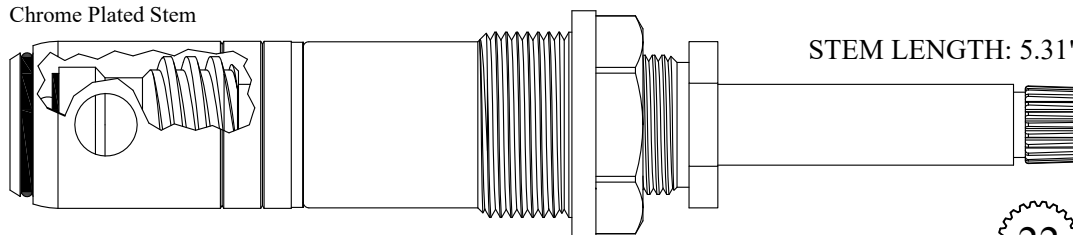

418011/ 418012

GASKET INCLUDED: 818000

218001/ 218002 Stem Only

OEM # 31321-07 or 31344-04/ 21666-02



1-4

FOR AMERICAN STANDARD

Chrome Plated Stem

INCLUDES BARREL:
LF647021/LF647022

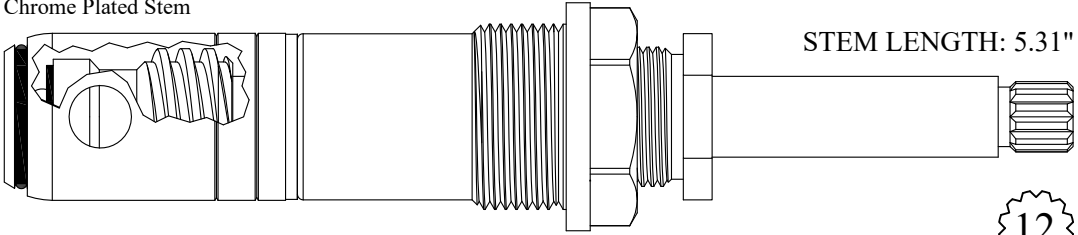

STEM LENGTH: 5.31"

12
1-2

418061/ 418062
GASKET INCLUDED: 818000
218051/ 218052 Stem Only

Chrome Plated Stem

INCLUDES BARREL:
LF647021/LF647022

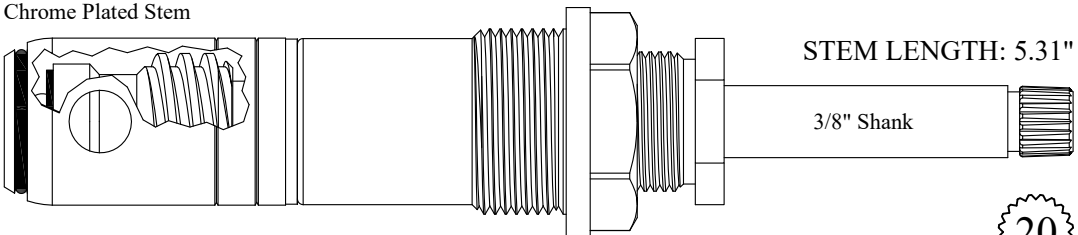

STEM LENGTH: 5.31"

3/8" Shank

20
3-14

418021/ 418022
GASKET INCLUDED: 818010
218021/ 218022 Stem Only
OEM # 21206-02

Chrome Plated Stem

INCLUDES BARREL:
LF647021/LF647022

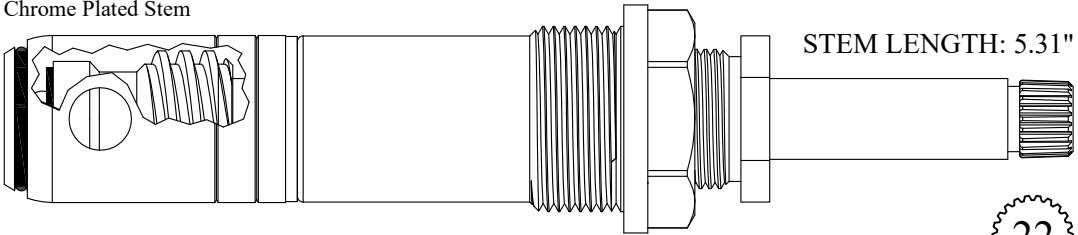

STEM LENGTH: 5.31"

22
1-4

418031/ 418032
GASKET INCLUDED: 818010
OEM # 4754-02
218001/ 218002 Stem Only
OEM # 31321-07 or 31344-04 / 21666-02

Chrome Plated Stem

INCLUDES BARREL:
LF647021/LF647022



STEM LENGTH: 5.31"

3/8" Shank

418081/ 418082
GASKET INCLUDED: 818010
218021/ 218022 Stem Only
OEM # 21206-02

FOR AMERICAN STANDARD

Chrome Plated Stem

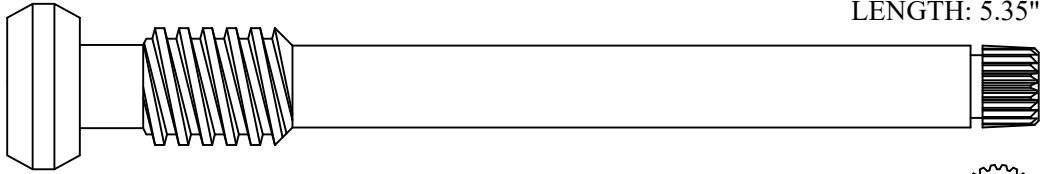

LENGTH: 5.35"

233531

OEM # 21444-04 or 21685-02

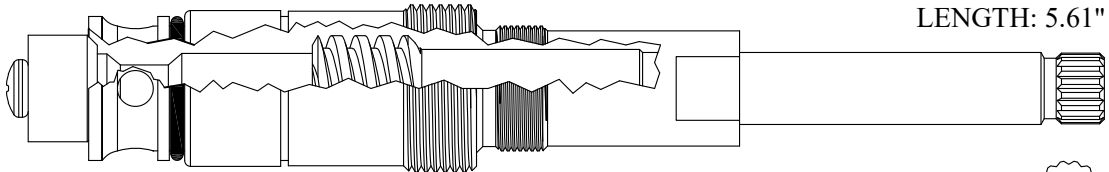

LENGTH: 5.61"

433801

WAVE WASHER INCLUDED: 897110

OEM # 72856-0700A

233801 Stem Only

OEM # 72815-07



Chrome Plated Stem

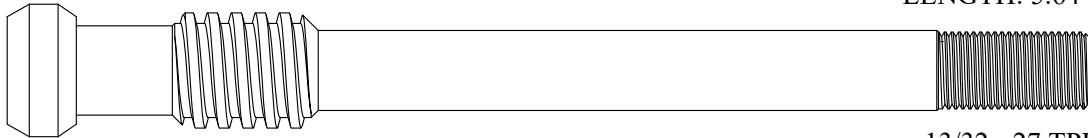

LENGTH: 5.64"

235641

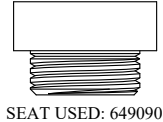

SEAT USED: 649090

13/32 - 27 TPI

Chrome Plated Stem

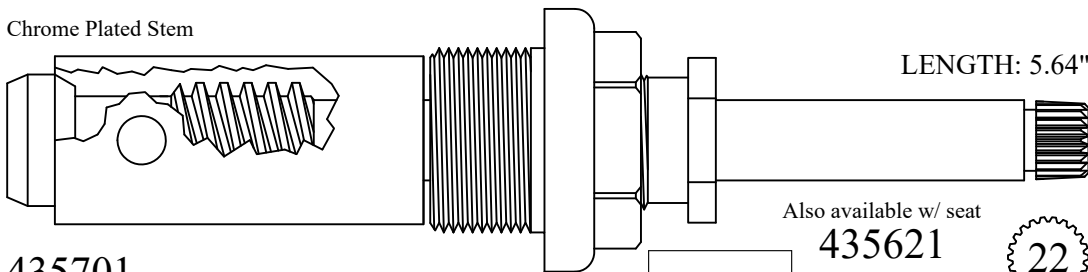

LENGTH: 5.64"

435701

GASKET INCLUDED: 818000

OEM # 18355-0200

235701 Stem Only

OEM # 21698-04

Also available stem & sleeve only

151171

Also available stem & bonnet only

435631

Also available w/ seat

435621

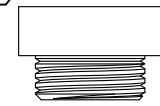

SEAT USED: 649090



Chrome Plated Stem

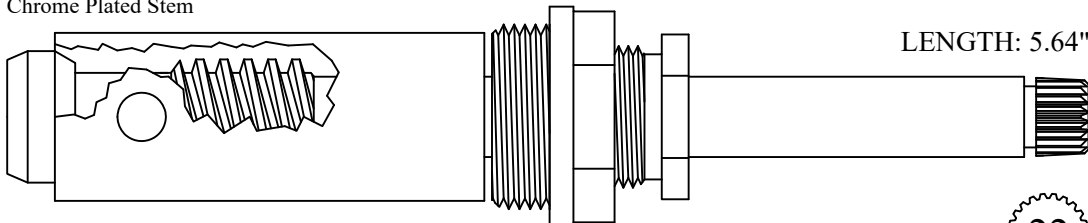

LENGTH: 5.64"

435711

GASKET INCLUDED: 818010

235701 Stem Only

OEM # 21698-04



SEAT USED: 649090



FOR AMERICAN STANDARD

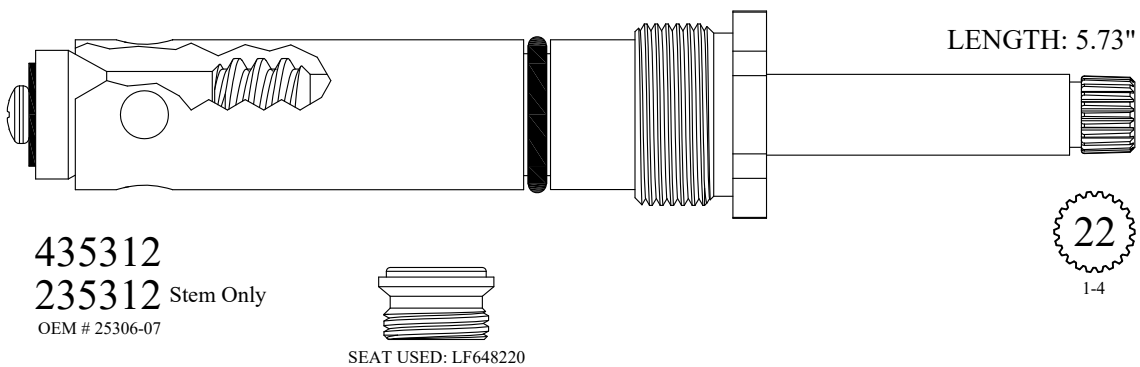
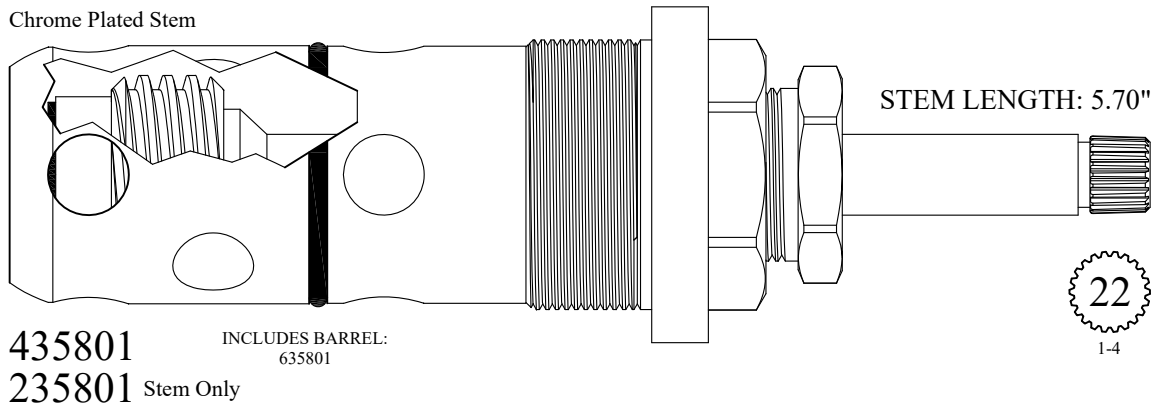
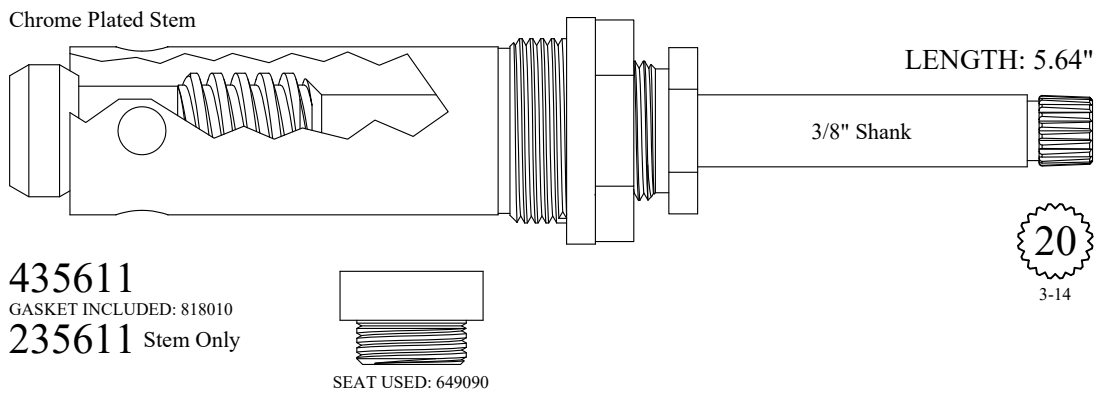
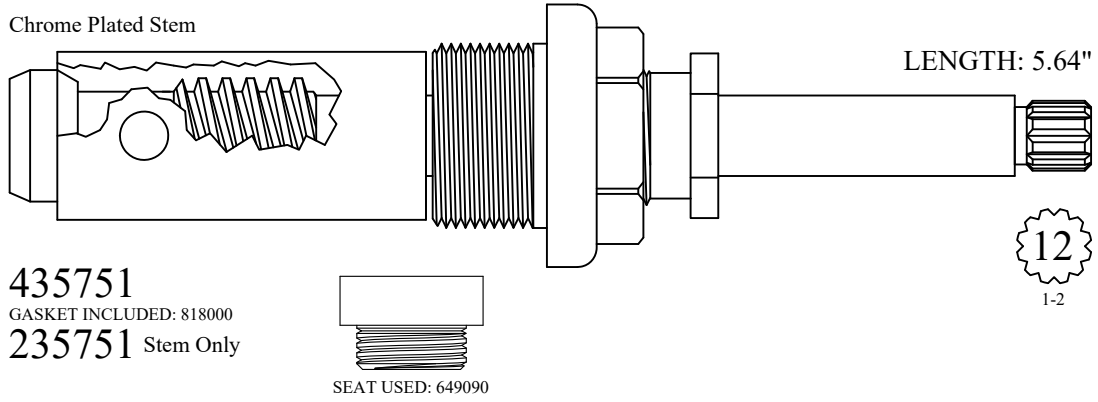

FOR AMERICAN STANDARD

Chrome Plated Stem



LENGTH: 5.75"

224641/ 224642
OEM # 21744-02/ 21745-02

USES BARREL:
647081/647082



Chrome Plated Stem

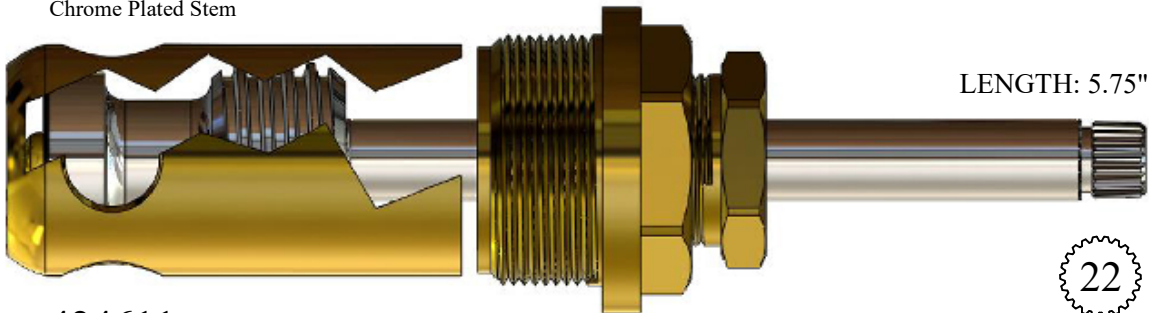

LENGTH: 5.75"

424611
224611
OEM # 21214-02 or 31303-04

INCLUDES BARREL:
647071



Chrome Plated Stem

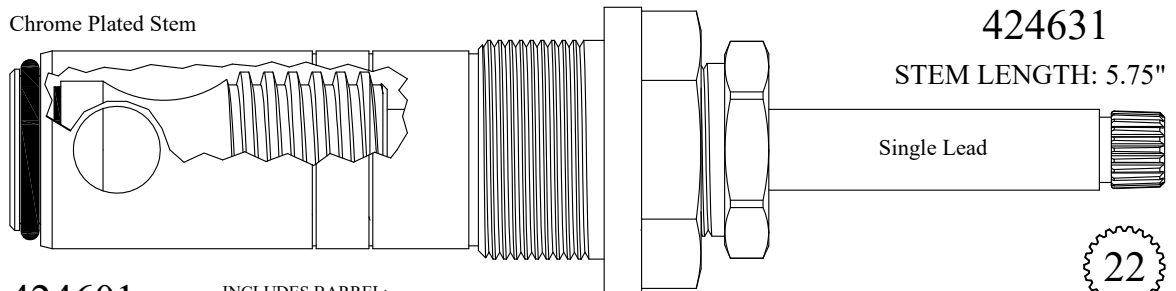

Also available less barrel

424631

STEM LENGTH: 5.75"

Single Lead

424601
GASKET INCLUDED: 824600
OEM # 16762-02
224601 Stem Only
OEM # 19276-02 or 31287-04

INCLUDES BARREL:
647051



Chrome Plated Stem

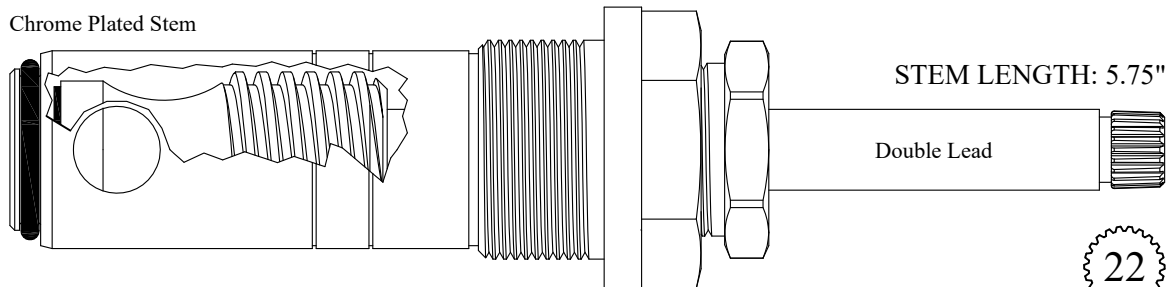

STEM LENGTH: 5.75"

Double Lead

424621/ 424622
GASKET INCLUDED: 824600
224621/ 224622 Stem Only
OEM # 20770-02/ 21741-02

INCLUDES BARREL:
647061 / 647062



FOR AMERICAN STANDARD

Chrome Plated Stem

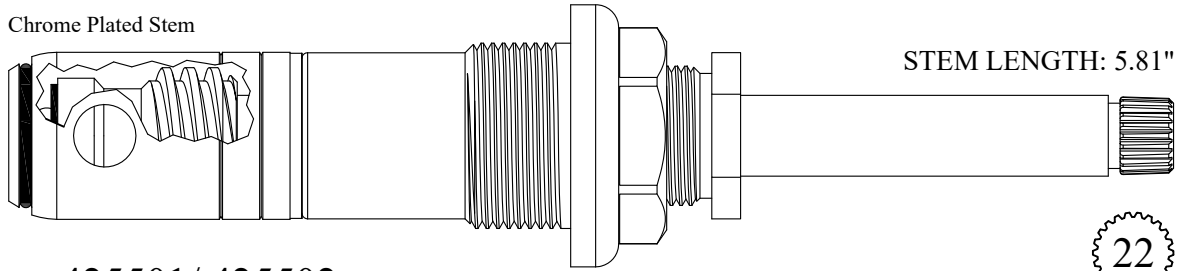

STEM LENGTH: 5.81"

425501/ 425502

GASKET INCLUDED: 818000

225501/ 225502 Stem Only

OEM # 21720-02/ 21728-02

INCLUDES BARREL:
LF647021/LF647022

22
1-4

Chrome Plated Stem

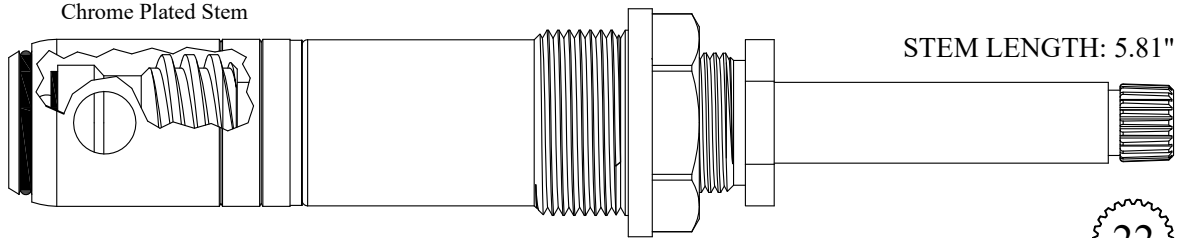

STEM LENGTH: 5.81"

425511

GASKET INCLUDED: 818010

225501 Stem Only

OEM # 21720-02

INCLUDES BARREL:
LF647021

22
1-4

Chrome Plated Stem

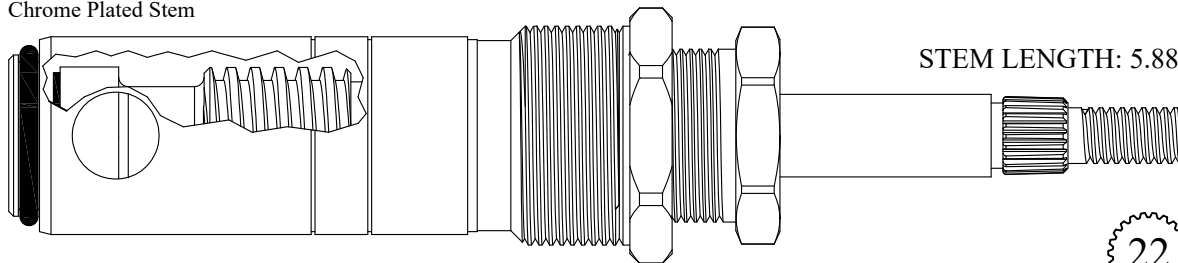

STEM LENGTH: 5.88"

425711

225711 Stem Only

INCLUDES BARREL:
647051

22
1-4

Chrome Plated Stem

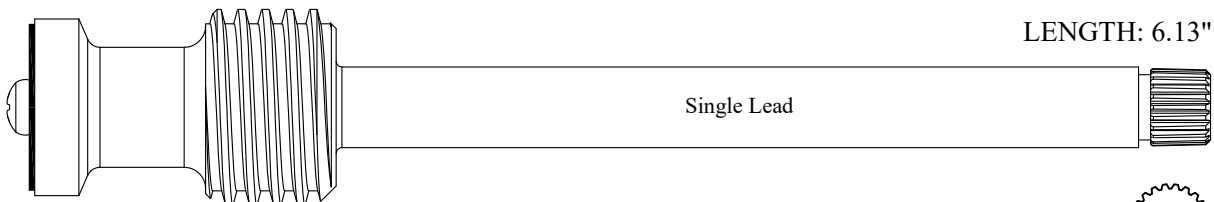

LENGTH: 6.13"

Single Lead

225701

OEM # 94054-02

USES BARREL:
647071

22
1-4

FOR AMERICAN STANDARD

Chrome Plated Stem

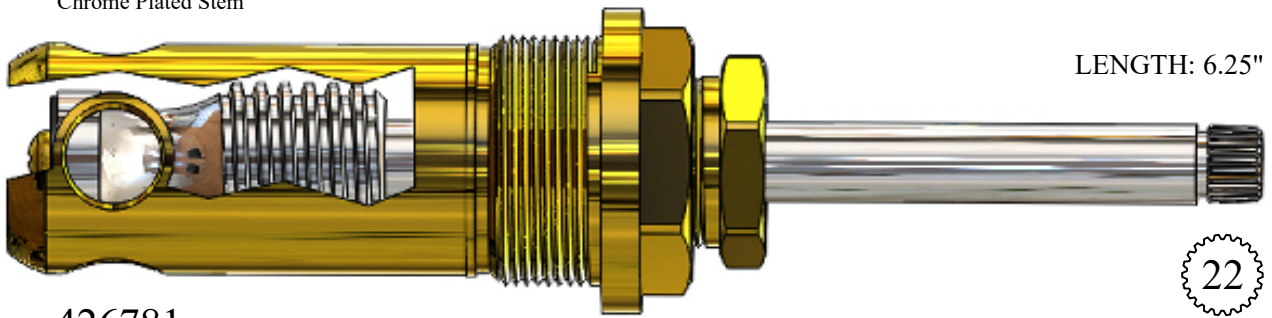

LENGTH: 6.25"

426781
OEM # 19324-02

INCLUDES BARREL:
LF647071



Chrome Plated Stem

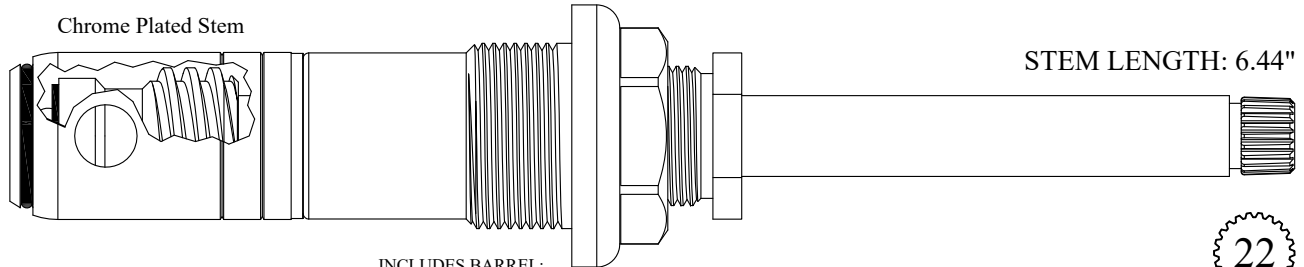

STEM LENGTH: 6.44"

427011/ 427012

GASKET INCLUDED: 818000

227011/ 227012 Stem Only

OEM # 33632-02/ 21760-02

INCLUDES BARREL:
LF647021/LF647022



Chrome Plated Stem

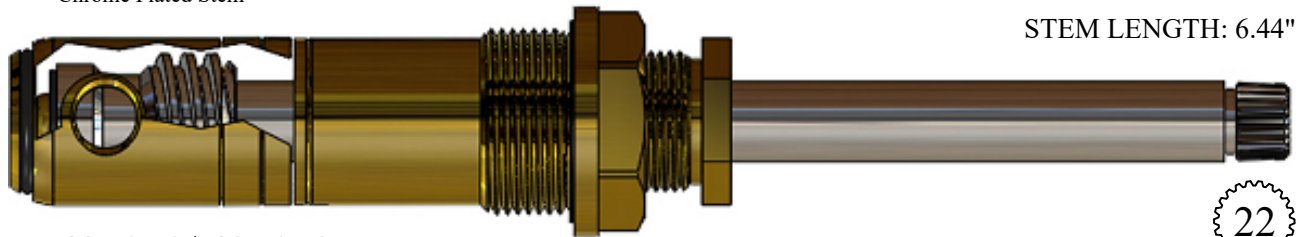

STEM LENGTH: 6.44"

427071/ 427072

GASKET INCLUDED: 818000

227011/ 227012 Stem Only

OEM # 33632-02/ 21760-02

INCLUDES BARREL:
LF647021/LF647022



Chrome Plated Stem

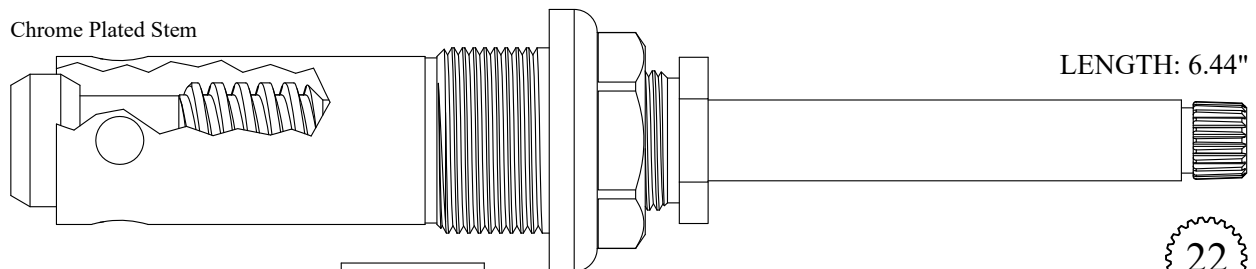

LENGTH: 6.44"

436501

GASKET INCLUDED: 818000

236501 Stem Only

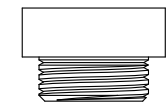

SEAT USED: 649090



FOR AMERICAN STANDARD

Chrome Plated Stem

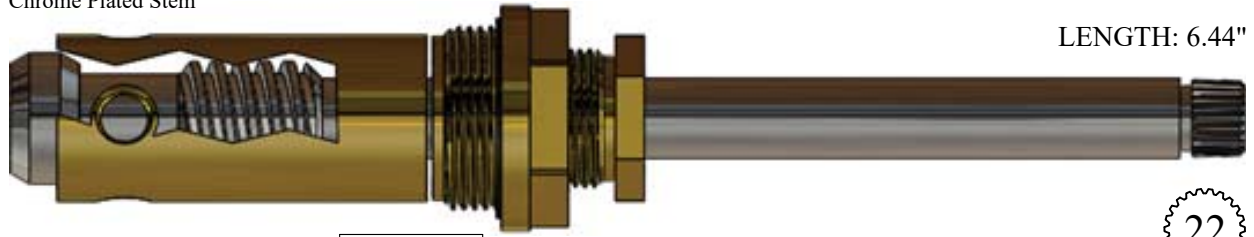

LENGTH: 6.44"

436561
GASKET INCLUDED: 818000
236501 Stem Only

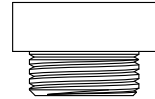

SEAT USED: 649090

22
1-4

Chrome Plated Stem

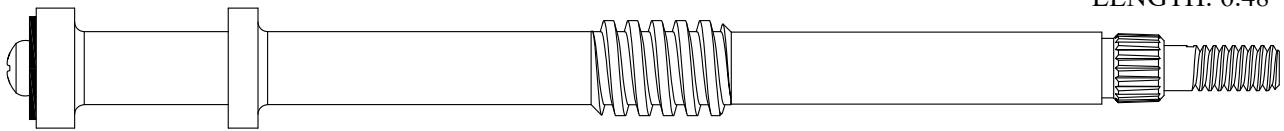

LENGTH: 6.48"

LF280511

20
3-14

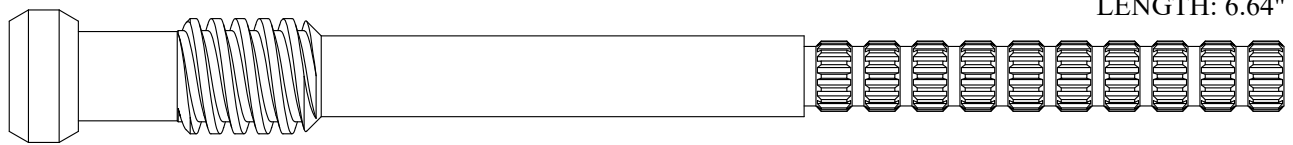

LENGTH: 6.64"

235741



SEAT USED: 649090

16
3-16

Chrome Plated Stem

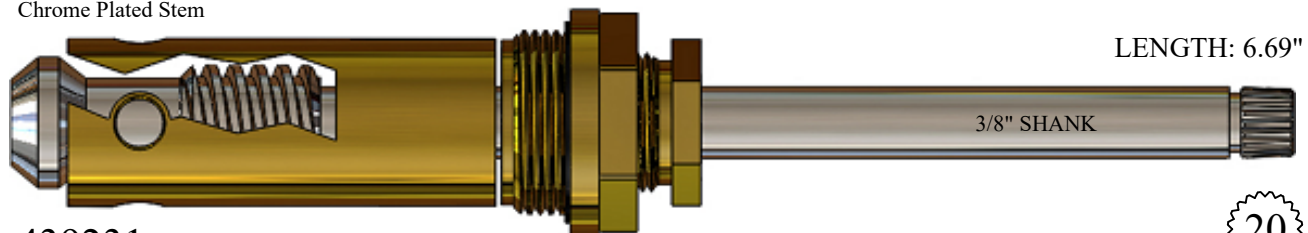

LENGTH: 6.69"

439231
239231 Stem Only

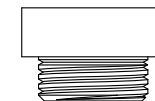

SEAT USED: 649090

20
3-14

FOR AMERICAN STANDARD

Chrome Plated Stem 3/8" Shank

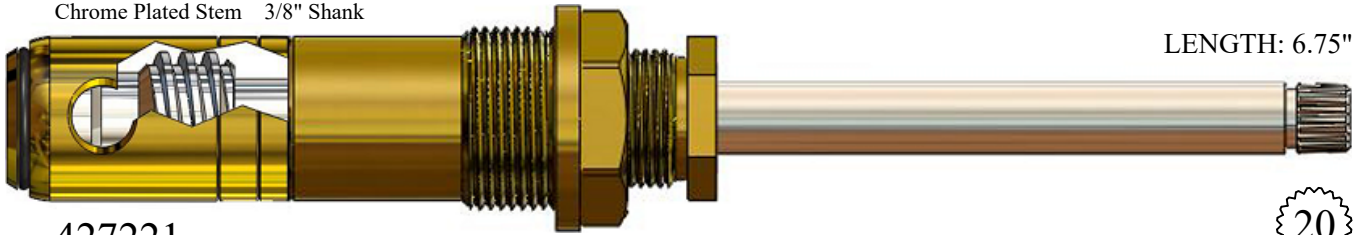

LENGTH: 6.75"

427221
227221

Stem Only

INCLUDES BARREL:
LF647021

20
3-14

Chrome Plated Stem Single Lead Thread

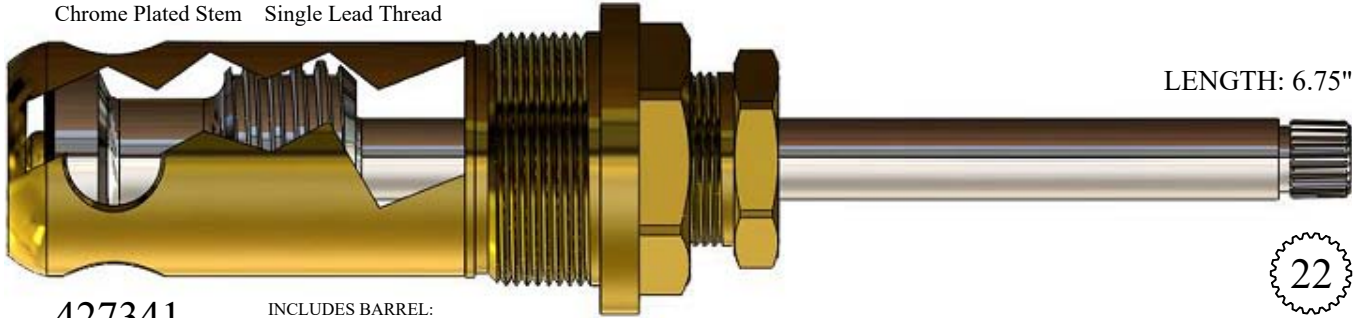

LENGTH: 6.75"

427341
227341

OEM # 21731-02

INCLUDES BARREL:
647071

22
1-4

Chrome Plated Stem Double Lead Thread



LENGTH: 6.75"

227351/ 227352
OEM # 21729-02 / 21730-02

USES BARREL:
647081/647082

22
1-4

Chrome Plated Stem Double Lead Thread

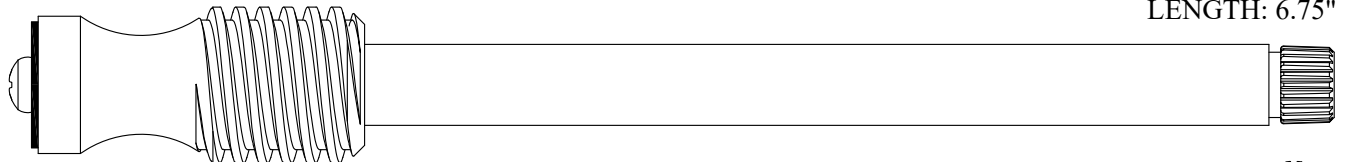

LENGTH: 6.75"

227361/ 227362
OEM # 21726-02 / 21727-02

USES BARREL:
647061/647062

22
1-4

FOR AMERICAN STANDARD

Chrome Plated Stem

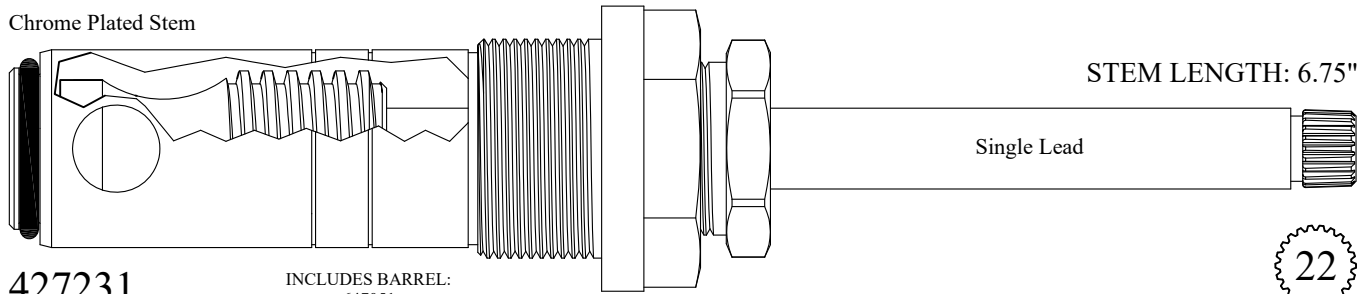

STEM LENGTH: 6.75"

Single Lead

427231

INCLUDES BARREL:
647051

GASKET INCLUDED: 824600
OEM # 5903-02

227231 Stem Only

OEM # 21221-02 or 31304-04

22

1-4

Chrome Plated Stem

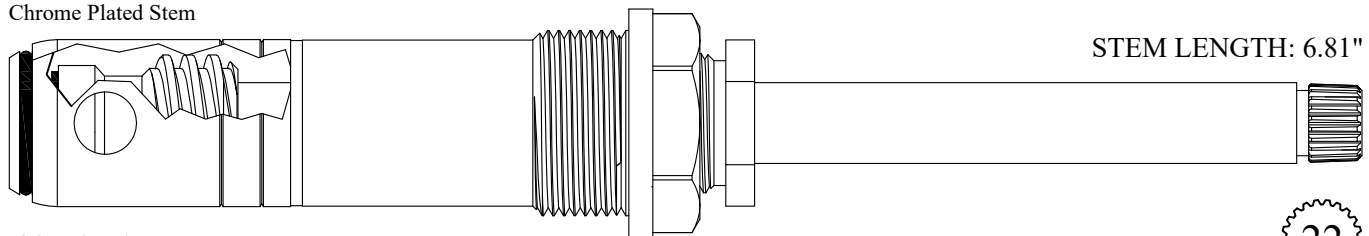

STEM LENGTH: 6.81"

427151

INCLUDES BARREL:
LF647021

GASKET INCLUDED: 818010

227021/ 227022 Stem Only

OEM # 31345-04 or 21688-02 / 21689-02

22

1-4

Chrome Plated Stem

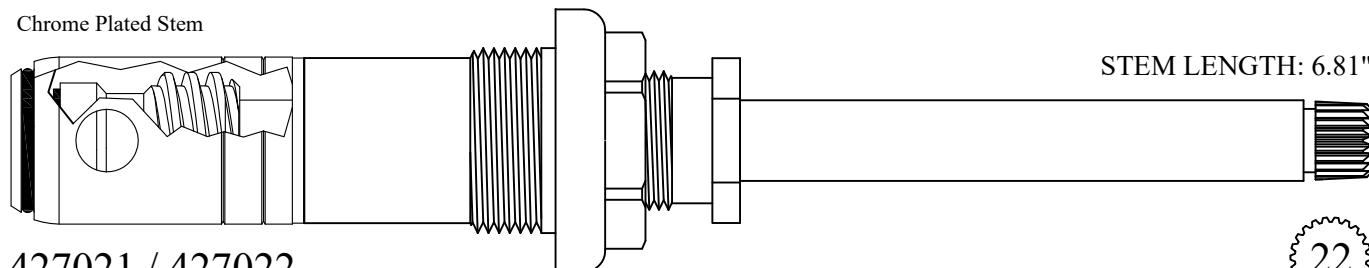

STEM LENGTH: 6.81"

427021 / 427022

INCLUDES BARREL:
LF647021/LF647022

GASKET INCLUDED: 818000

227021/ 227022 Stem Only

OEM # 31345-04 or 21688-02 / 21689-02

22

1-4

FOR AMERICAN STANDARD

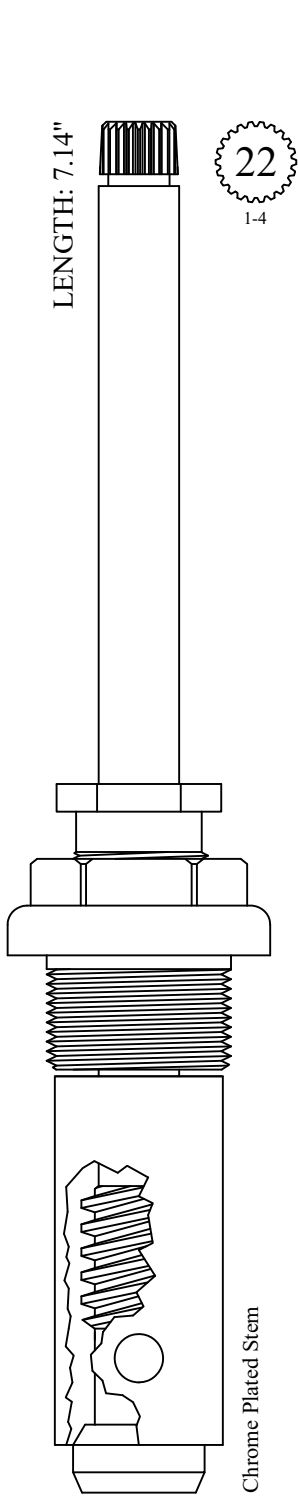

GASKET INCLUDED: 818000

435041
235041 Stem Only

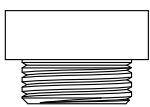

SEAT USED: 649090

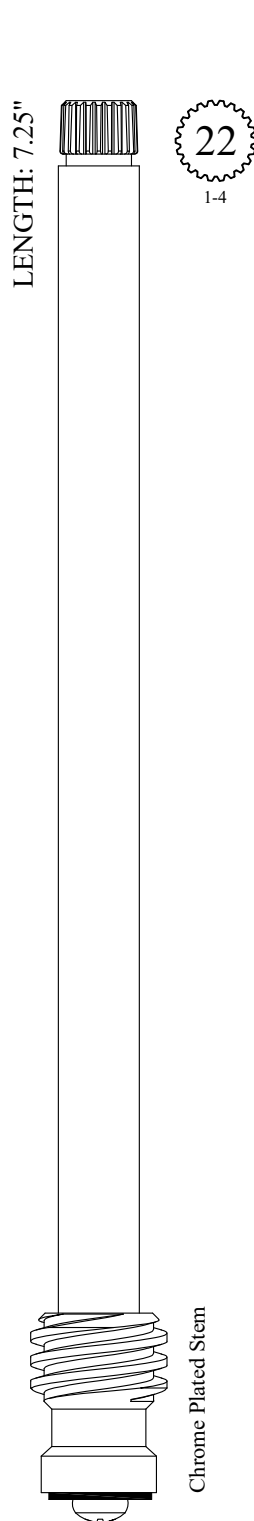

USES BARREL: LF647021

227611
OEM # 21220-02

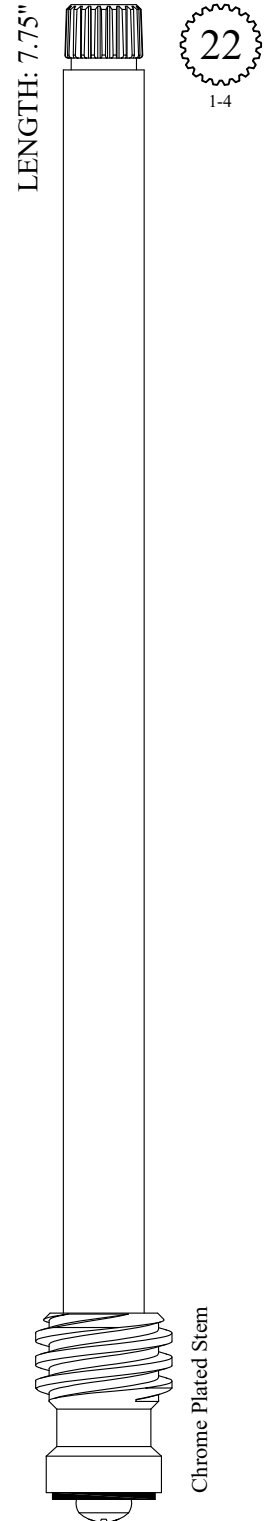

USES BARREL: LF647021

227811
OEM # 21222-02

FOR AMERICAN STANDARD

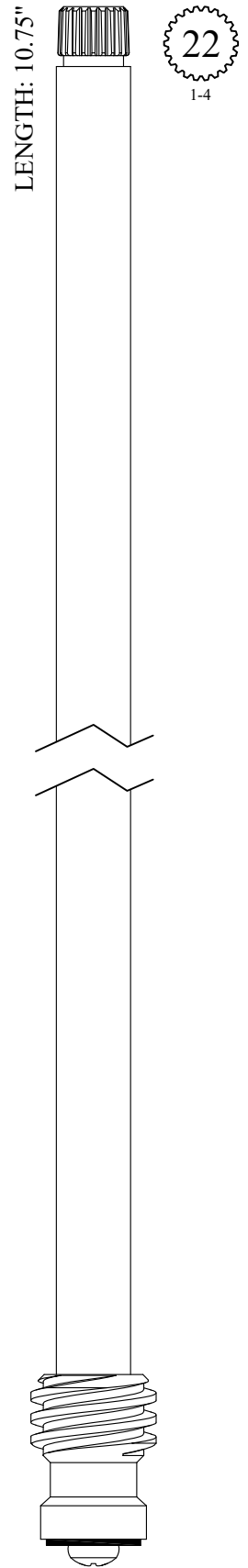
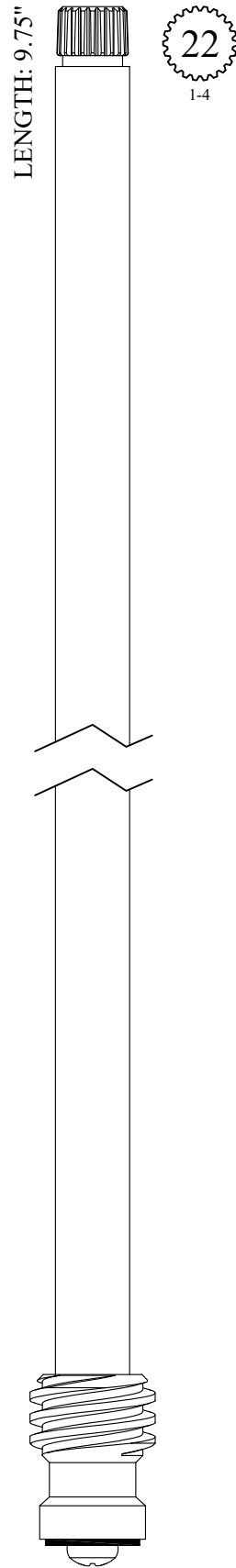
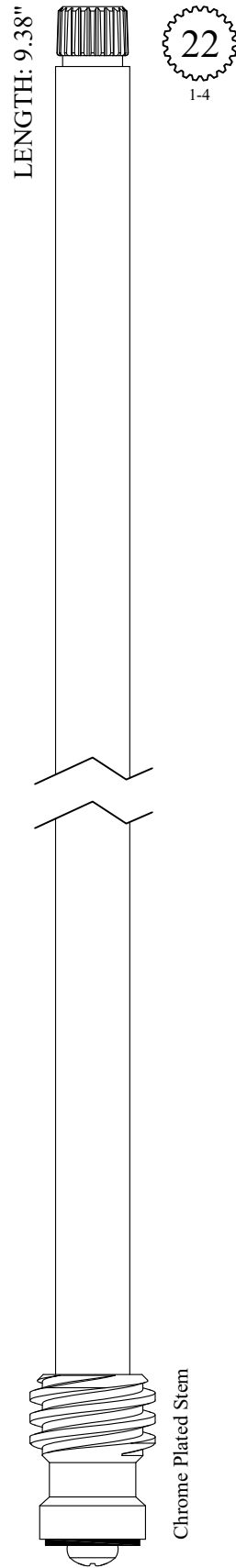
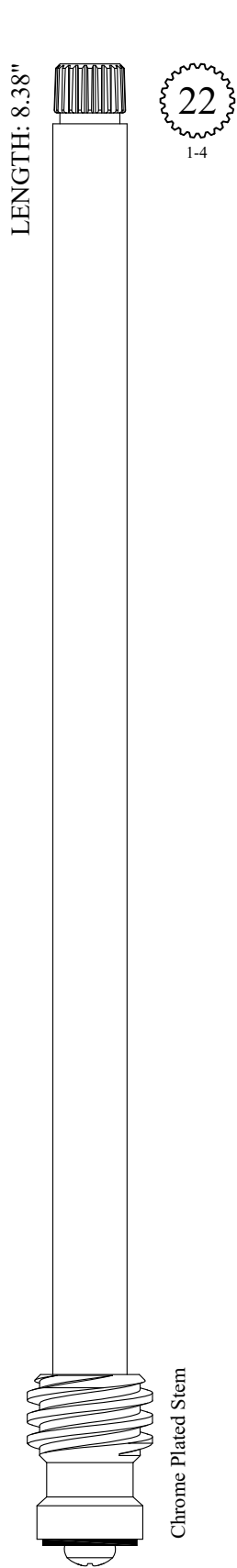

FOR APEX

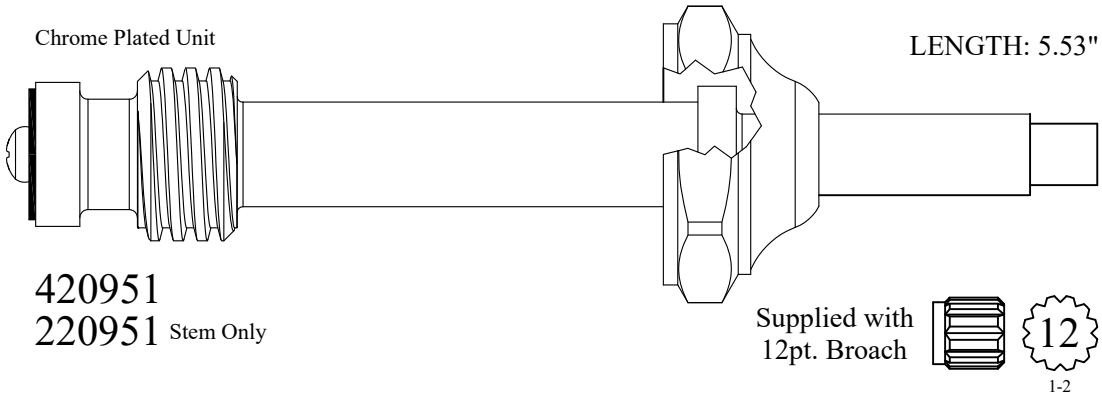

FOR ARJO

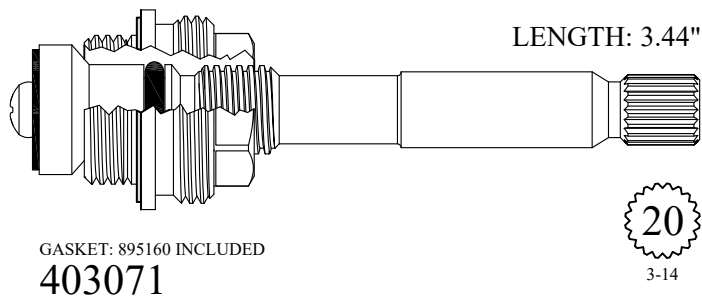

FOR ARMONIA

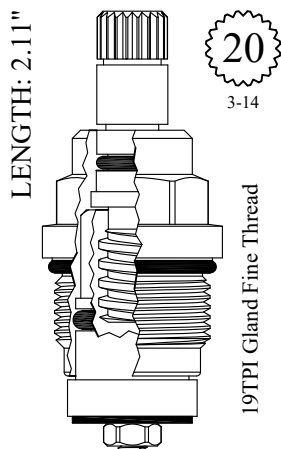

GASKET: 890180 O-RING INCLUDED

LF460172

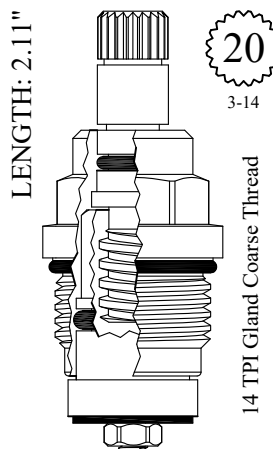

GASKET: 890180 O-RING INCLUDED

LF460182

FOR ARMONIA

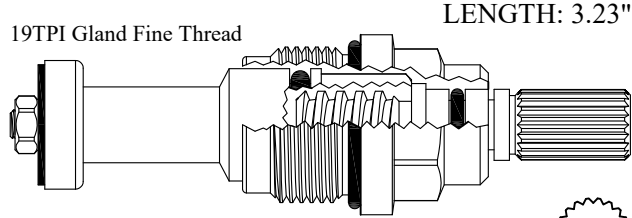

401822

GASKET: 890180 O-RING INCLUDED

20
3-14

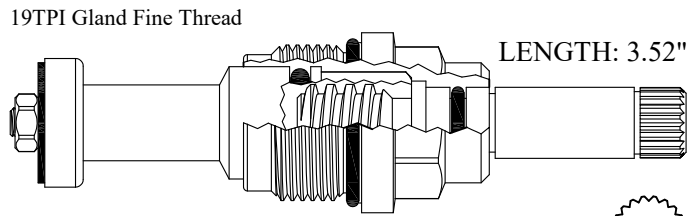

402532

GASKET: 890180 O-RING INCLUDED

20
3-14

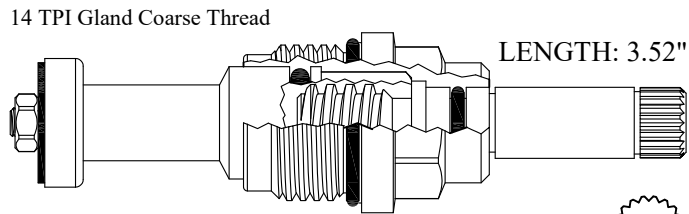

402542

GASKET: 890180 O-RING INCLUDED

20
3-14

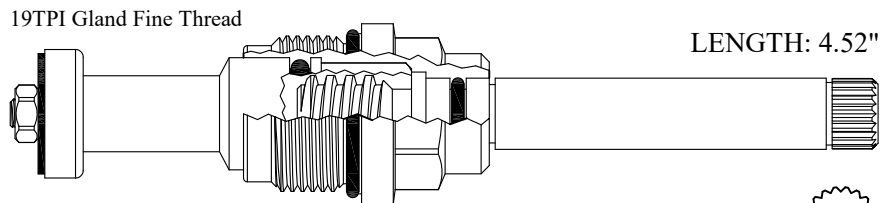

405942

GASKET: 890180 O-RING INCLUDED

20
3-14

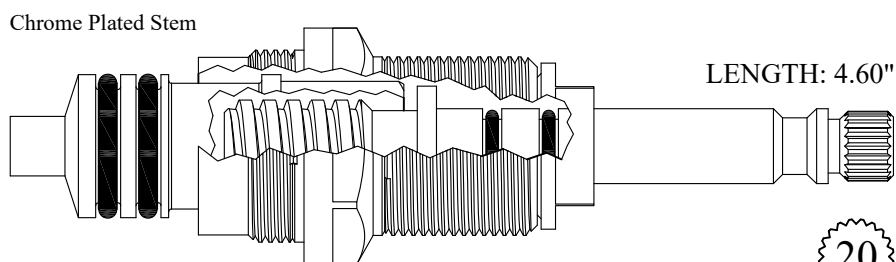

431441

GASKET: 895570 INCLUDED

20
3-14

FOR ARROWHEAD

LENGTH: 1.24"

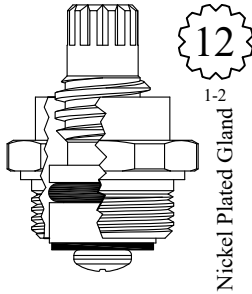

GASKET INCLUDED: 895100

LF450041
LF450042



LENGTH: 1.43"

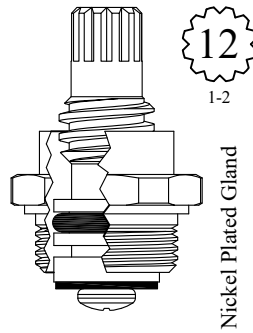

GASKET INCLUDED: 895100

LF452021
LF452022



LENGTH: 1.46"

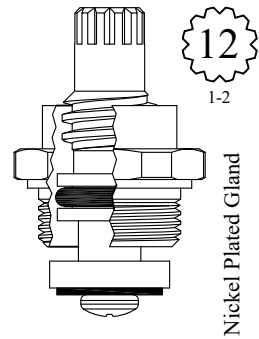

GASKET INCLUDED: 895100

LF450101
LF450102



LENGTH: 1.72"

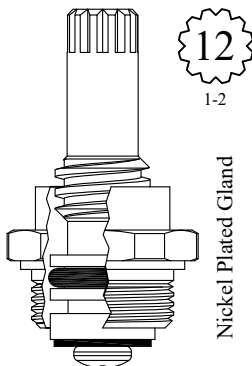

GASKET INCLUDED: 895100

LF454191
LF454192

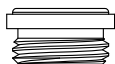

LENGTH: 1.75"

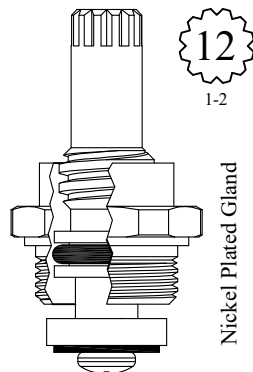

GASKET INCLUDED: 895100

LF454091
LF454092



LENGTH: 1.84"

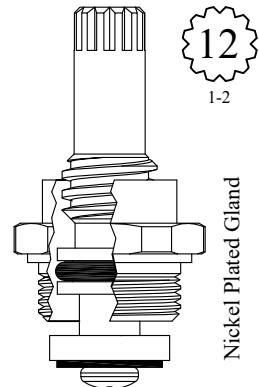

GASKET INCLUDED: 895100

LF457031
LF457032



FOR ARROWHEAD

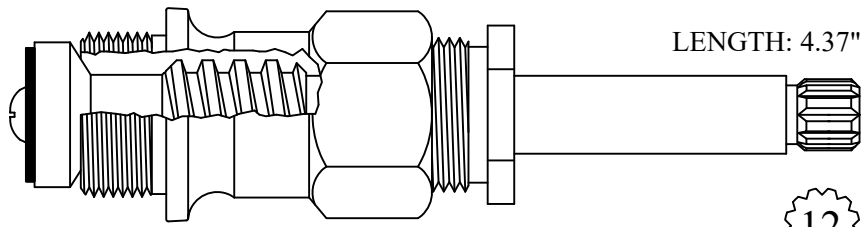

LENGTH: 4.37"

12
1-2

406411 Not Available, Use 415501

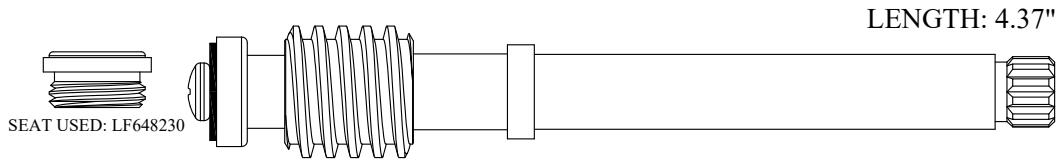

LENGTH: 4.37"

SEAT USED: LF648230

12
1-2

LF271101

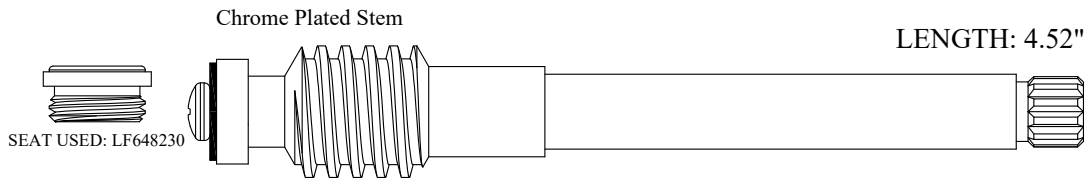

Chrome Plated Stem

LENGTH: 4.52"

SEAT USED: LF648230

12
1-2

LF274201

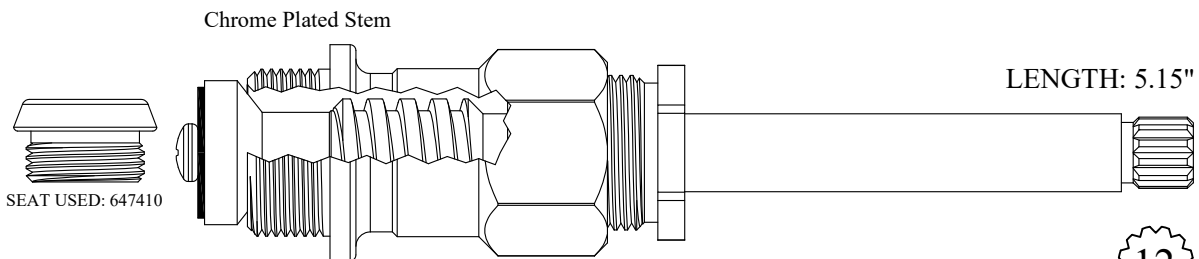

Chrome Plated Stem

LENGTH: 5.15"

SEAT USED: 647410

12
1-2

415501

215501 Stem Only

GASKET INCLUDED: 895400

FOR ARROWHEAD

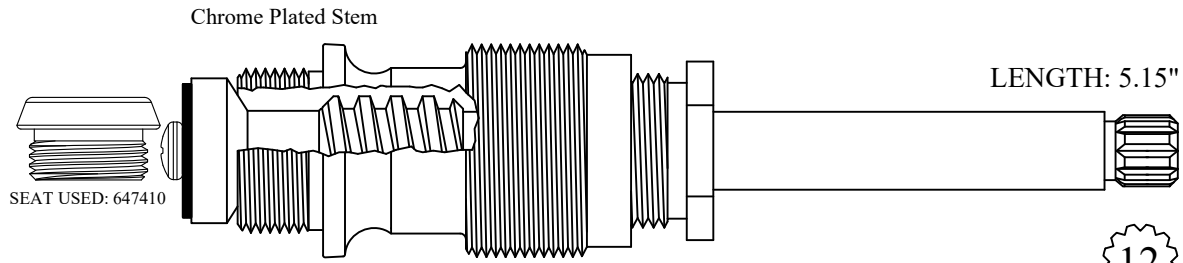

415521 Not Available, Use 415501

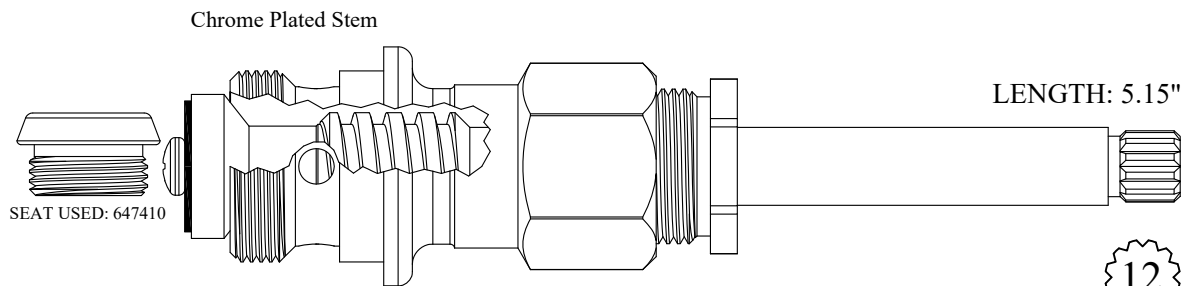

432401
215501 Stem Only
GASKET: 895550

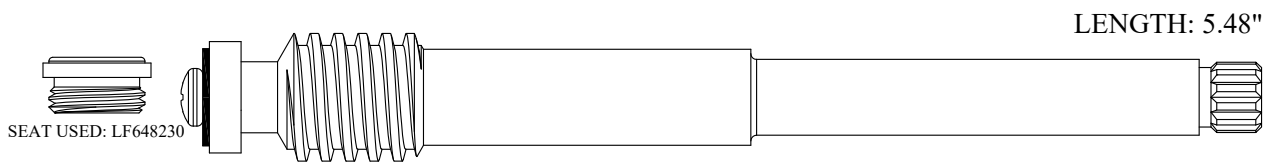

LF280081

BARRY E.  WALTER  SR. CO.

FOR ART F

Chrome Plated Stem

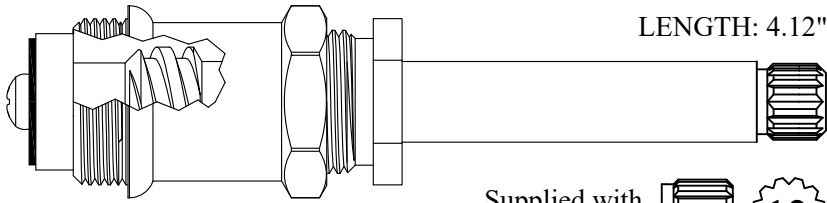

LENGTH: 4.12"

Supplied with
12pt. Broach



404661/ 404662

GASKET INCLUDED: 895400

204661/ 204662 Stem Only



SEAT USED: LF649430

Chrome Plated Stem

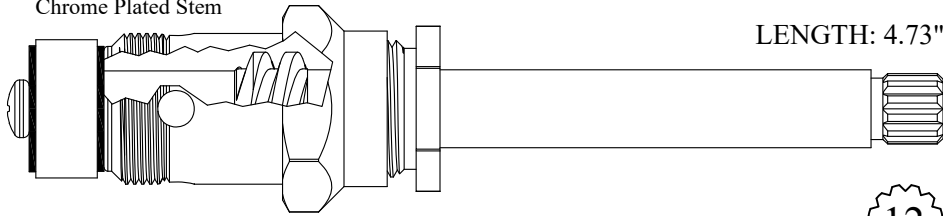

LENGTH: 4.73"

431362

GASKET INCLUDED: 895170



Chrome Plated Stem

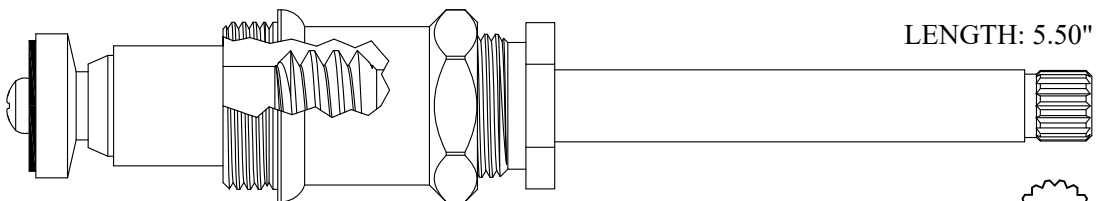

LENGTH: 5.50"

420501

GASKET INCLUDED: 895400

220501 Stem Only

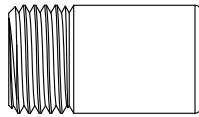

SEAT USED: 649260



Chrome Plated Stem

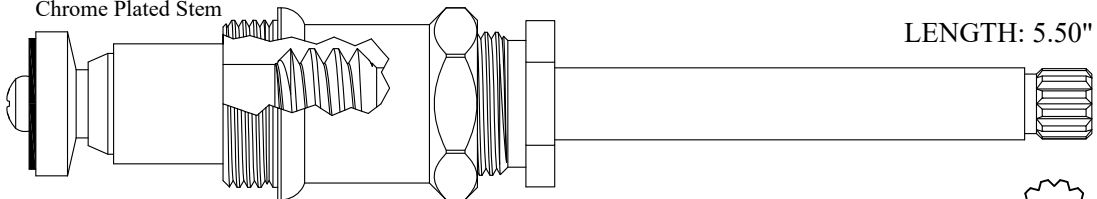

LENGTH: 5.50"

420551

GASKET INCLUDED: 895400

220551 Stem Only

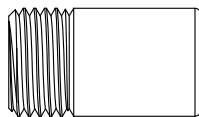

SEAT USED: 649260



FOR ART F

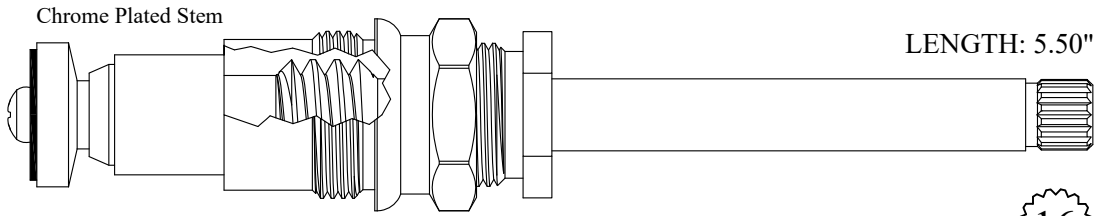

420511
220501 Stem Only
GASKET INCLUDED: 895400



SEAT USED: LF649430

16
1-6

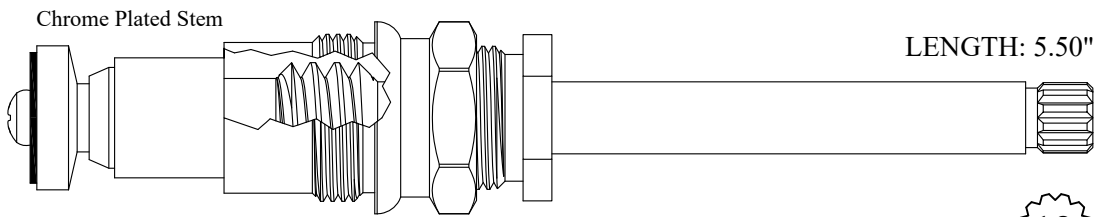

420561
220551 Stem Only
GASKET INCLUDED: 895400

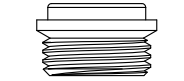

SEAT USED: LF649430

12
1-2

Send Your Orders To:

BARRY E.  SR. CO.

E-mail: orderdesk@barrywalter.com

Fax: 1.800.886.9831

Phone: 1.800.767.5552

FOR ARTISTIC BRASS

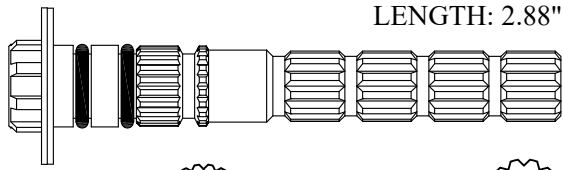

LENGTH: 2.88"

201540

20
2-4

12
1-2

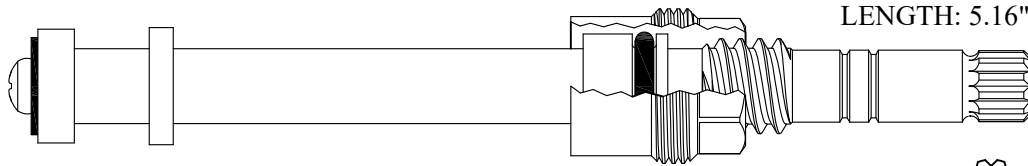

LENGTH: 5.16"

LF479501/ LF479502

GASKET INCLUDED: 895060



SEAT USED: LF648270

12
1-2

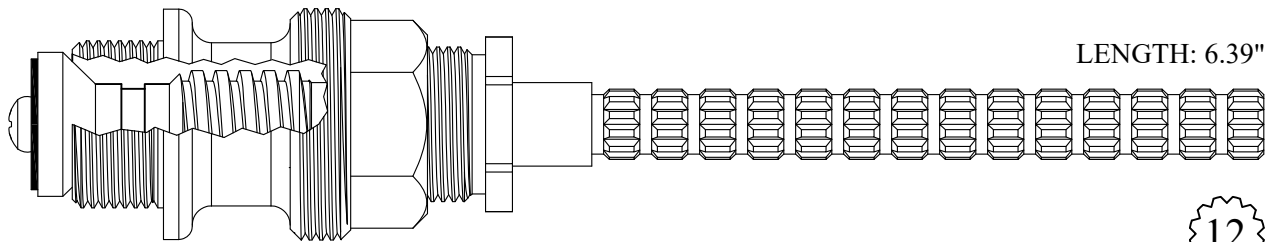

LENGTH: 6.39"

426911/ 426912

GASKET INCLUDED: 895400

226911/ 226912 Stem Only

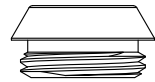

SEAT USED: 648370

12
1-2

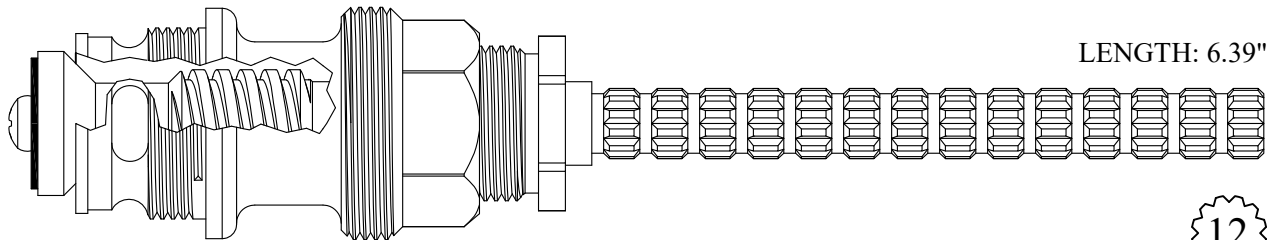

LENGTH: 6.39"

438831

GASKET INCLUDED: 895550

238831 Stem Only



SEAT USED: 648370

12
1-2

FOR ARTISTIC BRASS

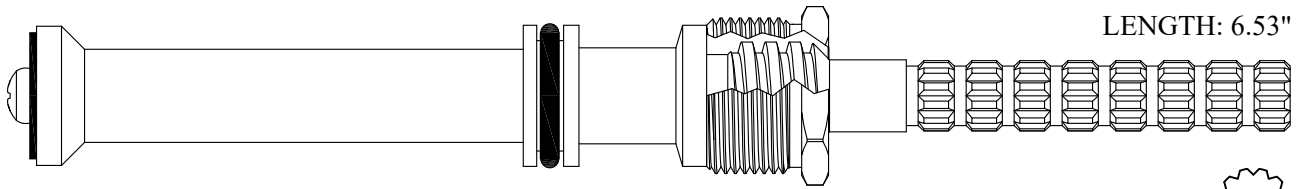

LENGTH: 6.53"

426941/ 426942



SEAT USED: LF648870

12
1-2

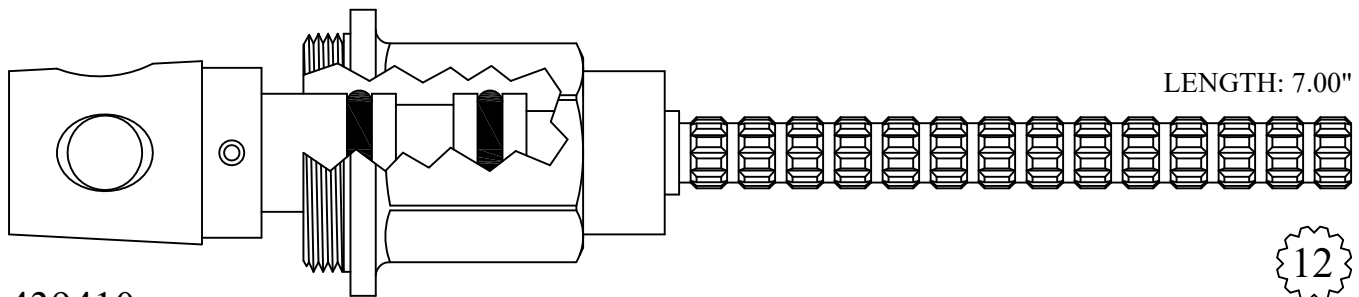

LENGTH: 7.00"

439410
239410 Stem Only

12
1-2

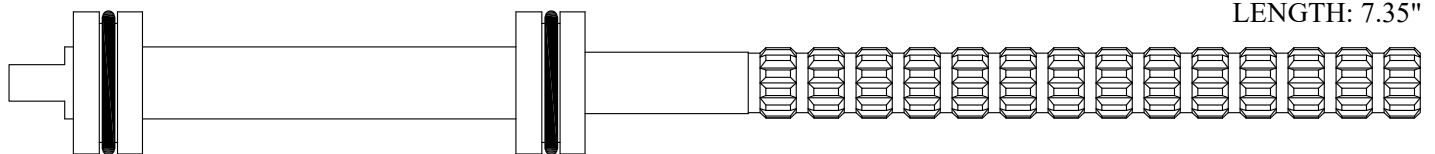

LENGTH: 7.35"

239690

12
1-2

FOR ATLAS

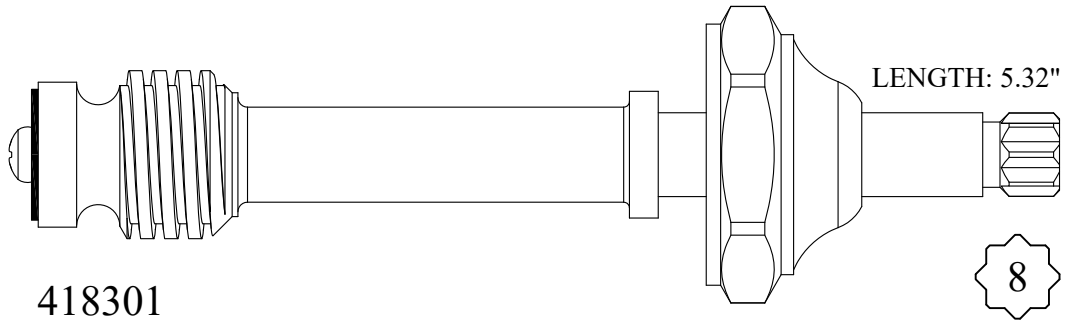

418301
218301 Stem Only

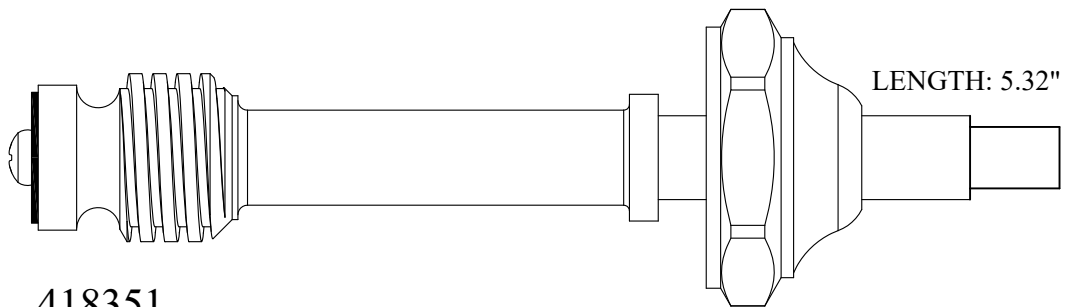

418351
218351 Stem Only

Supplied with
12pt. Broach



12
1-2

Send Your Orders To:

BARRY E.  WALTER  SR. CO.

E-mail: orderdesk@barrywalter.com

Fax: 1.800.886.9831

Phone: 1.800.767.5552

FOR AUBURN BRASS

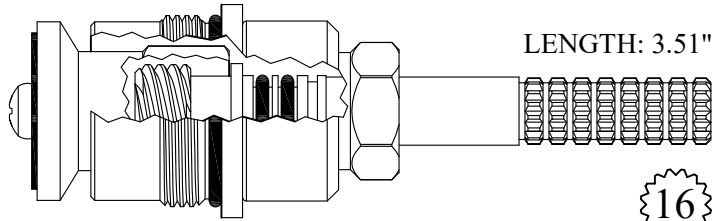

LENGTH: 3.51"

16
2-3

GASKET: 890200 O-RING INCLUDED
403021/ 403022

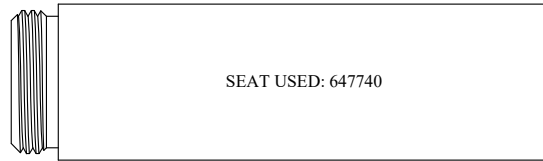

SEAT USED: 647740

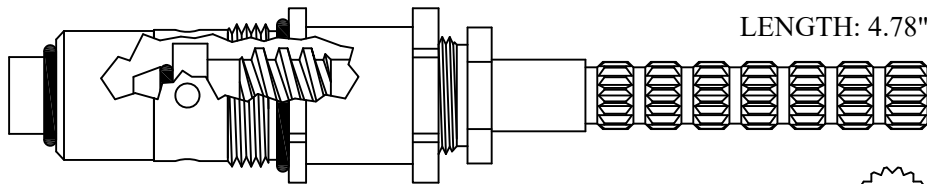

LENGTH: 4.78"

16
2-3

409921/ 409922
GASKET: 890160 O-RING INCLUDED

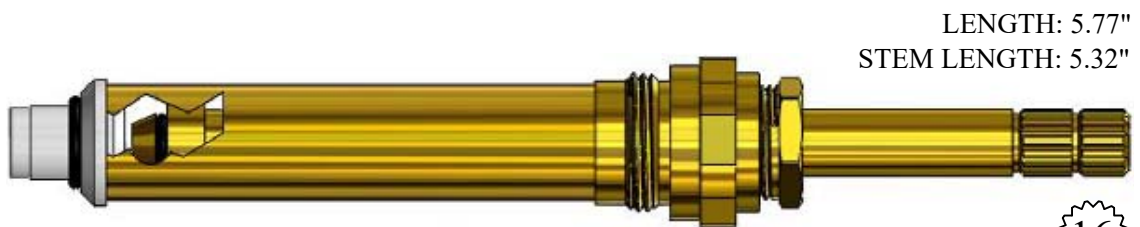

LENGTH: 5.77"
STEM LENGTH: 5.32"

16
2-3

LF480031/ LF480032

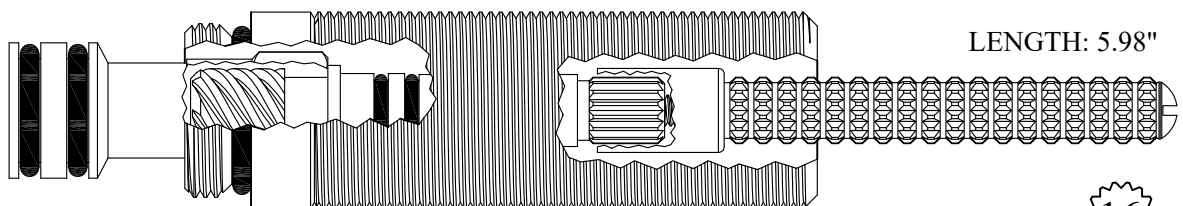

LENGTH: 5.98"

16
2-3

437611
GASKET: 891150 O-RING INCLUDED

FOR AUBURN BRASS

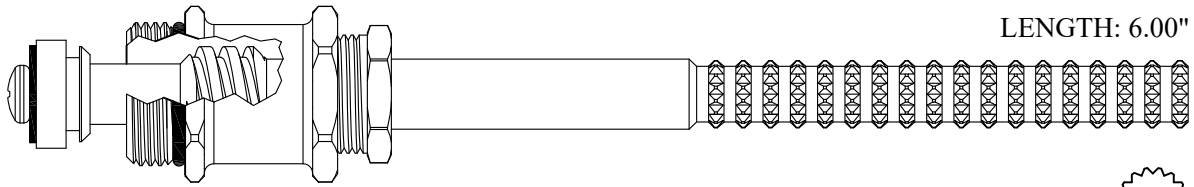

LENGTH: 6.00"

425811/ 425812
225811/ 225812 Stem Only
GASKET: 891150 O-RING INCLUDED



SEAT USED: LF647450

16
2-3

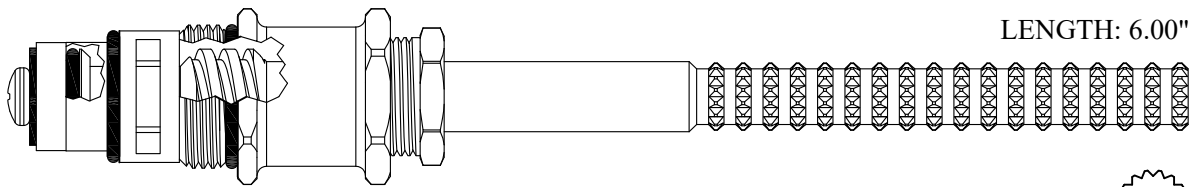

LENGTH: 6.00"

436611
225811 Stem Only
GASKET: 891150 O-RING INCLUDED



SEAT USED: LF647450

16
2-3

FOR A.Y. McDONALD

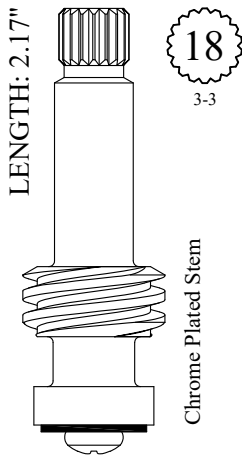

LENGTH: 2.17"

18
3-3

Chrome Plated Stem

LF261161
LF261162

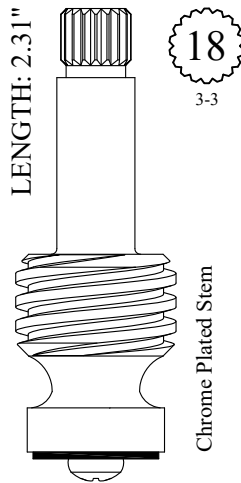

LENGTH: 2.31"

18
3-3

Chrome Plated Stem

LF262341
LF262342

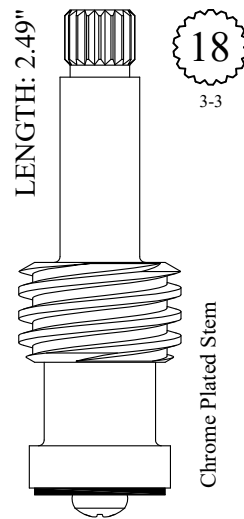

LENGTH: 2.49"

18
3-3

Chrome Plated Stem

LF264281
LF264282

FOR A.Y. McDONALD

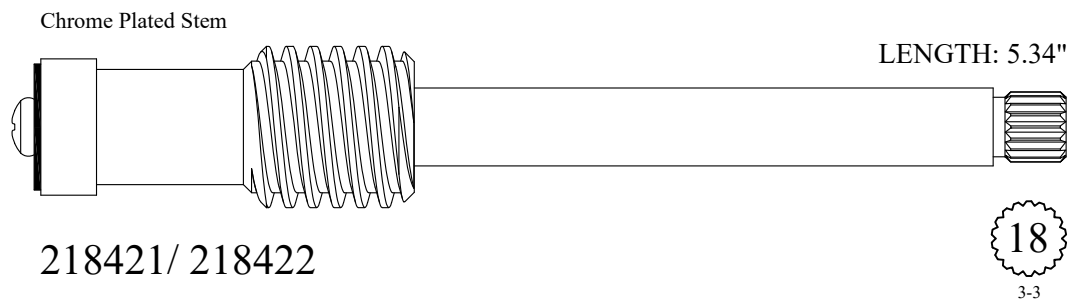
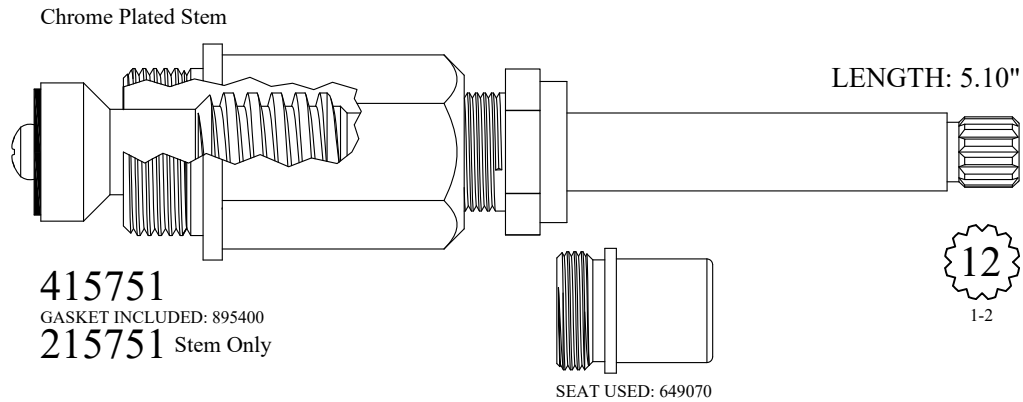
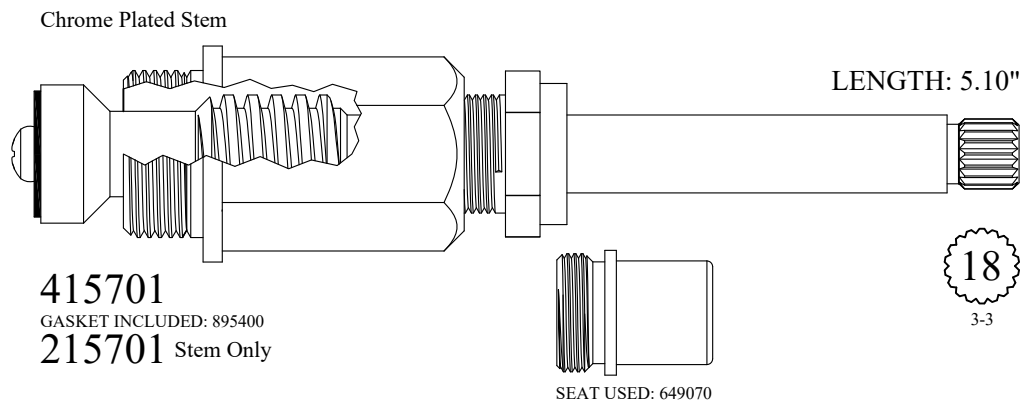
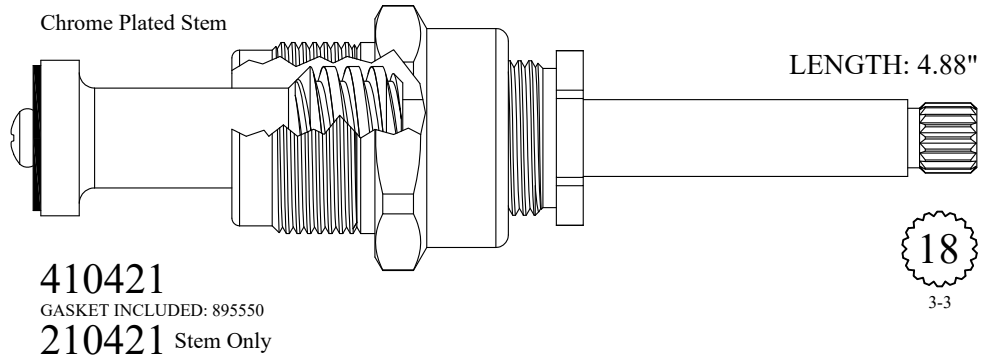

FOR BANNER

1300DIVBOOT



Replacement Boot Only

STEM LENGTH: 2.92"



1300DIVERTER

Complete Diverter with Black Rubber Boot



1300DIV

Diverter WITHOUT Boot

Chrome Plated Stem

LENGTH: 4.80"

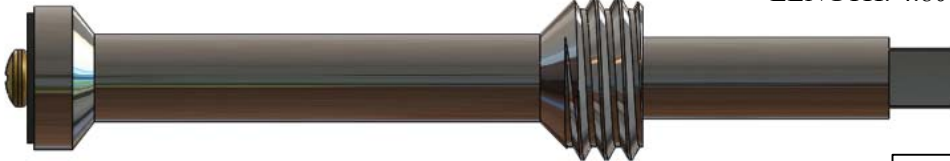

209201

.310

FOR BARBER WILSON

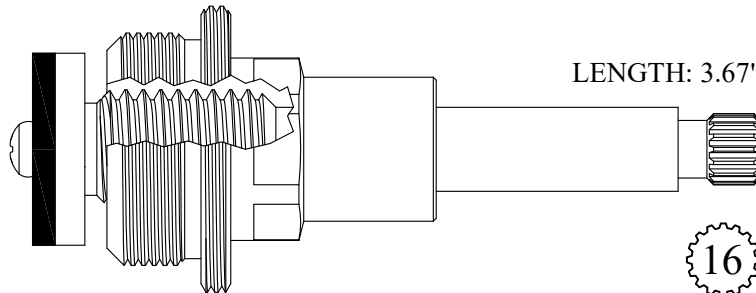

LENGTH: 3.67"

404541

16

3-16

FOR BARDES

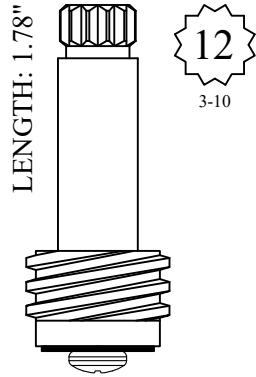

LF254001
LF254002



LF464241
LF464242
LF264241 Stem Only
LF264242 Stem Only

FOR BARNES

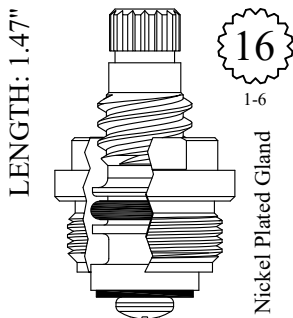

GASKET: 895100

LF452051
LF452052



SEAT USED: LF648350

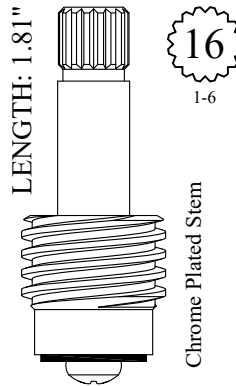

LF260131
LF260132



SEAT USED: LF648350

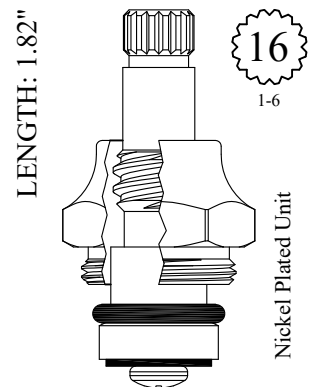

LF456051
LF456052



SEAT USED: LF648350

FOR BARNES

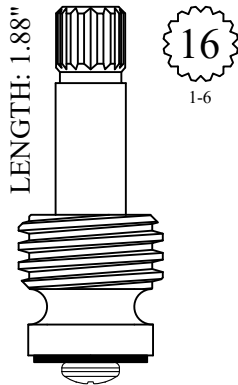

LF256101
LF256102

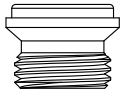

SEAT USED: LF648350

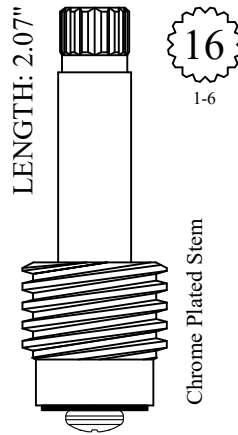

LF263101
LF263102

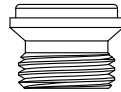

SEAT USED: LF648350

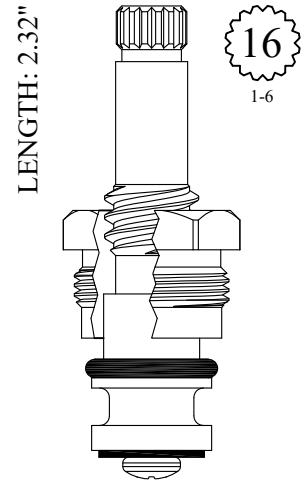

LF462061



SEAT USED: LF648350

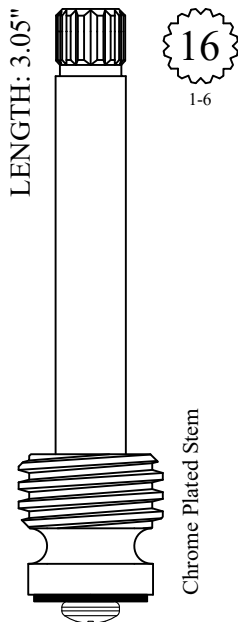

LF266121
LF266122



SEAT USED: LF648350

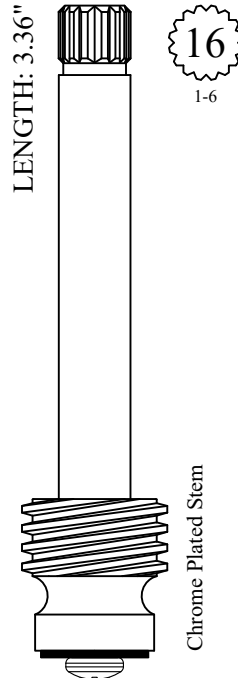

LF269121
LF269122



SEAT USED: LF648350

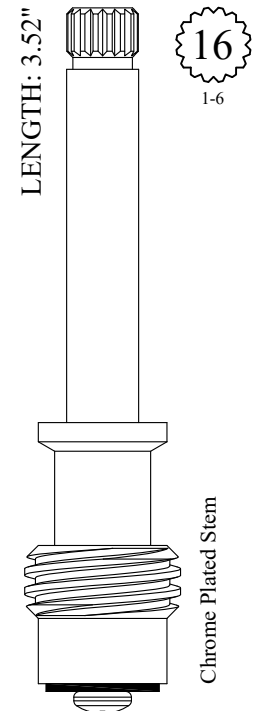

LF268001
LF268002



SEAT USED: LF648350

FOR BARNES

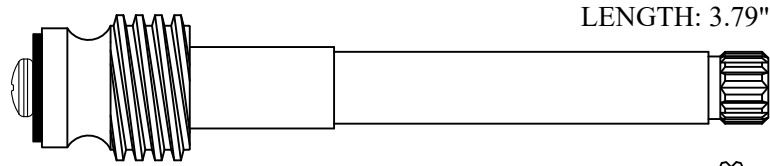

LF268141/ LF268142

16
1-6

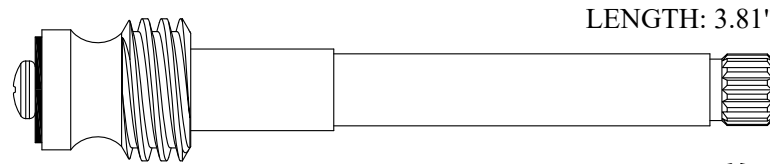

LF269061/ LF269062

16
1-6

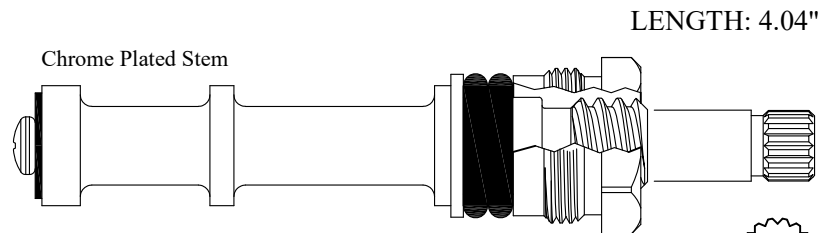

403711
203711 Stem Only

16
1-6

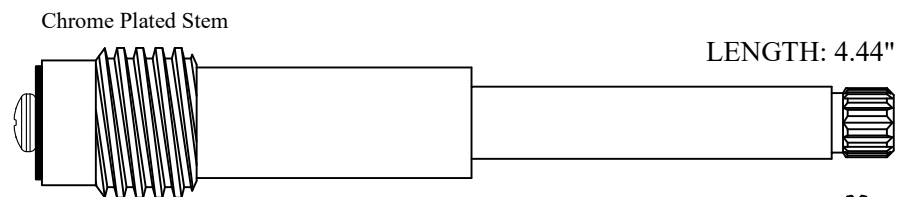

LF271031/ LF271032

16
1-6

FOR BARNES

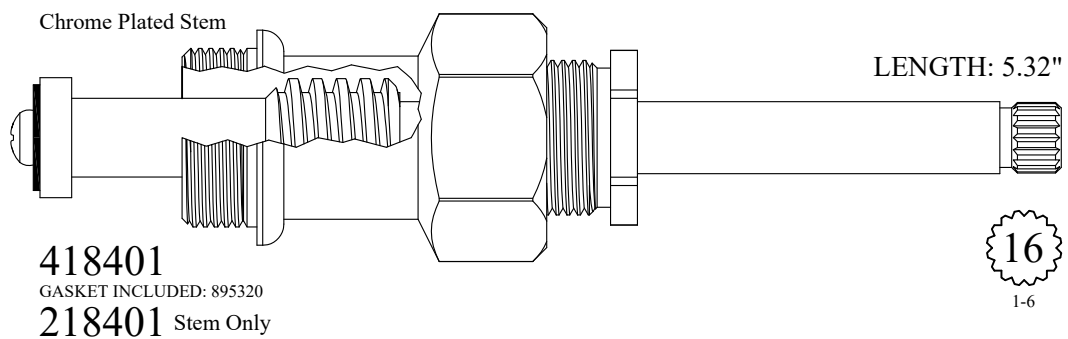
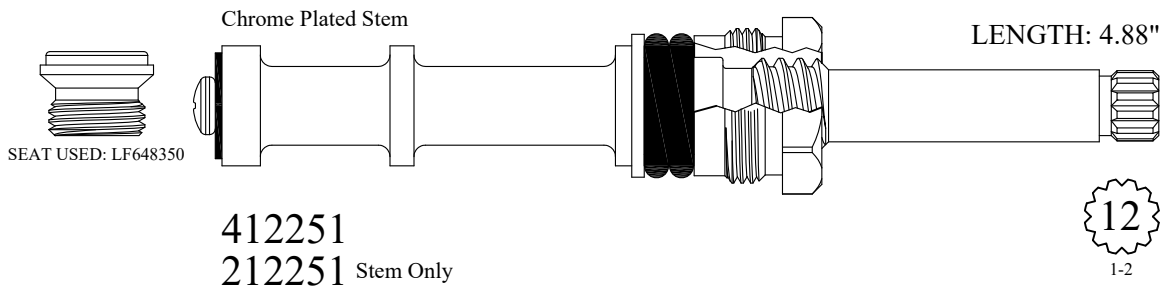
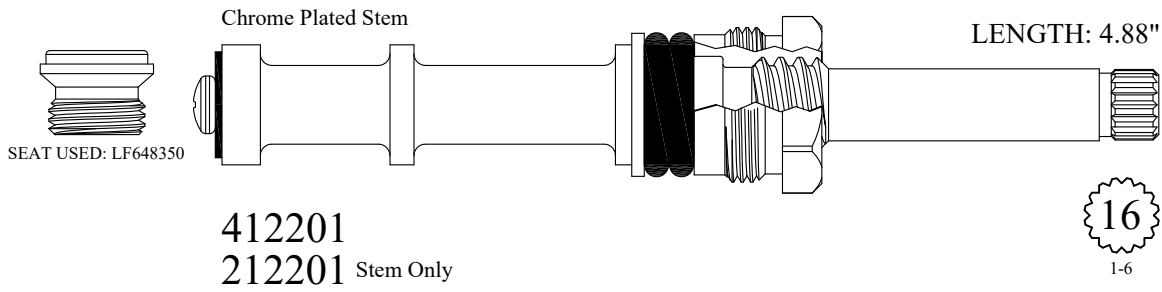
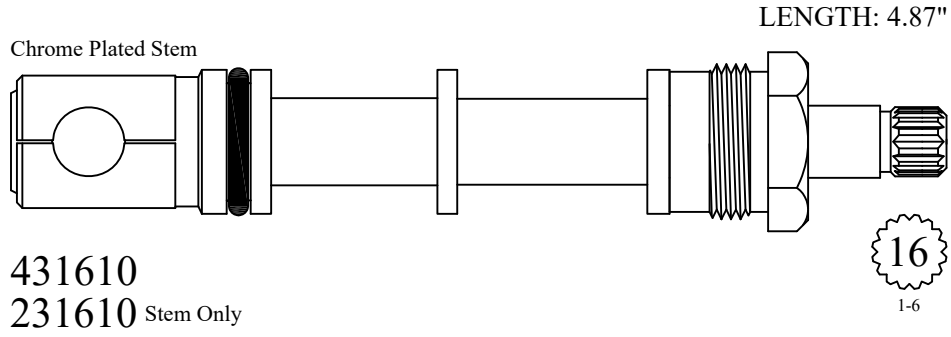

FOR BARNES

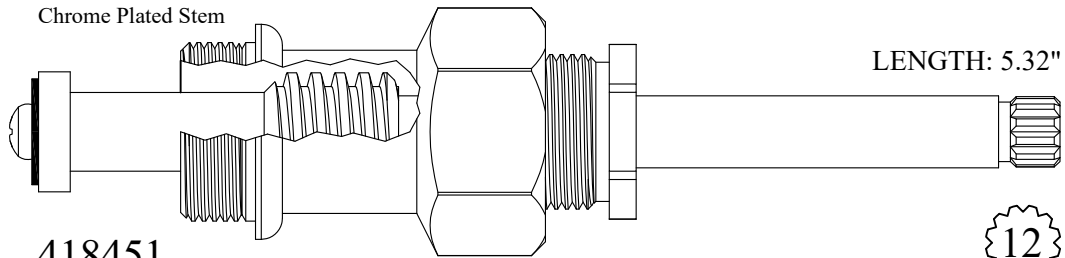

418451
218451 Stem Only
GASKET INCLUDED: 895320

12
1-2

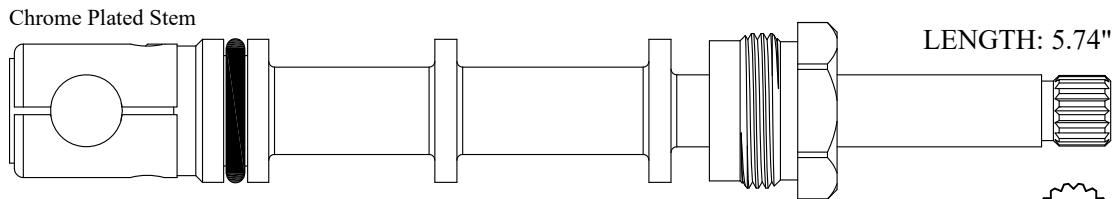

435010
235010 Stem Only

16
1-6

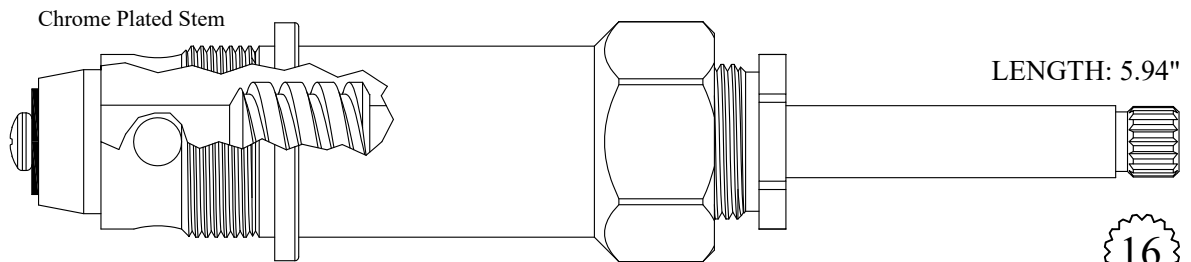

437601
237601 Stem Only

16
1-6

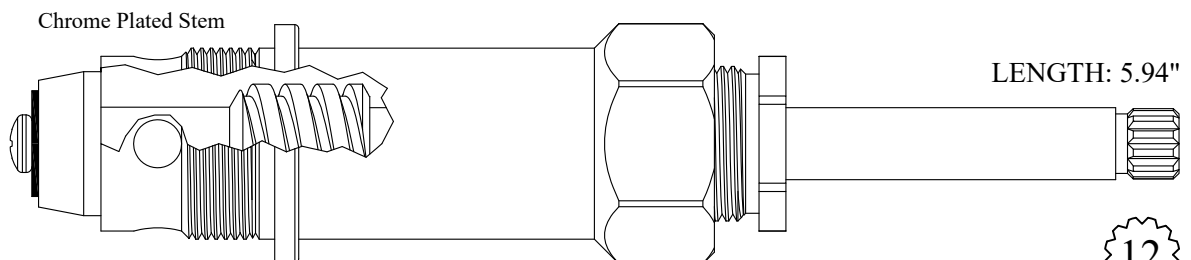

437651
237651 Stem Only

12
1-2

FOR BEAR BRAND

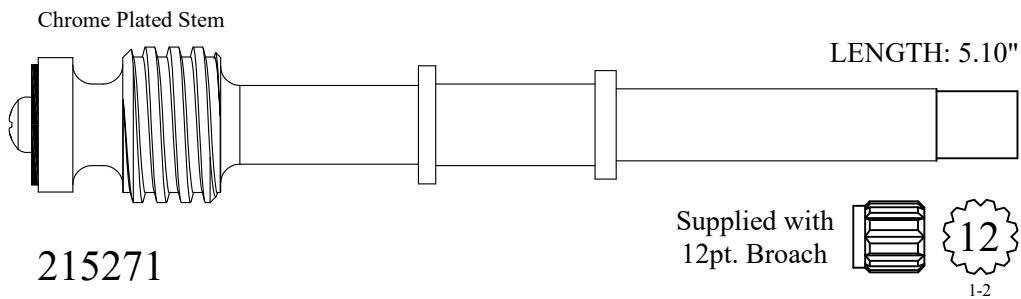
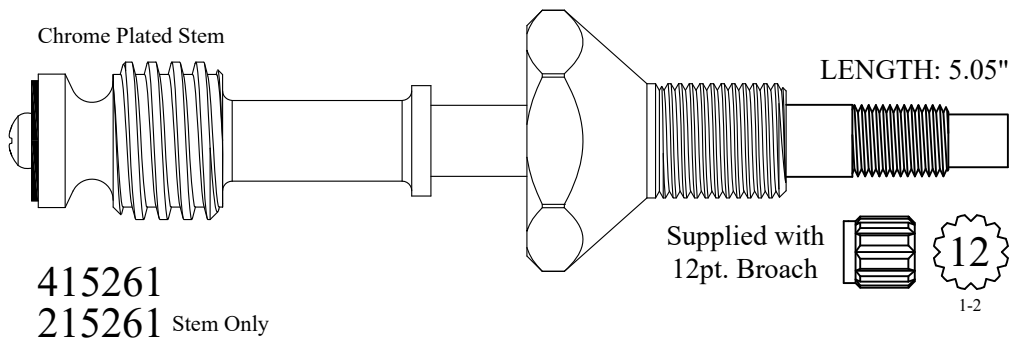
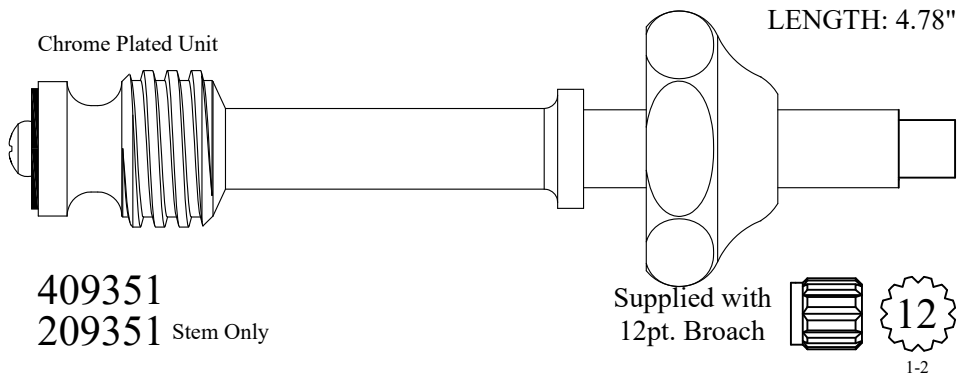

BARRY E.  WALTER  SR. CO.

FOR BELVEDERE

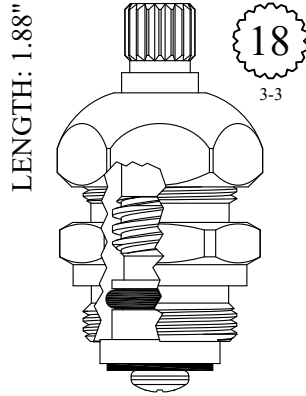

GASKET INCLUDED: 895150

LF456131
LF456132

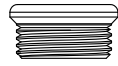

SEAT USED: LF648500

FOR BLOCK BRASS

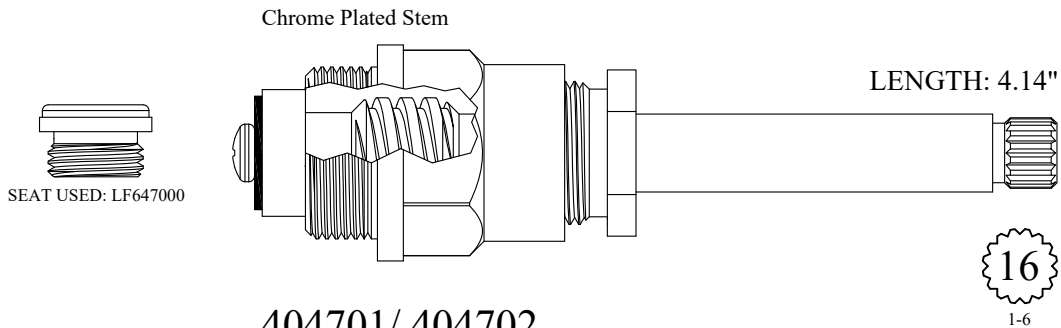

404701/ 404702

GASKET INCLUDED: 895290

204701/ 204702 Stem Only

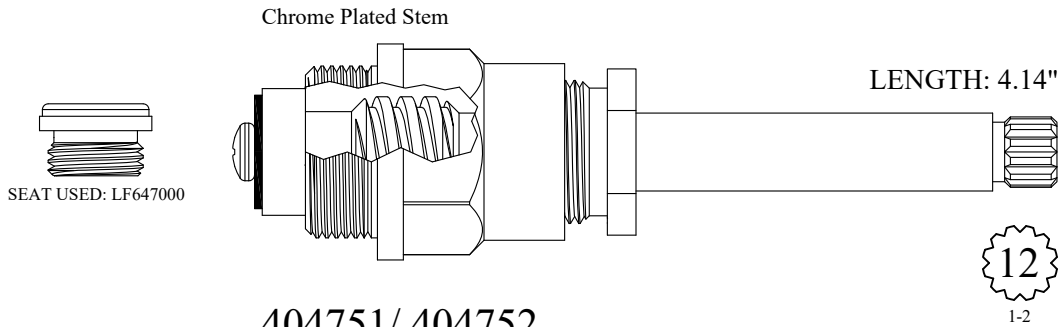

404751/ 404752

GASKET INCLUDED: 895290

204751/ 204752 Stem Only

FOR BLOCK BRASS

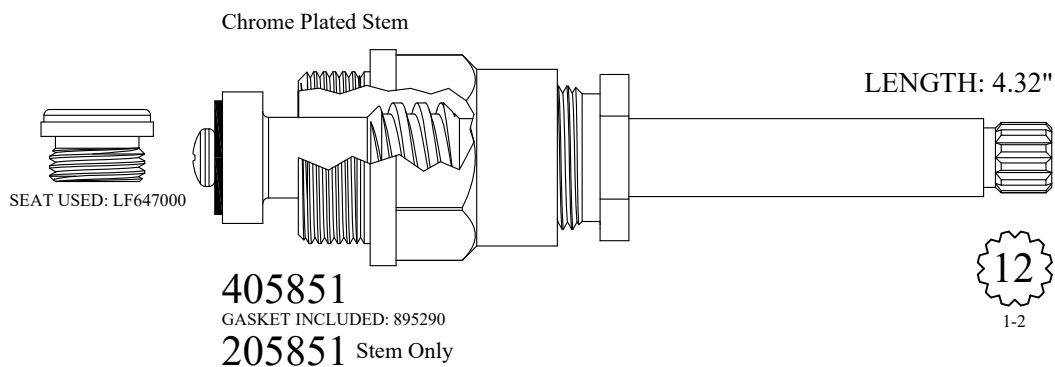
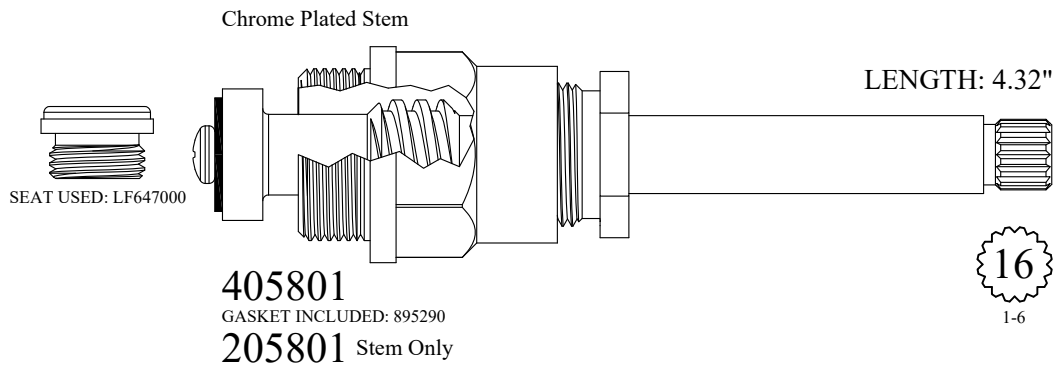
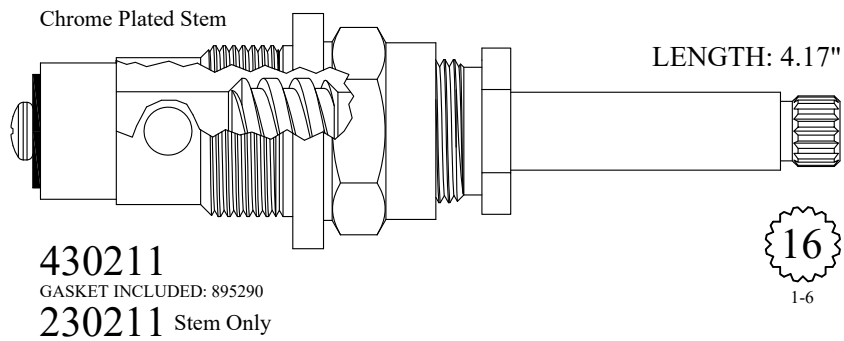
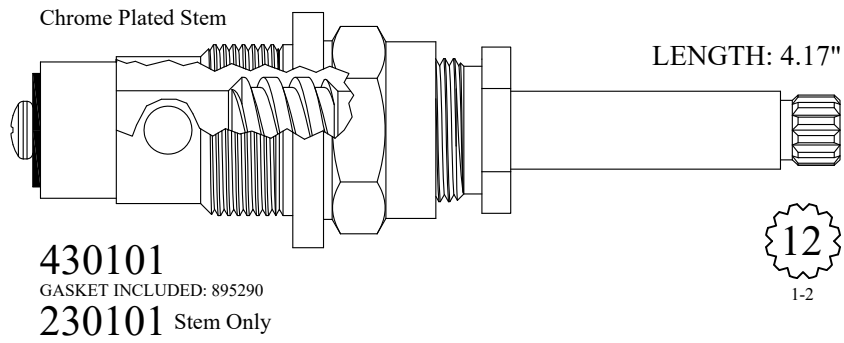

FOR BLOCK BRASS

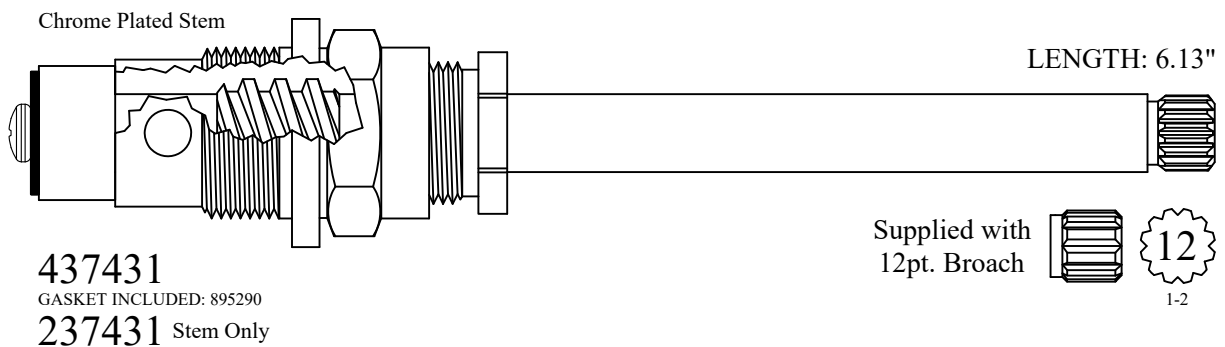
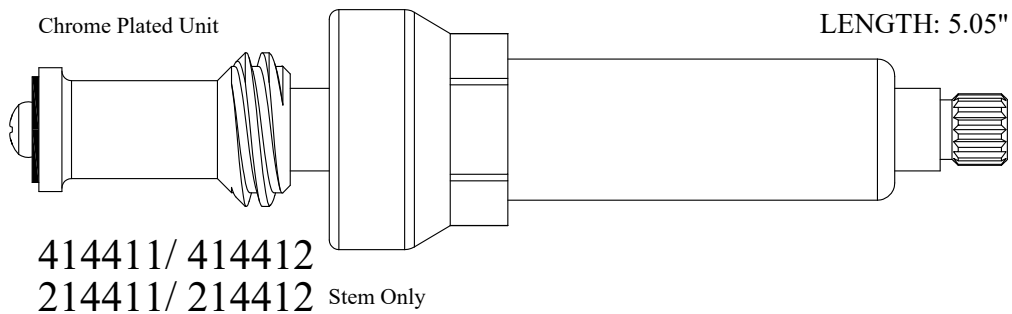
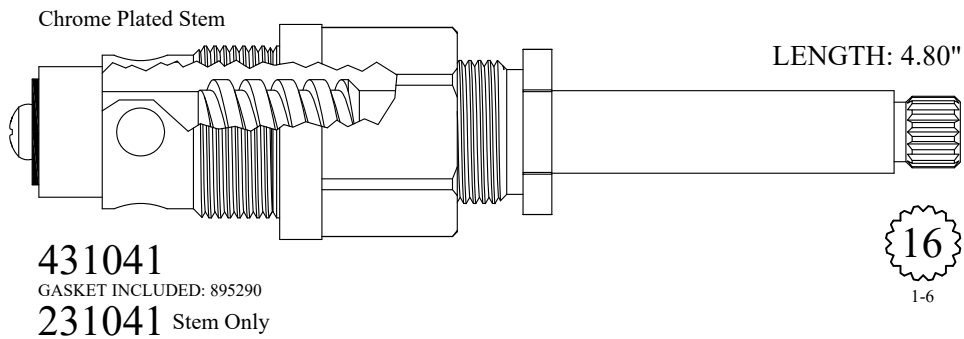

Send Your Orders To:

E-mail: orderdesk@barrywalter.com

Fax: 1.800.886.9831

Phone: 1.800.767.5552

FOR BORG-WARNER

LENGTH: 1.56"
Chrome Plated Stem

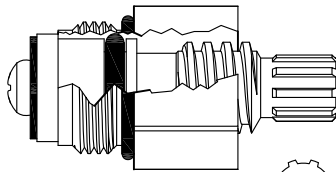

LF452861

GASKET: 890160 O-RING INCLUDED

LENGTH: 2.09"

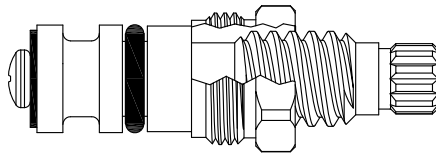

LF459091/ LF459092

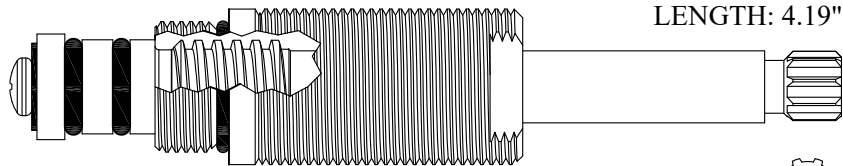

LENGTH: 4.19"



405011

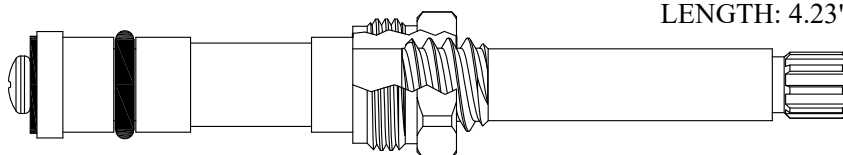

LENGTH: 4.23"



LF470801

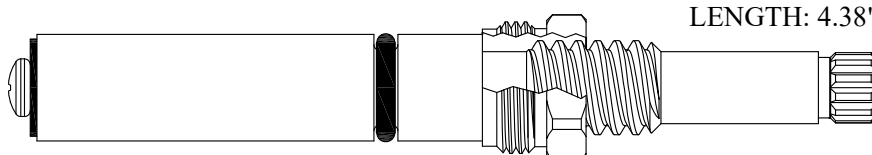

LENGTH: 4.38"



406311/ 406312

FOR BRADLEY

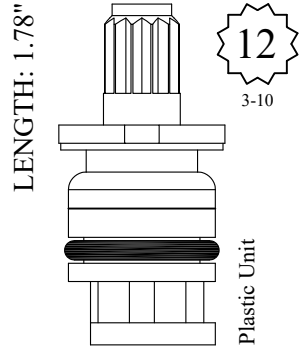

453201
OEM # 400-08190 or P402

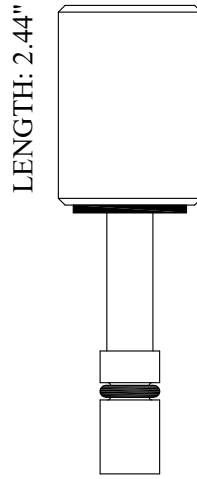

LF173770

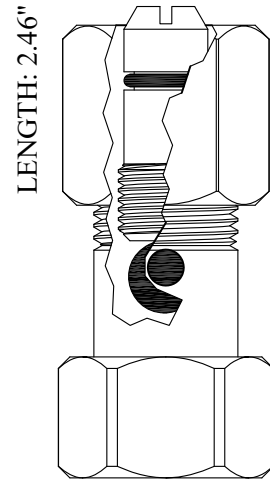

GASKET INCLUDED: 895100

LF126480

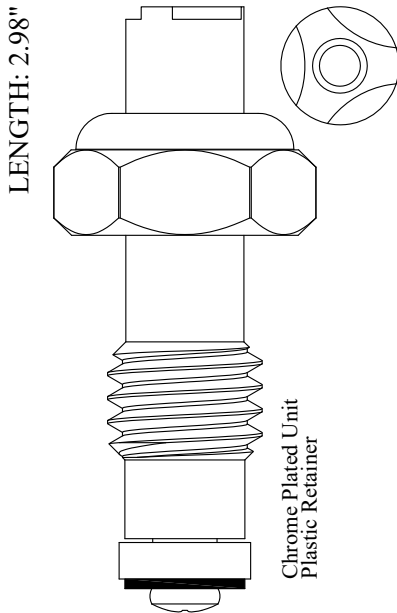

401731
201731 Stem Only
OEM # S21-020

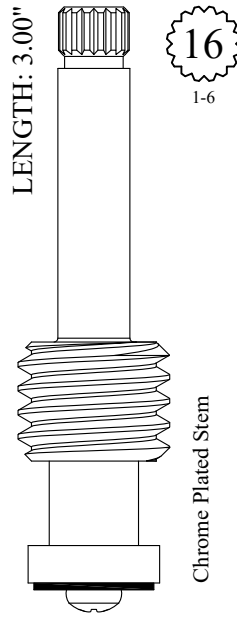

201841

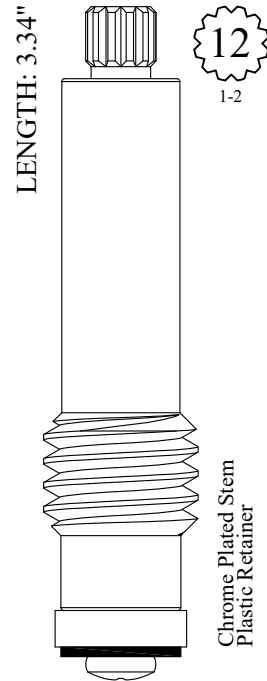

201771

FOR BRADLEY

Chrome Plated Stem

LENGTH: 3.38"

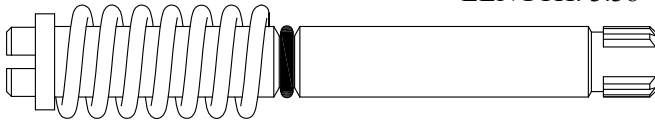

202690

OEM # S21-065 (Old number: S21-040)

Special 12pt Broach w/
2 splines missing on each
side to make an 8pt Broach

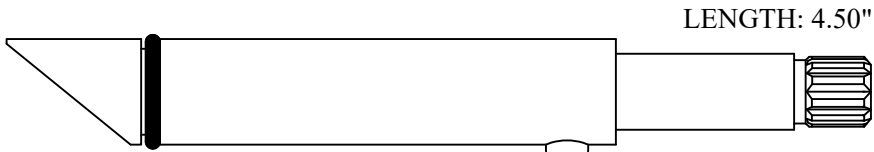

LENGTH: 4.50"

230620



3-10

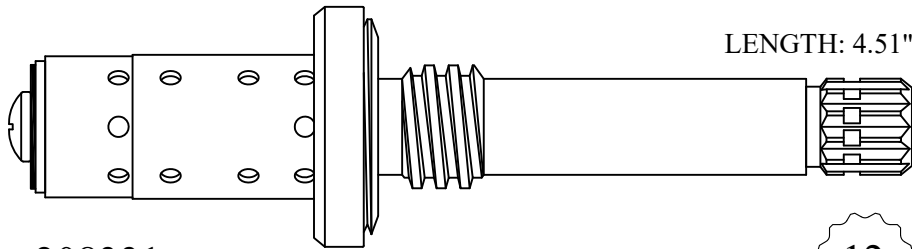

LENGTH: 4.51"

208331

OEM # BW-5

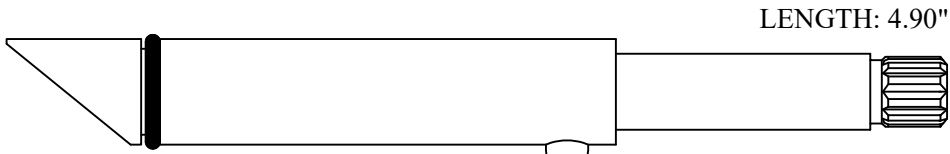

LENGTH: 4.90"

231530



3-10

FOR BRIGGS

LENGTH: 1.40"

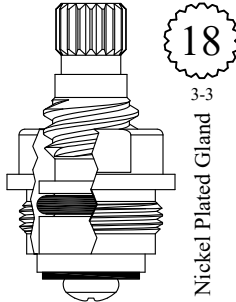

GASKET INCLUDED: 895100

LF452031
OEM # DIV10637 RH
LF452032
OEM # DIV10637 LH



SEAT USED: LF648120

LENGTH: 1.63"

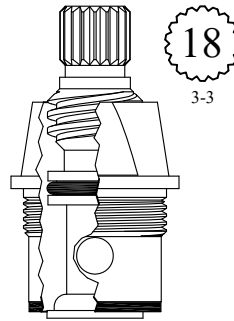

GASKET INCLUDED: 895100

LF453031
OEM # DIV10636 RH
LF453032
OEM # DIV10636 LH

LENGTH: 1.75"

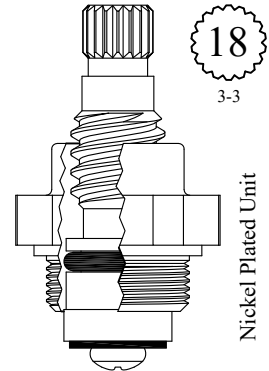

GASKET INCLUDED: 895100

LF454101
OEM # DIV10653 RH
LF454102
OEM # DIV10653 LH

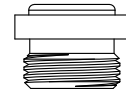

SEAT USED: LF648120

LENGTH: 1.95"

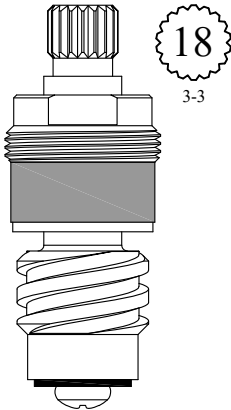

LF457131
LF457132
LF257131 Stem Only
OEM # 6647
LF257132 Stem Only
OEM # 6648



SEAT USED: LF648120

LENGTH: 2.00"

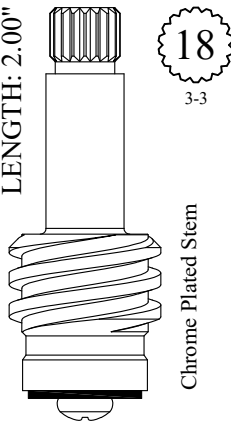

LF255181
LF255182

LENGTH: 2.08"

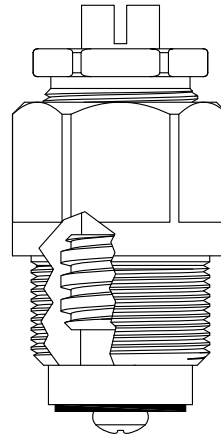

GASKET INCLUDED: 895370

401461
201461 Stem Only
OEM # 3573

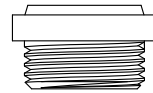

SEAT USED: 647650

LENGTH: 2.16"

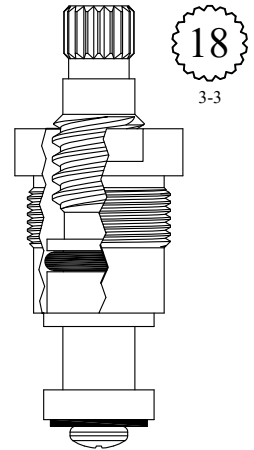

GASKET INCLUDED: 895100

LF461011
OEM # DIV10535 RH
LF461012
OEM # DIV10535 LH

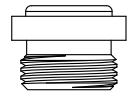

SEAT USED: LF648120

FOR BRIGGS

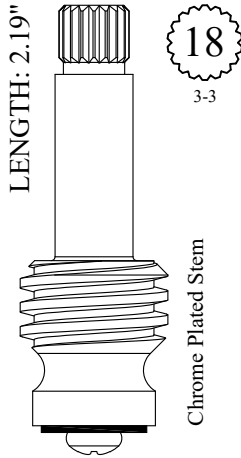

201221



SEAT USED: LF649790
OEM # 6761

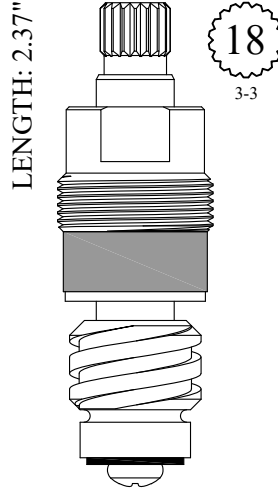

LF463111

LF463112

LF263111 Stem Only

OEM # 22097

LF263112 Stem Only

OEM # 22098

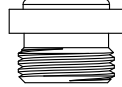

SEAT USED: LF648120

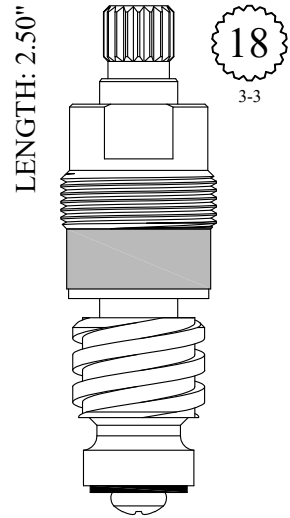

LF464031

LF464032

LF264031 Stem Only

OEM # 22033

LF264032 Stem Only

OEM # 22034

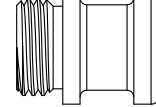

SEAT USED: LF648250

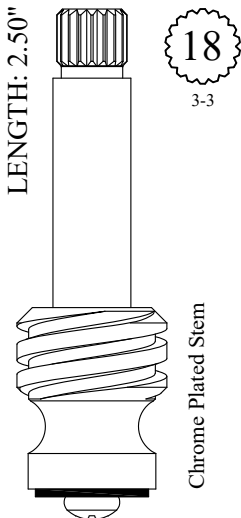

LF263161

OEM # 2779

LF263162

OEM # 2781



SEAT USED: LF648950

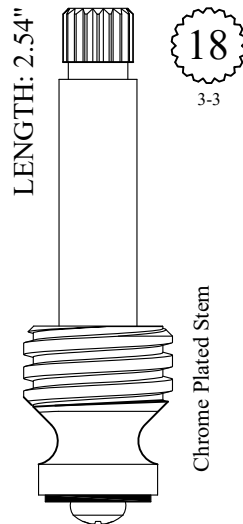

201231

OEM # 2650

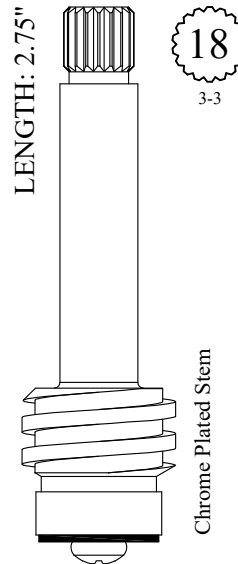

LF265201

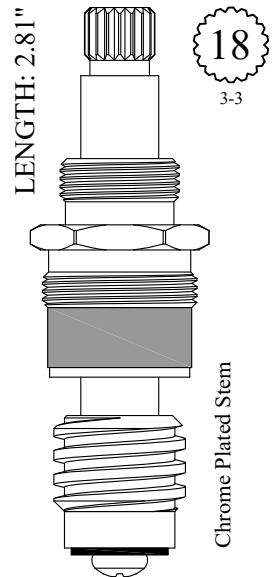

LF465271

LF265271 Stem Only

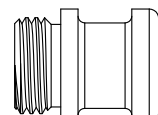

SEAT USED: LF648250

FOR BRIGGS

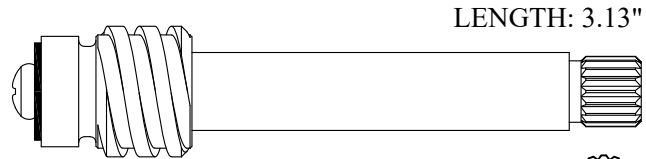

LF267061/ LF267062
OEM # 6612 / 6613



Chrome Plated Stem

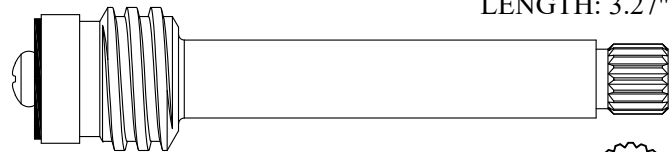

LF267121

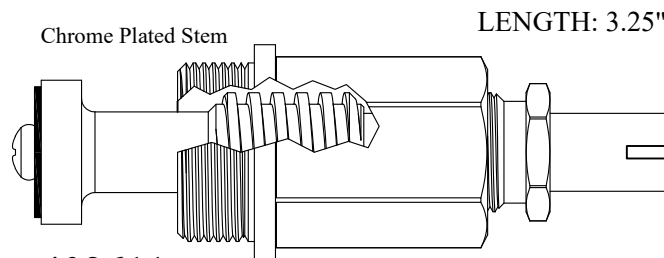
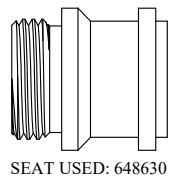

402611
GASKET INCLUDED: 895370
202611 Stem Only
OEM # 6734

Chrome Plated Stem

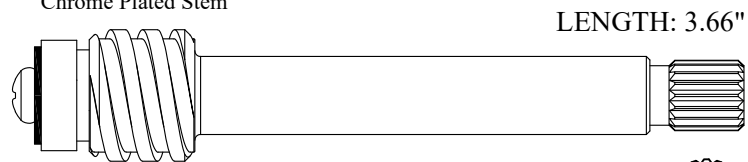

LF269151/ LF269152

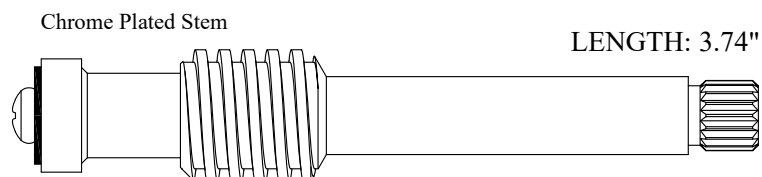
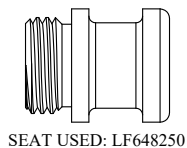
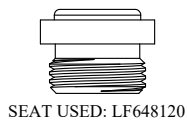

LF269141



FOR BRIGGS

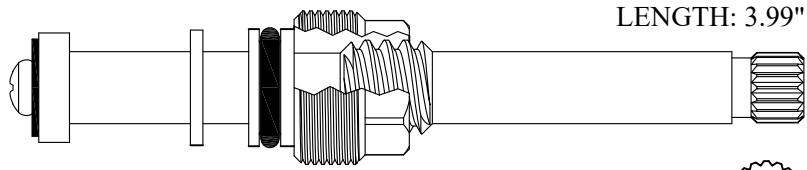

404111/ 404112
OEM # DIV10623

18
3-3

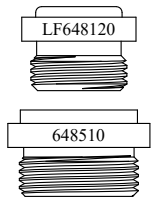

SEAT USED: 648510 or LF648120

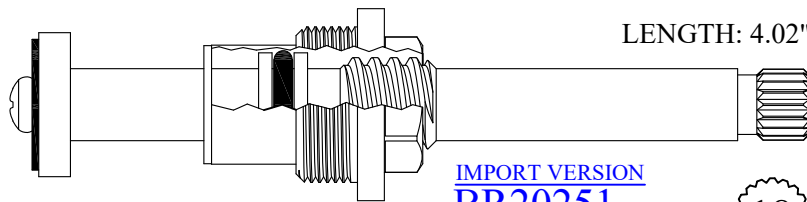

404101/ 404102
OEM # DIV10635
GASKET INCLUDED: 895150

IMPORT VERSION
BR20251

18
3-3

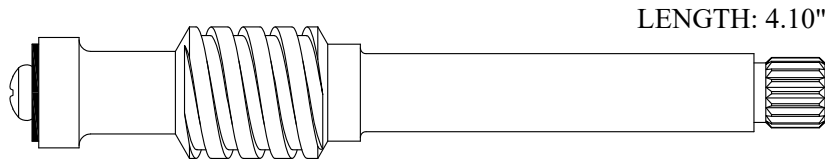
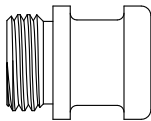

LF271011/ LF271012

18
3-3

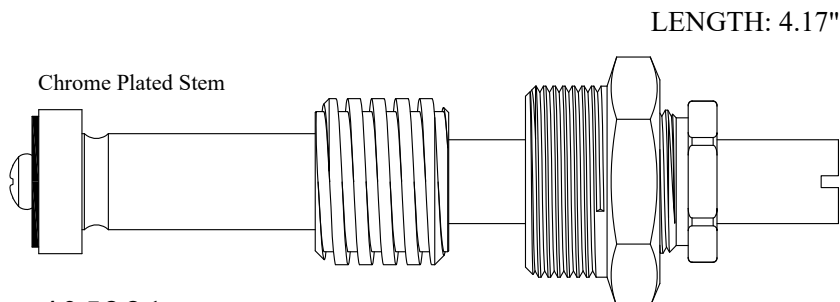

405391
205391 Stem Only
GASKET INCLUDED: 895340

FOR BRIGGS

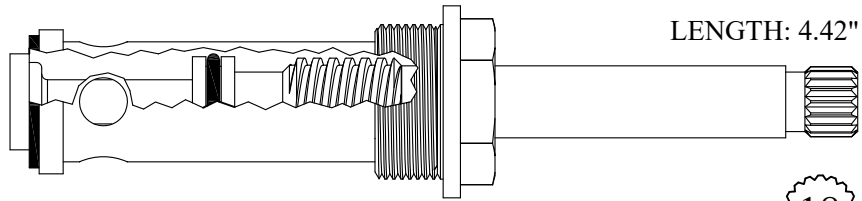

405902
 GASKET INCLUDED: 895150
 OEM # DIV10740

18
 3-3

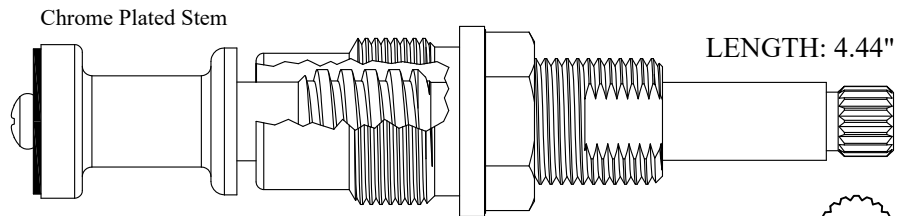

LF471501
 GASKET INCLUDED: 895180
LF271501 Stem Only

18
 3-3

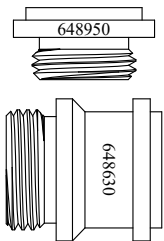

SEAT USED: 648950 or 648630

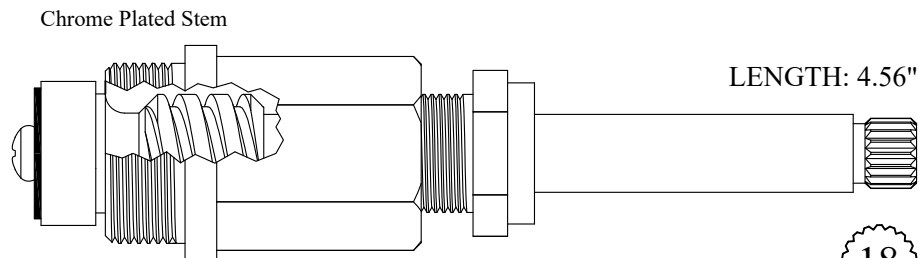

407501/ 407502
 GASKET INCLUDED: 895370
207501/ 207502 Stem Only

18
 3-3

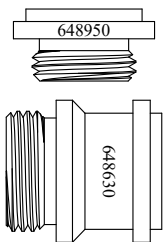

SEAT USED: 648950 or 648630

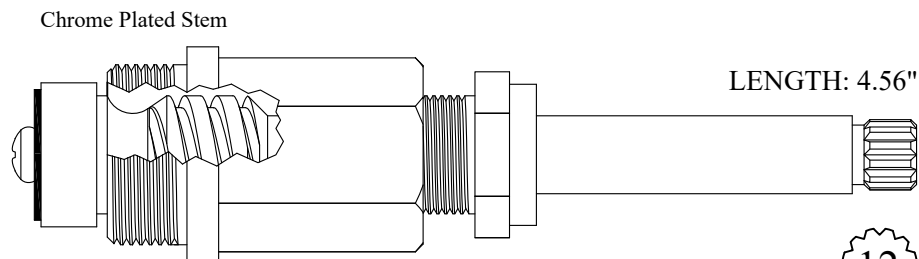

407551/ 407552
 GASKET INCLUDED: 895370
207551/ 207552 Stem Only

12
 1-2

FOR BRIGGS

Chrome Plated Unit

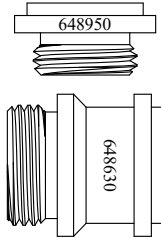

SEAT USED: 648950 or 648630

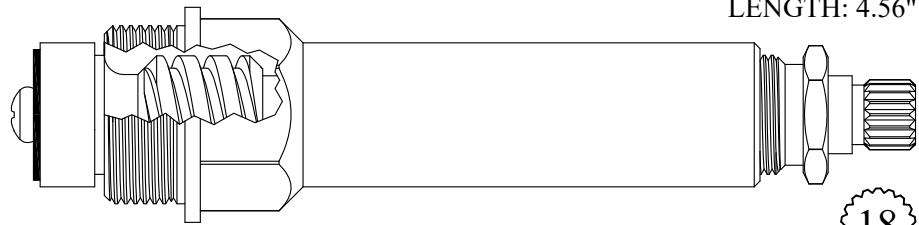

18
3-3

407521/ 407522

GASKET INCLUDED: 895370

207501/ 207502 Stem Only

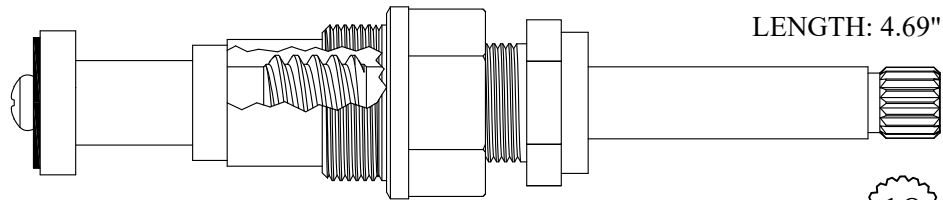
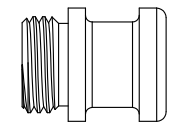

18
3-3

408701

GASKET INCLUDED: 895150

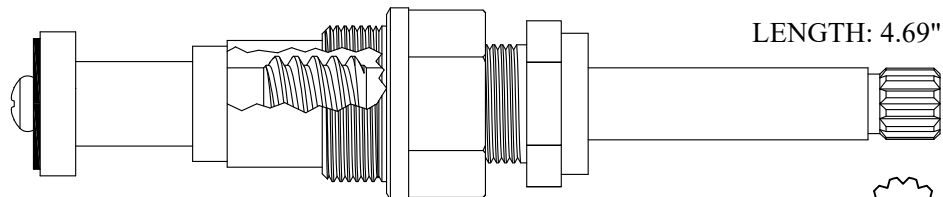
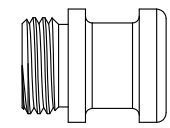

12
1-2

408751

GASKET INCLUDED: 895150

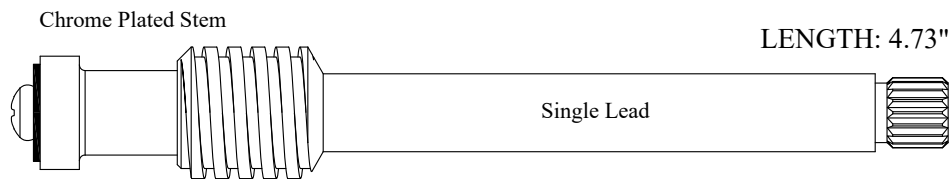
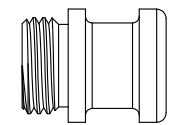

18
3-3

LF275041

OEM # 6336

FOR BRIGGS

Chrome Plated Stem

LENGTH: 4.73"

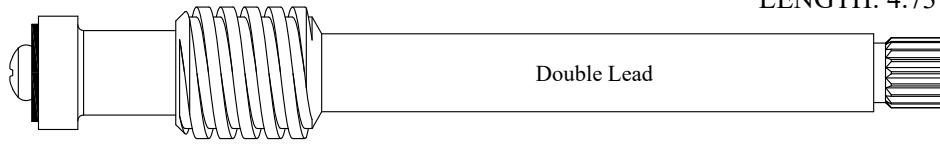

LF275541

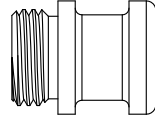

SEAT USED: LF648250

18
3-3

Chrome Plated Unit

LENGTH: 4.83"

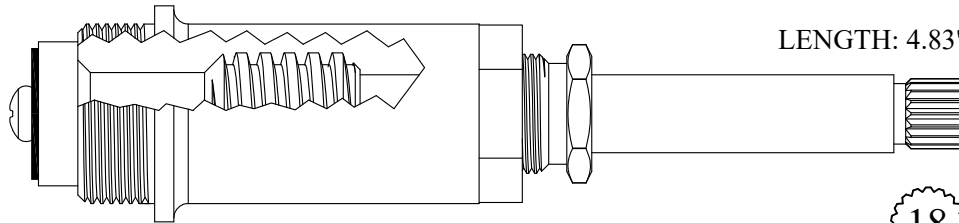

411241
GASKET INCLUDED: 895370
211241 Stem Only

18
3-3

Chrome Plated Stem

LENGTH: 4.84"

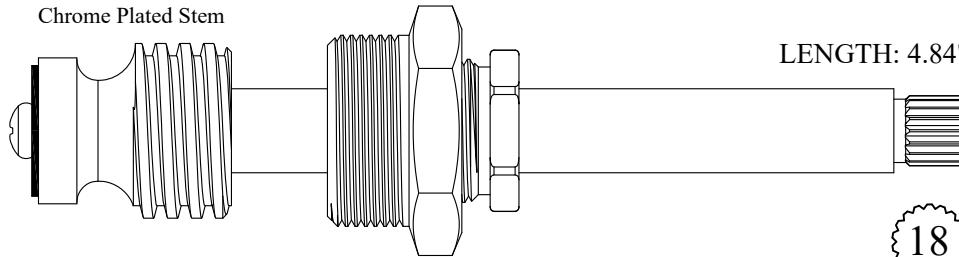

410901
GASKET INCLUDED: 895340
210901 Stem Only

18
3-3

Chrome Plated Stem

LENGTH: 4.84"

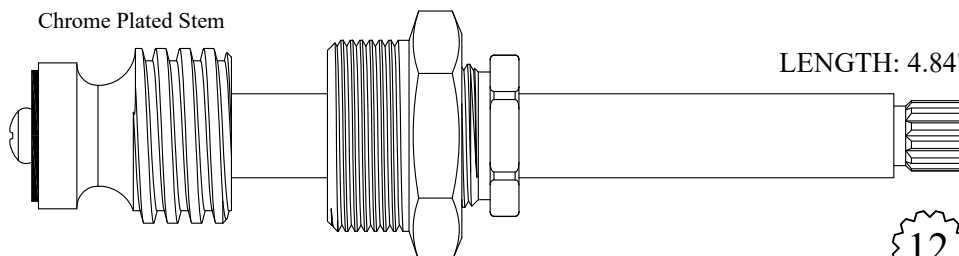

410951
GASKET INCLUDED: 895340
210951 Stem Only

12
1-2

FOR BRIGGS

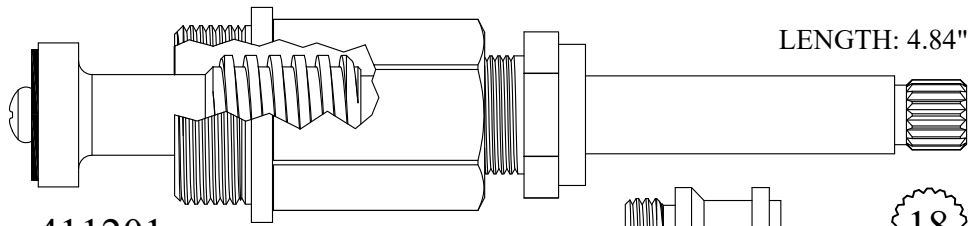

LENGTH: 4.84"

411201

GASKET INCLUDED: 895370
OEM # DIV10204

211201 Stem Only
OEM # 3567

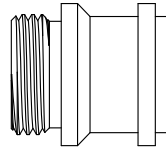

SEAT USED: 648630



OLD DESIGN

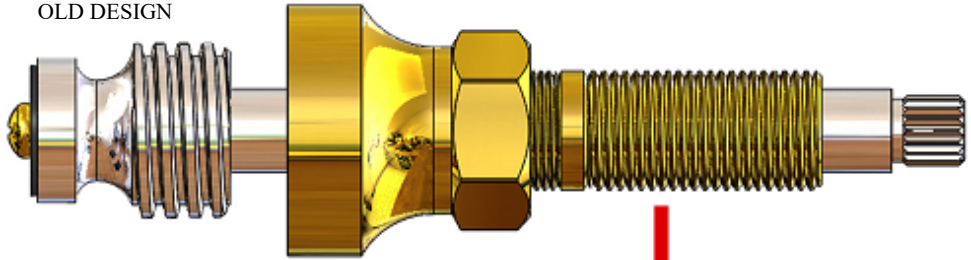

NEW DESIGN
Chrome Plated Unit

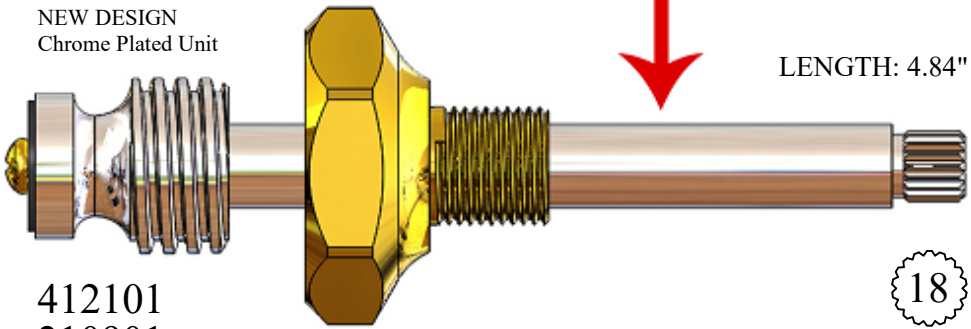

LENGTH: 4.84"

412101

210901 Stem Only



NEW DESIGN
Chrome Plated Unit

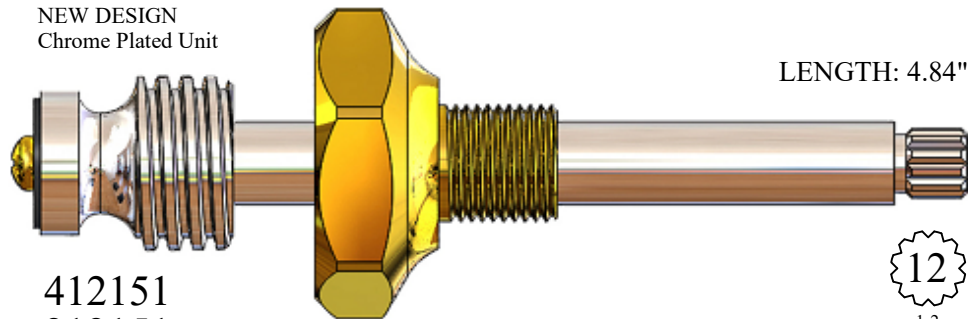

LENGTH: 4.84"

412151

212151 Stem Only



Chrome Plated Unit

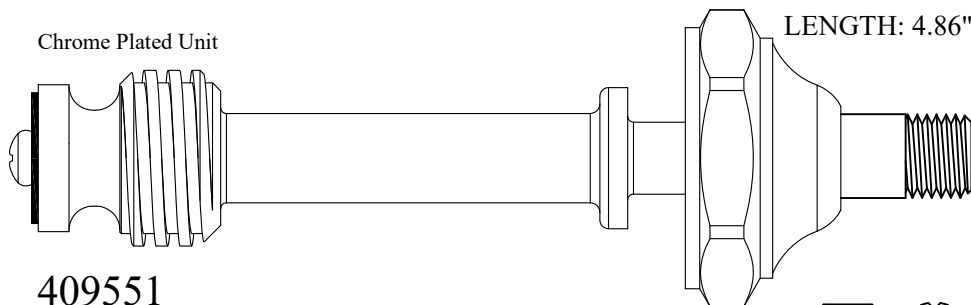

LENGTH: 4.86"

409551

209551 Stem Only

Supplied with
12pt. Broach



FOR BRIGGS

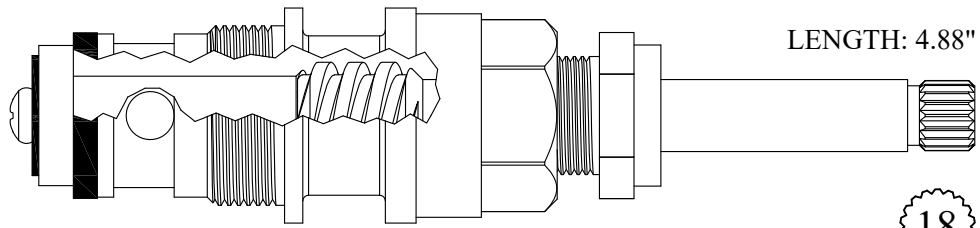

LENGTH: 4.88"

431502

GASKET INCLUDED: 895370

231502 Stem Only

OEM # 3136

18
3-3

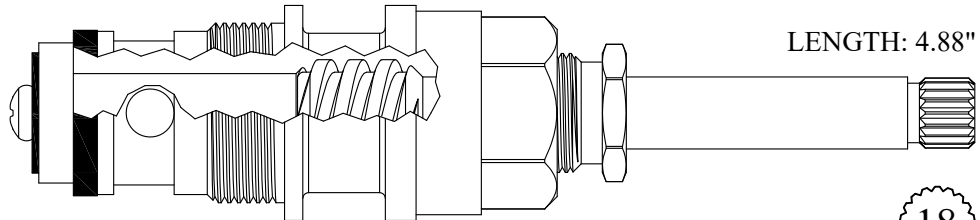

LENGTH: 4.88"

431512

GASKET INCLUDED: 895370

231502 Stem Only

18
3-3

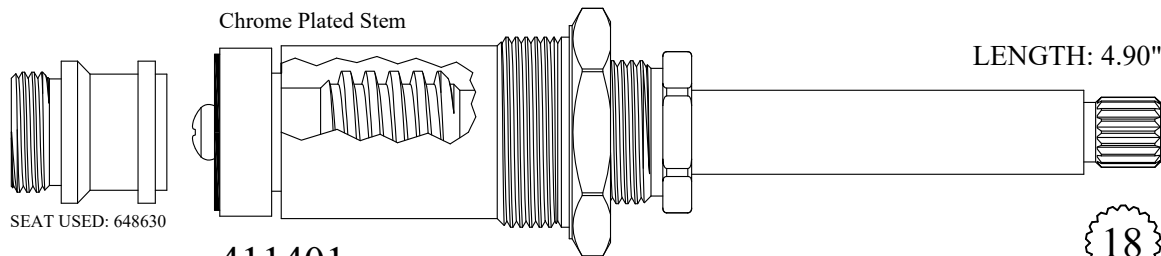

Chrome Plated Stem

LENGTH: 4.90"

SEAT USED: 648630

411401

GASKET INCLUDED: 895340

211401 Stem Only

18
3-3

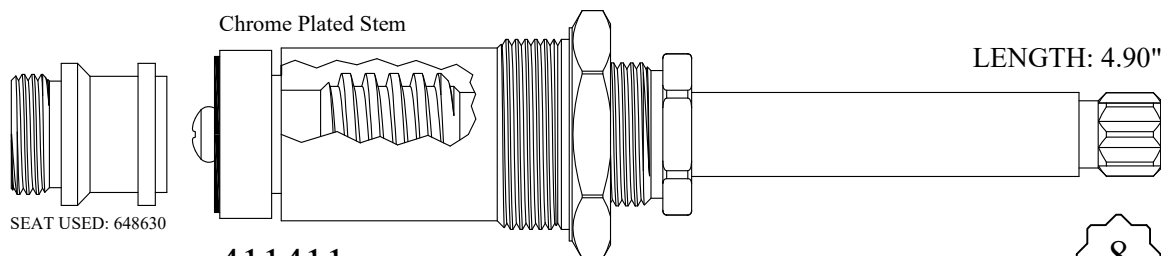

Chrome Plated Stem

LENGTH: 4.90"

SEAT USED: 648630

411411

GASKET INCLUDED: 895340

211411 Stem Only

8

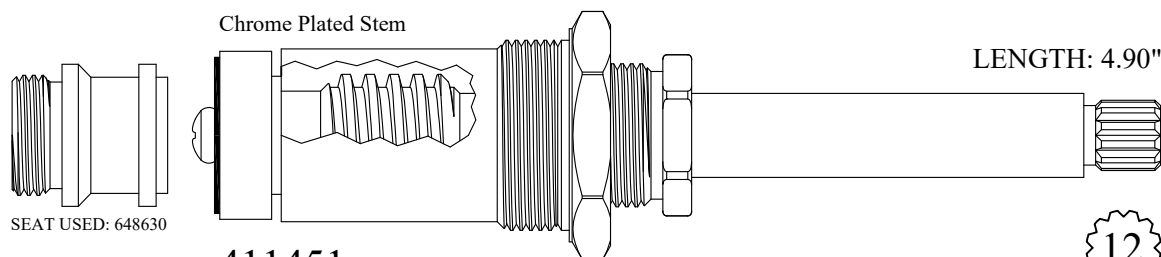

Chrome Plated Stem

LENGTH: 4.90"

SEAT USED: 648630

411451

GASKET INCLUDED: 895340

211451 Stem Only

12
1-2

FOR BRIGGS

Chrome Plated Stem

LENGTH: 4.91"

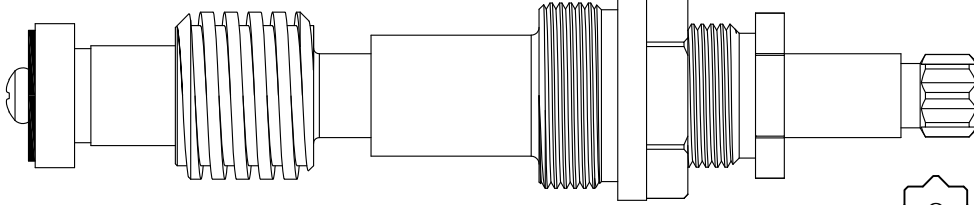

411901

GASKET INCLUDED: 895330

211901 Stem Only

OEM # 307

8

Chrome Plated Stem

LENGTH: 4.91"

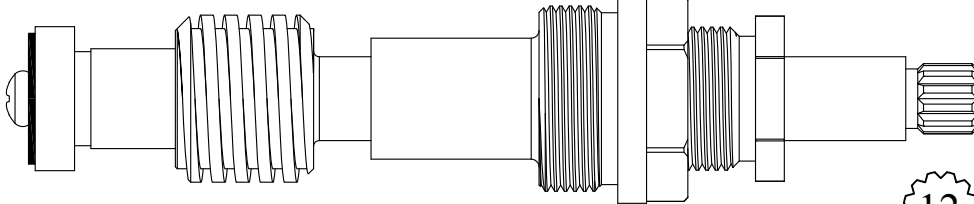

411951

GASKET INCLUDED: 895330

211951 Stem Only

12

1-2

Chrome Plated Stem

LENGTH: 4.92"



SEAT USED: 647650

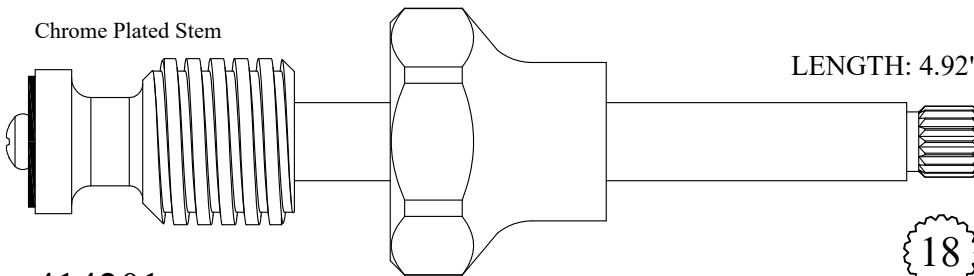

414201

OEM # 5814

214201 Stem Only

18

3-3

Chrome Plated Stem

LENGTH: 4.92"



SEAT USED: 647650

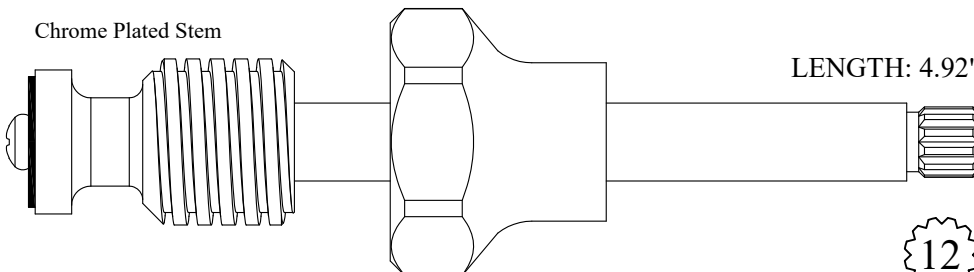

414251

214251 Stem Only

12

1-2

FOR BRIGGS

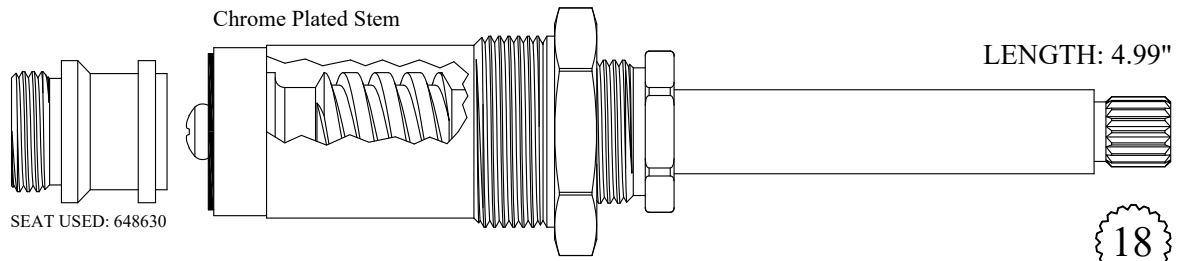

413001/ 413002
GASKET INCLUDED: 895340
213001/ 213002 Stem Only

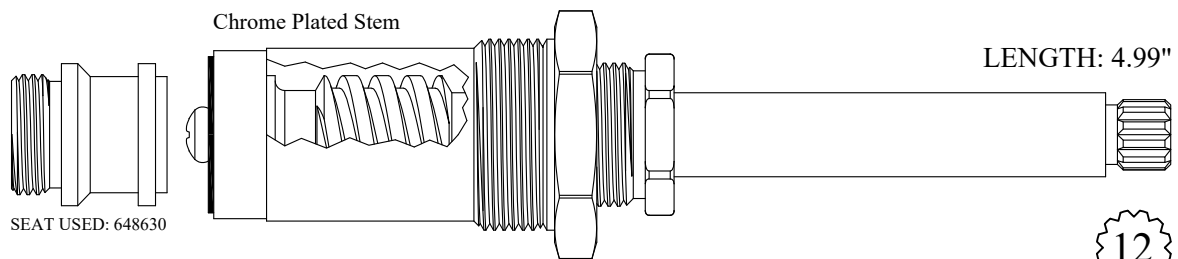

413051/ 413052
GASKET INCLUDED: 895340
213051/ 213052 Stem Only

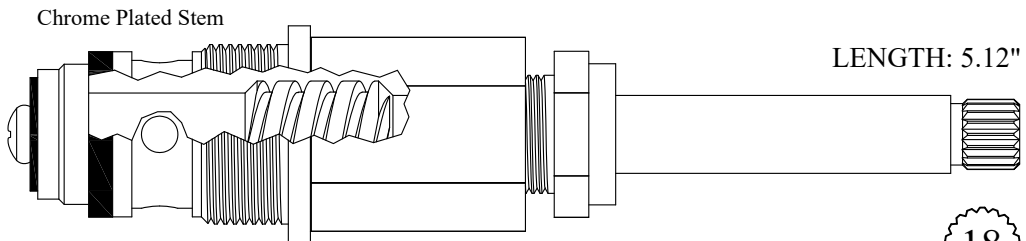

433502
GASKET INCLUDED: 895370
OEM # DIV10675
233502 Stem Only
OEM # 3568

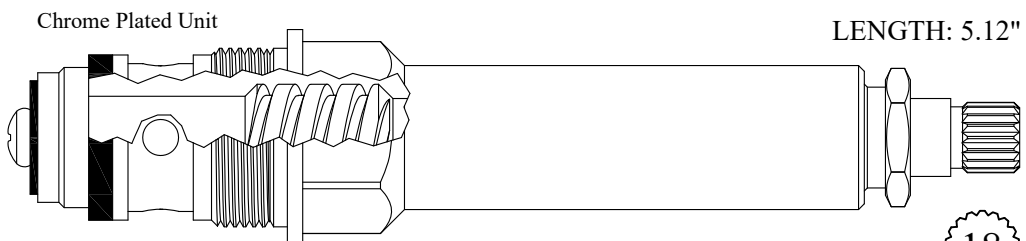

433512
GASKET INCLUDED: 895370
233502 Stem Only

FOR BRIGGS

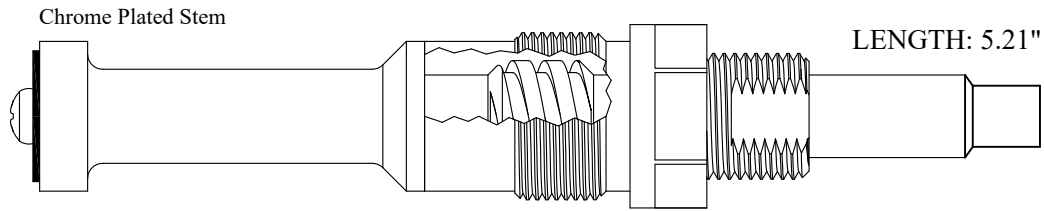

414561
 GASKET INCLUDED: 895180
214561 Stem Only

Supplied with  **12**
 1-2

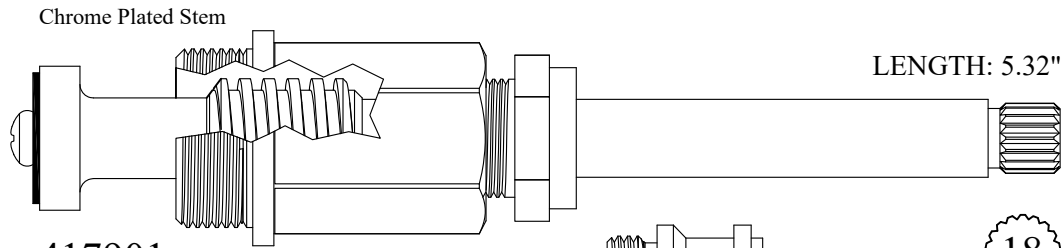

417901
 GASKET INCLUDED: 895370
 OEM # DIV505
217901 Stem Only
 OEM # 5857 (DIV502)

IMPORT VERSION
BR20252

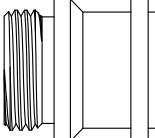
 **18**
 3-3
 SEAT USED: 648630

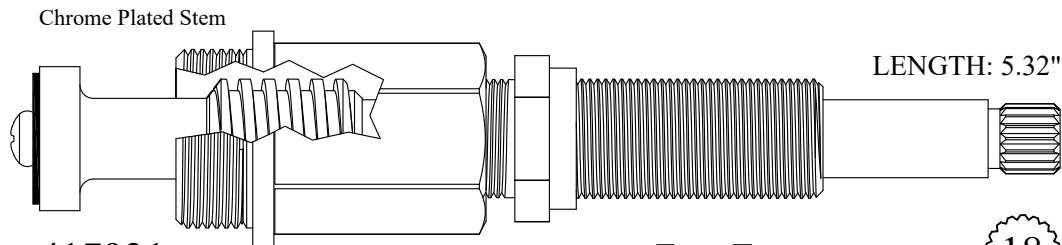

417921
 GASKET INCLUDED: 895370
217901 Stem Only

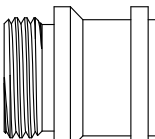
 **18**
 3-3
 SEAT USED: 648630

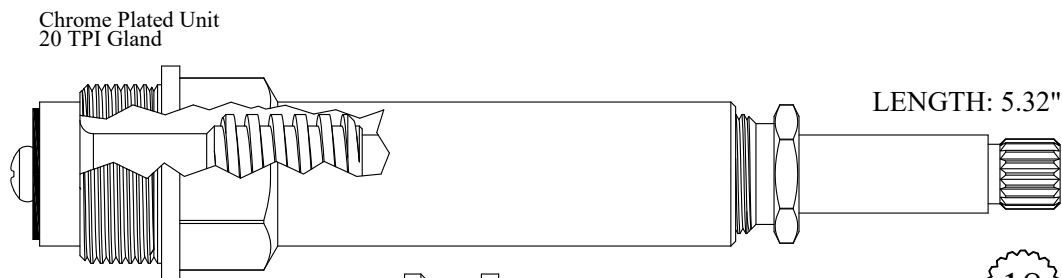

417911
 GASKET INCLUDED: 895370
217901 Stem Only

 **18**
 3-3
 SEAT USED: 648630

FOR BRIGGS

Chrome Plated Unit
18 TPI Gland

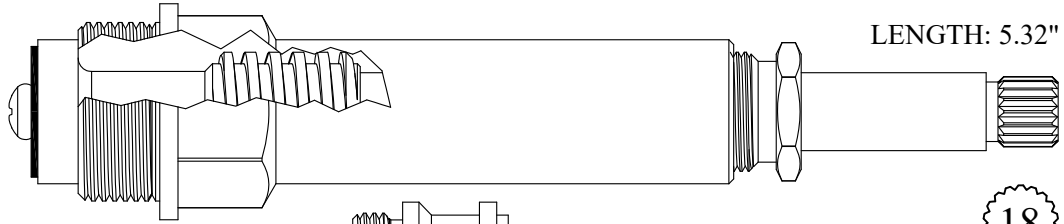

LENGTH: 5.32"

417931
GASKET INCLUDED: 895370
217901 Stem Only

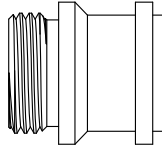

SEAT USED: 648630

18
3-3

Chrome Plated Stem

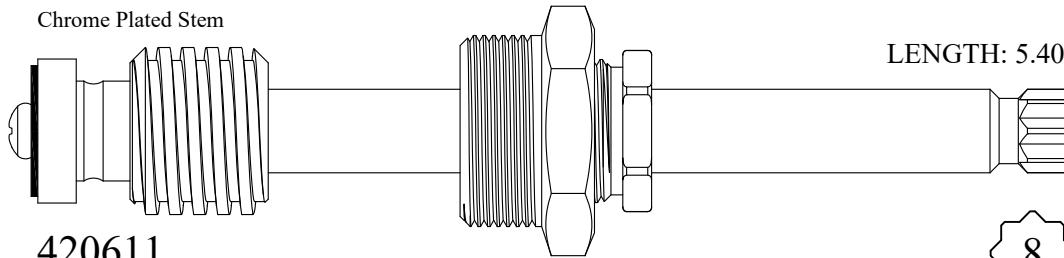

LENGTH: 5.40"

420611
GASKET INCLUDED: 895340
220611 Stem Only

8

Chrome Plated Stem

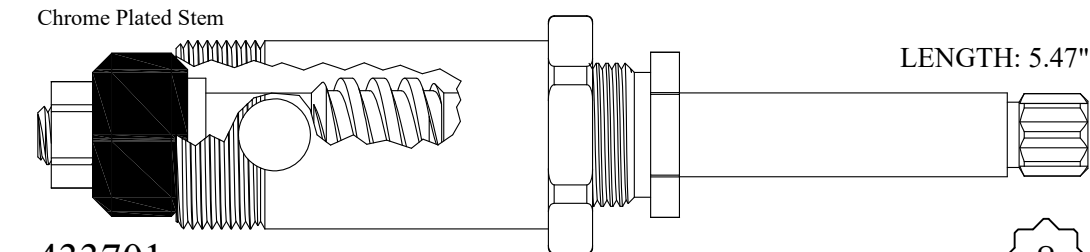

LENGTH: 5.47"

433701
GASKET INCLUDED: 895340
233701 Stem Only

8

Chrome Plated Stem

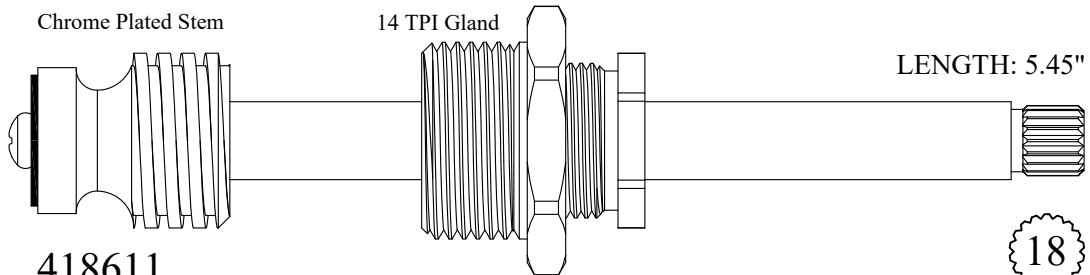

14 TPI Gland

LENGTH: 5.45"

418611
GASKET INCLUDED: 895570
220301 Stem Only
OEM # 6011

18
3-3

Chrome Plated Stem

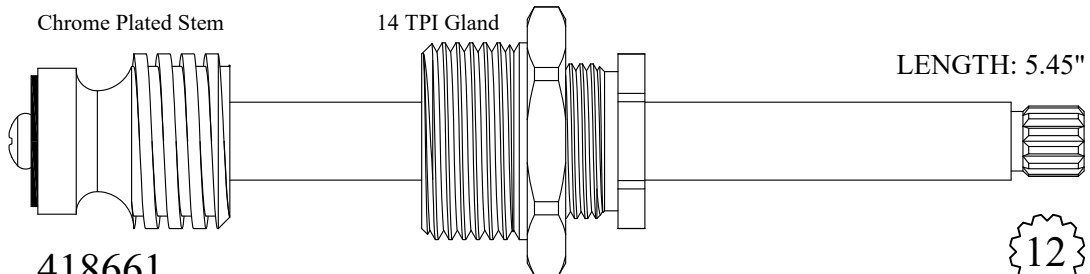

14 TPI Gland

LENGTH: 5.45"

418661
GASKET INCLUDED: 895570
220351 Stem Only

12

FOR BRIGGS

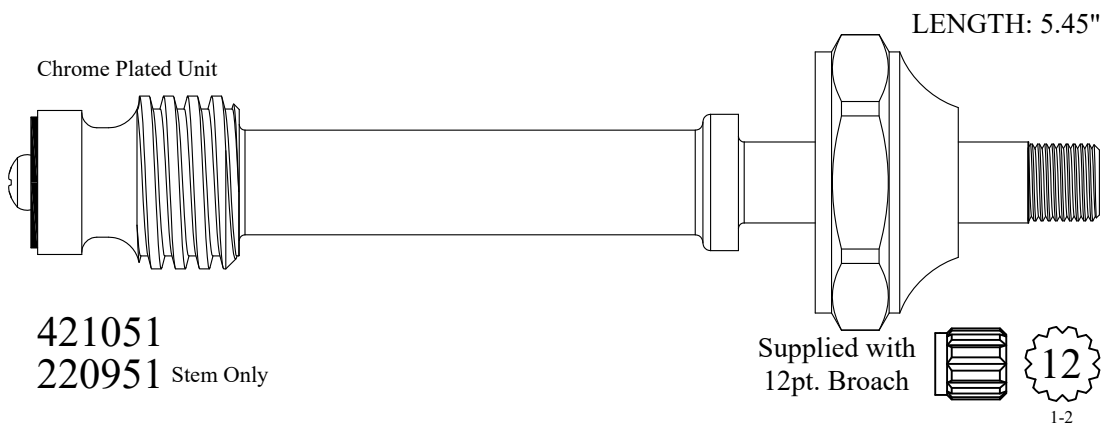
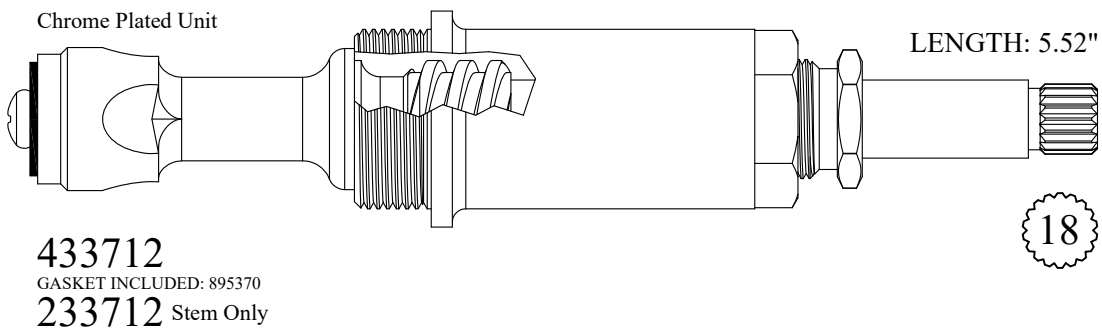
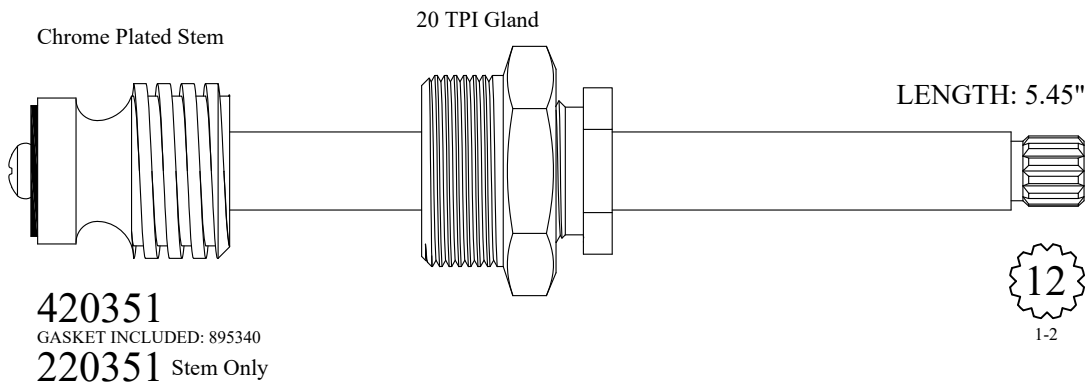
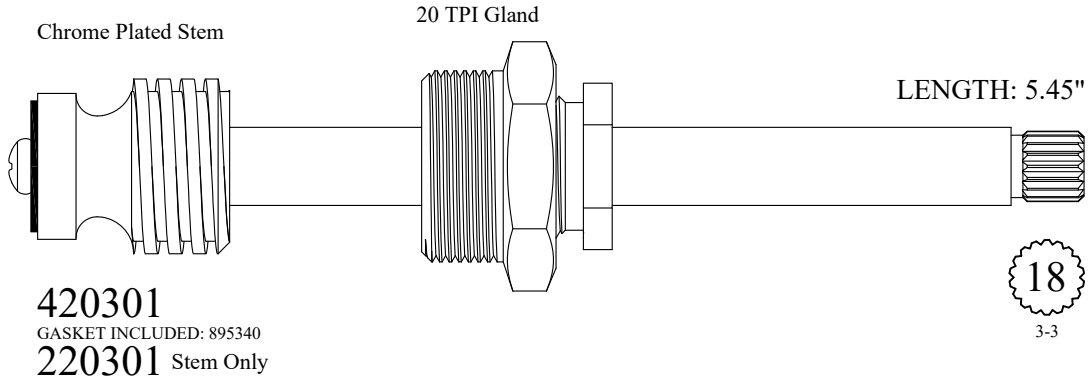

FOR BRIGGS

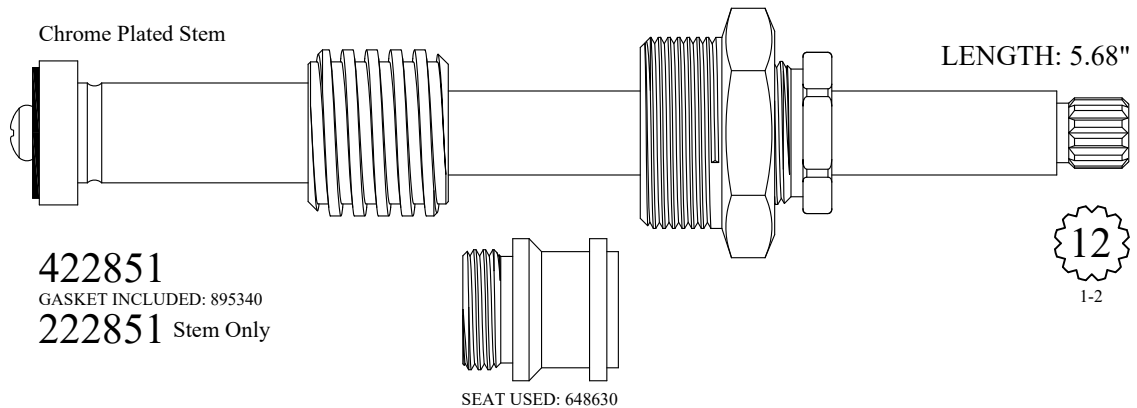
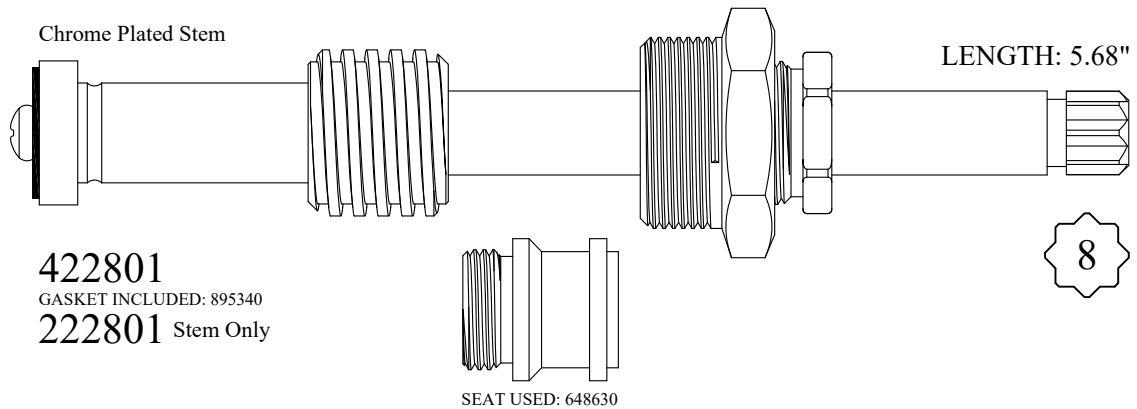
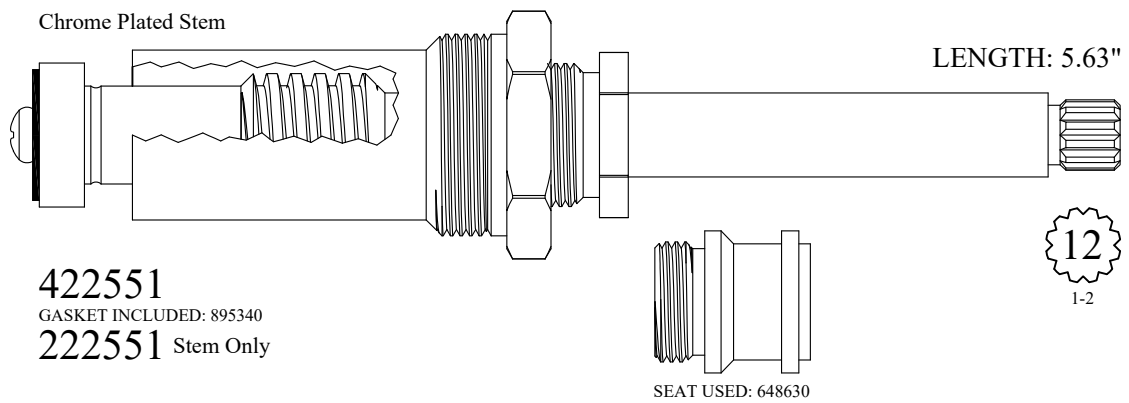
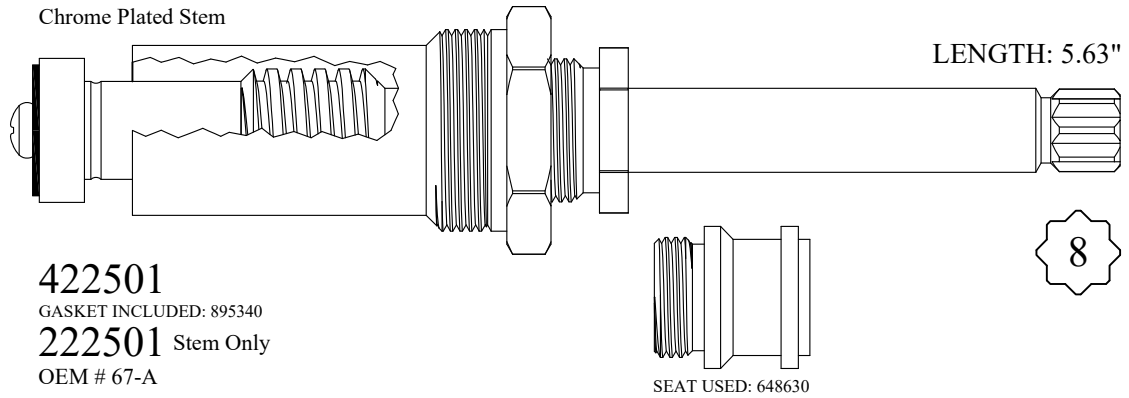

FOR BRIGGS

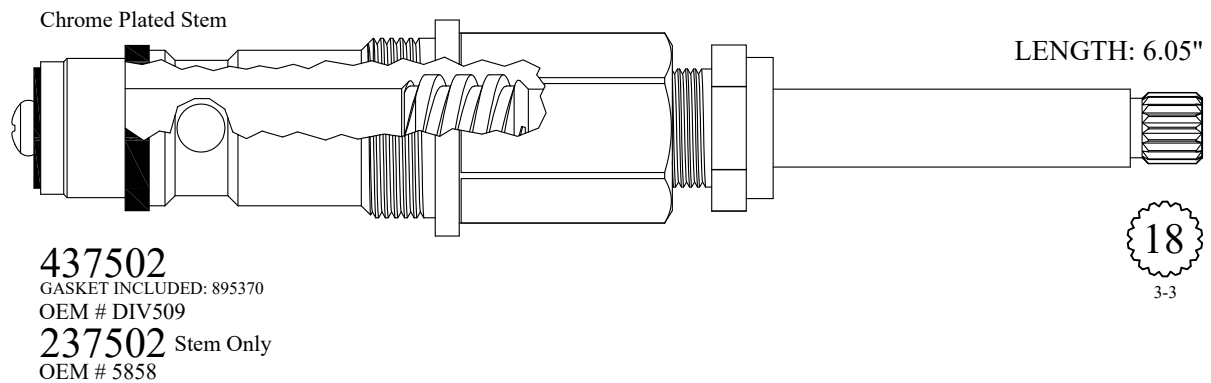
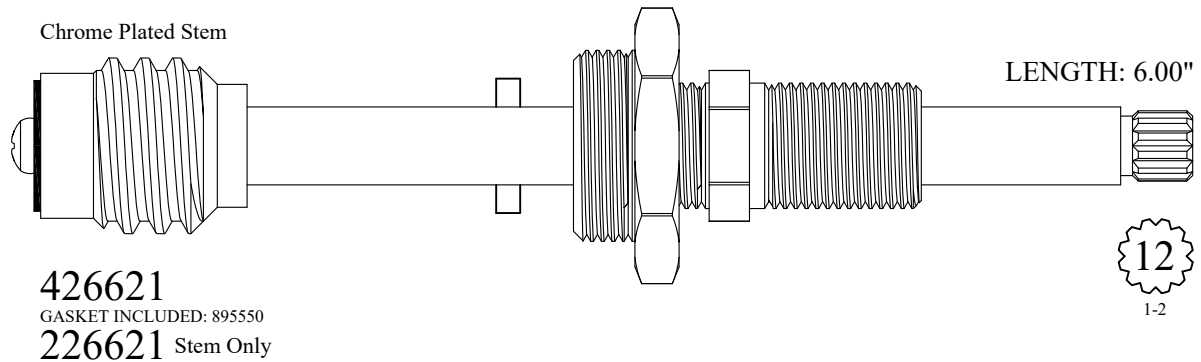
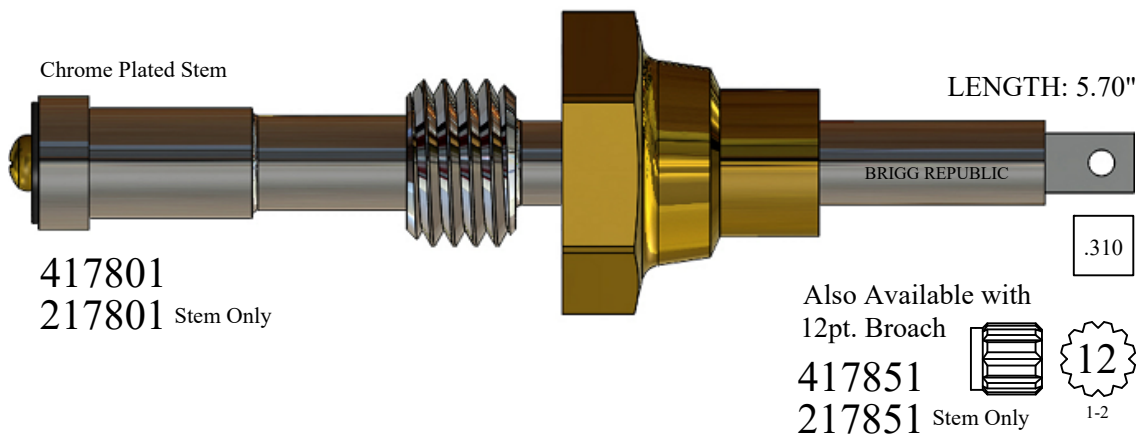
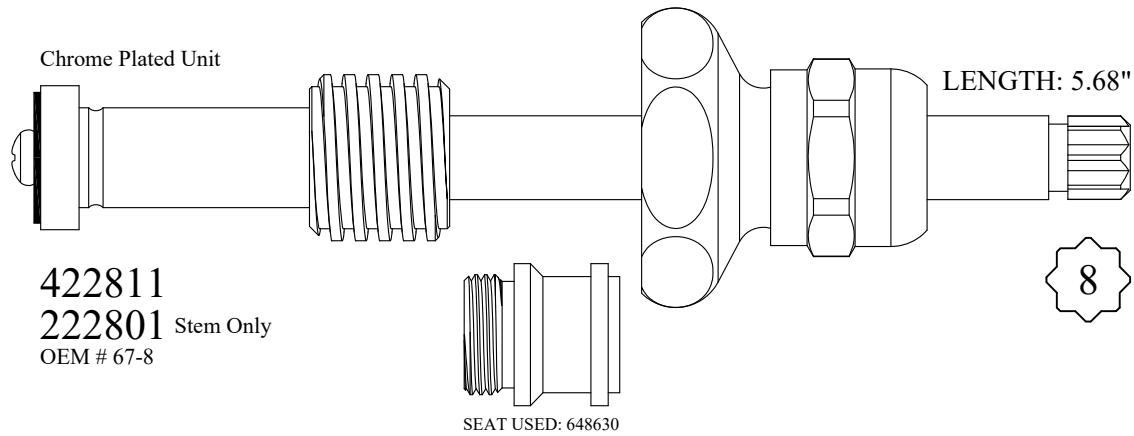

FOR BRIGGS

Chrome Plated Unit

LENGTH: 6.05"

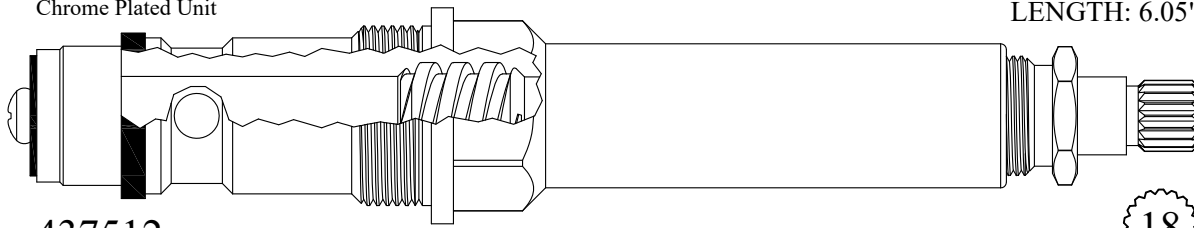

437512

GASKET INCLUDED: 895370

237502 Stem Only

18
3-3

Chrome Plated Stem

LENGTH: 6.50"

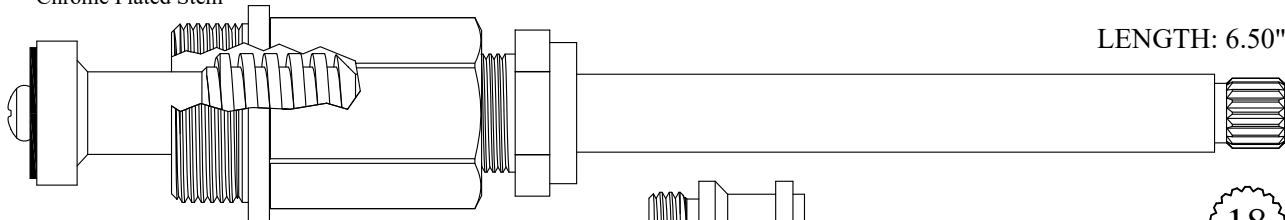

427141

GASKET INCLUDED: 895370

227141 Stem Only

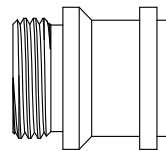

SEAT USED: 648630

18
3-3

Chrome Plated Stem

LENGTH: 6.68"

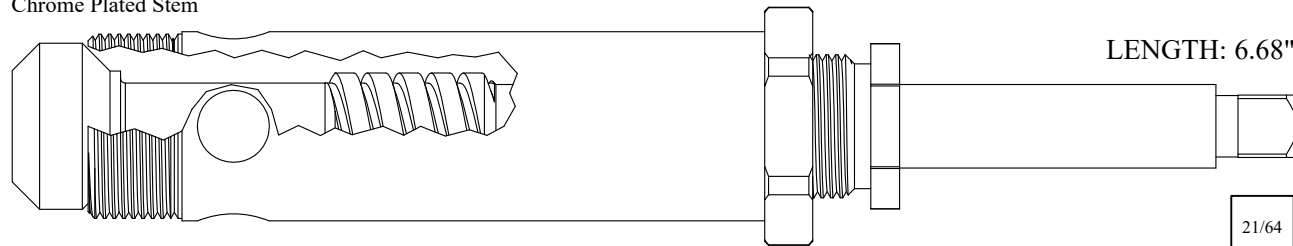

439201

GASKET INCLUDED: 895340

239201 Stem Only

21/64

Chrome Plated Stem

LENGTH: 6.68"

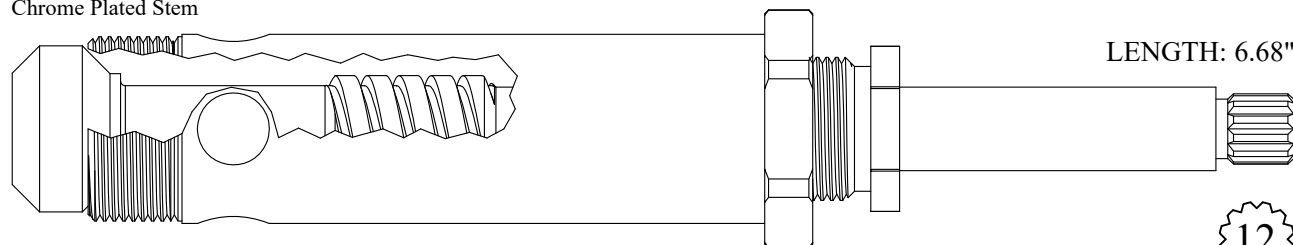

439251

GASKET INCLUDED: 895340

239251 Stem Only

12
1-2

Chrome Plated Stem

LENGTH: 6.79"

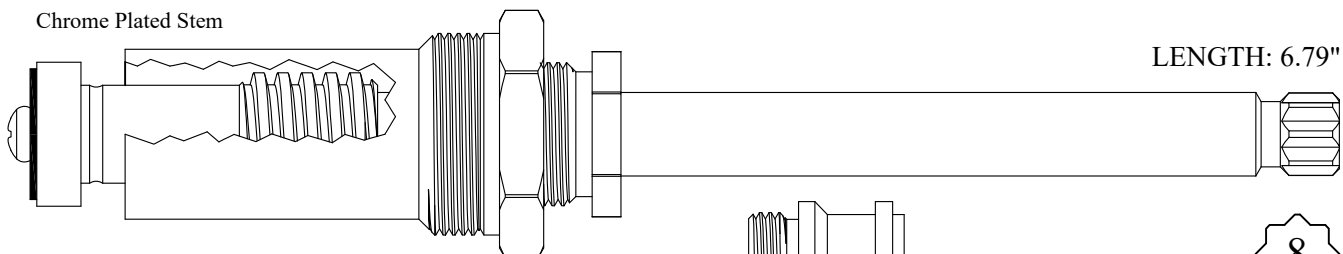

427441

GASKET INCLUDED: 895340

227441 Stem Only

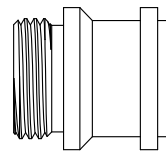

SEAT USED: 648630

8

FOR BRIGGS

Chrome Plated Stem

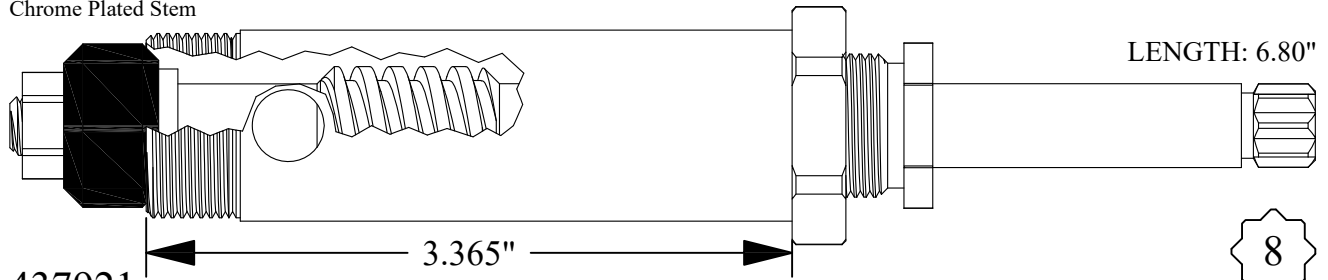

LENGTH: 6.80"

437921

GASKET INCLUDED: 895340

237911 Stem Only



Chrome Plated Stem

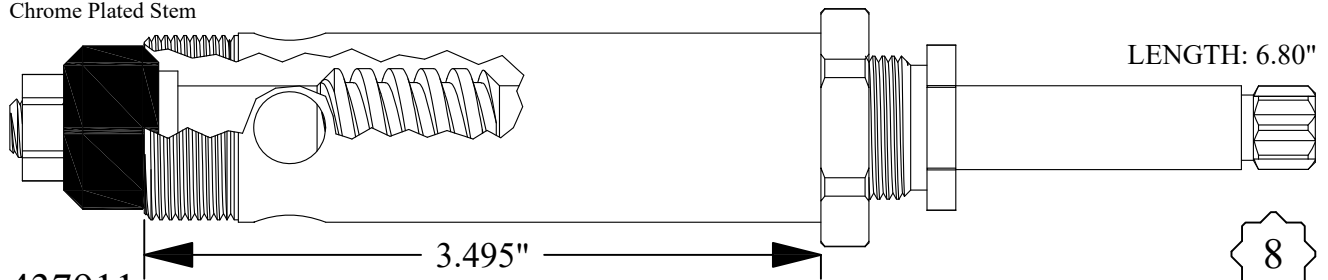

LENGTH: 6.80"

437911

GASKET INCLUDED: 895340

237911 Stem Only



Chrome Plated Stem

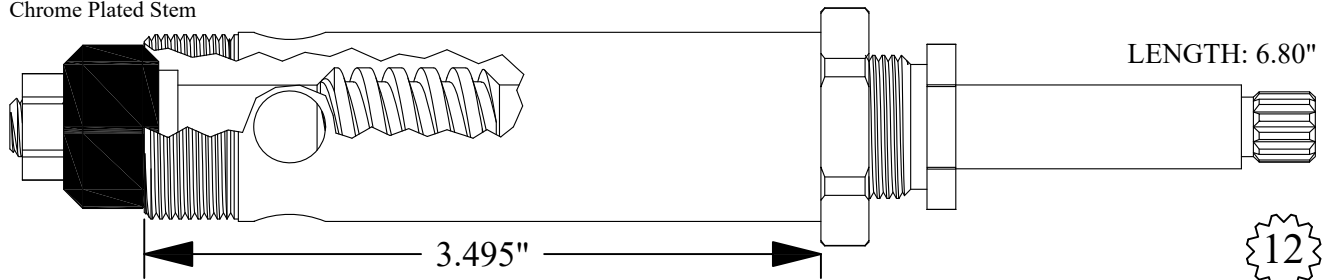

LENGTH: 6.80"

437961

GASKET INCLUDED: 895340



1-2

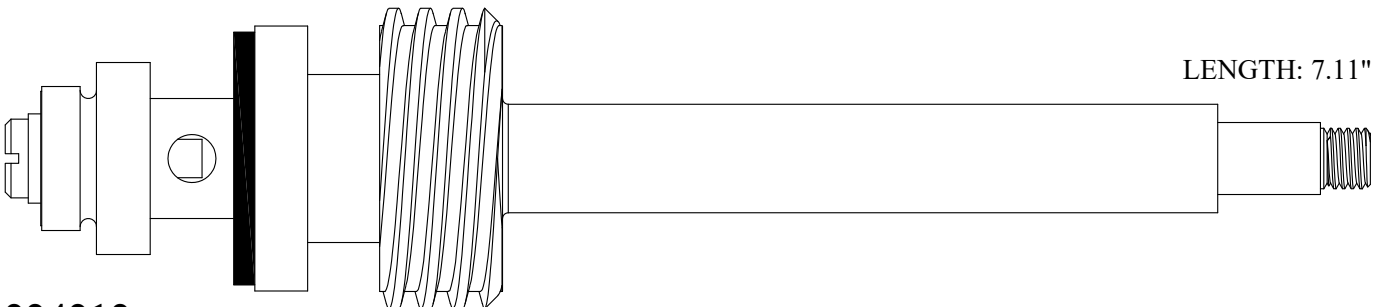

LENGTH: 7.11"

224212

OEM # DIV617

FOR BROADWAY



GASKET INCLUDED: 895150

LF451151
LF451152



GASKET INCLUDED: 895160

LF463501
LF463502

Also available with polished chrome plated stem
LF463501-CP/ LF463502-CP

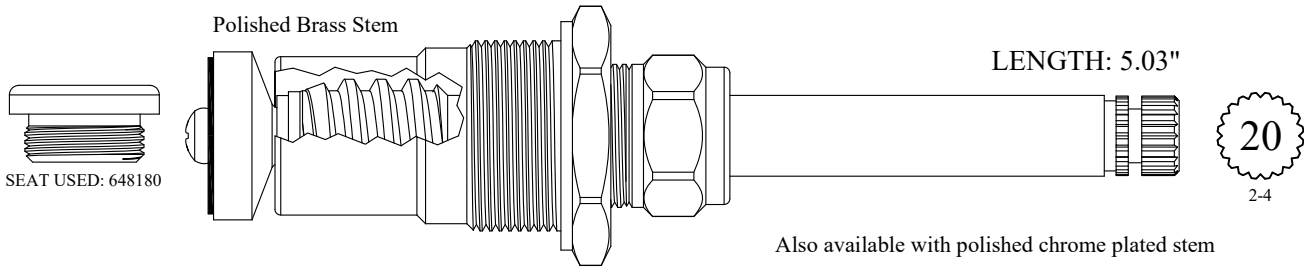

414321/ 414322

GASKET INCLUDED: 895570

OEM # 26.57760 605 & 26.57761 605

214321/ 214322 Stem Only

Also available with polished chrome plated stem

414321-CP/ 414322-CP

OEM # 26.57760 625 & 26.57761 625

214321-CP/ 214322-CP Stem Only

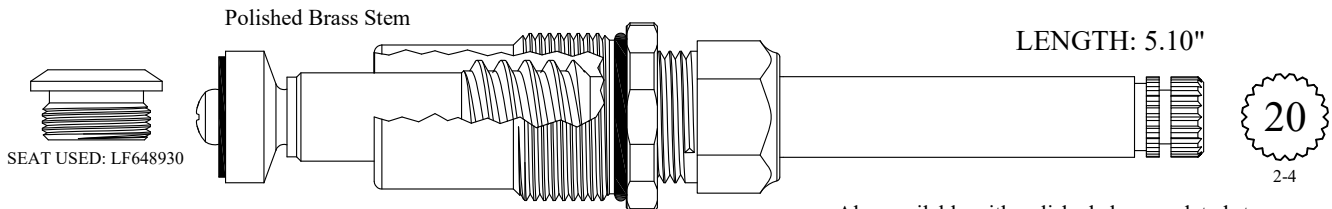

LF478881/ LF478882

GASKET INCLUDED: 890180

OEM # 26.57764 605 & 26.57765 605

LF278881/ LF278882 Stem Only

Also available with polished chrome plated stem

LF478881-CP/ LF478882-CP

GASKET INCLUDED: 890180

OEM # 26.57764 625 & 26.57765 625

LF278881-CP/ LF278882-CP Stem Only

FOR BROADWAY

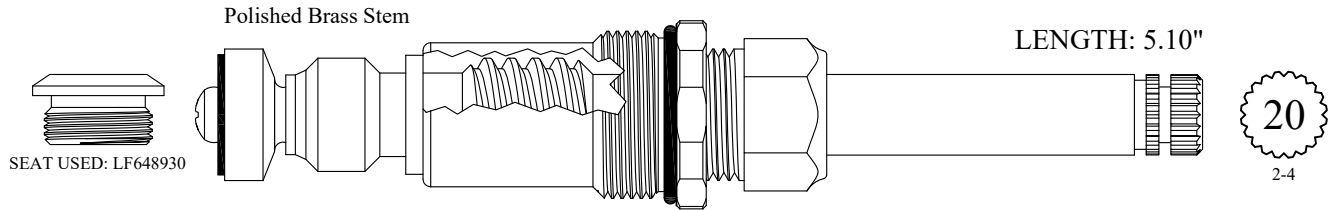

LF478891/ LF478892
 GASKET INCLUDED: 890180
 OEM # 26.57764 605 & 26.57765 605
LF278891/ LF278892 Stem Only

Also available with polished chrome plated stem
LF478891-CP/ LF478892-CP
 GASKET INCLUDED: 890180
 OEM # 26.57764 625 & 26.57765 625
LF278891-CP/ LF278892-CP Stem Only

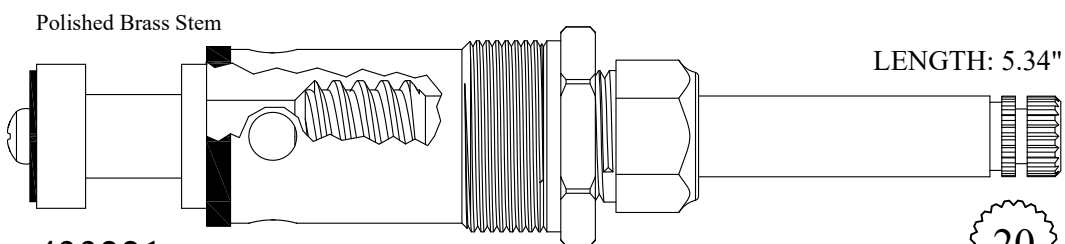

433221
 OEM # 26.57759 605
 GASKET INCLUDED: 895560
233221 Stem Only

Also available with polished chrome plated stem
433221-CP
 GASKET INCLUDED: 895560
 OEM # 26.57759 625
233221-CP Stem Only

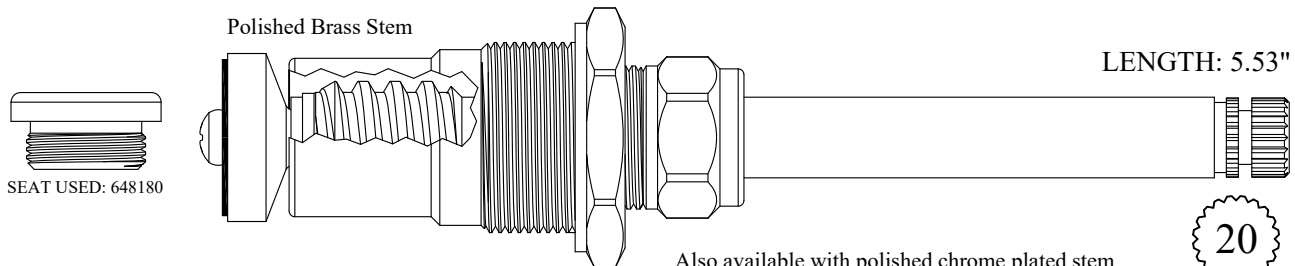

420311/ 420312
 GASKET INCLUDED: 895570
220311/ 220312 Stem Only

Also available with polished chrome plated stem
420311-CP/ 420312-CP
 GASKET INCLUDED: 895570
220311-CP/ 220312-CP Stem Only

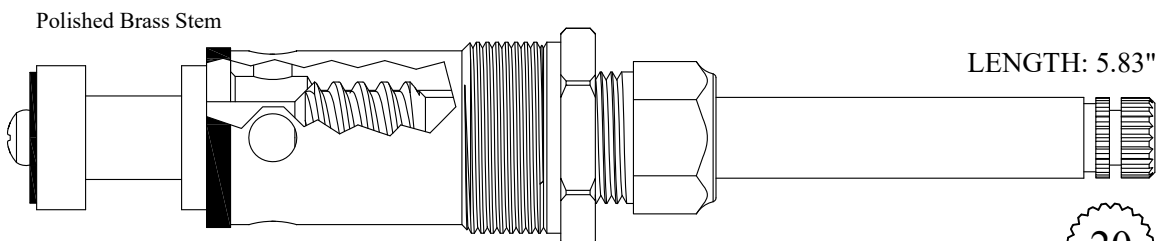

436321
 GASKET INCLUDED: 895560
236321 Stem Only

Also available with polished chrome plated stem
436321-CP
236321-CP Stem Only

FOR BROADWAY

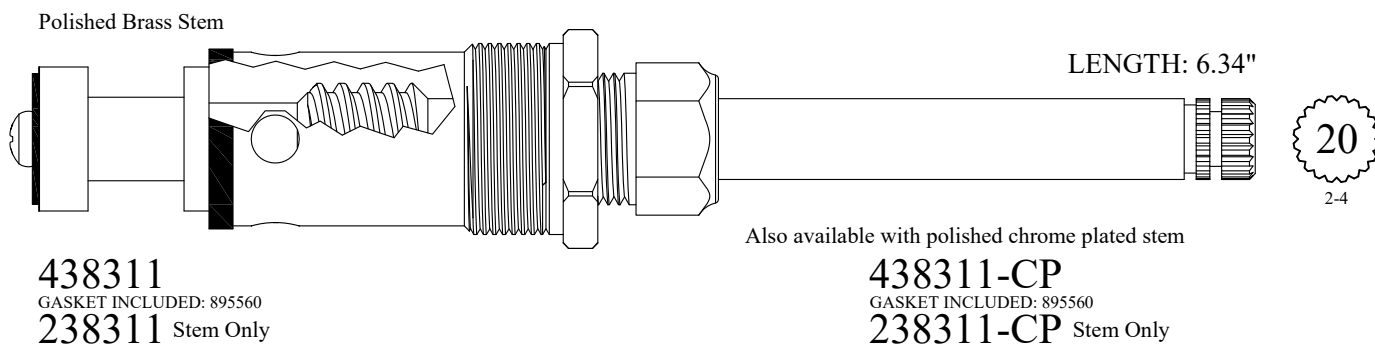
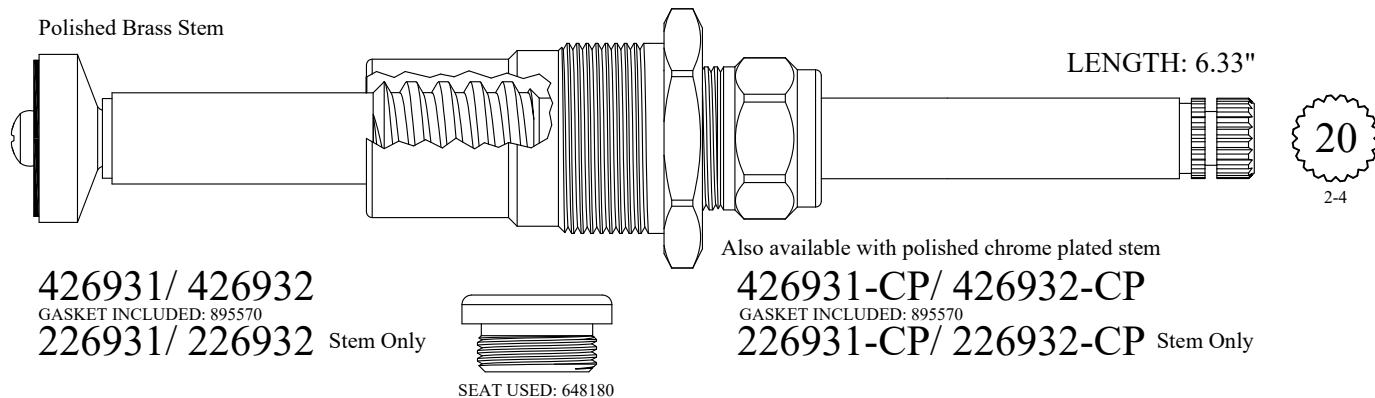
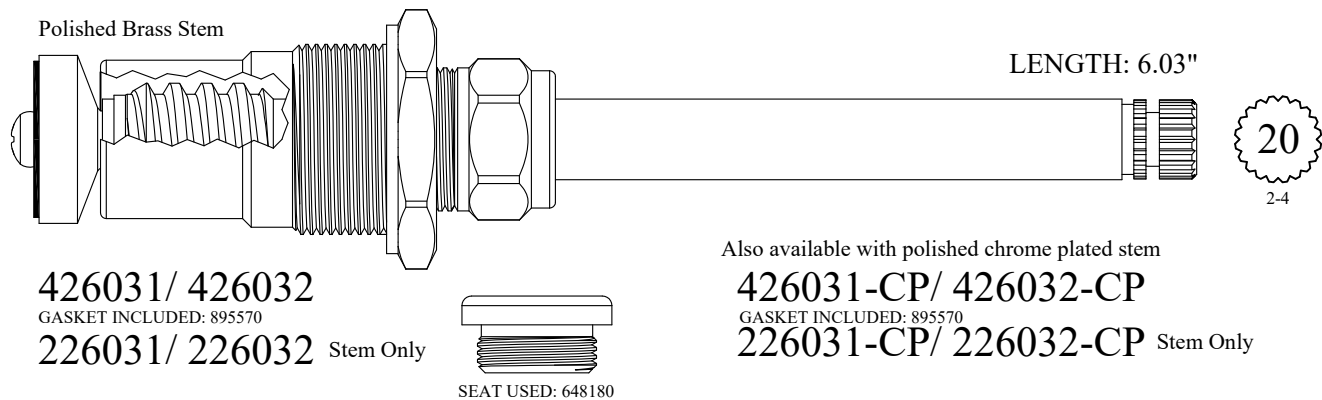

Send Your Orders To:
E-mail: orderdesk@barrywalter.com
Fax: 1.800.886.9831
Phone: 1.800.767.5552

FOR BURLINGTON

LENGTH: 1.26"

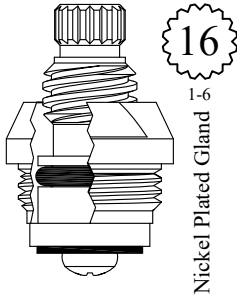

1-6
Nickel Plated Gland

GASKET INCLUDED: 895100

LF450061
LF450062



SEAT USED: LF648700

LENGTH: 1.58"

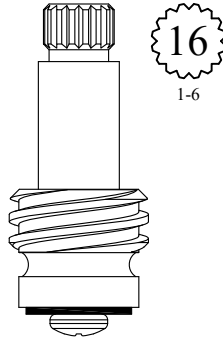

1-6

LF253061
LF253062



SEAT USED: LF648700

LENGTH: 1.80"

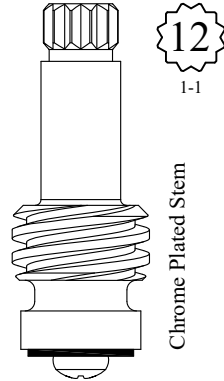

1-6

Chrome Plated Stem

LF255111
LF255112

LENGTH: 1.88"

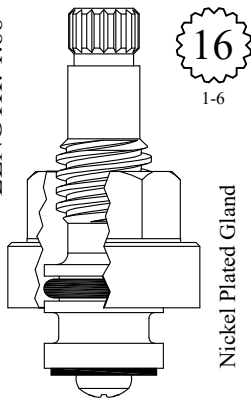

1-6

Nickel Plated Gland

LF457011
LF457012



SEAT USED: LF648700

LENGTH: 2.00"

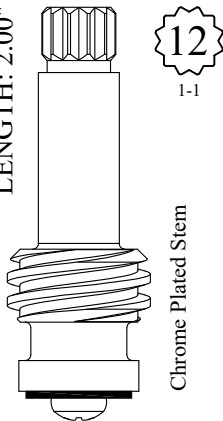

1-6

Chrome Plated Stem

LF260071
LF260072

LENGTH: 2.35"

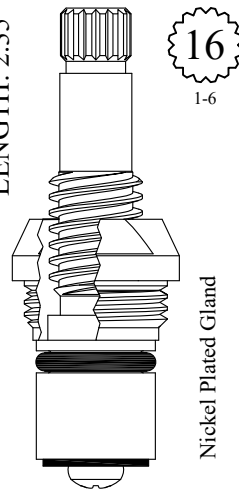

1-6

Nickel Plated Gland

LF462111
LF462112



SEAT USED: LF648700

FOR BURLINGTON

LENGTH: 3.27"

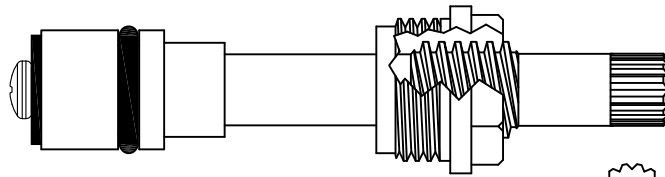

LF467071/ LF467072

GASKET INCLUDED: 895100



LENGTH: 4.27"

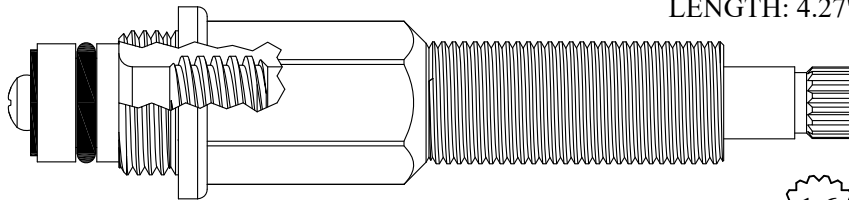

405811

GASKET INCLUDED: 895100

205811 Stem Only



LENGTH: 4.58"

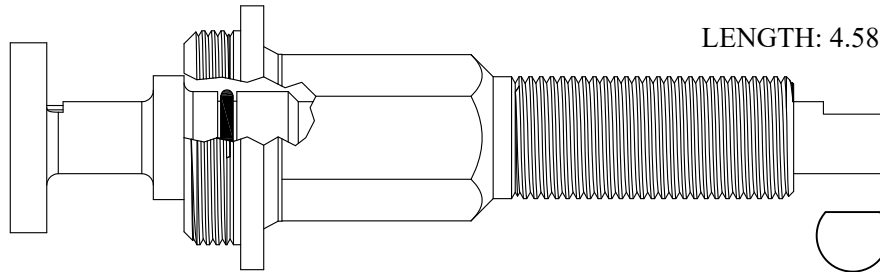

430710

GASKET INCLUDED: 894620

230710 Stem Only

BARRY E.  **WALTER**  SR. CO.

FOR CALIFORNIA BRASS

Chrome Plated Stem

LENGTH: 2.33"

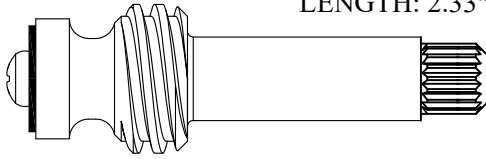

LF263141
LF263142

Supplied with
12pt. Broach



1-2

Chrome Plated Stem

LENGTH: 4.30"

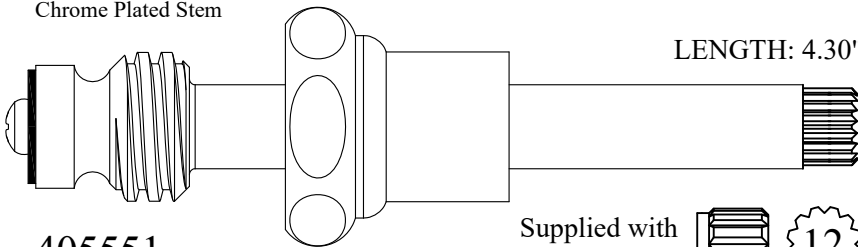

405551
205551 Stem Only

Supplied with
12pt. Broach



1-2

FOR HOT & COLD STEM USE PRICE PFISTER 405111/405112

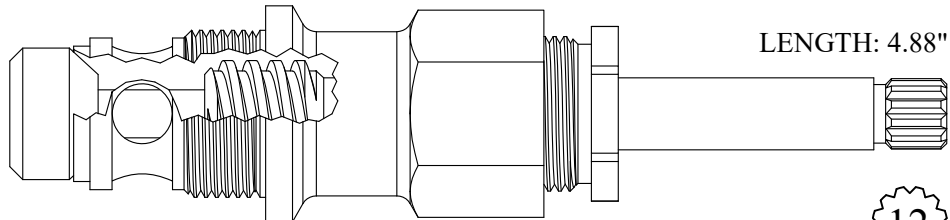

LENGTH: 4.88"

431701
GASKET INCLUDED: 895400
231701 Stem Only



1-2

FOR HOT & COLD STEM USE PRICE PFISTER 421601/421602

Chrome Plated Stem

LENGTH: 5.75"

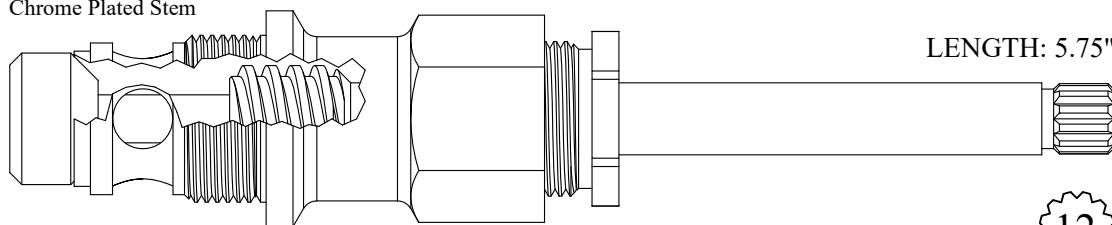

434801
GASKET INCLUDED: 895400
234801 Stem Only



1-2

FOR CAMBRIDGE

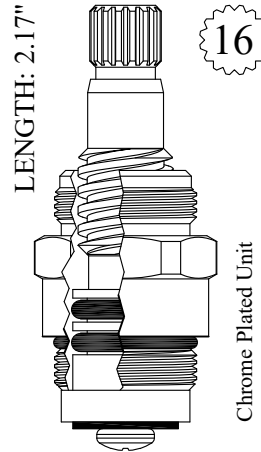
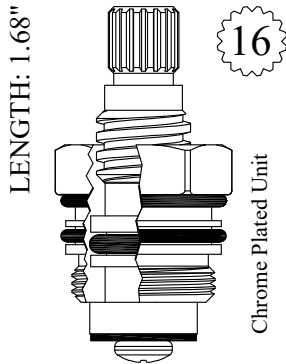

GASKET: 890170 O-RING INCLUDED

LF452961
OEM # 060047A
LF452962
OEM # 060048A



SEAT USED: LF646940

LF460291
LF460292

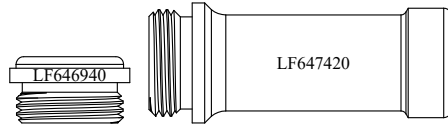

SEAT USED: LF646940 or LF647420

FOR CASE

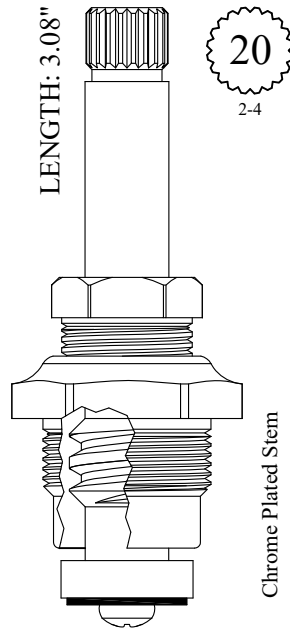

GASKET INCLUDED: 895290

LF467401
LF467402
LF267401 Stem Only
Speakman OEM # : G03-0175
LF267402 Stem Only

FOR CENTRAL

LENGTH: 1.44"

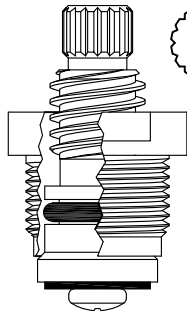

16
1-6

IMPORT VERSION
CB10368-LF
CB10369-LF

GASKET INCLUDED: 895100

LF451071
OEM # SU-357-K
LF451072

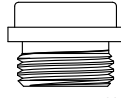

SEAT USED: LF648550

LENGTH: 1.50"

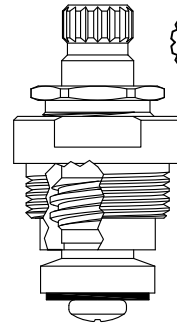

16
1-6

IMPORT VERSION
CB10370-LF
CB10371-LF

GASKET INCLUDED: 895100

LF452041
OEM # SU-353
LF452042
OEM # SU-353-EL

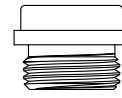

SEAT USED: LF648550

LENGTH: 1.88"

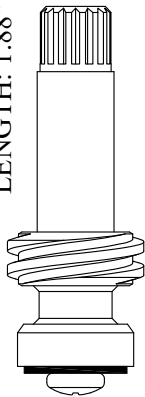

16
1-6

LF256111
OEM # SU-2714
LF256112



SEAT USED: LF648550

LENGTH: 2.00"

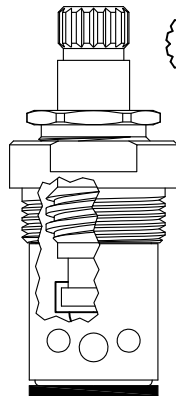

16
1-6

Plastic Retainer

GASKET INCLUDED: 895100

LF453501
OEM # SU-353-EWH
LF453502
OEM # SU-353-EWC

LENGTH: 2.01"



16
1-6

Chrome Plated Stem

LF258081
OEM # SU-1818/SU-2718-R
LF258082
OEM # SU-1818-L/ SU-2718-L



SEAT USED: LF648550

FOR CENTRAL

LENGTH: 2.13"

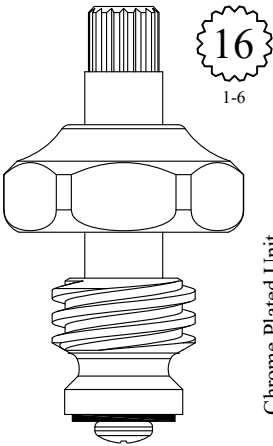

Chrome Plated Unit

LF460061
 LF460062
 LF260061 Stem Only
 OEM # SU-1855/45
 LF260062 Stem Only

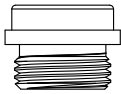

SEAT USED: LF648550

LENGTH: 2.30"

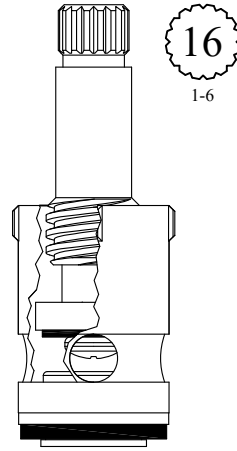

Chrome Plated Bonnet

SEAT INCLUDED:
 (Part of Barrel Assembly) LF647850

LF462051
 LF462052

LENGTH: 2.30"

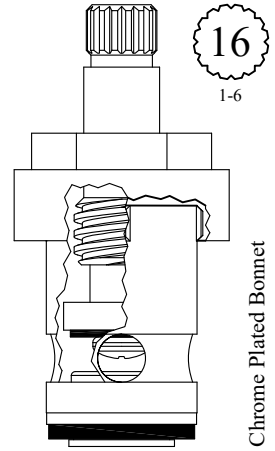

SEAT INCLUDED:
 (Part of Barrel Assembly) LF647850

LF462151
 LF462152

LENGTH: 2.38"

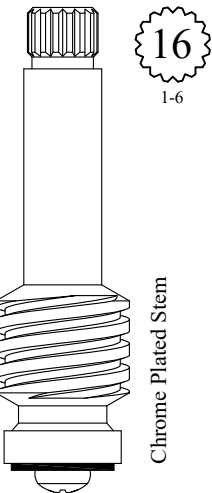

Chrome Plated Stem

LF263311
 OEM # SU-1858-R
 LF263312
 OEM # SU-1858-L

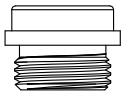

SEAT USED: LF648550

LENGTH: 2.40"

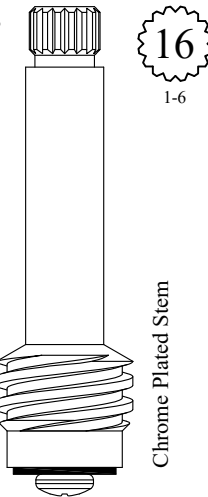

Chrome Plated Stem

LF263211
 OEM # SU-1990
 LF263211

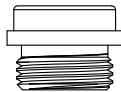

SEAT USED: LF648550

LENGTH: 2.42"

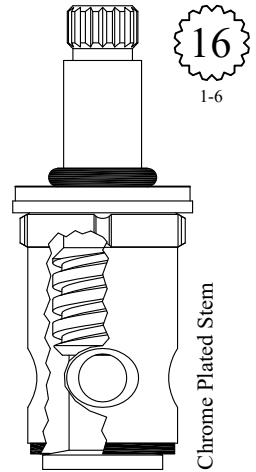

Chrome Plated Stem

LF463201
 LF463202

FOR CENTRAL

LENGTH: 2.42"

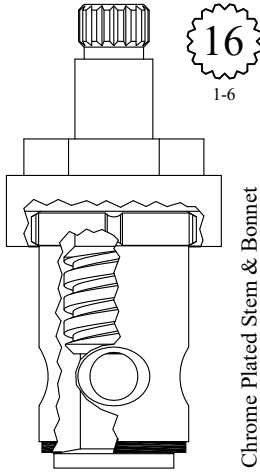

Chrome Plated Stem & Bonnet

LF463211
OEM # P-221
LF463212

LENGTH: 2.56"

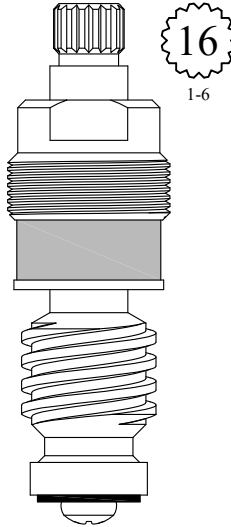

LF464101
LF464102
LF264101 Stem Only
OEM # SU-2127-R
LF264102 Stem Only
OEM # SU-2127-L

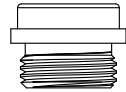

SEAT USED: LF648550

LENGTH: 2.65"

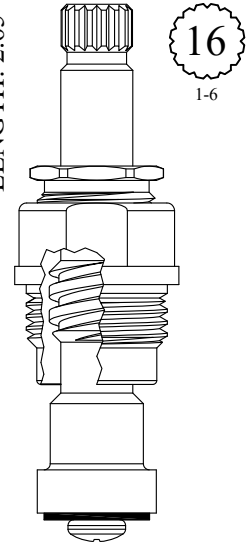

GASKET INCLUDED: 895100

LF464801
OEM # K-158-KR
LF464802
OEM # K-158-KL

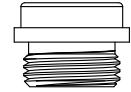

SEAT USED: LF648550

LENGTH: 2.66"

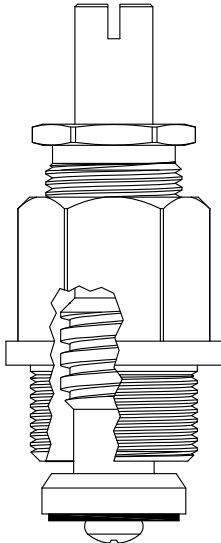

GASKET INCLUDED: 895400

401611
201611 Stem Only

LENGTH: 2.66"

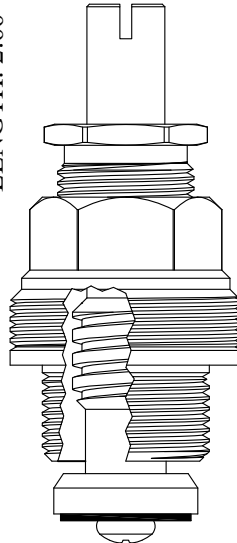

GASKET INCLUDED: 895400

401621
201611 Stem Only

LENGTH: 2.66"

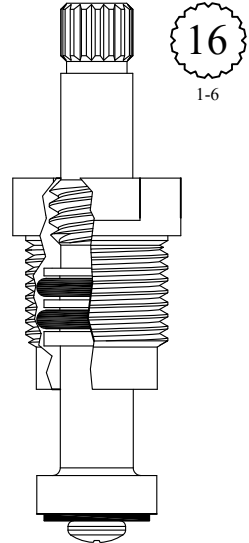

GASKET INCLUDED: 895100

LF464811
OEM # G-458-KR
LF464812
OEM # G-458-KL



SEAT USED: LF648550

FOR CENTRAL

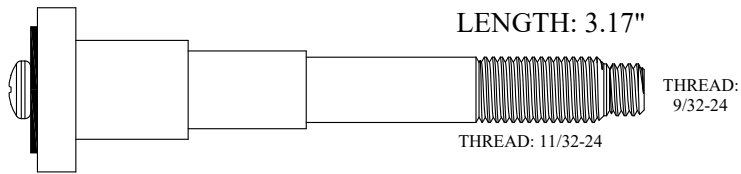

LF267150
OEM # SU-7101-AF

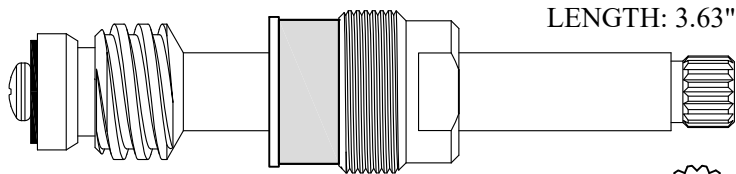
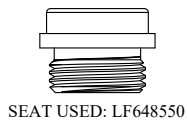

LF469021/ LF469022
LF269021/ LF269022 Stem Only
OEM # SU-1994

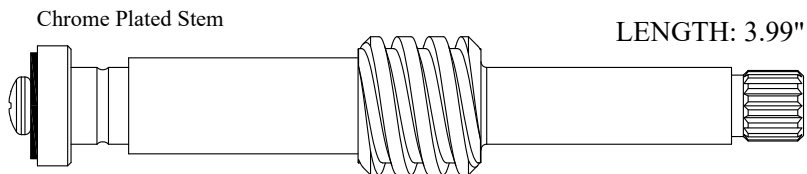

LF269201/ LF269202
OEM # SU-1885

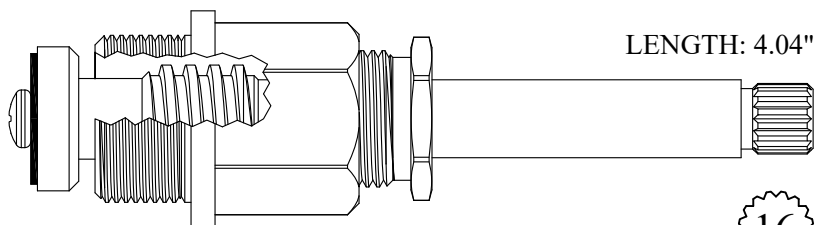
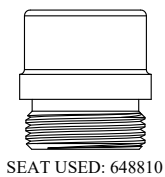

404401/ 404402
GASKET INCLUDED: 895400
204401/ 204402 Stem Only
OEM # SU-1529



FOR CENTRAL

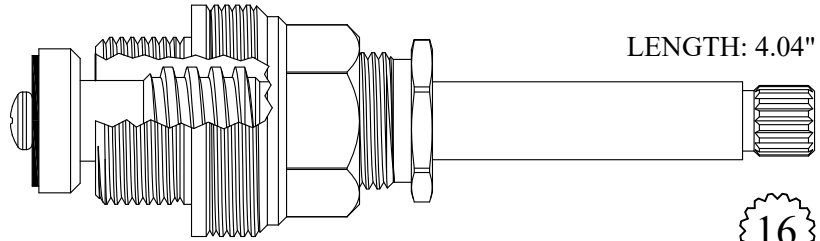
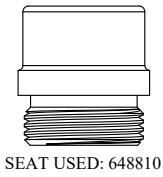

404411/ 404412
GASKET INCLUDED: 895400
204401/ 204402 Stem Only

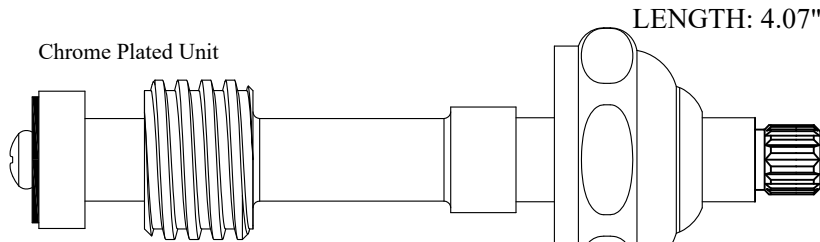

404651

Supplied with
12pt. Broach

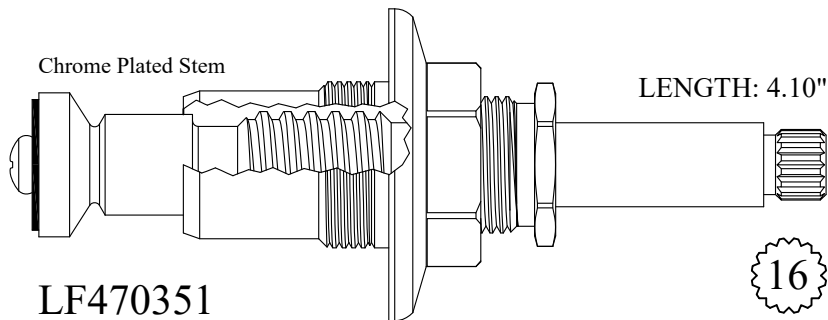
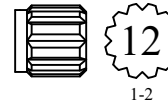

LF470351
GASKET INCLUDED: 895410

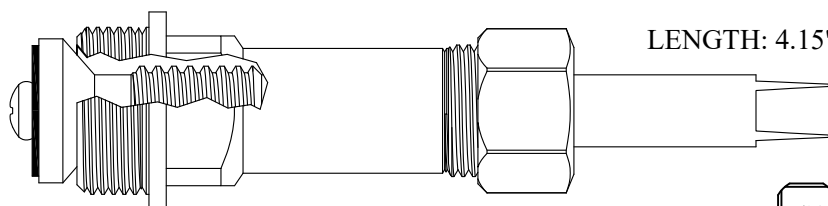

470771
GASKET INCLUDED: 895400



FOR CENTRAL

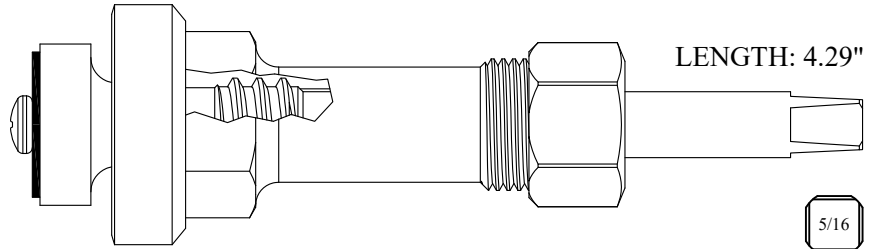

470751

5/16
TAPERED

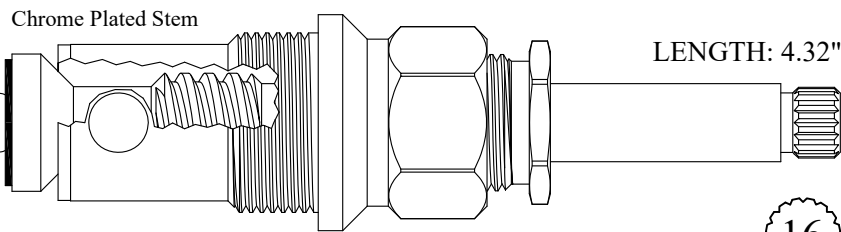
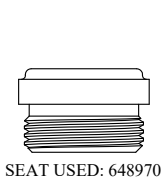

430401
GASKET INCLUDED: 895370
230401 Stem Only
OEM # SU-1559

16
1-6

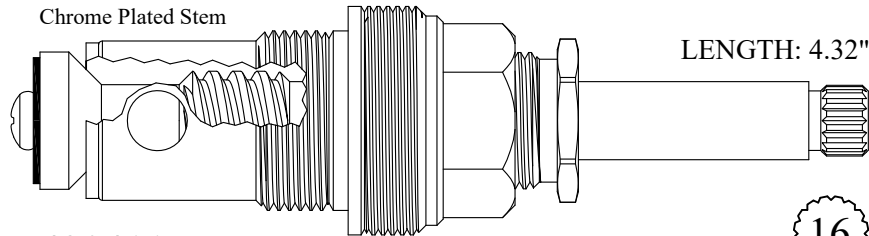
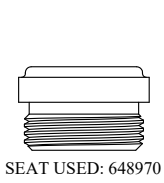

430411
GASKET INCLUDED: 895370
230401 Stem Only

16
1-6

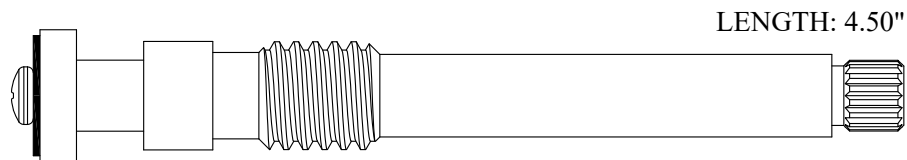

207221

16
1-6

FOR CENTRAL

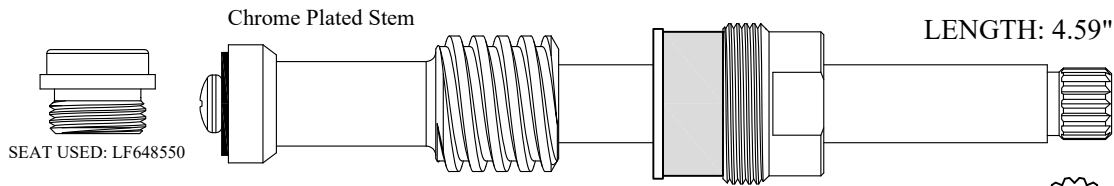

LF474021/ LF474022
LF274021/ LF274022 Stem Only
OEM # SU-1993

16
1-6

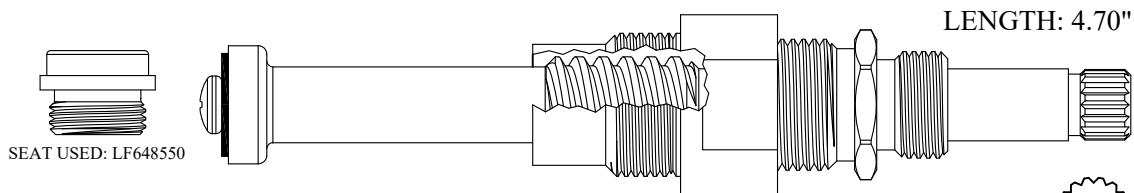

LF475061/ LF475062
GASKET INCLUDED: 895100
OEM # U-2970-SRI/ U-2970-SLI
LF275061/ LF275062 Stem Only
OEM # SU-2105-RI/ SU-2105-LI

16
1-6

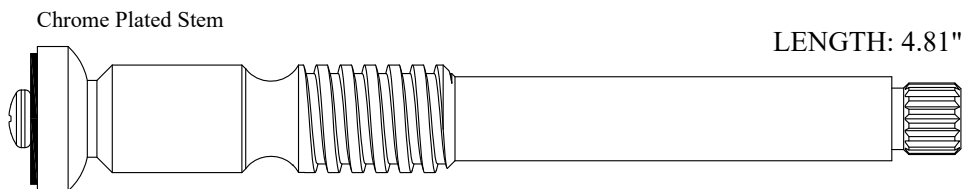

LF276101
OEM # SU-2002

16
1-6

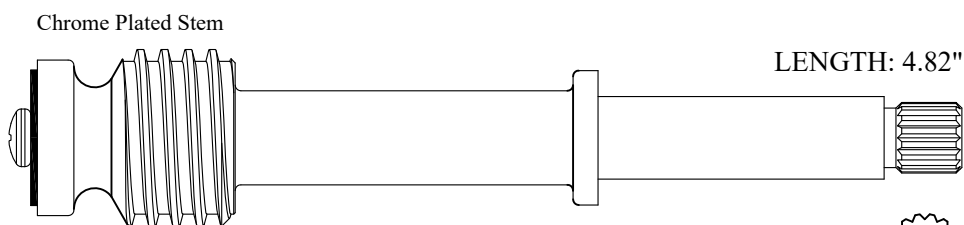

210431

16
1-6

FOR CENTRAL

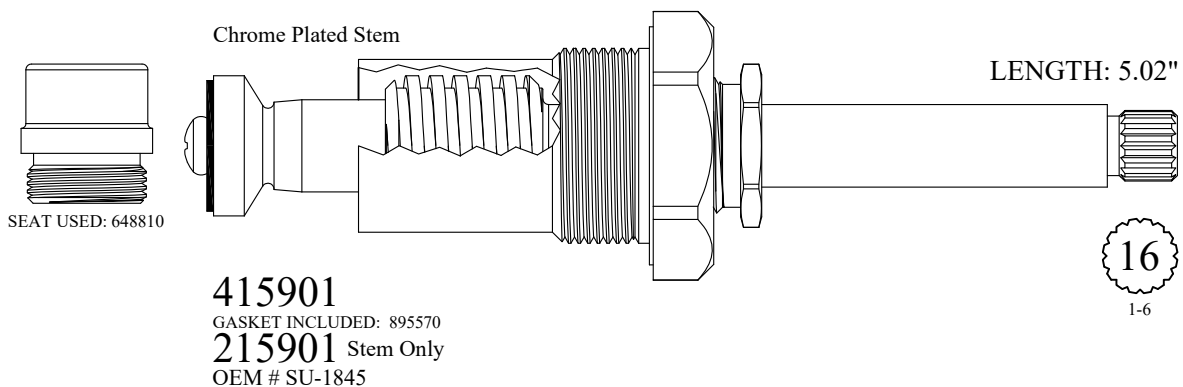
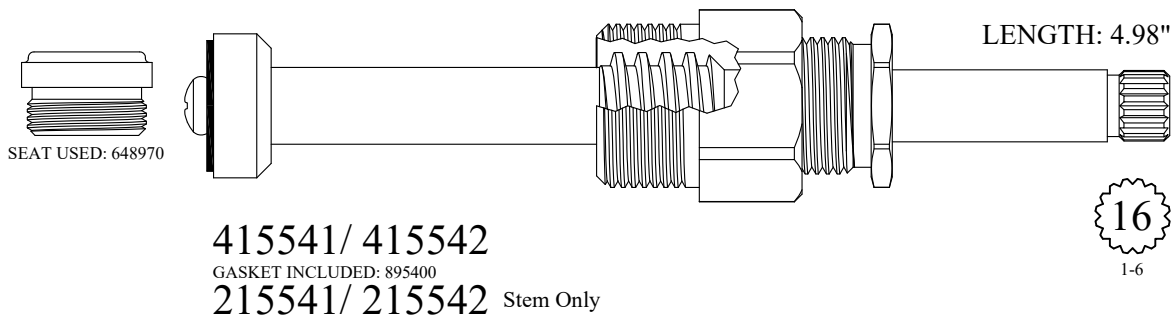
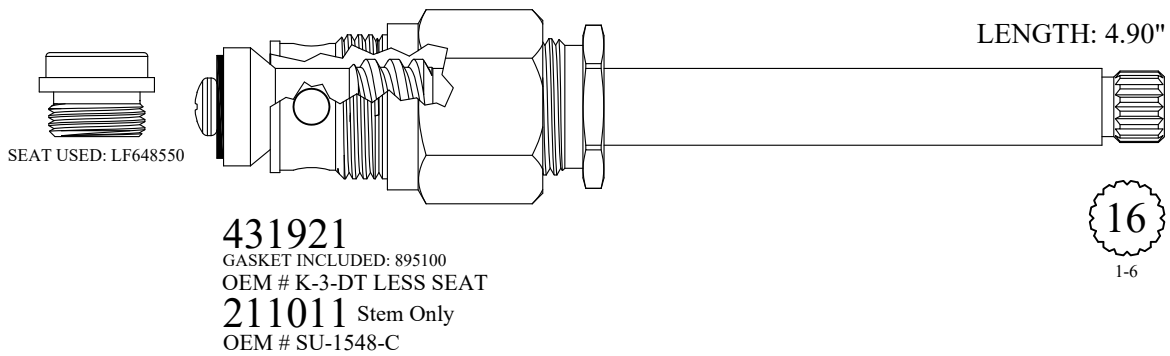
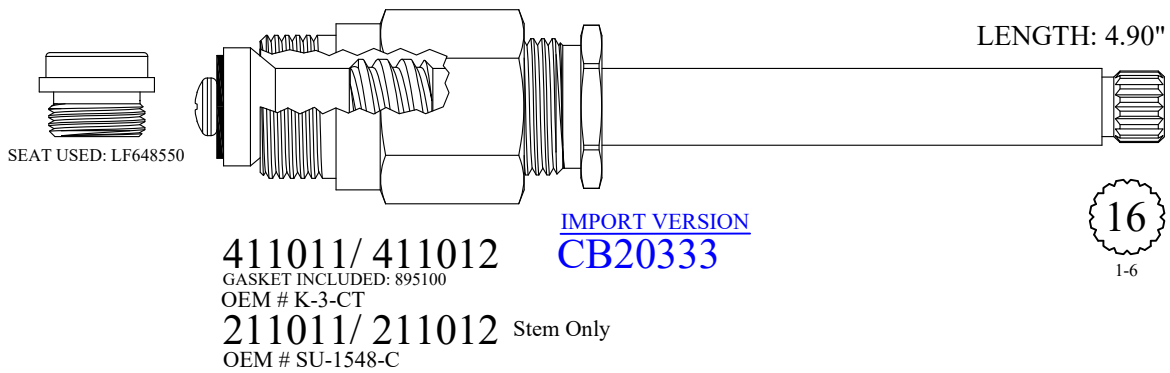

FOR CENTRAL

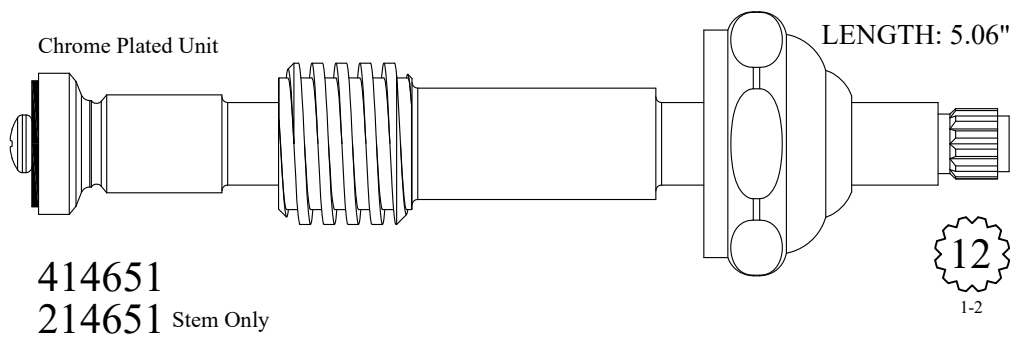
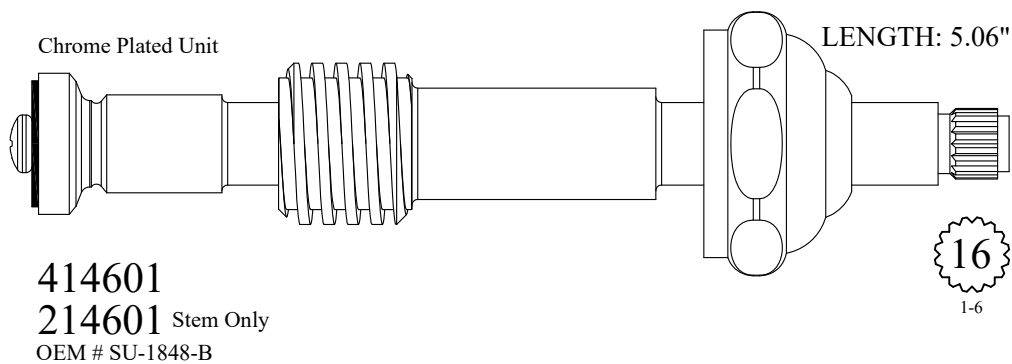
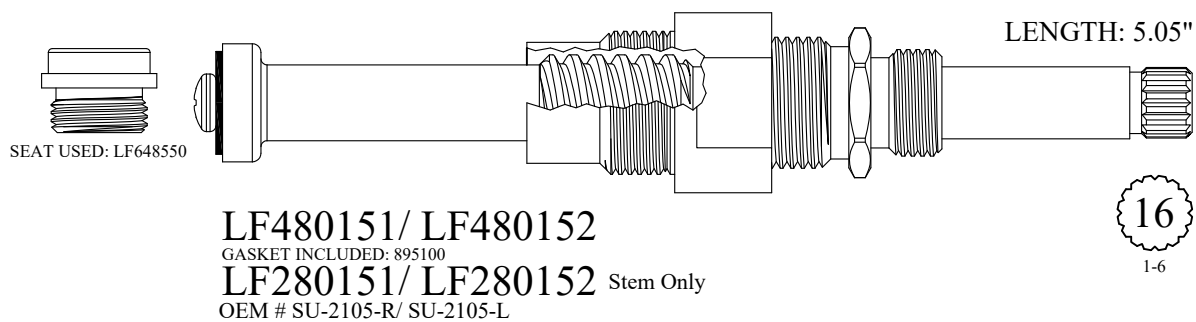
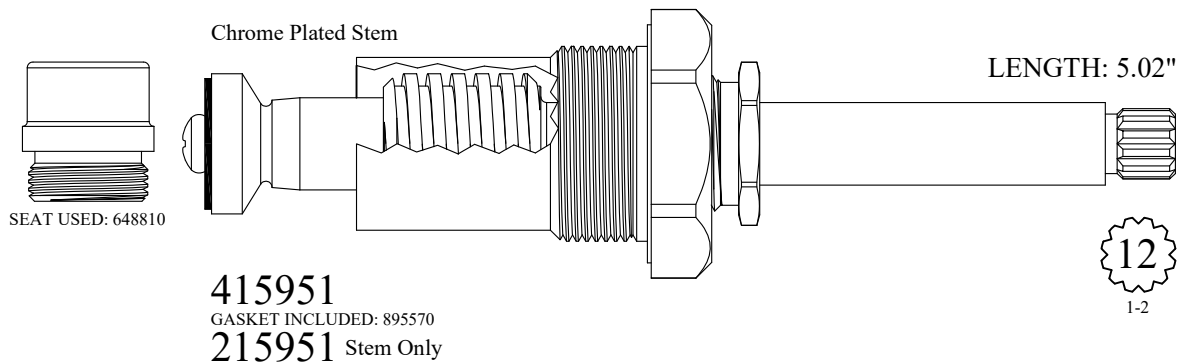

FOR CENTRAL

Chrome Plated Stem

LENGTH: 5.06"

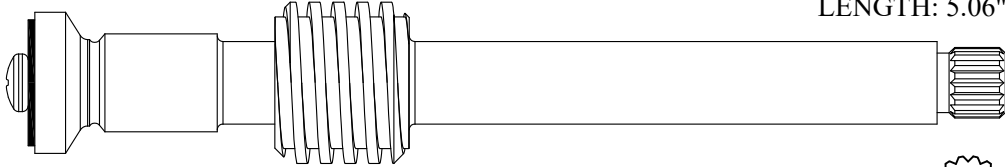

214631
OEM # SU-1848

16
1-6

LENGTH: 5.08"

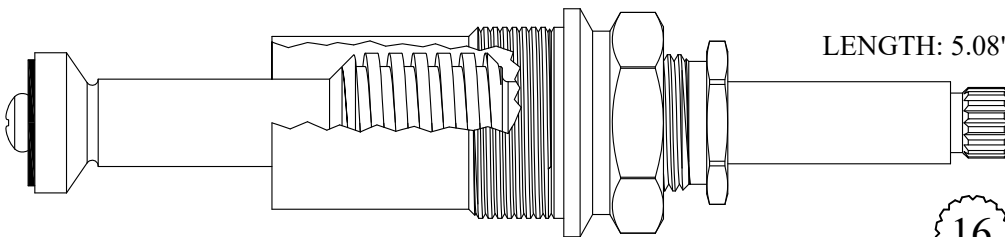

416811
GASKET INCLUDED: 895550
216811 Stem Only

16
1-6

LENGTH: 5.09"

SEAT INCLUDED:
(Part of Barrel Assembly)
LF647850

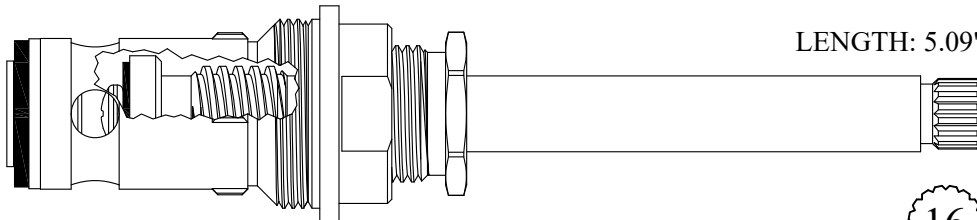

414811/ 414812
GASKET INCLUDED: 895340

16
1-6

LENGTH: 5.09"

SEAT INCLUDED:
(Part of Barrel Assembly)
LF647850

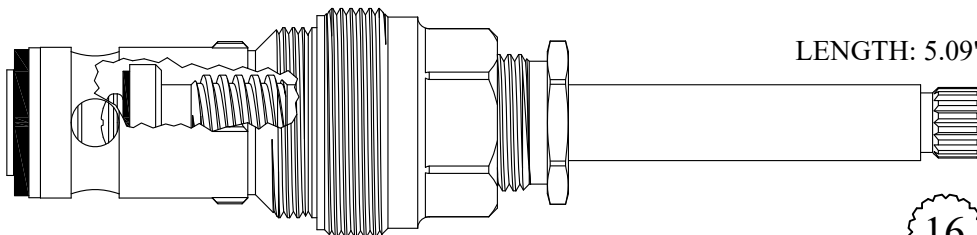

414821
GASKET INCLUDED: 895340

16
1-6

FOR CENTRAL

Chrome Plated Stem

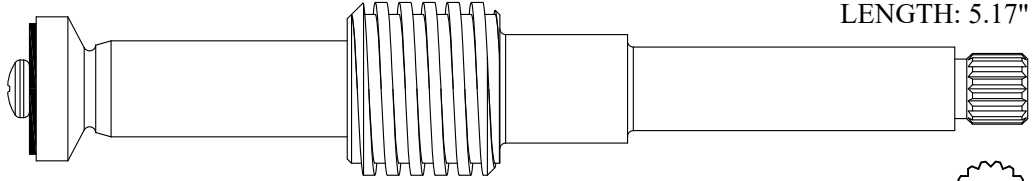

LENGTH: 5.17"

215621

OEM # SU-1840-B



Chrome Plated Stem

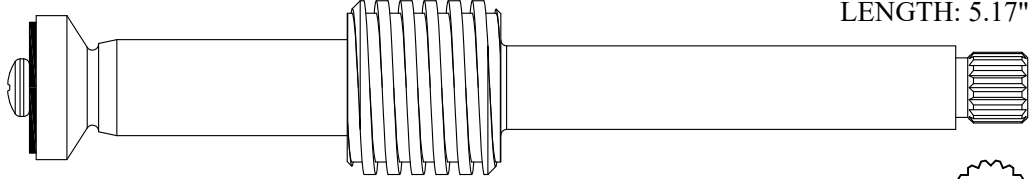

LENGTH: 5.17"

217811

OEM # SU-1840



Chrome Plated Stem

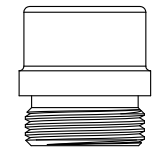

SEAT USED: 648810

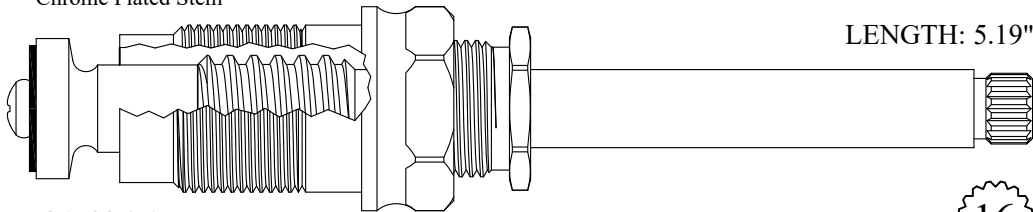

LENGTH: 5.19"

416801

GASKET INCLUDED: 895400

216801 Stem Only

OEM # SU-2087

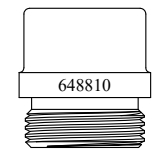

648810

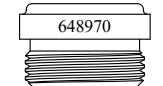

648970

SEAT USED:
648810 OR 648970

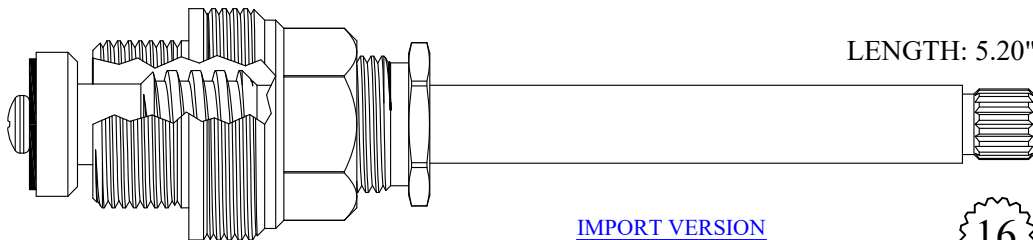

LENGTH: 5.20"

415811/ 415812

GASKET INCLUDED: 895400

OEM # K-2-CS

215801/ 215802 Stem Only

IMPORT VERSION
CB20331

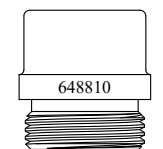

648810

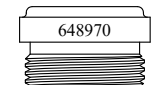

648970

SEAT USED:
648810 OR 648970

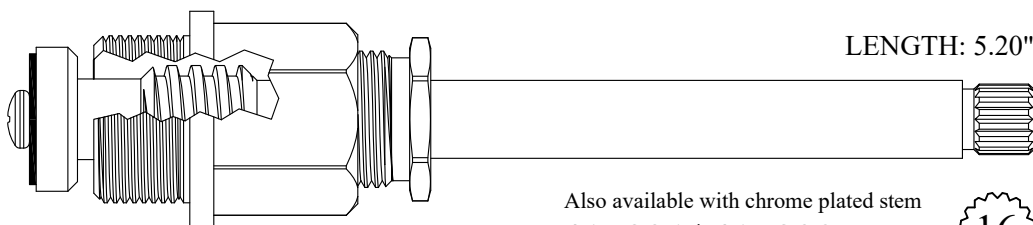

LENGTH: 5.20"

415801/ 415802

GASKET INCLUDED: 895400

OEM # K-2-CT

215801/ 215802 Stem Only

OEM # SU-1548-B

Also available with chrome plated stem

415831/ 415832

GASKET INCLUDED: 895400

215821/ 215822 Stem Only

OEM # SU-1548-605



FOR CENTRAL

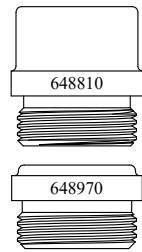

SEAT USED:
648810 OR 648970

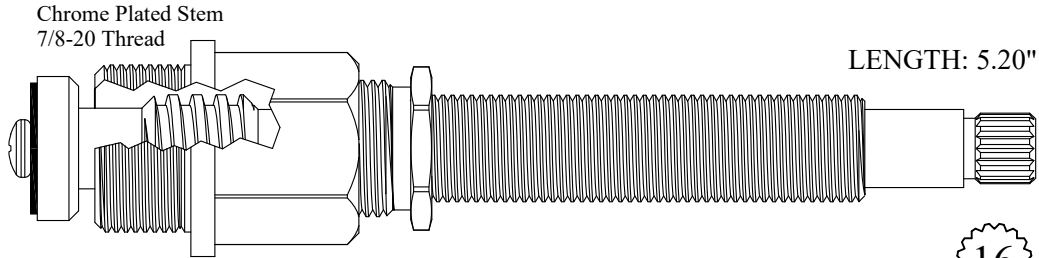

415891
GASKET INCLUDED: 895400
215821 Stem Only
OEM # 1548-605

IMPORT VERSION
CB20336

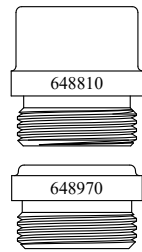

SEAT USED:
648810 OR 648970

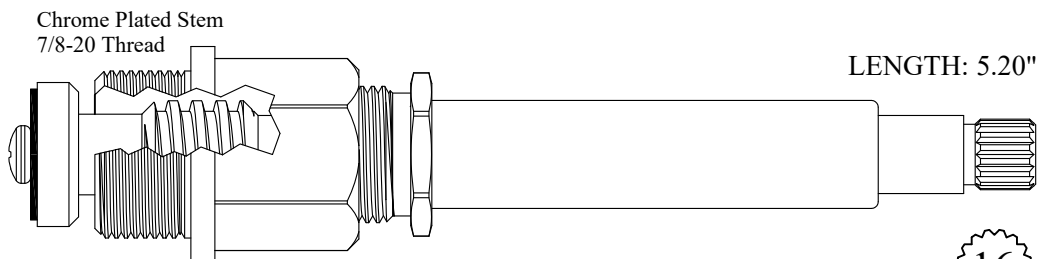

415821/ 415822
GASKET INCLUDED: 895400
215821/ 215822 Stem Only
OEM # 1548-605

IMPORT VERSION
CB20337

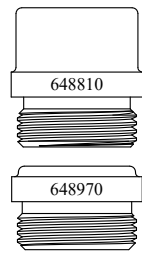

SEAT USED:
648810 OR 648970

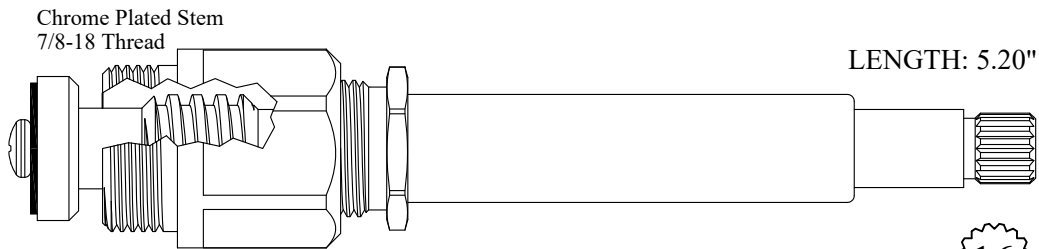

415841
GASKET INCLUDED: 895400
OEM # 607
215821 Stem Only

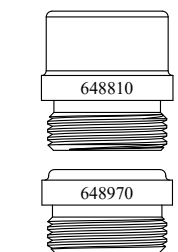

SEAT USED:
648810 OR 648970

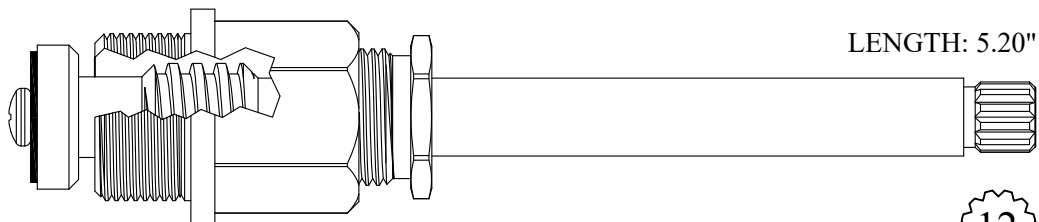

415851/ 415852
GASKET INCLUDED: 895400
215851/ 215852 Stem Only



FOR CENTRAL

Chrome Plated Stem

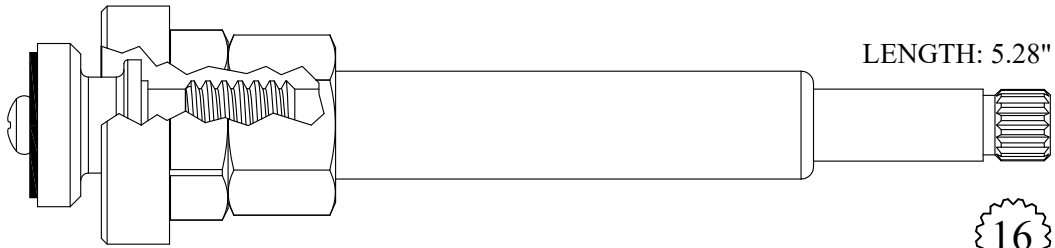

LENGTH: 5.28"

416931

16
1-6

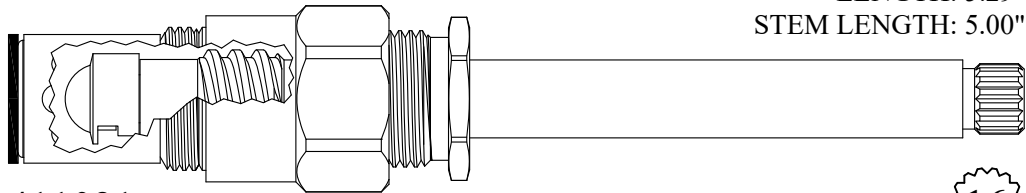

LENGTH: 5.29"
STEM LENGTH: 5.00"

411021

GASKET INCLUDED: 895100

16
1-6

Chrome Plated Stem

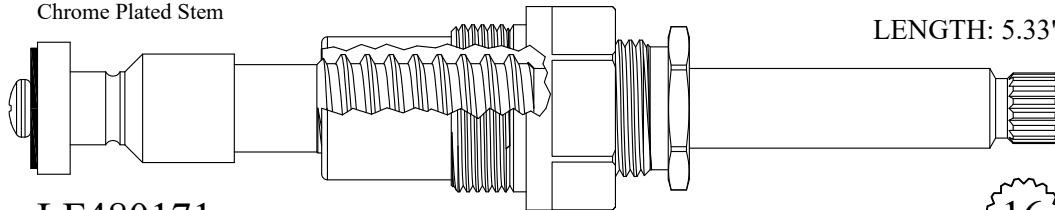

LENGTH: 5.33"

LF480171

GASKET INCLUDED: 895400

LF280171 Stem Only

16
1-6

Chrome Plated Stem

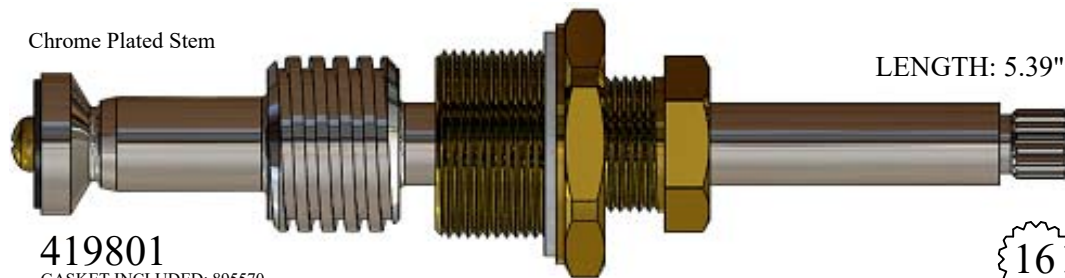

LENGTH: 5.39"

419801

GASKET INCLUDED: 895570

219801 Stem Only

16
1-6

Chrome Plated Unit

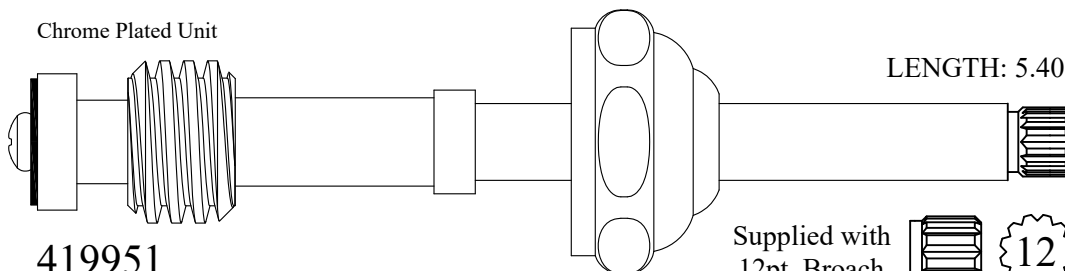

LENGTH: 5.40"

419951

219951 Stem Only

Supplied with
12pt. Broach



12
1-2

FOR CENTRAL

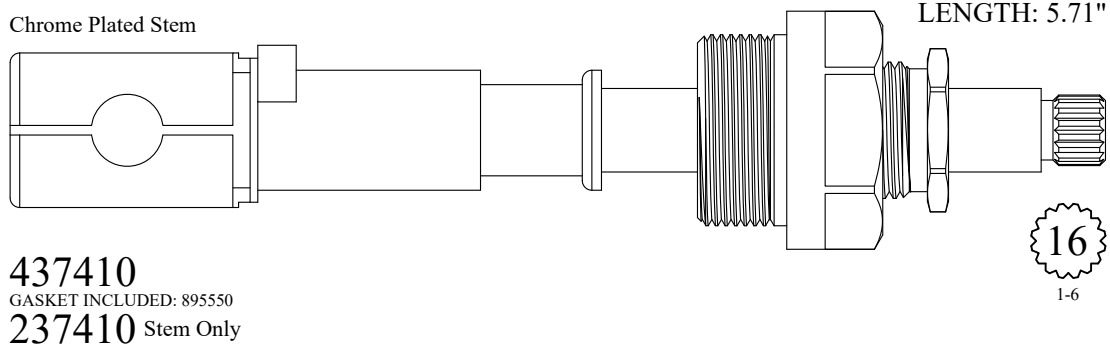
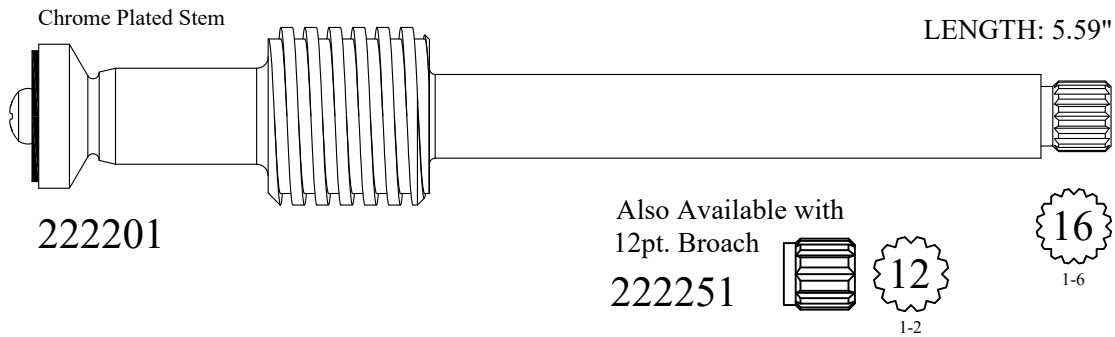
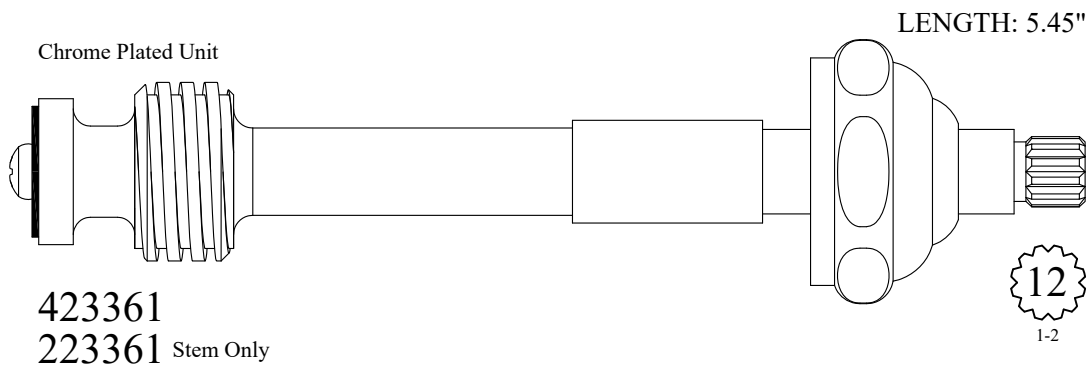
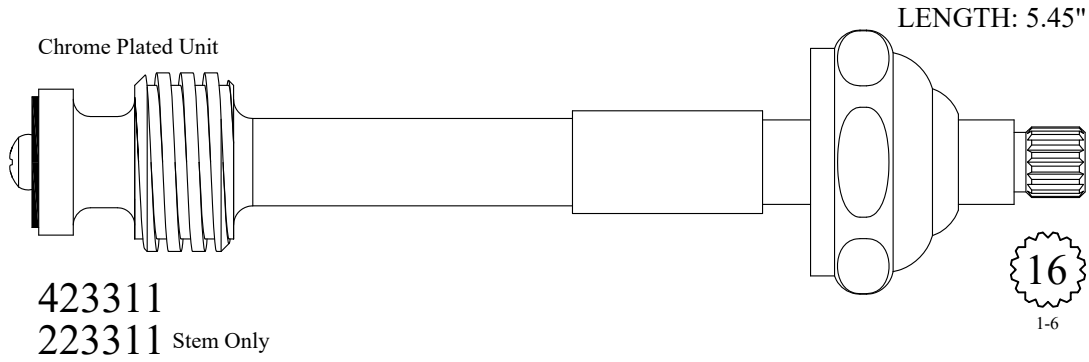

FOR CENTRAL

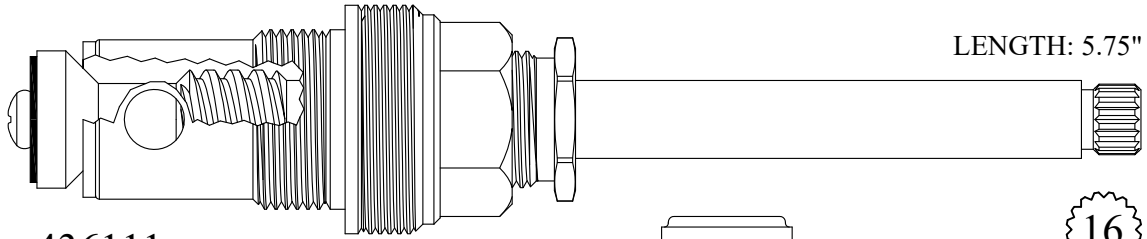

LENGTH: 5.75"

436111
GASKET INCLUDED: 895370
OEM # K-2-DS
236101 Stem Only

IMPORT VERSION
CB20329



SEAT USED: 648970

16
1-6

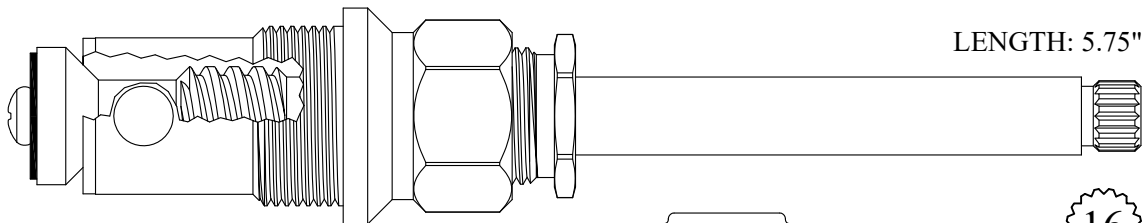

LENGTH: 5.75"

436101
GASKET INCLUDED: 895370
OEM # K-2-DT
236101 Stem Only
OEM # SU-1541

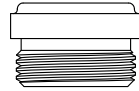

SEAT USED: 648970

16
1-6

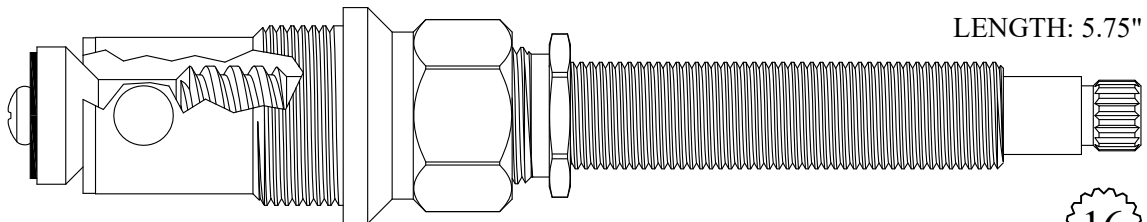

LENGTH: 5.75"

436161
GASKET INCLUDED: 895370



SEAT USED: 648970

16
1-6

Chrome Plated Tube

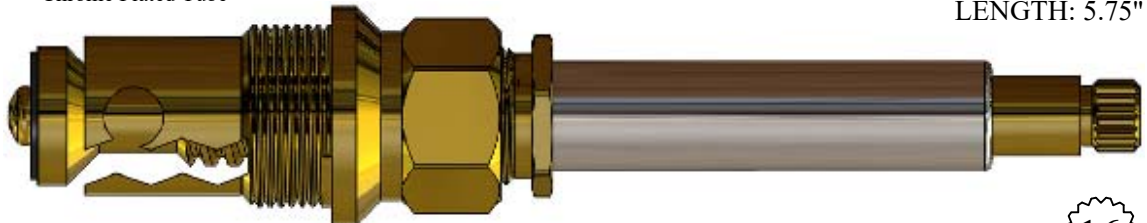

LENGTH: 5.75"

436281
GASKET INCLUDED: 895370
236101 Stem Only



SEAT USED: 648970

16
1-6

FOR CENTRAL

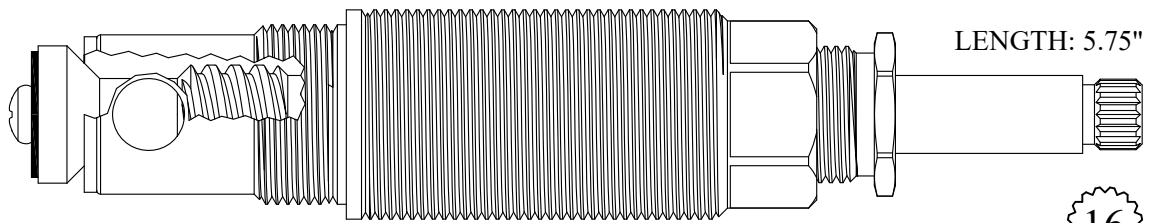

436141
GASKET INCLUDED: 895370
236101 Stem Only

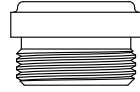

SEAT USED: 648970

16
1-6

Chrome Plated Stem & Tube

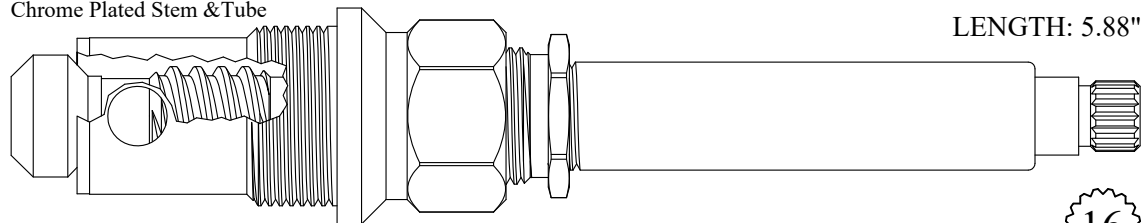

436121
GASKET INCLUDED: 895370
236121 Stem Only

16
1-6

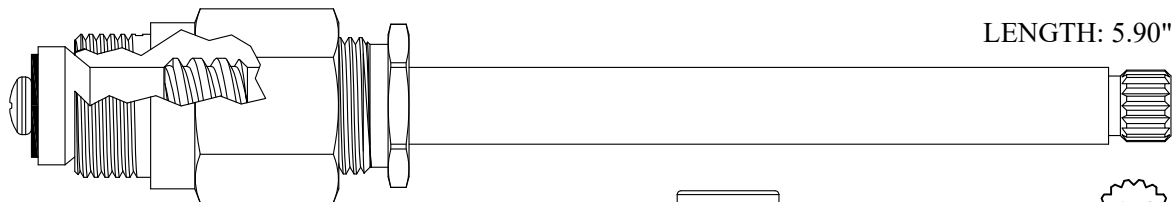

426211/ 426212
GASKET INCLUDED: 895100
226211/ 226212 Stem Only

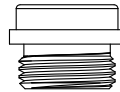

SEAT USED: LF648550

16
1-6

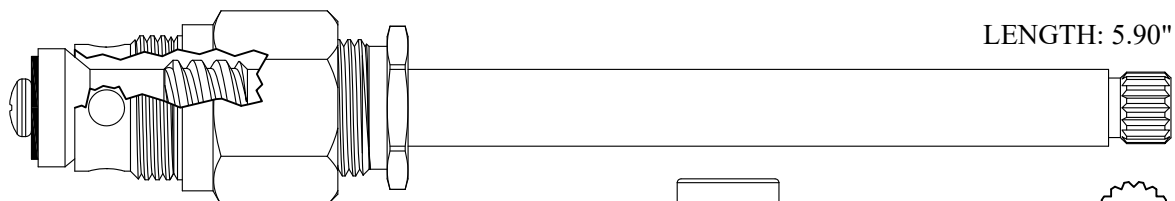

436231
GASKET INCLUDED: 895100
226211 Stem Only



SEAT USED: LF648550

16
1-6

FOR CENTRAL

SEAT INCLUDED
AS PART OF THE
BARREL ASSEMBLY
LF647850

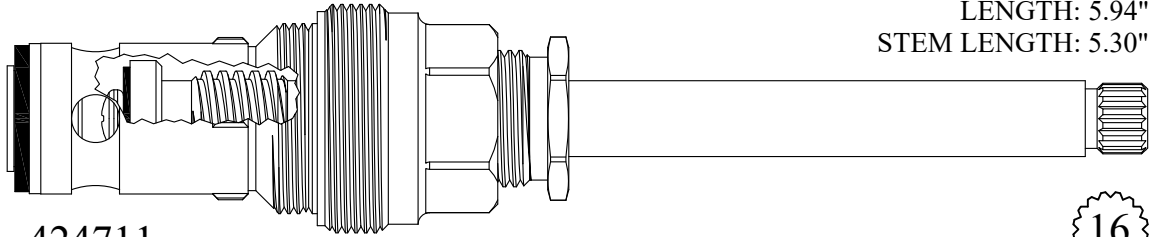

LENGTH: 5.94"
STEM LENGTH: 5.30"

424711

GASKET INCLUDED: 895340
OEM # P-226

16
1-6

Chrome Plated Stem

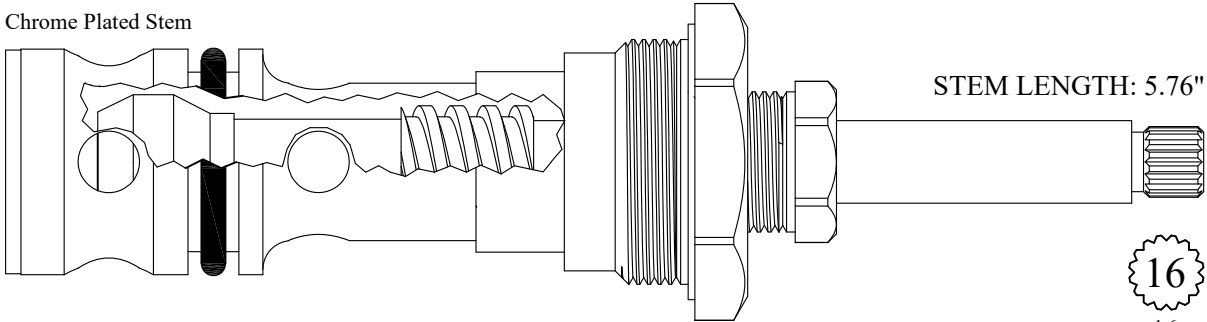

STEM LENGTH: 5.76"

438741

238741 Stem Only

16
1-6

Chrome Plated Unit

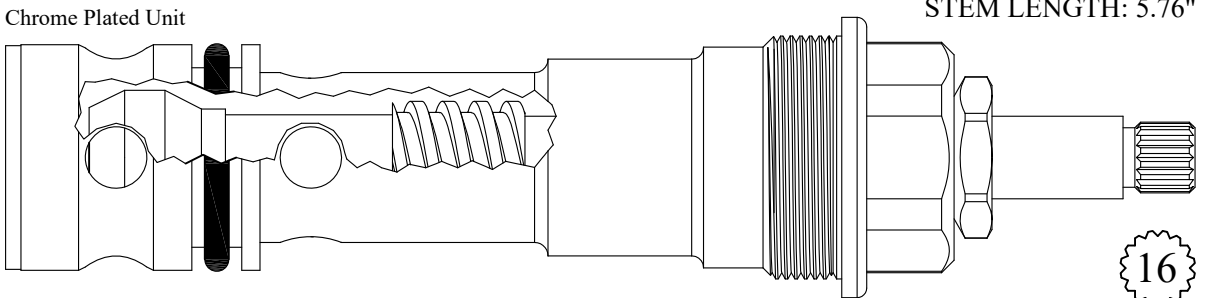

STEM LENGTH: 5.76"

438671

238741 Stem Only

16
1-6

FOR CHASE

Chrome Plated Stem

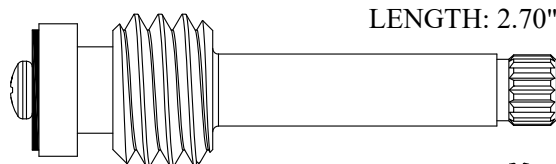

LENGTH: 2.70"

LF264171

16
1-6

FOR CHG

Gland thread turns
clockwise
into valve body

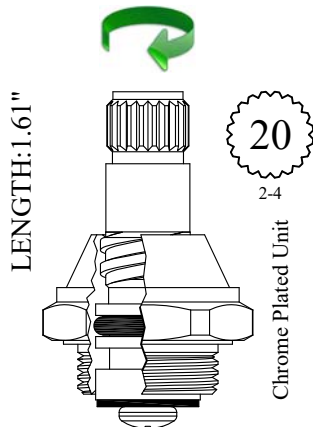

GASKET INCLUDED: 895100

LF455411
LF455412

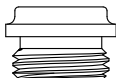

SEAT USED: LF648270

Gland thread turns
counter-clockwise
into valve body

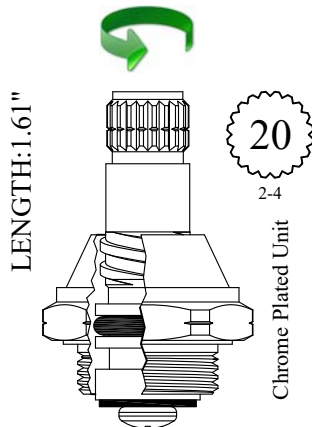

GASKET INCLUDED: 895100

LF455462

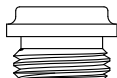

SEAT USED: LF648270

Gland thread turns
clockwise
into valve body



Knurled lock ring also available

952900

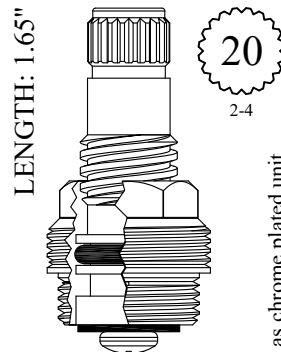
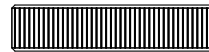

GASKET USED: 895100

LF452901
LF452902



SEAT USED: LF648270
OEM # 456000007
OEM # 456000008

Also available as chrome plated unit
LF452901-CP/ LF452902-CP

IMPORT VERSION - H & C PAIR
3057-STEM-PR-LF

Gland thread turns
counter-clockwise
into valve body

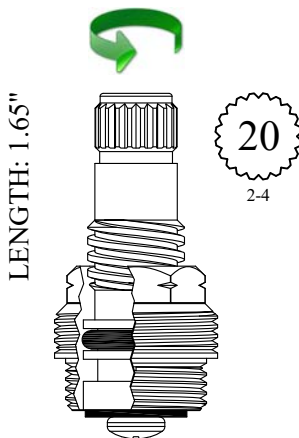

GASKET INCLUDED: 895100

LF452922



SEAT USED: LF648270

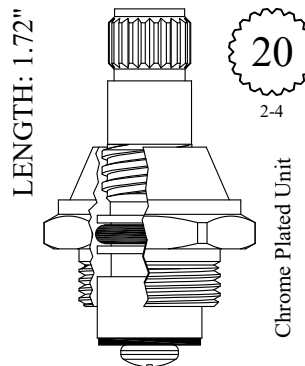

GASKET INCLUDED: 895100

LF455401
OEM # 455000007
LF455402
OEM # 455000008



SEAT USED: LF648270

FOR CHG

STEM LENGTH: 1.94"

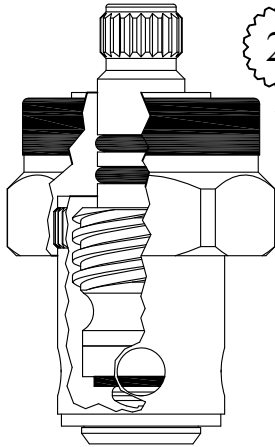

Chrome Plated Stem & Bonnet

LF462571
OEM # KL41-Y007
LF462572
OEM # KL41-Y006

STEM LENGTH: 2.08"



Chrome Plated Unit

LF462241
LF462242

STEM LENGTH: 2.29"

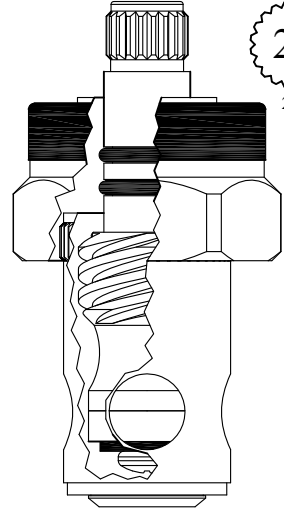

Chrome Plated Stem & Bonnet

LF463921
OEM # KL55-Y010
LF463922
OEM # KL55-Y011

STEM LENGTH: 2.56"

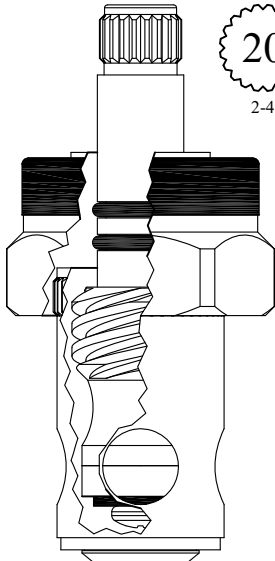

Chrome Plated Stem & Bonnet

LF466481
OEM # KL50-Y007
LF466482
OEM # KL50-Y006



Also available: Complete
Unit with Handle
LF466481-32955 Hot
LF466482-32955 Cold

STEM LENGTH: 2.85"

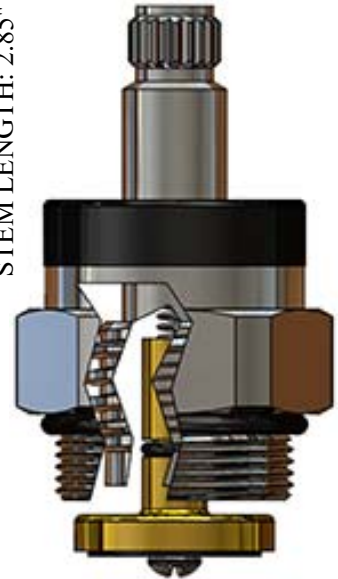

Chrome Plated Stem & Bonnet

GASKET: 890170 O-RING INCLUDED

LF465491
OEM # KL34-Y007
LF465492

FOR CHICAGO

CHICAGO MVP METERING



CH10323-LF
OEM # 667-080KJKABNF

Also Available with Complete Cartridge & Handle

CH10325-LF
OEM # 665-RKPABCP

SLOW COMPRESSION

LENGTH: 2.65"

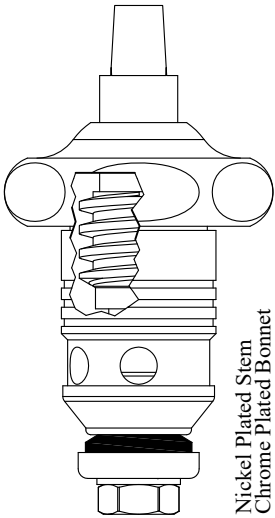

Nickel Plated Stem
Chrome Plated Bonnet

CORK GASKET INCLUDED: 895200

LF464991
LF464992

SLOW COMPRESSION

LENGTH: 2.65"

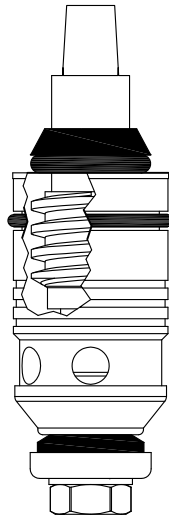

Nickel Plated Stem

CORK GASKET INCLUDED: 895200

LF465001
LF465002

QUATURN

LENGTH: 2.65"

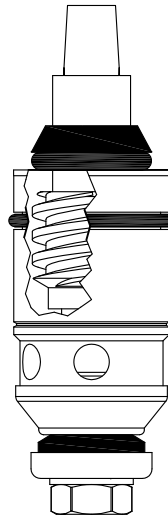

Nickel Plated Stem

IMPORT VERSION
CH10320-LF
CH10321-LF

CORK GASKET INCLUDED: 895200

LF465041
OEM # 1-99JK
LF465042
OEM # 1-100JK

FOR CHICAGO

QUATURN

LENGTH: 2.65"

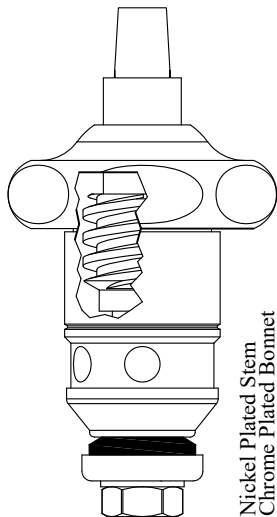

Nickel Plated Stem
Chrome Plated Bonnet

CORK GASKET INCLUDED: 895200

LF465051
LF465052

SLOW COMPRESSION
CONTROL-A-FLOW

LENGTH: 2.65"

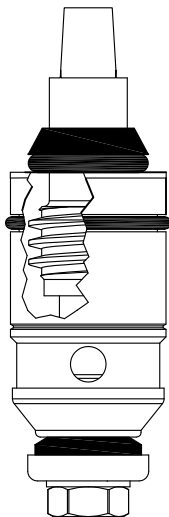

Nickel Plated Stem

CORK GASKET INCLUDED: 895200

LF465231
OEM # 217-X245RKJKABNF
LF465232
OEM # 217-X245LKJKABNF

QUATURN
CONTROL-A-FLOW

LENGTH: 2.65"

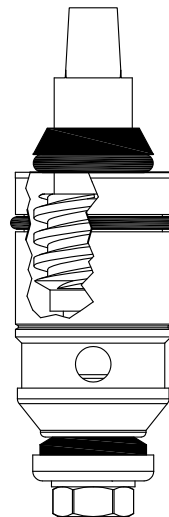

Nickel Plated Stem

CORK GASKET INCLUDED: 895200

LF465241
OEM # 1-099-245JKABNF
LF465242
OEM # 1-100-245JKABNF

NEW STYLE
QUATURN

LENGTH: 2.65"

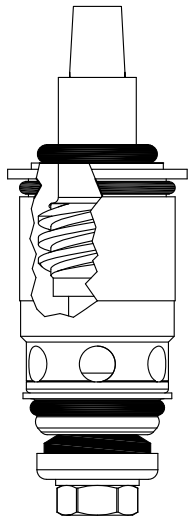

Nickel Plated Stem

CORK GASKET INCLUDED: 895200

LF465221
OEM # 1-099XTJKABNF
LF465222
OEM # 1-100XTJKABNF

NEW STYLE
SLOW COMPRESSION

LENGTH: 2.65"

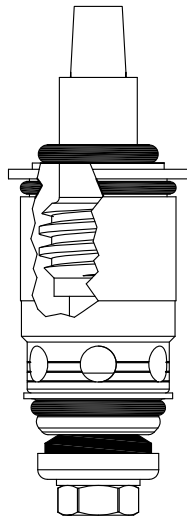

Nickel Plated Stem

CORK GASKET INCLUDED: 895200

LF465281
OEM # 217-XTRHJKABNF
LF465282
OEM # 217-XTLHJKABNF

QUATURN

LENGTH: 3.36"

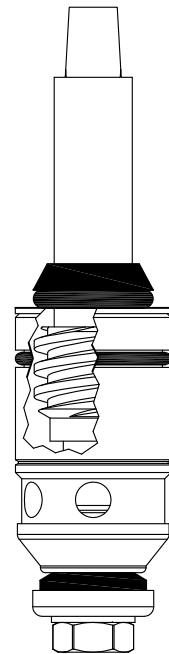

Nickel Plated Stem

CORK GASKET INCLUDED: 895200

LF467091
OEM # 377-XRH
LF467092
OEM # 377-XLH

FOR CHICAGO

SLOW COMPRESSION

LENGTH: 3.36"

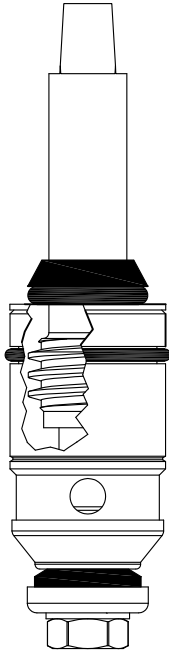

Nickel Plated Stem

CORK GASKET INCLUDED: 895200

LF467101
LF467102

QUATURN

LENGTH: 3.36"

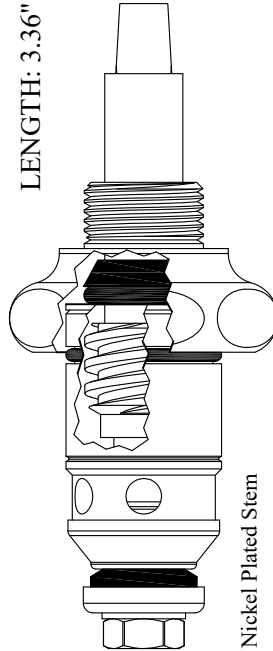

Nickel Plated Stem

CORK GASKET INCLUDED: 895200

LF467181
LF467182

QUATURN

LENGTH: 3.36"

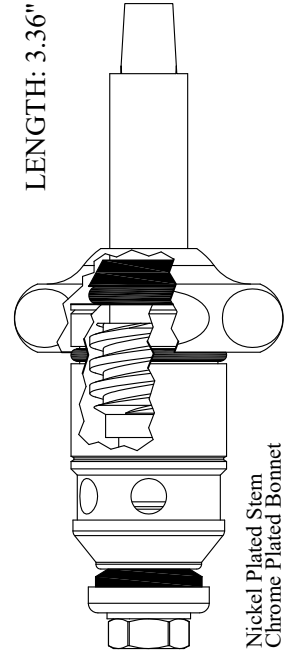

Nickel Plated Stem
Chrome Plated Bonnet

CORK GASKET INCLUDED: 895200

LF467191
LF467192

NEW STYLE QUATURN

LENGTH: 3.39"

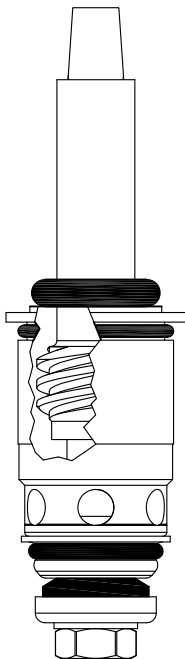

Nickel Plated Stem

CORK GASKET INCLUDED: 895200

LF467131
OEM # 377-XTRHJKABNF
LF467132
OEM # 377-XTLHJKABNF

NEW STYLE
SLOW COMPRESSION

LENGTH: 3.39"

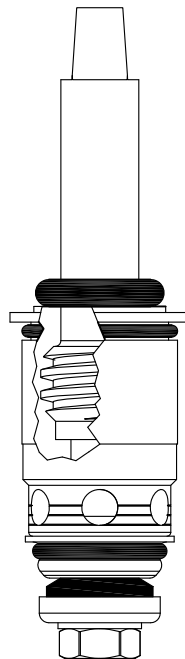

Nickel Plated Stem

CORK GASKET INCLUDED: 895200

LF467221
OEM # 274-XTRHJKABNF
LF467222
OEM # 274-XTLHJKABNF

LENGTH: 3.55"

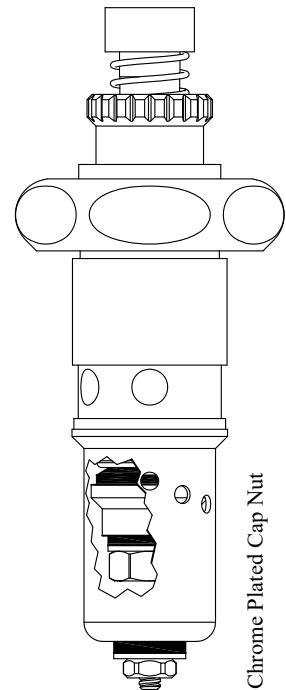

Chrome Plated Cap Nut

LF468320
OEM # 355-XJKABNF

FOR CHICAGO

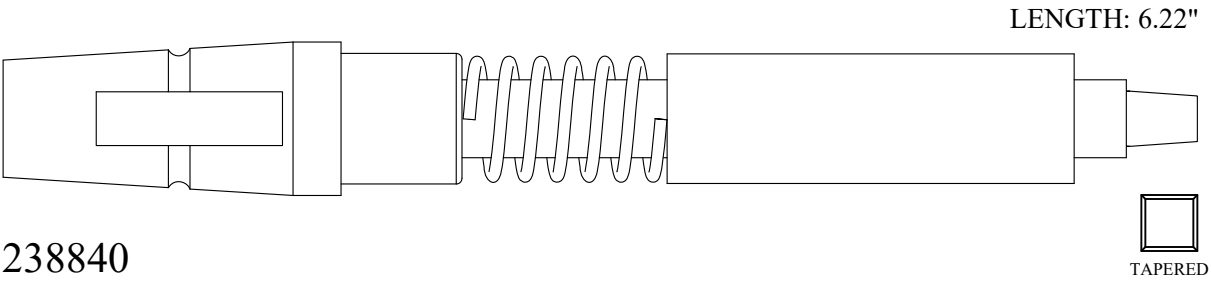
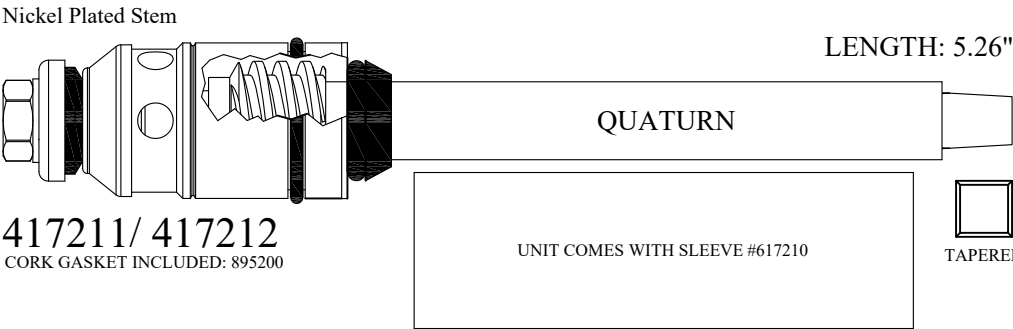
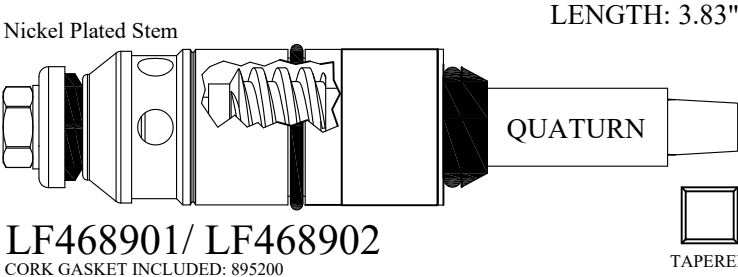

BARRY E.  WALTER SR. CO.

FOR CIFIAL

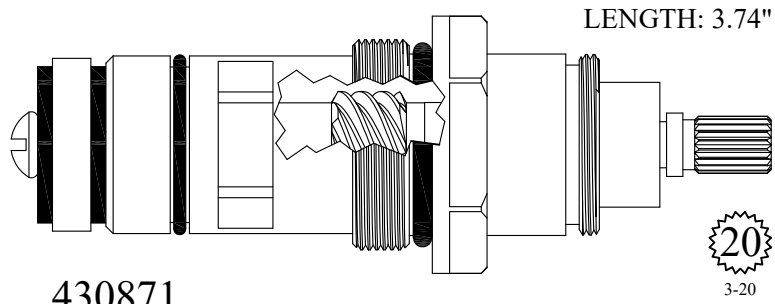

430871

GASKET: 891180 O-RING INCLUDED

FOR CLEVELAND

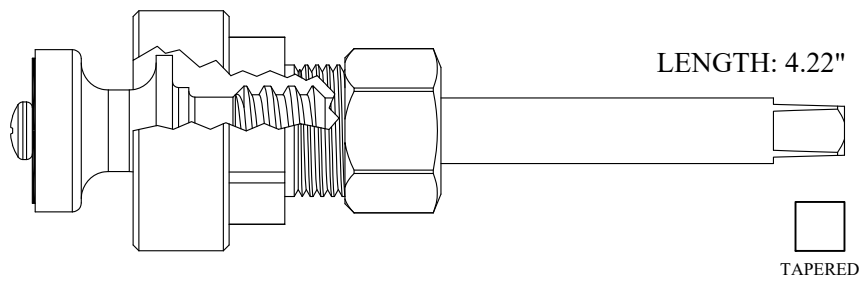

470791

FOR CONCINNITY

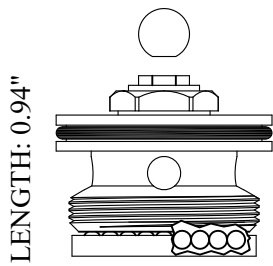

LENGTH: 0.94"

LF450111
OEM # 30336
LF450112
OEM # 30337

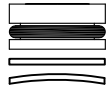

SEAT USED: 647140

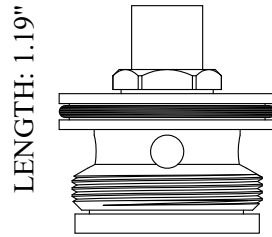

LENGTH: 1.19"

LF450161
LF450162

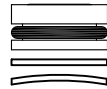

SEAT USED: 647140



LENGTH: 2.00"

LF456160

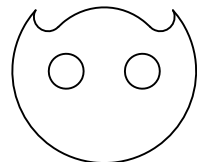

BOTTOM VIEW

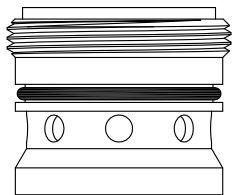

SEAT KIT USED: 106090

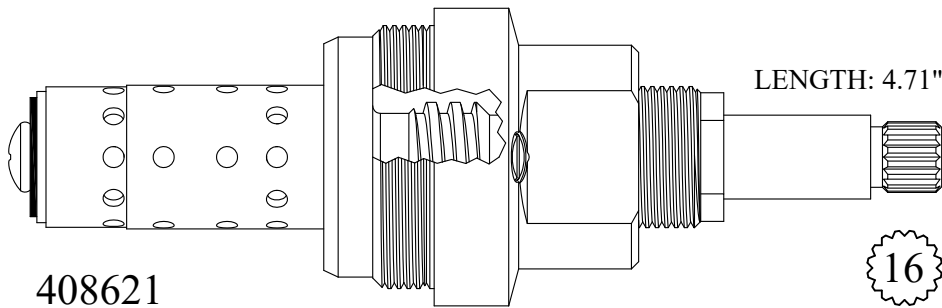

LENGTH: 4.71"

408621
GASKET INCLUDED: 895500
208621 Stem Only



FOR COYNE DELANEY

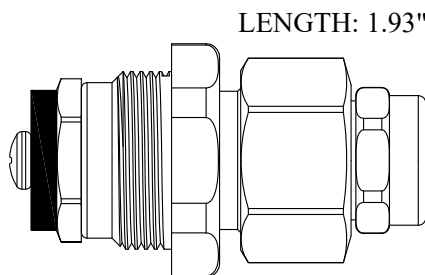

LENGTH: 1.93"

460302

GASKET INCLUDED: 895370
OEM # 89A-J

Chrome Plated Unit

FOR CRANE

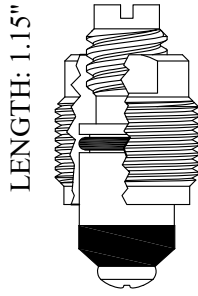

LENGTH: 1.15"

400201
200201 Stem Only
 OEM # F12078

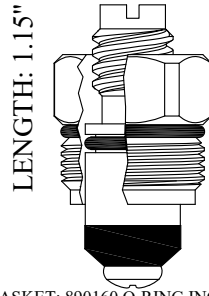

LENGTH: 1.15"

GASKET: 890160 O-RING INCLUDED

400211
 OEM # FB9238
200201 Stem Only
 OEM # F12078

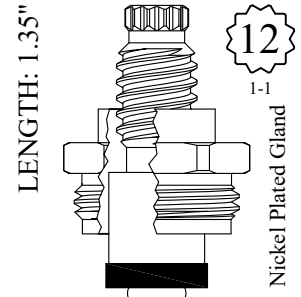

LENGTH: 1.35"

12

Nickel Plated Gland

GASKET INCLUDED: 895180

400411
 OEM # FB8358
400412
 OEM # FB8359

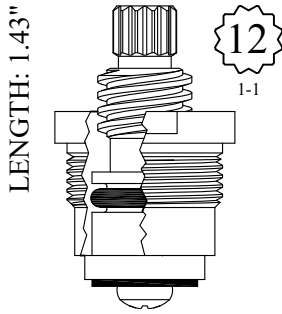

LENGTH: 1.43"

12
1-1

GASKET INCLUDED: 895180

LF451021
LF451022

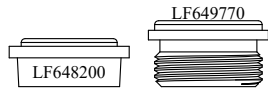

SEAT USED: LF648200 or LF649770

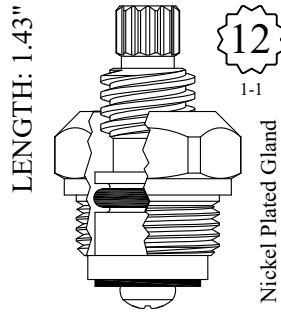

LENGTH: 1.43"

12
1-1

Nickel Plated Gland

GASKET INCLUDED: 895100

LF451061
 OEM # FB9137
LF451062
 OEM # FB9138



SEAT USED: LF649430

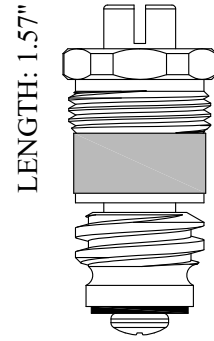

LENGTH: 1.57"

452821
252821 Stem Only
 OEM # FB9301

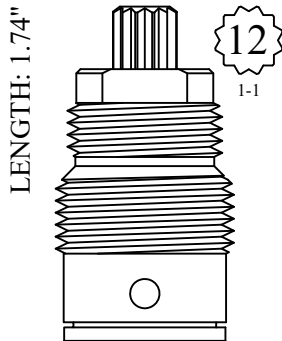

LENGTH: 1.74"

12
1-1

CORK GASKET INCLUDED: 895250

LF453300
 OEM # FB11285

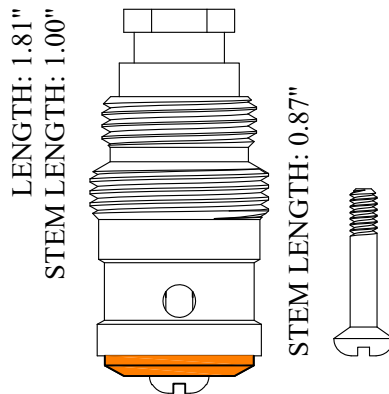

LENGTH: 1.81"
 STEM LENGTH: 1.00"

STEM LENGTH: 0.87"

Shorter version stem available

LF103990

CORK GASKET INCLUDED: 895250

LF458700
 OEM # 355174
LF258700 Stem Only
 OEM # 301715

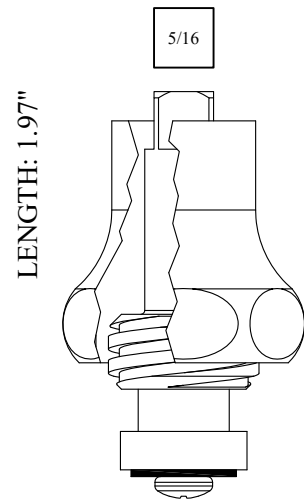

LENGTH: 1.97"

5/16

Also available with chrome plated bonnet

461541-CP

461541
261541 Stem Only

FOR CRANE

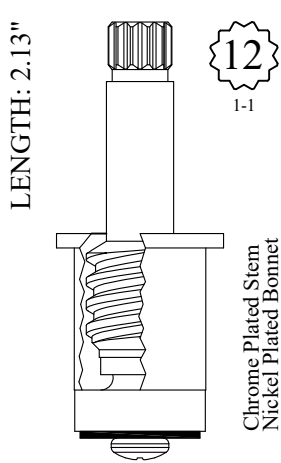

LF460041
OEM # FB197
LF460042
OEM # FB203

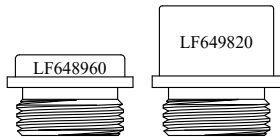

SEAT USED: LF648960 or LF649820

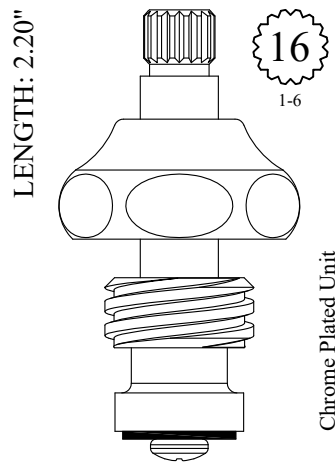

LF461041
LF461042
LF261041 Stem Only
OEM # FB9302
LF261042 Stem Only
OEM # FB9303

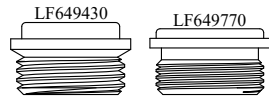

SEAT USED: LF649430 or LF649770

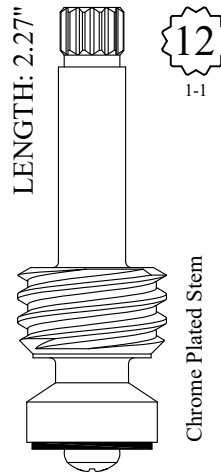

LF261151
LF261152

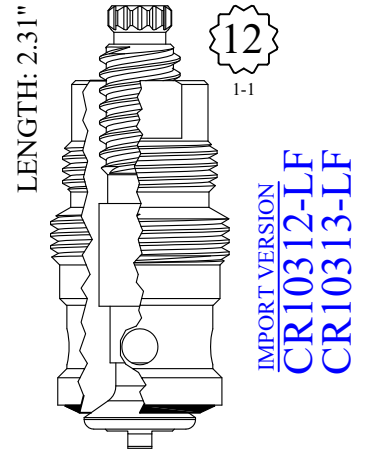

CORK GASKET INCLUDED: 895250

LF462011
OEM # FB8552
LF462012
OEM # FB8553
LF262011 Stem Only
OEM # 300108 OR F12535
LF262012 Stem Only
OEM # 300107 OR F12536

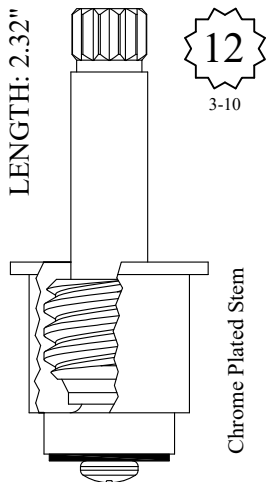

LF462131
LF262131 Stem Only

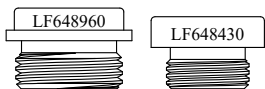

SEAT USED: LF648960 or LF648430

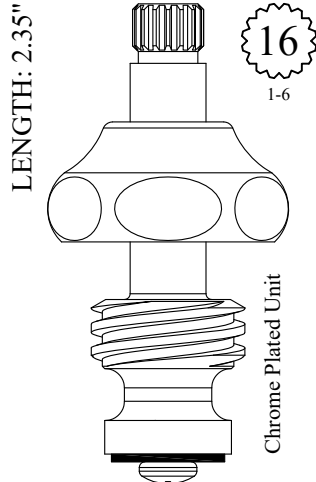

LF461931
LF261931 Stem Only

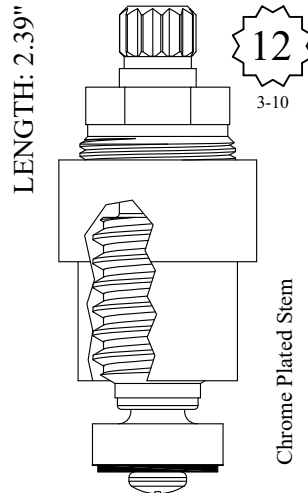

LF462611
LF462612



SEAT USED: LF649920

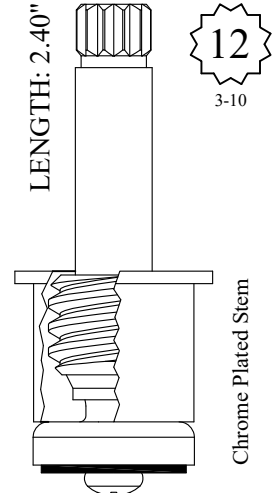

LF462071
OEM # FB68
LF462072
OEM # FB150



SEAT USED: LF648340

FOR CRANE

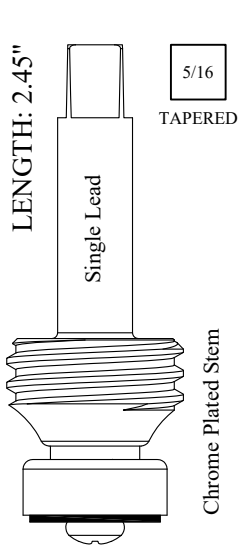

LF263401

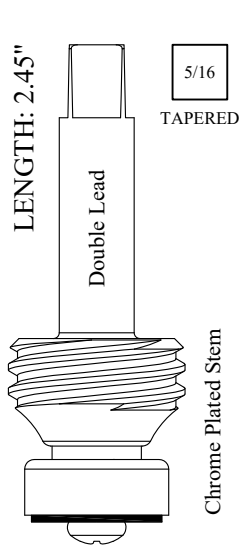

LF263411
LF263412

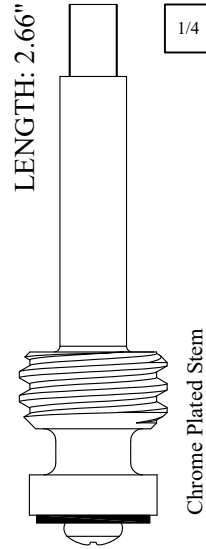

LF264461

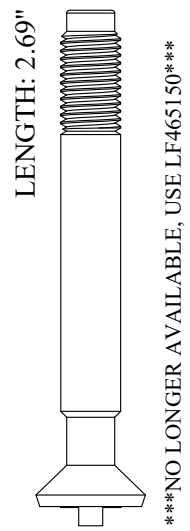

LF265140

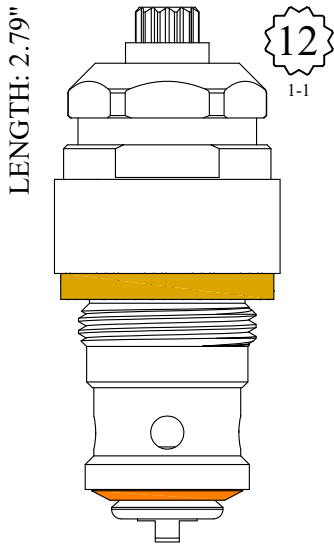

LF456090

OEM # FB8401
LF256090 Stem Only
OEM # F12537

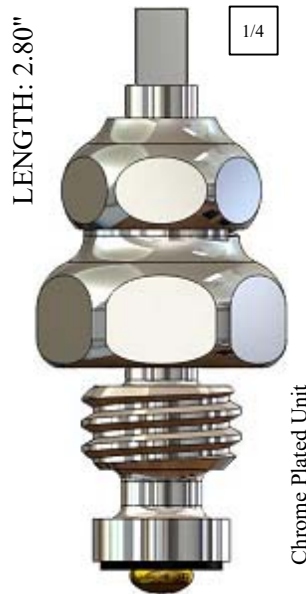

LF464461

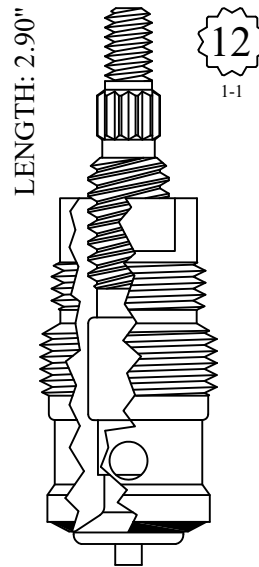

GASKET INCLUDED: 895250
LF465121
OEM # FB8807 / 354014
LF465122
OEM # FB8808 / 354013
LF265121 Stem Only
OEM # 301142 or FB13167
LF265122 Stem Only
OEM # 301141 or FB13168

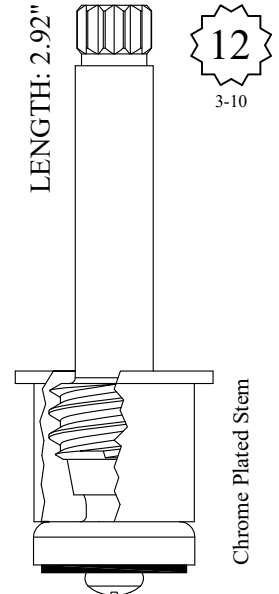

LF466051

OEM # FB168
LF466052
OEM # FB174



SEAT USED: LF648340

FOR CRANE

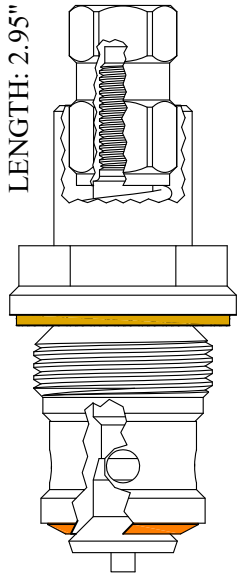

LENGTH: 2.95"

Chrome Plated Sleeve

CORK GASKET INCLUDED: 895250

LF465150

OEM # FB8361 OR 355777

LF265150 Stem Only

OEM # F12539

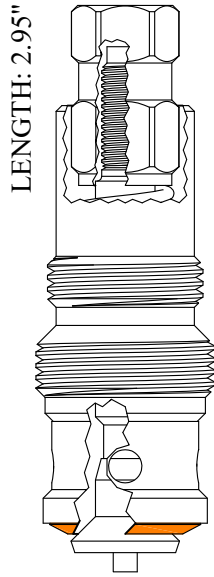

LENGTH: 2.95"

CORK GASKET INCLUDED: 895250

LF465160

LF265150 Stem Only

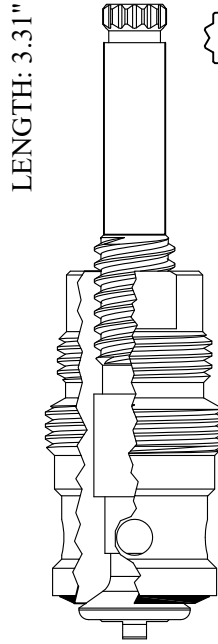

LENGTH: 3.31"

12
1-1

CORK GASKET INCLUDED: 895250

402431

402432

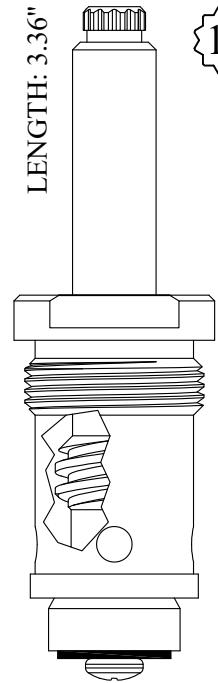

LENGTH: 3.36"

12
1-1

430631

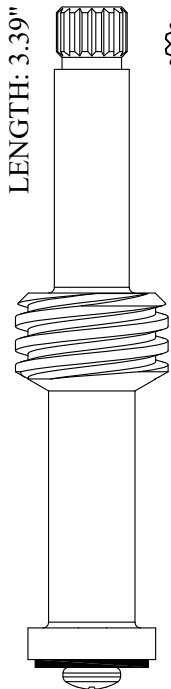

LENGTH: 3.39"

16
1-6

Chrome Plated Stem

LF268091
LF268092



LENGTH: 3.48"

Supplied with
12pt. Broach

12
1-2

Chrome Plated Stem

LF267161

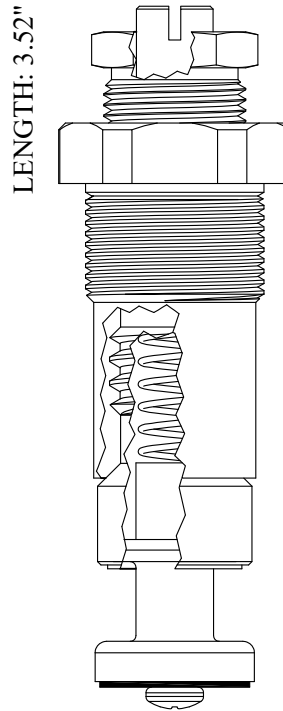

LENGTH: 3.52"

GASKET INCLUDED: 895370

402731

202731 Stem Only

OEM # FB8368 or 355764



SEAT USED: LF648340

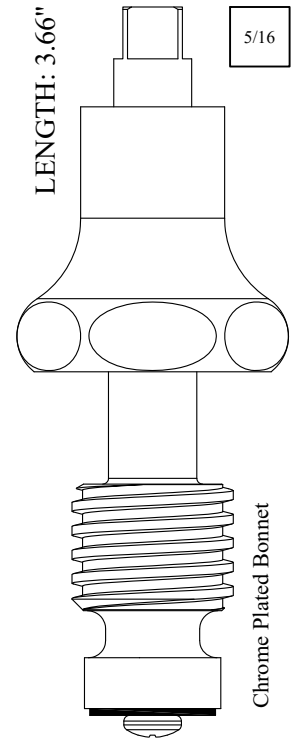

LENGTH: 3.66"

5/16

Chrome Plated Bonnet

403121

203121 Stem Only

FOR CRANE

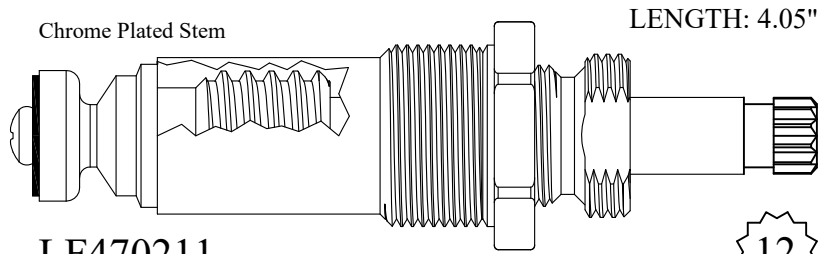
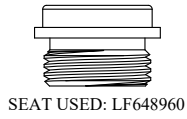

LF470211
GASKET INCLUDED: 895320

12
3-10

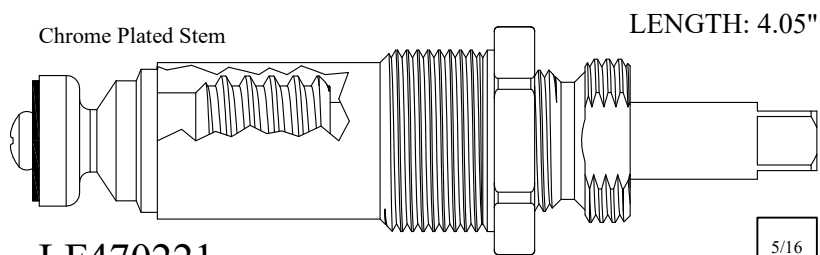

LF470221
GASKET INCLUDED: 895320

5/16

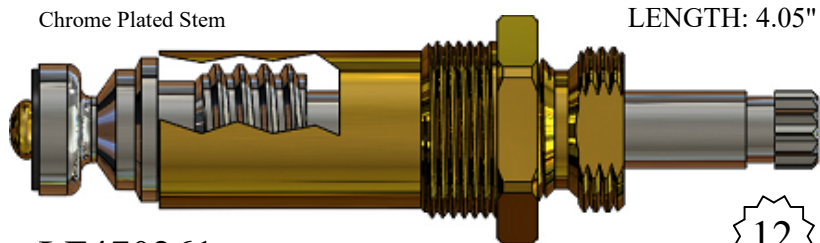

LF470261
GASKET INCLUDED: 895290

12
3-10

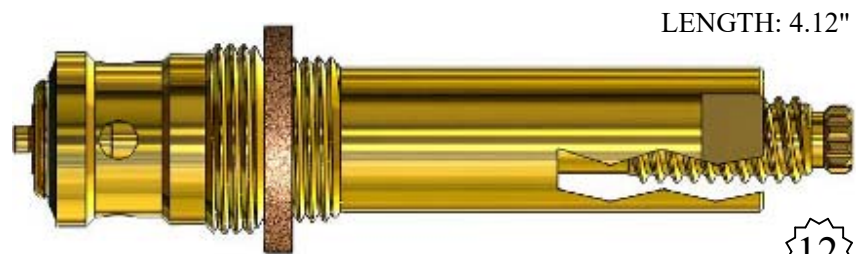

404631 / 404632
CORK GASKET INCLUDED: 895250

12
1-1

FOR CRANE

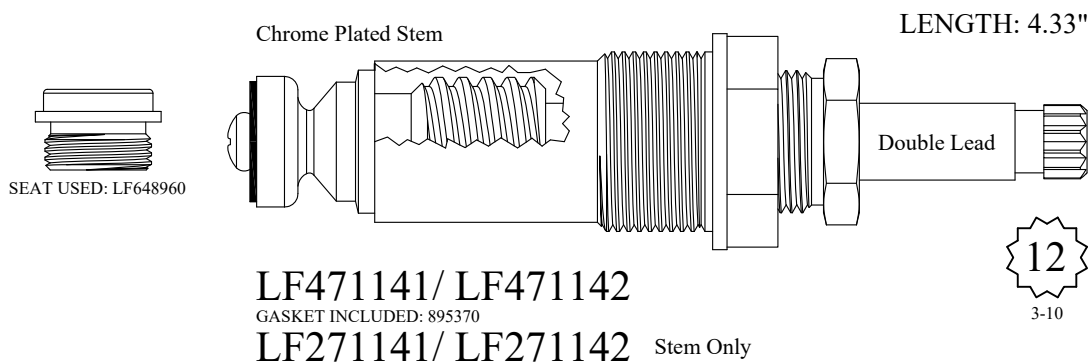
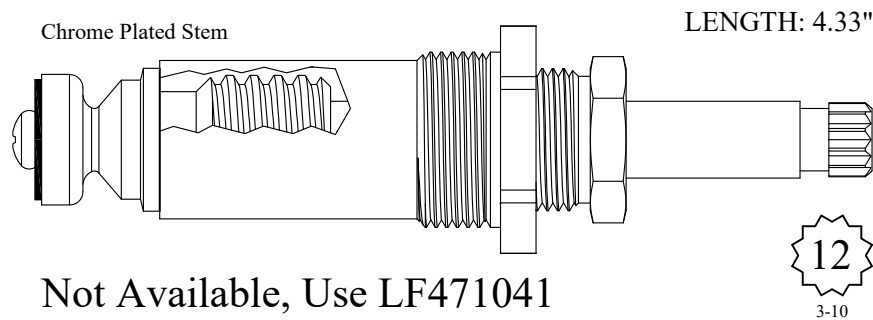
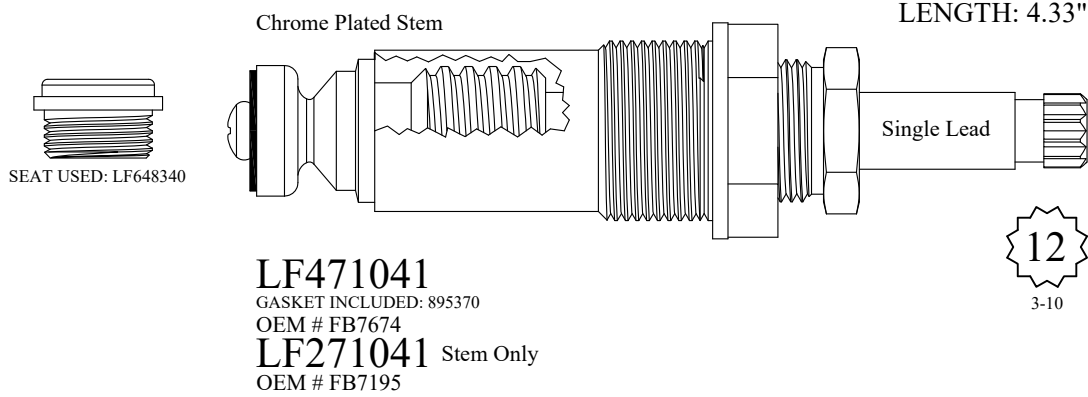
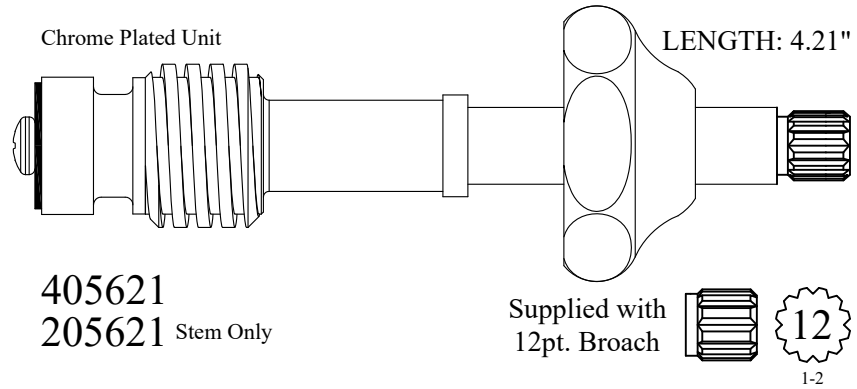

FOR CRANE



SEAT USED: LF648960

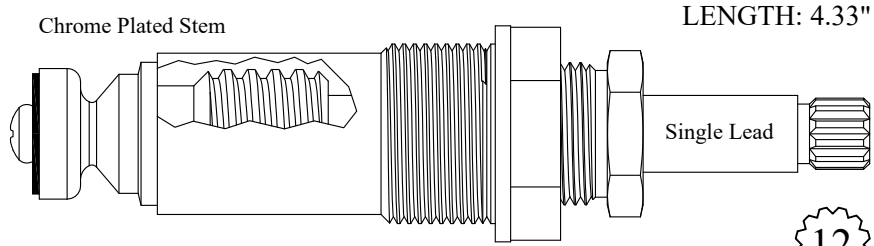

LENGTH: 4.33"

LF471121
 GASKET INCLUDED: 895370
LF271121 Stem Only

12
1-2

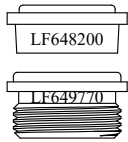

SEAT USED: LF648200 or LF649770

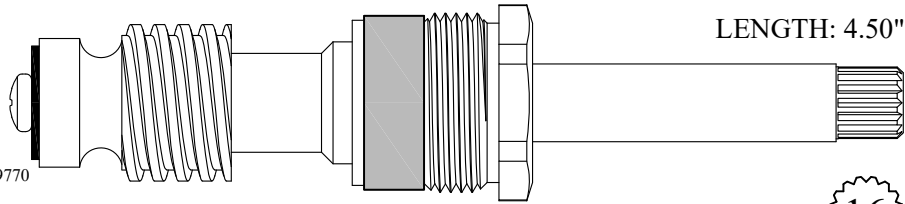

LENGTH: 4.50"

LF473031/ LF473032
LF273031/ LF273032 Stem Only
 OEM # 515L-5

16
1-6

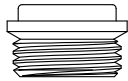

SEAT USED: LF649430

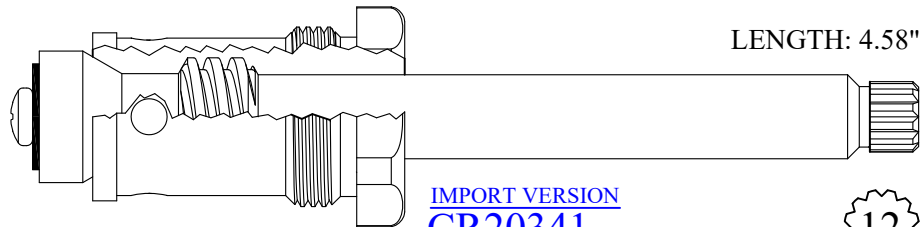

LENGTH: 4.58"

430901
 GASKET INCLUDED: 895320
 OEM # FB9520
230901 Stem Only
 OEM # FB9519

IMPORT VERSION
CR20341

12
1-2



SEAT USED: LF649430

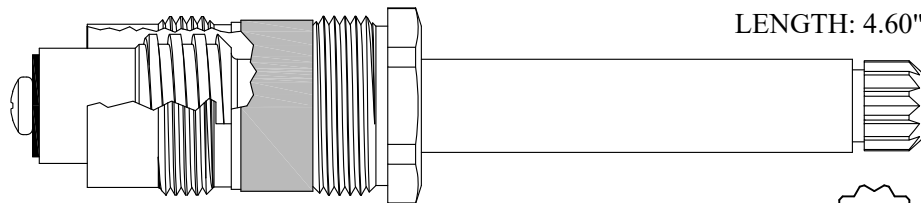

LENGTH: 4.60"

408001
208001 Stem Only
 OEM # FB11047 or FB16830 or FB13985

12

FOR CRANE

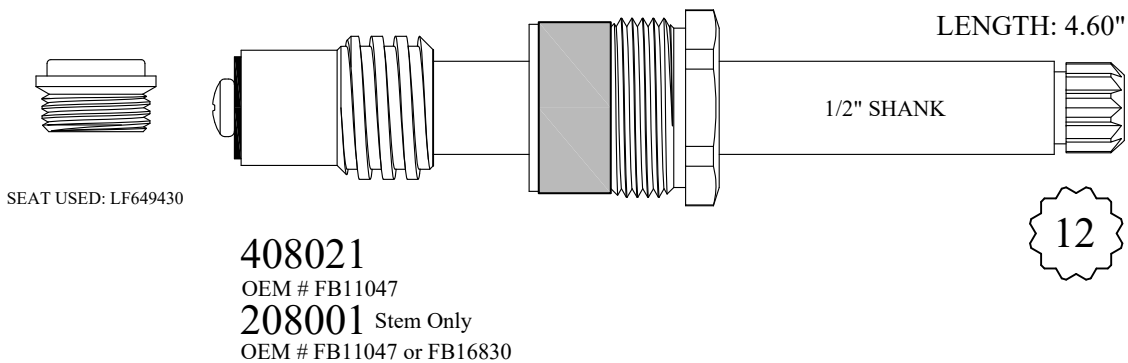
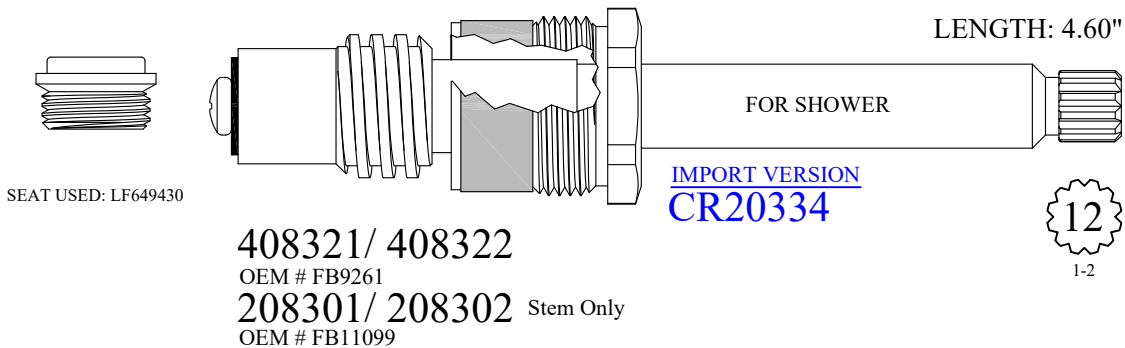
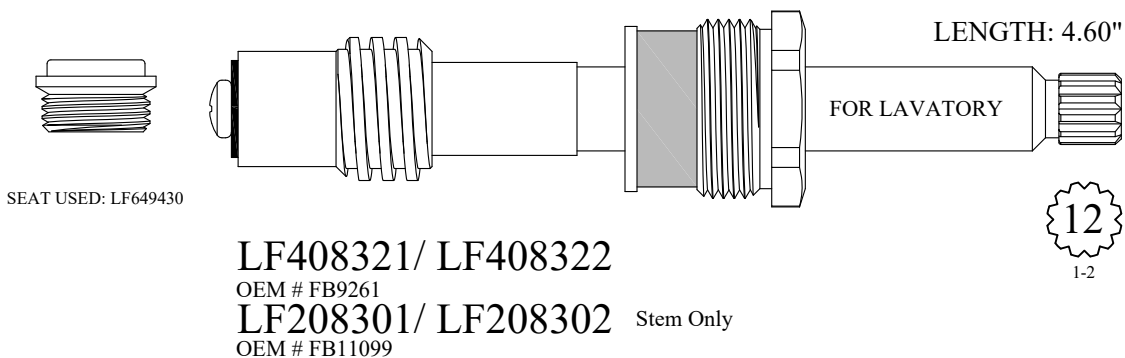
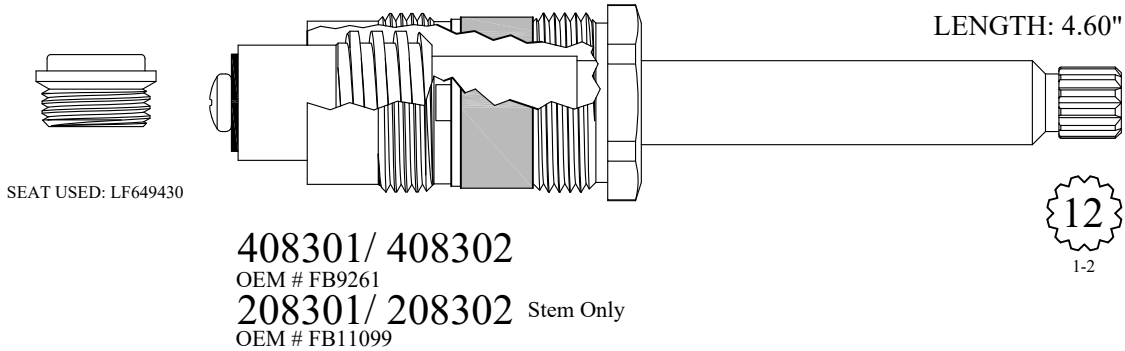

FOR CRANE

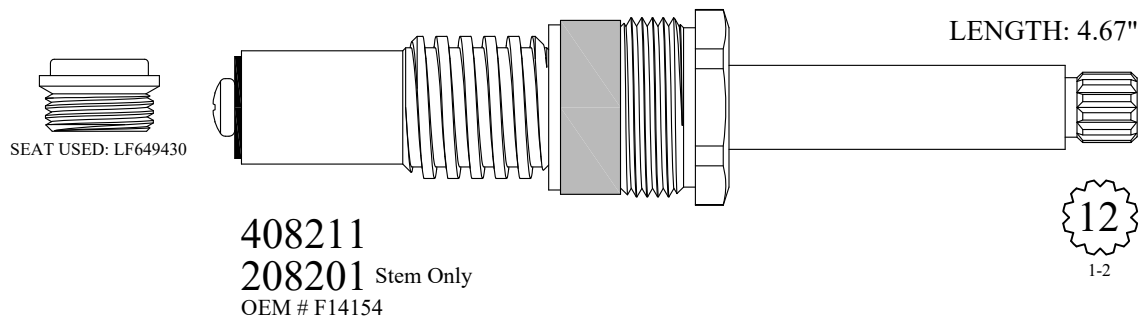
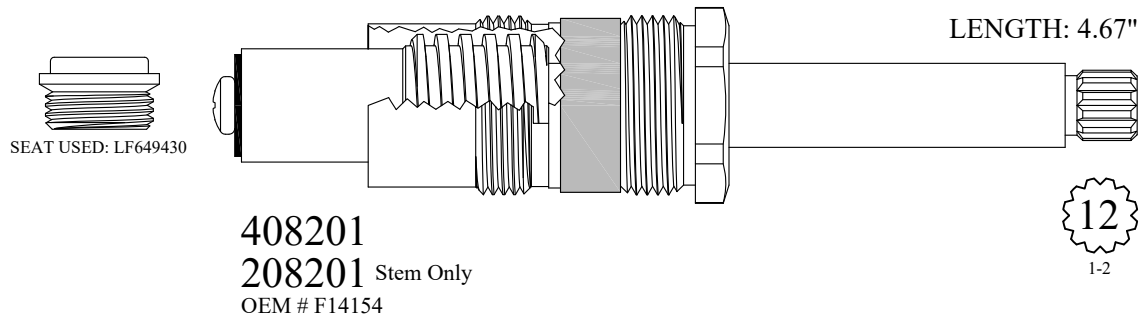
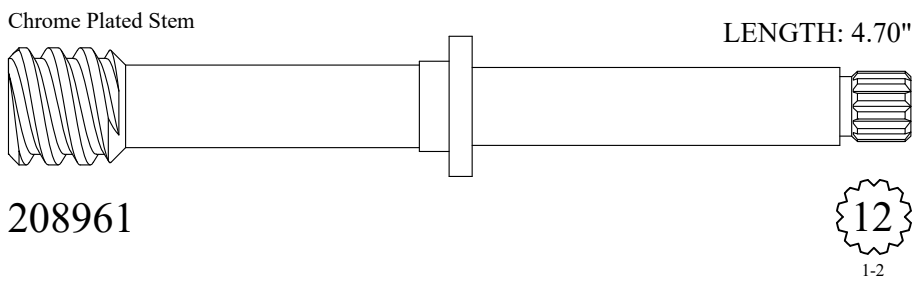
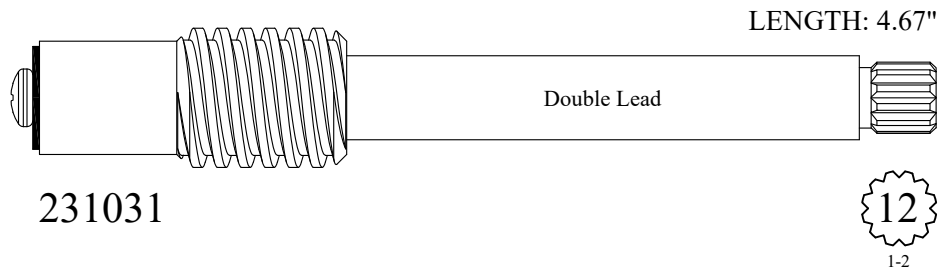

FOR CRANE

Chrome Plated Stem

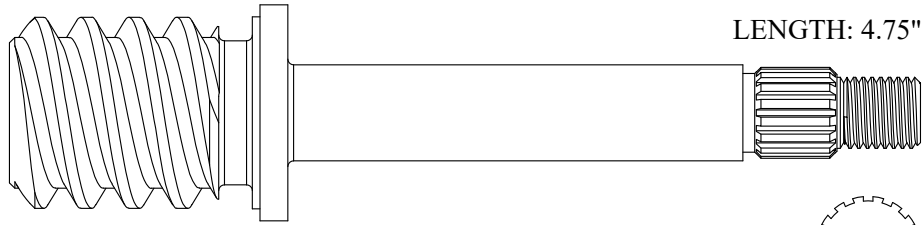

LENGTH: 4.75"

212511
OEM # F4406



Chrome Plated Bonnet

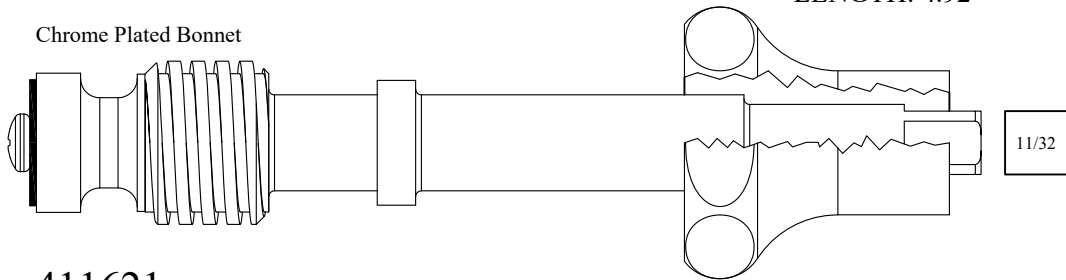

LENGTH: 4.92"

411621
211621 Stem Only

11/32

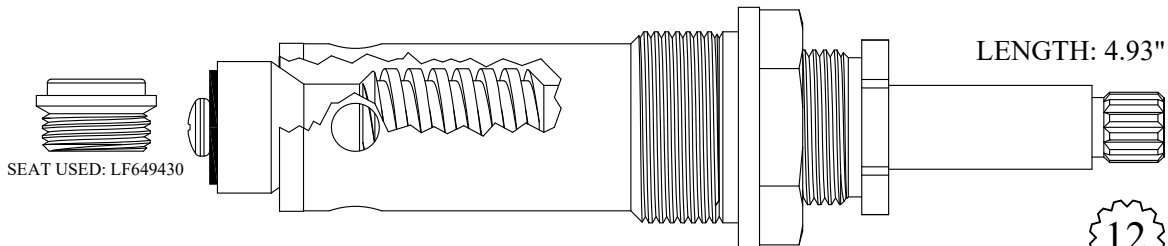

LENGTH: 4.93"

SEAT USED: LF649430

431901
GASKET INCLUDED: 895550
OEM # 137-5B
231901 Stem Only



1-2

BARRY E.  ALTER  SR. CO.

FOR CRANE

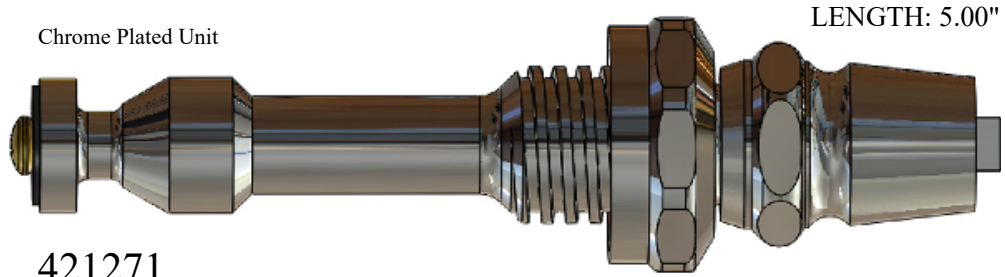

Chrome Plated Unit

LENGTH: 5.00"

9/32

421271
221271 Stem Only

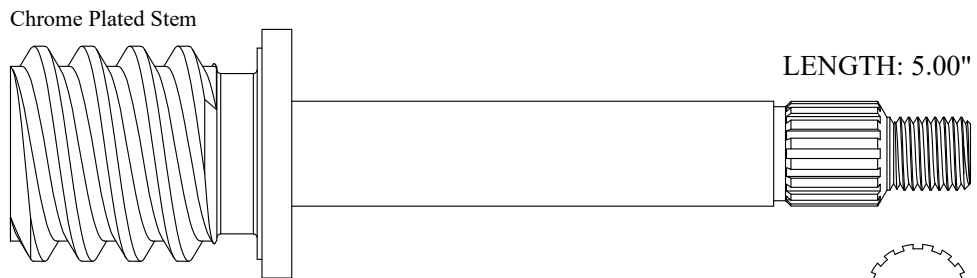

Chrome Plated Stem

LENGTH: 5.00"

212581

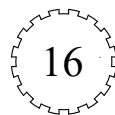

SEAT USED: 647730

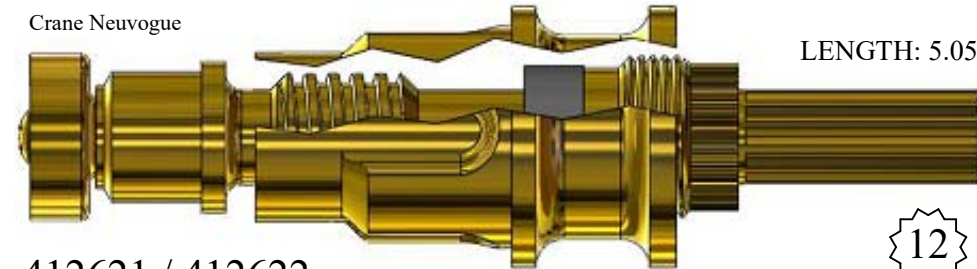

Crane Neuvogue

LENGTH: 5.05"

412621 / 412622

GASKET INCLUDED: 895450



3-10

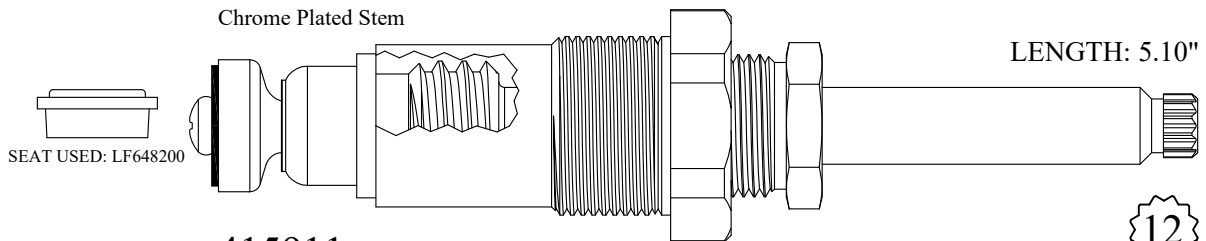

Chrome Plated Stem

LENGTH: 5.10"

SEAT USED: LF648200

415911
GASKET INCLUDED: 895370
OEM # FB8464 RH
215911 Stem Only



1-1

FOR CRANE

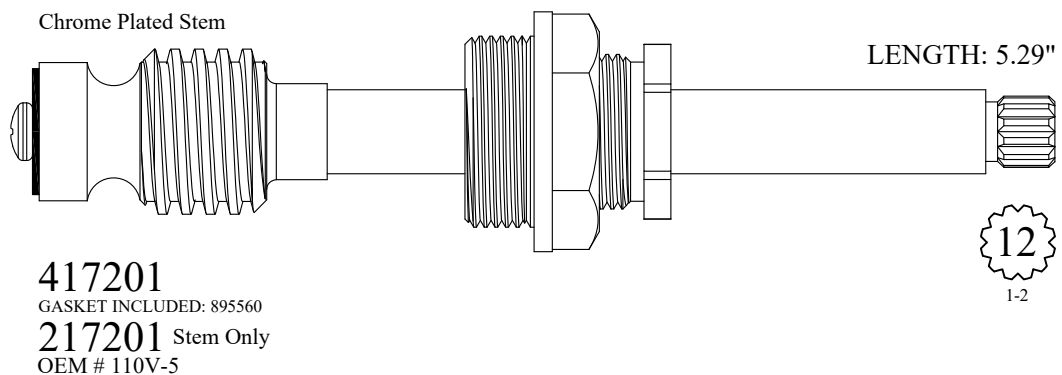
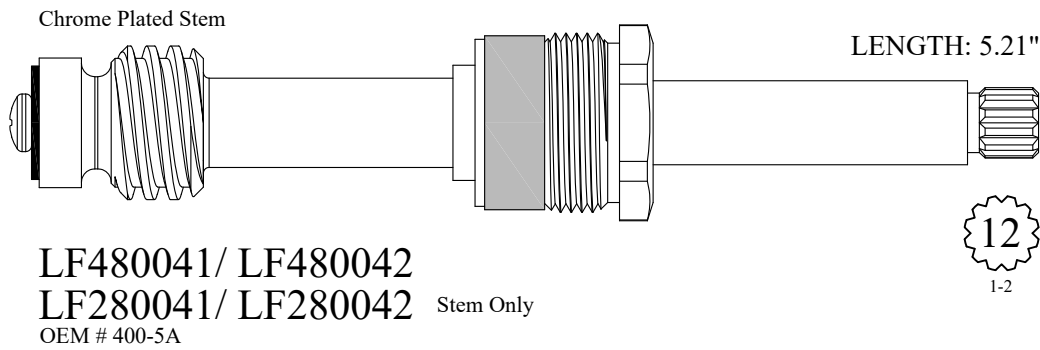
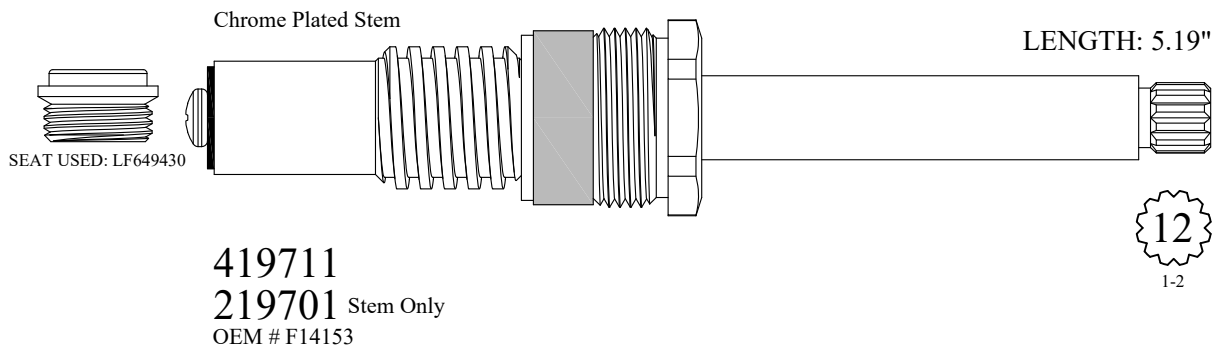
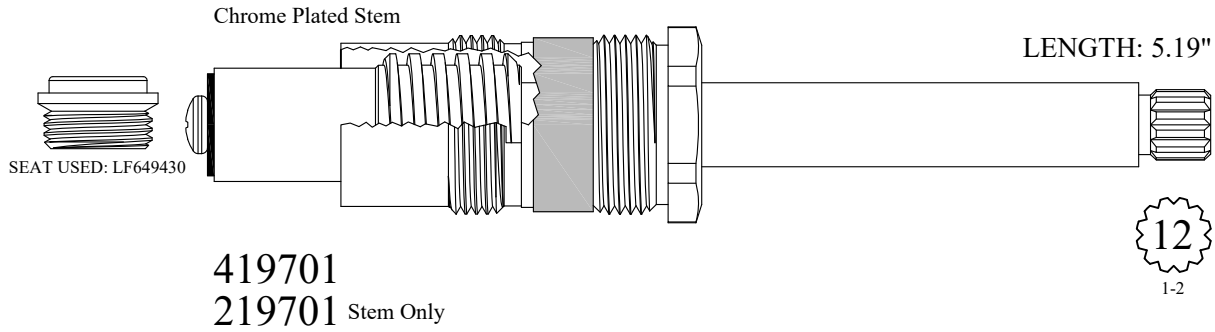

FOR CRANE

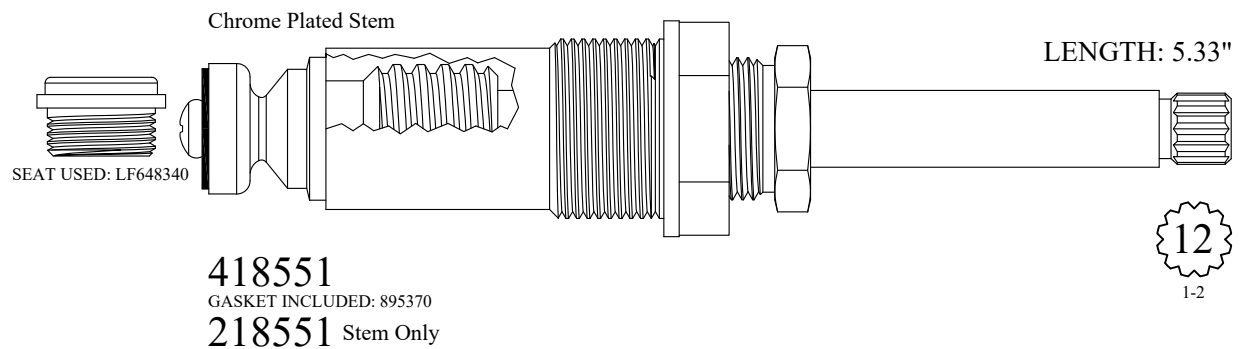
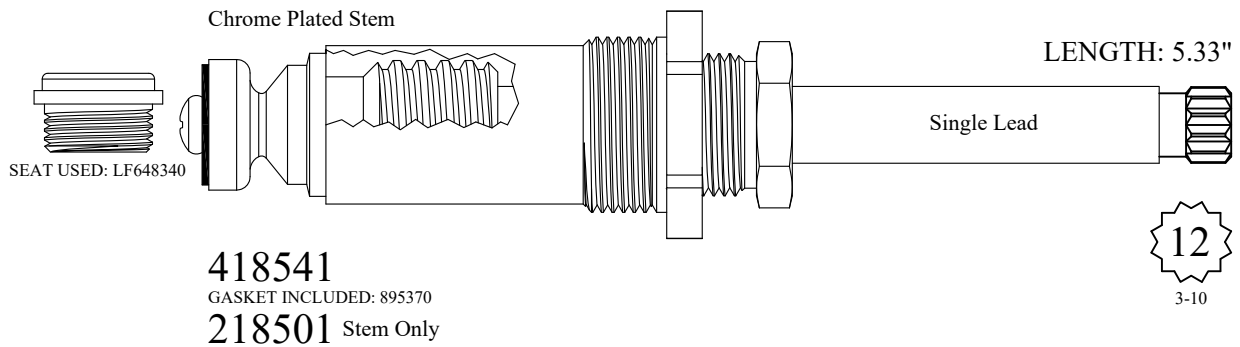
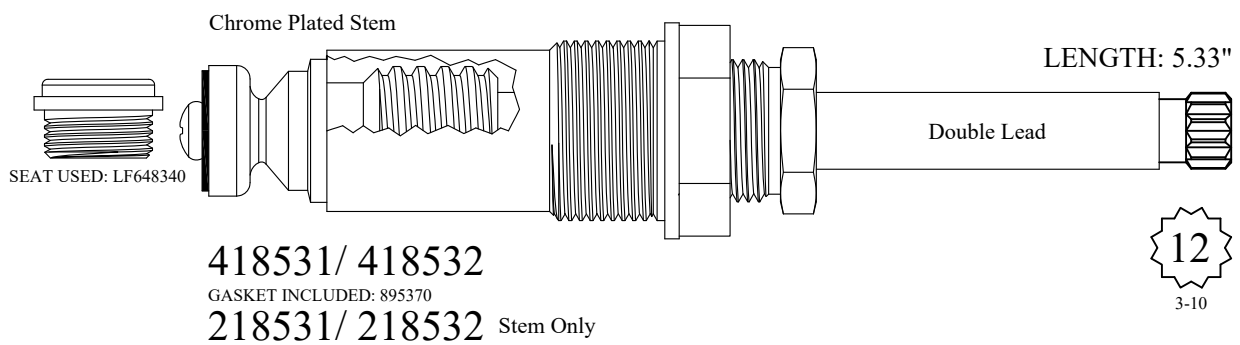
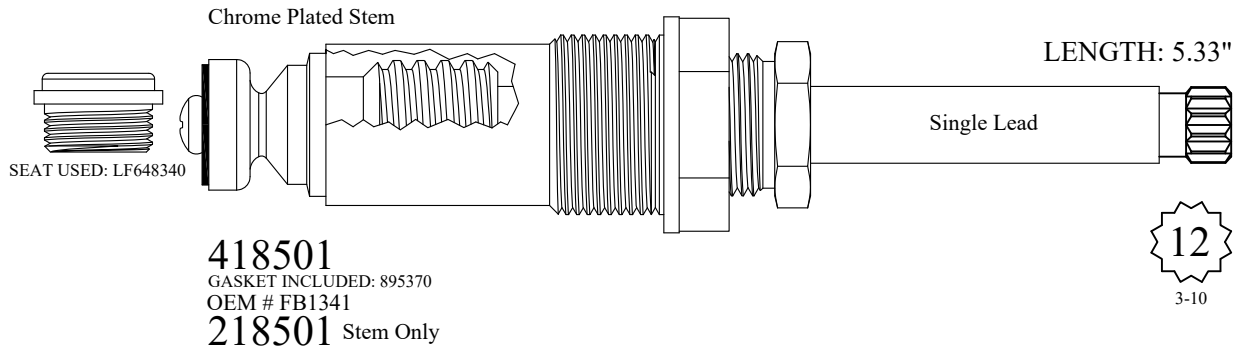

FOR CRANE

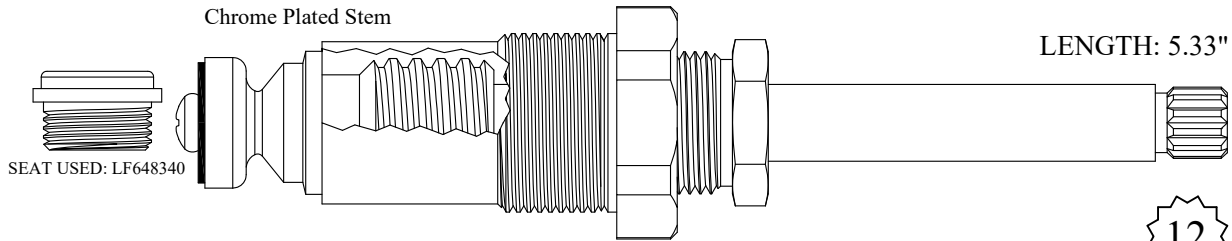

SEAT USED: LF648340

LENGTH: 5.33"

418621

GASKET INCLUDED: 895370

218501 Stem Only

12
3-10

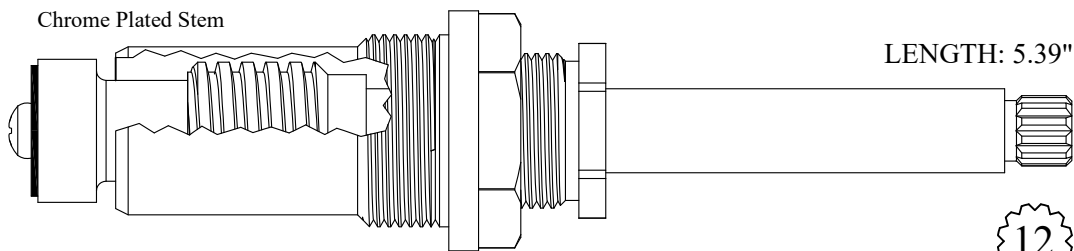

Chrome Plated Stem

LENGTH: 5.39"

417401

GASKET INCLUDED: 895430

217401 Stem Only

12
1-2

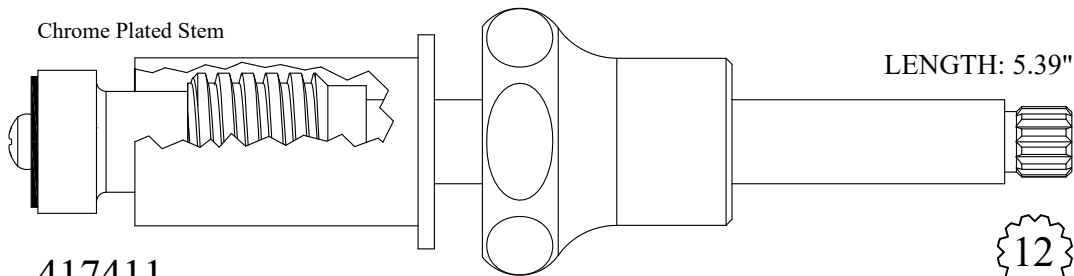

Chrome Plated Stem

LENGTH: 5.39"

417411

217401 Stem Only

12
1-2

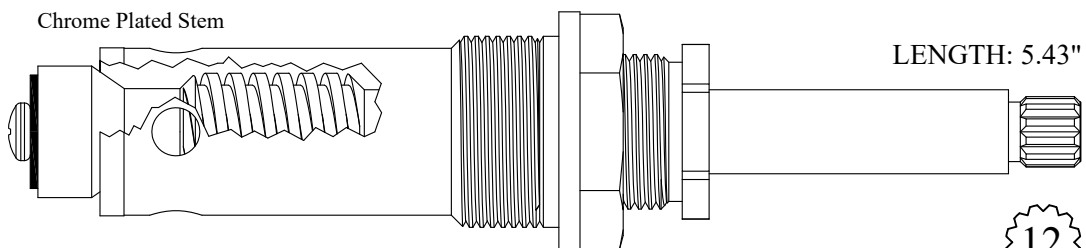

Chrome Plated Stem

LENGTH: 5.43"

433601

GASKET INCLUDED: 895550

OEM # FB9178

233601 Stem Only

OEM # F14151

SEAT USED: LF649430

12
1-2

FOR CRANE

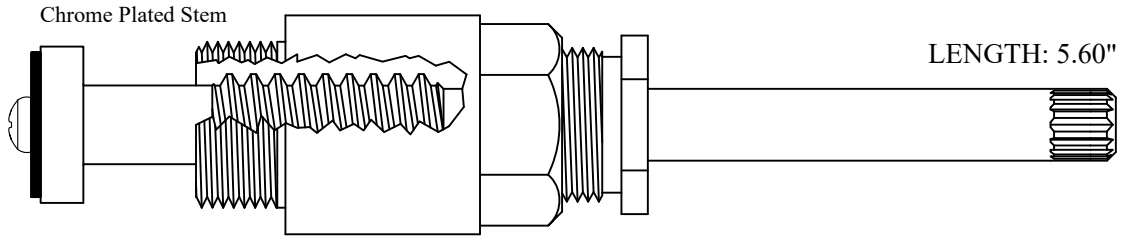

Not Available, Use 423151

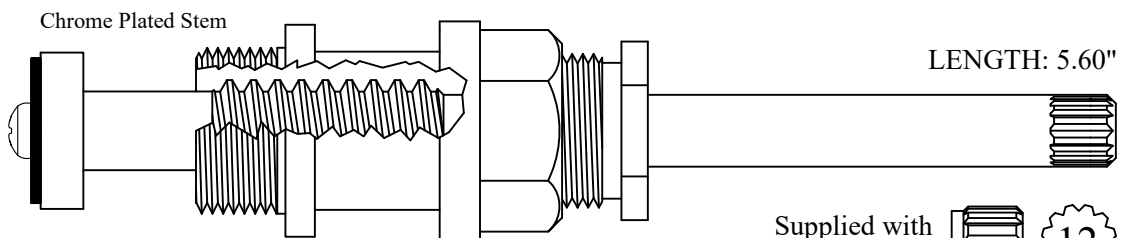

423151
GASKET INCLUDED: 895400
223151 Stem Only

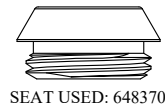

Supplied with
12pt. Broach

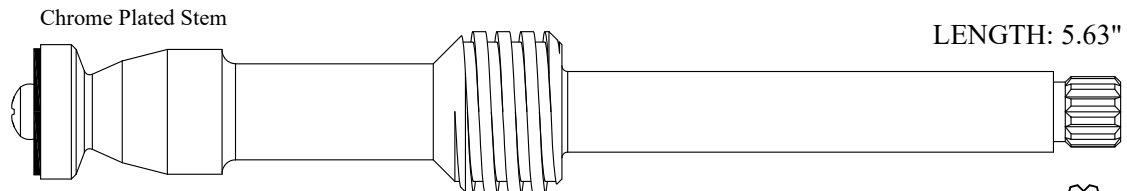
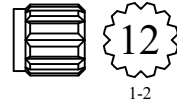

222651



BARRY E.  WALTER  SR. CO.

FOR CRANE

Chrome Plated Stem

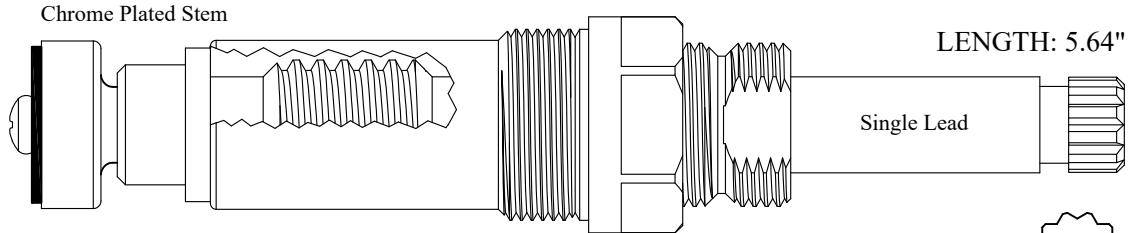

LENGTH: 5.64"

Single Lead

LF480101
GASKET INCLUDED: 895340
OEM # FB7673 RH
LF280101 Stem Only

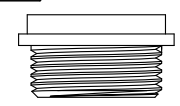

SEAT USED: LF649660

12

Chrome Plated Stem

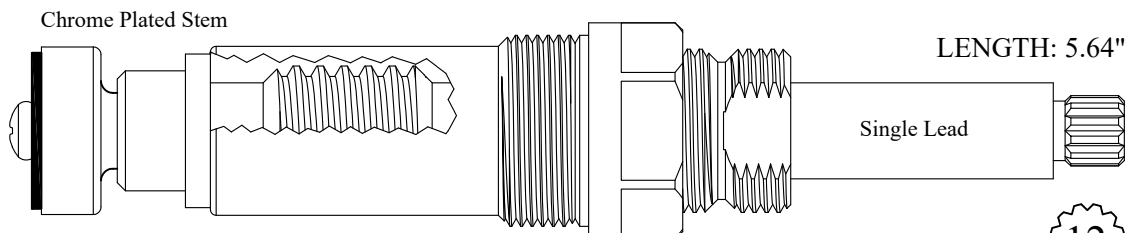

LENGTH: 5.64"

Single Lead

LF480111
GASKET INCLUDED: 895340
LF280111 Stem Only



SEAT USED: LF649660

12
1-2

Chrome Plated Stem

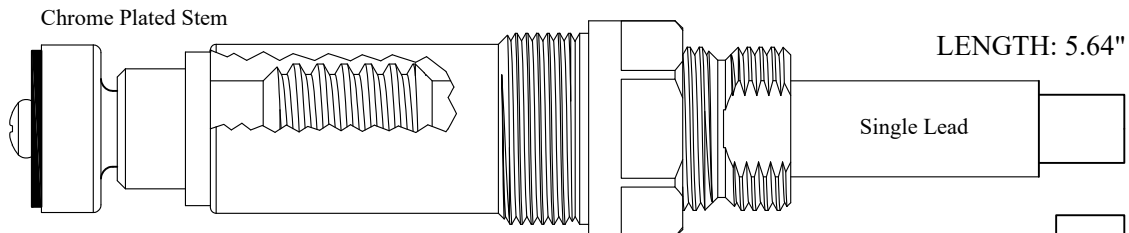

LENGTH: 5.64"

Single Lead

LF480121
GASKET INCLUDED: 895340
LF280121 Stem Only



SEAT USED: LF649660

23/64

Chrome Plated Stem

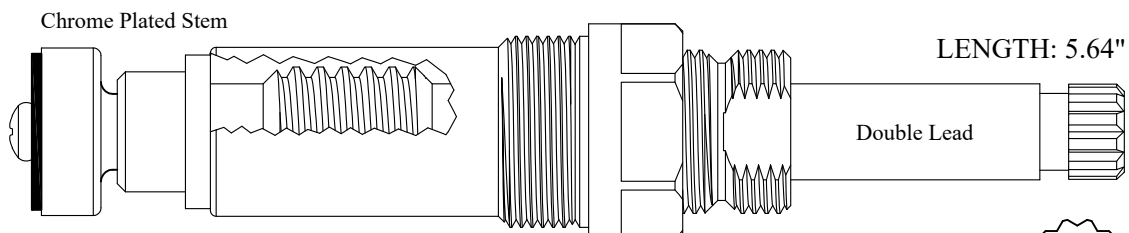

LENGTH: 5.64"

Double Lead

LF480131/ LF480132
GASKET INCLUDED: 895340
LF280131/ LF280132 Stem Only



SEAT USED: LF649660

12

FOR CRANE

Chrome Plated Stem

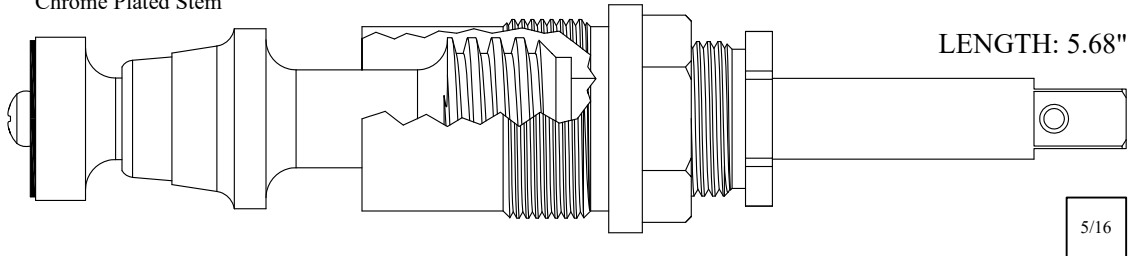

423901

GASKET INCLUDED: 895440

223901 Stem Only

Chrome Plated Stem

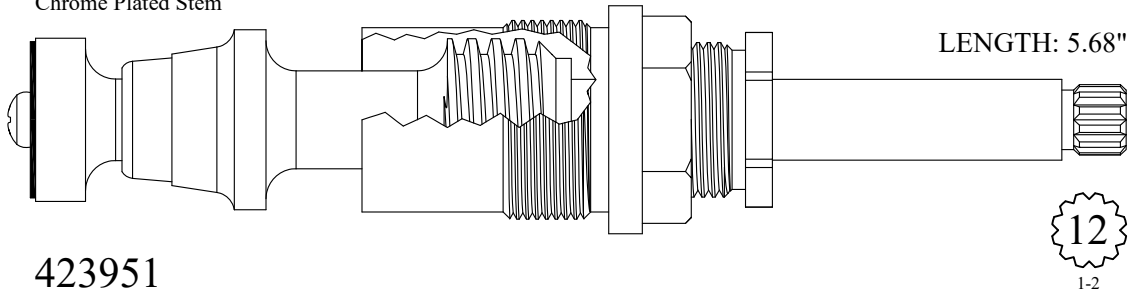

423951

GASKET INCLUDED: 895440

223951 Stem Only

Chrome Plated Stem

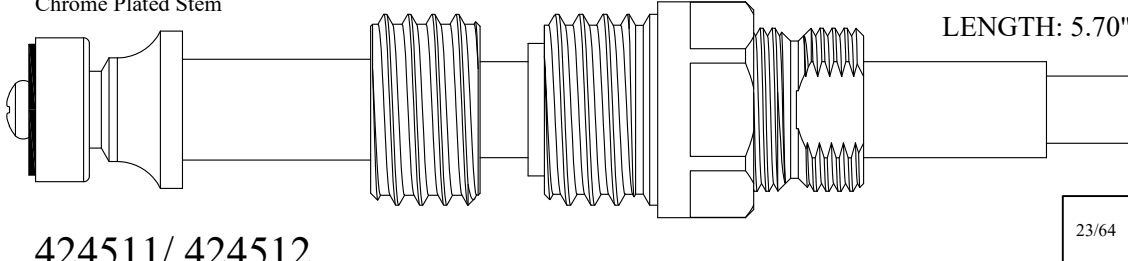

424511/ 424512

GASKET INCLUDED: 895340

224511/ 224512 Stem Only

Chrome Plated Stem

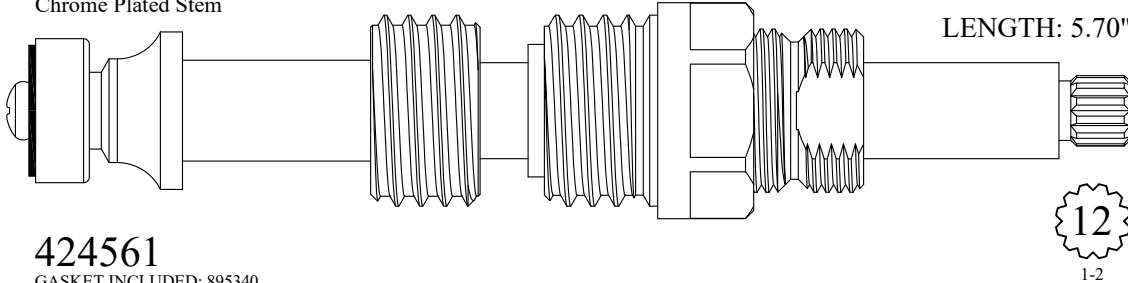

424561

GASKET INCLUDED: 895340

224561 Stem Only

FOR CRANE

Chrome Plated Stem

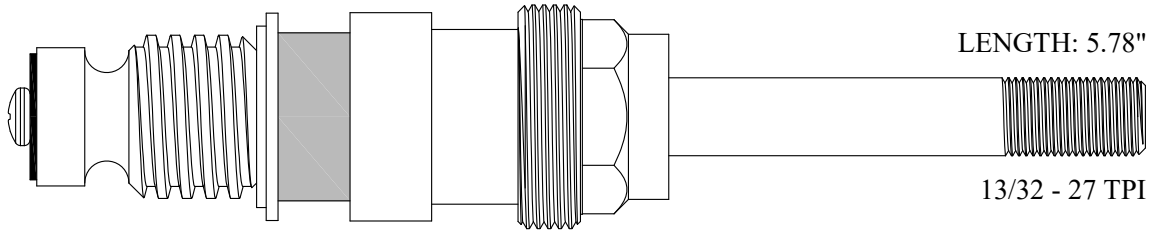

LENGTH: 5.78"

13/32 - 27 TPI

422301
222301 Stem Only

Chrome Plated Stem

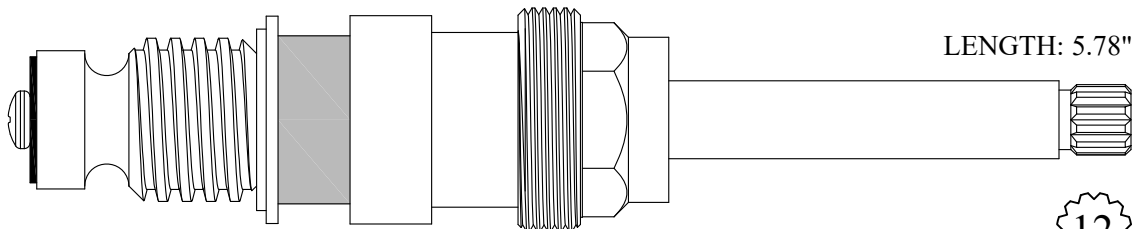

LENGTH: 5.78"

12
1-2

422351
222351 Stem Only

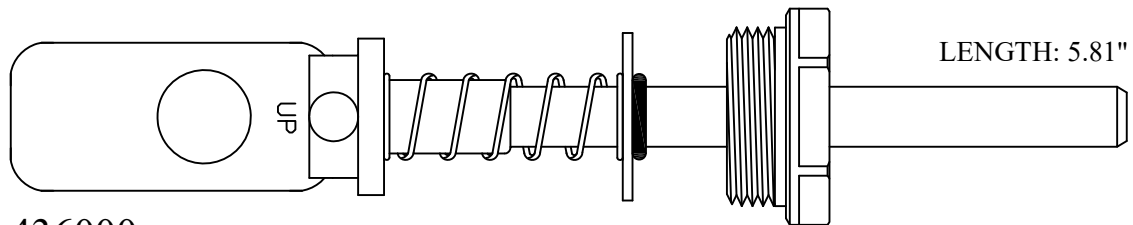

LENGTH: 5.81"

436000
GASKET INCLUDED: 895370
OEM # FB9199
236000 Stem Only

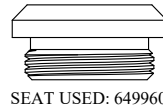

SEAT USED: 649960

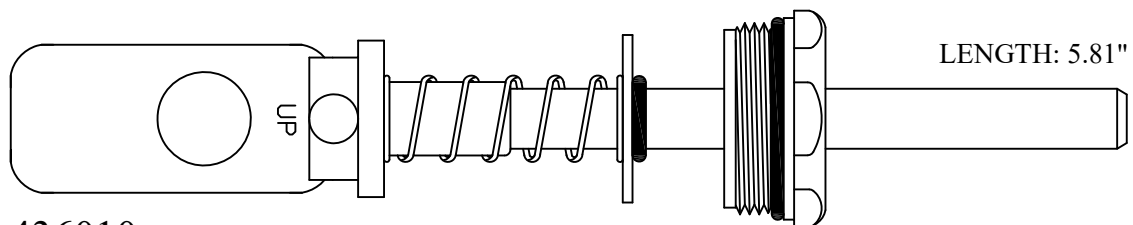

LENGTH: 5.81"

436010
GASKET: 890210 O-RING INCLUDED
236000 Stem Only

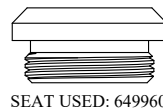

SEAT USED: 649960

FOR CRANE

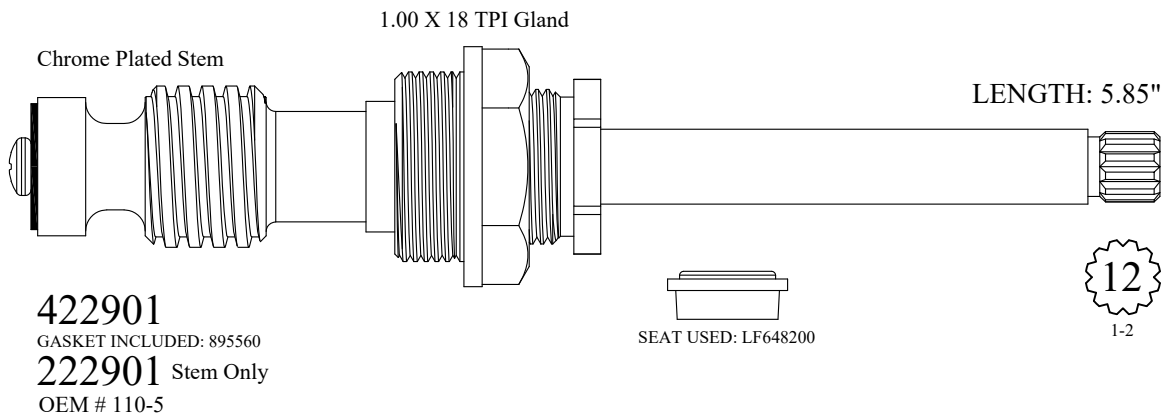
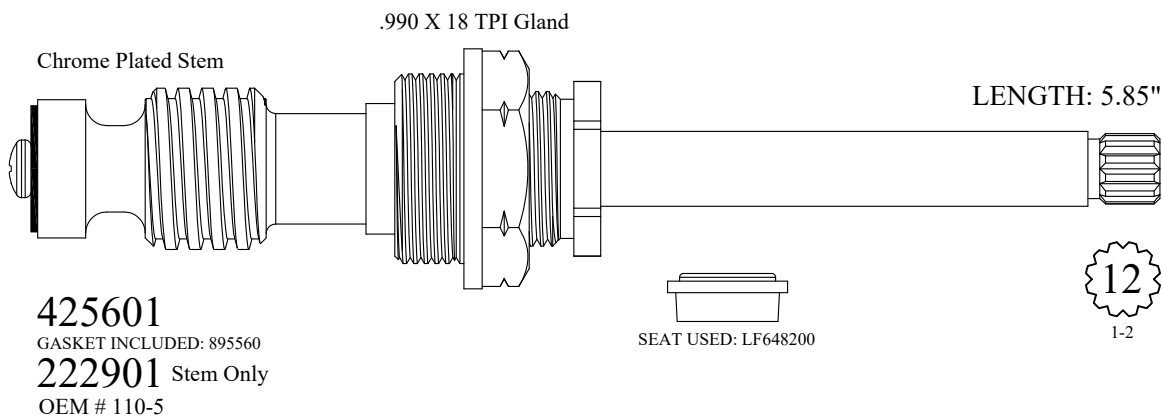
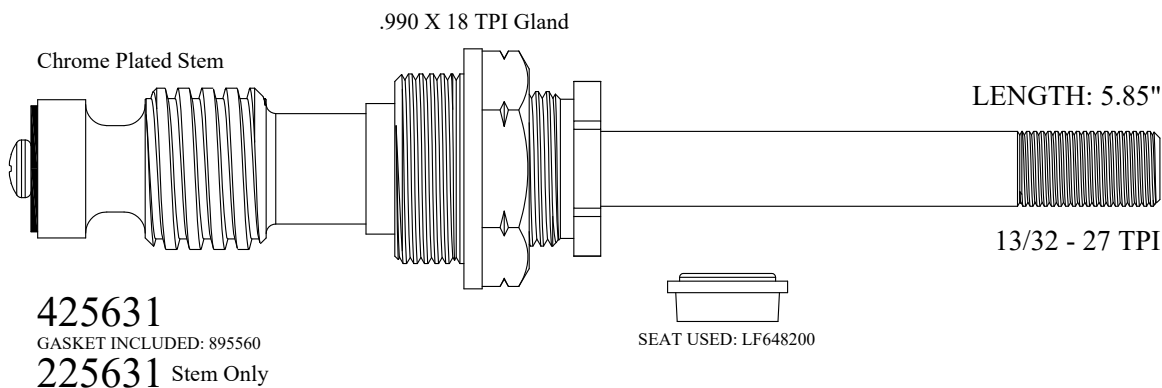
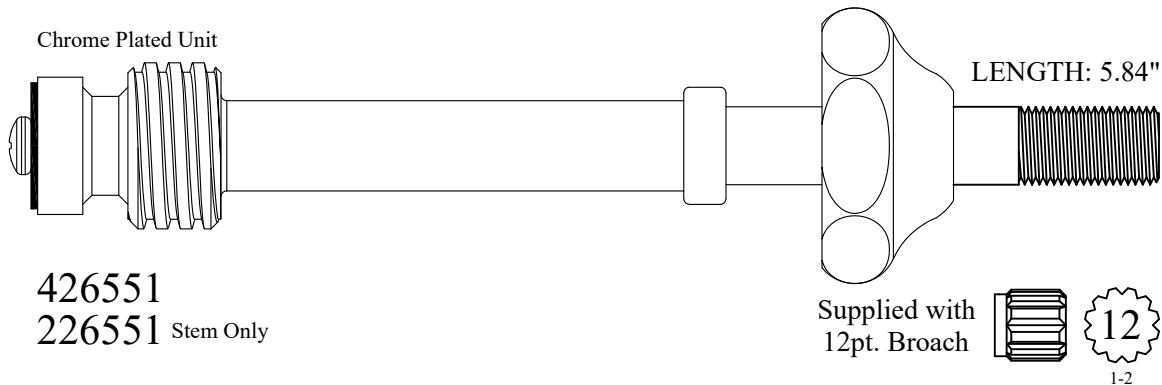

FOR CRANE

LENGTH: 5.95"

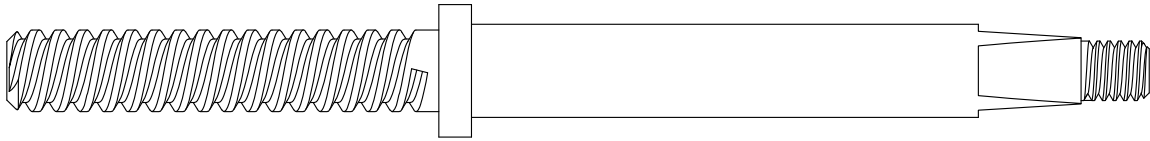

281522

Chrome Plated Stem

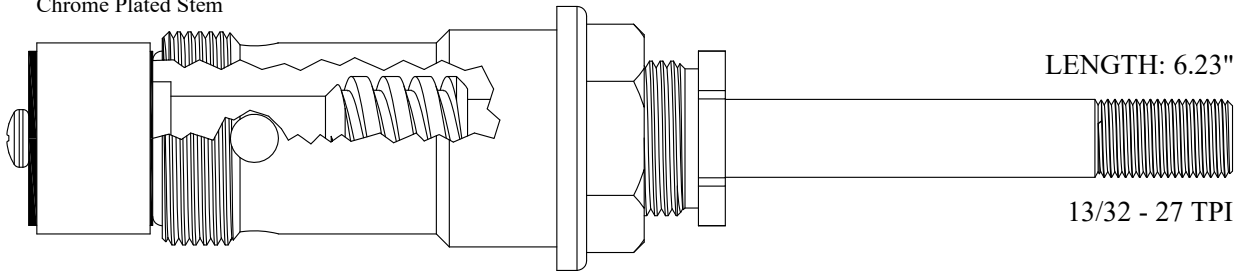

LENGTH: 6.23"

13/32 - 27 TPI

438601

GASKET INCLUDED: 895450

238601 Stem Only

Chrome Plated Stem

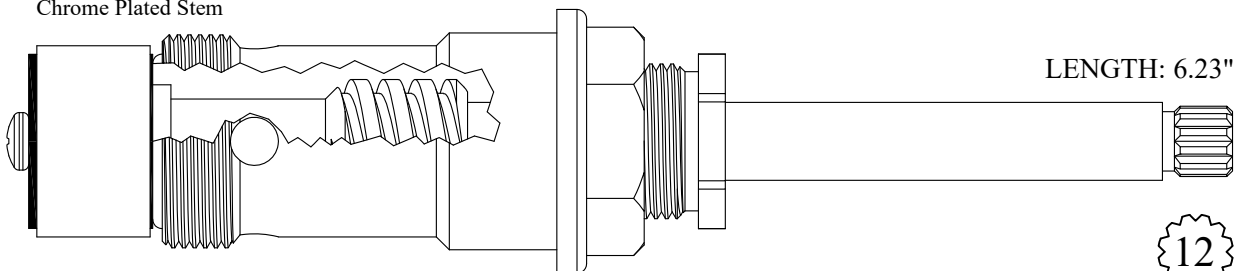

LENGTH: 6.23"



438651

GASKET INCLUDED: 895450

238651 Stem Only

Chrome Plated Stem

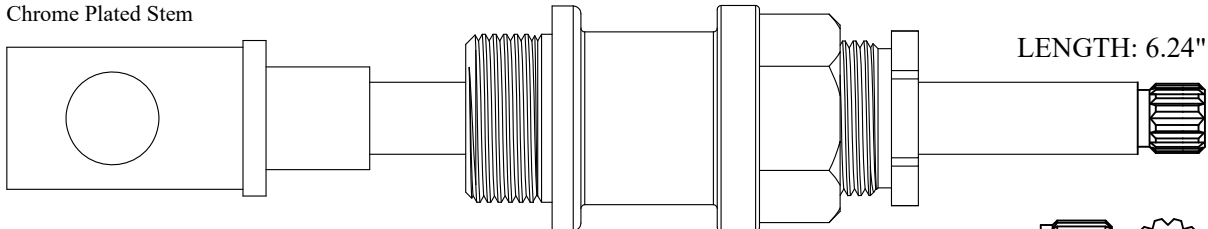

LENGTH: 6.24"

Supplied with
12pt. Broach



438550

GASKET INCLUDED: 895400

238550 Stem Only

1-2

FOR CRANE

Chrome Plated Stem

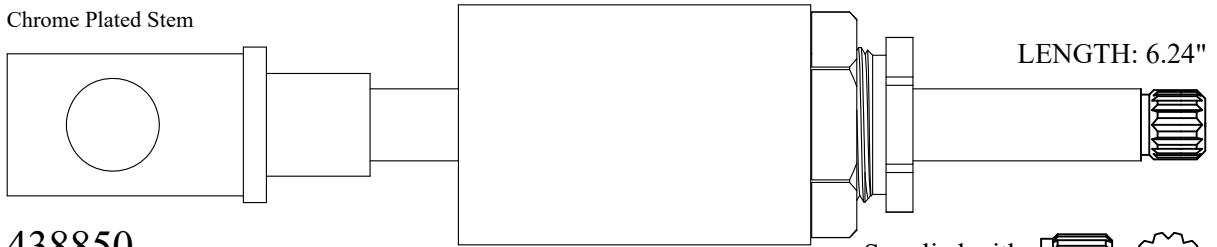

LENGTH: 6.24"

438850
238850 Stem Only

Supplied with
12pt. Broach



12
1-2

Chrome Plated Stem

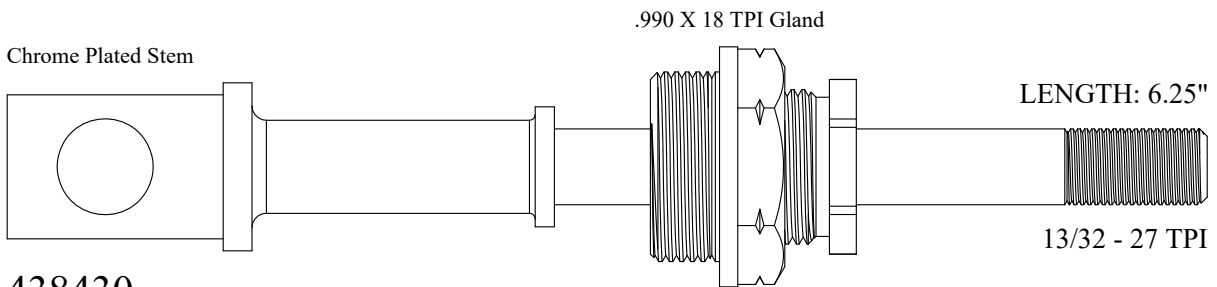

.990 X 18 TPI Gland

LENGTH: 6.25"

438430
GASKET INCLUDED: 895560
238430 Stem Only

13/32 - 27 TPI

Chrome Plated Stem

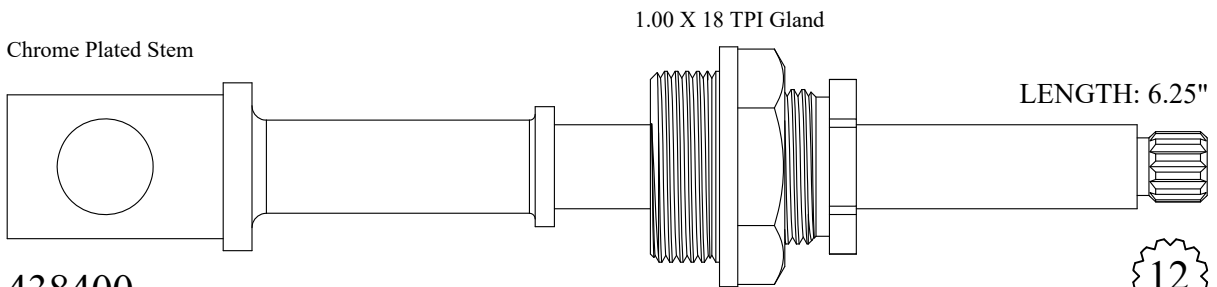

1.00 X 18 TPI Gland

LENGTH: 6.25"

438400
GASKET INCLUDED: 895560
238400 Stem Only

12
1-2

Chrome Plated Unit

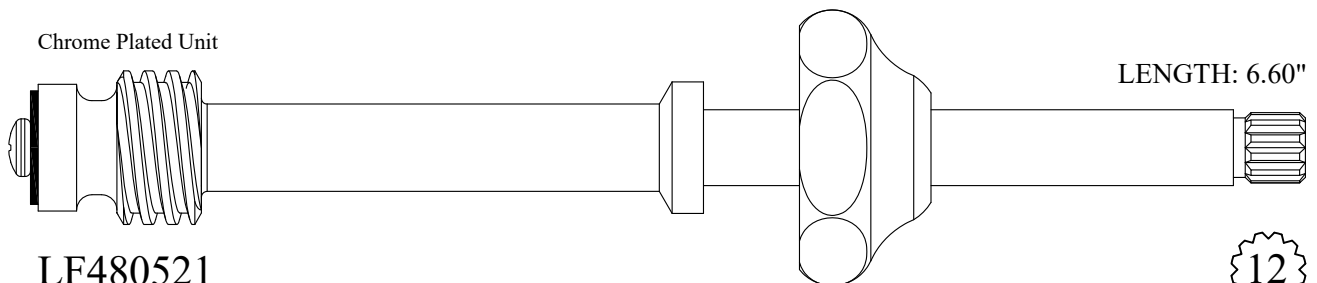

LENGTH: 6.60"

LF480521
LF280521 Stem Only
OEM # 400-5

12
1-2

FOR CRANE

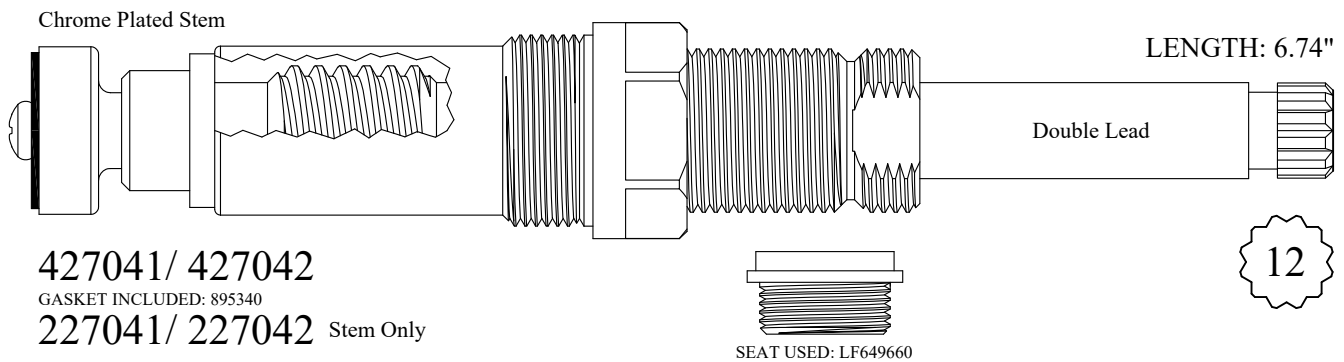
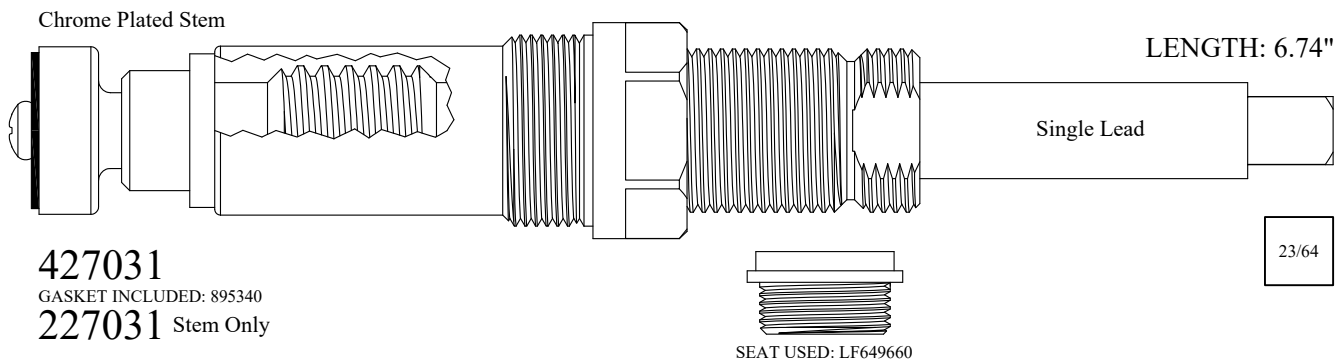
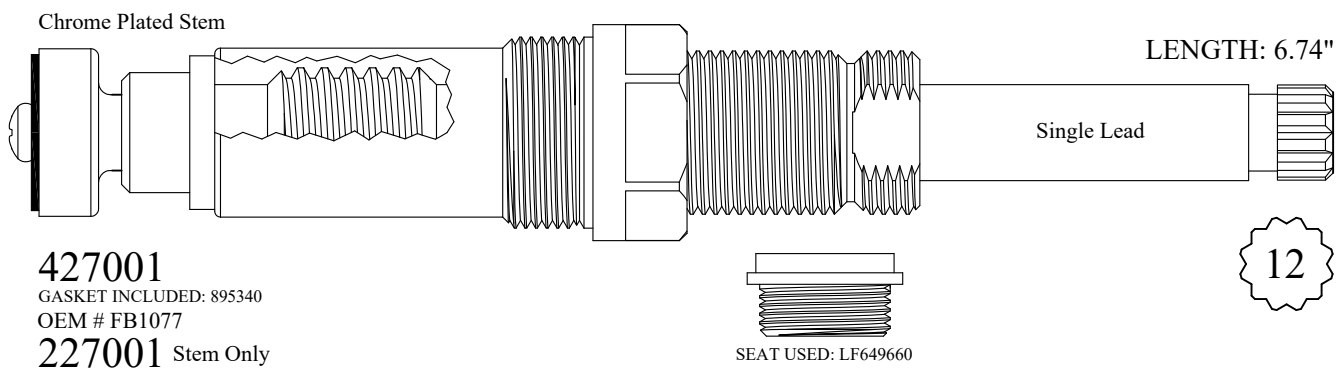
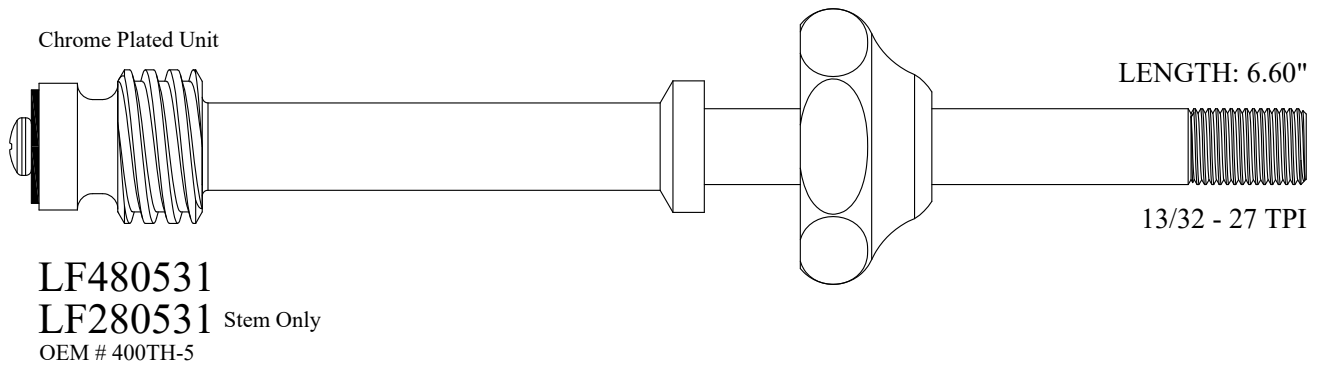

FOR CRANE

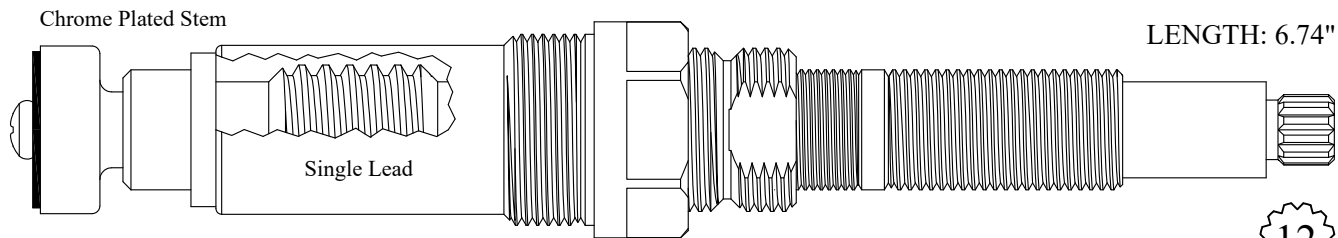

427051

GASKET INCLUDED: 895340

227051 Stem Only

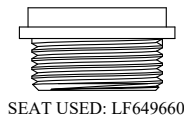

12

1-2

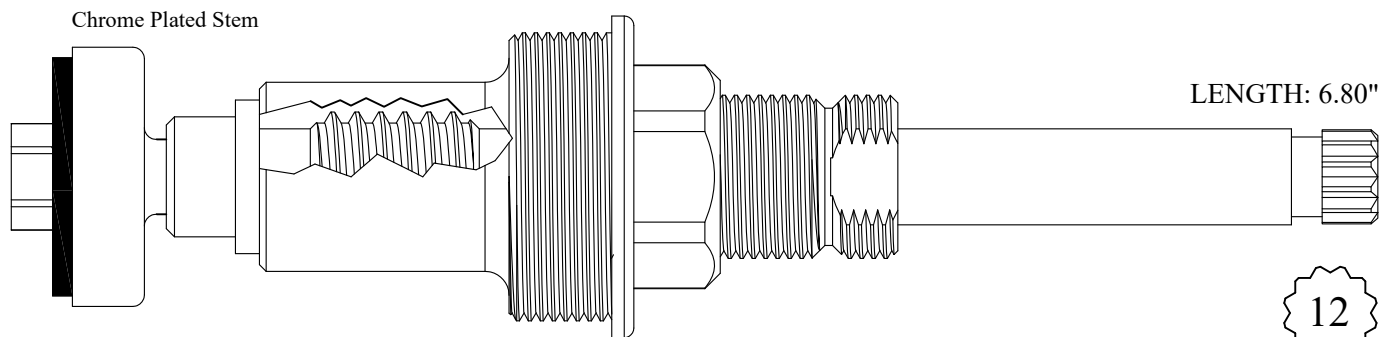

427181

227181 Stem Only

12

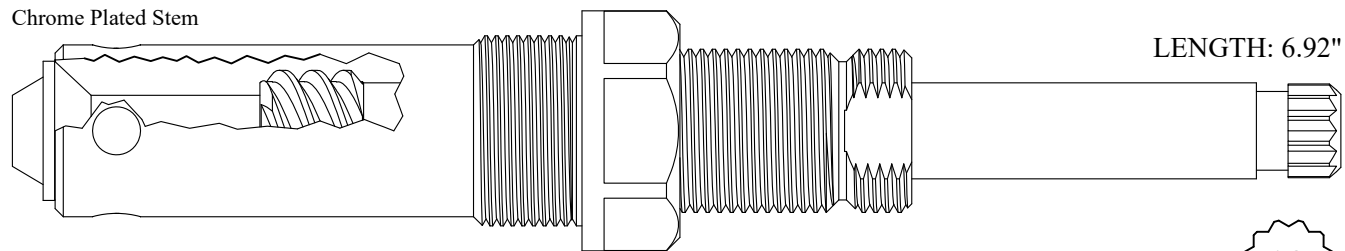

439661

GASKET INCLUDED: 895550

239661 Stem Only

12

BARRY E.  SR. CO.

FOR CRANE

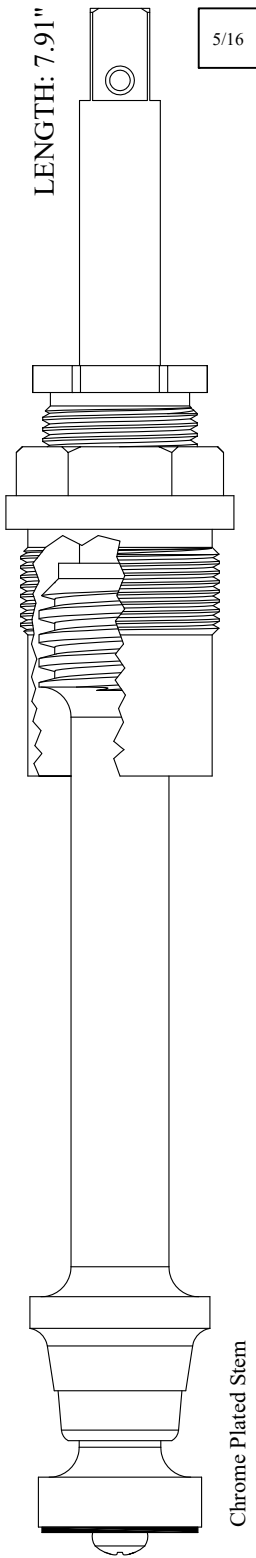

GASKET INCLUDED: 895560

428001
228001 Stem Only

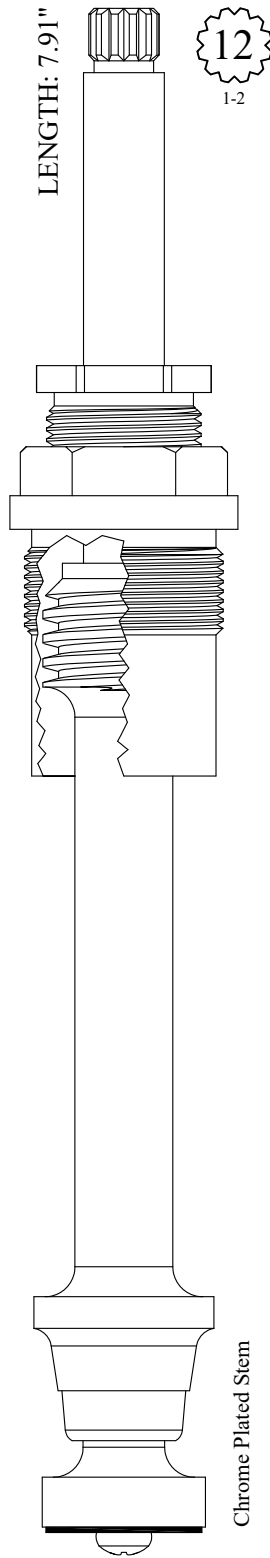

GASKET INCLUDED: 895560

428051
228051 Stem Only

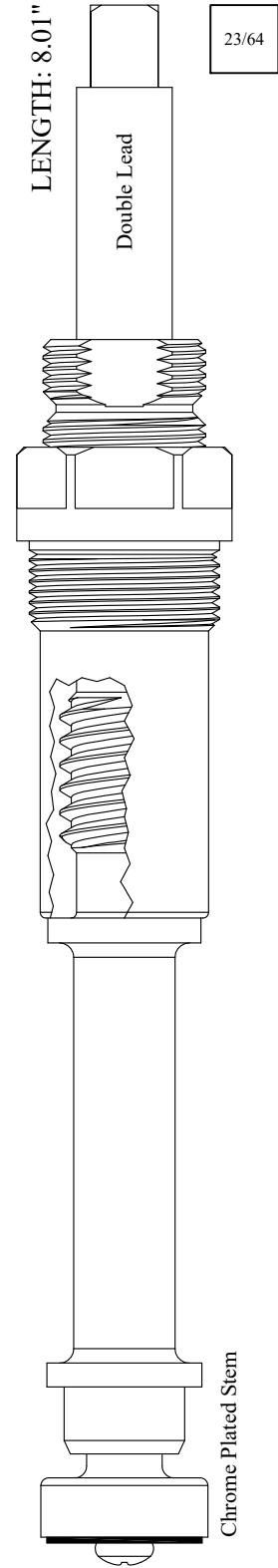

GASKET INCLUDED: 895550

LF480911
LF480912
LF280911 Stem Only
LF280912 Stem Only

FOR CRANE

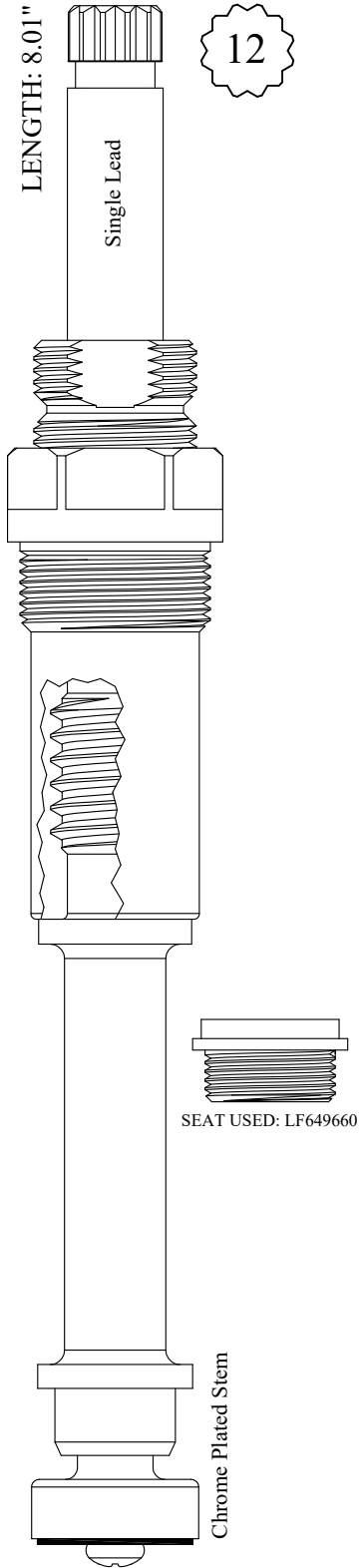

GASKET INCLUDED: 895340

LF480991
LF280991 Stem Only

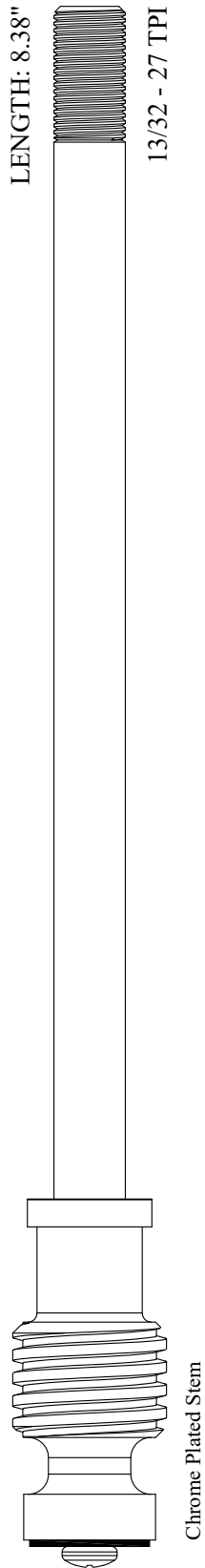

227101



GASKET INCLUDED: 895550

LF481301

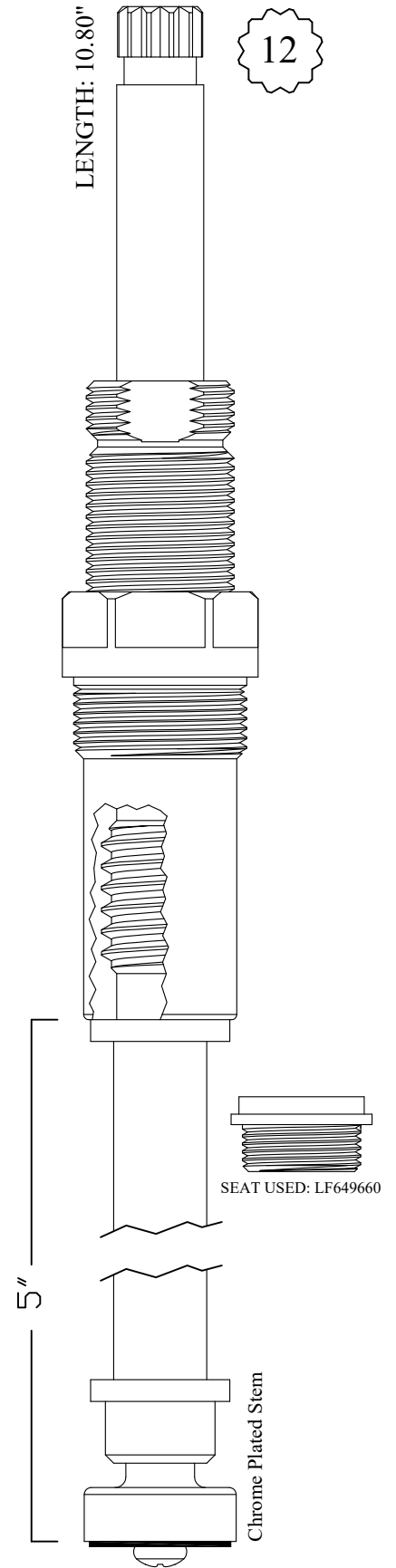

GASKET INCLUDED: 895340

428501
228501 Stem Only
OEM # 228501

FOR CUTHBERT

LENGTH: 1.80"

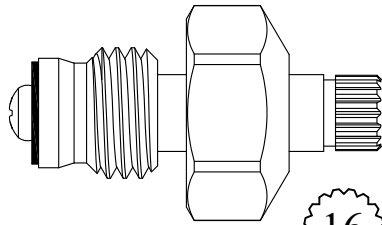

16
1-5

LF456971

LF256971 Stem Only

FOR DANFOSS

Old Style - Automatic

LENGTH: 3.59"

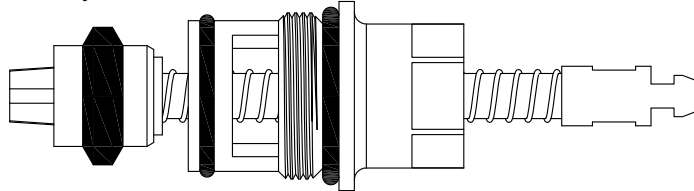

430790

GASKET: 894120 O-RING INCLUDED

New Style - Manual

LENGTH: 3.76"

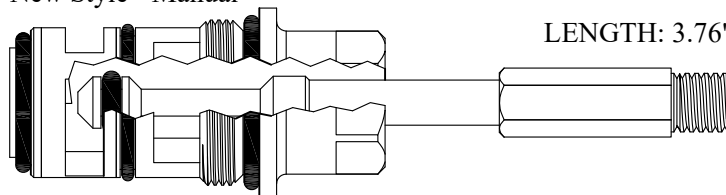

430850

GASKET: 894120 O-RING INCLUDED

Old Style - Automatic with Brass Link

LENGTH: 4.09"

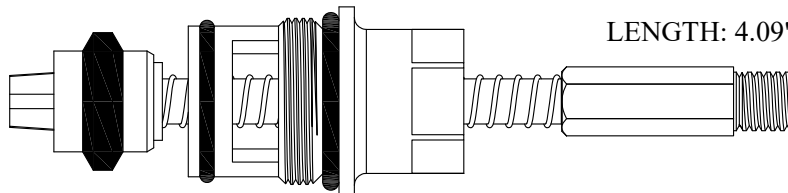

431130

GASKET: 894120 O-RING INCLUDED

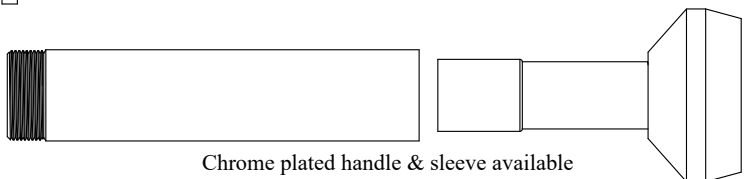

Chrome plated handle & sleeve available

128540

FOR DANZE



GASKET: 890150 O-RING INCLUDED

400881
OEM # THU4125



431760
OEM # A607238



GASKET: 890160 O-RING INCLUDED

402031
OEM # DA603923

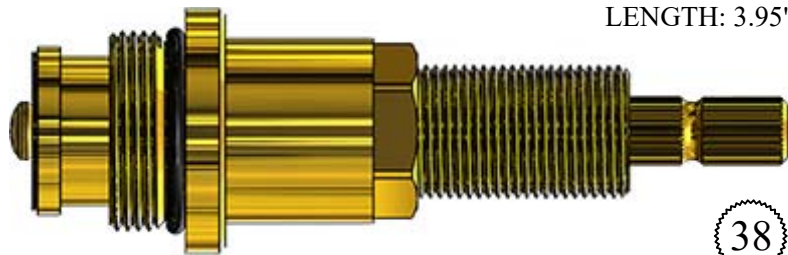

LENGTH: 3.95"

38
3-21

403672
GASKET: 891180 O-RING INCLUDED
OEM # DA507875



FOR DELTA

LENGTH: 1.14"

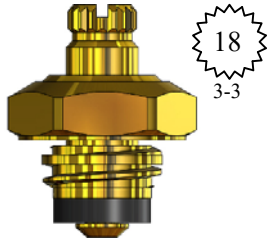

400671
OEM # RP16213

LENGTH: 1.20"

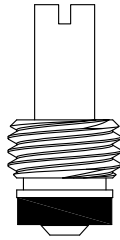

200141

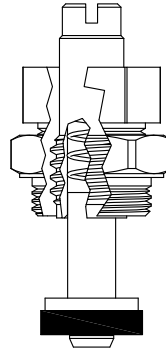

GASKET INCLUDED: 895060

400151
OEM # RP2090

LENGTH: 1.79"



DE10427

LENGTH: 1.87"



DE10422

LENGTH: 1.91"



DE10428
DE10428-2 Stem Pair

ALSO AVAILABLE:
DE10428-KIT
Includes 1 Cartridge
1 Each Seat & Spring



ALSO AVAILABLE:
DE10428-2KIT
Includes 2 Cartridges
2 Each Seats & Springs



LENGTH: 1.91"



DE10423

LENGTH: 1.91"



DE10421

ALSO AVAILABLE:
DE10421-KIT
Includes 1 Cartridge
1 Each Seat & Spring



LENGTH: 1.91"



DE10424

FOR DELTA

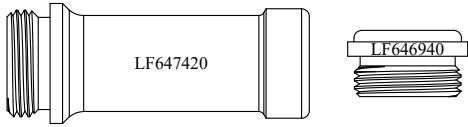

SEAT USED: LF647420 or LF646940

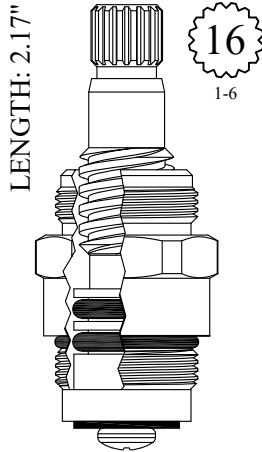

GASKET INCLUDED: 890160

LF460291
OEM # 060060A
LF460292
OEM # 060061A



NON-METERING
LF154110



DE10429



DE10493
OEM # RP19653



DE10425



DE10420

FOR DELTA

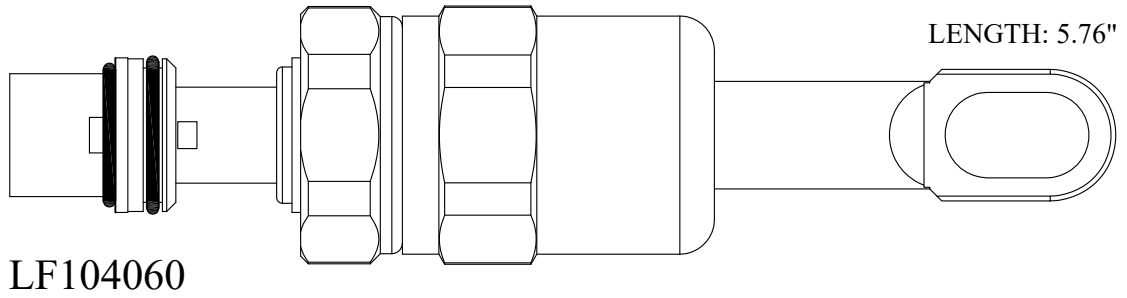

FOR DICK BROTHERS

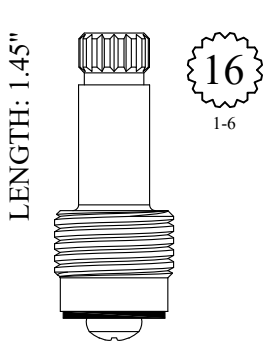

LF253011
LF253012

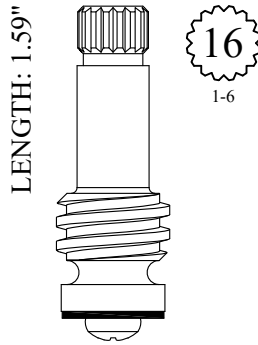
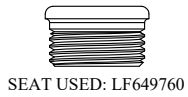

LF253161
LF253162

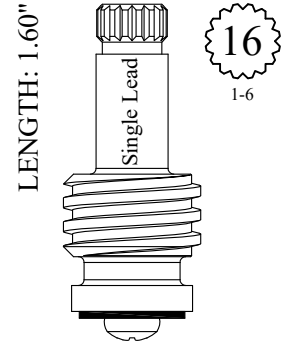
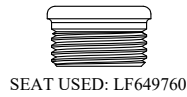

LF252251

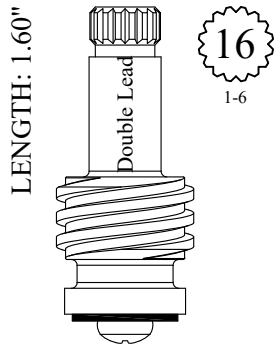

LF253151
LF253152

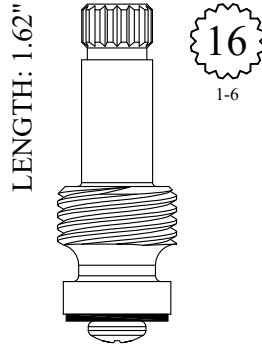

LF252151
LF252152

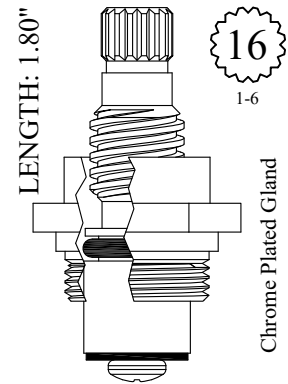
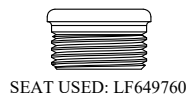

GASKET: 895100

LF457071
LF457072

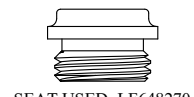

FOR DICK BROTHERS

LENGTH: 1.84"

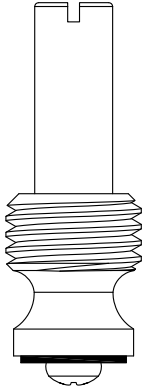

LF257001

LENGTH: 1.85"

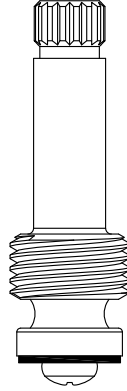

16
1-6

Chrome Plated Stem

LF257061
LF257062



SEAT USED: LF649760

LENGTH: 1.91"



5/16

Chrome Plated Stem

258211

LENGTH: 1.97"

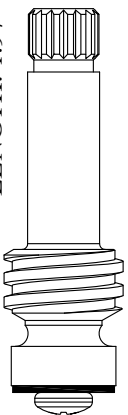

16
1-6

Chrome Plated Stem

LF257271
LF257272

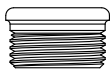

SEAT USED: LF649760

LENGTH: 1.98"

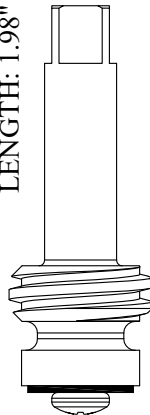

5/16

LF256711

LENGTH: 2.00"

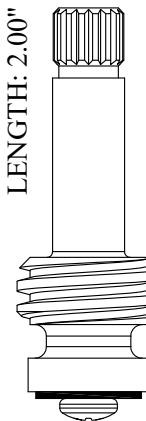

16
1-6

Chrome Plated Stem

LF256701
LF256702

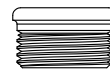

SEAT USED: LF649760

FOR DICK BROTHERS

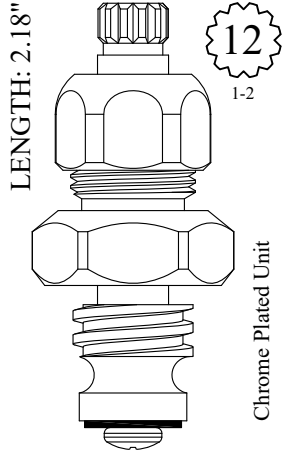

LF459901
LF259901 Stem Only

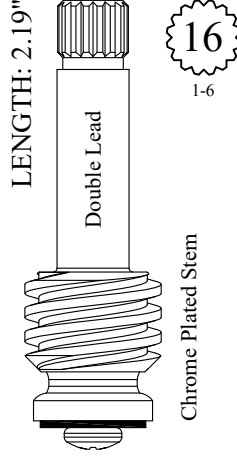

LF258111
LF258112

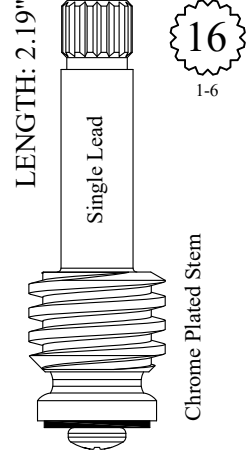

LF261061
LF261062

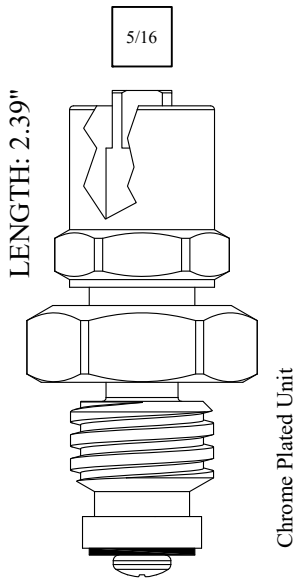

LF463091
LF263091 Stem Only

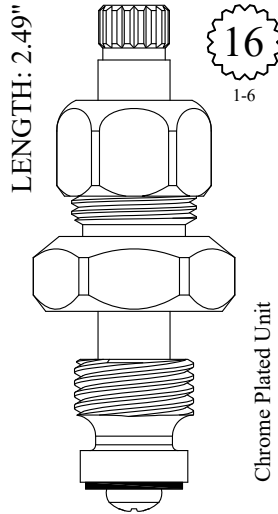

LF463841
LF463842
LF263841 Stem Only
LF263842 Stem Only

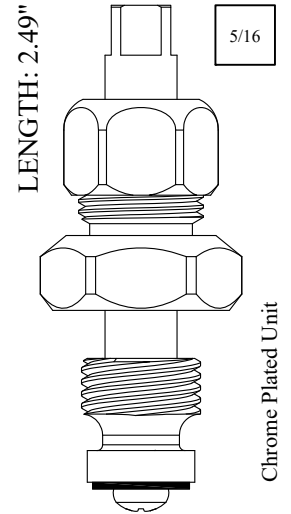

LF463851
LF263851 Stem Only

FOR DICK BROTHERS

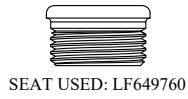

Chrome Plated Stem

LENGTH: 3.56"

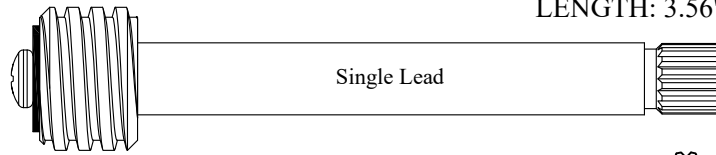

LF268211/ LF268212

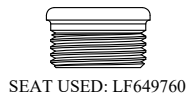

Chrome Plated Stem

LENGTH: 3.56"

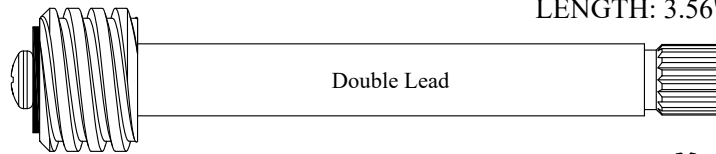

LF269031/ LF269032

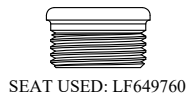

Chrome Plated Stem

LENGTH: 3.57"

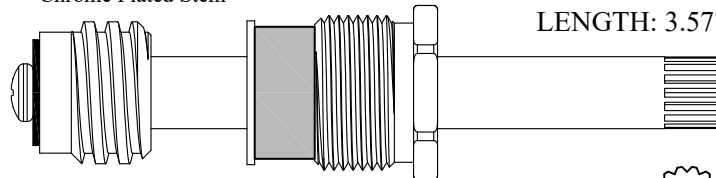

403011/ 403012
203011/ 203012 Stem Only

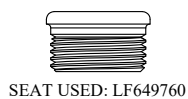

Chrome Plated Stem

LENGTH: 3.58"

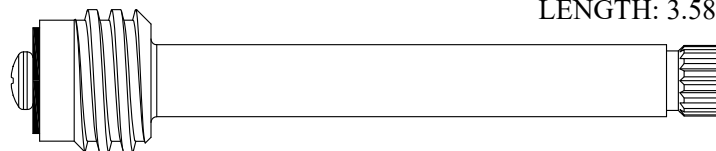

LF269091/ LF269092



FOR DICK BROTHERS

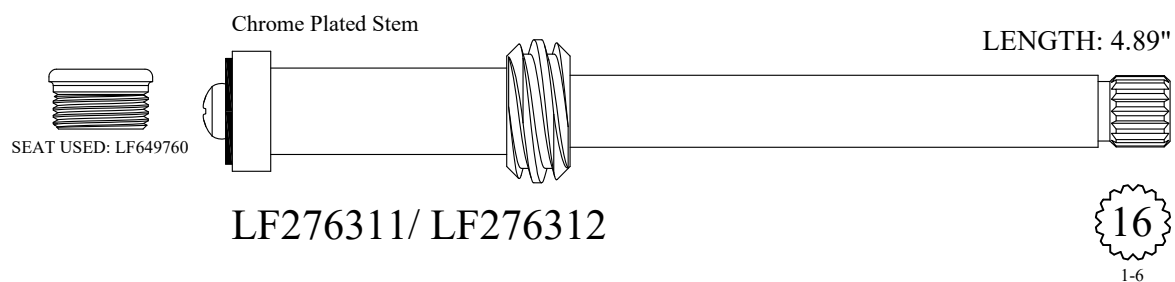
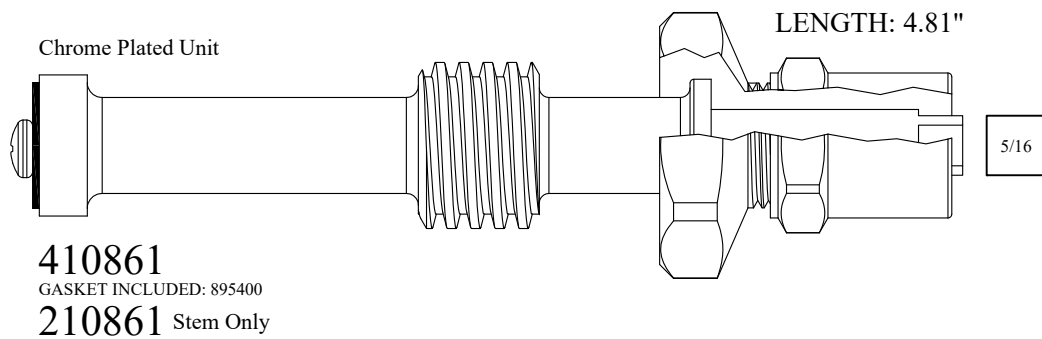
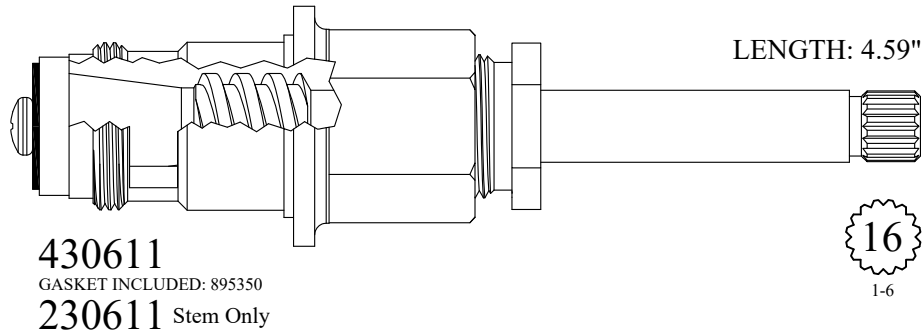
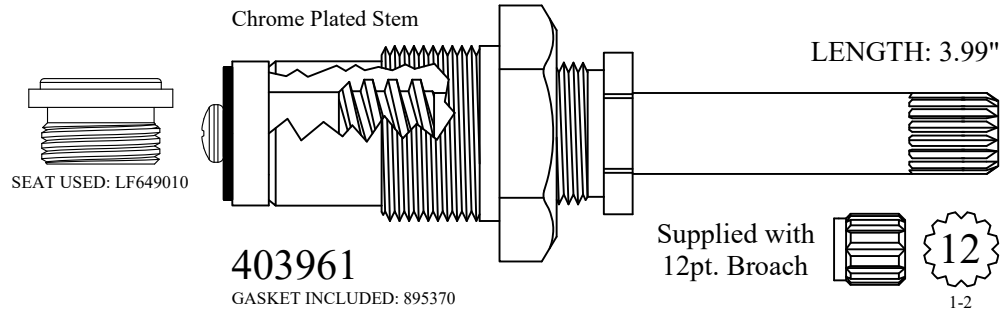

FOR DICK BROTHERS

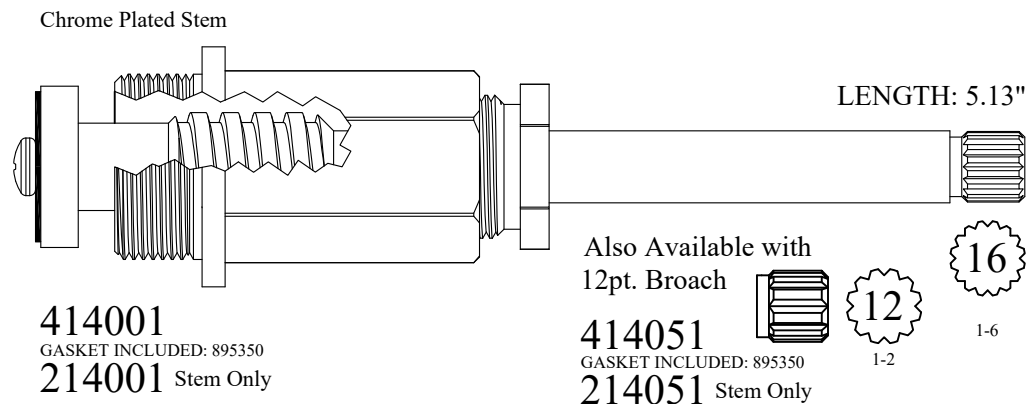
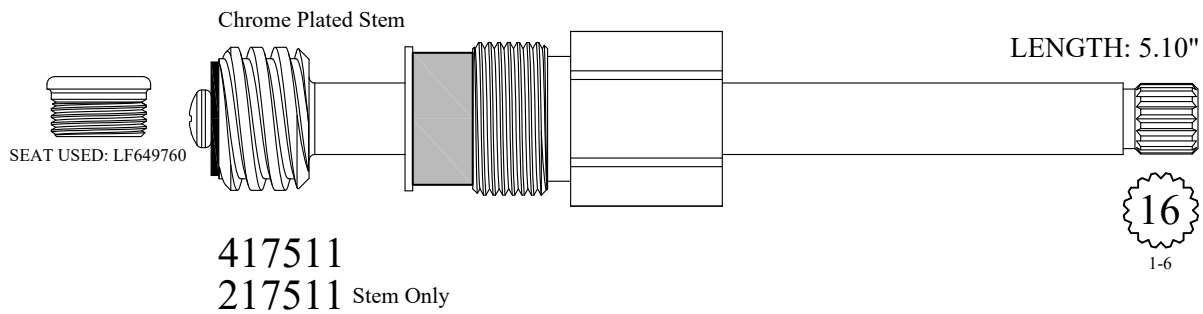
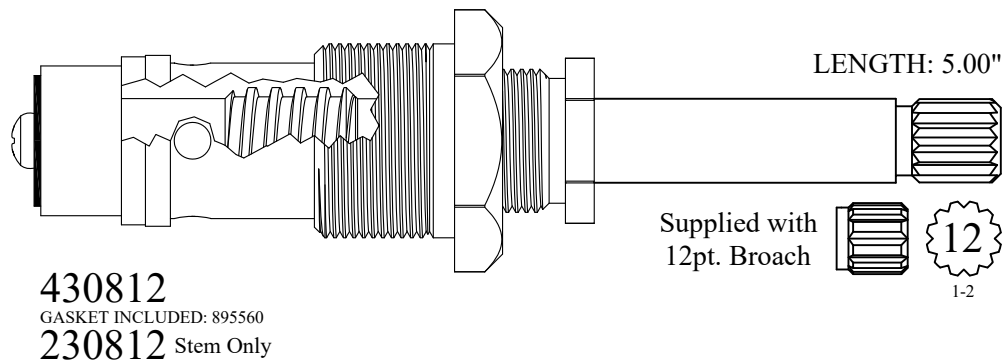
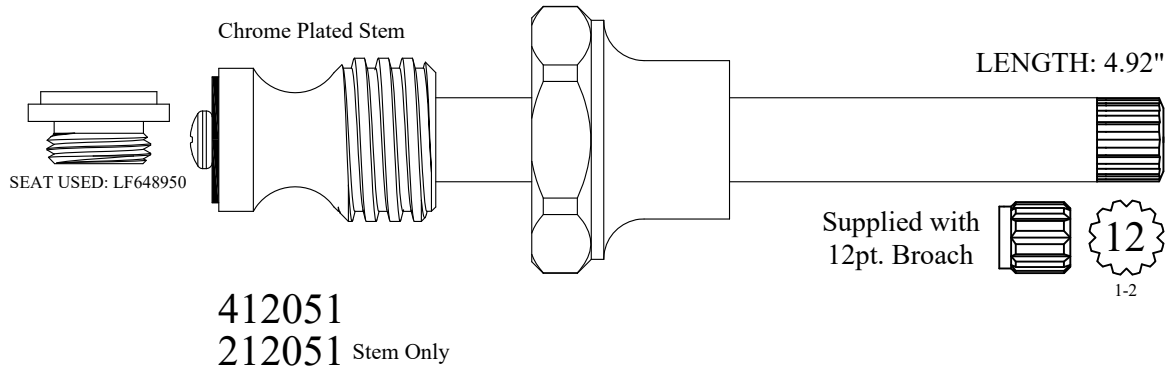

FOR DICK BROTHERS

SEAT USED: LF649010

Chrome Plated Stem

LENGTH: 5.19"

Supplied with
12pt. Broach

12
1-2

416951/ 416952
GASKET INCLUDED: 895370

SEAT USED: LF649760

Chrome Plated Unit

LENGTH: 5.31"

5/16

480311
GASKET INCLUDED: 895400
280311 Stem Only

Not Available, Use 418521

TAPERED

SEAT USED: 648980

Chrome Plated Unit

LENGTH: 5.35"

5/16

418521
GASKET INCLUDED: 895400
218521 Stem Only

SEAT USED: LF649760

Chrome Plated Stem

LENGTH: 5.41"

220411

16
1-6

FOR DICK BROTHERS

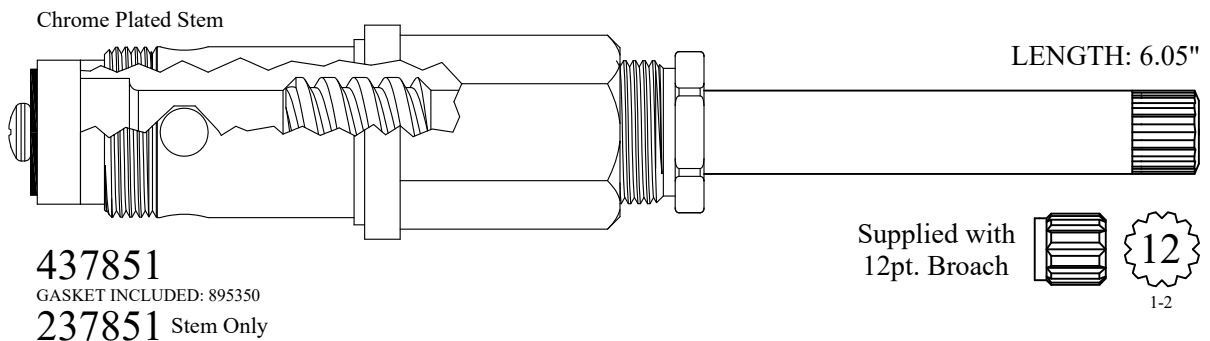
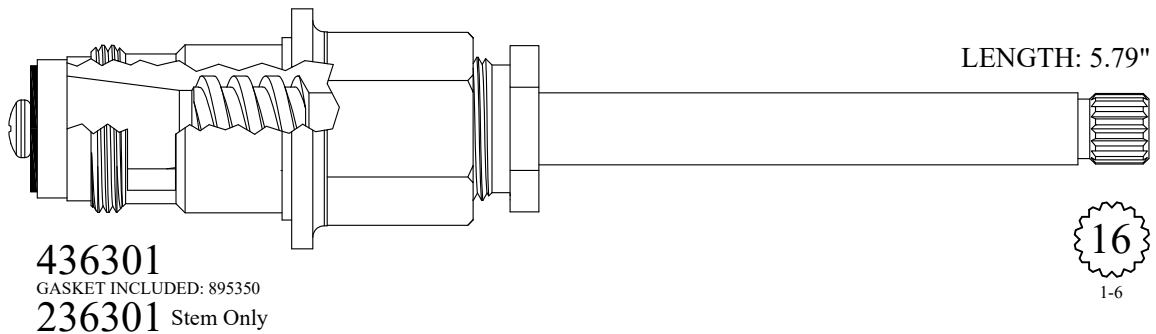
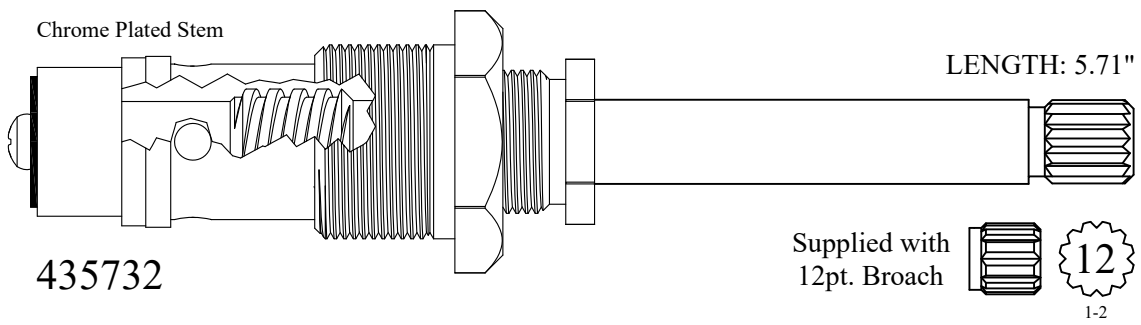
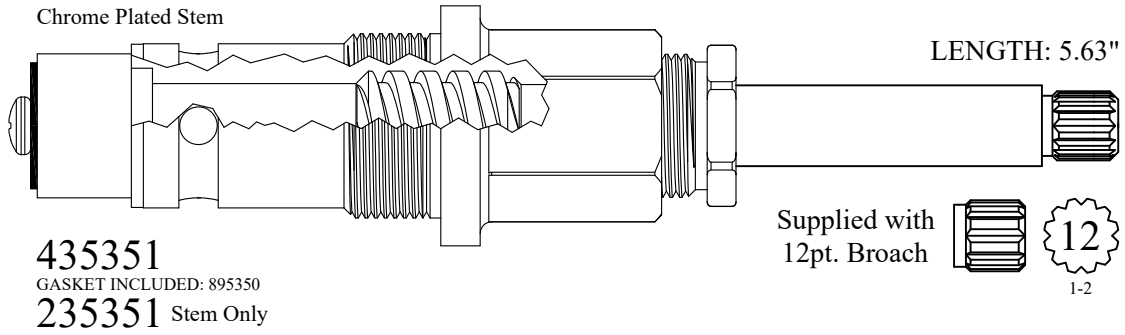

FOR DISHMASTER

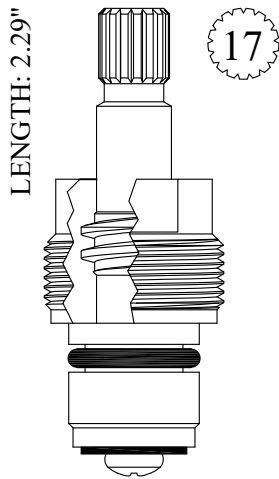

LF463051
LF463052



SEAT USED: LF649450

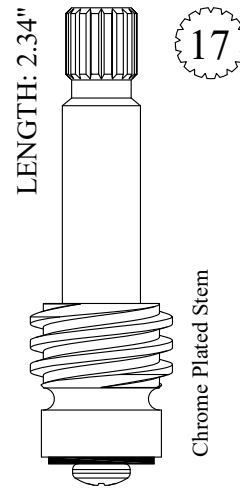

LF263191
LF263192

FOR DISNEY CRUISE

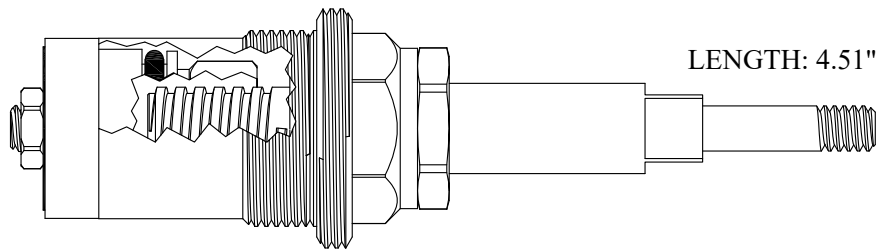

405722

GASKET INCLUDED: 895560

FOR DOLLY TRIM

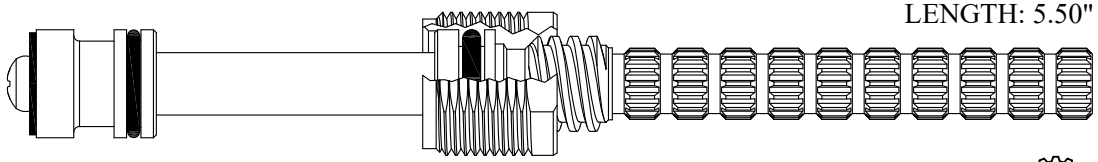

LENGTH: 5.50"

421511/ 421512

GASKET INCLUDED: 895400

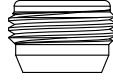

SEAT USED: LF648670



3-16

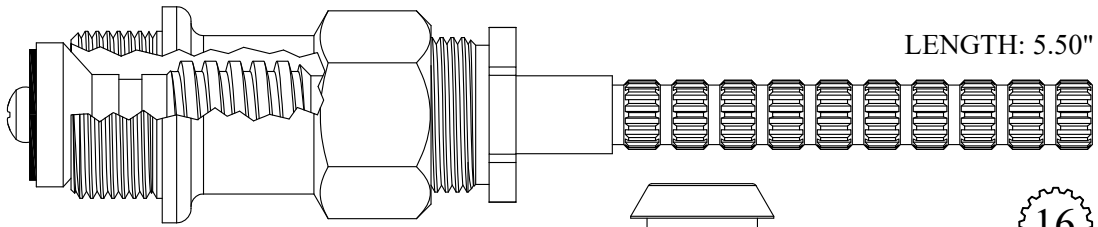

LENGTH: 5.50"

421621/ 421622

GASKET INCLUDED: 895400

221621/ 221622 Stem Only



SEAT USED: 648370



3-16

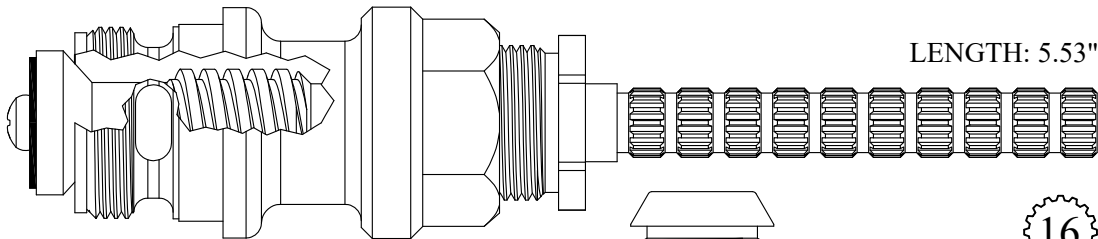

LENGTH: 5.53"

432021

GASKET INCLUDED: 895560

234731 Stem Only

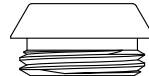

SEAT USED: 648370



3-16

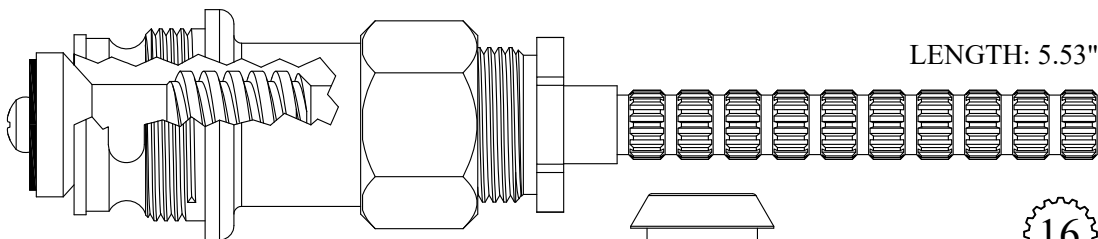

LENGTH: 5.53"

434731

GASKET INCLUDED: 895550

234731 Stem Only



SEAT USED: 648370



3-16

FOR DOLLY TRIM

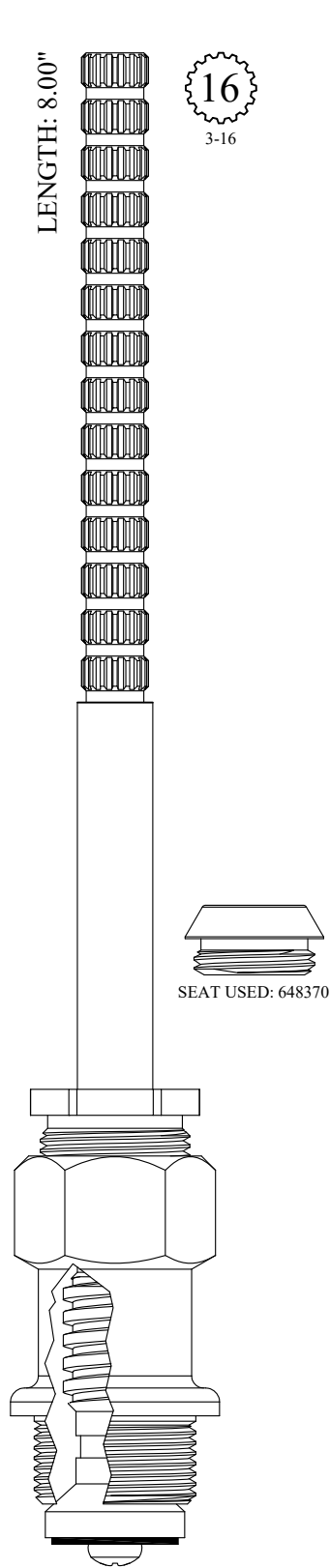

GASKET INCLUDED: 895400

428221
428222
228221 Stem Only
228222 Stem Only

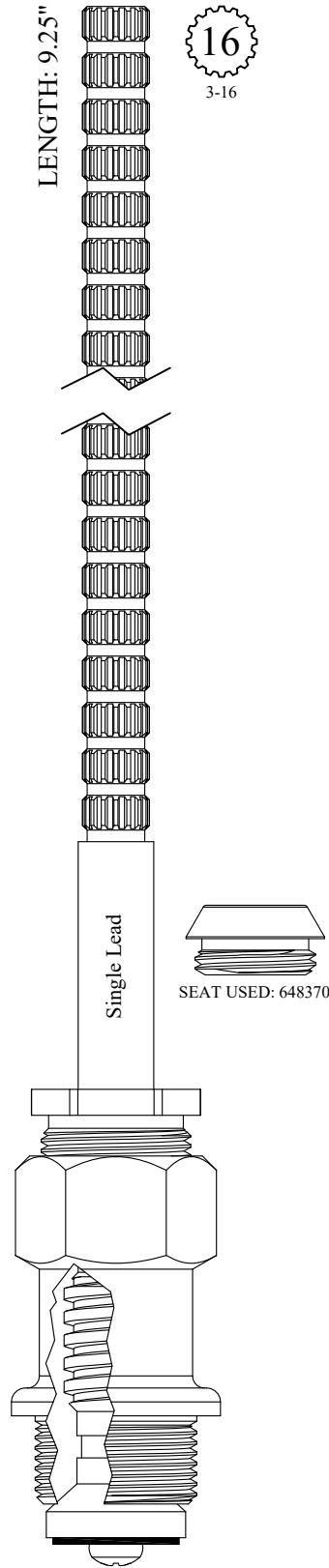

GASKET INCLUDED: 895400

428391
428392
228391 Stem Only
228392 Stem Only

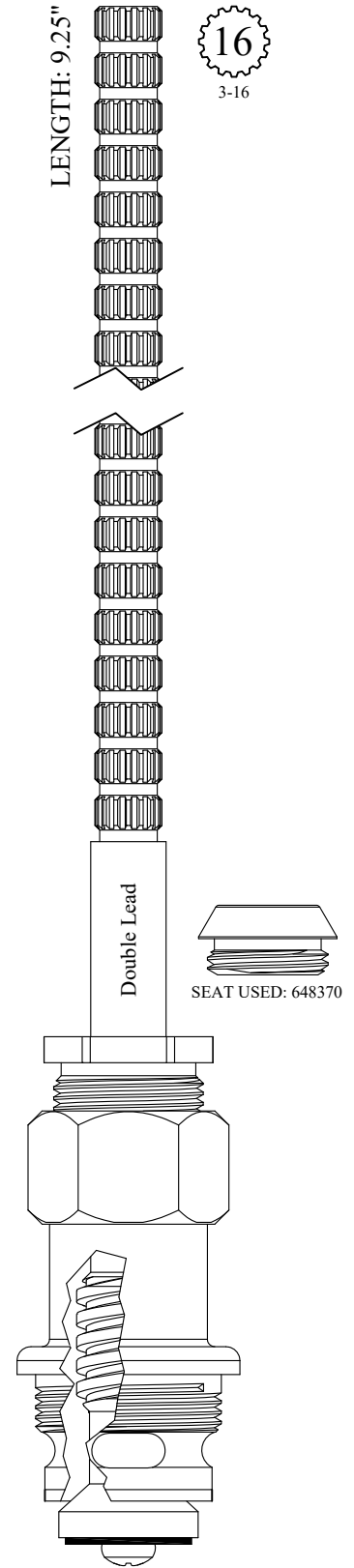

GASKET INCLUDED: 895550

439881
239881 Stem Only

FOR DORF

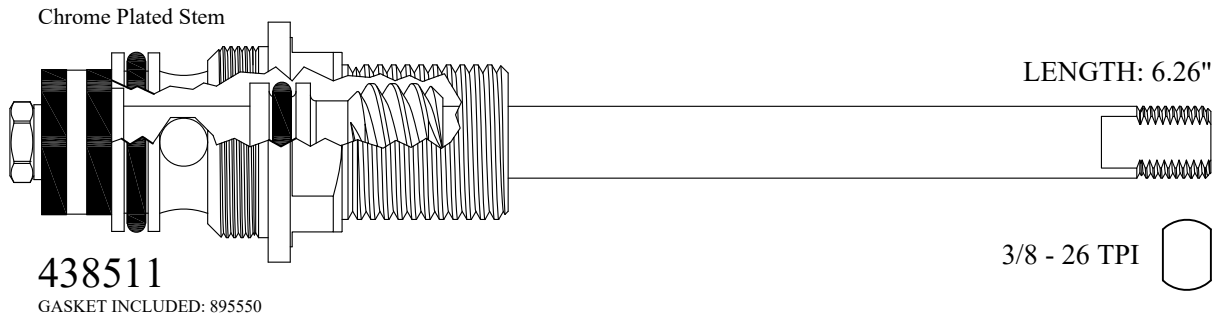

FOR DORNBRACHT

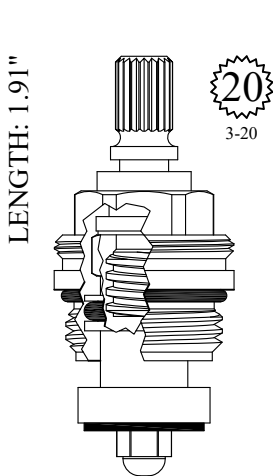

LF456362
OEM # 9090030230190 or 03.90.03.020.00.60

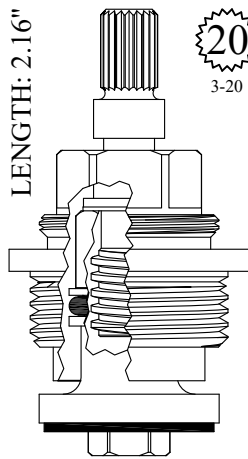

401082
OEM # 03.90.03.040.00.90 or 07.025

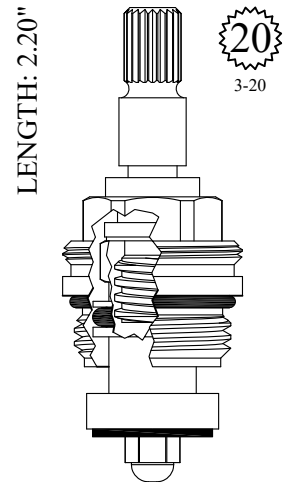
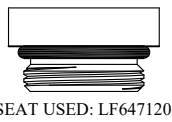

LF459512
OEM # 0390030210090

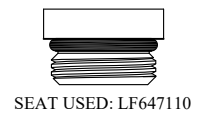

FOR DORNBRACHT LENGTH: 2.52"

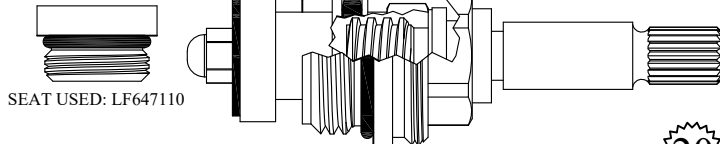

LF463872
GASKET: 890170 O-RING INCLUDED
OEM # 03.90.03.022.00.90

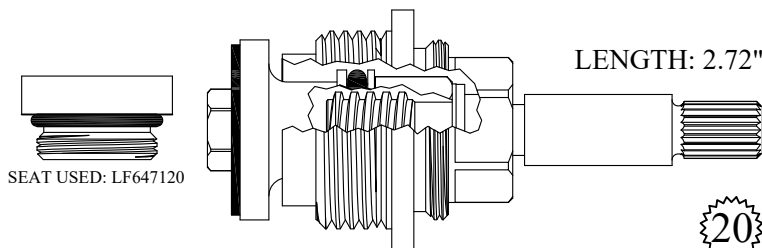

401762
GASKET INCLUDED: 895560
OEM # 03.90.03.041.00.90

**ALL DORNBRACHT UNITS
ON THIS PAGE COME
WITH THIS PLASTIC
BROACH ADAPTER**

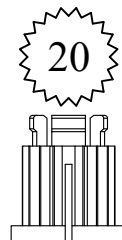

Comes with 20pt
Dornbracht adapter: 103200

FOR DORNBRACHT

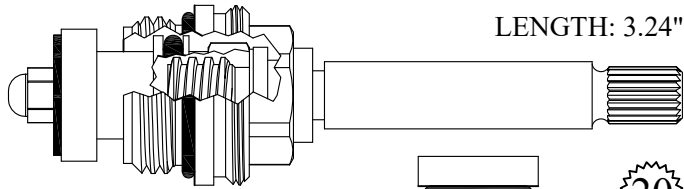

LENGTH: 3.24"

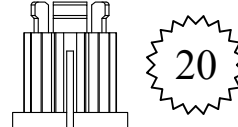

20

Comes with 20pt
Dornbracht adapter:
103200

402242

GASKET: 890170 O-RING INCLUDED
OEM # 03.90.03.050.00.90

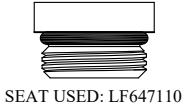

SEAT USED: LF647110



20
3-20

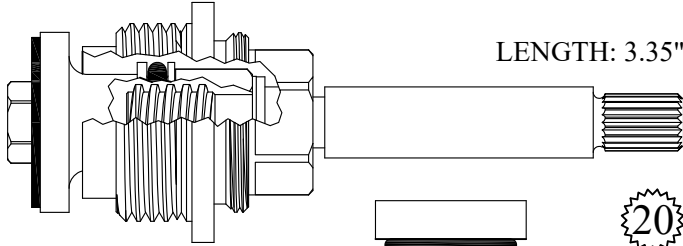

LENGTH: 3.35"

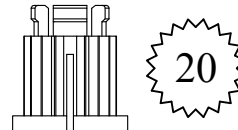

20

Comes with 20pt
Dornbracht adapter:
103200

402752

GASKET INCLUDED: 895560
OEM # 03.90.03.060.00.90

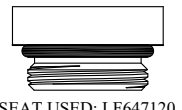

SEAT USED: LF647120



20
3-20

Old Style - Automatic

LENGTH: 3.59"

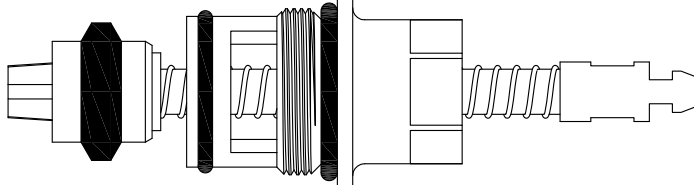

430790

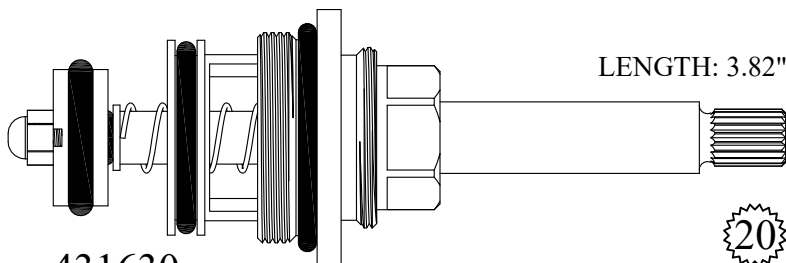

LENGTH: 3.82"

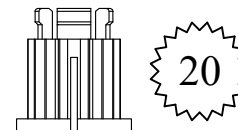

20

Comes with 20pt
Dornbracht adapter:
103200

431630

GASKET: 891200 O-RING INCLUDED



20
3-20

LENGTH: 6.23"

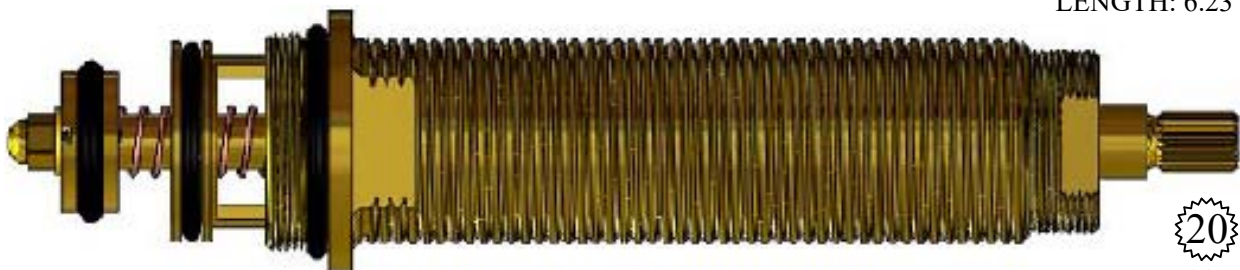

438520

OEM # 0430010130190



20
3-20

FOR DWYER

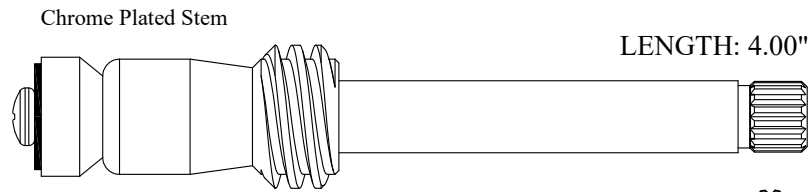

LF270041/ LF270042

16
1-6

FOR EAST RIVER

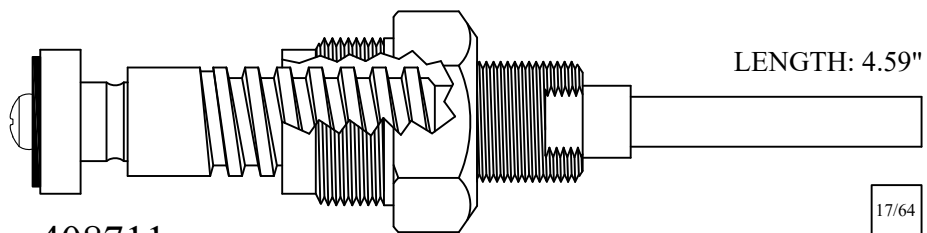

408711
GASKET INCLUDED: 895150
208711 Stem Only

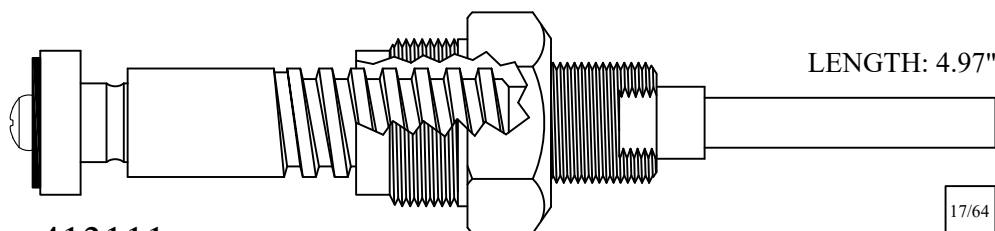

413111
GASKET INCLUDED: 895150
213111 Stem Only

FOR EAST RIVER

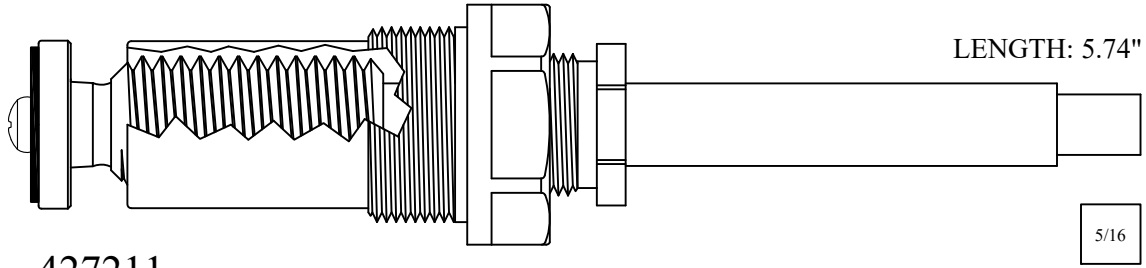

427211
GASKET INCLUDED: 895540
227211 Stem Only

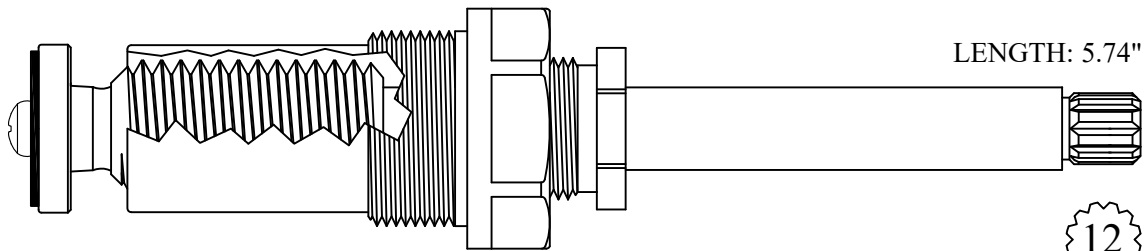

427261
GASKET INCLUDED: 895540
227261 Stem Only

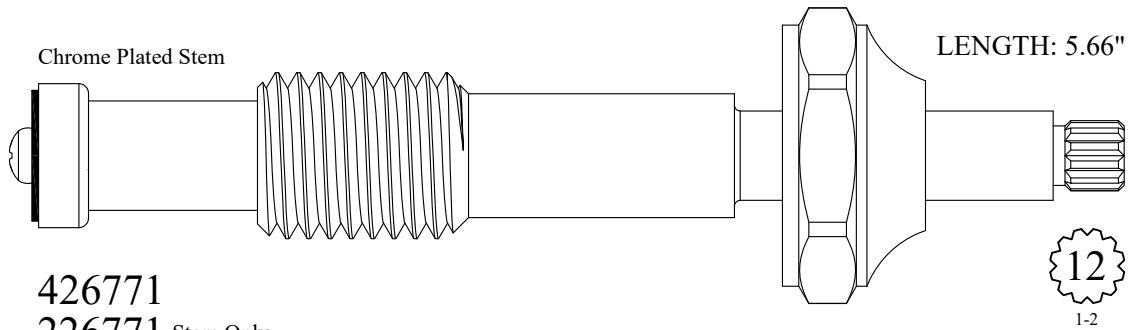

426771
226771 Stem Only

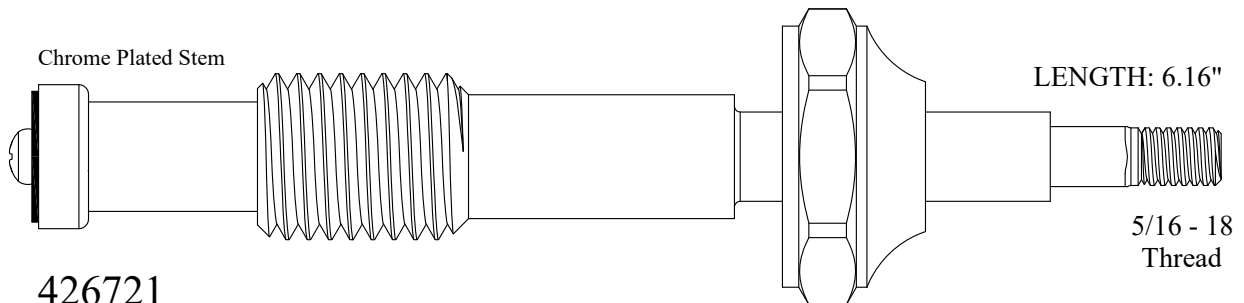

426721
226721 Stem Only

FOR ELECTROWAY

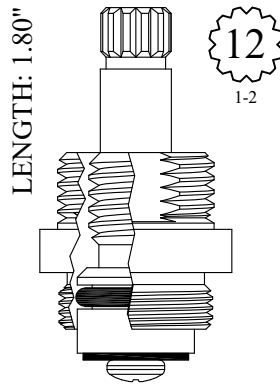

LF457141
LF457142

FOR ELIZABETHAN CLASSICS

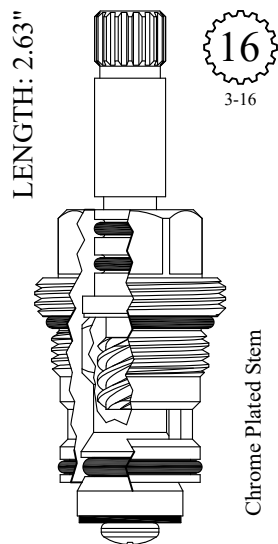

GASKET: 890180 O-RING INCLUDED

430881

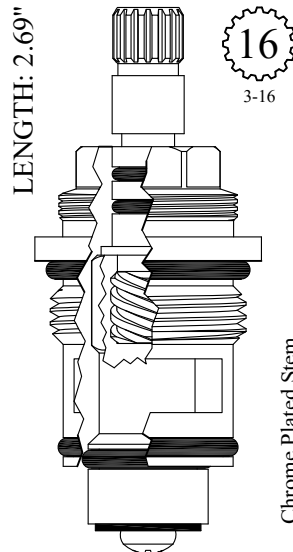

GASKET: 890180 O-RING INCLUDED

431052
OEM # P099-120502D

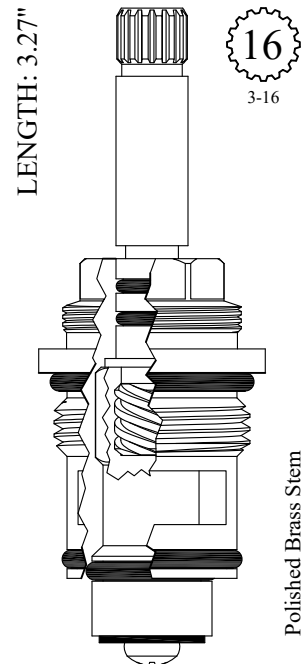

GASKET: 890180 O-RING INCLUDED

431552

FOR ELJER

LENGTH: 1.16"

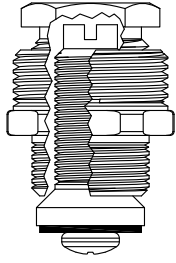

GASKET INCLUDED: 895060

400101

LENGTH: 1.19"

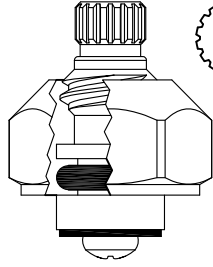

16
3-15

Nickel Plated Gland

LF450031

OEM # 490-5294-02

LF450032

OEM # 490-5294-01

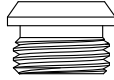

SEAT USED: LF648320

LENGTH: 1.25"

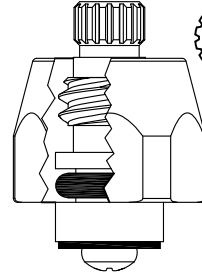

16
3-15

Nickel Plated Gland

LF450231

OEM # 490-6344-02

LF450232

OEM # 490-6344-01

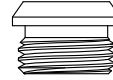

SEAT USED: LF648320

LENGTH: 1.25"

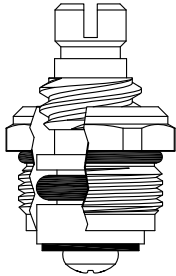

GASKET: 890160 O-RING INCLUDED

400131

LENGTH: 1.25"

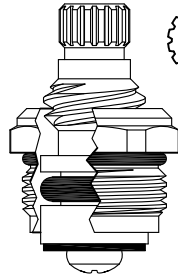

16
3-15

GASKET: 890160 O-RING INCLUDED

LF450851

OEM # 490-6339

LF450852



SEAT USED: LF648320

LENGTH: 1.25"

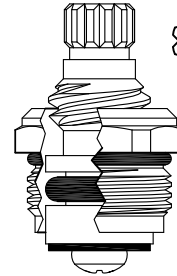

12
1-2

GASKET: 890160 O-RING INCLUDED

LF450861

LF450862

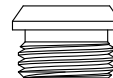

SEAT USED: LF648320

LENGTH: 1.38"

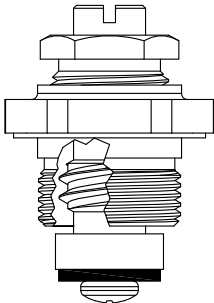

GASKET INCLUDED: 895100

400331

OEM # 490-2725-00

200331

OEM # 490-2727-00

LENGTH: 1.38"

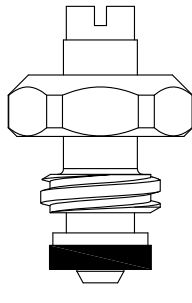

400251

LENGTH: 1.55"

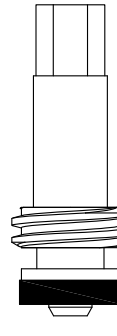

200351

FOR ELJER

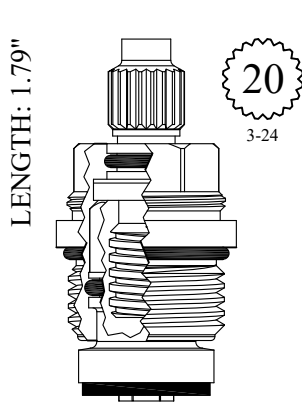

GASKET: 890170 O-RING INCLUDED

LF455962
OEM # V491-2506

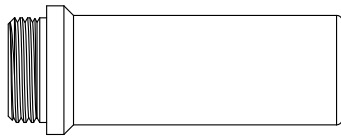

SEAT USED: LF647430

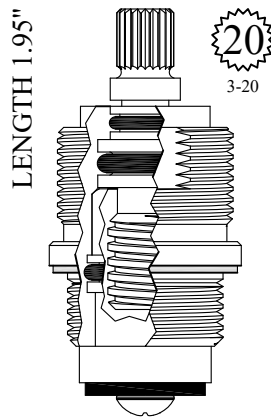

GASKET INCLUDED: 895160

LF457242
OEM # 491-2506

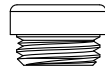

SEAT USED: LF647690

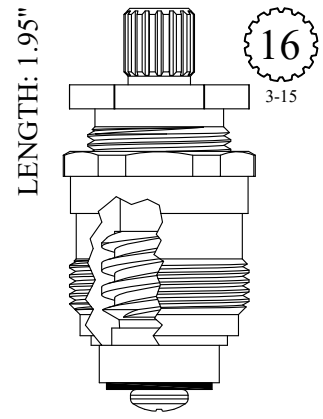

GASKET INCLUDED: 895120

LF458101
OEM # 490-8105-02

LF458102
OEM # 490-8105-01

LF258101 Stem Only

LF258102 Stem Only

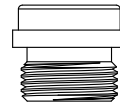

SEAT USED: LF648160

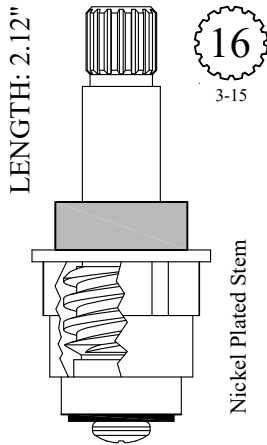

LF460091

LF460092

LF260091 Stem Only

LF260092 Stem Only

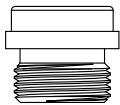

SEAT USED: LF648160

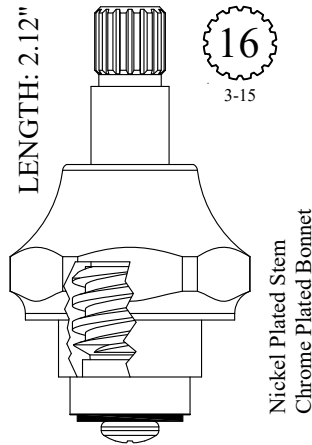

LF460191

OEM # 490-2808-02

LF460192

OEM # 490-2808-01

LF260091 Stem Only

LF260092 Stem Only



SEAT USED: LF648160

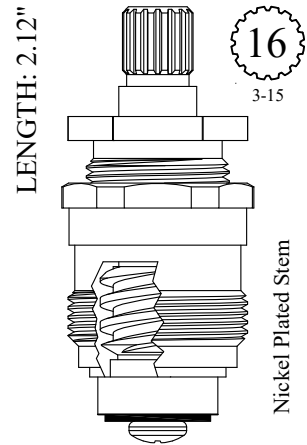

GASKET: 895120

LF460111

OEM # 490-8051-02

LF460112

OEM # 490-8051-01

LF260091 Stem Only

LF260092 Stem Only



SEAT USED: LF648160

FOR ELJER

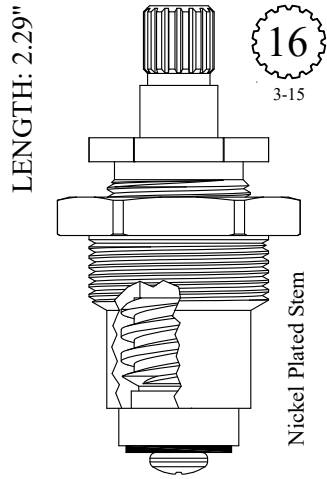

GASKET INCLUDED: 895330

LF463071
LF463072
LF263071 Stem Only
LF263072 Stem Only

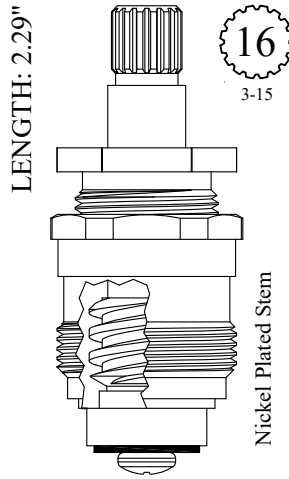

GASKET INCLUDED: 895120

LF463171
OEM # 490-8056-01
LF463172
OEM # 490-8056-02
LF263071 Stem Only
LF263072 Stem Only

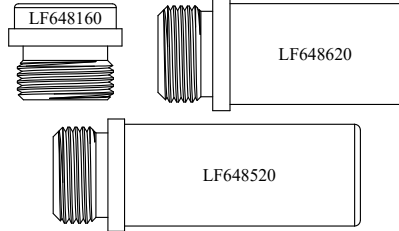

SEATS USED: LF648160, LF648520 & LF648620

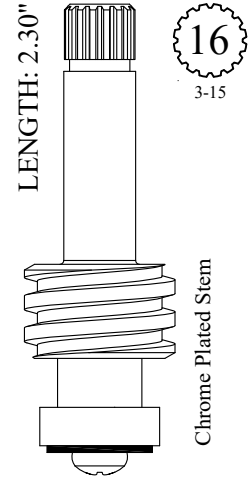

LF260201
LF260202

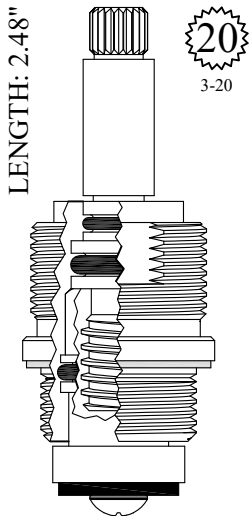

GASKET INCLUDED: 895160

401342
OEM # 491-2503-00

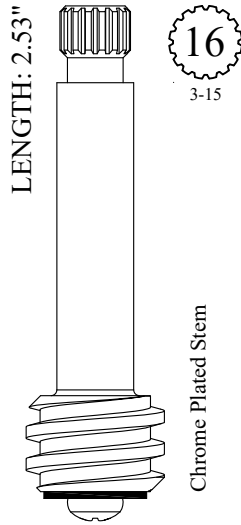

LF265171

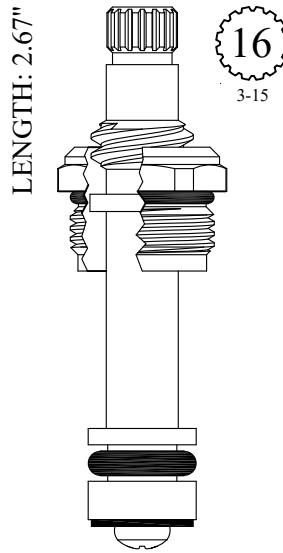

GASKET: 890160 O-RING INCLUDED

LF465381
OEM # 490-6953-00

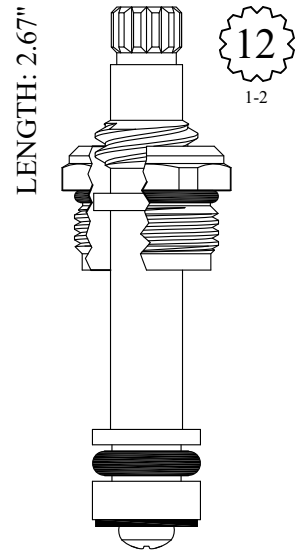

GASKET: 890160 O-RING INCLUDED

LF465391
LF465392
OEM # 490-7356-02
OEM # 490-7356-01



FOR ELJER

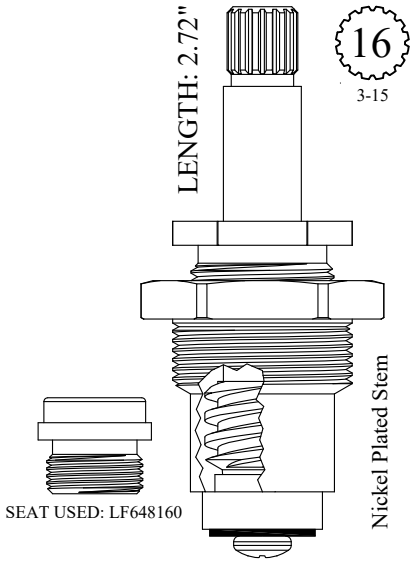

GASKET INCLUDED: 895330

LF465071
 OEM # 490-2740-02
LF465072
LF265071 Stem Only
LF265072 Stem Only

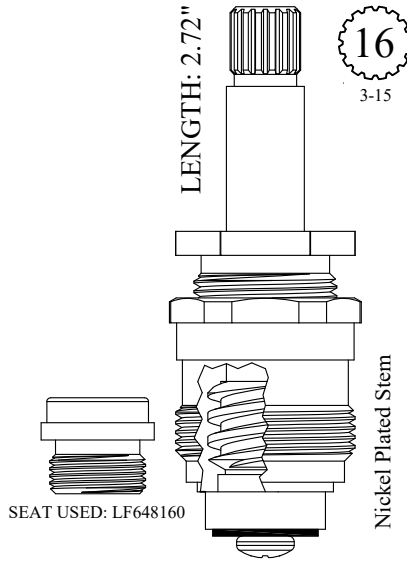

GASKET INCLUDED: 895120

LF465571
 OEM # 490-8143-01 RH
LF465572
 OEM # 490-8143-01 LH
LF265071 Stem Only
LF265072 Stem Only

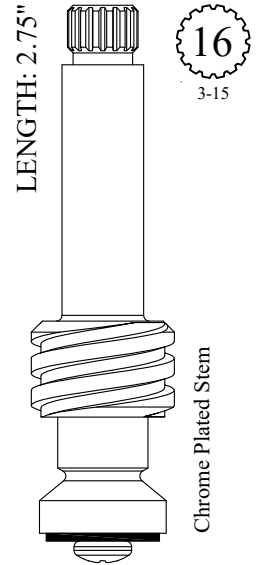

LF265601
LF265602
 OEM # SU-1854/90

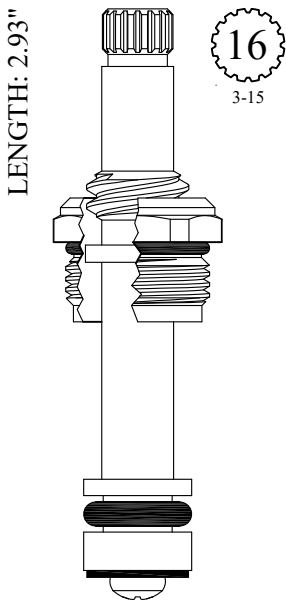

GASKET: 890160 O-RING INCLUDED

LF465801
 OEM # 490-8419-02
LF465802
 OEM # 490-8419-01

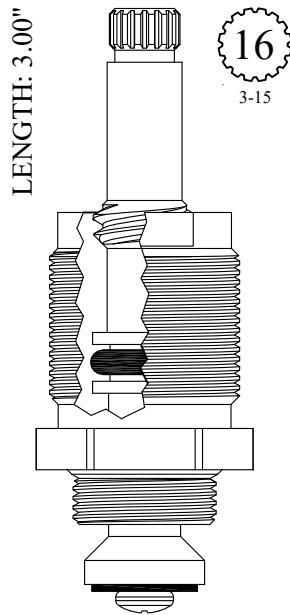

GASKET INCLUDED: 895100

401741
 OEM # 490-7143-02
401742

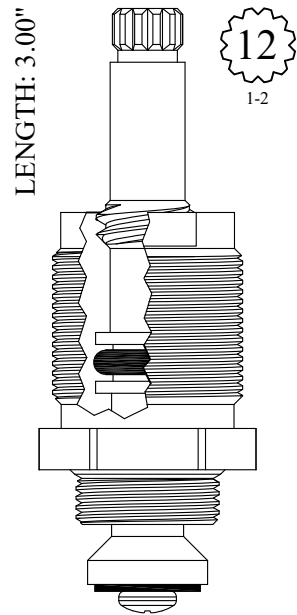

GASKET INCLUDED: 895100

401791
 OEM # 490-7432-02
401792



FOR ELJER



SEAT USED: LF648320

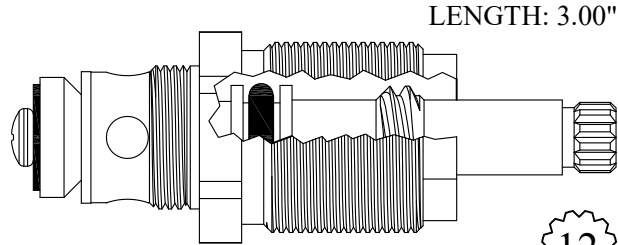

LENGTH: 3.00"

430271
GASKET INCLUDED: 895100
OEM # 490-7433-00

12
1-2



SEAT USED: LF648320

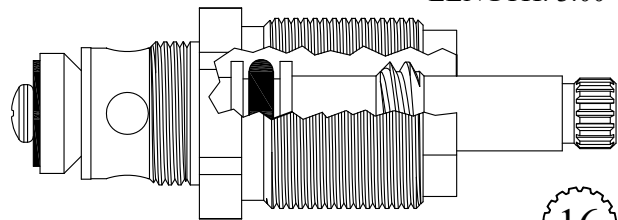

LENGTH: 3.00"

430281
GASKET INCLUDED: 895100
OEM # 490-7145-00

16
3-15



SEAT USED: LF647690

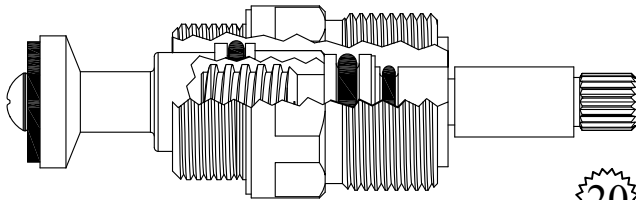

LENGTH: 3.12"

402012
GASKET INCLUDED: 895160
OEM # 491-2505-00

20
3-20

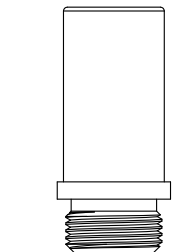

SEAT USED: LF648620

Chrome Plated Stem

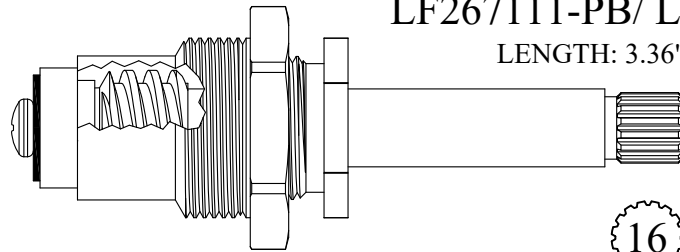

Also available with polished brass stem
LF467111-PB/ LF467112-PB
LF267111-PB/ LF267112-PB Stem Only

LENGTH: 3.36"

16
3-15

LF467111/ LF467112
GASKET INCLUDED: 895330
OEM # 490-2740-06
LF267111/ LF267112 Stem Only
OEM # 490-2788-02/ 490-2788-01

FOR ELJER

Also available with polished brass stem

LF467611-PB/ LF467612-PB

LF267111-PB/ LF267112-PB Stem Only

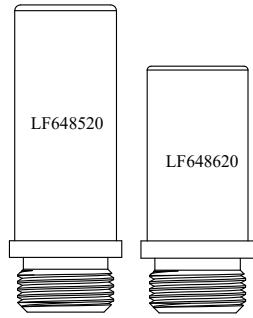

SEAT USED: LF648520 or LF648620

Chrome Plated Stem

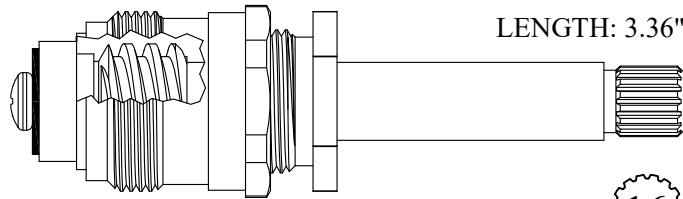

LF467611/ LF467612

GASKET INCLUDED: 895120

OEM # 490-6434-02/ 490-6434-01

LF267111/ LF267112 Stem Only

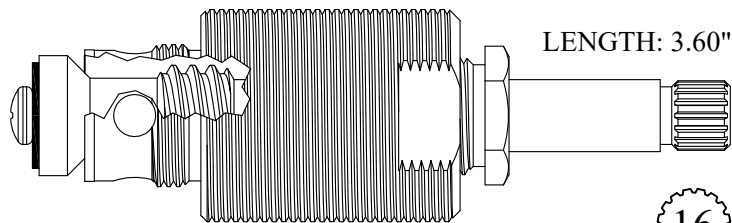

430131

GASKET INCLUDED: 895100

OEM # 490-8272-02

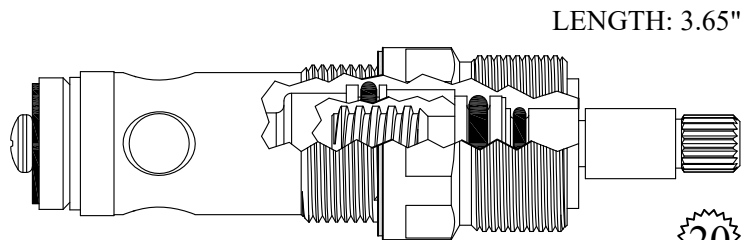

430192

GASKET INCLUDED: 895160

OEM # 491-2658-00 or 491-2507-0

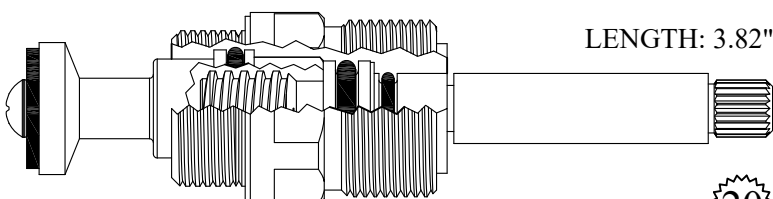

403232

GASKET INCLUDED: 895160



FOR ELJER



SEAT USED: LF648160

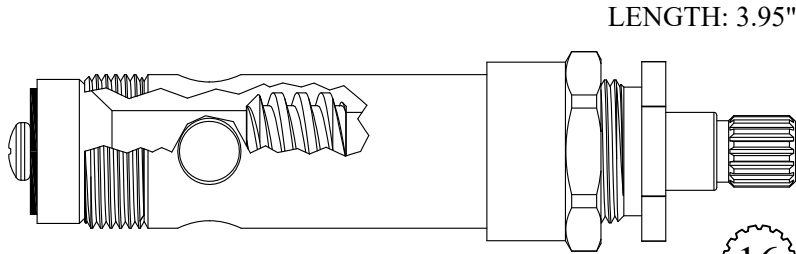

LENGTH: 3.95"

430431

GASKET INCLUDED: 895150
OEM # 490-6391-00

230431 Stem Only
OEM # 490-6759

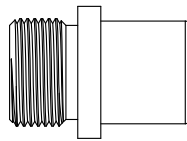

SEAT USED: LF649640

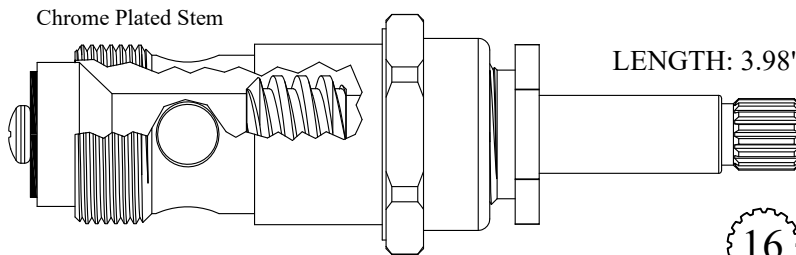

Chrome Plated Stem

LENGTH: 3.98"

430251

GASKET INCLUDED: 895320

230251 Stem Only

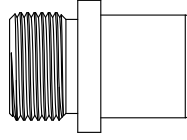

SEAT USED: LF649640

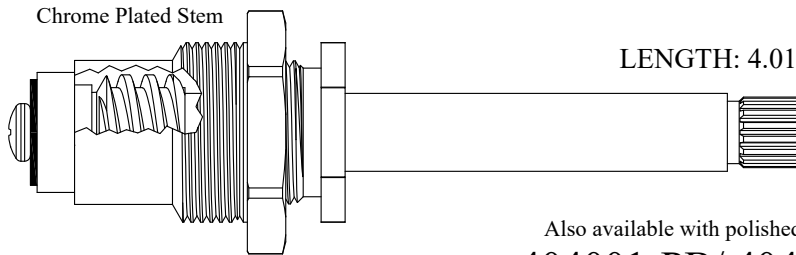

Chrome Plated Stem

LENGTH: 4.01"

404001/ 404002

GASKET INCLUDED: 895330
OEM # 490-2740-04/ 490-2740-03

204001/ 204002 Stem Only
OEM # 490-2749-02

Also available with polished brass stem
404001-PB/ 404002-PB
204001-PB/ 204002-PB Stem Only

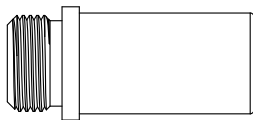

SEAT USED: LF648620

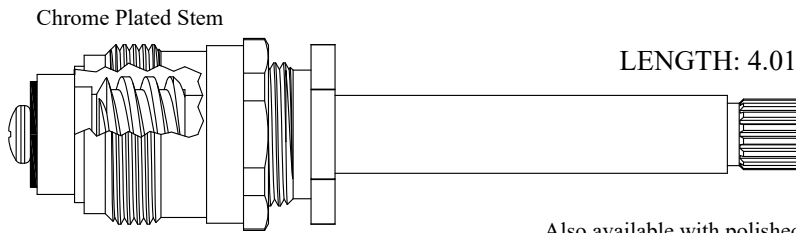

Chrome Plated Stem

LENGTH: 4.01"

404021/ 404022

GASKET INCLUDED: 895120

204001/ 204002 Stem Only
OEM # 490-2749-02

Also available with polished brass stem
404021-PB/ 404022-PB
204001-PB/ 204002-PB Stem Only



FOR ELJER



SEAT USED: LF648320

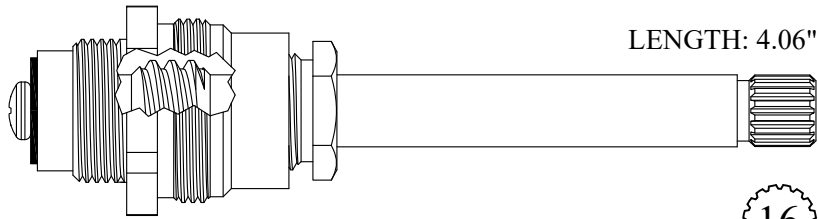

LENGTH: 4.06"

16
3-15

404211
GASKET INCLUDED: 895100
204221 Stem Only

Chrome Plated Sleeve

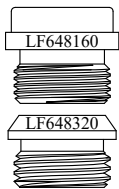

SEAT USED: LF648320 or LF648160

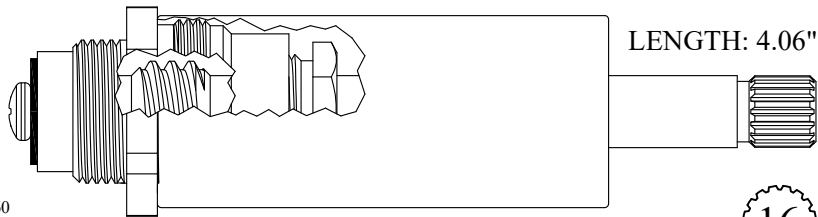

LENGTH: 4.06"

16
3-15

404221/ 404222
GASKET INCLUDED: 895100
OEM # 490-6750-02
204221/ 204222 Stem Only

IMPORT VERSION
EL20528

Chrome Plated Sleeve

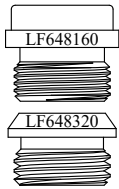

SEAT USED: LF648320 or LF648160

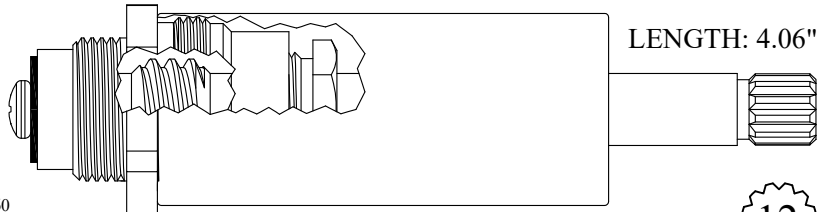

LENGTH: 4.06"

12
1-2

404241/ 404242
GASKET INCLUDED: 895100
204241/ 204242 Stem Only

Chrome Plated Sleeve

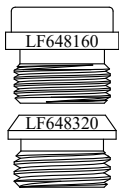

SEAT USED: LF648320 or LF648160

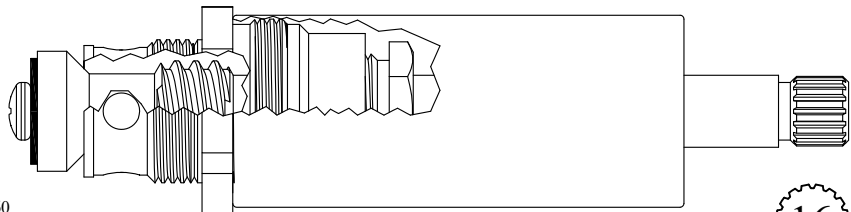

LENGTH: 4.23"

16
3-15

430221
GASKET INCLUDED: 895100
OEM # 490-6749-02
230221 Stem Only
OEM # 490-6751-02

IMPORT VERSION
EL20529

FOR ELJER

Chrome Plated Sleeve

LENGTH: 4.23"

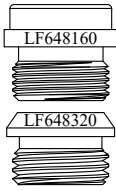

SEAT USED: LF648320 or LF648160

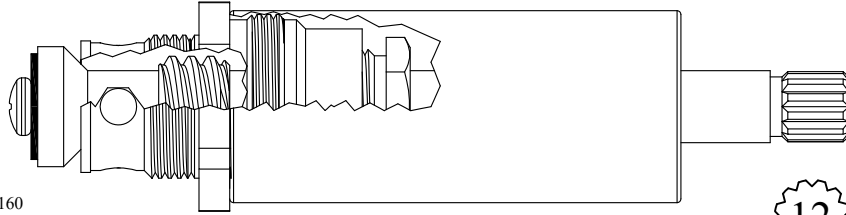

430341

GASKET INCLUDED: 895100

OEM # 490-7452-02

230341 Stem Only

OEM # 490-7428-02

12
1-2



SEAT USED: LF647690

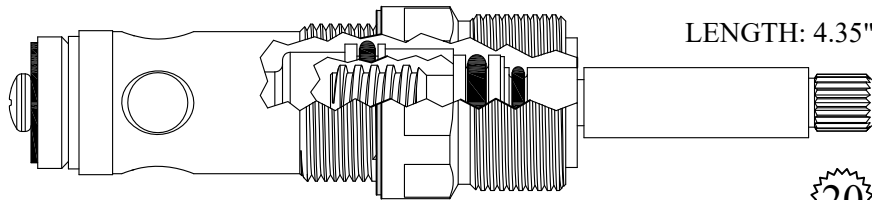

LENGTH: 4.35"

430552

GASKET INCLUDED: 895160

20
3-20

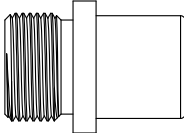

SEAT USED: LF649640

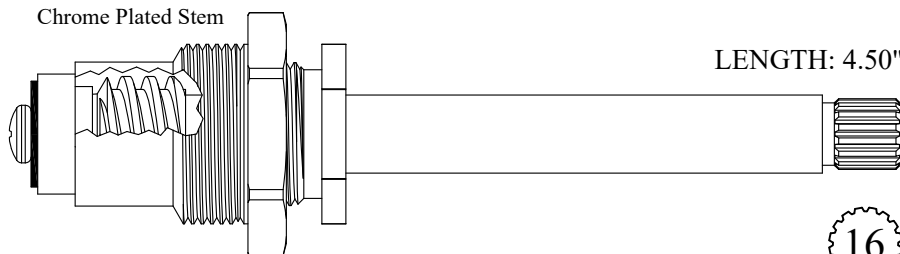

Chrome Plated Stem

LENGTH: 4.50"

411211/ 411212

GASKET INCLUDED: 895330

211211/ 211212 Stem Only

16
3-15

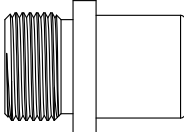

SEAT USED: LF649640



Chrome Plated Stem

LENGTH: 4.50"

411231/ 411232

GASKET INCLUDED: 895120

211211/ 211212 Stem Only

16
3-15

FOR ELJER

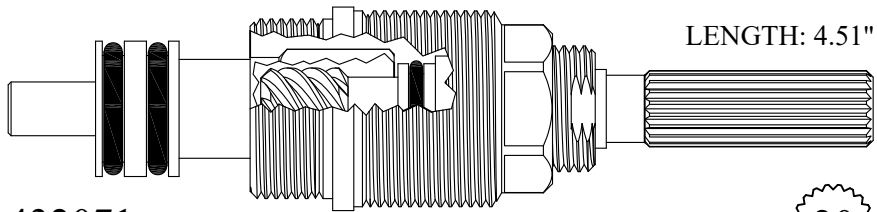

432071

GASKET INCLUDED: 895300

20
3-24



SEAT USED:
LF648320
or LF648160

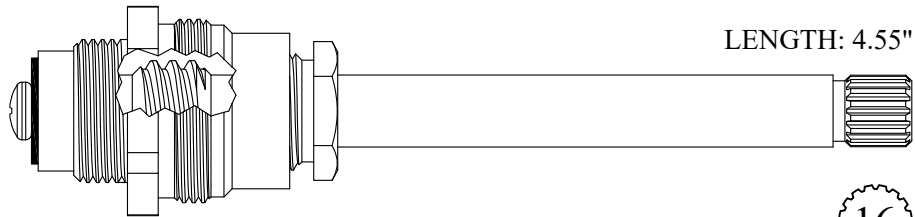

407831/ 407832

GASKET INCLUDED: 895100

207801/ 207802 Stem Only

16
3-15



SEAT USED:
LF648320
or LF648160

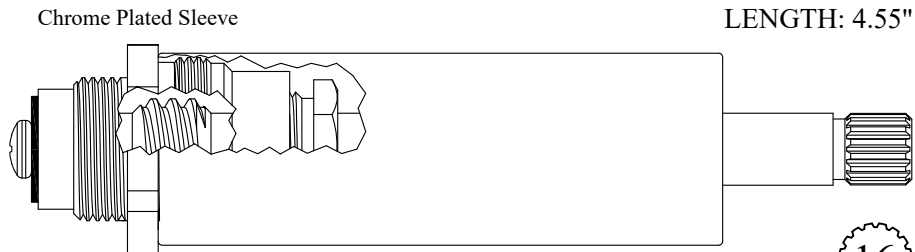

407801/ 407802

GASKET INCLUDED: 895100

OEM # 490-5264-02

207801/ 207802 Stem Only

OEM # 490-5264-01

IMPORT VERSION
EL20526 / EL20533

16
3-15



SEAT USED:
LF648320
or LF648160

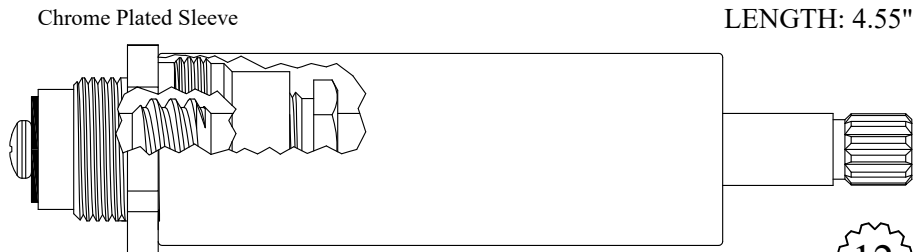

407851/ 407852

GASKET INCLUDED: 895100

207851/ 207852 Stem Only

12
1-2

FOR ELJER



Chrome Plated Gland

LENGTH: 4.55"



407821/ 407822

GASKET INCLUDED: 895100

207801/ 207802 Stem Only

IMPORT VERSION
EL20524



Plastic Plunger End

LENGTH 4.65"

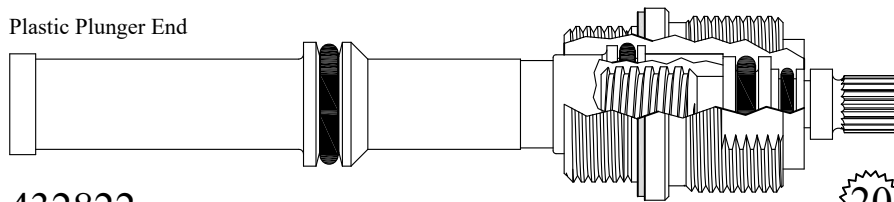

432822

GASKET: 895160 INCLUDED
OEM # 490-2510-00

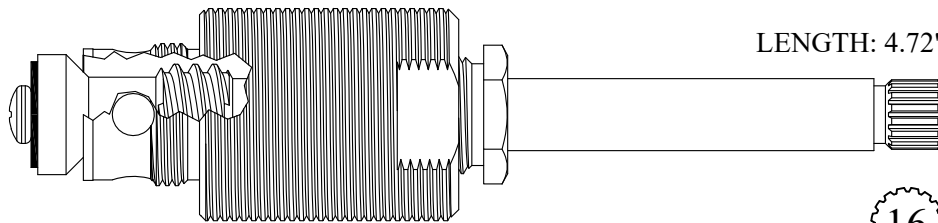

LENGTH: 4.72"

430321

GASKET INCLUDED: 895100
OEM # 490-8279-02

231001 Stem Only
OEM # 490-5266-00



Chrome Plated Sleeve

LENGTH: 4.72"

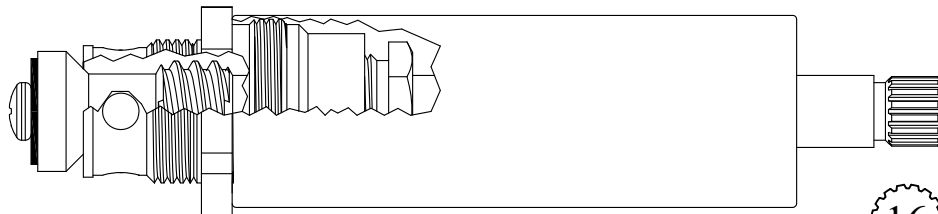

431001

GASKET INCLUDED: 895100
OEM # 490-5262-00

231001 Stem Only
OEM # 490-5266-00

IMPORT VERSION
EL20527



FOR ELJER

Chrome Plated Gland

LENGTH: 4.72"

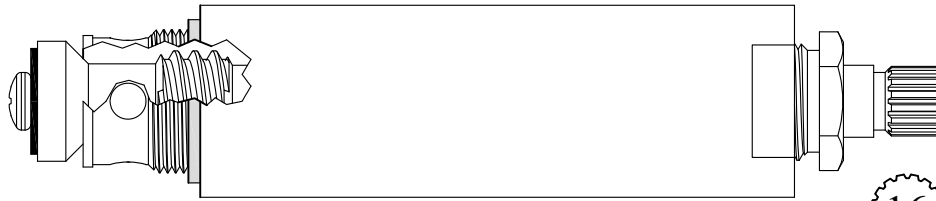

431021

GASKET INCLUDED: 895100
OEM # 490-5262-00

231001 Stem Only
OEM # 490-5266-00

IMPORT VERSION
EL20525

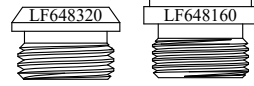

SEAT USED: LF648320 or LF648160

16
3-15

Chrome Plated Stem

LENGTH: 4.79"

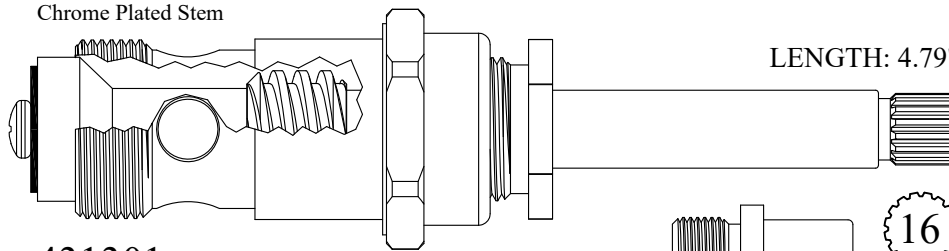

431301

GASKET INCLUDED: 895320
OEM # 490-5436-00

231301 Stem Only

Also available with
Polished Brass stem

431301-PB

231301-PB Stem Only

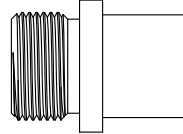

SEAT USED: LF649640

16
3-15

Chrome Plated Stem

LENGTH: 4.79"

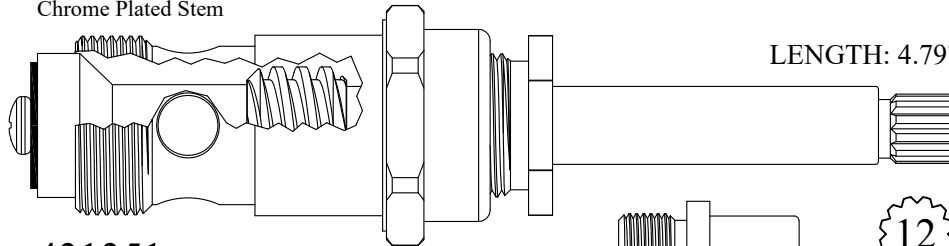

431351

GASKET INCLUDED: 895320

231351 Stem Only

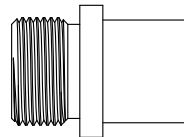

SEAT USED: LF649640

12
1-2

Chrome Plated Stem

LENGTH: 4.79"

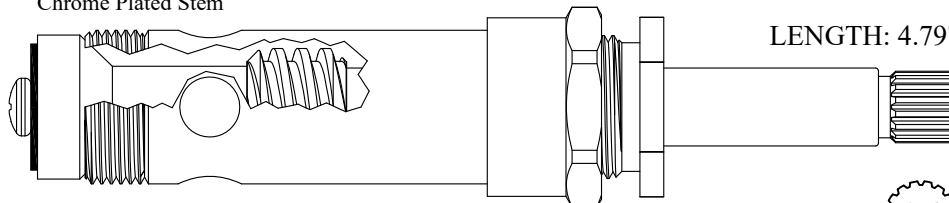

431321

GASKET INCLUDED: 895150

OEM # 490-6391-00

231301 Stem Only

OEM # 490-5266-00



SEAT USED: LF648160

16
3-15

FOR ELJER

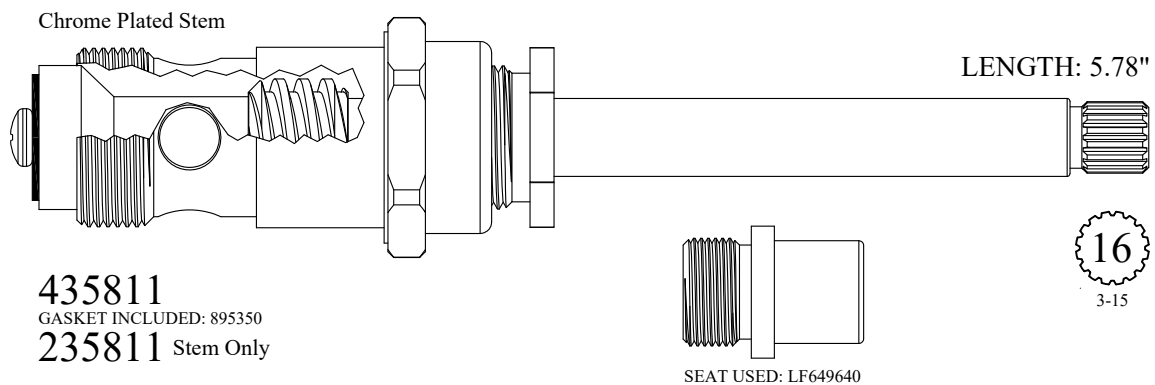
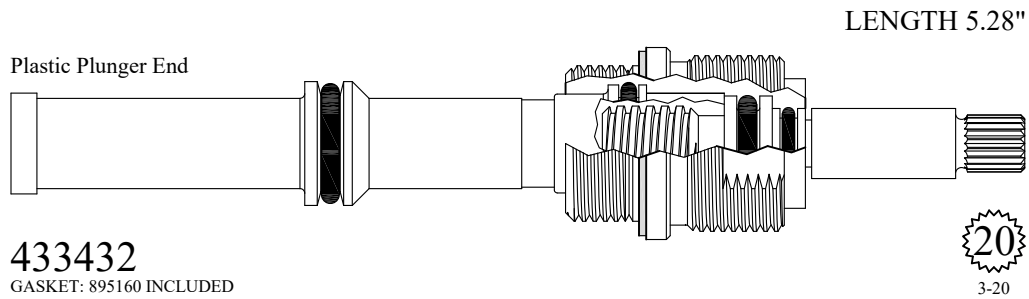
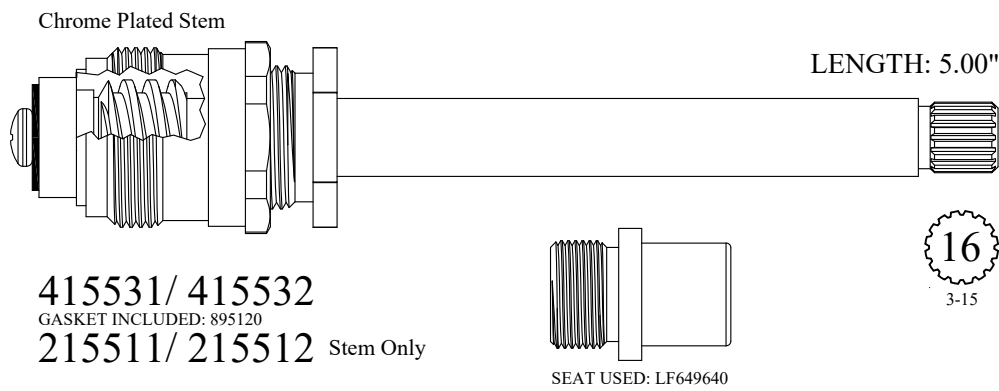
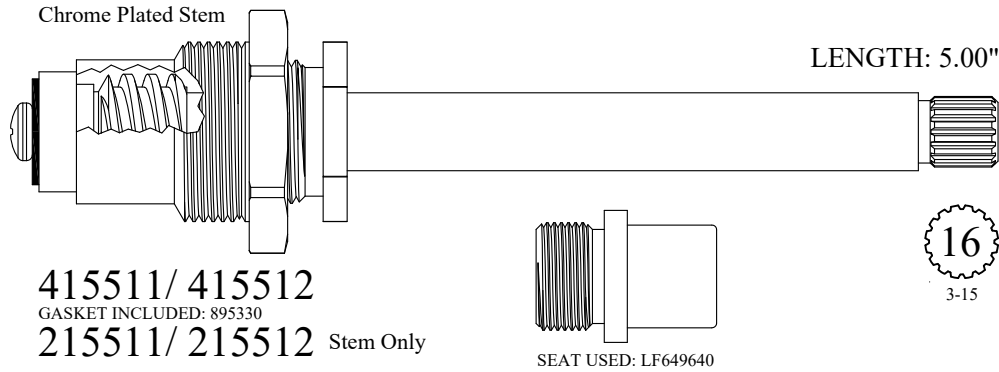

FOR ELK

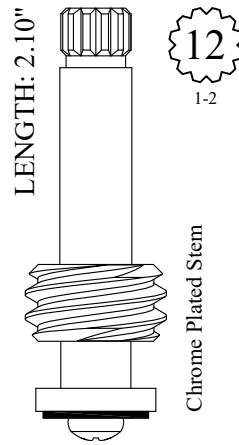

LF261101
LF261102

FOR EMCO

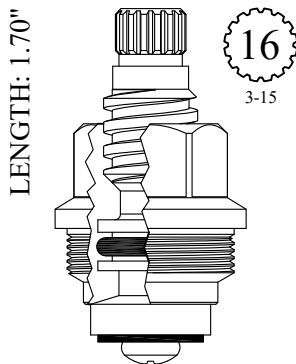

GASKET INCLUDED: 895180

LF452701
OEM # 1057

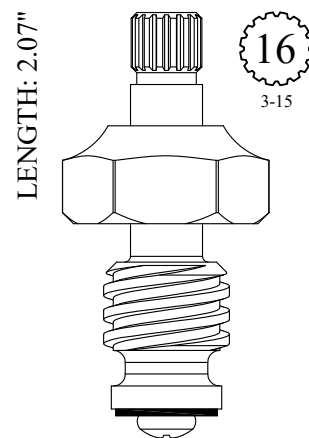

LF184561
LF184631 Stem Only

FOR EMPIRE

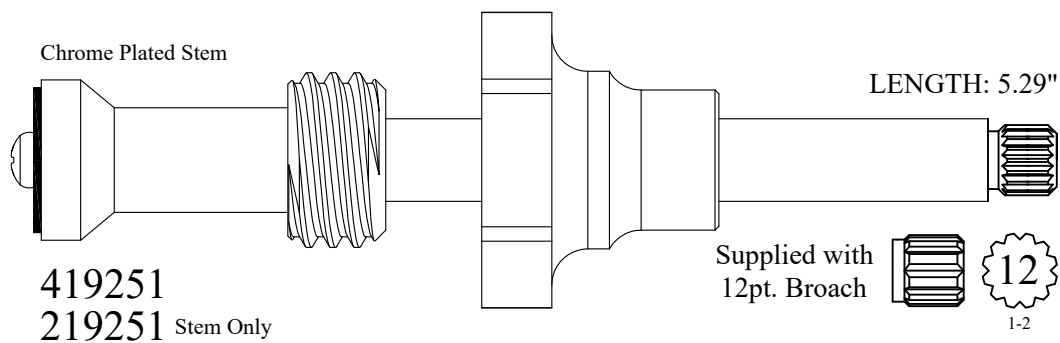
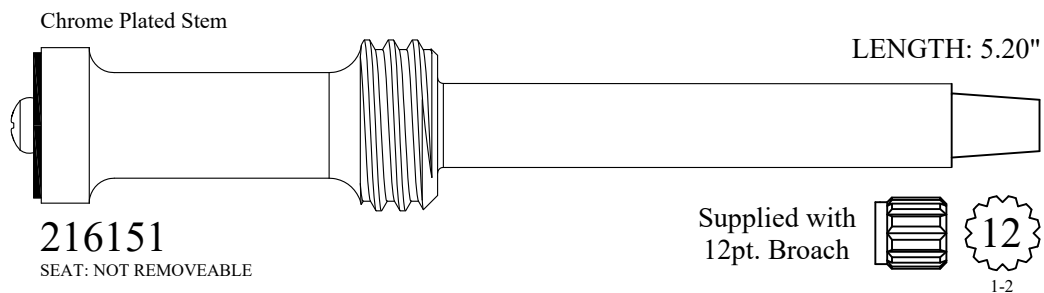
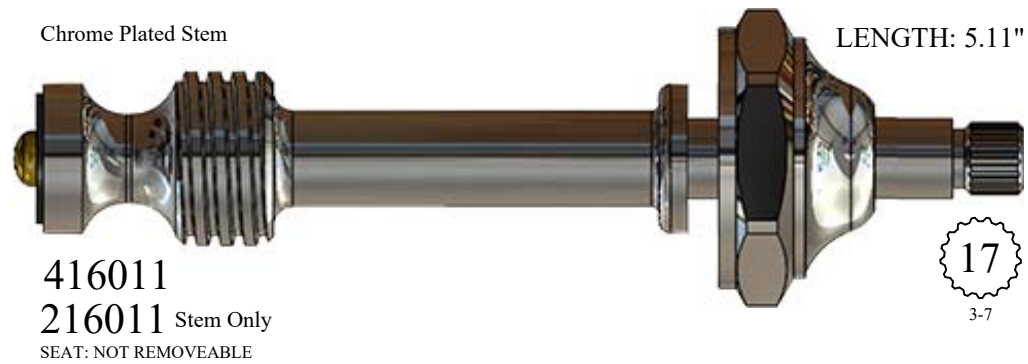
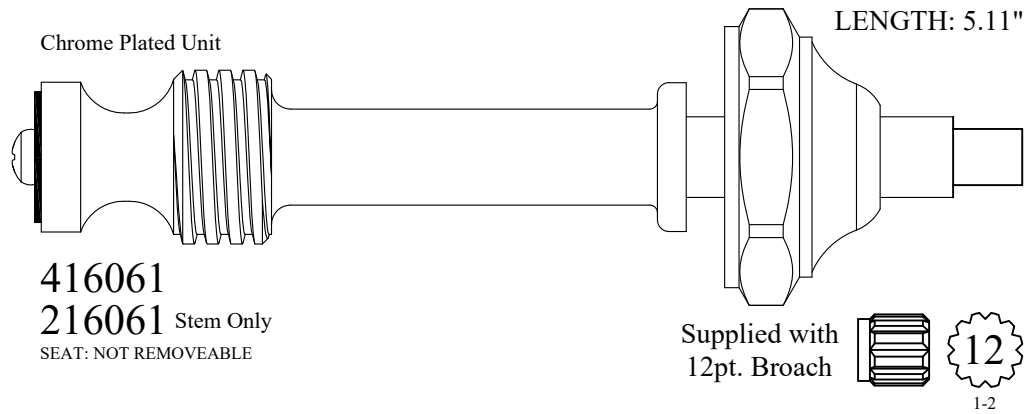

FOR EMPIRE

Chrome Plated Stem

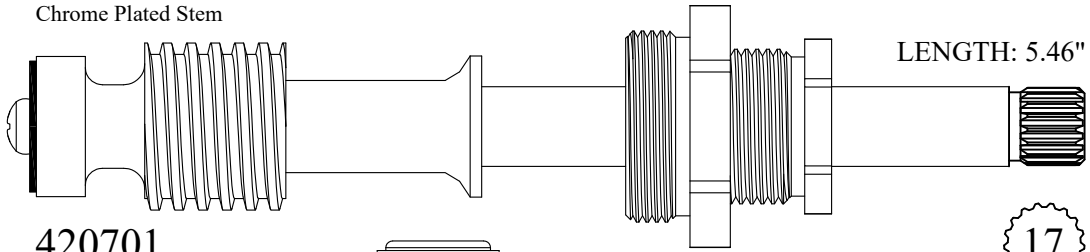

LENGTH: 5.46"

420701

GASKET INCLUDED: 895550

220701 Stem Only

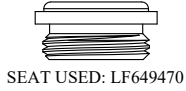

SEAT USED: LF649470

17

3-7

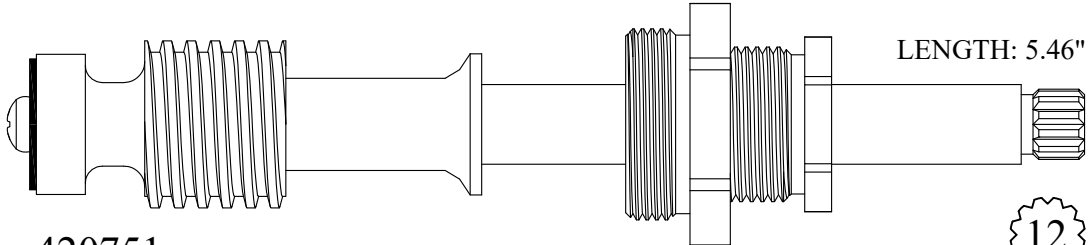

LENGTH: 5.46"

420751

GASKET INCLUDED: 895550

220751 Stem Only

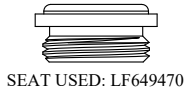

SEAT USED: LF649470

12

1-2

Chrome Plated Stem

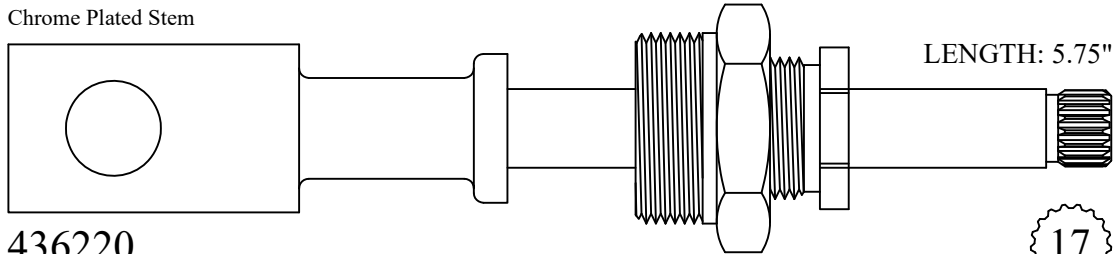

LENGTH: 5.75"

436220

GASKET INCLUDED: 895550

236220 Stem Only

17

3-7

Chrome Plated Stem

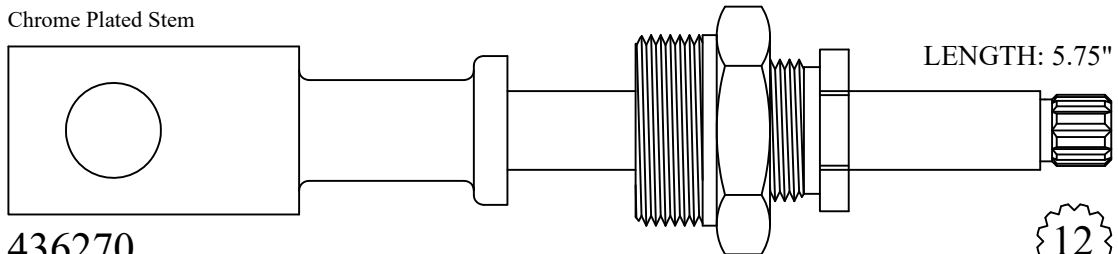

LENGTH: 5.75"

436270

GASKET INCLUDED: 895550

236270 Stem Only

12

1-2

Chrome Plated Stem

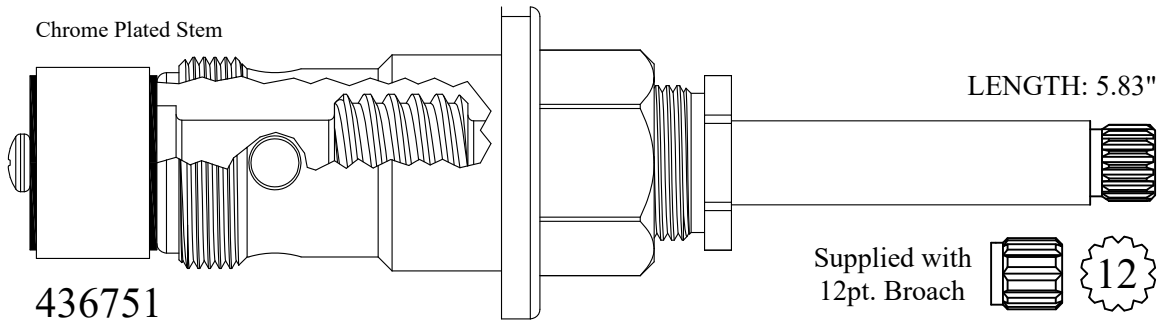

LENGTH: 5.83"

436751

GASKET INCLUDED: 895450

236751 Stem Only

Supplied with
12pt. Broach



12

1-2

FOR ENCORE

Chrome Plated Stem & Gland

LENGTH: 2.85"

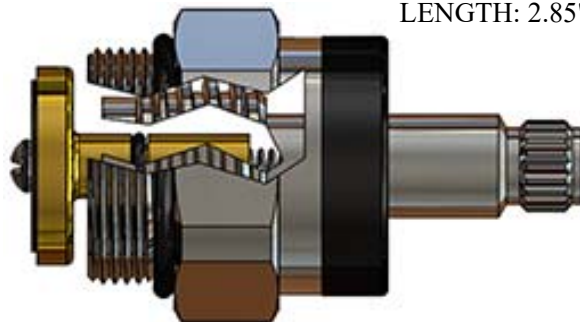

LF465491/ LF465492

GASKET: 890170 O-RING INCLUDED
OEM # KL34-Y007

LENGTH: 2.24"



LF462800 Chrome Plated Gland

GASKET: 890170 O-RING INCLUDED
OEM # KL50-Y027-Z

FOR ENTERPRISE

Chrome Plated Stem

LENGTH: 5.27"

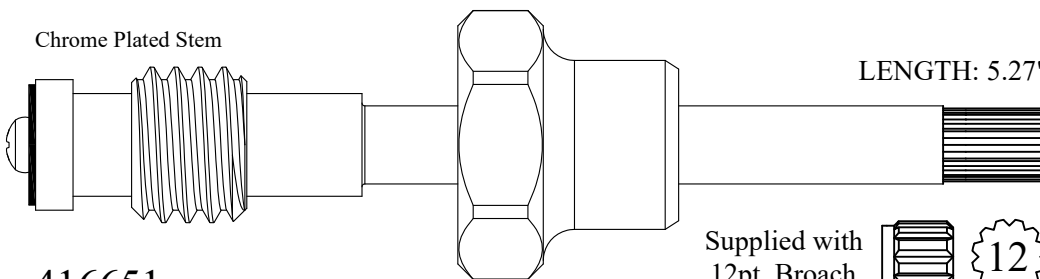

416651
216651 Stem Only

Supplied with
12pt. Broach

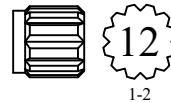

1-2



SEAT USED: LF648350

FOR ENWARE

LENGTH: 2.20"

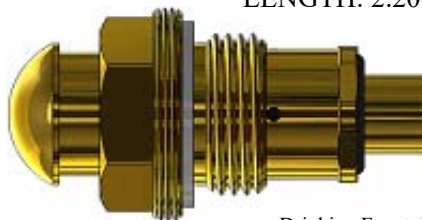

LF461600

Drinking Fountain
Push Button

FOR FANTINI

LENGTH: 2.17"

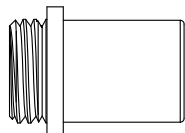

SEAT USED: LF647210

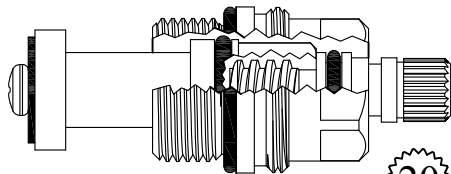

LF463332

GASKET: 890170 O-RING INCLUDED



11/32
3-34

LENGTH: 2.70"



402022

GASKET INCLUDED: 895350



3-22

FOR FEDERAL HUBER

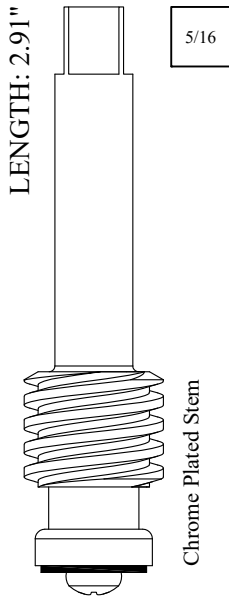

LF266021
LF266022

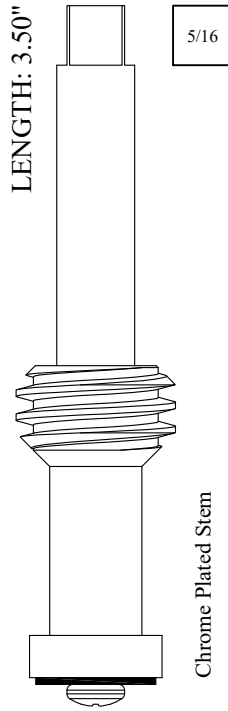

202801

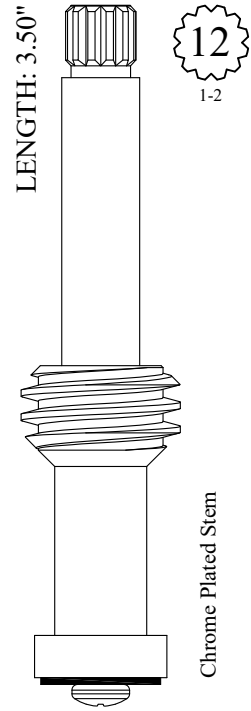

202851

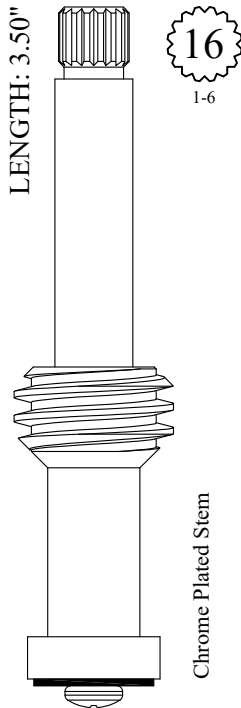

202871

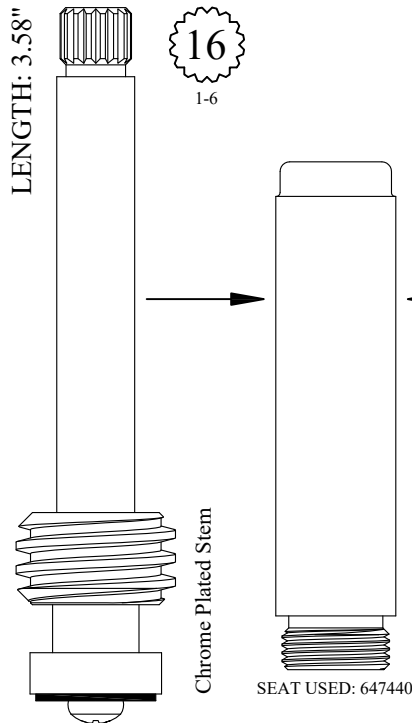

203101

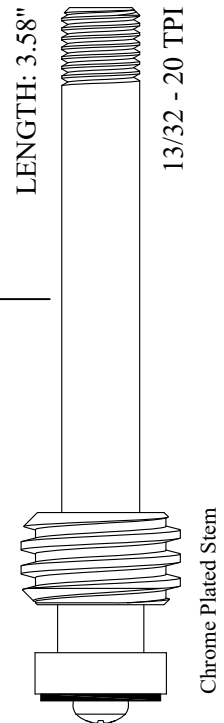

203111

FOR FEDERAL HUBER

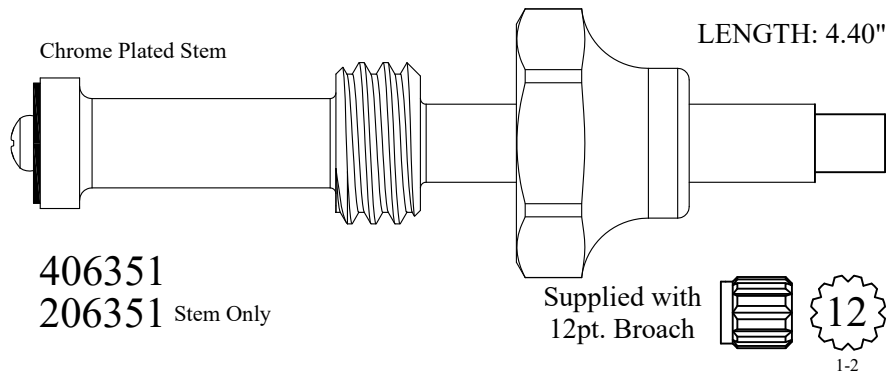
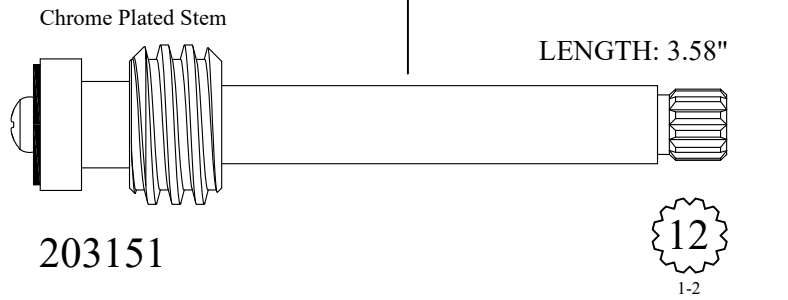
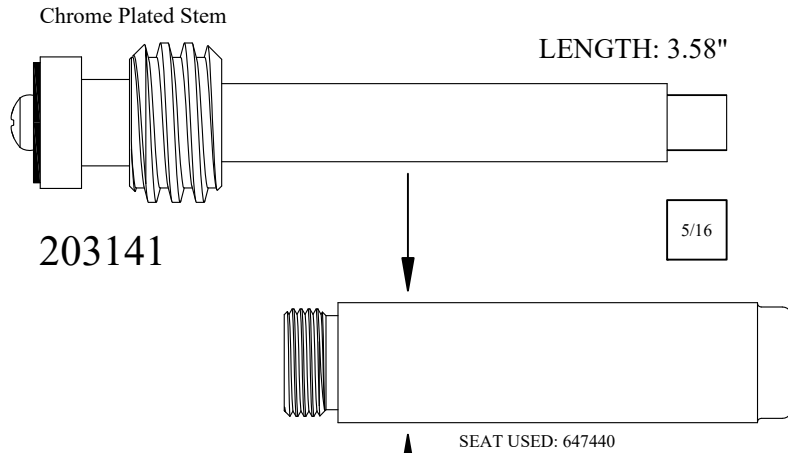

FOR FEDERAL HUBER

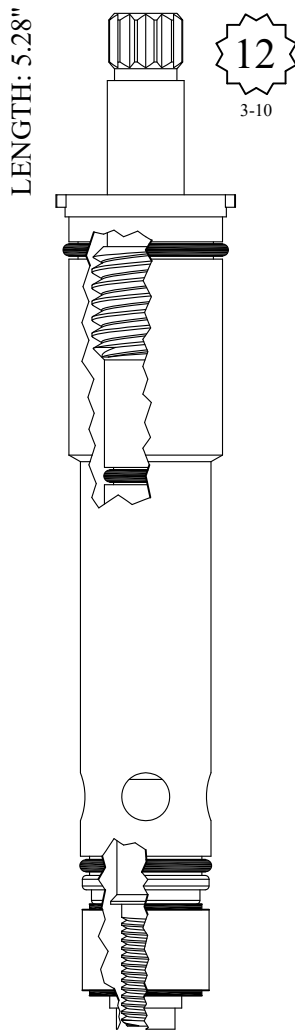

432901

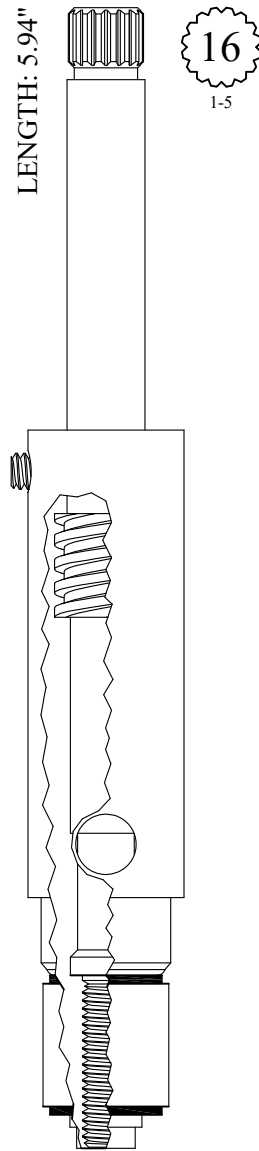

436441

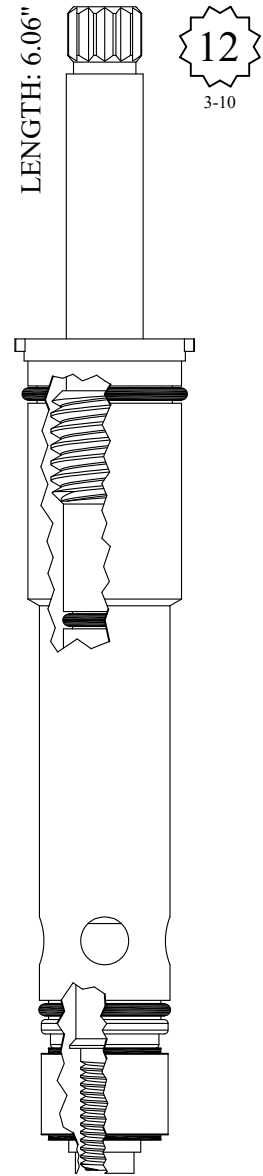

437011

FOR FEDERAL HUBER

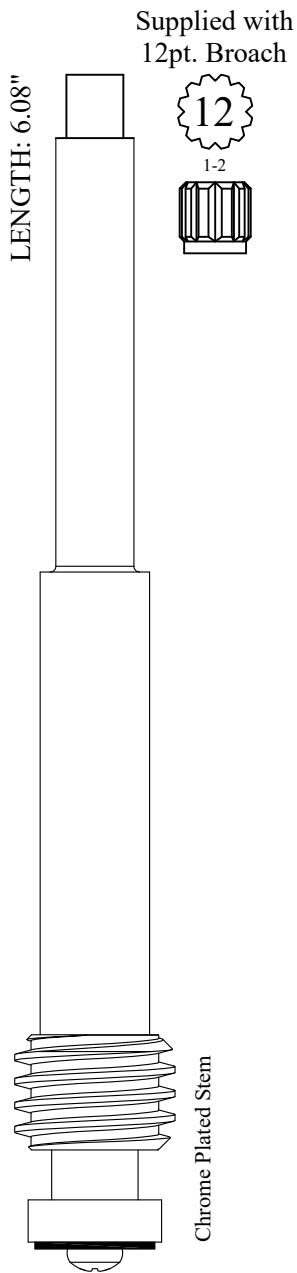

226631

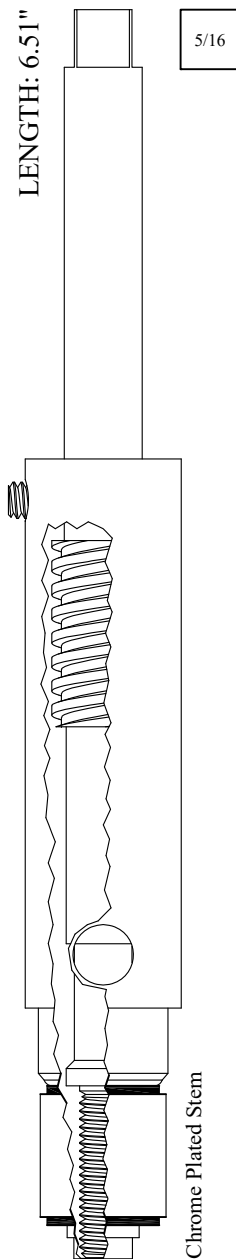

439001

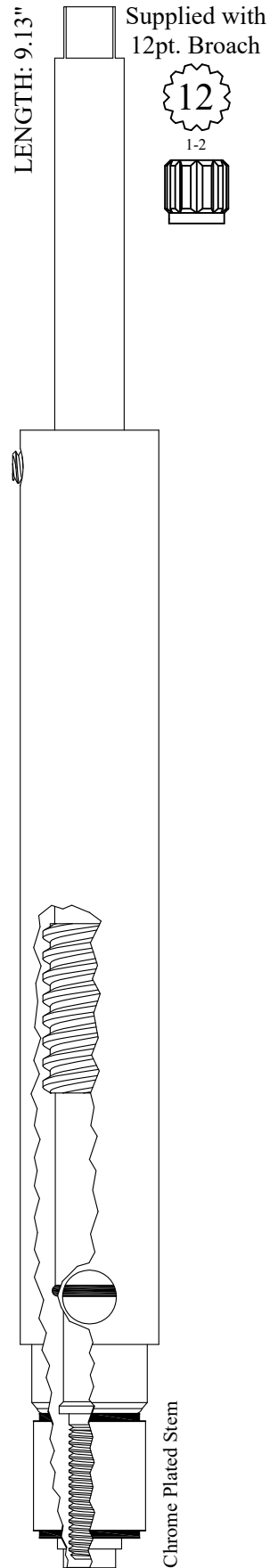

439921

FOR FIAT

Chrome Plated Unit

LENGTH: 2.61"

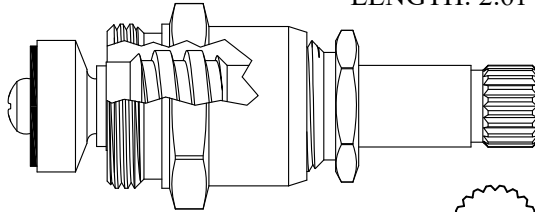

LF464201

GASKET INCLUDED: 895400
OEM # GRA-02



2-4

FOR FISHER

Chrome Plated Bonnet
Nickel Plated Stem

LENGTH: 2.25"

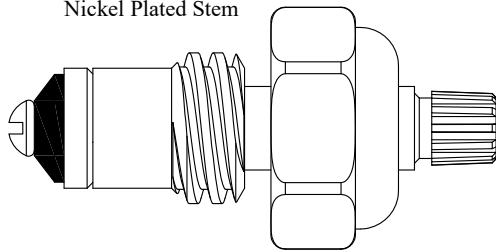

3-31

LF462201/ LF462202

LF262201/ LF262202 Stem Only

OEM # 3000-0011/ 3000-0010

Also available with handle ABRFI32601



LF462201-32601

OEM # 3000-0000

LF462202-32601

OEM # 3000-0001

Chrome Plated Bonnet
Nickel Plated Stem

LENGTH: 2.29"

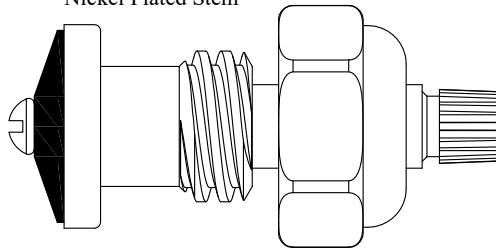

3-31

LF462221/ LF462222

LF262221/ LF262222 Stem Only

OEM # 5000-00007/ 5000-00006

Also available with handle ABRFI32601



LF462221-32601

OEM # 5000-0010

LF462222-32601

OEM # 5000-0011

Chrome Plated Bonnet
Nickel Plated Stem

LENGTH: 2.26"



SEAT USED: LF649380

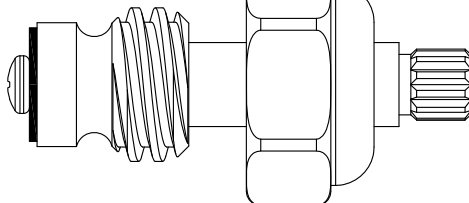

1-2

LF462031/ LF462032

LF262031/ LF262032 Stem Only

Also available with handle ABRFI32601



LF462031-32601

LF462032-32601

FOR FISHER

Also available with handle ABRFI32601

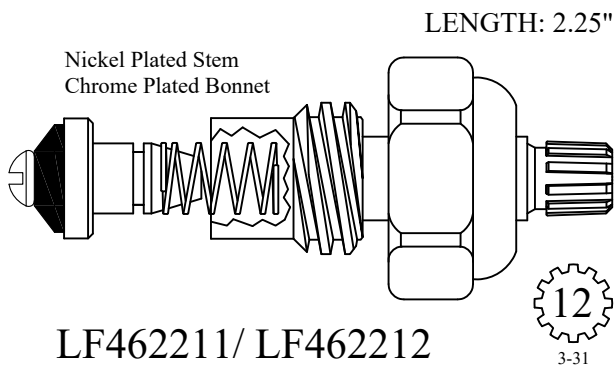

LF462211/ LF462212
LF262211/ LF262212 Stem Only
OEM # 2000-0000R/ 2000-0000L



LF462211-32601
OEM # 2000-0004
LF462212-32601
OEM # 2000-0005

Also available with handle ABRFI32601

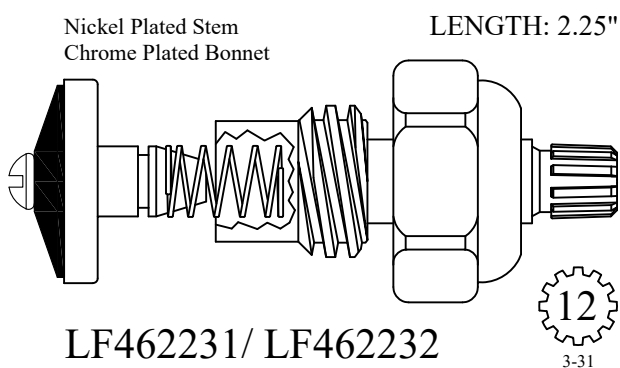

LF462231/ LF462232
LF262231/ LF262232 Stem Only



LF462231-32601
OEM # 5000-0012
LF462232-32601
OEM # 5000-0013

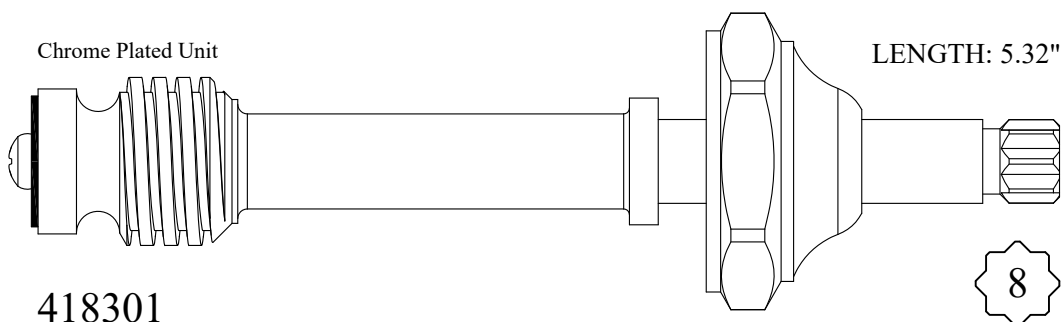

418301
218301 Stem Only

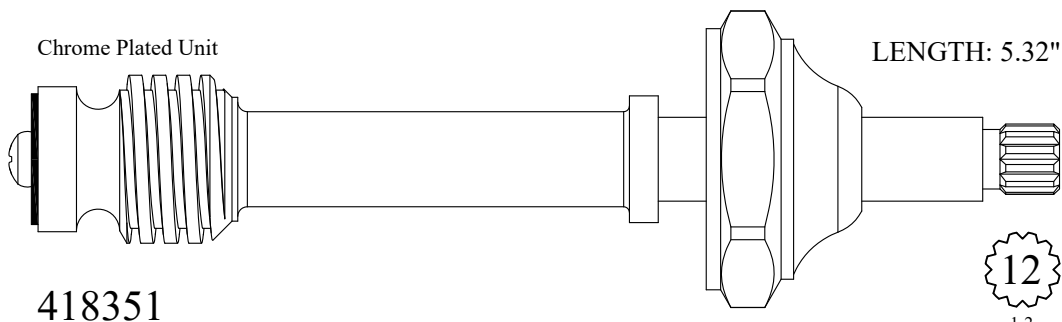

418351
218351 Stem Only

FOR FOREST

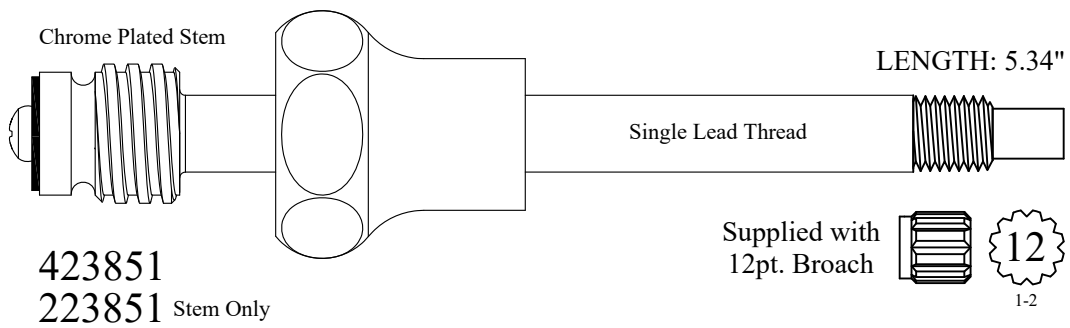
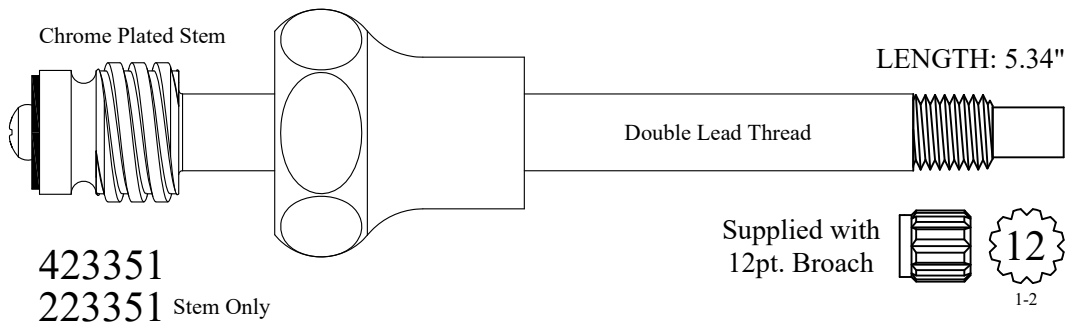
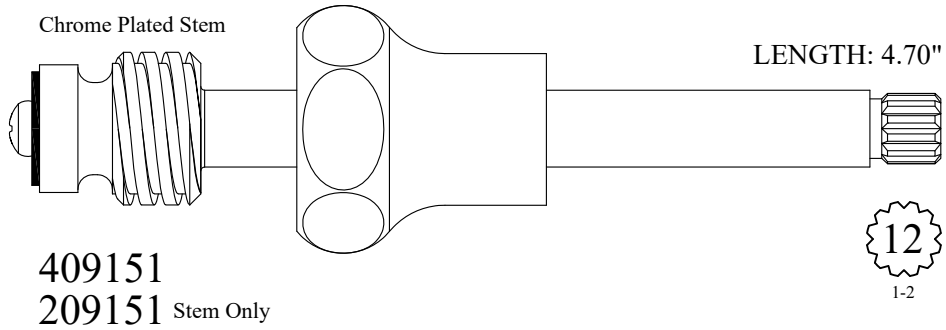

FOR GERBER

LENGTH: 1.19"

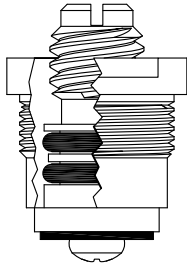

GASKET INCLUDED: 895150

400381
OEM # 98-660

LENGTH: 1.45"

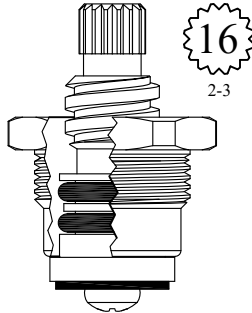

GASKET INCLUDED: 895150

LF451051
OEM # 98-682
LF451052



SEAT USED: LF649150

LENGTH: 1.45"

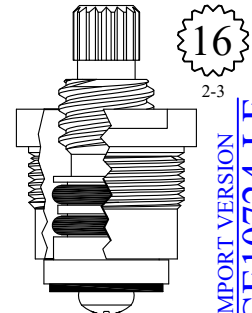

GASKET INCLUDED: 895150

LF451251
OEM # 98-688
LF451252
OEM # 98-689

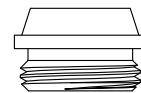

SEAT USED: LF649150

IMPORT VERSION
GE10724-LF
GE10725-LF

LENGTH: 1.65"

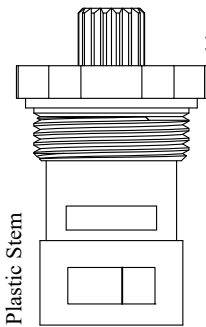

GASKET INCLUDED: 895150

LF453171
LF453172

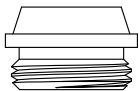

SEAT USED: LF649150

16
2-3
IMPORT VERSION
GE10726-LF
GE10727-LF

LENGTH: 1.75"

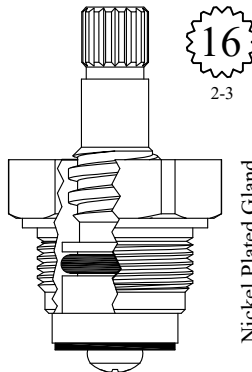

GASKET INCLUDED: 895150

LF453111
OEM # 98-684
LF453112
OEM # 98-685



SEAT USED: LF649150

Nickel Plated Gland

LENGTH: 1.83"

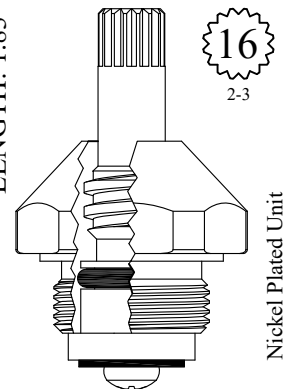

GASKET INCLUDED: 895150

LF454131
OEM # 98-680
LF454132
OEM # 98-681

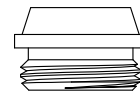

SEAT USED: LF649150

Nickel Plated Unit

FOR GERBER

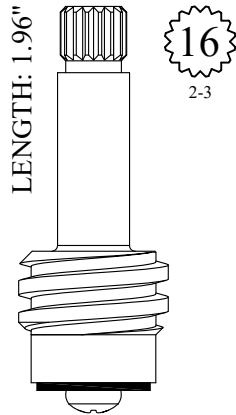

LF259021
LF259022

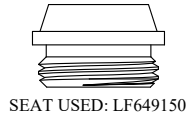

SEAT USED: LF649150

FOR DANZE / GERBER

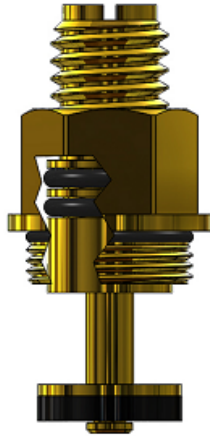

GASKET: 890180 O-RING INCLUDED

402031
OEM # DA603923

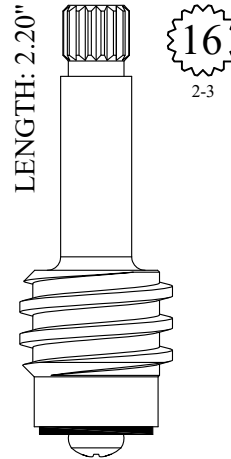

LF261111
LF261112



SEAT USED: LF649150

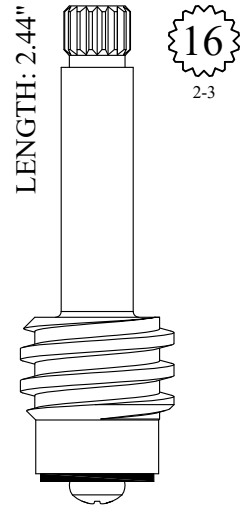

LF263121
OEM # 90-292
LF263122
OEM # 90-291

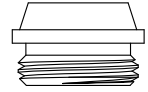

SEAT USED: LF649150

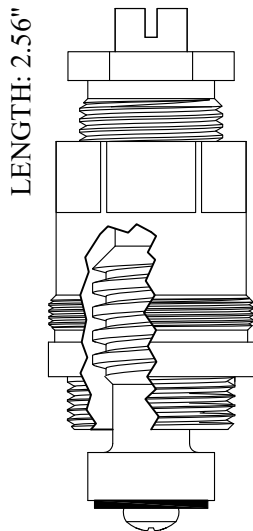

GASKET INCLUDED: 895400

401241
OEM # 98-671
201241 Stem Only

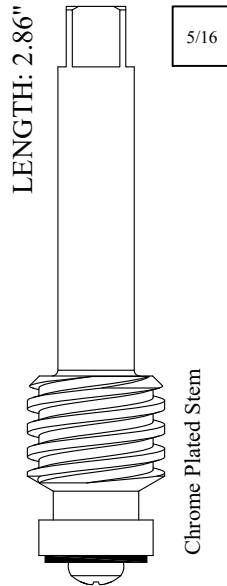

LF266211
LF266212

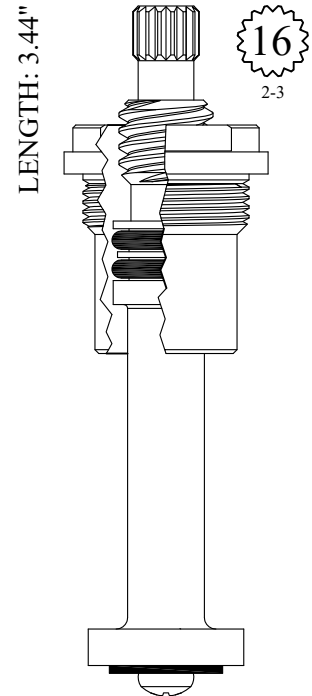

GASKET INCLUDED: 895180

402771
OEM # 98-999

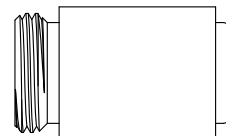

SEAT USED: LF649140

FOR GERBER

Old Style - Automatic

LENGTH: 3.59"

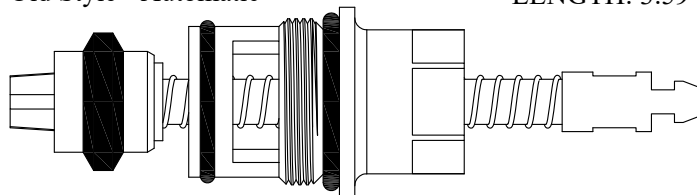

430790

GASKET: 894120 O-RING INCLUDED

Old Style - Automatic with Brass Link

LENGTH: 3.76"

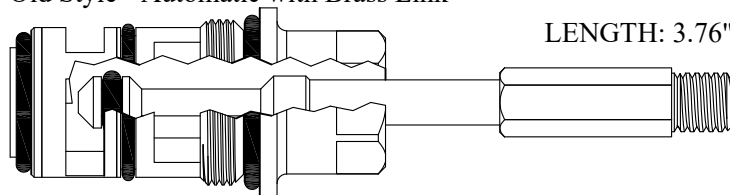

430850

GASKET: 894120 O-RING INCLUDED

New Style - Manual

LENGTH: 4.09"

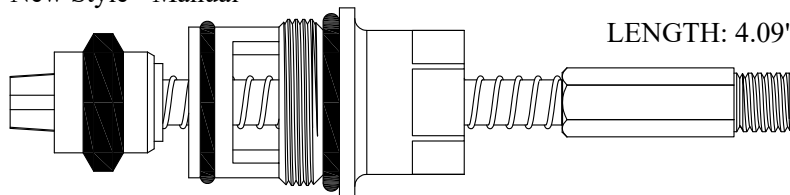

431130

GASKET: 894120 O-RING INCLUDED

Chrome Plated
Handle & Sleeve Available
128540

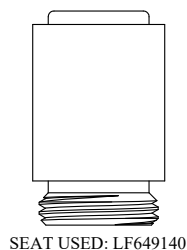
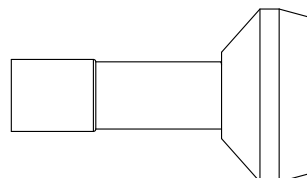

SEAT USED: LF649140

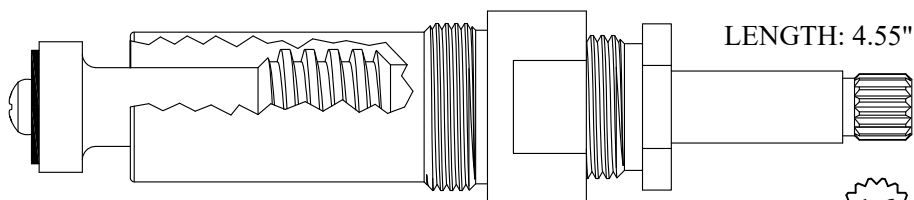

LENGTH: 4.55"

LF473041/ LF473042

GASKET INCLUDED: 895180

OEM # 98-770

LF273041/ LF273042 Stem Only

OEM # 96-400

16
2-3

FOR GERBER

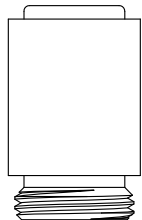

SEAT USED: LF649140

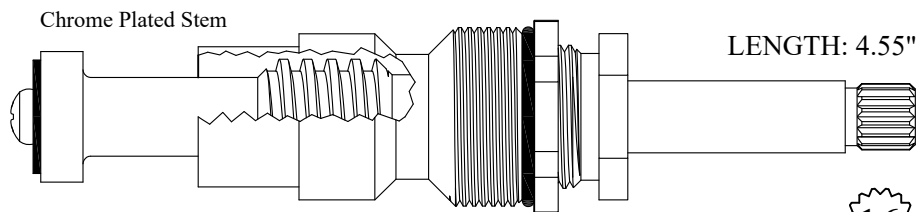

Chrome Plated Stem

LENGTH: 4.55"

16

2-3

LF477021/ LF477022

GASKET: 890190 O-RING INCLUDED

LF277021/ LF277022 Stem Only

OEM # 96-408/ 96-409

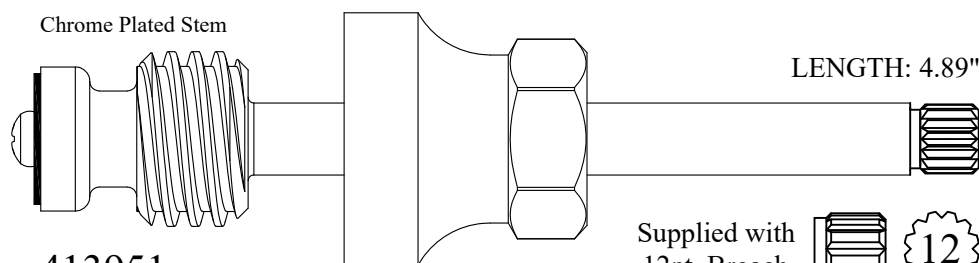

Chrome Plated Stem

LENGTH: 4.89"

Supplied with
12pt. Broach



12

1-2

413951

213951 Stem Only

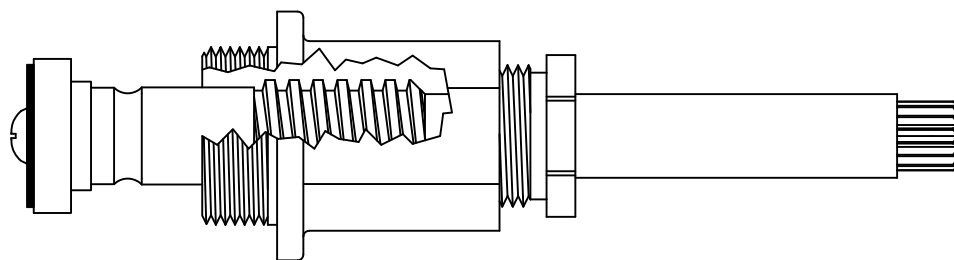

Old Style, Use 413601

OEM # 98-677

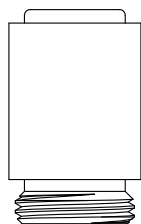

SEAT USED: LF649140

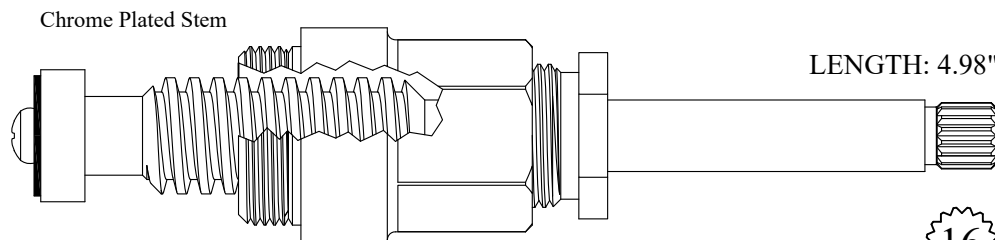

Chrome Plated Stem

LENGTH: 4.98"

16

2-3

413601

GASKET INCLUDED: 895370

213601 Stem Only

FOR GERBER

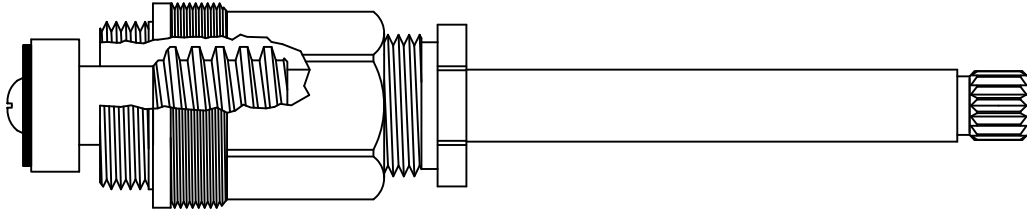

Old Style, Use 413301 or 413301-CP

Also available with chrome plated stem

413301-CP

LENGTH: 5.25"



SEAT USED: LF649150

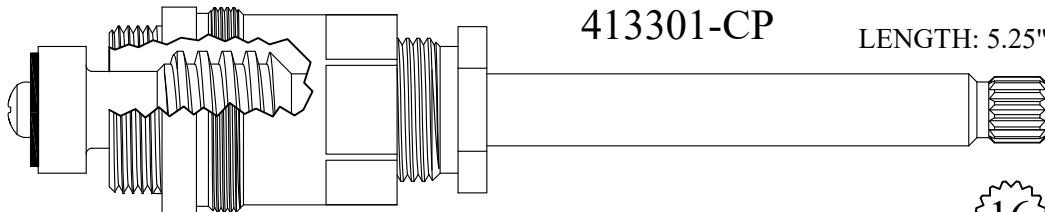

413301/ 413302

GASKET INCLUDED: 895400

OEM # 98-673/ 98-674

213301/ 213302 Stem Only

OEM # 98-710

IMPORT VERSION

GE20778B/ GE20781

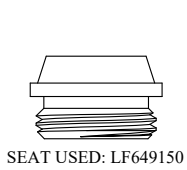

SEAT USED: LF649150

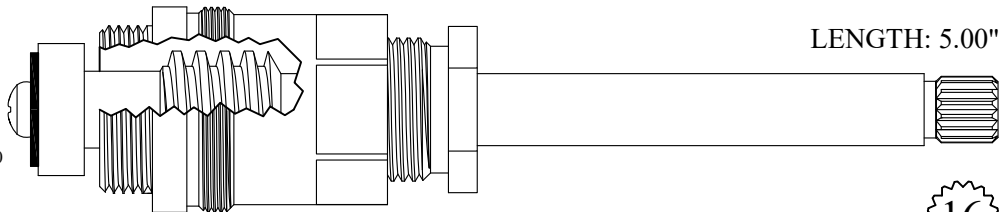

LENGTH: 5.00"

413311/ 413312

GASKET INCLUDED: 895400

OEM # 98-672

213311/ 213312 Stem Only

Also available with chrome plated stem

413311-CP/ 413312-CP

213311-CP/ 213312-CP Stem Only



Chrome Plated Stem

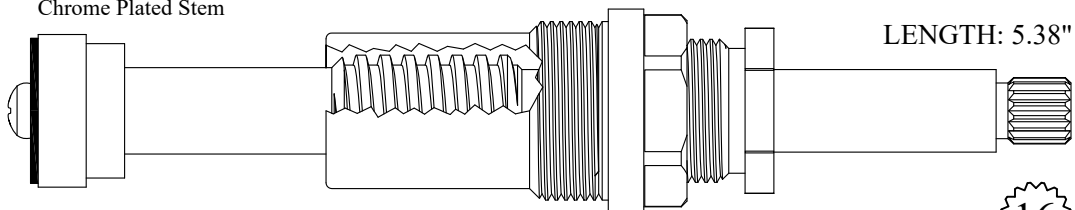

LENGTH: 5.38"

418911

GASKET INCLUDED: 895300

218911 Stem Only



FOR GERBER

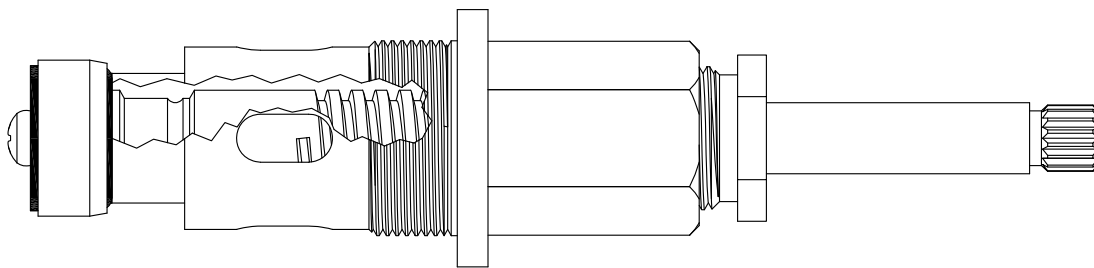
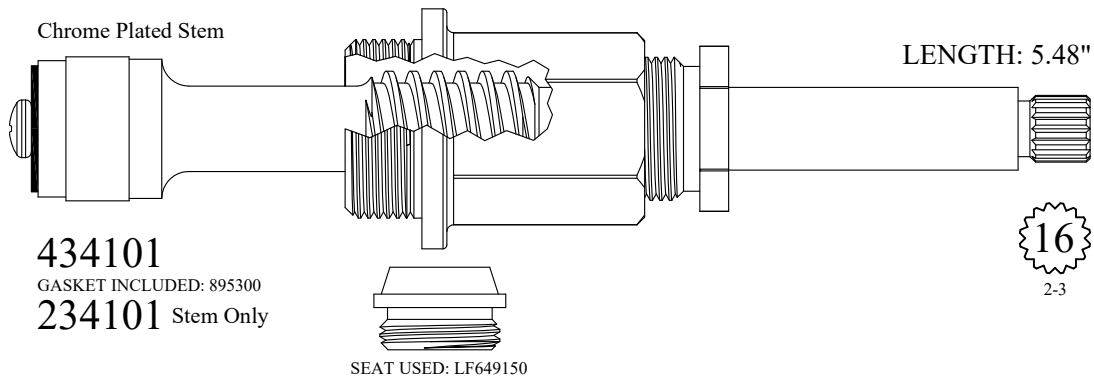
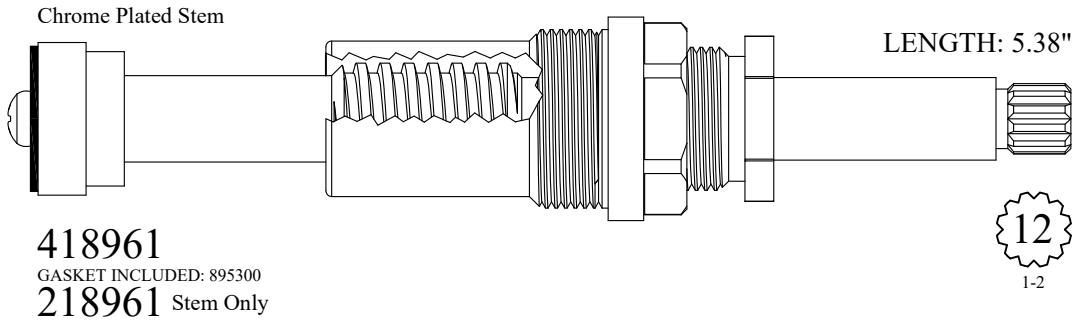

Old Style, Use 434401 or 236411 stem only

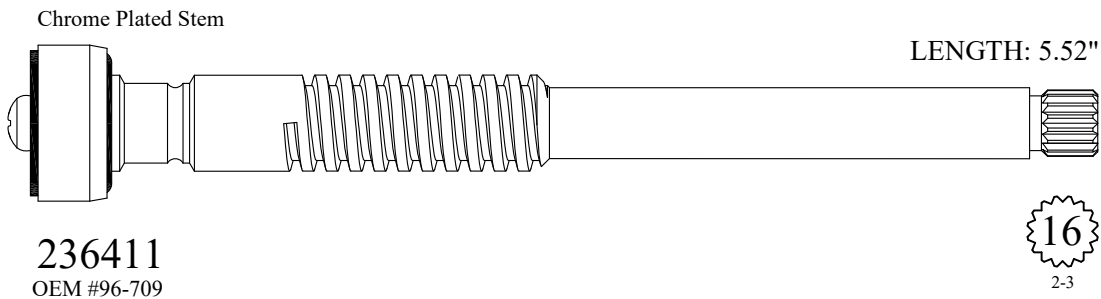

FOR GERBER

Chrome Plated Stem

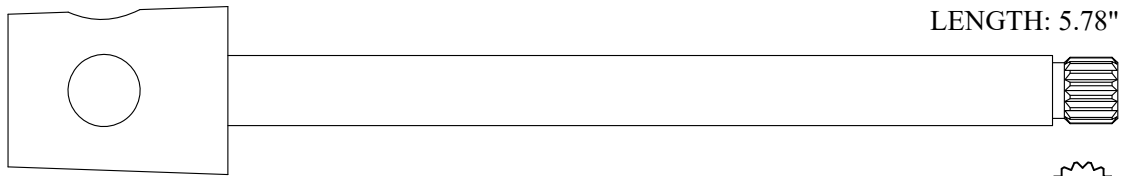

LENGTH: 5.78"

235900

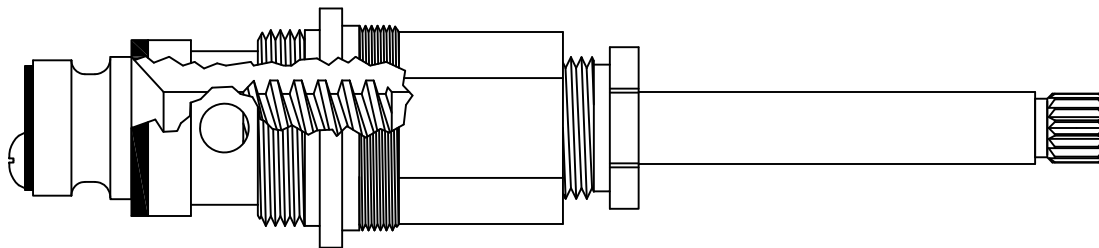

Old Style, Use 433401

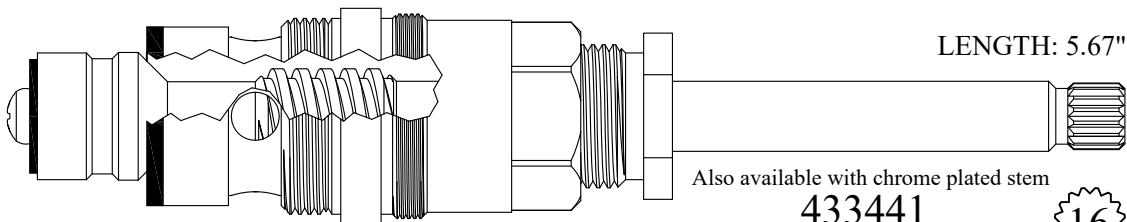

LENGTH: 5.67"

Also available with chrome plated stem

433441



433401

GASKET INCLUDED: 895560

OEM # 96-230 / 98-726

233401 Stem Only

OEM # 97-432 or 96-290

IMPORT VERSION
GE20779

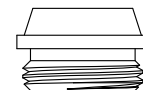

SEAT USED: LF649150

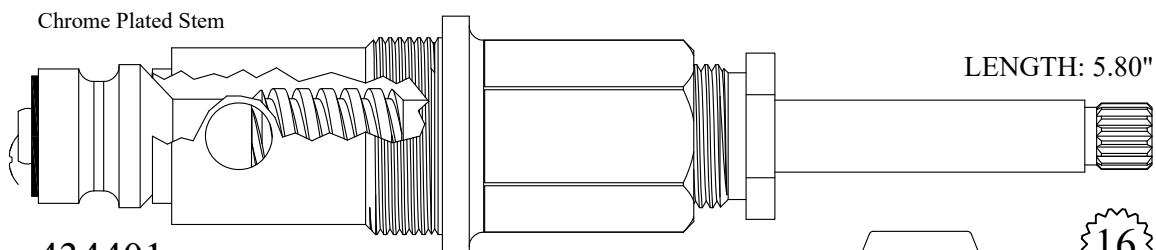

Chrome Plated Stem

LENGTH: 5.80"

434401

GASKET INCLUDED: 895560

234401 Stem Only

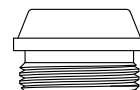

SEAT USED: 649860



FOR GERBER

Chrome Plated Stem

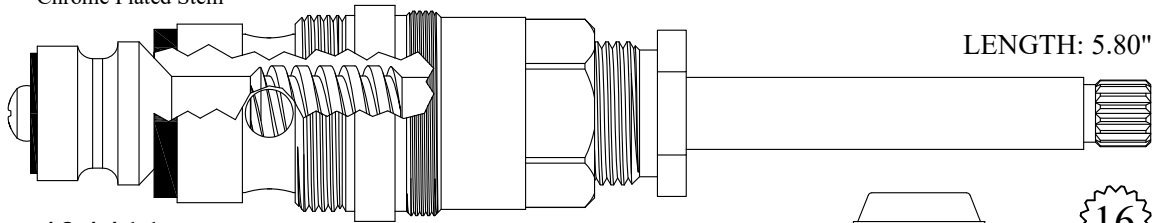

LENGTH: 5.80"

434411

GASKET INCLUDED: 895560
OEM # 98-720

234401 Stem Only

OEM # 98-709

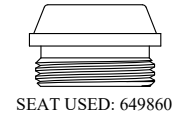

SEAT USED: 649860

16

2-3

Chrome Plated Stem

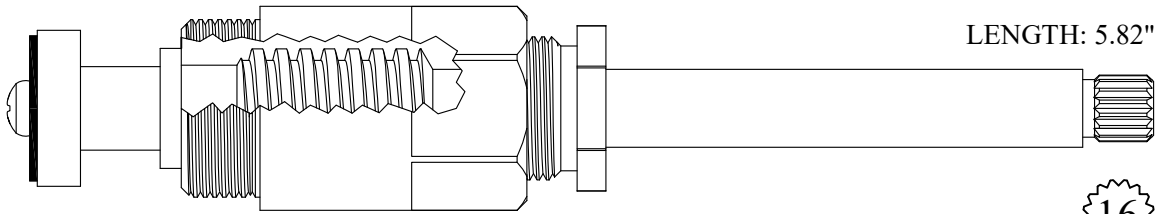

LENGTH: 5.82"

424411

GASKET INCLUDED: 895400

224411 Stem Only

16

2-3

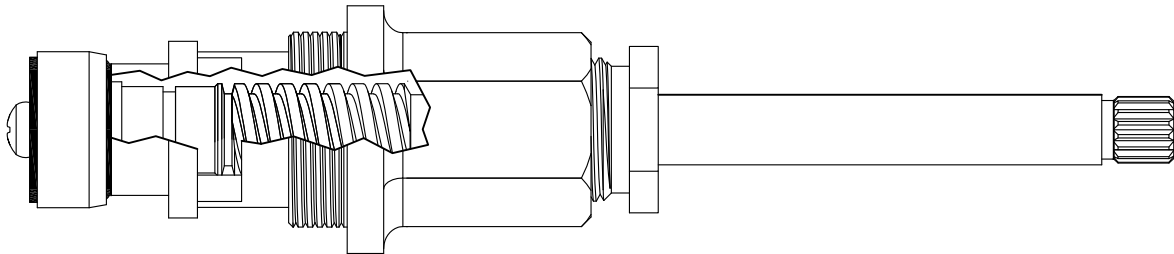

Old Style, Use 433441 or 236401 stem only

Chrome Plated Stem

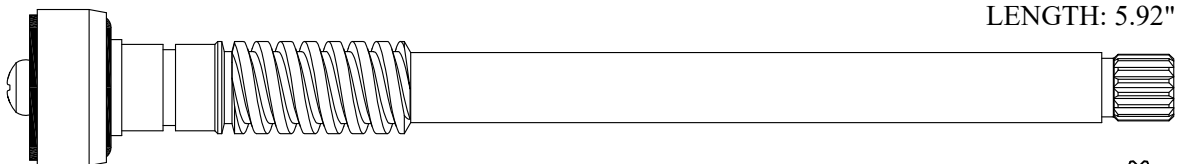

LENGTH: 5.92"

236401

16

2-3

Chrome Plated Stem

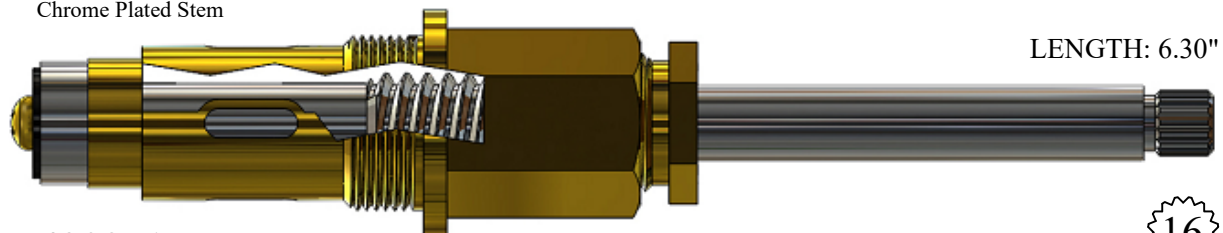

LENGTH: 6.30"

439271

GASKET INCLUDED: 895570

239271 Stem Only

16

2-3

FOR GLACIER BAY

LENGTH: 1.58"

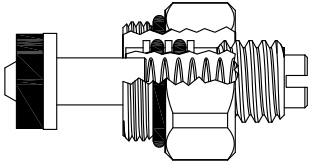

400231

GASKET: 890150 O-RING INCLUDED

1300DIVBOOT



Replacement Boot Only

STEM LENGTH: 2.92"



1300DIVERTER

Complete Diverter with Black Rubber Boot

1300DIV

Diverter WITHOUT Boot



LENGTH: 4.72"



GB10654

OEM # RP22018



LENGTH: 5.28"



GB10655

OEM # RP70620



FOR GLAUBER SALTER

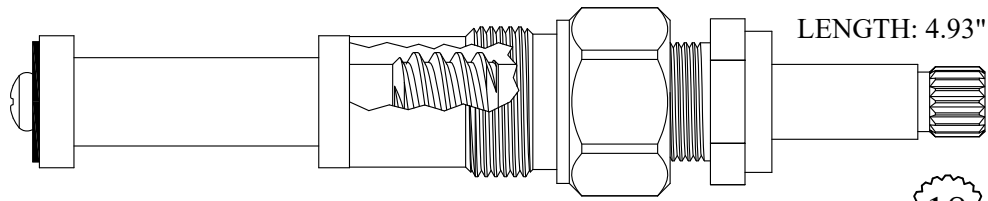

LENGTH: 4.93"

LF476501
LF276501 Stem Only

18
3-3

Chrome Plated Stem

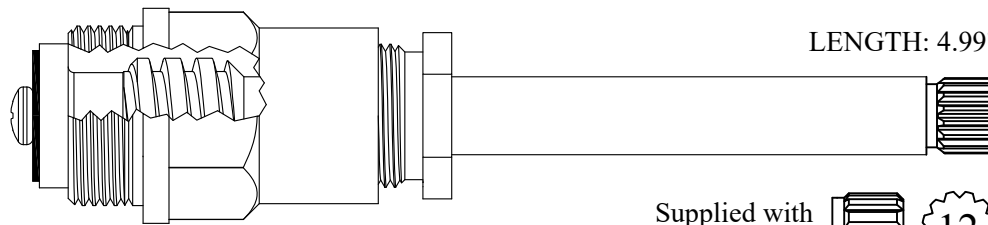

LENGTH: 4.99"

412451
GASKET INCLUDED: 895370
212451 Stem Only

Supplied with
12pt. Broach



12
1-2

Chrome Plated Stem

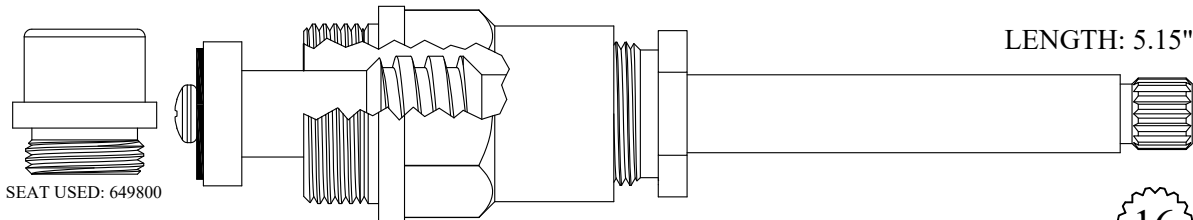

LENGTH: 5.15"

SEAT USED: 649800

415001
GASKET INCLUDED: 895370
215001 Stem Only

16
1-6

Chrome Plated Stem

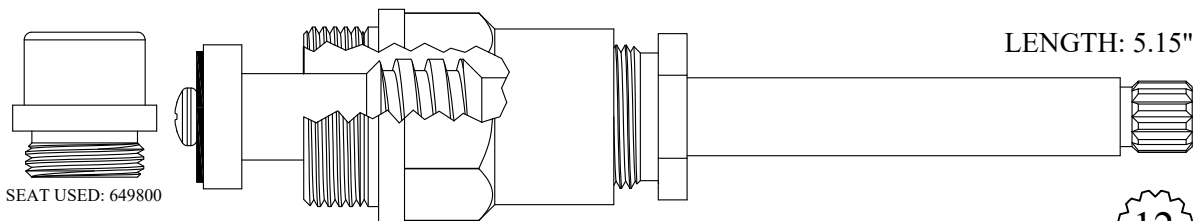

LENGTH: 5.15"

SEAT USED: 649800

415051
GASKET INCLUDED: 895370
215051 Stem Only

12
1-2

FOR GLAUBER SALTER

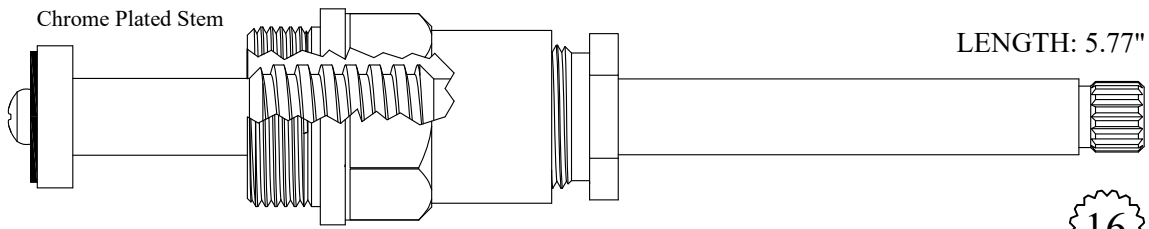

424701
GASKET INCLUDED: 895370
224701 Stem Only

16
1-6

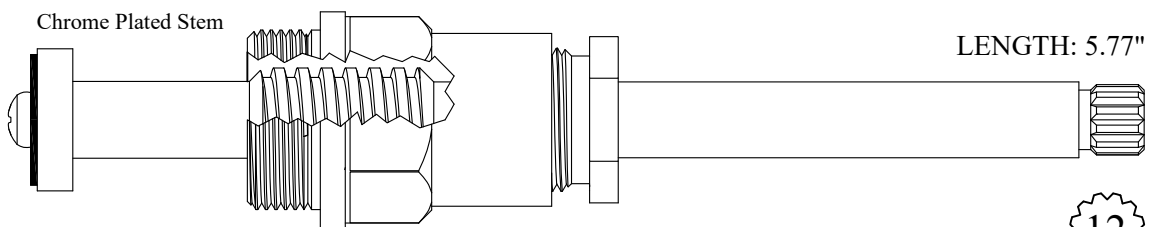

424751
GASKET INCLUDED: 895370
224751 Stem Only

12
1-2

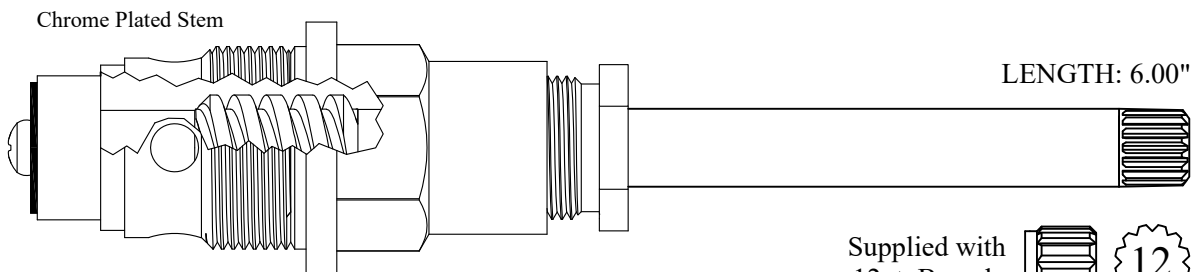

437451
GASKET INCLUDED: 895440
237451 Stem Only

Supplied with
12pt. Broach  12
1-2

BARRY E.  SR. CO.

FOR GLAUBER WEST COAST

STEM LENGTH: 3.65"

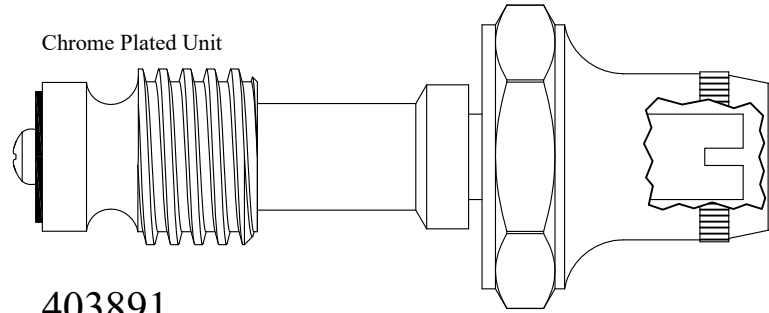

403891

203891 Stem Only

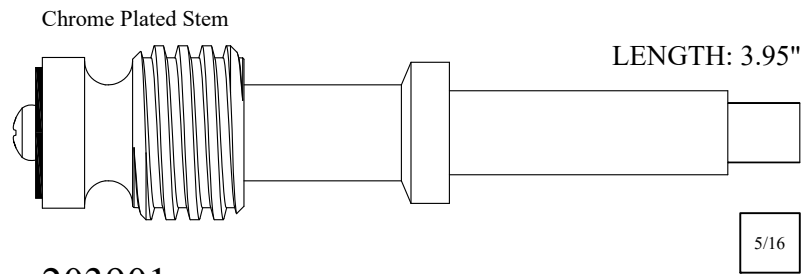

203901

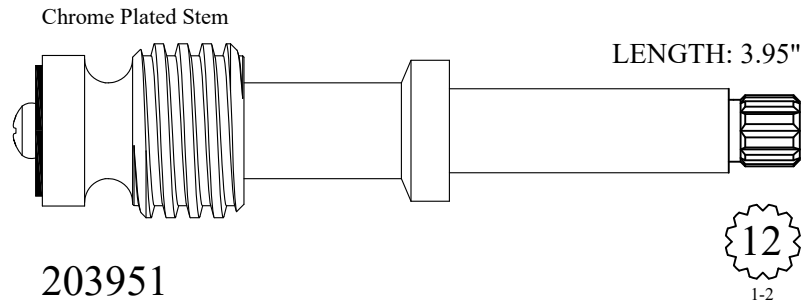

203951

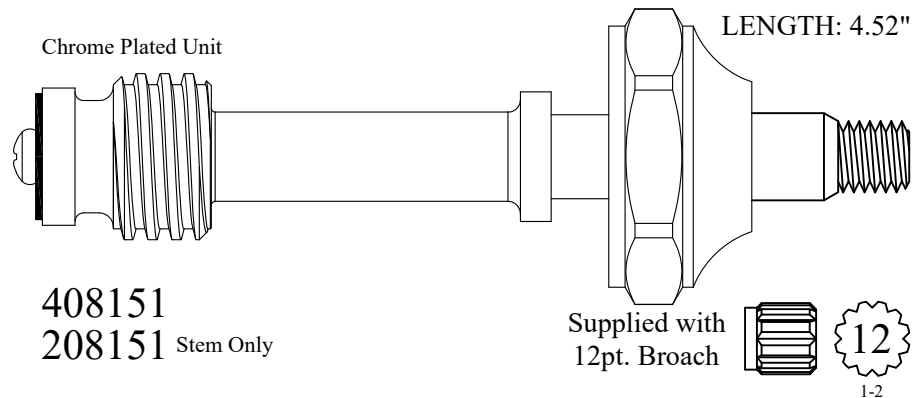

408151

208151 Stem Only

FOR GLAUBER WEST COAST

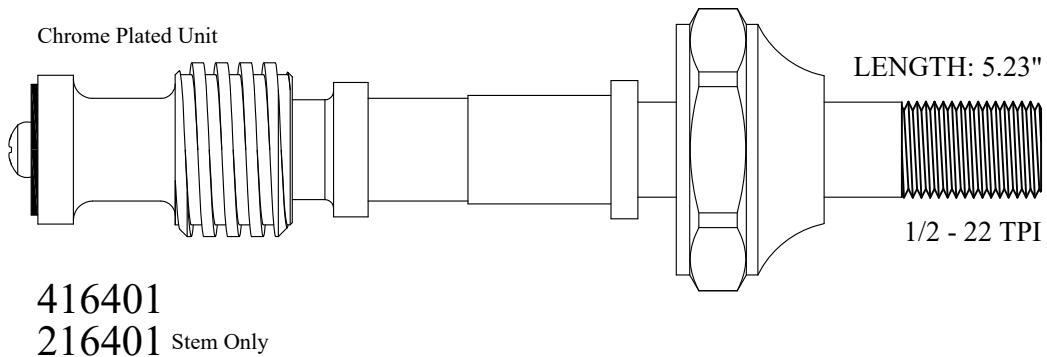
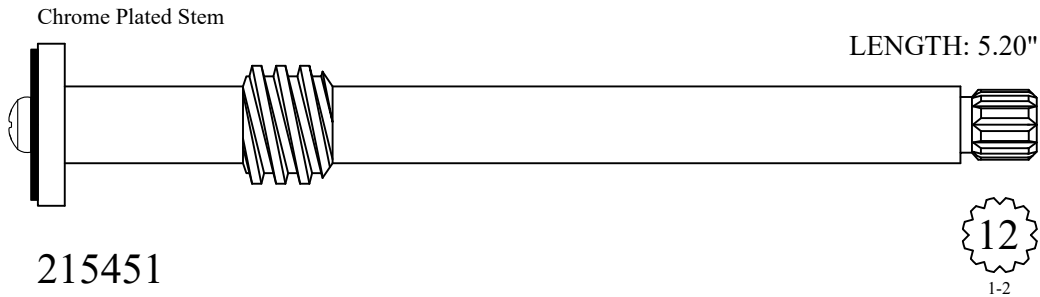
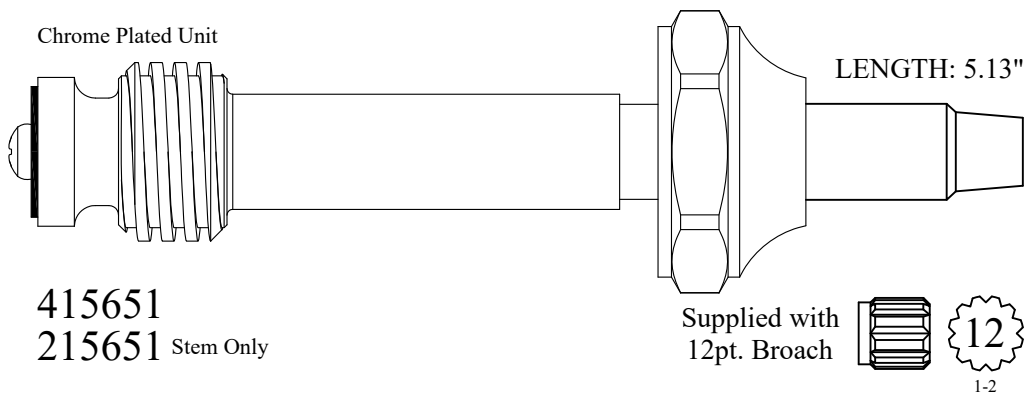
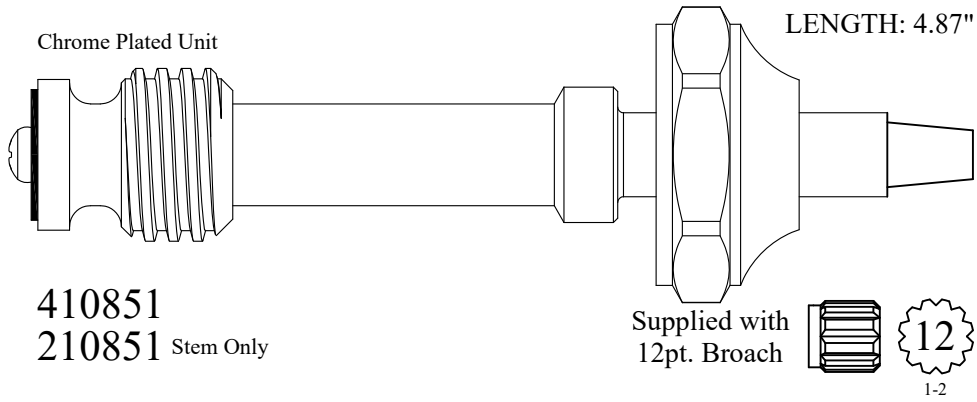

FOR GLAUBER WEST COAST

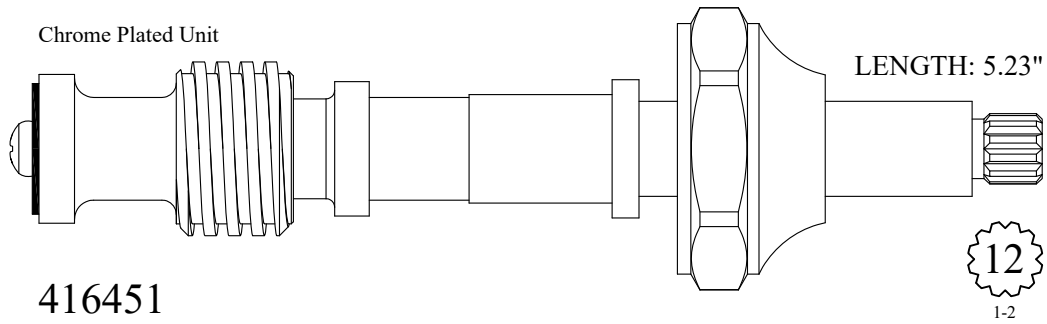

416451
216451 Stem Only

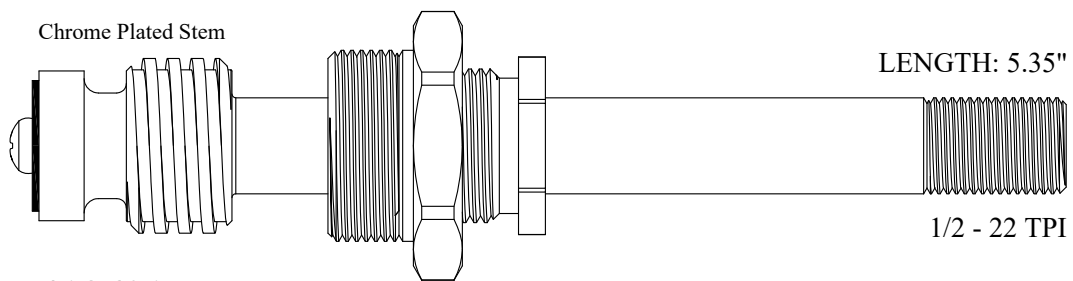

418601
GASKET INCLUDED: 895570
218601 Stem Only

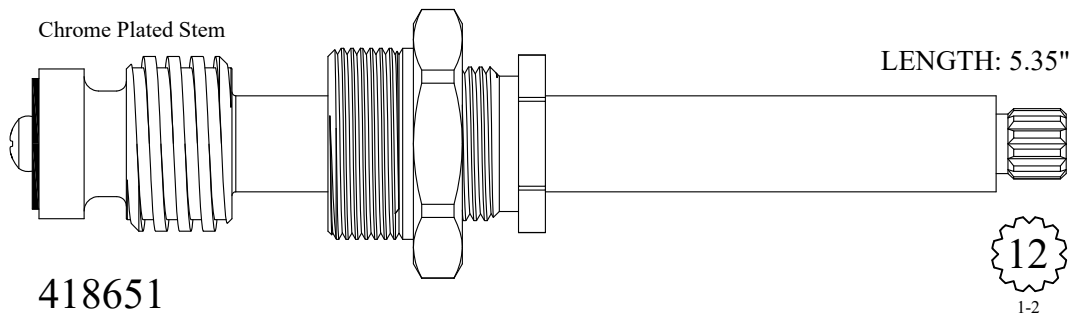

418651
GASKET INCLUDED: 895570
218651 Stem Only

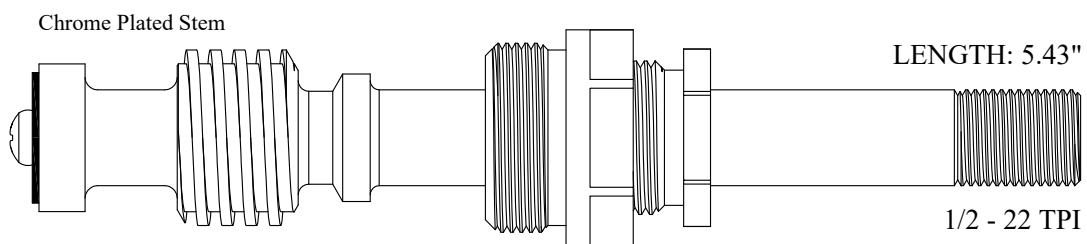

422401
GASKET INCLUDED: 895550
222401 Stem Only

FOR GLAUBER WEST COAST

Chrome Plated Stem

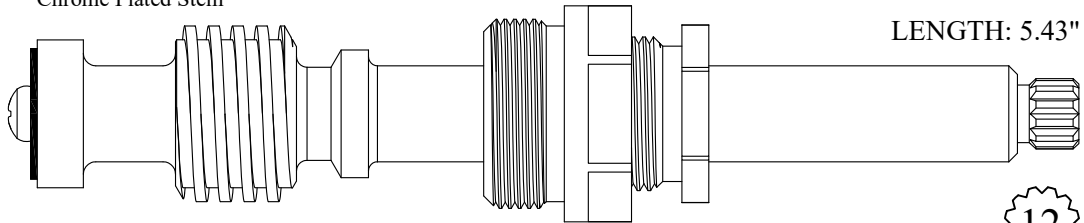

LENGTH: 5.43"

422451

GASKET INCLUDED: 895550

222451 Stem Only



1-2

Chrome Plated Stem

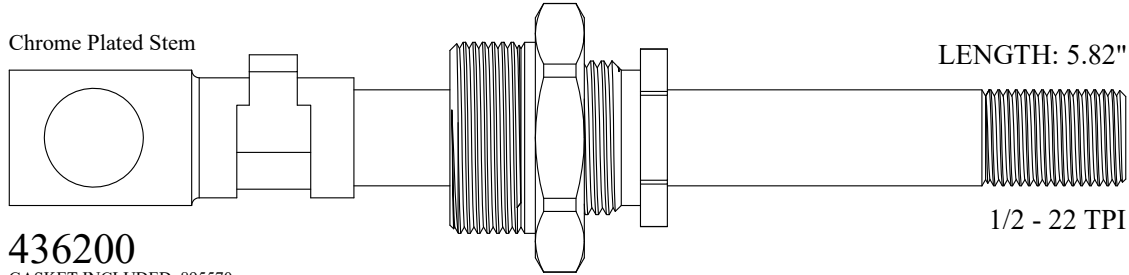

LENGTH: 5.82"

436200

GASKET INCLUDED: 895570

236200 Stem Only

1/2 - 22 TPI

Chrome Plated Stem

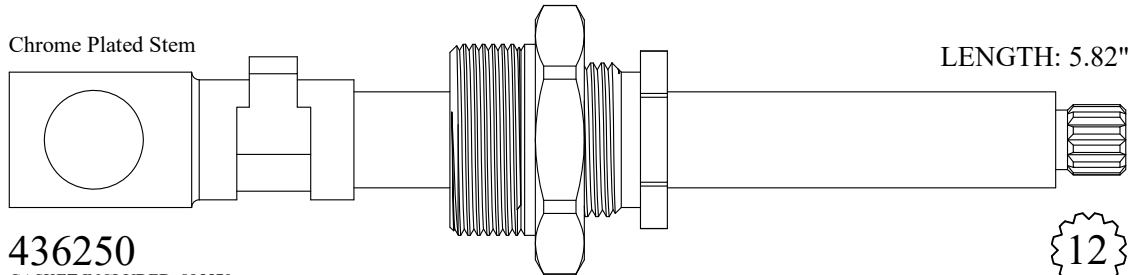

LENGTH: 5.82"

436250

GASKET INCLUDED: 895570

236250 Stem Only



1-2

Chrome Plated Stem

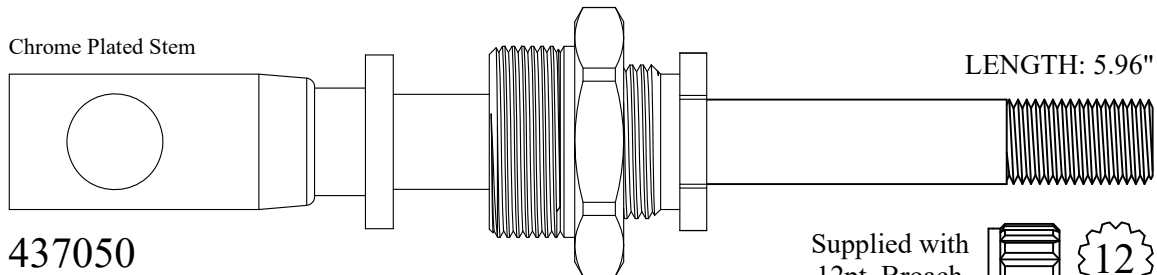

LENGTH: 5.96"

437050

GASKET INCLUDED: 895570

237050 Stem Only

Supplied with
12pt. Broach



1-2

Chrome Plated Stem

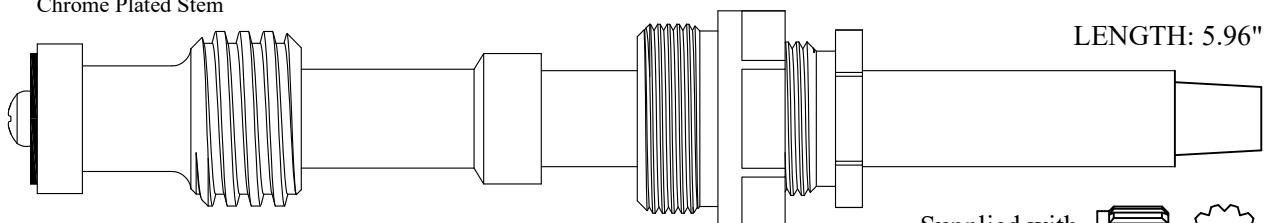

LENGTH: 5.96"

424351

GASKET INCLUDED: 895550

224351 Stem Only

Supplied with
12pt. Broach



1-2

FOR GOETZ

Chrome Plated Unit

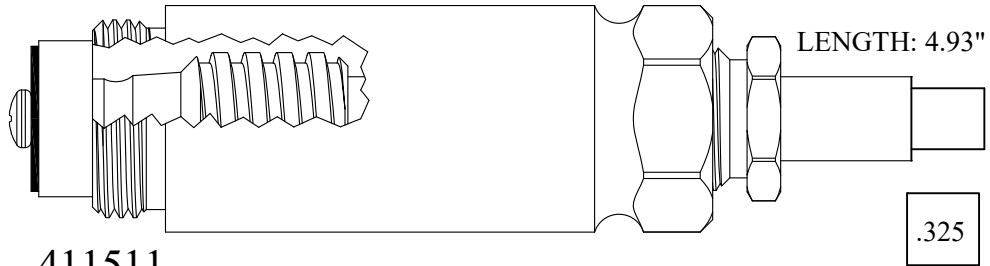

411511

GASKET INCLUDED: 895560

211221 Stem Only

Chrome Plated Unit

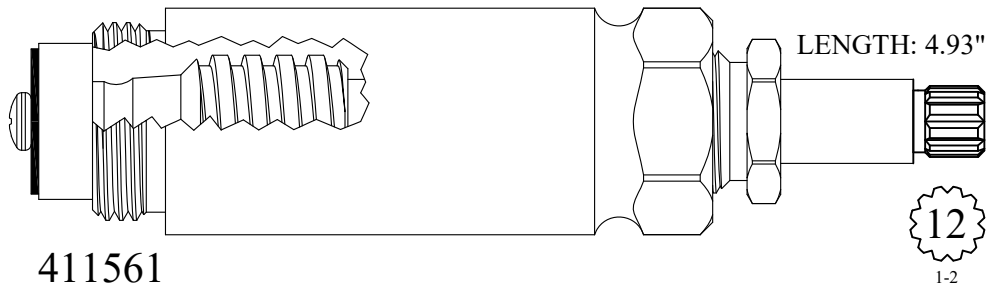

411561

GASKET INCLUDED: 895560

211551 Stem Only

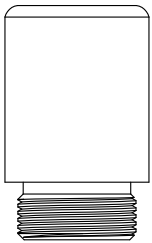

SEAT USED: 648920

Chrome Plated Stem

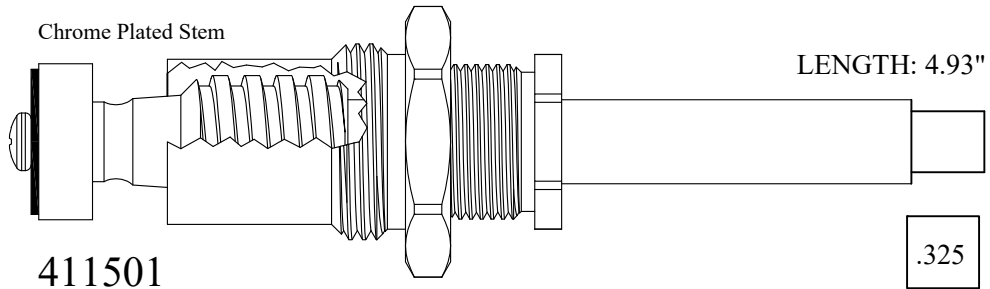

411501

GASKET INCLUDED: 895560

212221 Stem Only

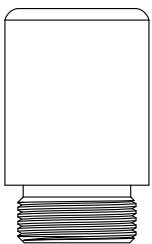

SEAT USED: 648920

Chrome Plated Stem

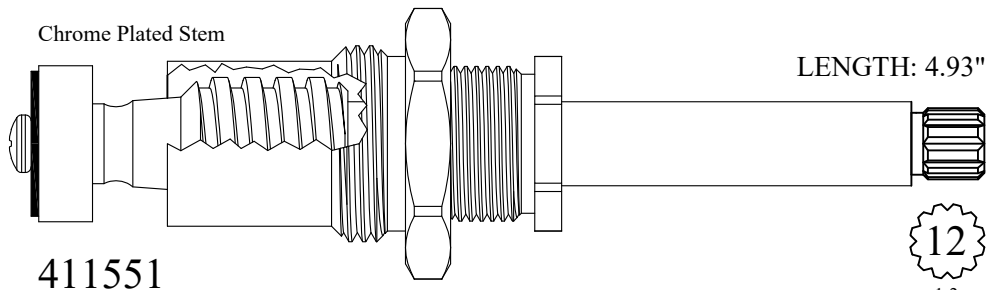

411551

GASKET INCLUDED: 895560

211551 Stem Only

FOR GOETZ

Chrome Plated Unit

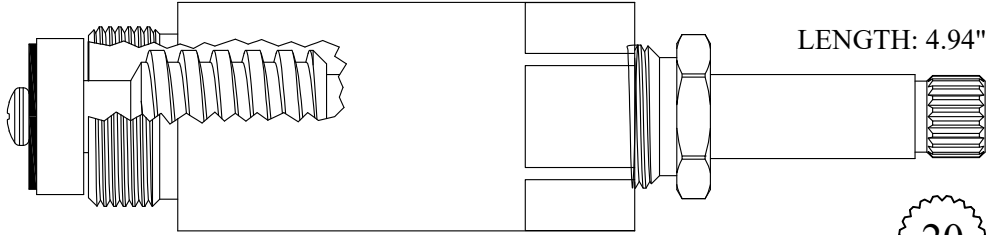

LENGTH: 4.94"



412211
GASKET INCLUDED: 895370
212211 Stem Only

Chrome Plated Unit

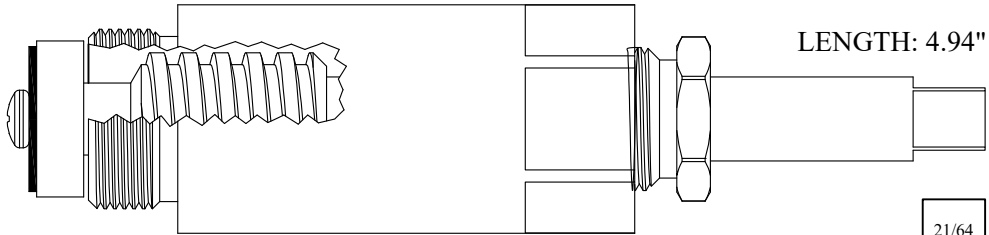

LENGTH: 4.94"



412221
GASKET INCLUDED: 895370
212221 Stem Only

Chrome Plated Stem

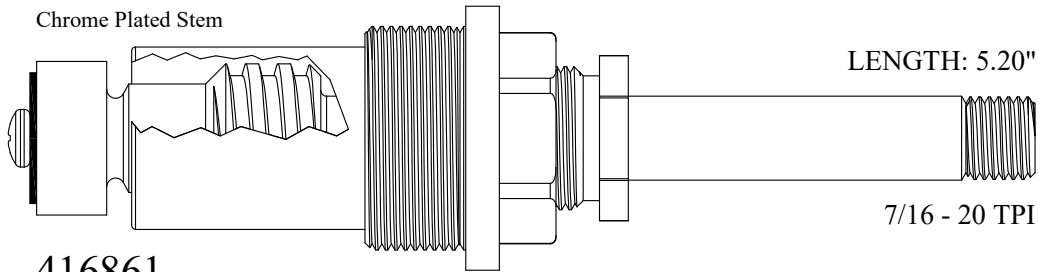

LENGTH: 5.20"

7/16 - 20 TPI

416861
GASKET INCLUDED: 895450
216861 Stem Only

FOR GRAND HAVEN

LENGTH: 1.19"

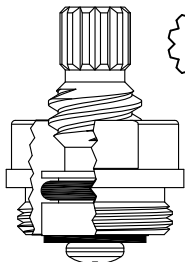

SEAT USED:
LF649270

GASKET INCLUDED: 895160

LF450021

LENGTH: 1.56"

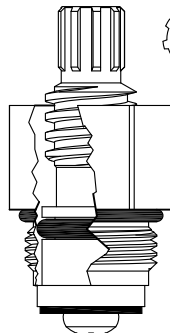

Chrome Plated Gland

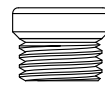

SEAT USED:
LF649050

GASKET: 890160 O-RING INCLUDED

LF452861

LENGTH: 1.81"

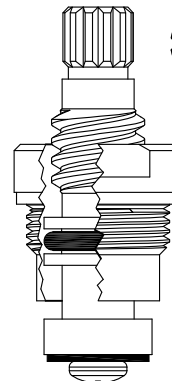

SEAT USED:
LF649270

GASKET INCLUDED: 895100

LF456071
LF456072

FOR GRAND HAVEN

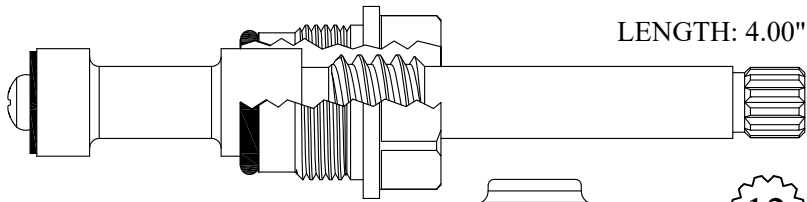

404121

GASKET INCLUDED: 895150

SEAT USED: LF649270

12
1-2

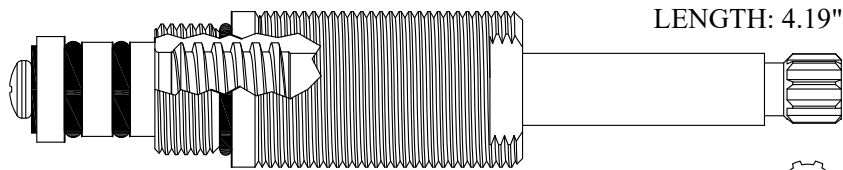

405011

GASKET: 890150 O-RING INCLUDED

SEAT USED: LF649050

9

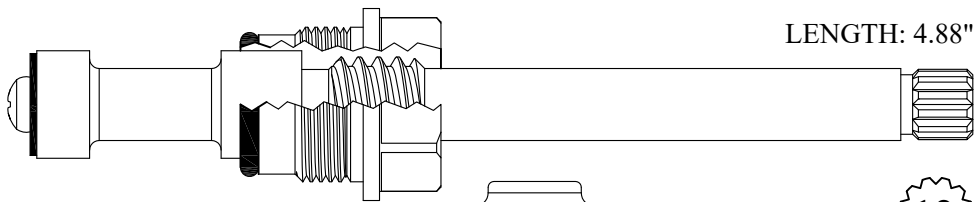

410761

GASKET INCLUDED: 895150

SEAT USED: LF649270

12
1-2

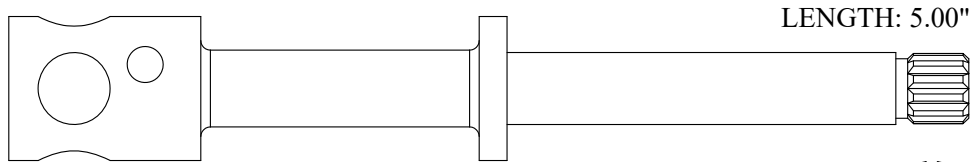

232220

12
1-2

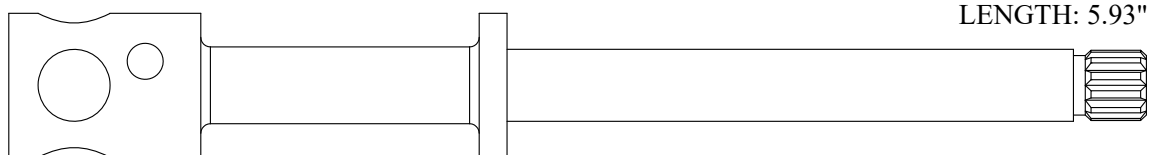

236310

12
1-2

FOR GROHE

FOR GROHE



GASKET: 891160 O-RING INCLUDED

142790
OEM # 08.213

LENGTH: 1.94"

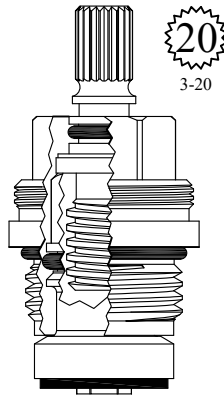

20
3-20

GASKET: 890170 O-RING INCLUDED

457282
OEM # 07.146



SEAT USED: LF647580

LENGTH: 2.15"

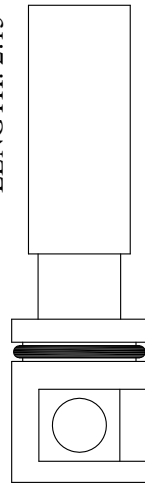

230650
OEM # 47.621

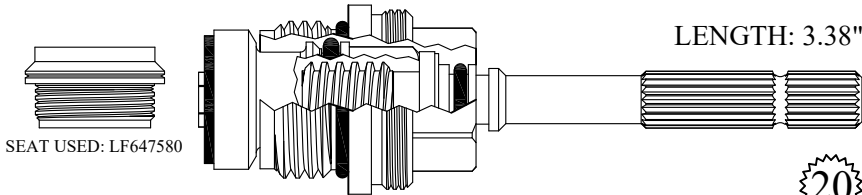

LENGTH: 3.38"

SEAT USED: LF647580

20
3-20

402642

GASKET: 890170 O-RING INCLUDED
OEM # 7.147

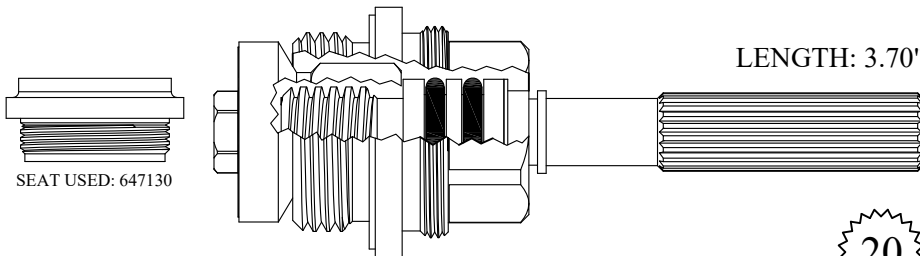

LENGTH: 3.70"

SEAT USED: 647130

20
3-32

402892

GASKET: 895440 INCLUDED
OEM # 7.151

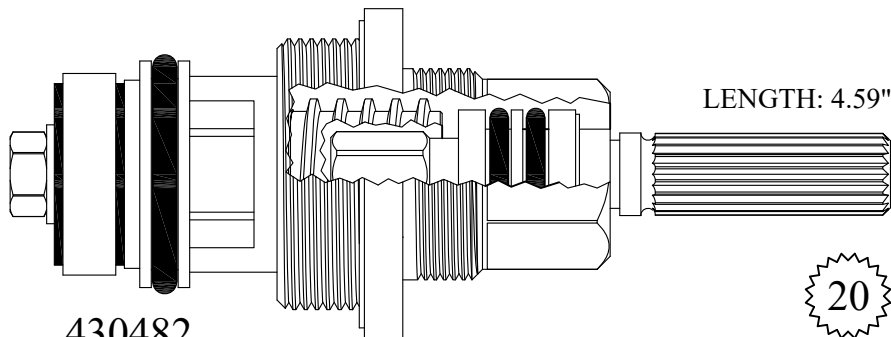

LENGTH: 4.59"

20
3-32

430482

GASKET: 895520 INCLUDED
OEM # 6.188

FOR GROHE

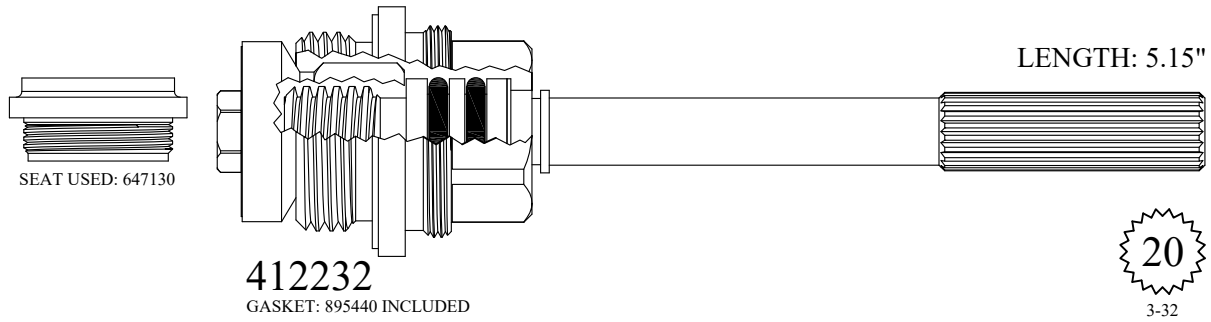

FOR HAJOCA

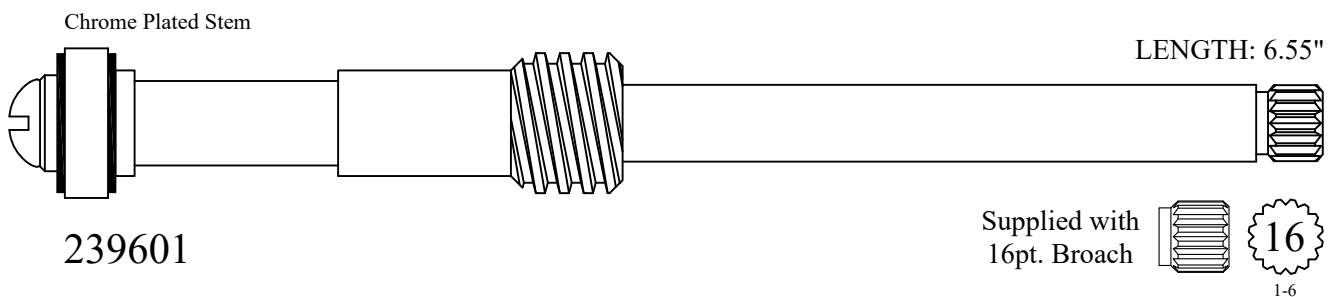
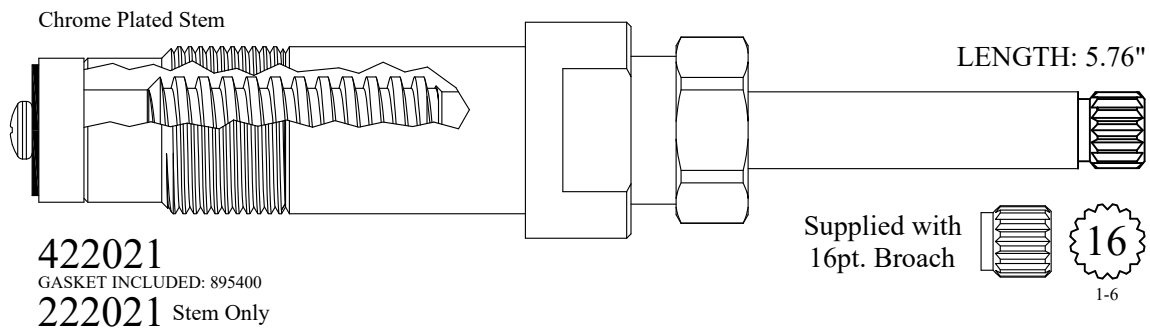
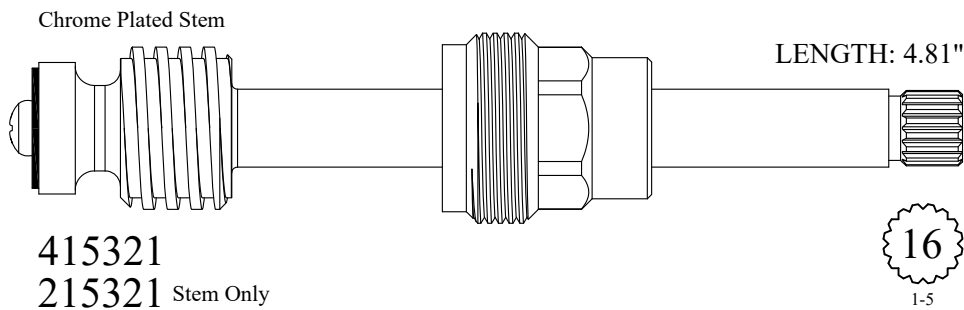
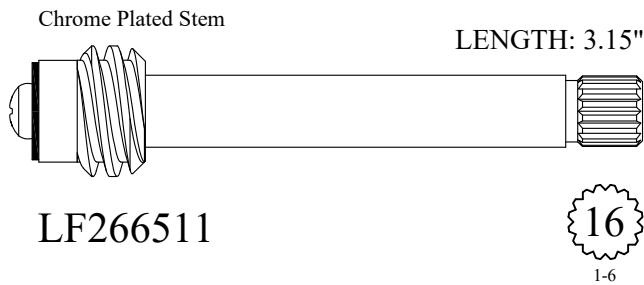

FOR **HALSEY TAYLOR**

LENGTH: 3.15"



LF463670
OEM # 60-08240-51-640

Send Your Orders To:

BARRY E.  SR. CO.

E-mail: orderdesk@barrywalter.com

Fax: 1.800.886.9831

Phone: 1.800.767.5552

FOR HARCRAFT

LENGTH: 1.45"

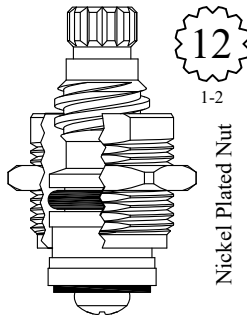

Nickel Plated Nut

GASKET INCLUDED: 895040

LF451101
OEM # 3247

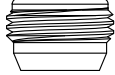

SEAT USED: LF648670

LENGTH: 1.45"

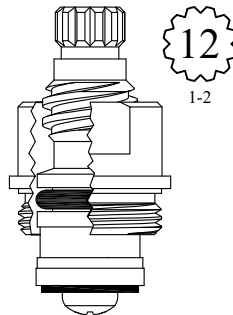

GASKET INCLUDED: 895100

LF451241
OEM # 3128
LF451242
OEM # 3129

LENGTH: 1.67"

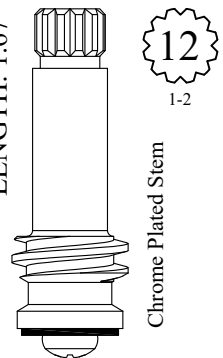

Chrome Plated Stem

LF254021
LF254022

LENGTH: 1.90"

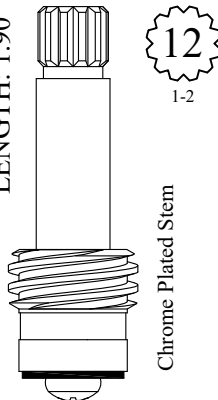

Chrome Plated Stem

LF257111
LF257112

LENGTH: 2.34"

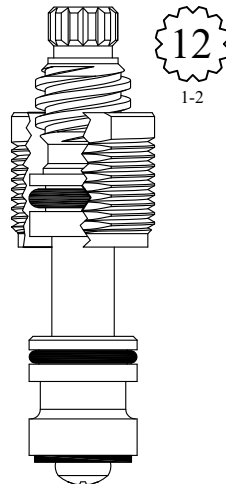

GASKET INCLUDED: 895040

LF462091
OEM # 3467

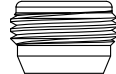

SEAT USED: LF648670

LENGTH: 2.44"

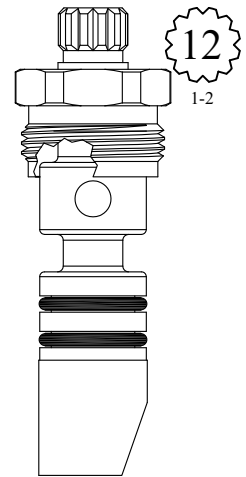

430040
OEM # 3502
230040 Stem Only
OEM # 7454

FOR HARCRAFT

LENGTH: 2.52"

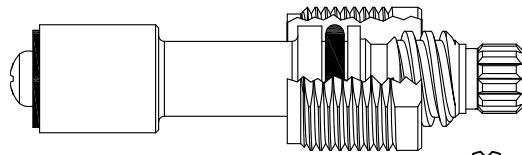

LF464021
GASKET INCLUDED: 895040
OEM # 3254



LENGTH: 2.98"

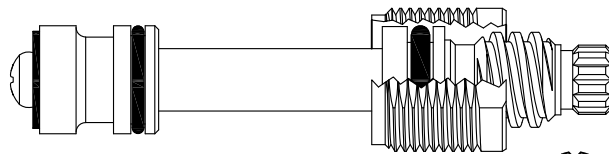

LF465411
GASKET INCLUDED: 895040



LENGTH: 3.45"

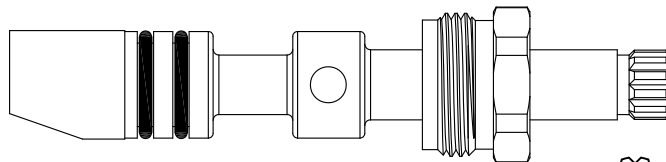

430140
230140 Stem Only



LENGTH: 3.46"

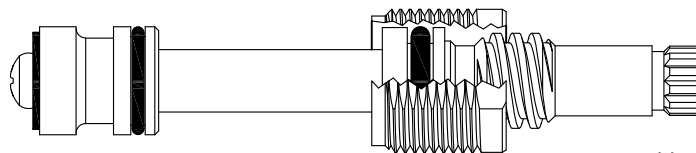
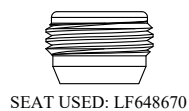

LF466131
GASKET INCLUDED: 895040
OEM # 3593
LF266131 Stem Only
OEM # 7176



FOR HARCRAFT

Chrome Plated Stem

LENGTH: 3.88"

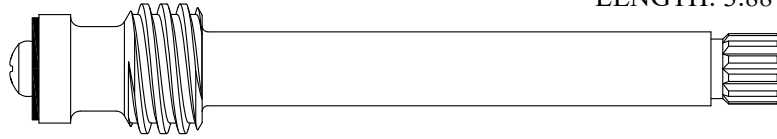

LF270011/ LF270012

OEM # 3023/ 3022

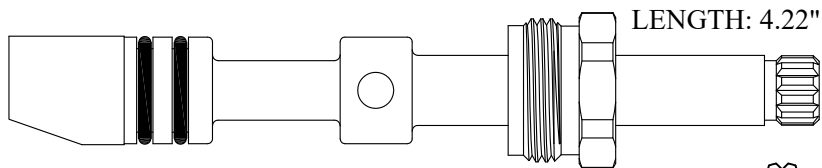

LENGTH: 4.22"

430200

OEM # 3420

230200 Stem Only

OEM # 7217

IMPORT VERSION
HA20834

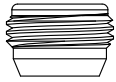

SEAT USED: LF648670

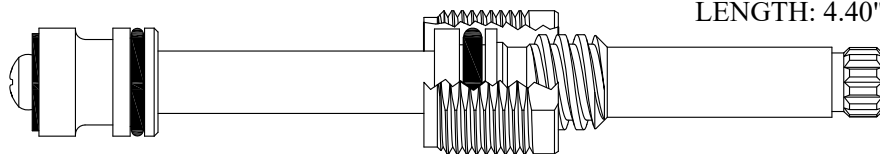

LENGTH: 4.40"

406001

GASKET INCLUDED: 895040

OEM # 3261

IMPORT VERSION
HA20831

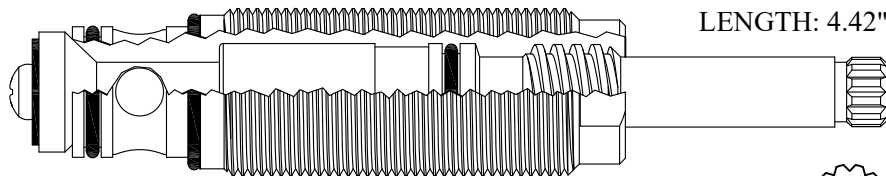

LENGTH: 4.42"

430501

GASKET: 890170 O-RING INCLUDED

OEM # 3262

203501 Stem Only



FOR HARCRAFT

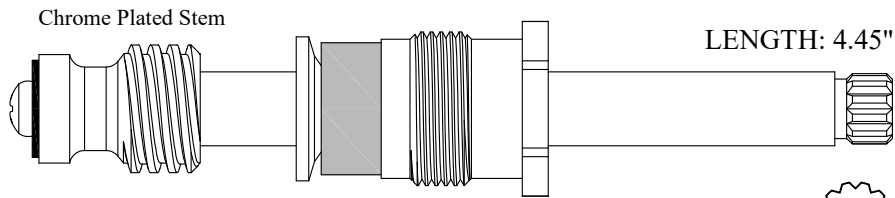

LF473021/ LF473022

OEM # 3020/ 3019

LF273021/ LF273022 Stem Only

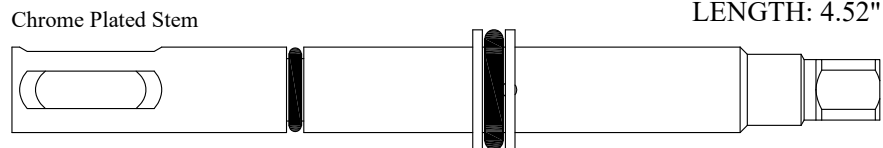

161320

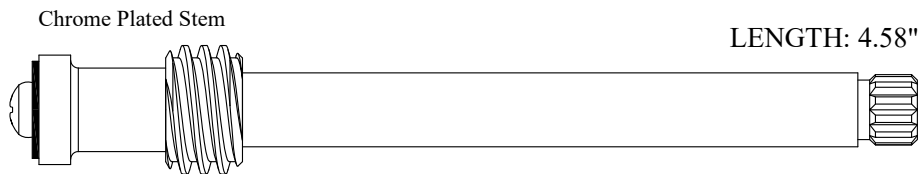

LF274031/ LF274032

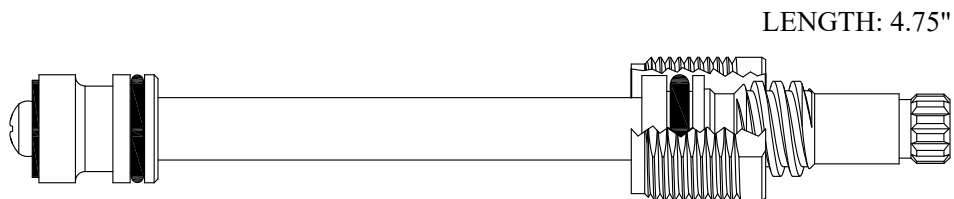

LF475071

GASKET INCLUDED: 895040

OEM # 3413



FOR HARCRAFT

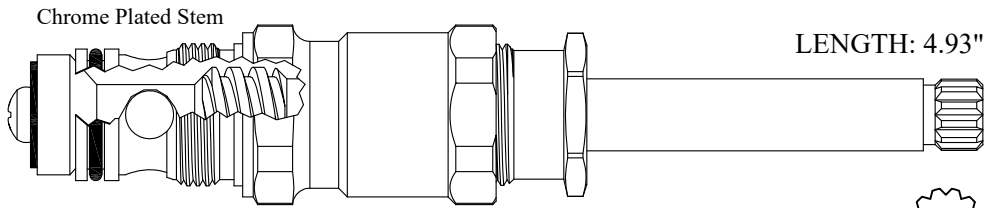

431801
GASKET INCLUDED: 895100
OEM # 3233
231801 Stem Only
OEM # 2795

12
1-2

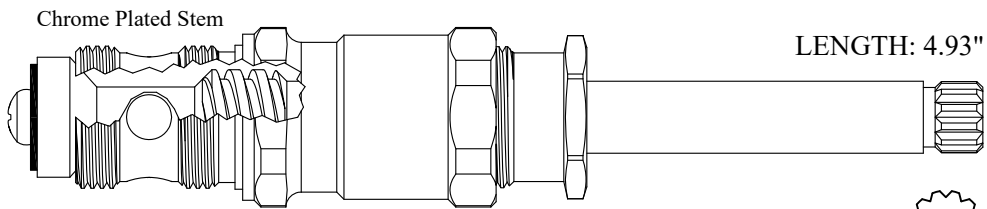

431811
GASKET INCLUDED: 895100
OEM # 3141
231801 Stem Only
OEM # 2795

12
1-2

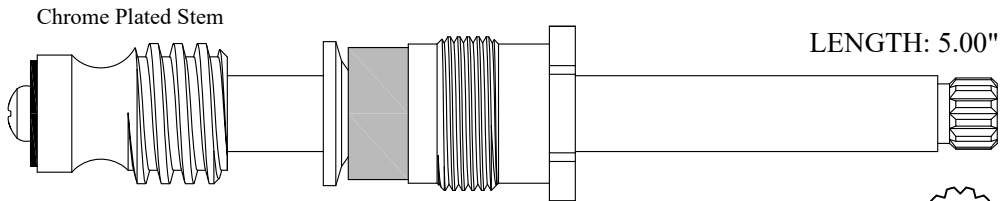

413501
OEM # 3038
213501 Stem Only

12
1-2

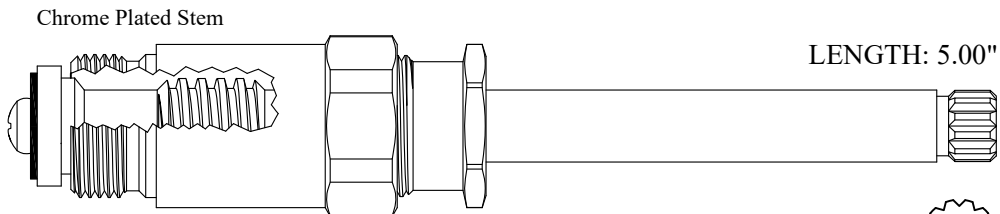

413701
GASKET INCLUDED: 895100
OEM # 3140
213701 Stem Only

12
1-2

FOR HARCRAFT

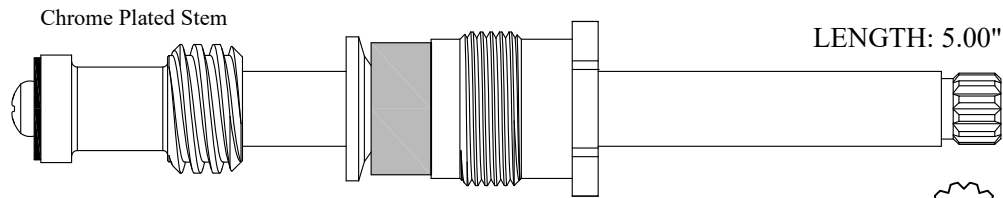

LF480011/ LF480012
LF280011/ LF280012 Stem Only

12
1-2

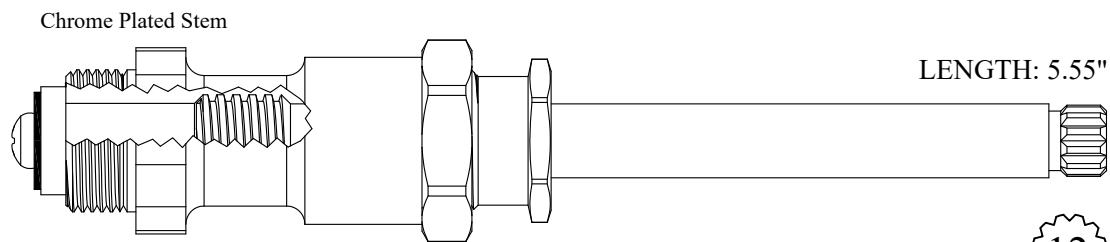

423001
GASKET INCLUDED: 895100
223001 Stem Only



12
1-2

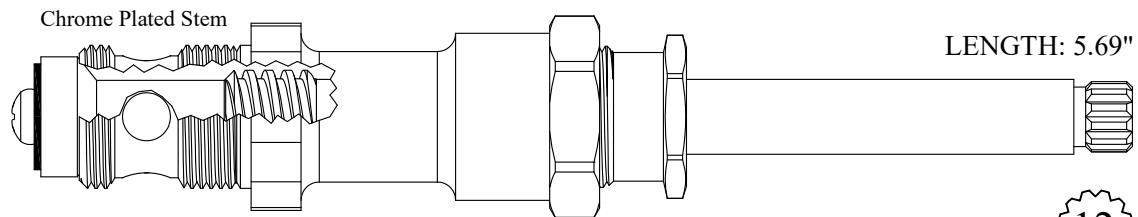

435721
GASKET INCLUDED: 895100
235721 Stem Only

12
1-2

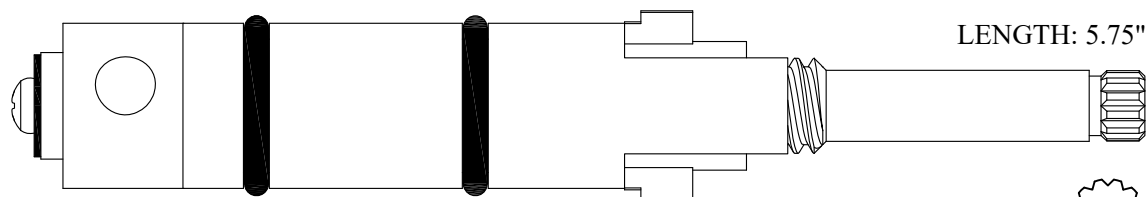

424221
OEM # 3366

12
1-2

FOR HARDEN

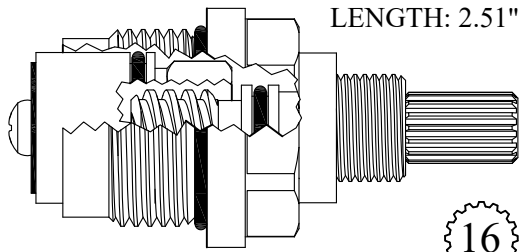

LF463901/ LF463902
GASKET: 890210 O-RING INCLUDED

16
3-16

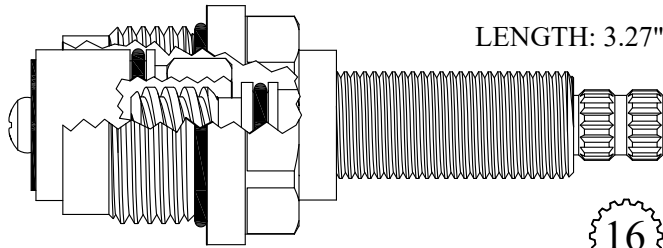

402421/ 402422
GASKET: 890210 O-RING INCLUDED

16
3-16

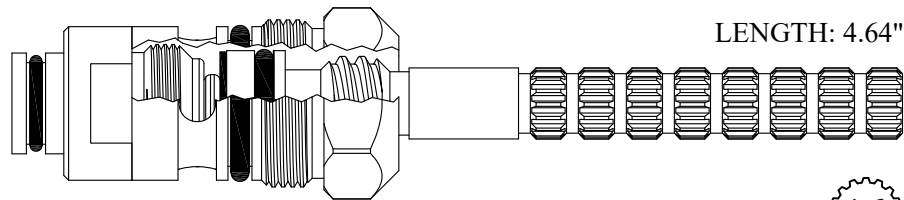

408031/ 408032
GASKET: 891140 O-RING INCLUDED

16
3-16

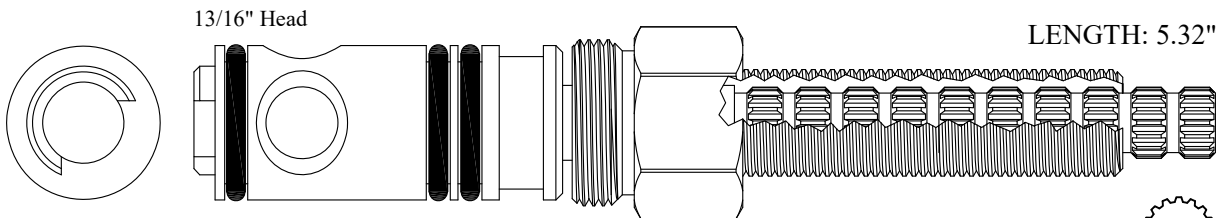

432920
OEM # 580040 or 133 DIV
232920 Stem Only

16
3-16

FOR HARDEN

3/4" Head

LENGTH: 5.32"

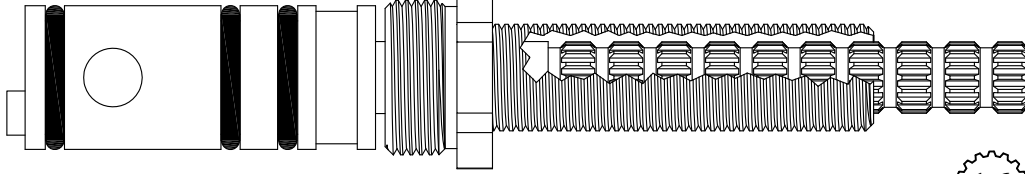

432930
232930 Stem Only

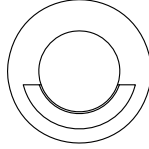

16
3-16

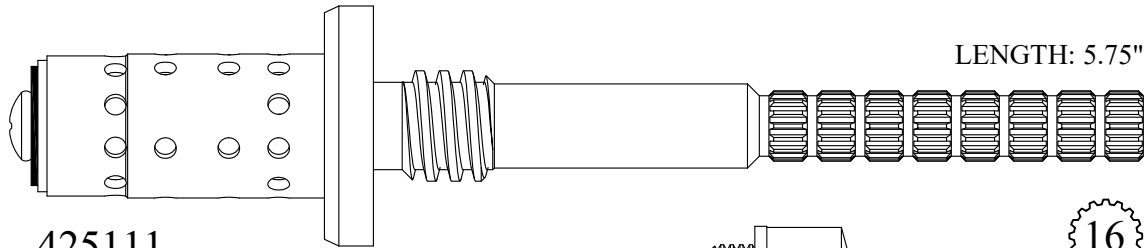

LENGTH: 5.75"

425111
GASKET INCLUDED: 895500
225111 Stem Only
OEM # 580150
Zum # RK7000-50-ACL

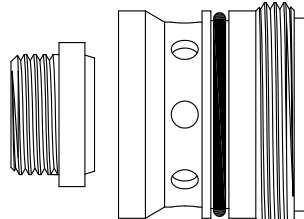

SEAT KIT USED: 106090

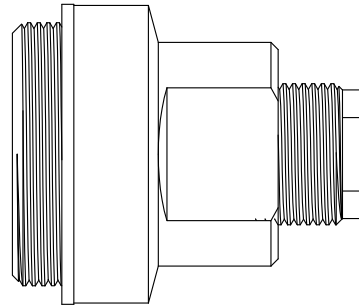

16
3-16

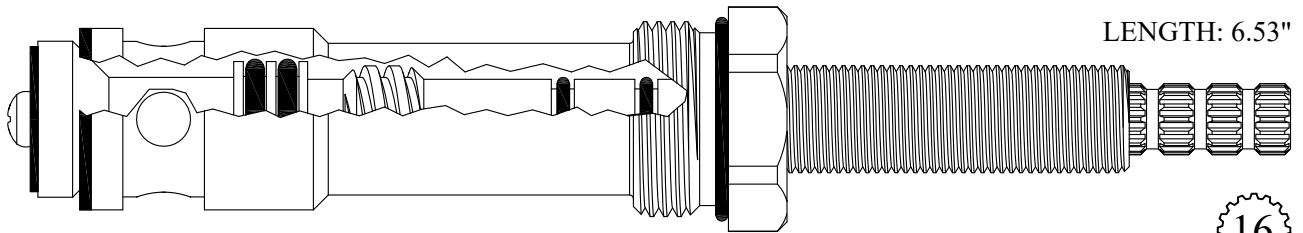

LENGTH: 6.53"

439141
GASKET: 891180 O-RING INCLUDED
OEM # 580116

16
3-16

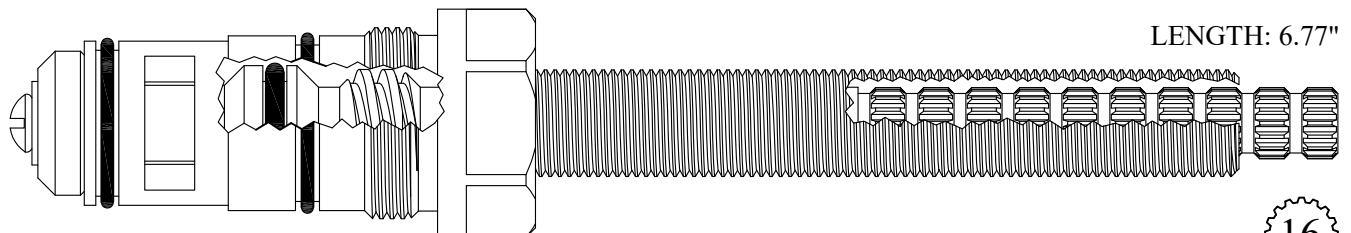

LENGTH: 6.77"

439221
OEM # OWC8JK

16
3-16

FOR HARDEN

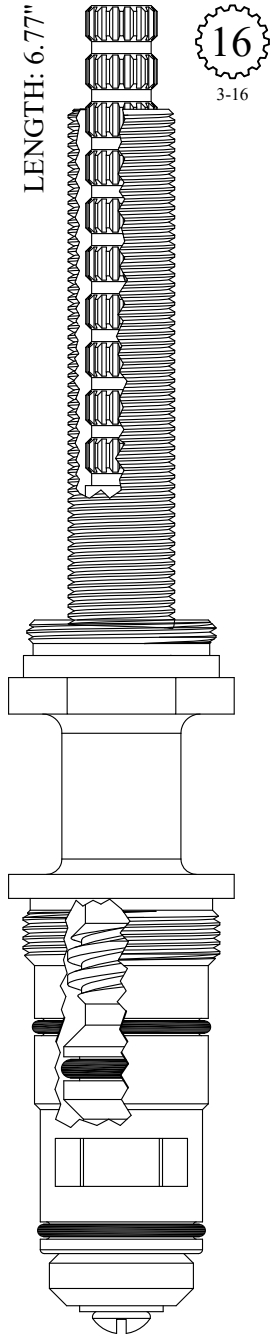

439241

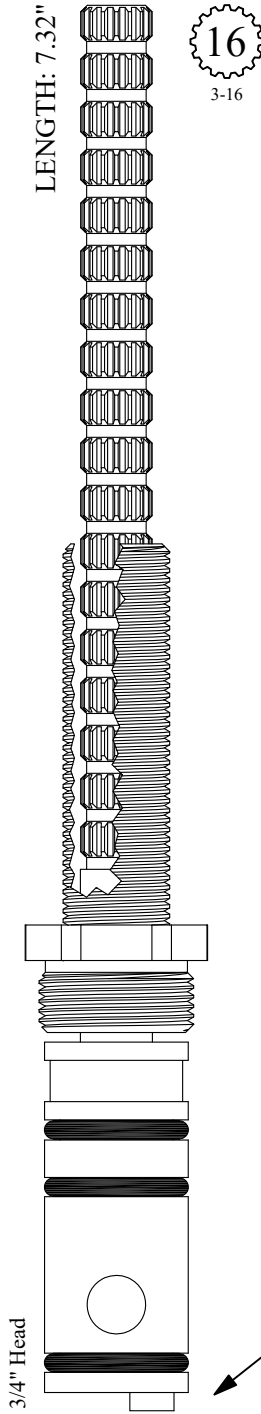

439730
239730 Stem Only

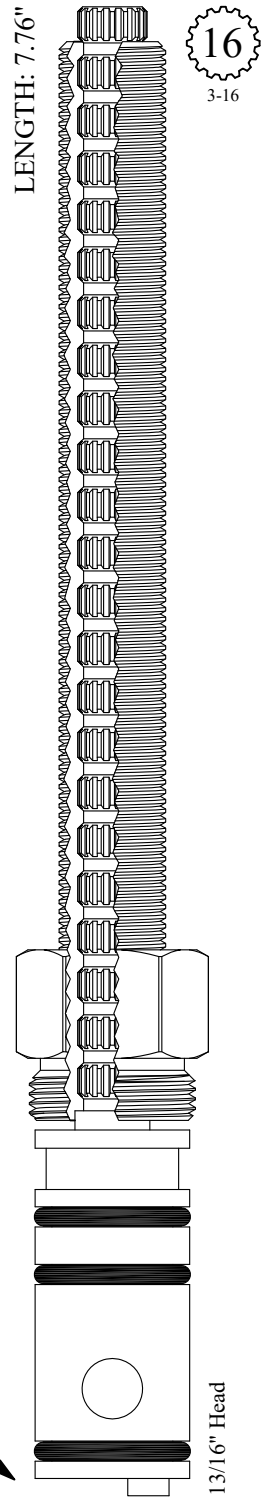

439760
239760 Stem Only

FOR HARDEN

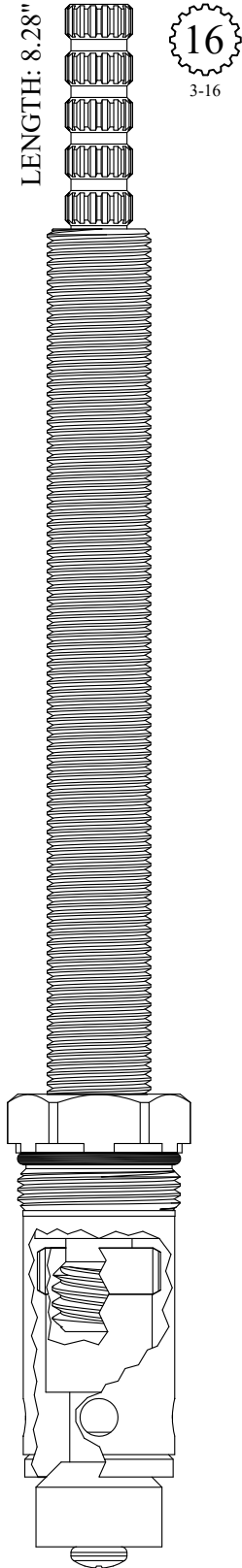

GASKET: 891140 O-RING INCLUDED

439722

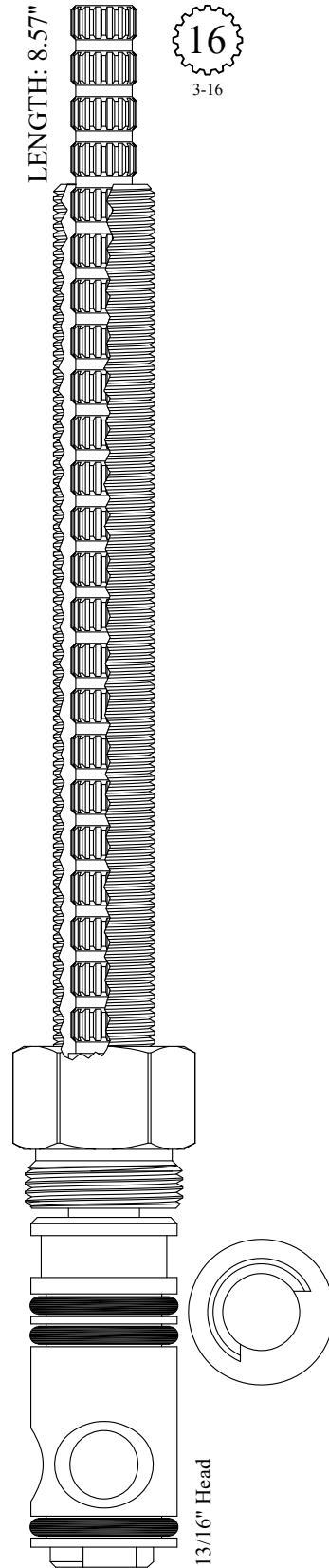

439740
OEM # 580070 or 136 DIV
239740 Stem Only

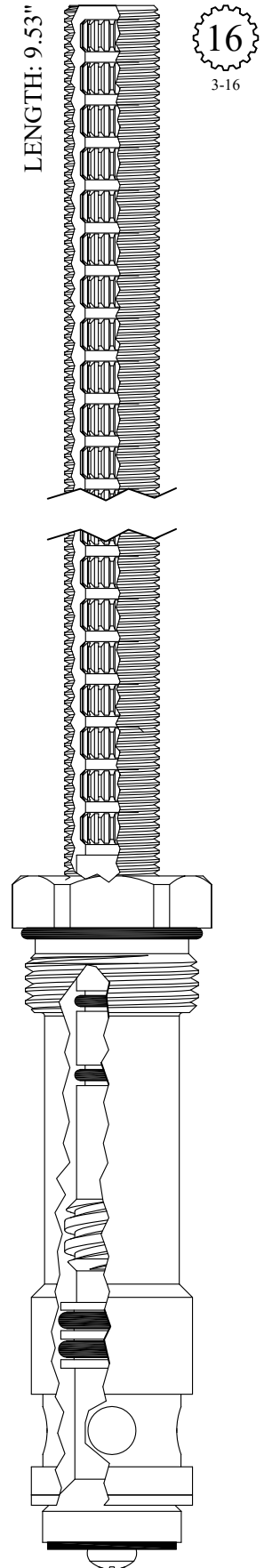

GASKET: 891180 O-RING INCLUDED

439911

FOR HASTINGS

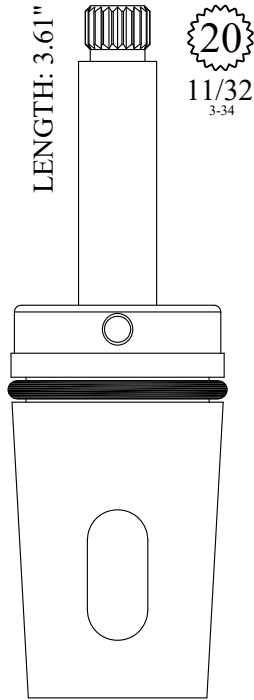

230580

FOR HAWS

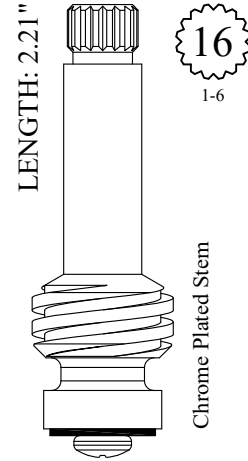

LF262161

FOR HELVEX

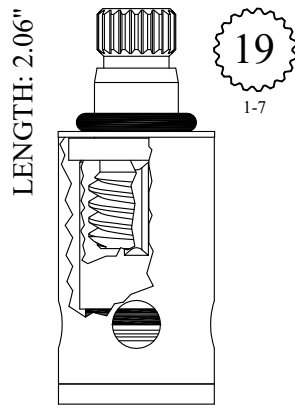

LF458992
OEM # SH-0001

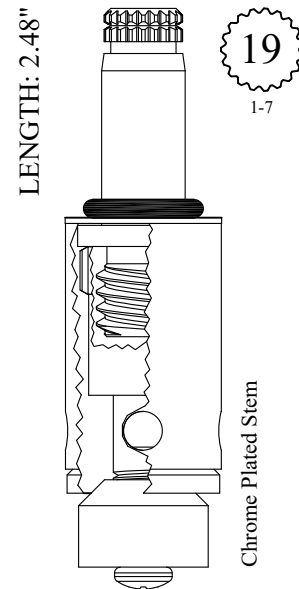

430992

FOR HUDSON

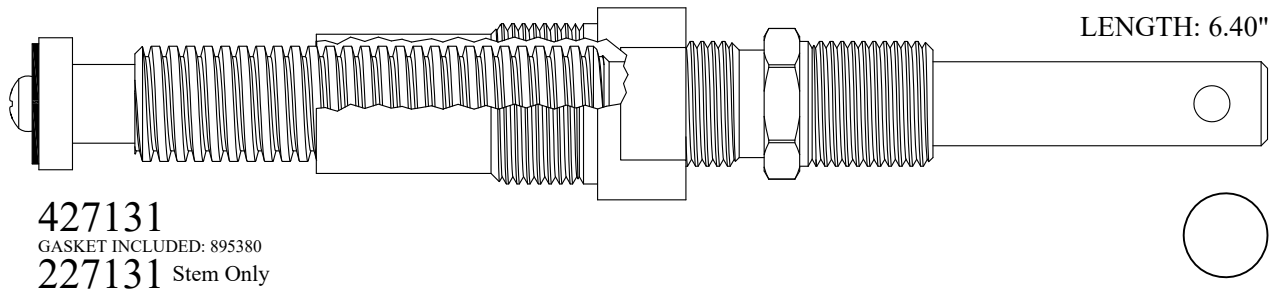
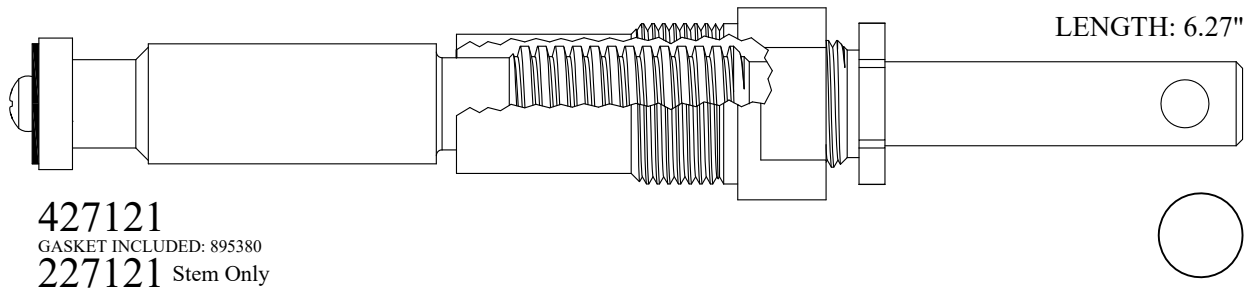
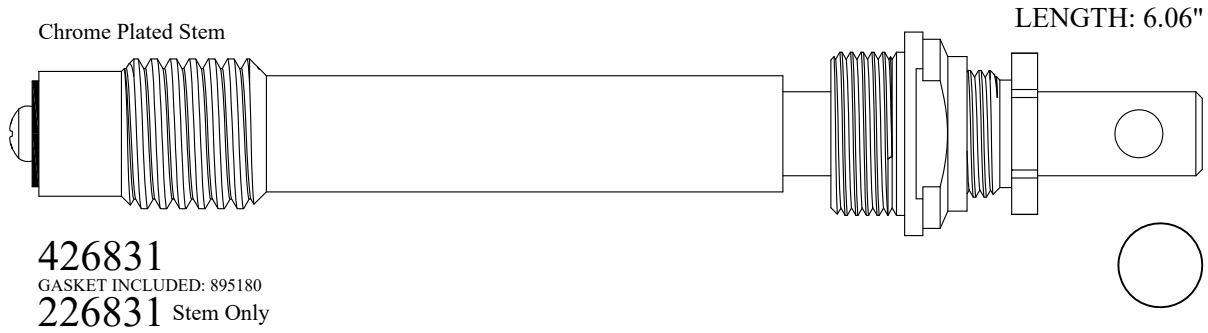

FOR ILLINOIS

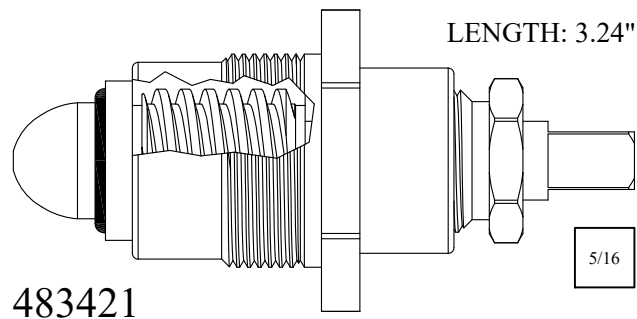

FOR INDIANA

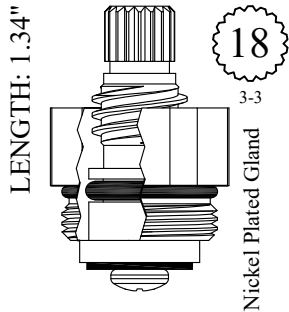

GASKET: 890170 O-RING INCLUDED

450971

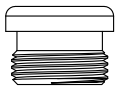

SEAT USED: LF648560

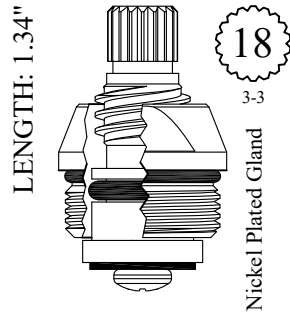

GASKET: 890170 O-RING INCLUDED

LF451011
OEM # 631C&D
LF451012
OEM # 625C&D

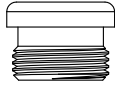

SEAT USED: LF648560

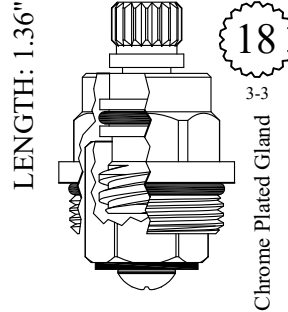

GASKET: 890170 O-RING INCLUDED

LF450501
LF450502

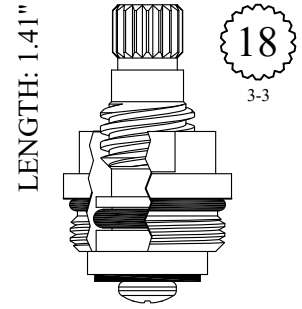

GASKET: 890170 O-RING INCLUDED

LF451121
LF451122

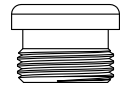

SEAT USED: LF648560

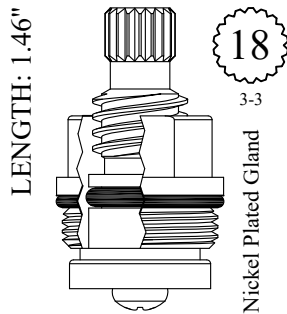

GASKET: 890180 O-RING INCLUDED

LF451141
LF451142

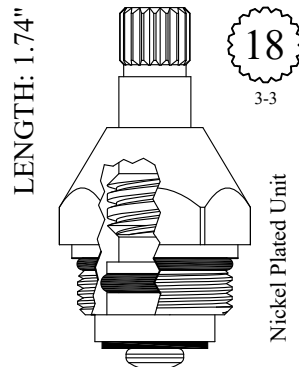

GASKET: 890170 O-RING INCLUDED

LF454031
LF454032

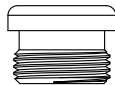

SEAT USED: LF648560

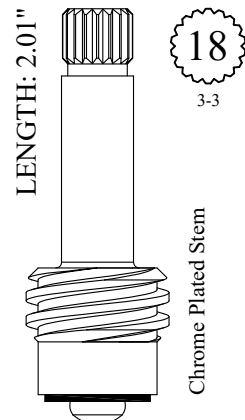

LF259031
LF259032

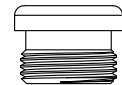

SEAT USED: LF648560

FOR INDIANA

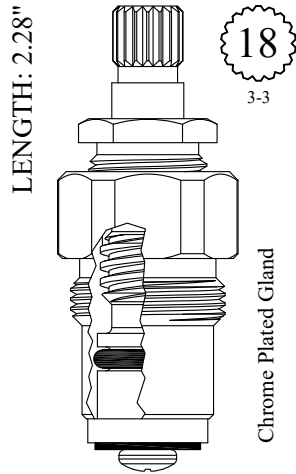

GASKET: 890170 O-RING INCLUDED

LF461951
LF461952

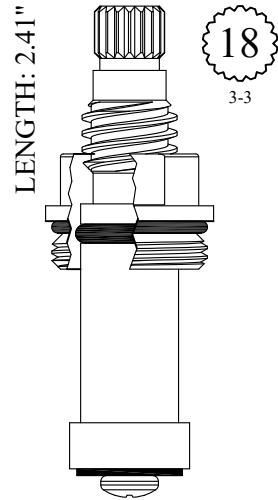

GASKET: 890170 O-RING INCLUDED

LF464131
LF464132

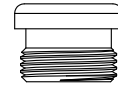

SEAT USED: LF648560

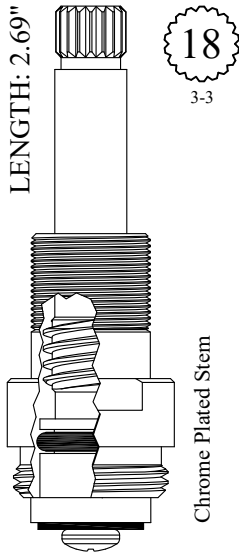

GASKET INCLUDED: 895150

LF465061
LF465062

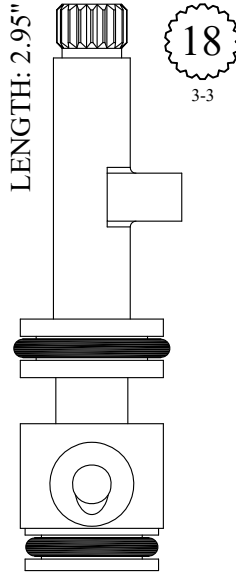

230030

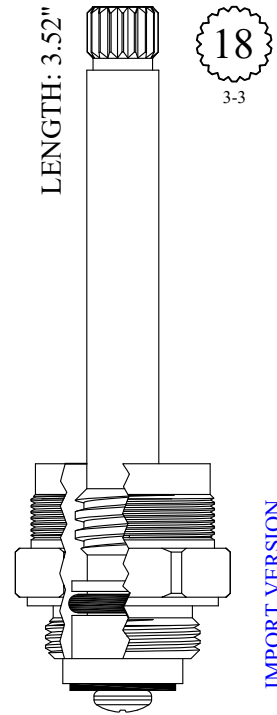

GASKET INCLUDED: 895150

402901
OEM # 552-C-RH
402902
OEM # 552-C-LA

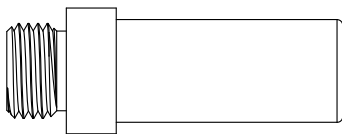

SEAT USED: LF649160

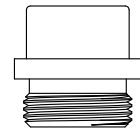

SEAT USED: 649300

FOR INDIANA

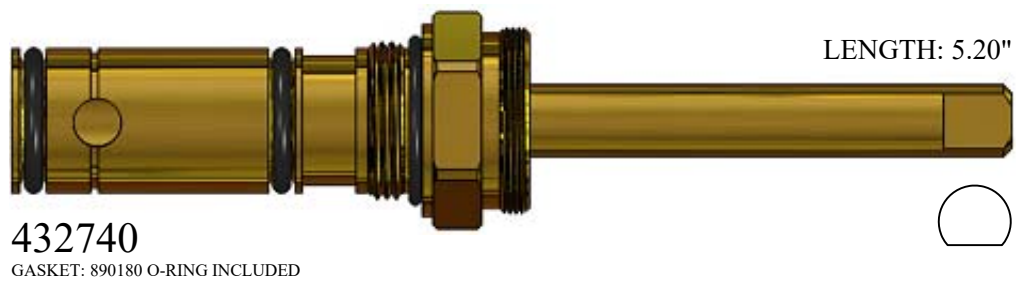
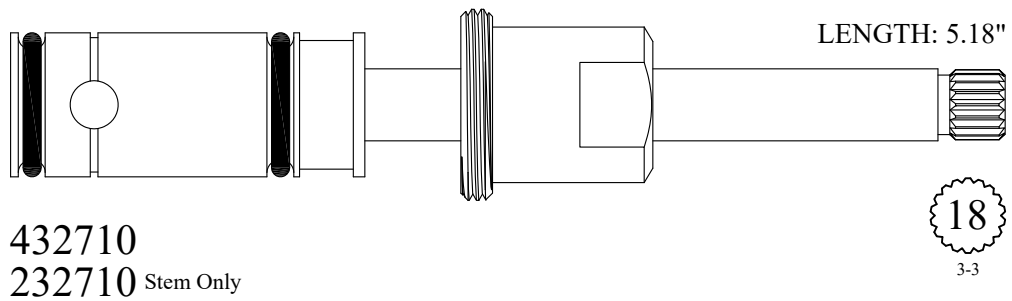
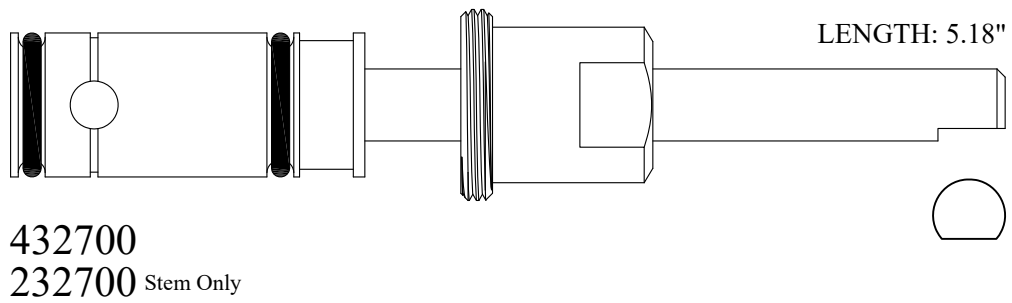
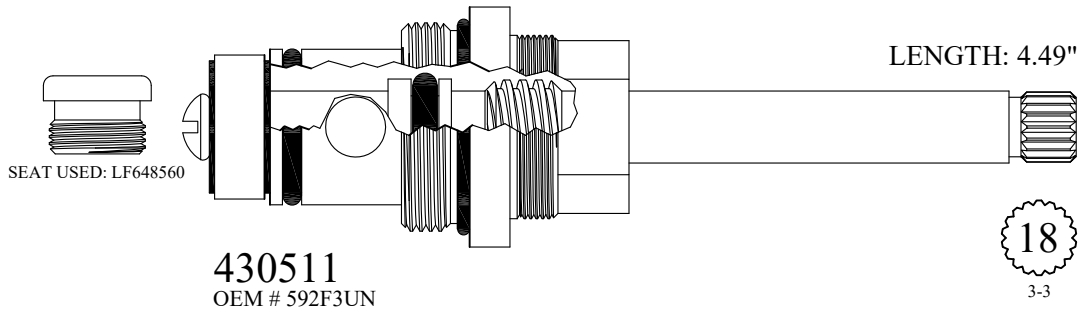

FOR INDIANA

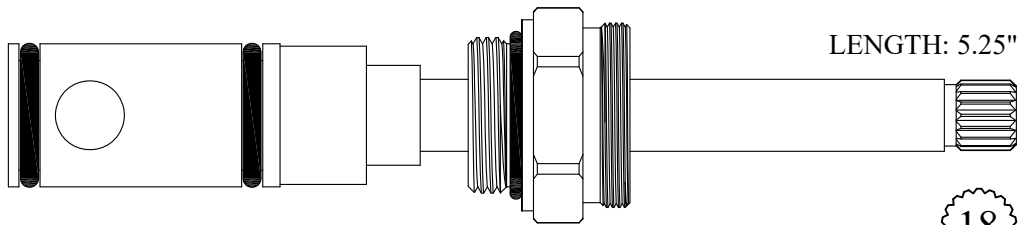

432730
GASKET: 890180 O-RING INCLUDED
232730 Stem Only
OEM # 27610

18
3-3

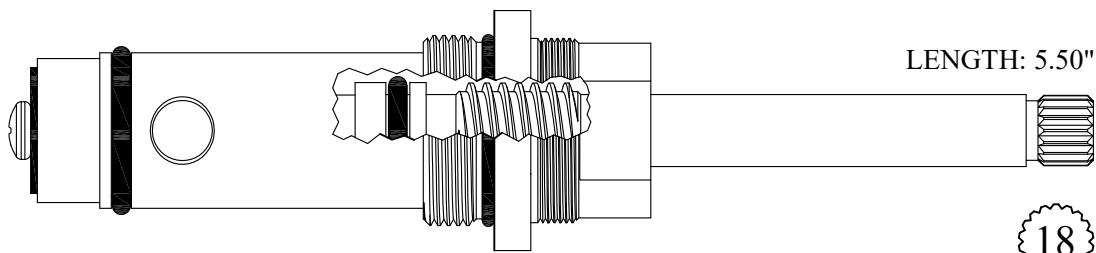

434301
GASKET: 890200 O-RING INCLUDED

18
3-3

Chrome Plated Stem

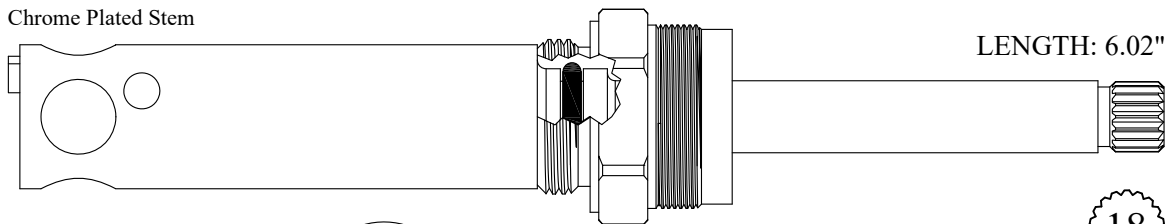

437700
GASKET INCLUDED: 895150
237700 Stem Only

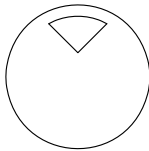

18
3-3

Chrome Plated Stem

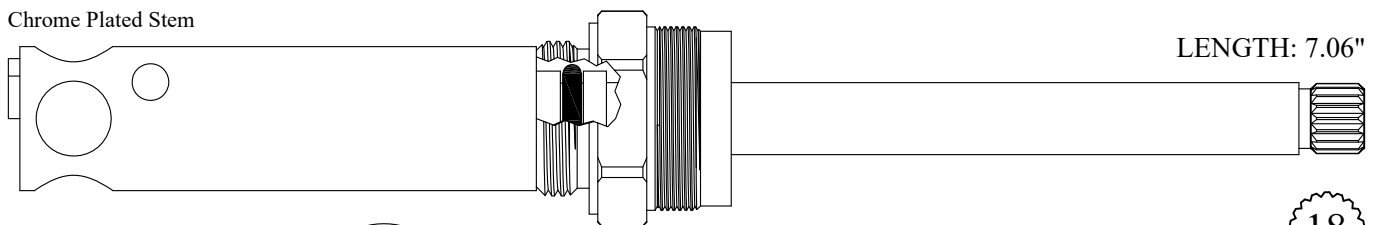

439520
GASKET INCLUDED: 895150
239520 Stem Only

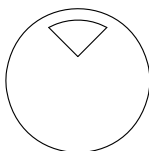

18
3-3

FOR I.W. INDUSTRIES

Wall and Deck Models

To identify a 4 or 5-Port Unit, look down the stem from the broach end at the dent bushing. Refer to the images below:

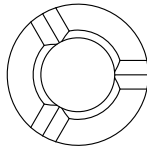

4-Port

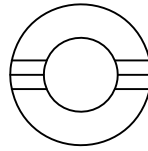

5-Port

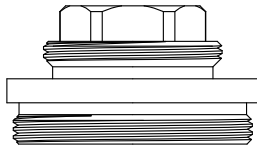

730560

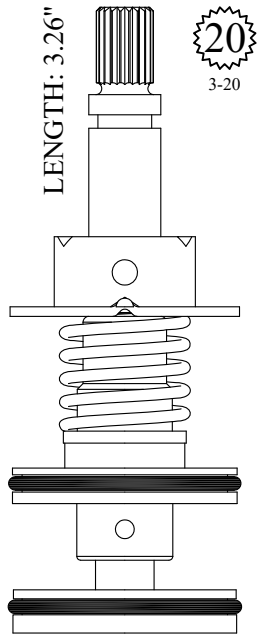

Wall Model	
4-Port	230560
5-Port	230570
W/ 730560 Bonnet	
4-Port	430560
5-Port	430570

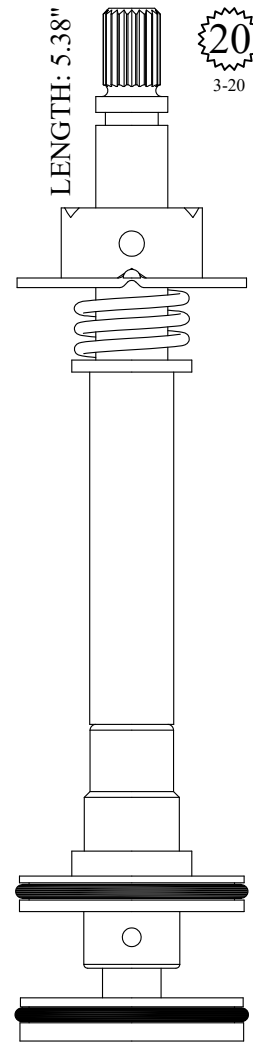

Deck Model	
4-Port	233980
5-Port	233990
W/ 730560 Bonnet	
4-Port	433980
5-Port	433990

FOR J.L. MOTT

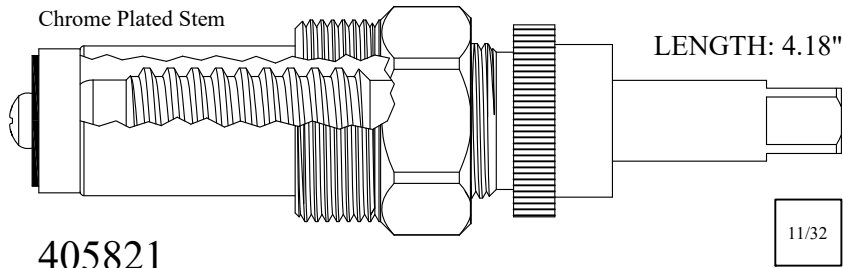

405821

GASKET USED: 895160

205821 Stem Only

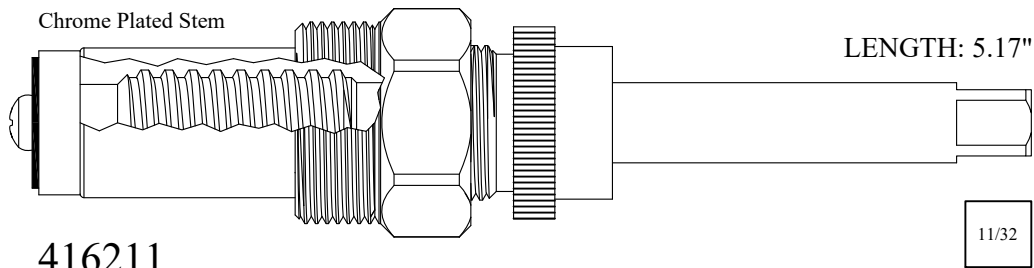

416211

GASKET USED: 895160

216211 Stem Only

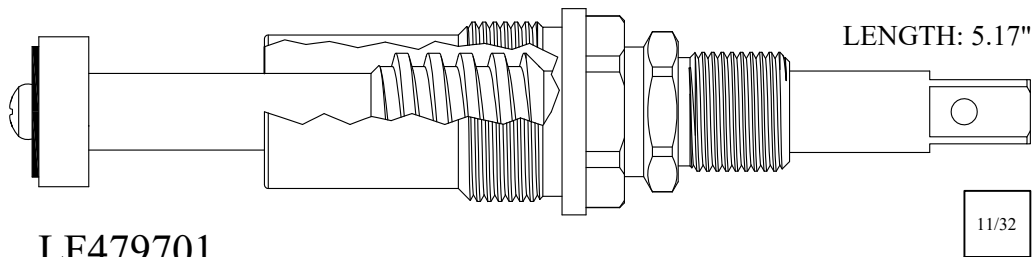

LF479701

GASKET USED: 895320

LF279701 Stem Only

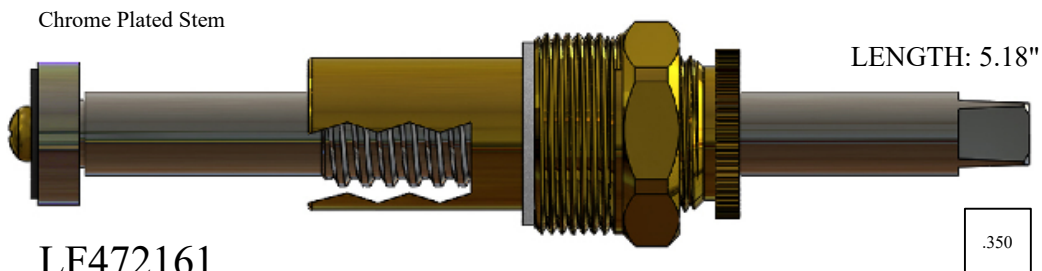

LF472161

GASKET USED: 895160

LF272161 Stem Only

FOR JACLO

Chrome Plated Stem & Gland

LENGTH: 5.15"

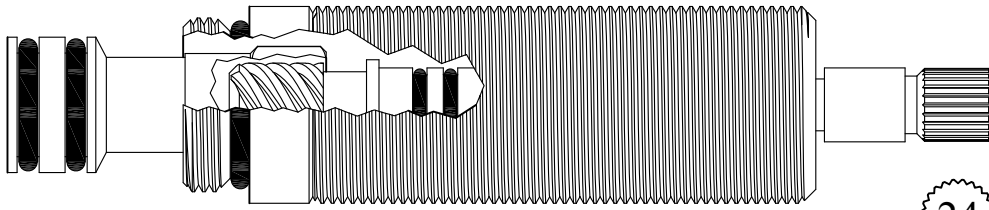

432431

GASKET: 891150 O-RING INCLUDED

24
3-19

Chrome Plated Stem & Gland

LENGTH: 5.15"

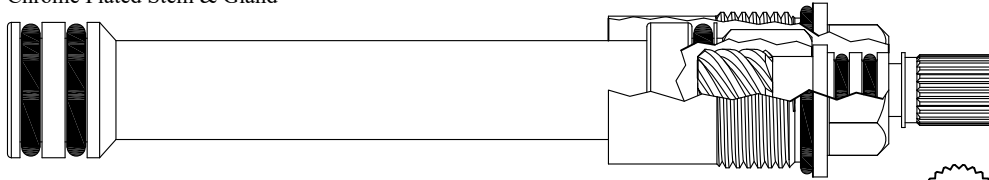

432511

GASKET: 890180 O-RING INCLUDED

24
3-19

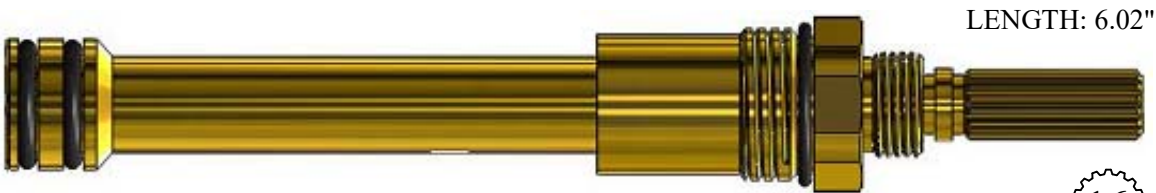

LENGTH: 6.02"

438421

16
3-16

Chrome Plated Gland

LENGTH: 7.15"

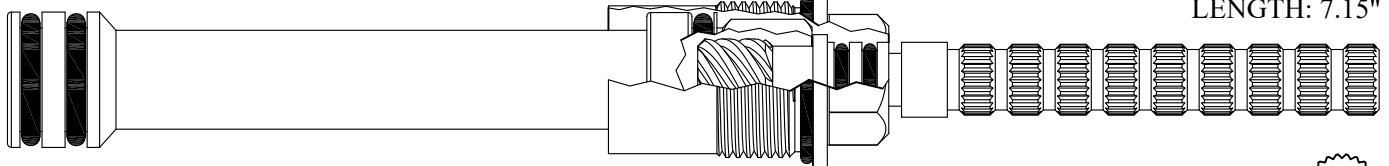

439421

GASKET: 890180 O-RING INCLUDED

24
3-19

FOR JADO

LENGTH: 2.22"



431450

OEM # 913000.191

LENGTH: 5.04"



432961

20
3-20

FOR JAMECO

LENGTH: 3.20"

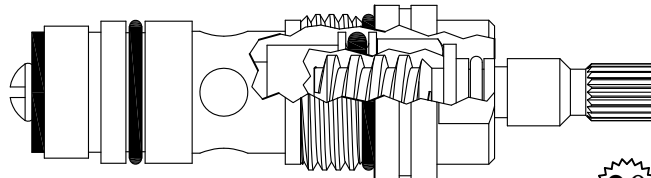

430392

GASKET: 890170 O-RING INCLUDED

20
3-20

FOR KALLISTA

Comes with handle screw:
899230

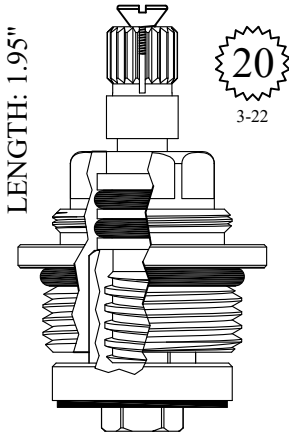

GASKET: 891180 O-RING INCLUDED

401072

Comes with handle screw:
899230

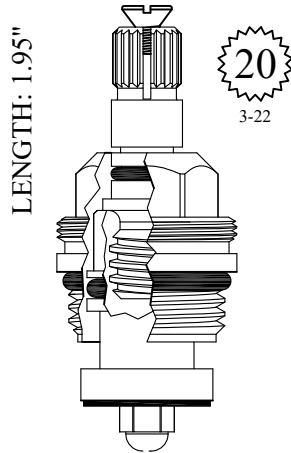

GASKET: 891150 O-RING INCLUDED

LF458502

Comes with handle screw:
899230

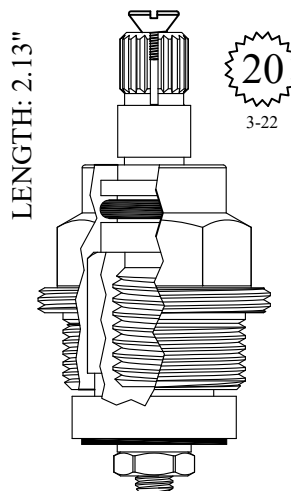

GASKET INCLUDED: 895350

LF463602

Comes with handle screw:
899230

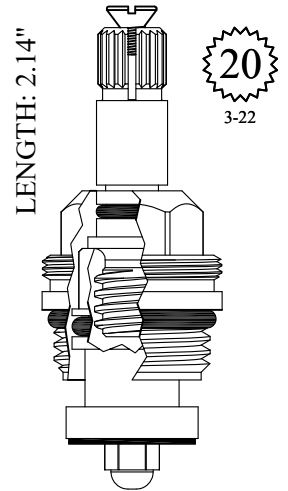

GASKET: 891150 O-RING INCLUDED

**LF459801
LF459802**

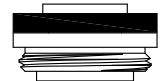

SEAT USED: LF648850-M

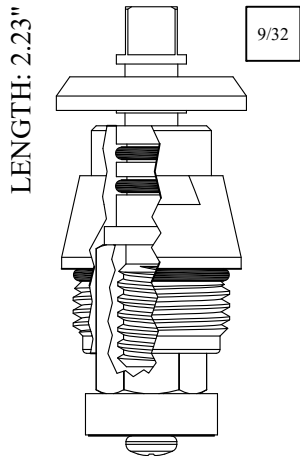

GASKET: 890170 O-RING INCLUDED

LF460652

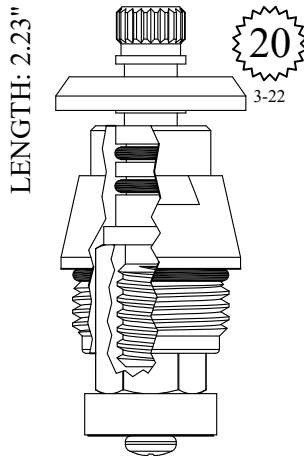

GASKET: 890170 O-RING INCLUDED

LF460672

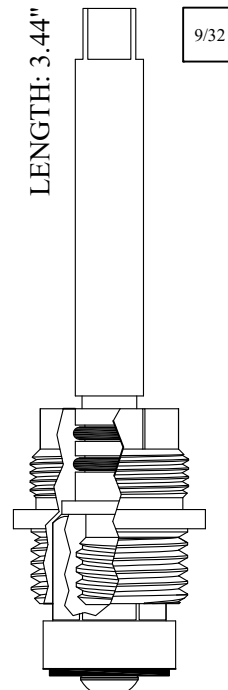

GASKET INCLUDED: 895160

402762

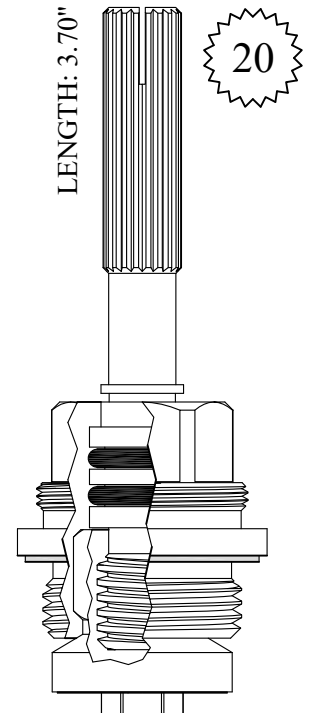

GASKET INCLUDED: 895440

402792

FOR KALLISTA

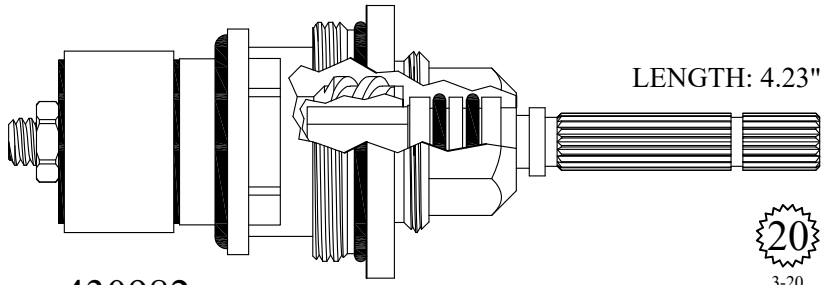

430982

GASKET: 890210 O-RING INCLUDED

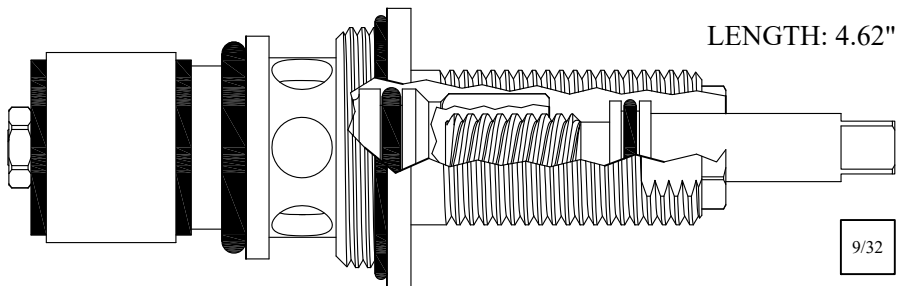

430642

GASKET: 890240 O-RING INCLUDED

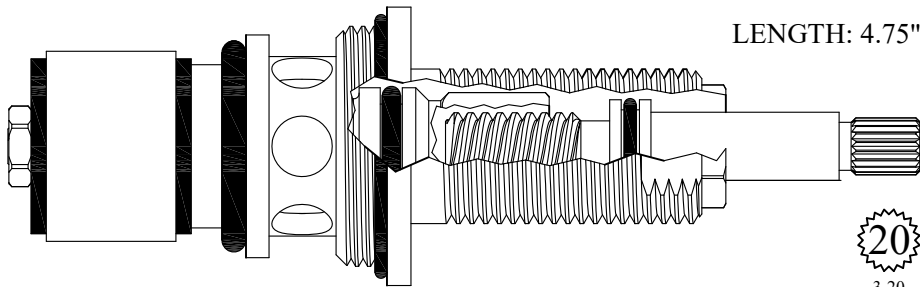

430782

GASKET: 890240 O-RING INCLUDED

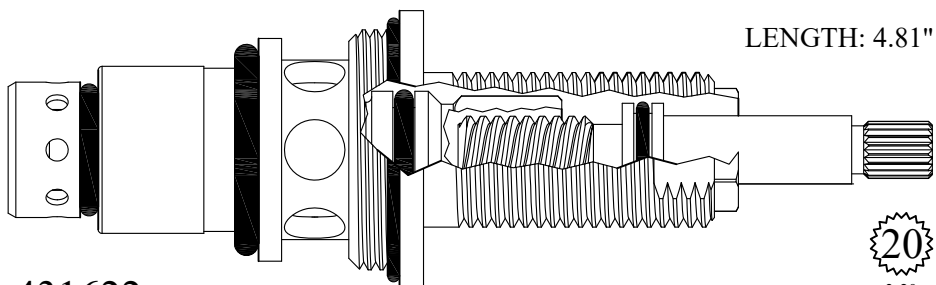

431622

GASKET: 890240 O-RING INCLUDED

FOR KALLISTA

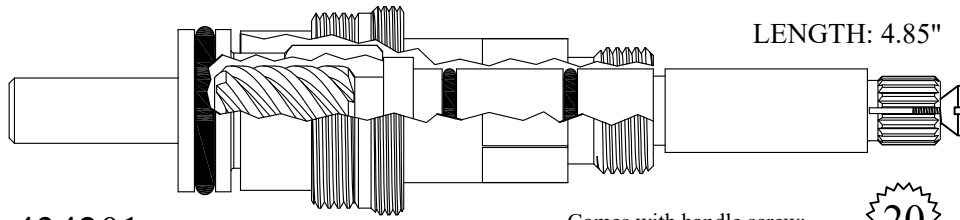

434201

Comes with handle screw:
899230

20
3-22

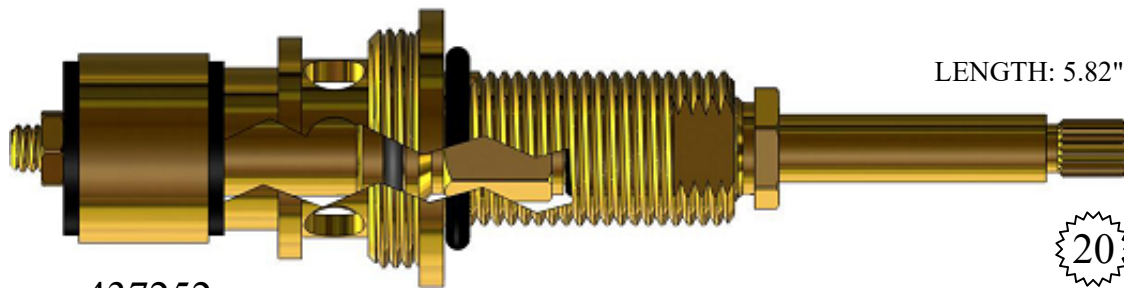

437252

GASKET: 890240 O-RING INCLUDED

LENGTH: 5.82"

20
3-22

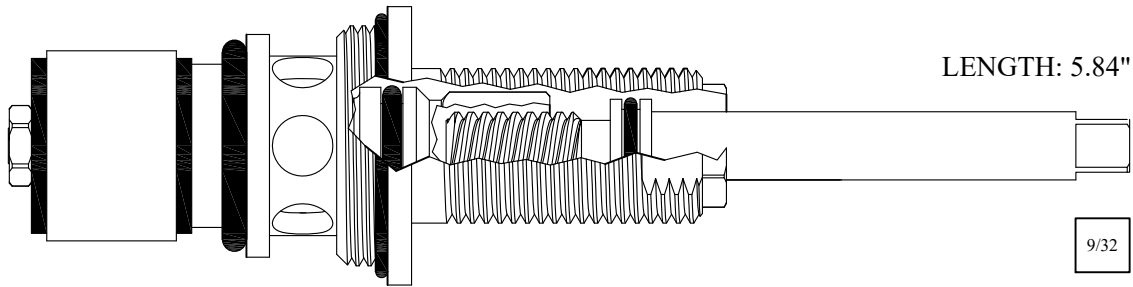

437112

GASKET: 890240 O-RING INCLUDED

LENGTH: 5.84"

9/32

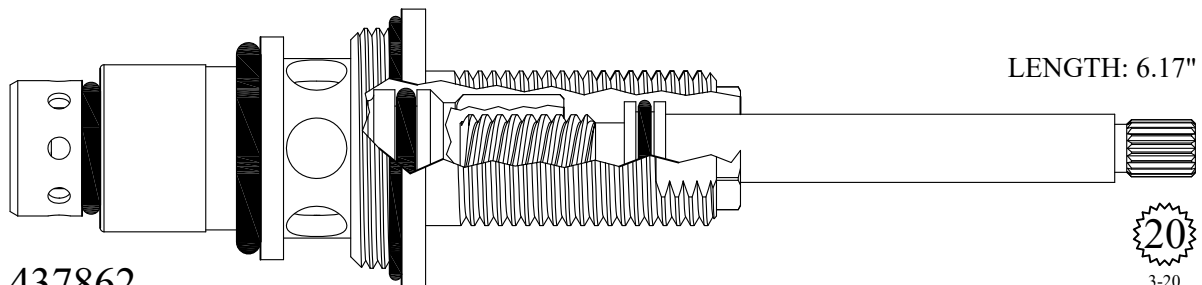

437862

GASKET: 890240 O-RNG INCLUDED

LENGTH: 6.17"

20
3-20

FOR KINGSBURY

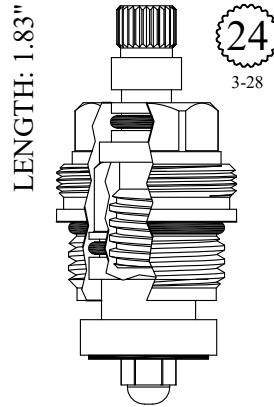

GASKET: 890170 O-RING INCLUDED

LF455972

FOR KOHLER

LENGTH: 1.13"



147250

INCLUDES 400691 & 400671
KOHLER OEM # 77148

400691

LENGTH: 1.14"

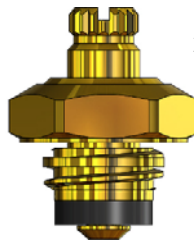

400671

LENGTH: 1.37"

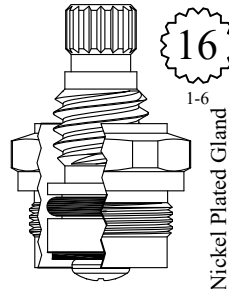

Nickel Plated Gland



SEAT USED: LF648070

GASKET INCLUDED: 895100

LF450051

OEM # 20786

LF450052

OEM # 20785

IMPORT VERSION
KO11127-LF
KO11128-LF

LENGTH: 1.80"

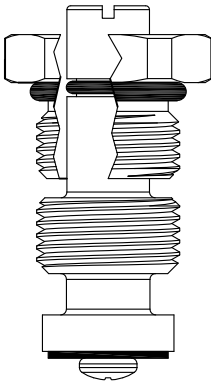

GASKET: 891140 O-RING INCLUDED

400921

200921 Stem Only

LENGTH: 1.94"

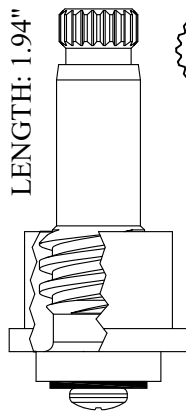

Chrome Plated Stem

SEAT USED: LF647230

LF458041

LF458042

LF258041 Stem Only

OEM # 34070

LF258042 Stem Only

OEM # 34071

LENGTH: 1.94"

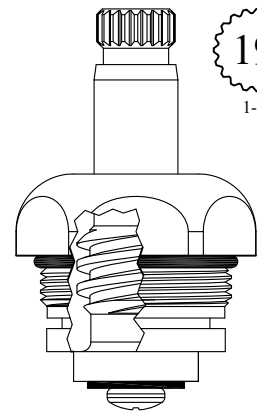

Chrome Plated Stem & Bonnet

GASKET: 890210 O-RING INCLUDED

LF458241

LF458242

LF258041 Stem Only

OEM # 34070

LF258042 Stem Only

OEM # 34071

FOR KOHLER

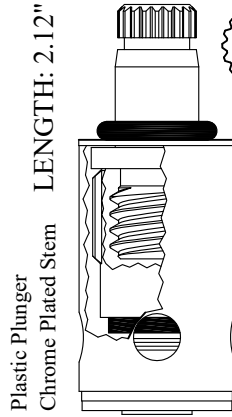
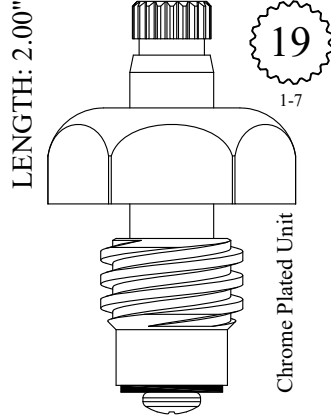
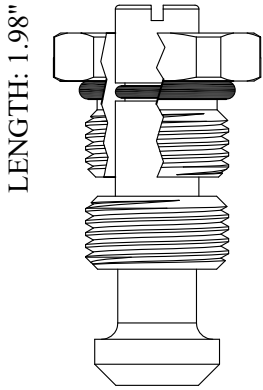

Also available with
Brass Plunger
LF459101-B / LF459102-B

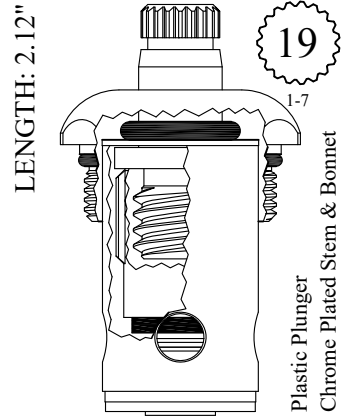

GASKET: 891140 O-RING INCLUDED

400911
200911 Stem Only

LF459041
LF459042
LF259041 Stem Only
OEM # 33914
LF259042 Stem Only
OEM # 33915



SEAT USED: LF648730

SEAT: LF649460 INCLUDED

LF459101
OEM # 20656
LF459102
OEM # 20655

IMPORT VERSION
KO11124-LF
KO11125-LF

LF259101 Stem Only
LF259102 Stem Only

GASKET: 890210 O-RING INCLUDED
SEAT: LF649460 INCLUDED

LF459141
LF459142
LF259101 Stem Only
LF259102 Stem Only

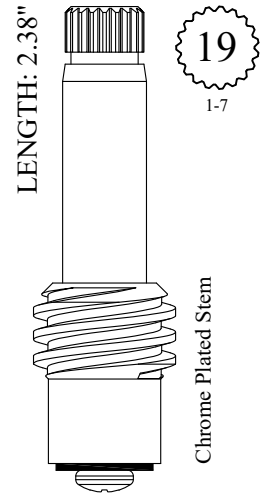
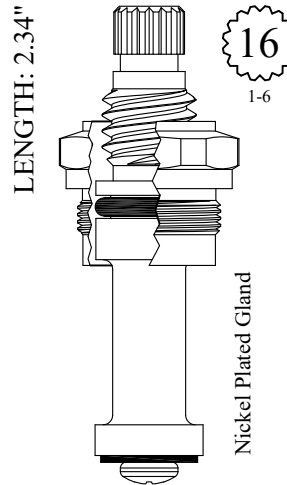
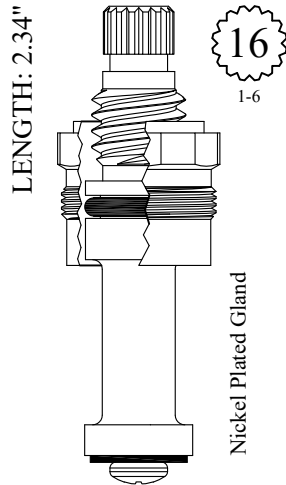
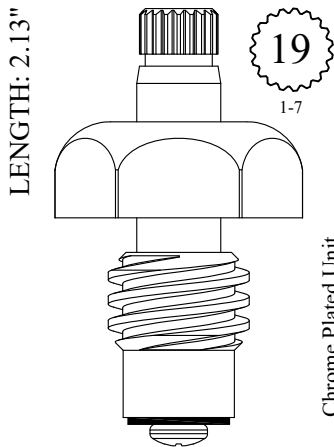

GASKET INCLUDED: 895060

GASKET INCLUDED: 895060

LF460161
LF460162
LF260161 Stem Only
OEM # 31871
LF260162 Stem Only
OEM # 31872

LF462101
LF462102



SEAT USED: LF648070

LF462141
LF462142

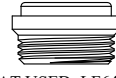

SEAT USED: LF648070

LF263151
OEM # 33491
LF263152
OEM # 37631



SEAT USED: LF647230

SEAT USED: LF648730

FOR KOHLER

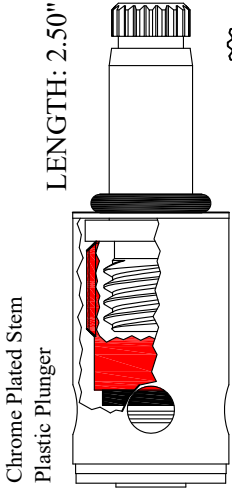

LENGTH: 2.50"

19

1-7

Also available with
Brass Plunger

LF460051-B / LF460052-B

IMPORT VERSION

KO1124-LF / KO1125-LF

SEAT INCLUDED:
LF649460

LF460051

OEM # 30004

LF460052

OEM # 30002

LF260051 Stem Only

LF260052 Stem Only

OEM # 34320

IMPORT VERSION

KO1134-LF

KO1135-LF

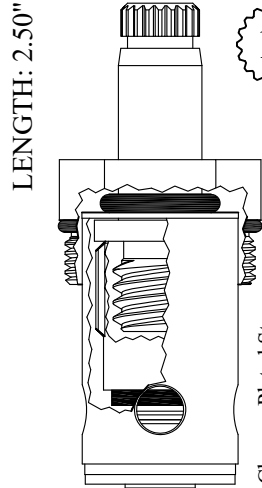

LENGTH: 2.50"

19

1-7

Chrome Plated Stem
Brass Plunger

GASKET: 890210 O-RING INCLUDED
SEAT INCLUDED: LF649460

LF460251-B

LF460252-B

LF260051 Stem Only

LF260052 Stem Only

OEM # 34320

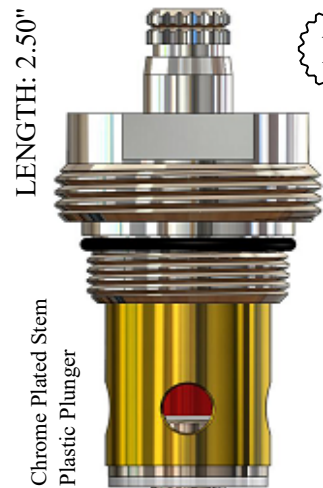

LENGTH: 2.50"

19

1-7

Chrome Plated Stem
Plastic Plunger

GASKET: 890180 O-RING INCLUDED
SEAT INCLUDED: LF649460

LF460151

LF460152

LF260051 Stem Only

LF260052 Stem Only

OEM # 34320

Also available with Brass Plunger

LF460151-B / LF460152-B

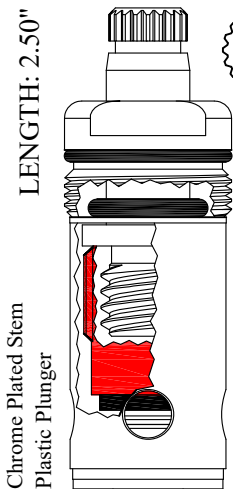

LENGTH: 2.50"

19

1-7

Also available with Brass Plunger

LF460261-B / LF460262-B

GASKET: 890180 O-RING INCLUDED
SEAT INCLUDED: LF649460

LF460261

LF460262

LF260051 Stem Only

LF260052 Stem Only

OEM # 34320

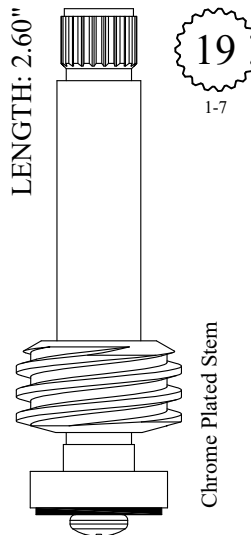

LENGTH: 2.60"

19

1-7

Chrome Plated Stem

LF264321

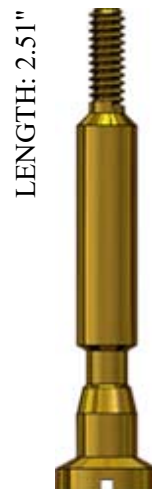

LENGTH: 2.51"

Stem Only
LF256190

OEM # K-36261



LENGTH: 2.82"

LF456190

FOR K13816 & K13960

FOR KOHLER

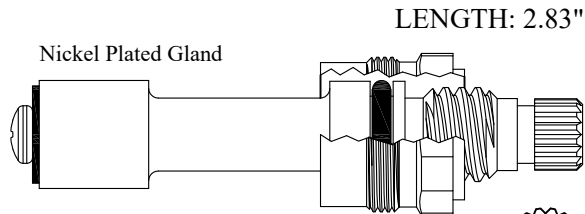

LF465131/ LF465132

GASKET INCLUDED: 895060
OEM # 20810-RP/ 20811-RP



1-6

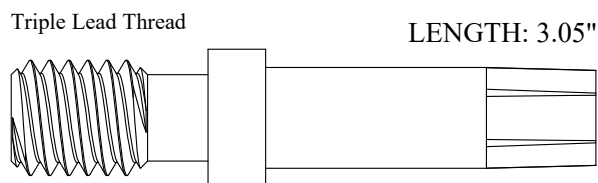
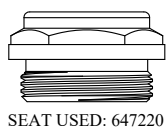

202171
OEM # 22909

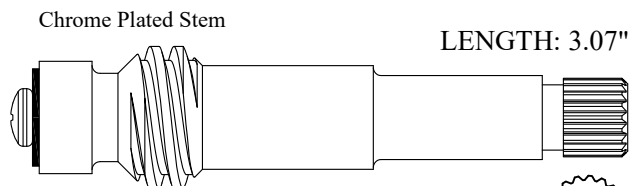
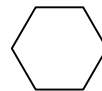

LF265651/ LF265652



1-7

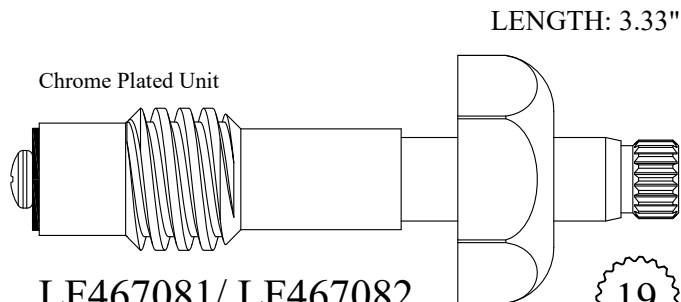

LF467081/ LF467082
LF267081/ LF267082 Stem Only
OEM # 31585/ 31584



1-7

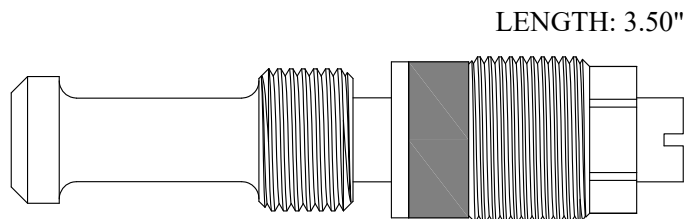

402991
202991 Stem Only

FOR KOHLER

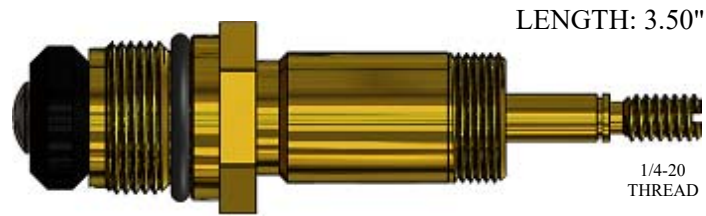

431710

GASKET: 891150 O-RING INCLUDED
OEM # 89773

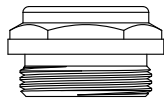

Triple Lead

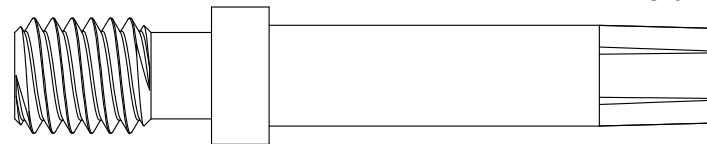

202941

OEM # 22124

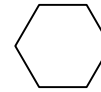

431370

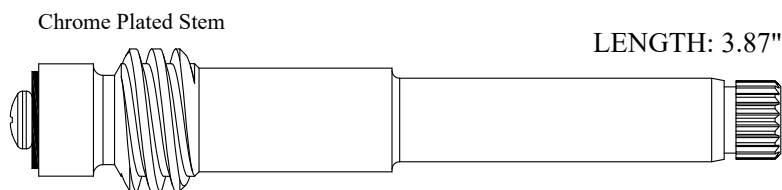
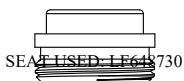

LF269081/ LF269082



FOR KOHLER

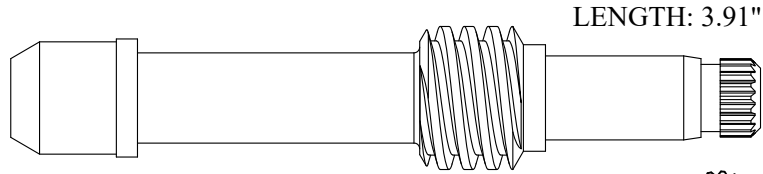

LENGTH: 3.91"

231151
OEM # 34470

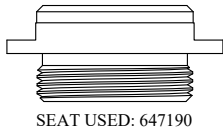

Triple Lead
Chrome Plated Stem

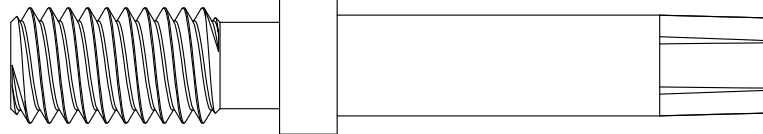

LENGTH: 3.95"

203211
OEM # 21712

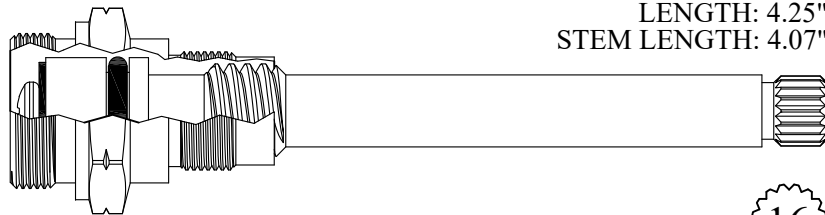
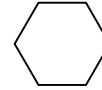

LENGTH: 4.25"
STEM LENGTH: 4.07"

404331/ 404332

GASKET: 895150
OEM # 21076

204201/ 204202 Stem Only
OEM # 20901/ 20900



Chrome Plated Escutcheon Tube #111460



LENGTH: 4.25"
STEM LENGTH: 4.07"

404201/ 404202

GASKET: 895150
OEM # 20905 / 20904

204201/ 204202 Stem Only
OEM # 20901 / 20900

IMPORT VERSION
KO21102
KO21103



FOR KOHLER

Plastic Escutcheon Nipple #119040

LENGTH: 4.25"
STEM LENGTH: 4.07"



SEAT USED: LF648070

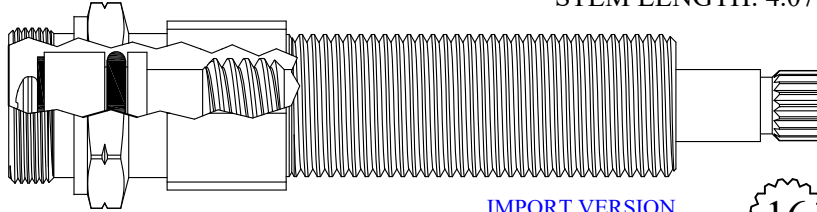

IMPORT VERSION
KO21101



1-6

404231/ 404232

GASKET: 895150

OEM # 30119

204201/ 204202 Stem Only

OEM # 20901 / 20900

Chrome Plated Stem / Plastic Plunger

LENGTH: 4.24"

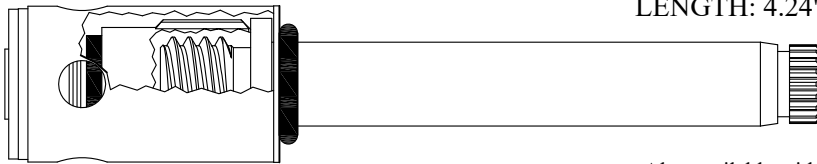

1-7

SEAT INCLUDED: LF649460

LF470701/ LF470702

OEM # 30128/ 30127

LF270701/ LF270702 Stem Only

Also available with Brass Plunger

LF470701-B / LF470702-B

Also available with Brass Plunger &
Polished Gold stem

LF470701-PG / LF470702-PG

LF270701-PG / LF270702-PG Stem Only

Chrome Plated Stem / Plastic Plunger

LENGTH: 4.24"

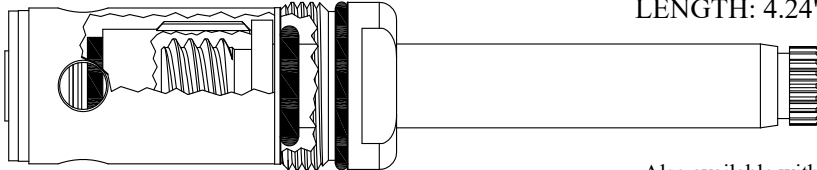

1-7

SEAT INCLUDED: LF649460

LF470711/ LF470712

GASKET: 890180 O-RING INCLUDED

LF270701/ LF270702 Stem Only

Also available with Brass Plunger

LF470711-B / LF470712-B

Also available with Brass Plunger &
Polished Gold stem

LF470711-PG / LF470712-PG

LF270701-PG / LF270702-PG Stem Only

Chrome Plated Stem / Plastic Plunger

LENGTH: 4.24"

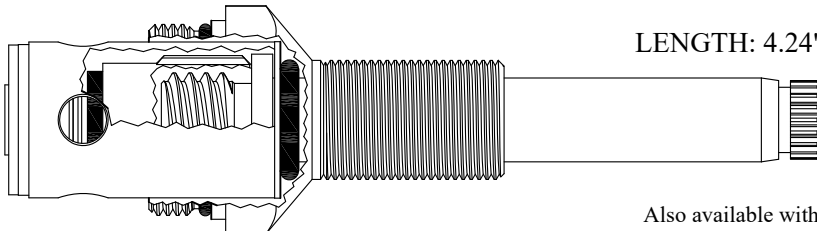

1-7

SEAT INCLUDED: LF649460

LF470721/ LF470722

GASKET: 890200 O-RING INCLUDED

LF270701/ LF270702 Stem Only

Also available with Brass Plunger

LF470721-B / LF470722-B

Also available with Brass Plunger &
Polished Gold stem

LF470721-PG / LF470722-PG

LF270701-PG / LF270702-PG Stem Only

FOR KOHLER

Quadruple Lead
Chrome Plated Stem

LENGTH: 4.34"

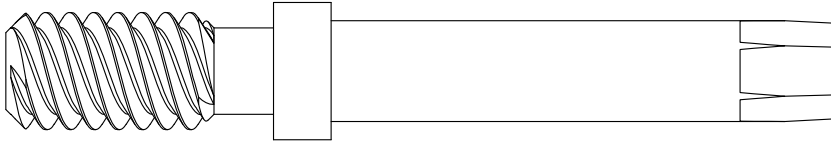

206161

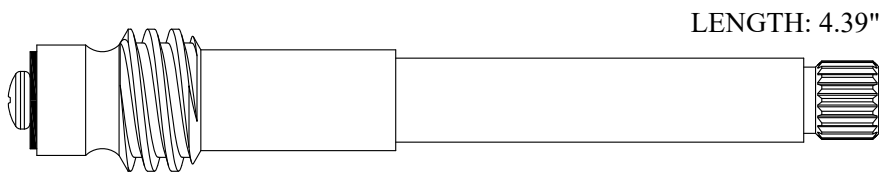
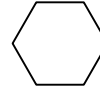

LENGTH: 4.39"

LF273361/ LF273362



SEAT USED: LF648730



1-7



STEM LENGTH: 4.60"

LF474501/ LF474502

GASKET INCLUDED: 895350

INCLUDES BARREL:
647321/647322



1-7

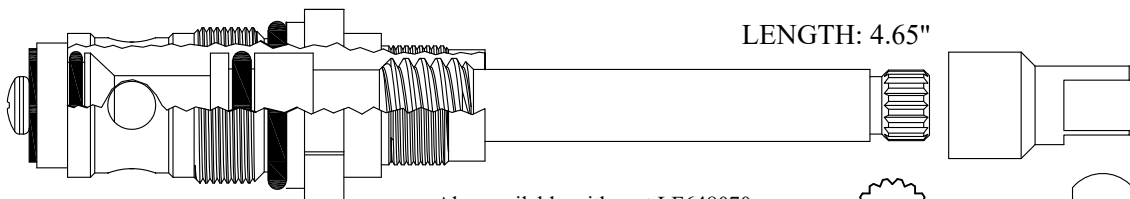

LENGTH: 4.65"

433121

GASKET: 891150 O-RING INCLUDED
OEM # 70424

Also available with seat LF648070

433121-S



1-6

FOR KOHLER



LENGTH: 4.74"

431291



Plastic Escutcheon Nipple

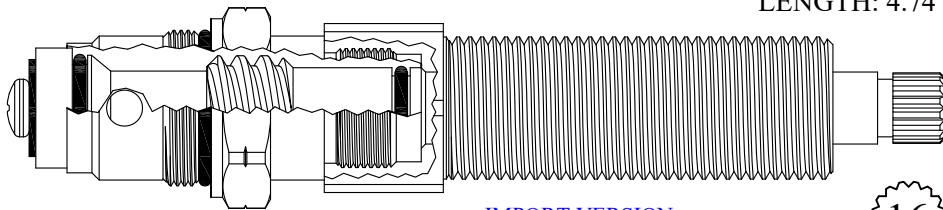

LENGTH: 4.74"

430941

GASKET: 890170 O-RING INCLUDED
OEM # 40281, 30467, 21130

IMPORT VERSION
KO21111

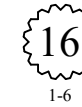

Chrome Plated Stem

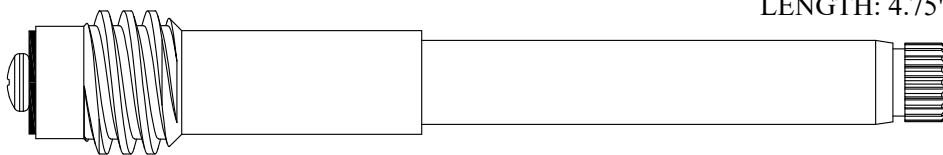

LENGTH: 4.75"

LF276011/ LF276012

OEM # 37646/ 37645



SEAT USED: LF648730



LENGTH: 4.89"

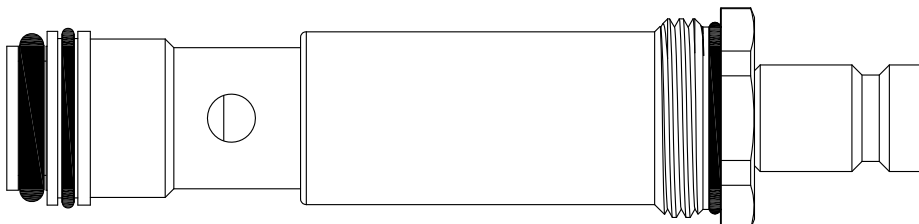

436180

GASKET: 890200 O-RING INCLUDED
OEM # 74392

FOR KOHLER

Chrome Plated Stem

LENGTH: 5.00"

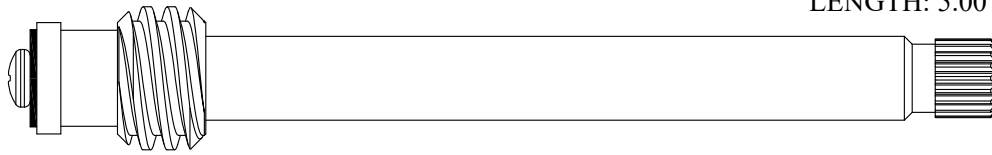

LF277051/ LF277052



Chrome Plated Stem / Plastic Plunger

LENGTH: 5.04"

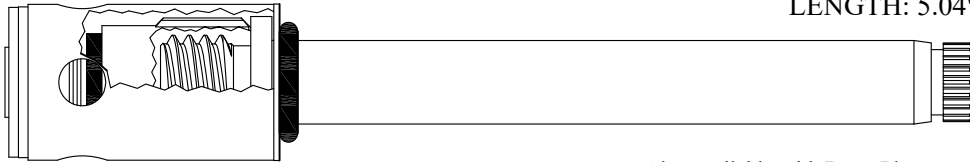

SEAT: LF649460 INCLUDED

407001/ 407002

OEM # 30137/ 20654

207001/ 207002 Stem Only

OEM # 20413

Also available with Brass Plunger

407001-B / 407002-B

OEM # 30137/ 30138

Also available with Brass Plunger &

Polished Gold stem

407001-PG / 407002-PG



Chrome Plated Stem / Plastic Plunger

LENGTH: 5.04"

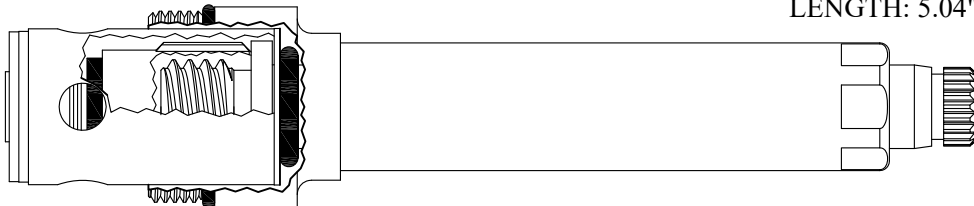

SEAT: LF649460 INCLUDED

407021/ 407022

GASKET: 890210 O-RING INCLUDED

207001/ 207002 Stem Only

Also available with Brass Plunger

407021-B / 407022-B



Chrome Plated Stem / Plastic Plunger

LENGTH: 5.04"

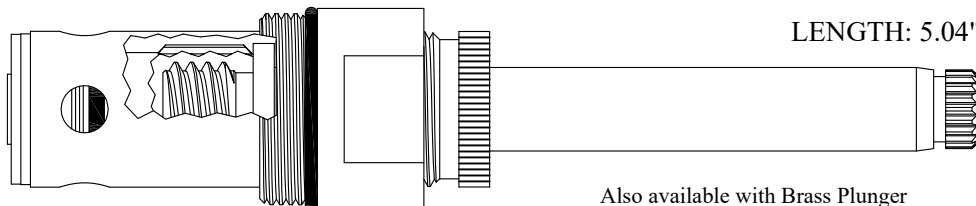

SEAT: LF649460 INCLUDED

407031/ 407032

GASKET: 890210 O-RING INCLUDED

207001/ 207002 Stem Only

Also available with Brass Plunger

407031-B / 407032-B

Also available with Brass Plunger &

Polished Gold stem

407031-PG / 407032-PG



FOR KOHLER

Chrome Plated Stem / Brass Plunger

LENGTH: 5.04"

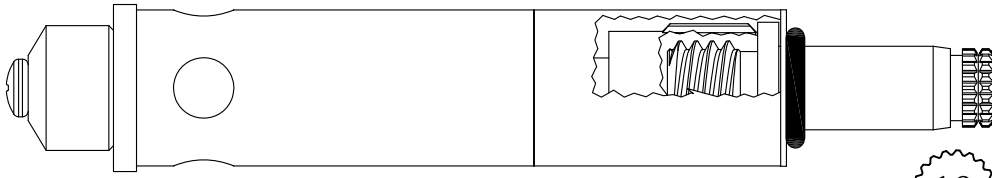

431412

19
1-7

Chrome Plated Stem / Brass Plunger

LENGTH: 5.04"

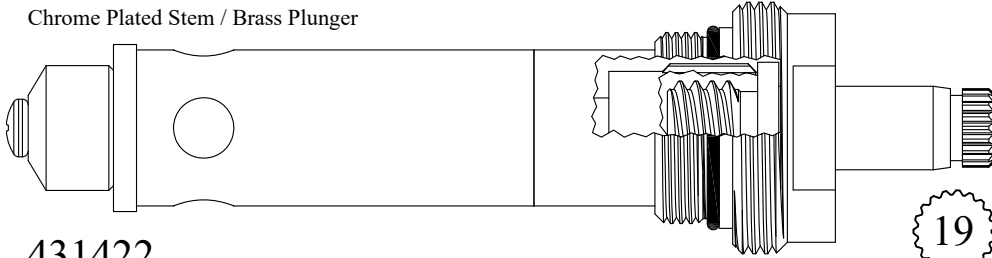

431422

GASKET: 890210 O-RING INCLUDED
OEM # 23070

19
1-7

Plastic Escutcheon Nipple

LENGTH: 5.08"

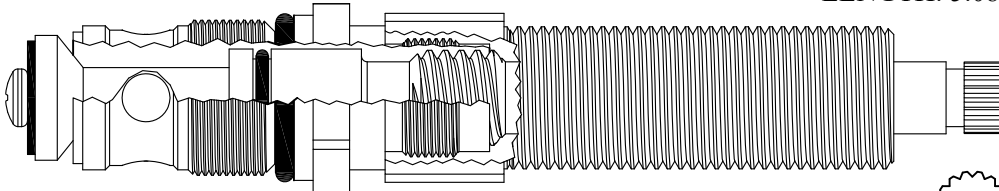

433171

GASKET: 891150 O-RING INCLUDED
OEM # 30139

IMPORT VERSION
KO21112

16
1-6

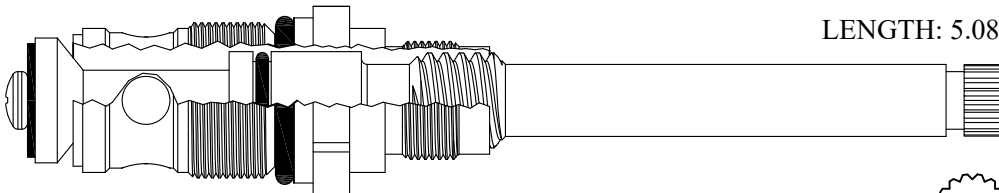

433181

GASKET: 891150 O-RING INCLUDED

LENGTH: 5.08"

16
1-6

Chrome Escutcheon Tube

LENGTH: 5.08"

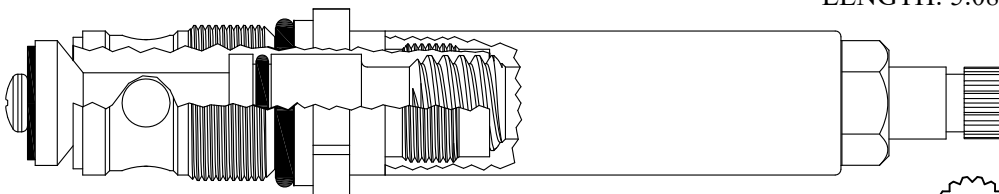

433191

GASKET: 891150 O-RING INCLUDED

16
1-6

FOR KOHLER



432810

GASKET: 891150 O-RING INCLUDED
OEM # 42011

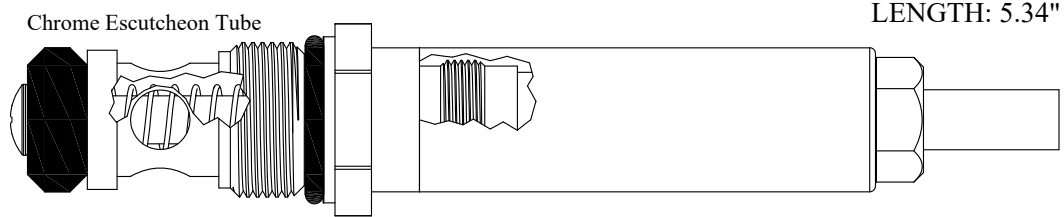

432910

GASKET: 891150 O-RING INCLUDED
OEM # 20868, 30050

IMPORT VERSION
KO21114

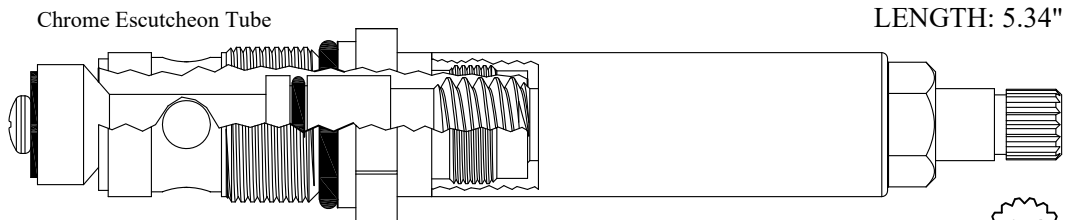

433211

GASKET: 891150 O-RING INCLUDED
OEM # 21131

16

1-6

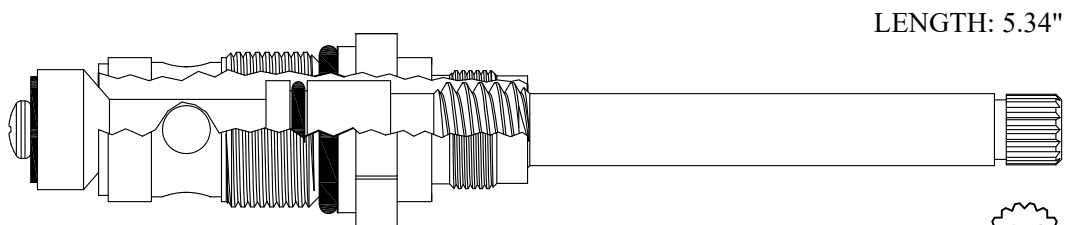

433231

GASKET: 891150 O-RING INCLUDED

16

1-6

FOR KOHLER

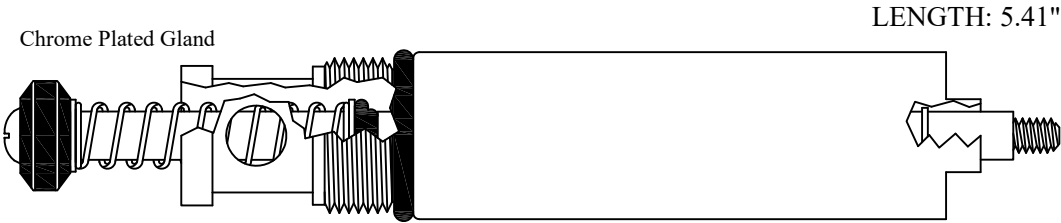

432830

GASKET: 891150 O-RING INCLUDED
OEM # 31439-BC

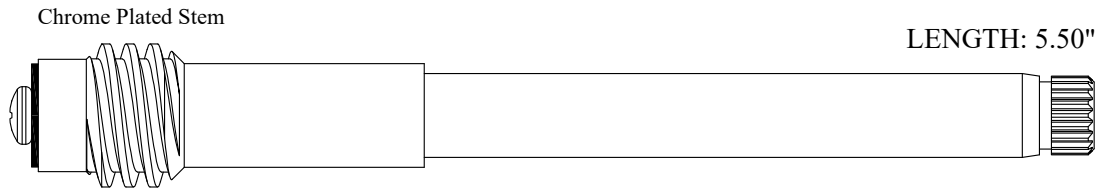

LF280051/ LF280052

OEM # 39821/ 39863

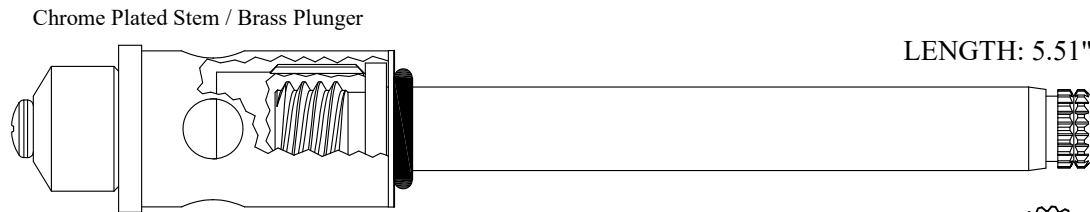

433412

OEM # 30123

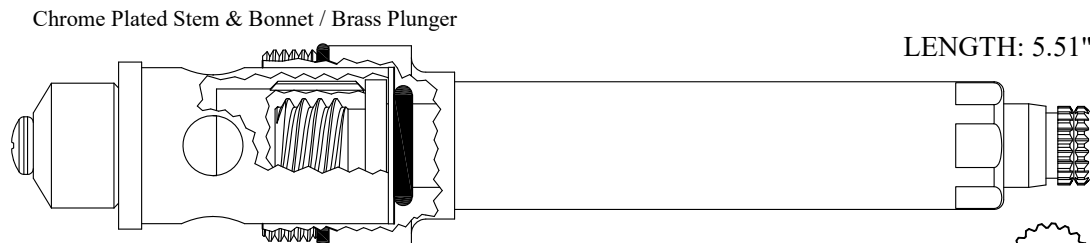

433422

GASKET: 890210 O-RING INCLUDED



FOR KOHLER

Chrome Plated Stem

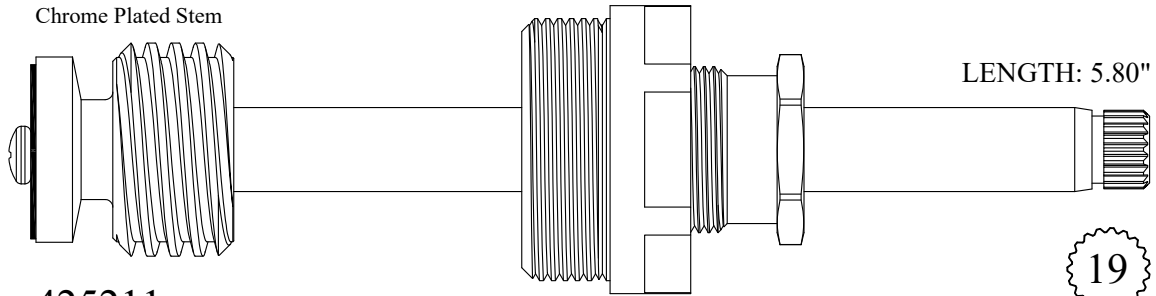

LENGTH: 5.80"

425211
225211 Stem Only

19
1-7

Chrome Plated Stem

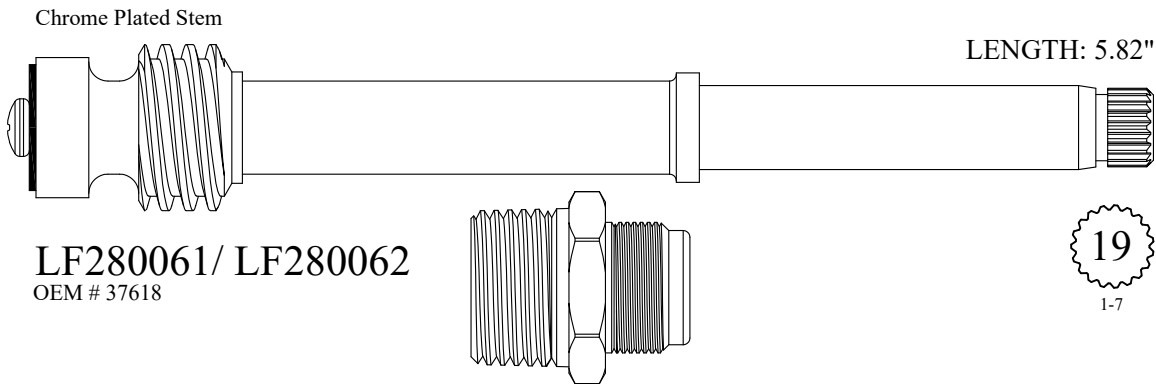

LENGTH: 5.82"

LF280061/ LF280062
OEM # 37618

19
1-7

SEAT USED: LF647500

Chrome Plated Stem

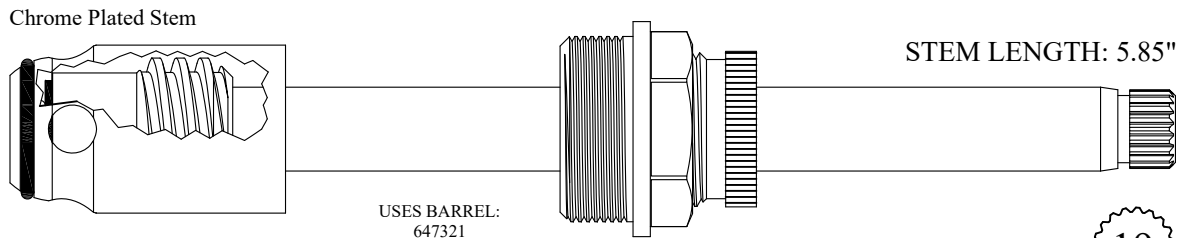

STEM LENGTH: 5.85"

425931
GASKET INCLUDED: 895350
225901 Stem Only
OEM # 20242

USES BARREL:
647321

19
1-7

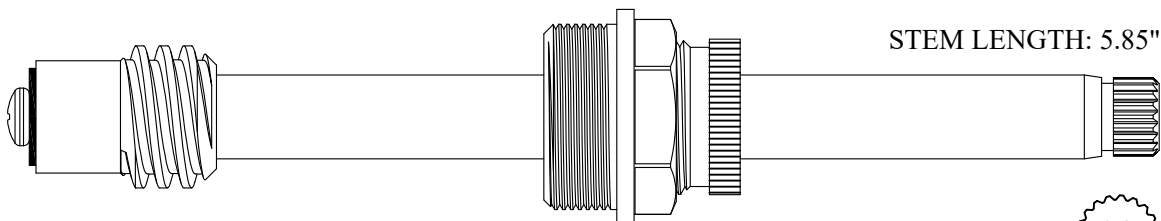

STEM LENGTH: 5.85"

425921/ 425922
GASKET INCLUDED: 895350
225901/ 225902 Stem Only
OEM # 20242/ 22842-BC

19
1-7

FOR KOHLER

Chrome Plated Stem

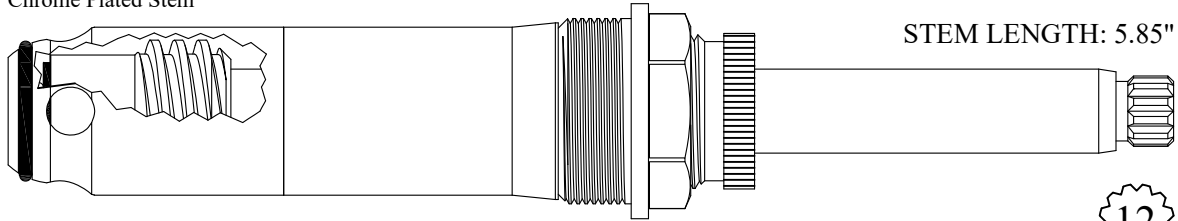

STEM LENGTH: 5.85"

425951/ 425952

GASKET INCLUDED: 895350

225951/ 225952 Stem Only

INCLUDES BARREL:
647321/647322

12

1-2

Chrome Plated Stem & Packing Nut

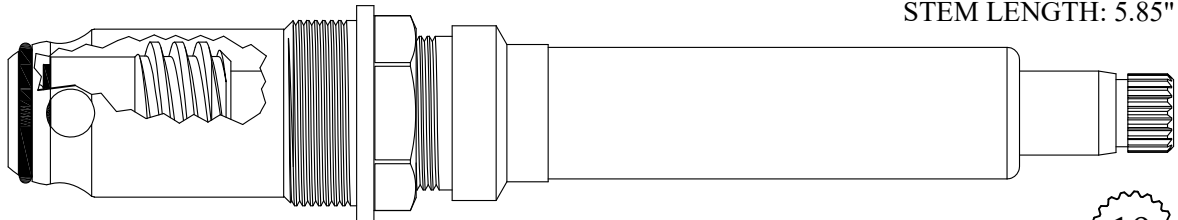

STEM LENGTH: 5.85"

425961/ 425962

GASKET INCLUDED: 895350

225901/ 225902 Stem Only

OEM # 20242/ 22842-BC

INCLUDES BARREL:
647321/647322

19

1-7

Chrome Plated Stem

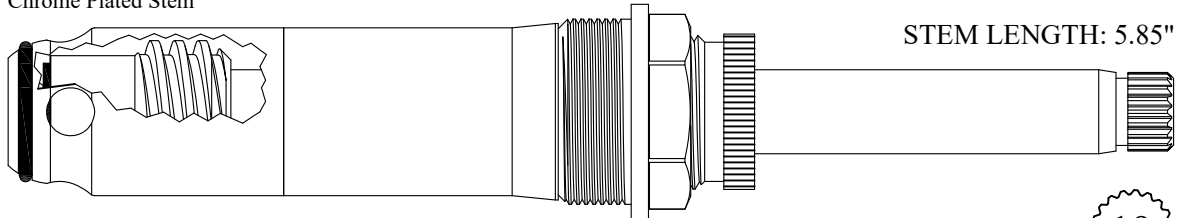

STEM LENGTH: 5.85"

425901/ 425902

GASKET INCLUDED: 895350

225901/ 225902 Stem Only

OEM # 20242/ 22842-BC

INCLUDES BARREL:
647321/647322

19

1-7

Chrome Plated Stem

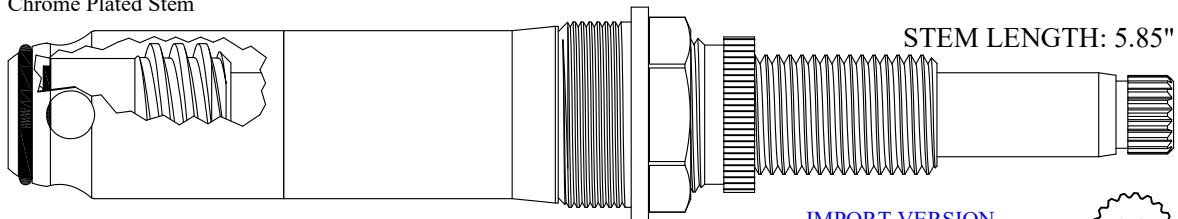

STEM LENGTH: 5.85"

425911/ 425912

GASKET INCLUDED: 895350

225901/ 225902 Stem Only

OEM # 20242/ 22842-BC

INCLUDES BARREL:
647321/647322

IMPORT VERSION
KO21104

19

1-7

FOR KOHLER

Chrome Plated Stem



LENGTH: 5.98"

437311

GASKET INCLUDED: 895350

237311 Stem Only

OEM # 22881

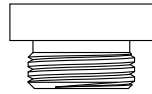

SEAT USED: 649700

19

1-7

Chrome Plated Stem & Packing Nut

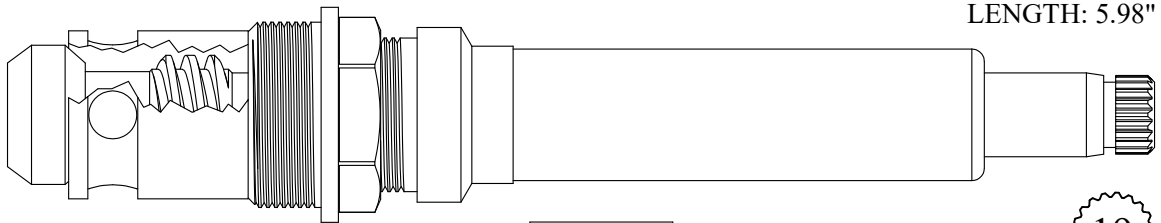

LENGTH: 5.98"

437321

GASKET INCLUDED: 895350

237311 Stem Only

OEM # 22881

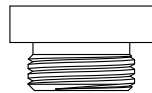

SEAT USED: 649700

19

1-7

Chrome Plated Stem

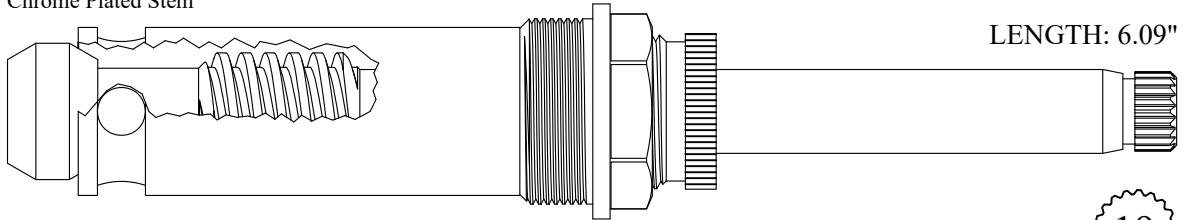

LENGTH: 6.09"

437301

GASKET INCLUDED: 895350

237301 Stem Only

OEM # 22862

Also available with seat 649700

437301-S

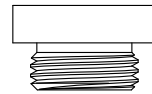

19

1-7

Chrome Plated Stem

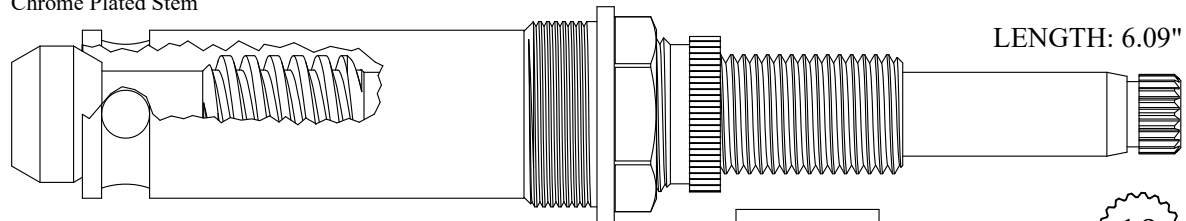

LENGTH: 6.09"

437331

GASKET INCLUDED: 895350

237301 Stem Only

OEM # 22862

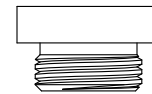

SEAT USED: 649700

19

1-7

FOR KOHLER

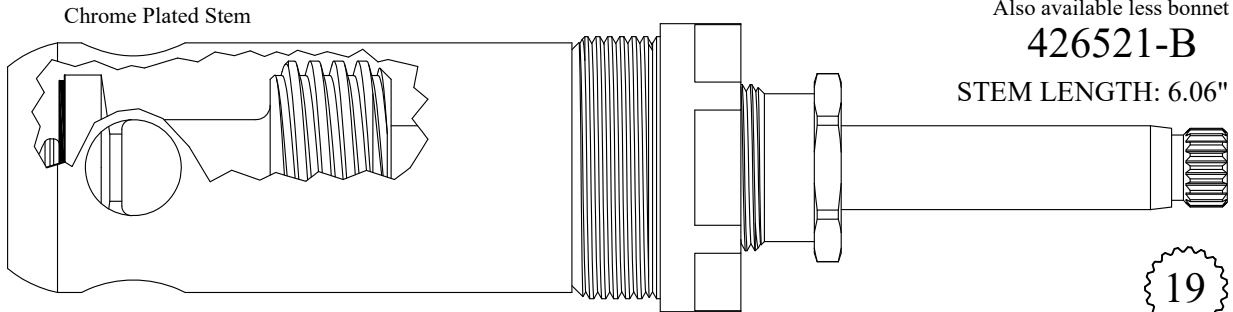

426521
226521 Stem Only
OEM # 20277

INCLUDES BARREL:
647361

19
1-7

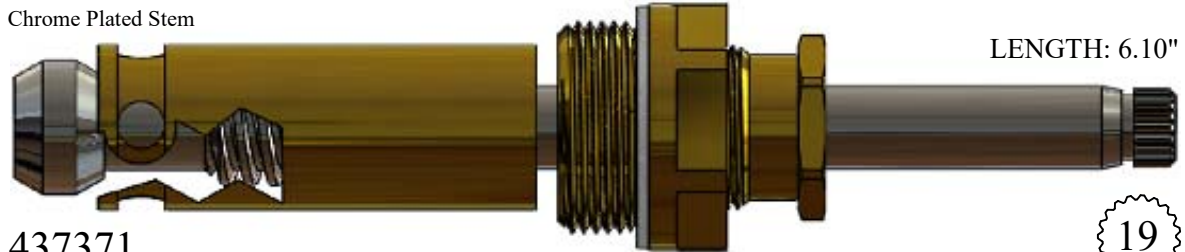

437371
GASKET INCLUDED: 895350
OEM # 22862

19
1-7

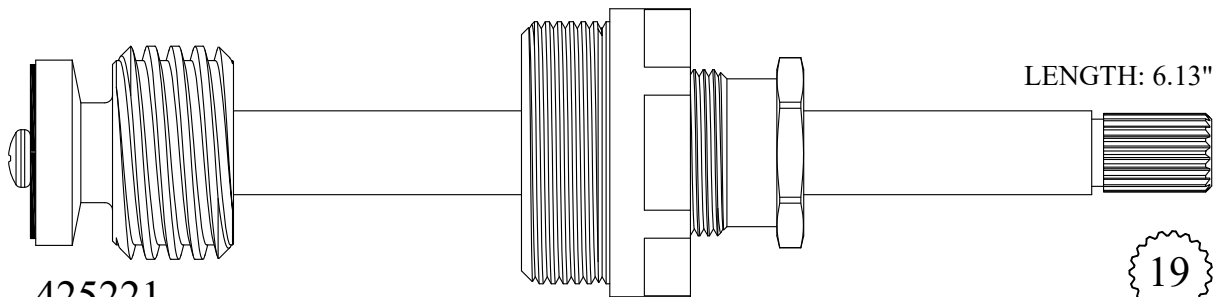

425221
225221 Stem Only

19
1-7

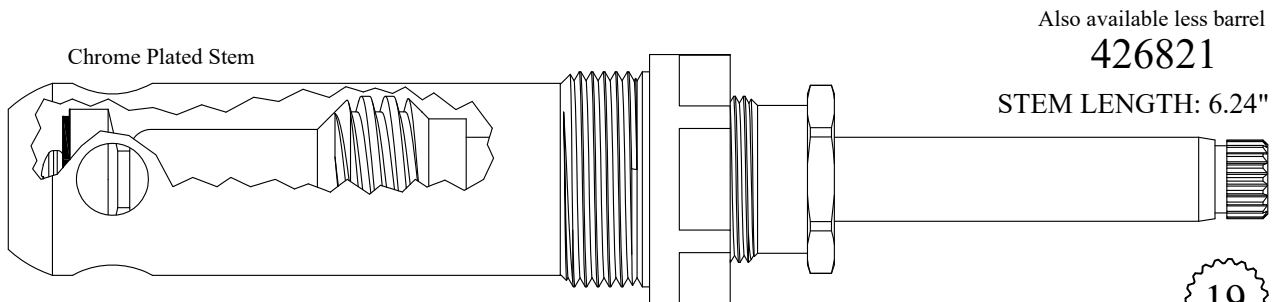

426801
GASKET INCLUDED: 895450
226801 Stem Only
OEM # 20072

INCLUDES BARREL:
647331

19
1-7

FOR KOHLER

Chrome Plated Stem

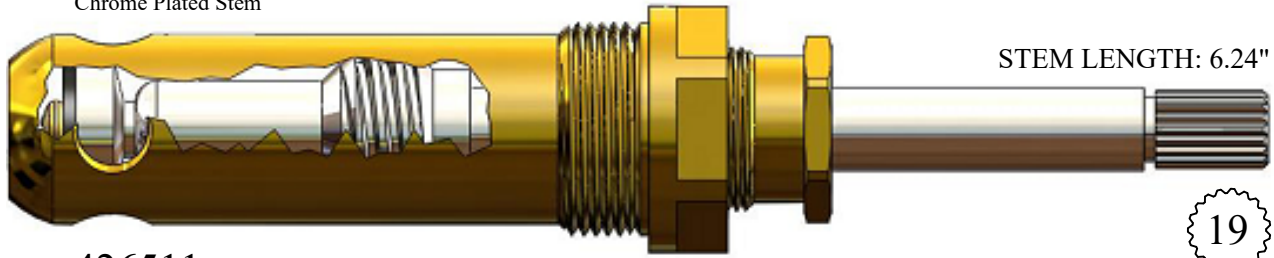

STEM LENGTH: 6.24"

426511
GASKET INCLUDED: 895450

INCLUDES BARREL:
647331

19
1-7

Chrome Plated Stem

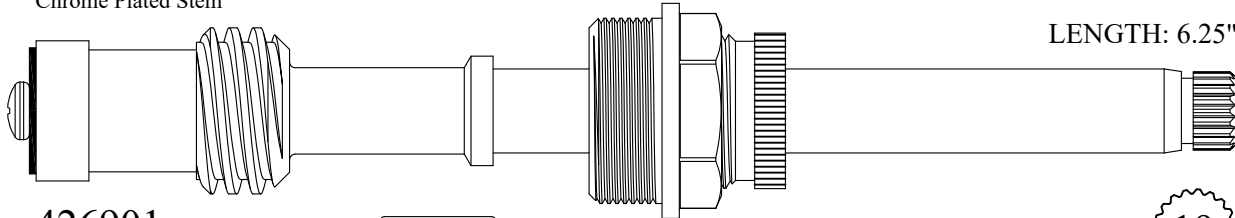

LENGTH: 6.25"

426901
GASKET INCLUDED: 895350
226901 Stem Only
OEM # 20140

SEAT USED: LF647230

19
1-7

Chrome Plated Stem

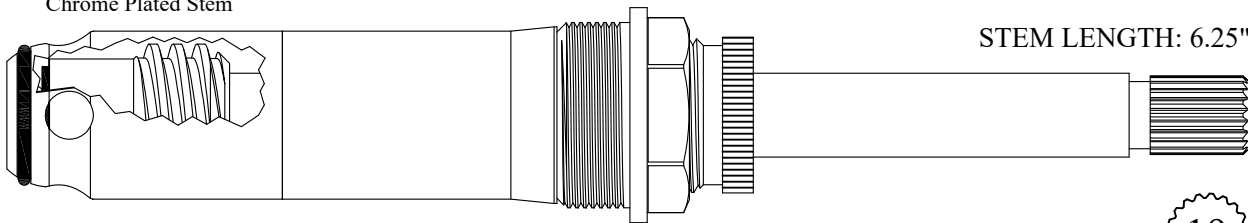

STEM LENGTH: 6.25"

426701
GASKET INCLUDED: 895350
226701 Stem Only

INCLUDES BARREL:
647321

19
1-7

Chrome Plated Stem

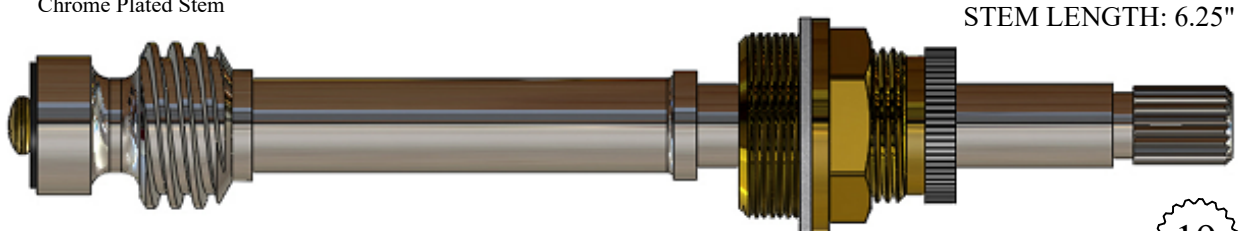

STEM LENGTH: 6.25"

LF480701
LF280701 Stem Only

19
1-7

FOR KOHLER

Chrome Plated Stem

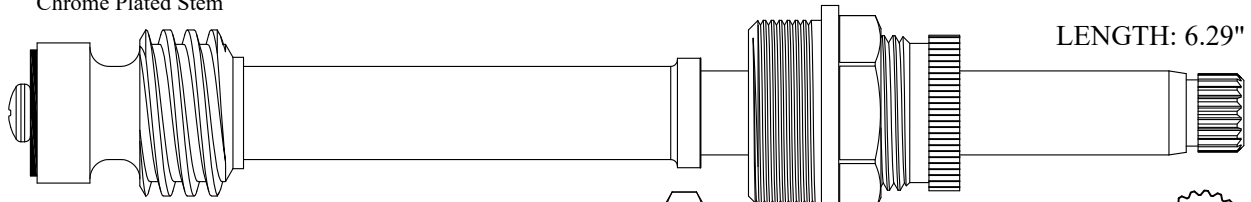

LENGTH: 6.29"

LF480501/ LF480502

GASKET INCLUDED: 895350

LF280501/ LF280502 Stem Only

OEM # 31754

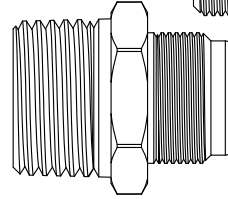

SEAT USED: LF647500

19

1-7

Chrome Plated Stem

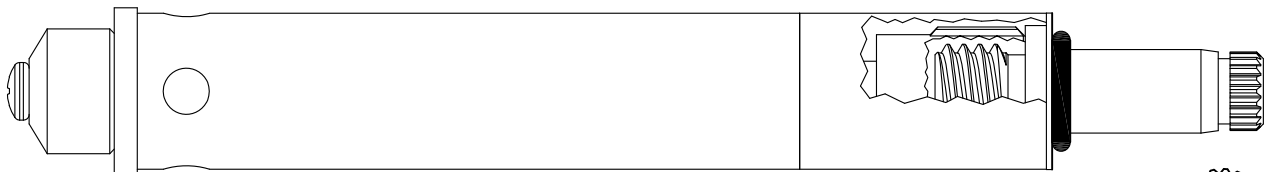

LENGTH: 6.43"

439502

19

1-7

Chrome Plated Stem

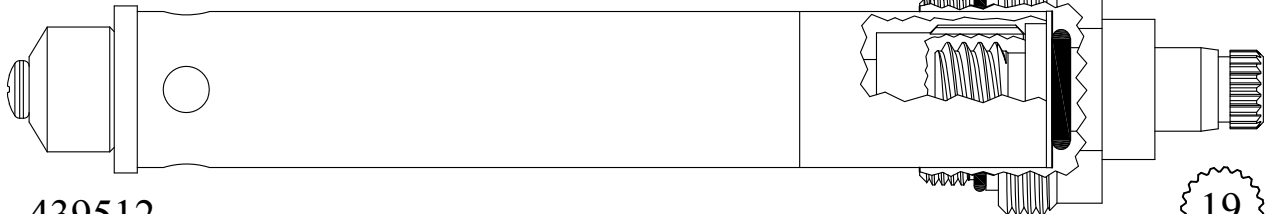

LENGTH: 6.43"

439512

GASKET: 890210 O-RING INCLUDED

19

1-7

Chrome Plated Stem

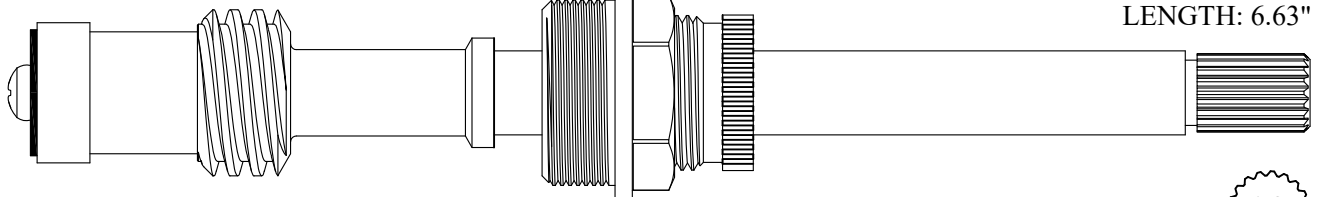

LENGTH: 6.63"

426921

GASKET INCLUDED: 895350

226921 Stem Only

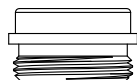

SEAT USED: LF647230

19

1-7

FOR KOHLER

LENGTH: 6.67"

Chrome Plated Gland

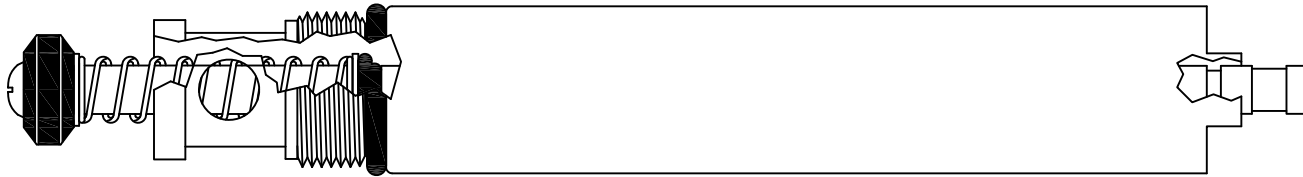

434600

GASKET: 891150 O-RING INCLUDED
OEM # 42020-CP

Chrome Plated Stem

LENGTH: 6.83"

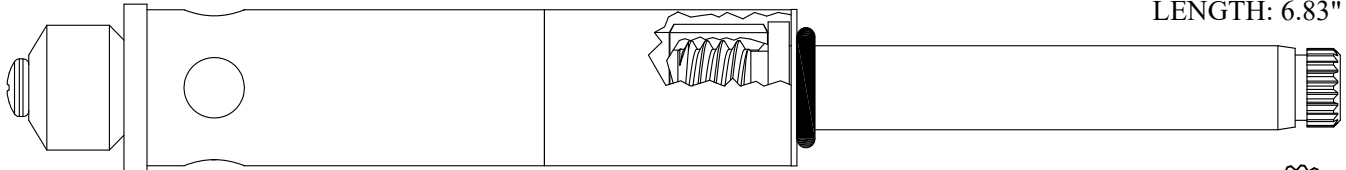

439312

19
1-7

Chrome Plated Stem

LENGTH: 6.83"

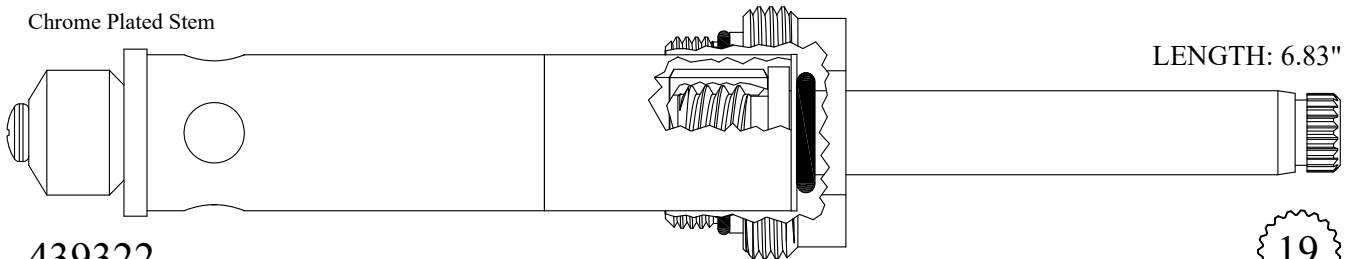

439322

19
1-7

Chrome Plated Stem

STEM LENGTH: 6.86"

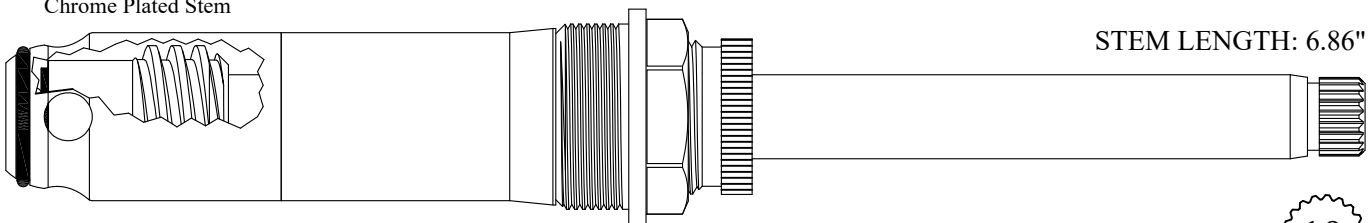

426711

GASKET INCLUDED: 895350
226711 Stem Only

INCLUDES BARREL:
647321

19
1-7

FOR KOHLER

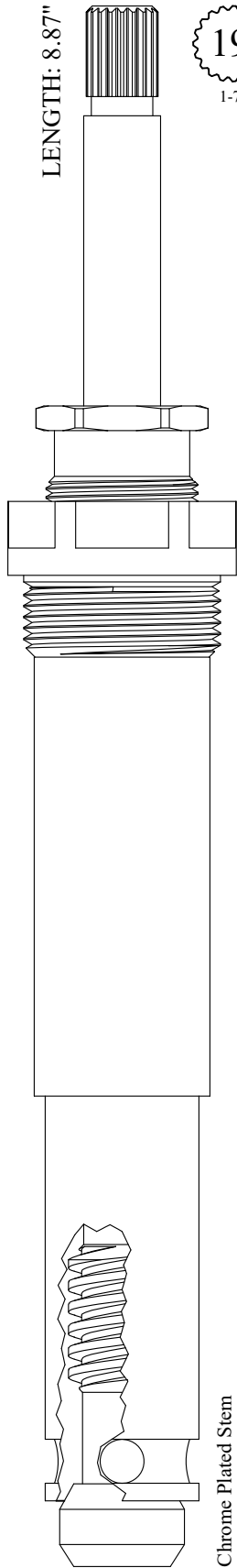

LENGTH: 8.87"

19
1-7

Chrome Plated Stem

GASKET INCLUDED: 895450

439801
239801 Stem Only

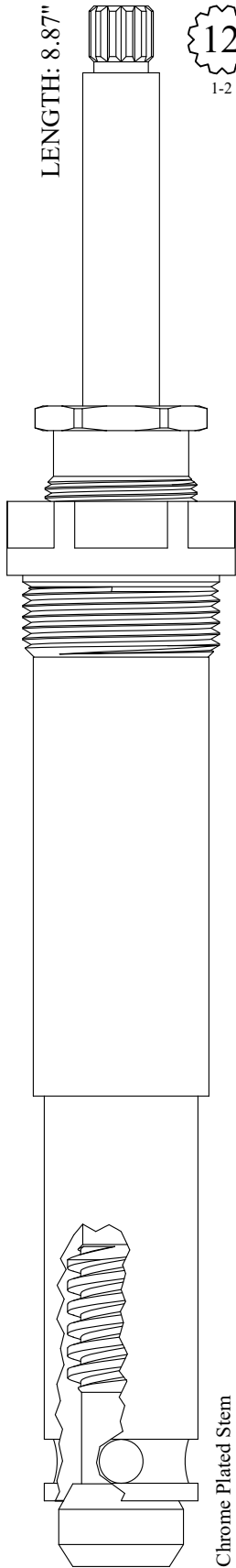

LENGTH: 8.87"

12
1-2

Chrome Plated Stem

GASKET INCLUDED: 895450

439851
239851 Stem Only

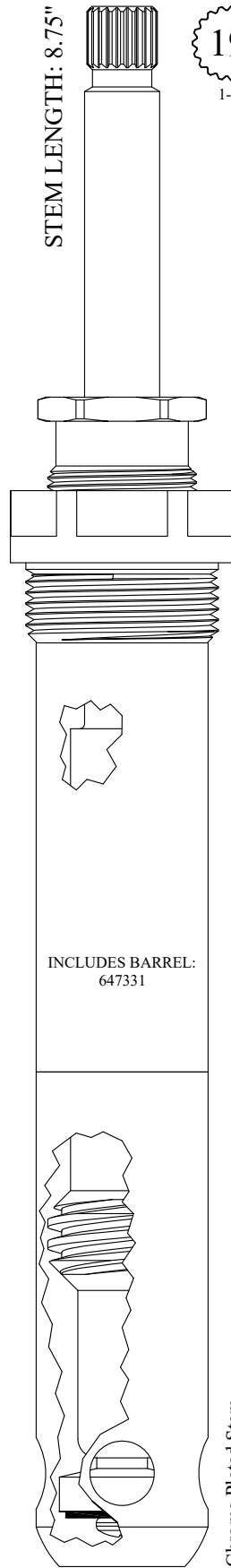

STEM LENGTH: 8.75"

19
1-7

Chrome Plated Stem

INCLUDES BARREL:
647331

GASKET INCLUDED: 895450

428331
228331 Stem Only

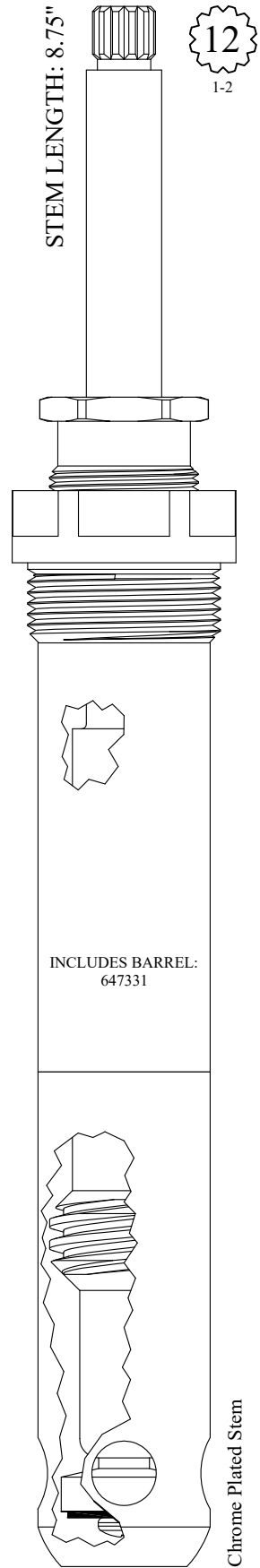

STEM LENGTH: 8.75"

12
1-2

Chrome Plated Stem

INCLUDES BARREL:
647331

GASKET INCLUDED: 895450

428381
228381 Stem Only

FOR LABONGE

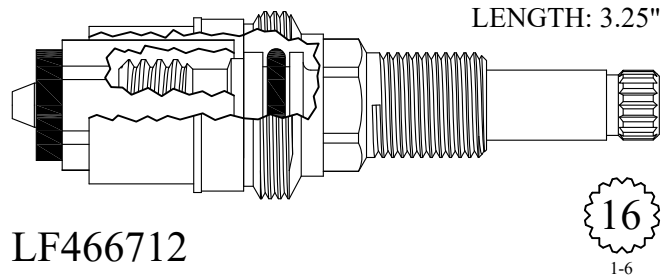

FOR LARDEN

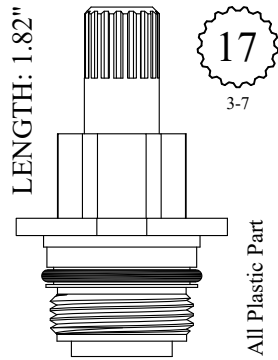

454351

FOR LAWLER

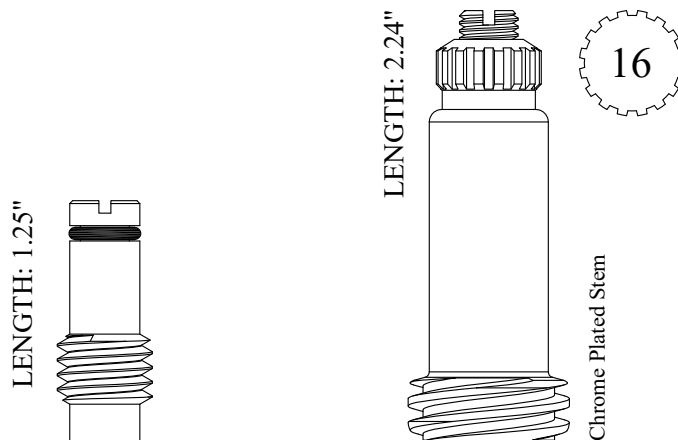

LF200751

201021

FOR LENHART

Chrome Plated Stem

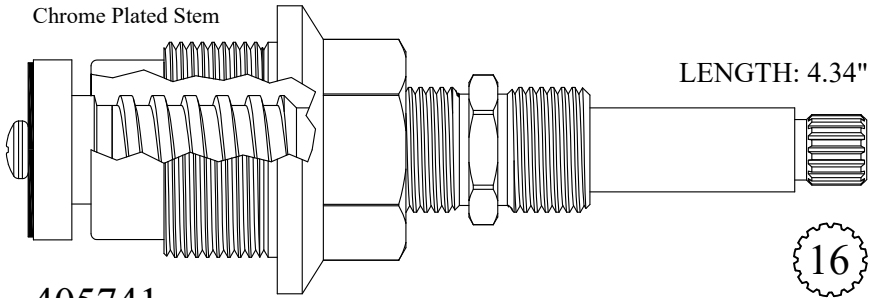

LENGTH: 4.34"

16
3-15

405741

GASKET INCLUDED: 895450

Chrome Plated Stem

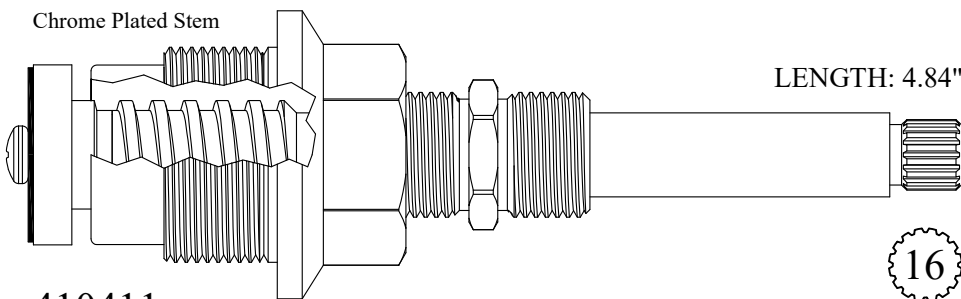

LENGTH: 4.84"

16
3-15

410411

GASKET INCLUDED: 895450

210411 Stem Only

Chrome Plated Stem

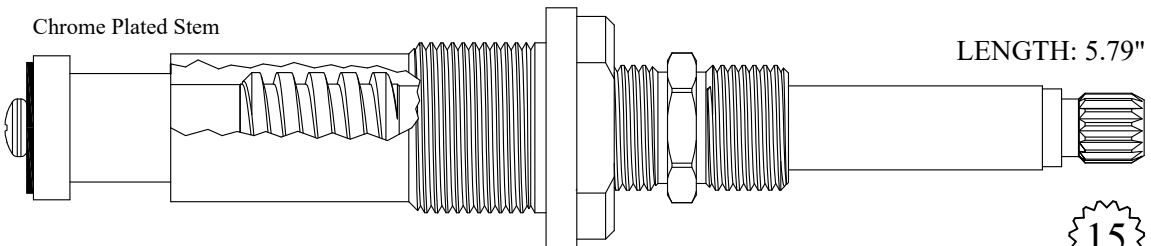

LENGTH: 5.79"

15
1-13

425611

GASKET INCLUDED: 895370

225611 Stem Only

Chrome Plated Stem

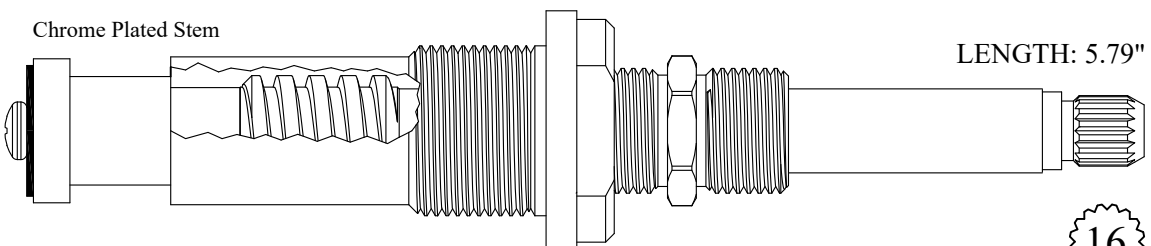

LENGTH: 5.79"

16
1-6

425621

GASKET INCLUDED: 895370

225621 Stem Only

FOR LEONARD

LENGTH: 1.39"



LF400771
LF400771-P Pair



LF400701
LF400701-P Pair

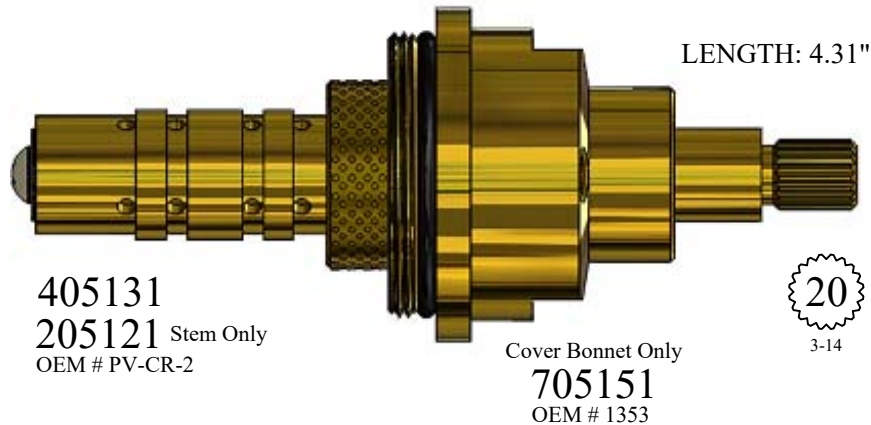
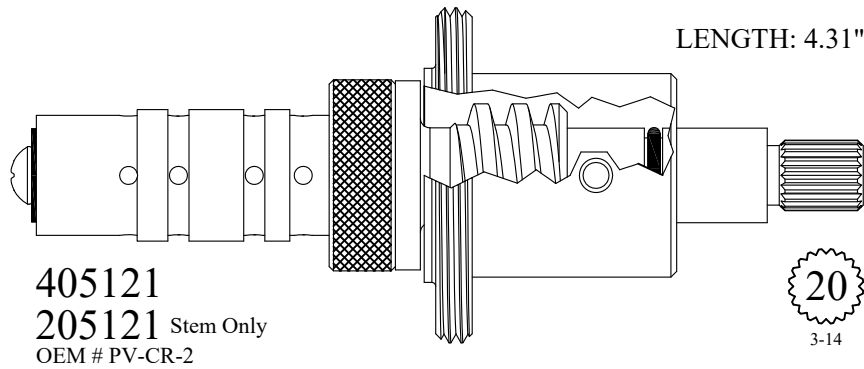
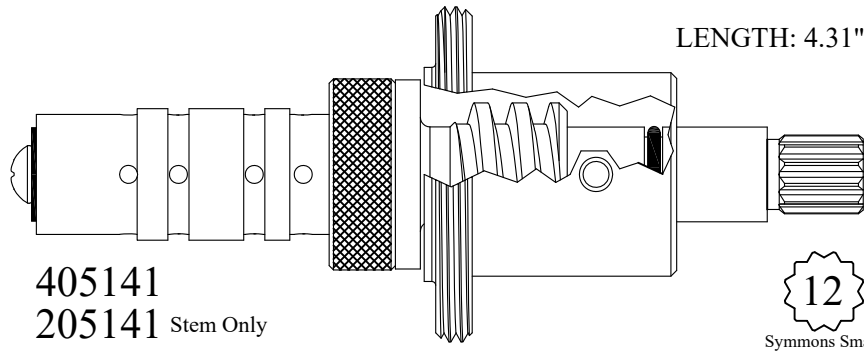

FOR LEONARD

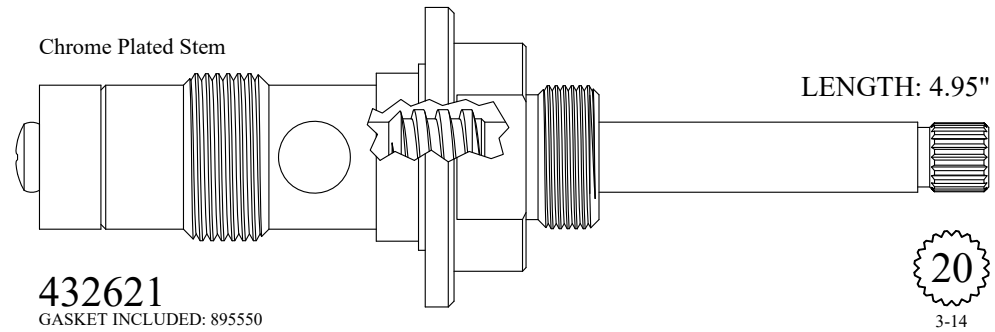
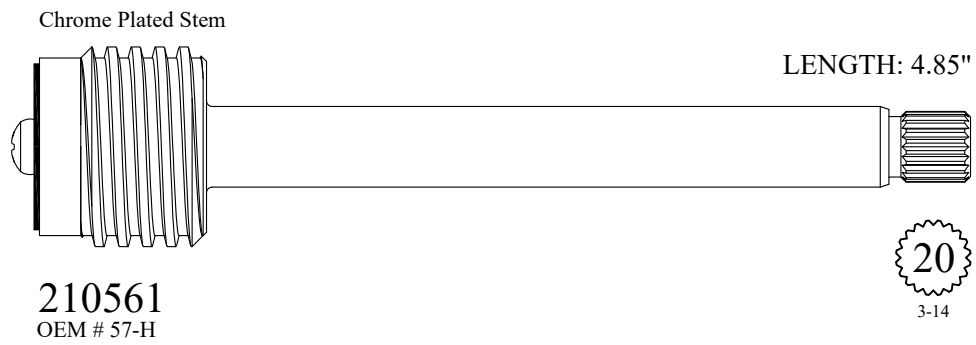

FOR LOGAN

Chrome Plated Stem



SEAT USED: 648800

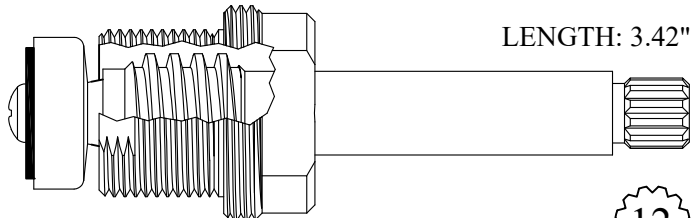

LENGTH: 3.42"

402811

GASKET INCLUDED: 895400

202811 Stem Only

OEM # 2656-000-002



Chrome Plated Unit
Polished Chrome Nut

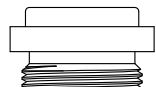

SEAT USED: 648800

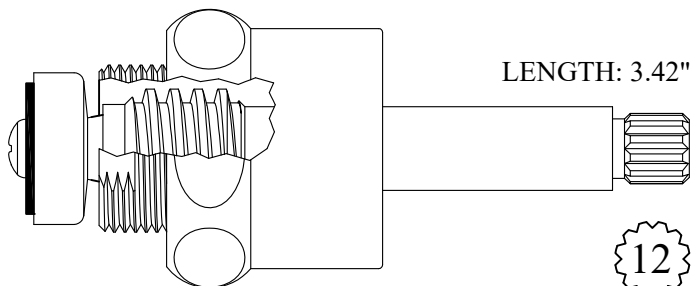

LENGTH: 3.42"

402811-N

GASKET INCLUDED: 895400

202811 Stem Only

OEM # 2656-000-002



Chrome Plated Stem
1-1/8" - 18 TPI

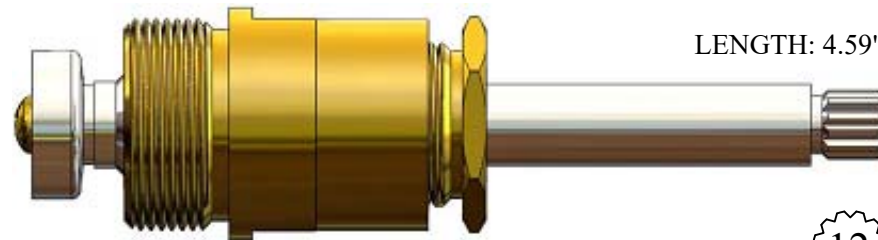

LENGTH: 4.59"

410041

GASKET INCLUDED: 894620



Chrome Plated Stem
1.00" - 18 TPI

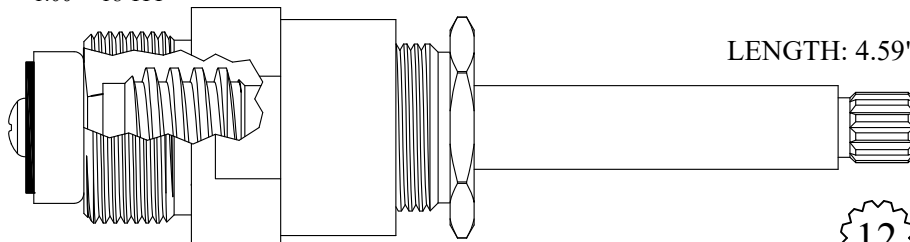

LENGTH: 4.59"

410011

GASKET INCLUDED: 895430

210011 Stem Only



FOR LOGAN

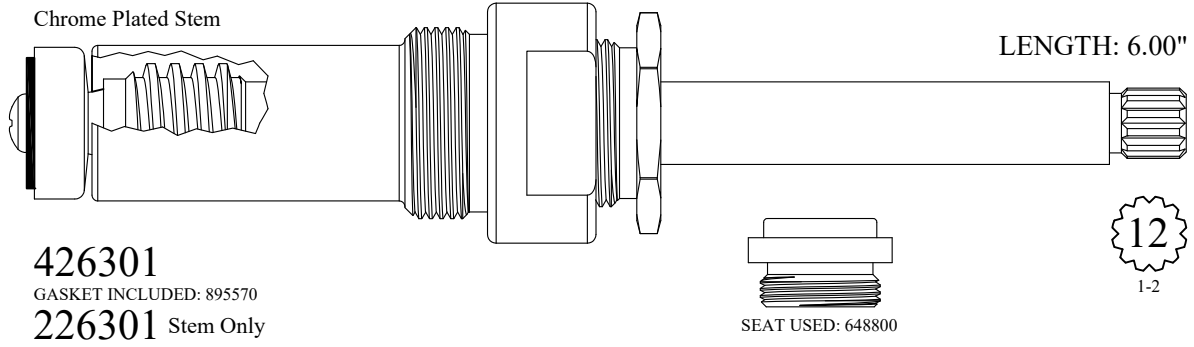

Also available in the following lengths:

THESE STEMS ARE ALL
CHROME PLATED

UNIT	STEM ONLY	LENGTH
427201	227201	6.50"
427501	227501	7.00"
428301	228301	8.00"
428401	228401	9.50"
429301	229301	12.00"
429501	229501	14.00"
429601	229601	16.00"
429701	229701	18.00"

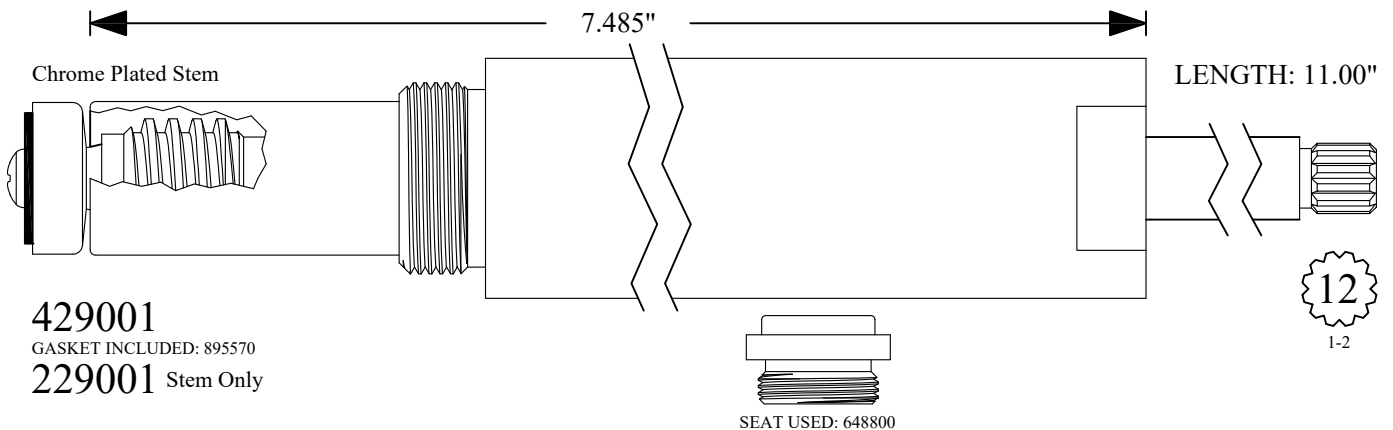
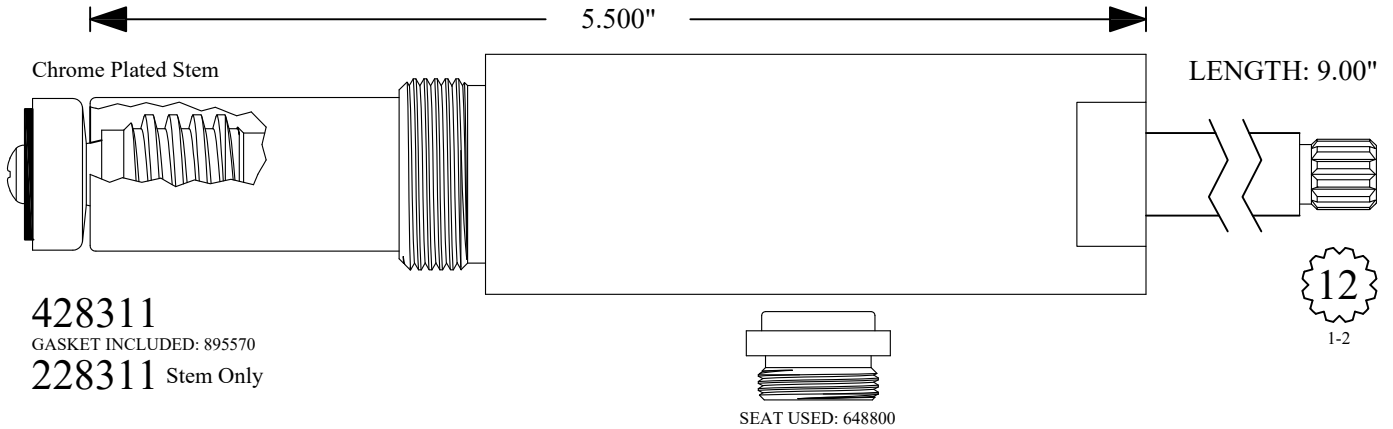

FOR MANSFIELD

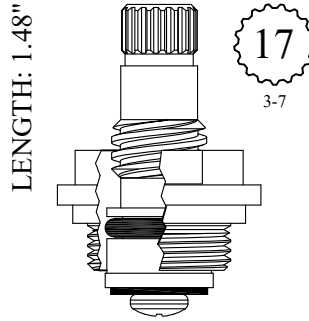

GASKET INCLUDED: 895100

LF450981
LF450982

FOR McCAMBRIDGE

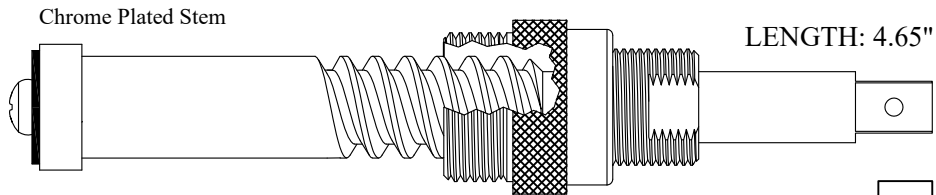

408651

GASKET INCLUDED: 895160

208651 Stem Only

FOR MELCLIFF

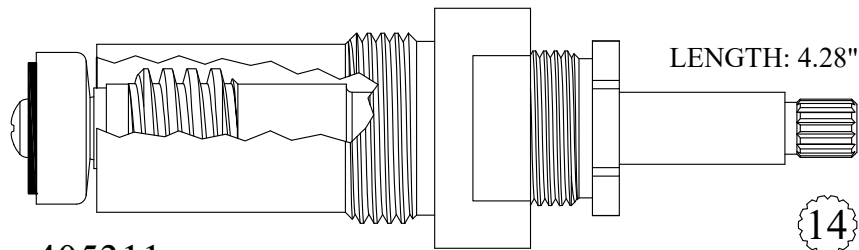

405311

GASKET INCLUDED: 895550

205311 Stem Only

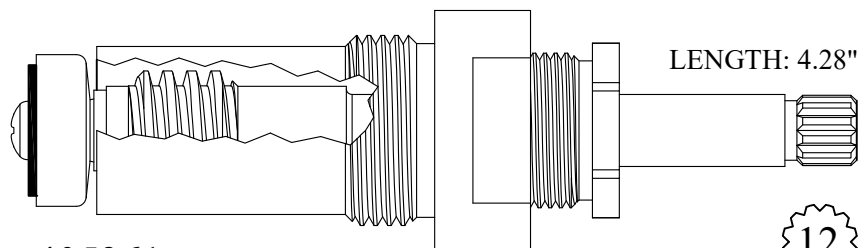

405361

GASKET INCLUDED: 895550

205361 Stem Only

1-2

FOR METCRAFT

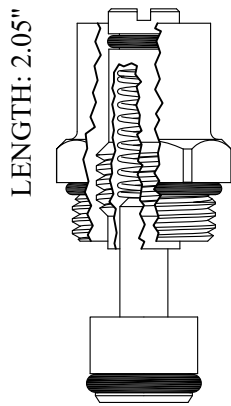

GASKET: 890170 O-RING INCLUDED

LF400751

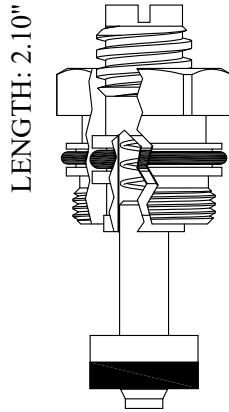

LF400441
OEM # 0660282A

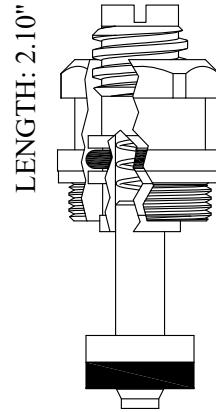

GASKET: 895100 INCLUDED

LF400461

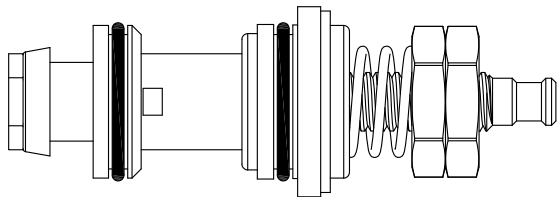

LF128000

LENGTH: 2.85"

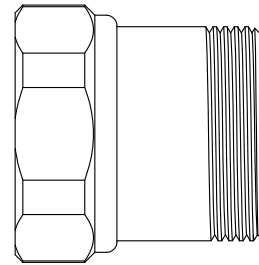

NON-METERING

LENGTH: 3.00"



LF154110

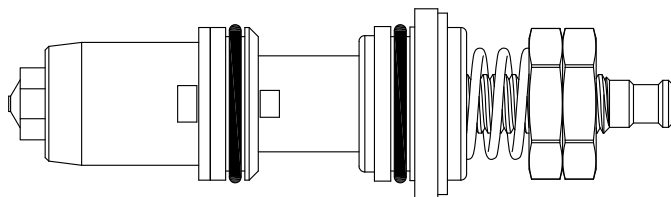

LF114090
LF114020 Cartridge Only

LENGTH: 3.46"

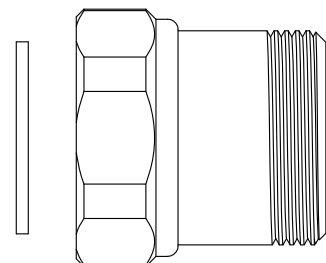

FOR MICHIGAN BRASS

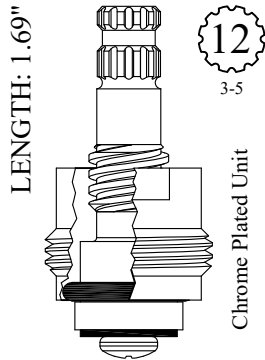

GASKET: 891120 O-RING INCLUDED

400621
400622

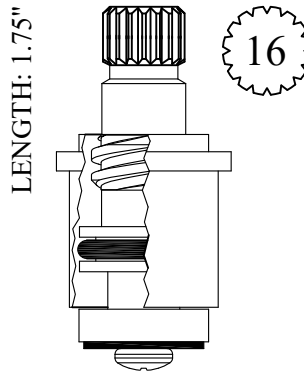

LF455091
LF455092



SEAT USED: LF648210

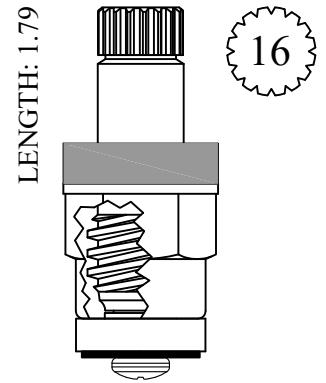

LF454151
LF454152

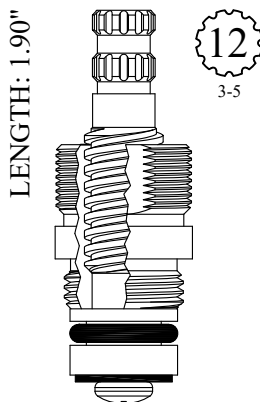

LF456821
LF456822



SEAT USED: LF648210

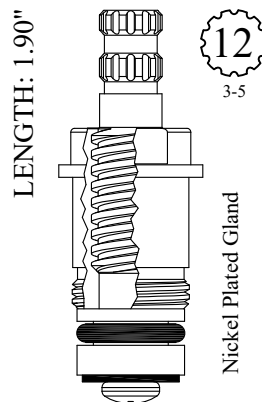

LF457021
LF457022



SEAT USED: LF648210

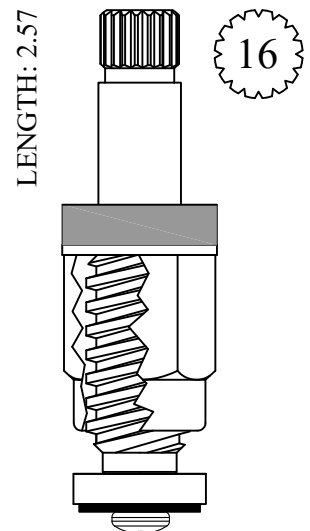

LF464141
LF464142

FOR MICHIGAN BRASS

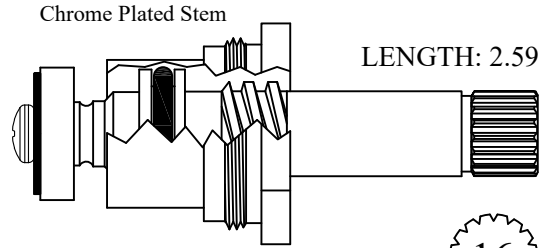

LF465321/ LF465322

16

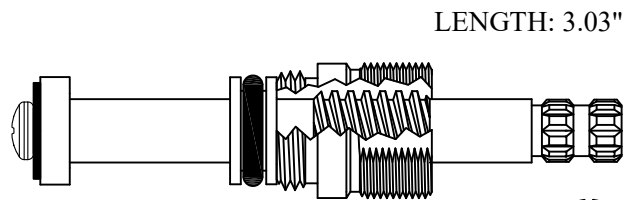
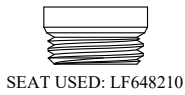

LF466101/ LF466102

12
3-5

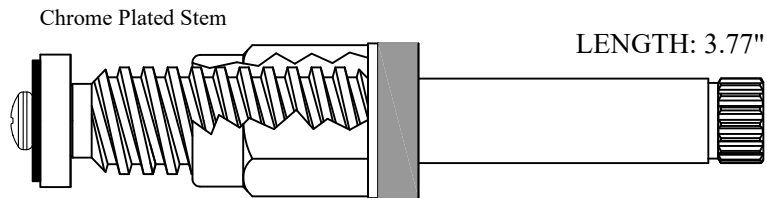

403271

16

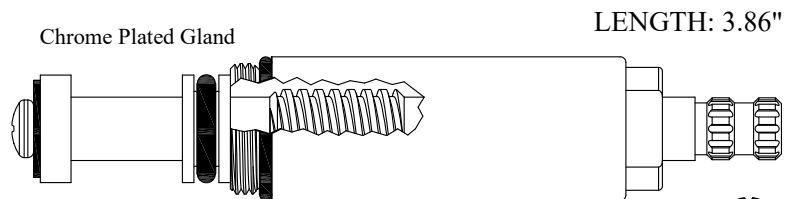

403421/ 403422

GASKET: 890160 O-RING INCLUDED

12
3-5

FOR MICHIGAN BRASS

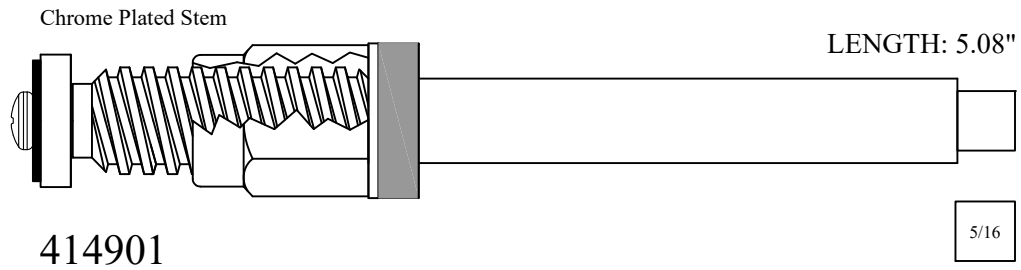
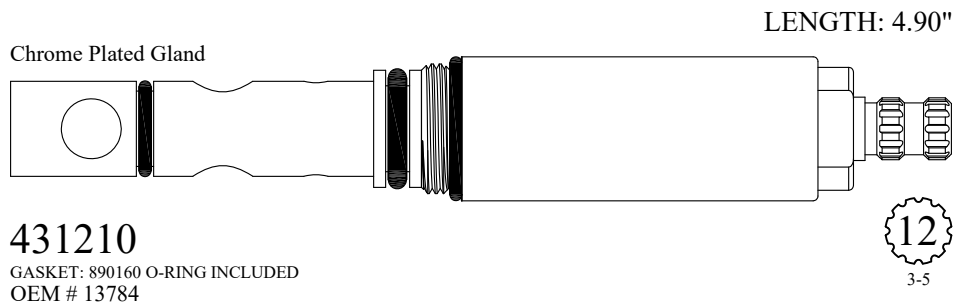
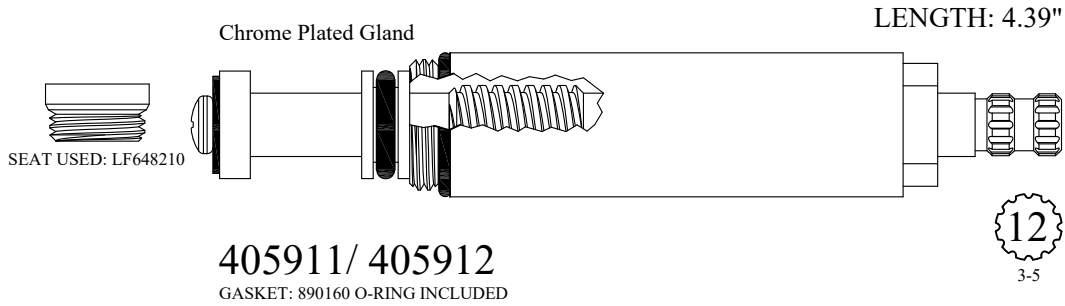

BARRY E.  WALTER  SR. CO.

FOR MILWAUKEE

LENGTH: 1.04"

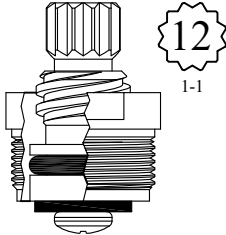

12
1-1

GASKET INCLUDED: 895100

LF450011
LF450012

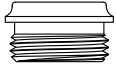

SEAT USED: LF649040

LENGTH: 1.43"

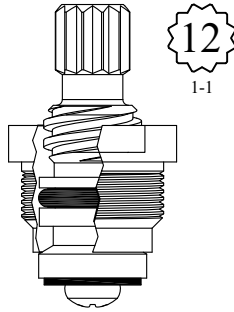

12
1-1

GASKET INCLUDED: 895100

LF451301
LF451302

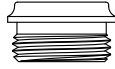

SEAT USED: LF649040

LENGTH: 1.43"



MW11325

LENGTH: 1.65"

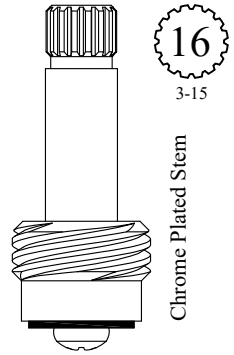

16
3-15

Chrome Plated Stem

201211
201212



SEAT USED: 648370

LENGTH: 1.65"



16
3-15

Chrome Plated Unit

401211
401212

LENGTH: 1.74"

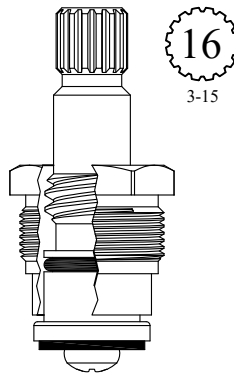

16
3-15

GASKET INCLUDED: 199930

LF453121
OEM # 5012
LF453122



SEAT USED: LF649040

LENGTH: 1.74"

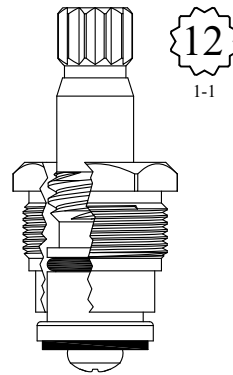

12
1-1

GASKET INCLUDED: 199930

LF453241
LF453242



SEAT USED: LF649040

LENGTH: 1.75"

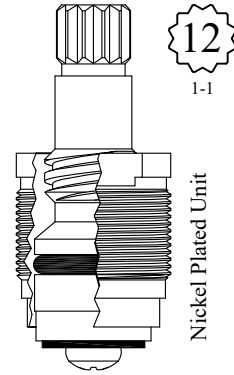

12
1-1

Nickel Plated Unit

GASKET INCLUDED: 894670

LF455021
LF455022

FOR MILWAUKEE

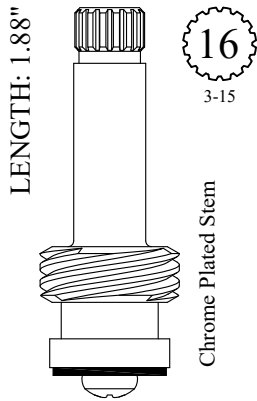

LF256121
LF256122

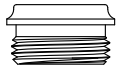

SEAT USED: LF649040

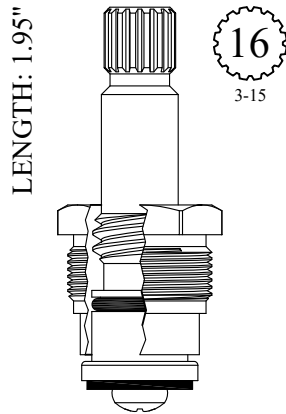

GASKET INCLUDED: 199930

LF457301

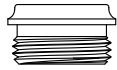

SEAT USED: LF649040



MW11326

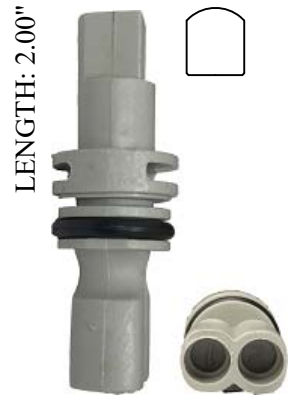

MW11327

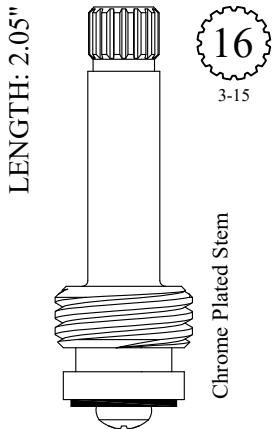

LF259051
LF259052



SEAT USED: LF649040

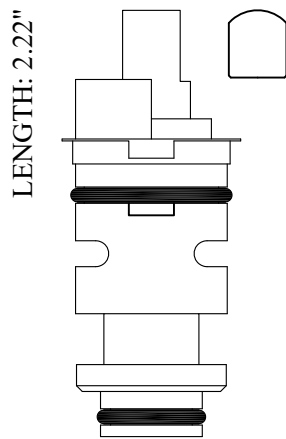

459621 Red
459622 Blue

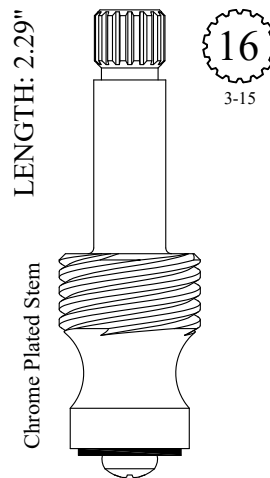

LF264231
LF264232



SEAT USED: LF649040

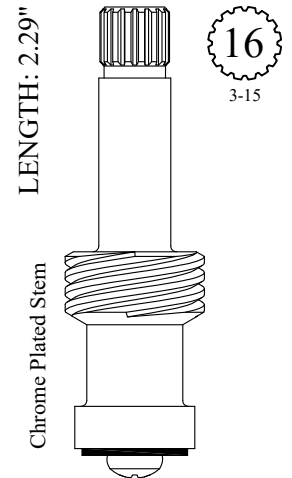

LF263181
LF263182



SEAT USED: LF649040

FOR MILWAUKEE

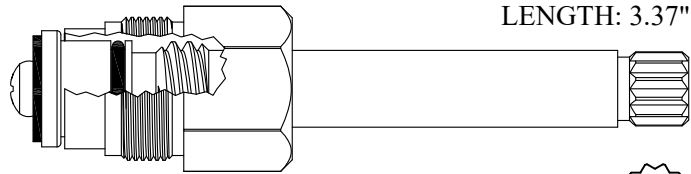
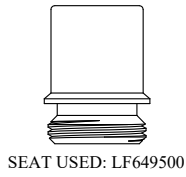

402591
GASKET INCLUDED: 199930

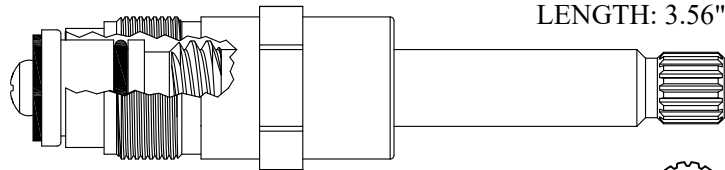

403001
GASKET INCLUDED: 199930
OEM # 8023
203001 Stem Only

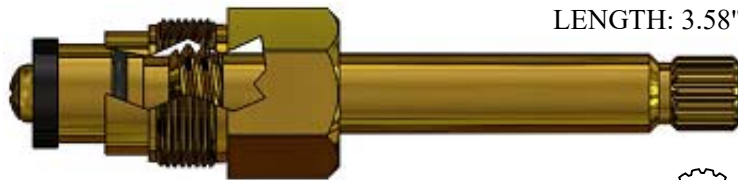

403591
GASKET INCLUDED: 199930



Chrome Plated Stem

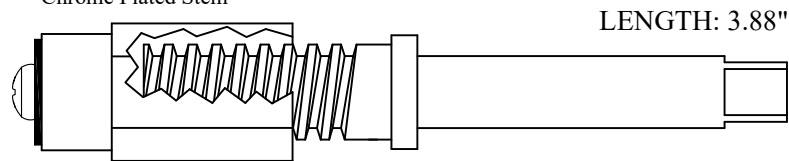

402632
202632 Stem Only



Chrome Plated Stem

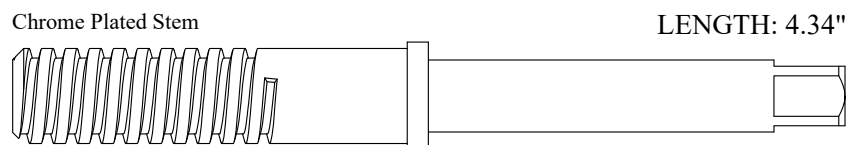

205212



FOR MILWAUKEE

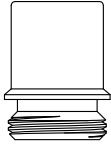

SEAT USED: LF649500

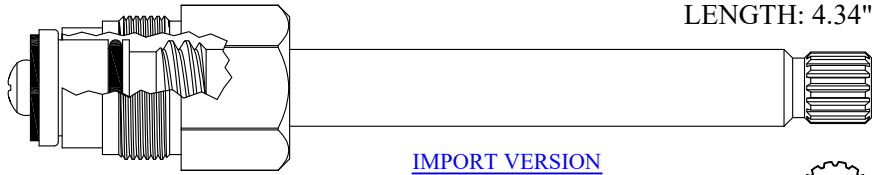

LENGTH: 4.34"

404901

GASKET INCLUDED: 199930
OEM # 5090

IMPORT VERSION
MW21323

16
3-15

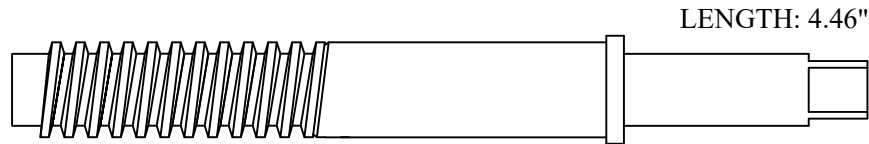

LENGTH: 4.46"

207512

5/16

Chrome Plated Stem

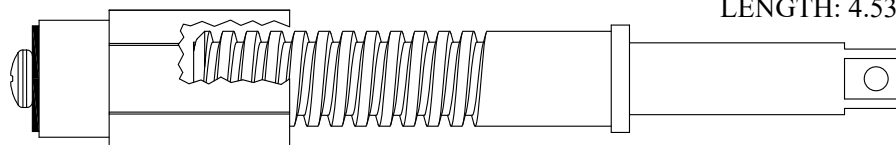

LENGTH: 4.53"

403432

203432 Stem Only

5/16

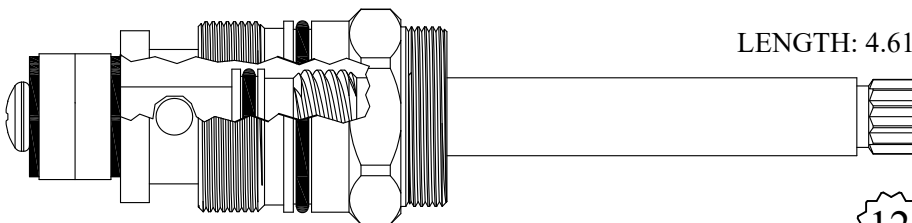

LENGTH: 4.61"

430951

GASKET: 890200 O-RING INCLUDED

12
1-1

FOR MILWAUKEE

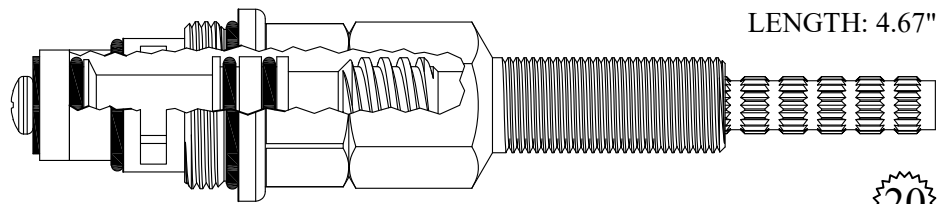

LENGTH: 4.67"

430931

GASKET: 890180 O-RING INCLUDED

20
3-20

Chrome Plated Stem

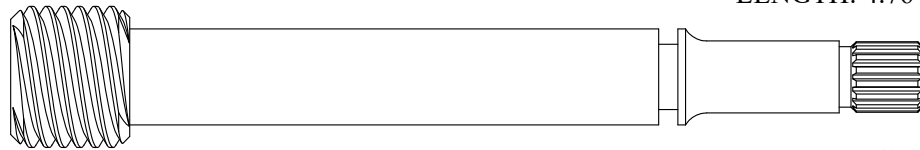

LENGTH: 4.76"

231331

16
3-15

Chrome Plated Stem

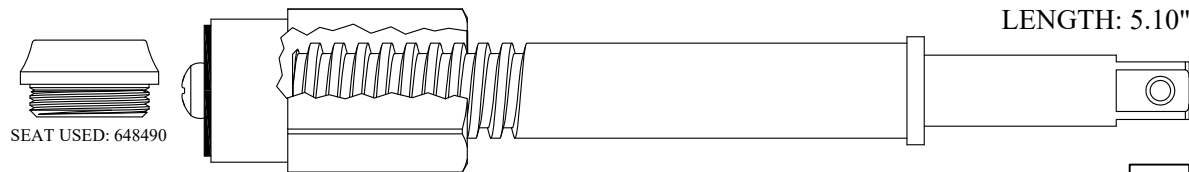

SEAT USED: 648490

LENGTH: 5.10"

408502

208502 Stem Only

GASKET: 894960 INCLUDED

5/16

Chrome Plated Stem

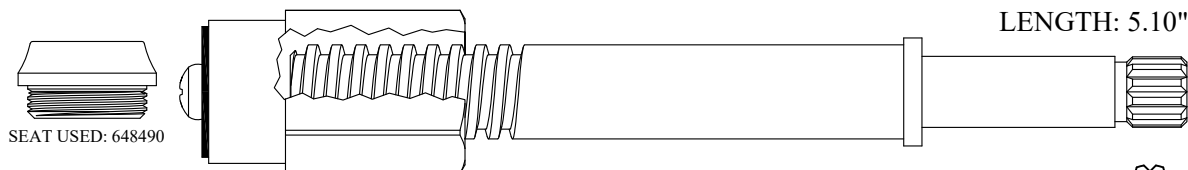

SEAT USED: 648490

LENGTH: 5.10"

408552

208552 Stem Only

GASKET: 894960 INCLUDED

12
1-2

FOR MILWAUKEE

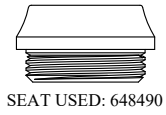

Chrome Plated Stem

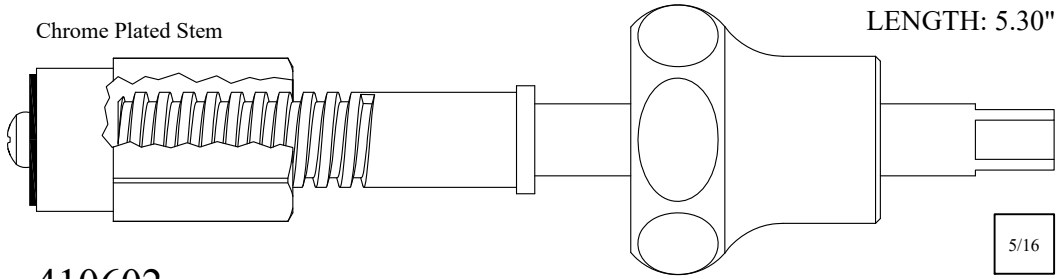

LENGTH: 5.30"

5/16

410602
210602 Stem Only
GASKET: 894960 INCLUDED

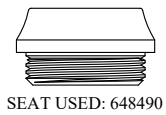

Chrome Plated Stem

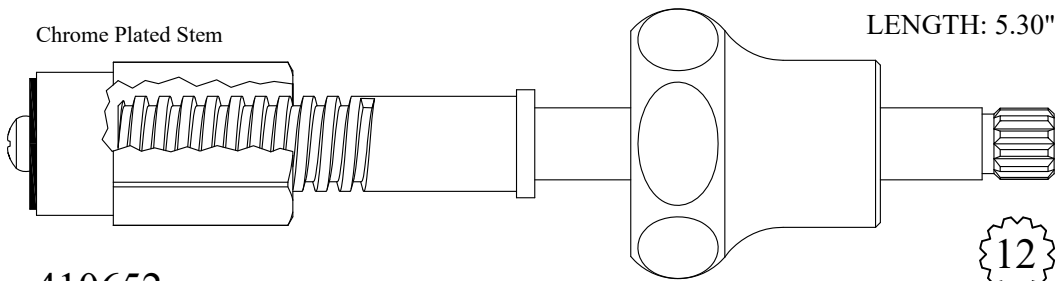

LENGTH: 5.30"

12

1-2

410652
210652 Stem Only
GASKET: 894960 INCLUDED

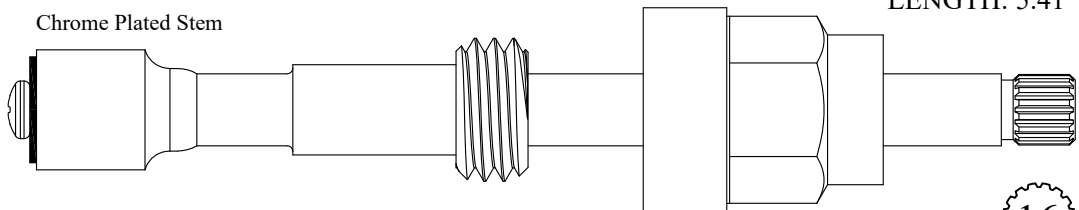

Chrome Plated Stem

LENGTH: 5.41"

16

3-15

419401
219401 Stem Only

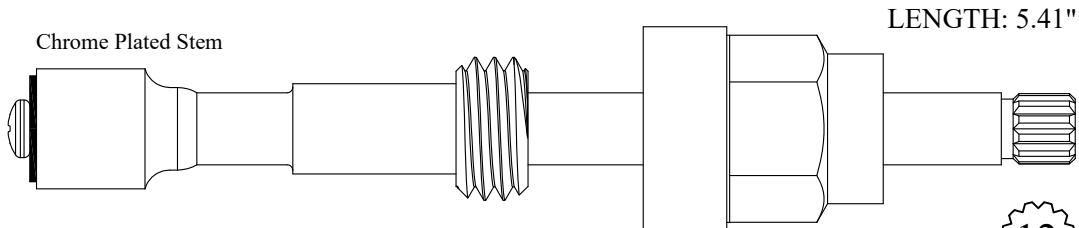

Chrome Plated Stem

LENGTH: 5.41"

12

1-2

419451
219451 Stem Only

FOR MILWAUKEE

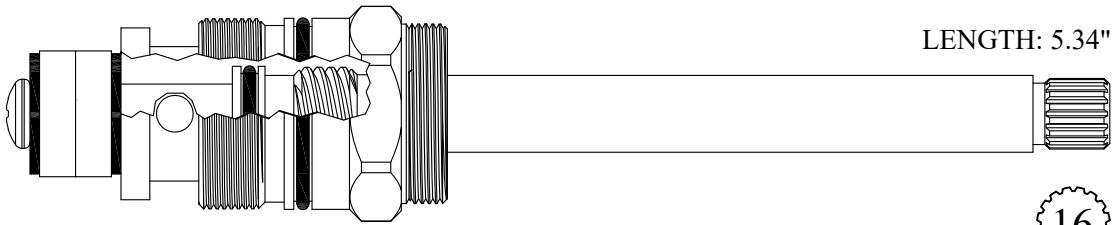

LENGTH: 5.34"

434721

GASKET: 890200 O-RING INCLUDED
OEM # 5091

16
3-15

Chrome Plated Stem

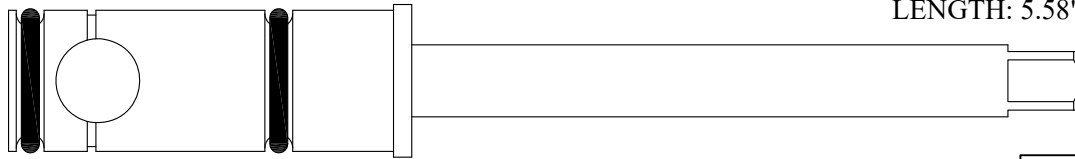

LENGTH: 5.58"

237420

5/16

Chrome Plated Stem

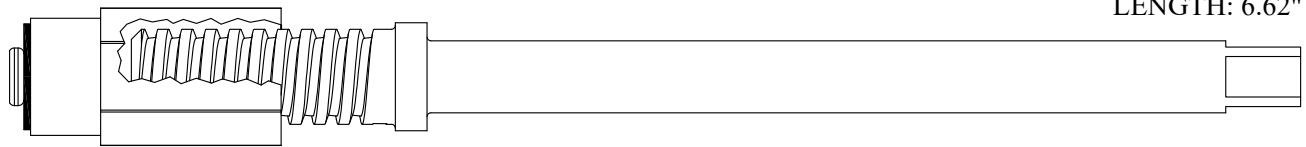

LENGTH: 6.62"

426312

226312 Stem Only

5/16

FOR MIXET

LENGTH: 1.60"

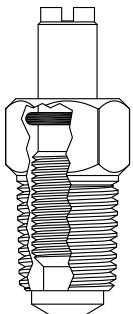

400721
OEM # MCSVS

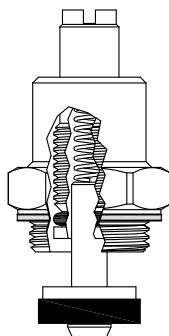

GASKET: 895060 INCLUDED

400371
OEM # MCHK

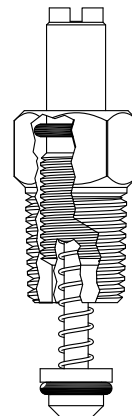

400731
OEM # MSPC

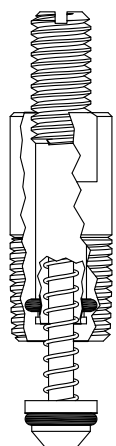

400901

FOR MOEN



400011-KIT
OEM #130158

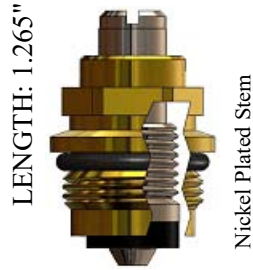

GASKET INCLUDED: 891140
400541

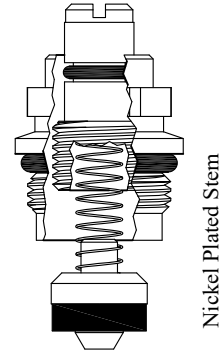

GASKET: 891140 O-RING INCLUDED
400421
OEM #12318

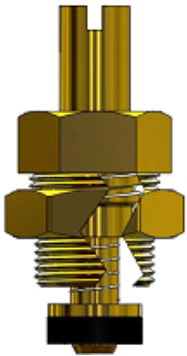

GASKET INCLUDED: 895110
400531

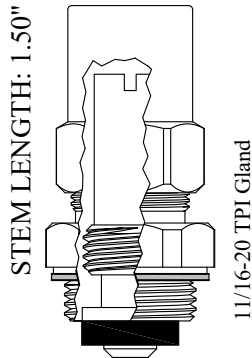

GASKET: 895110 INCLUDED
400311

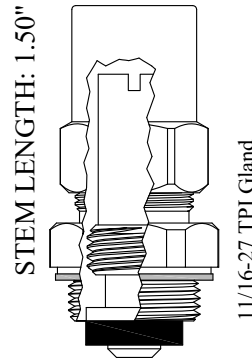

GASKET: 895110 INCLUDED
400321

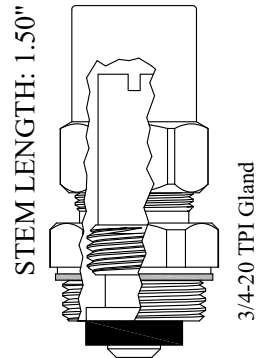

GASKET: 895110 INCLUDED
400341

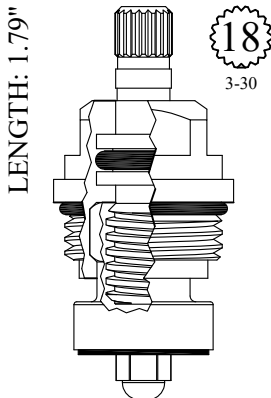

GASKET: 890180 O-RING INCLUDED
LF455362



MO11301
OEM #1224



MO11300
OEM #1248

FOR MOEN

Chrome Plated Stem & Tube

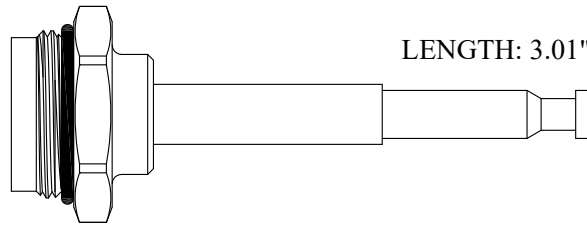

LENGTH: 3.01"

430450

GASKET: 890190 O-RING INCLUDED

Chrome Plated Stem & Tube

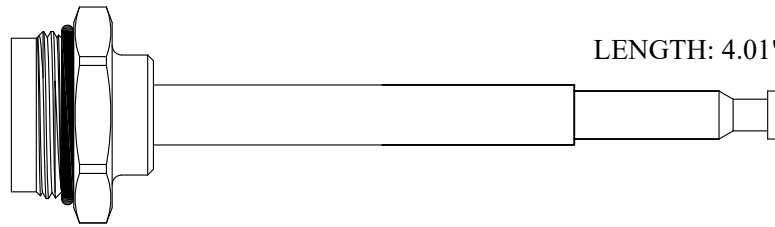

LENGTH: 4.01"

430460

GASKET: 890190 O-RING INCLUDED
OEM # 1394

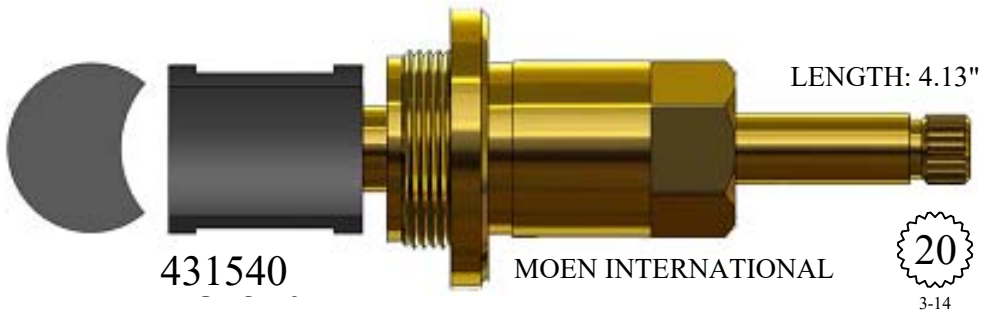

LENGTH: 4.13"

431540

MOEN INTERNATIONAL

20

3-14

Chrome Plated Stem & Tube

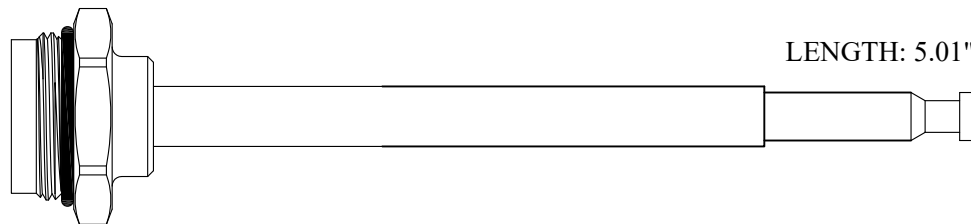

LENGTH: 5.01"

430590

GASKET: 890190 O-RING INCLUDED
OEM # 1198



436390

GASKET: 890170 O-RING INCLUDED
OEM # 94543

FOR MUELLER

LENGTH: 2.00"

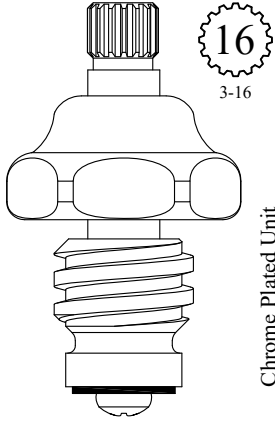

Chrome Plated Unit

LF459011
 LF459012
 LF259011 Stem Only
 LF259012 Stem Only

LENGTH: 2.00"

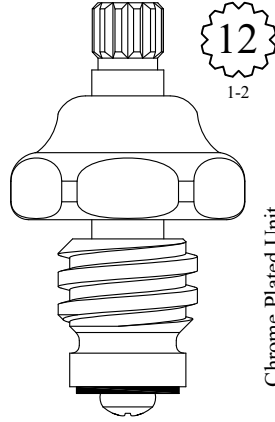

Chrome Plated Unit

LF459061
 LF459062
 LF259061 Stem Only
 LF259062 Stem Only

LENGTH: 2.15"

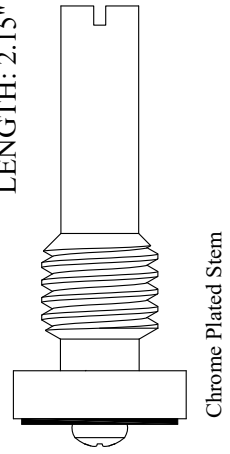

Chrome Plated Stem

201141

LENGTH: 2.40"

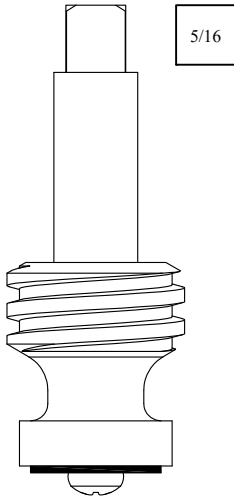

263341

LENGTH: 2.57"

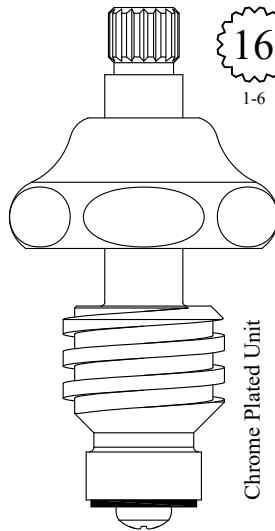

Chrome Plated Unit

401401
 201401 Stem Only

LENGTH: 2.57"

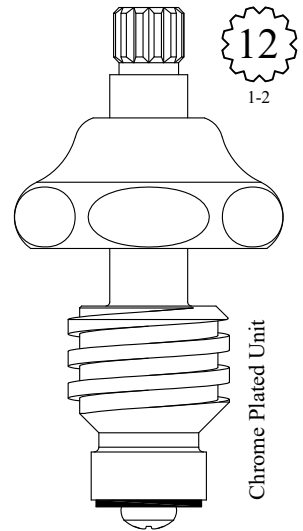

Chrome Plated Unit

401451
 201451 Stem Only



SEAT USED: LF649190

FOR MUELLER

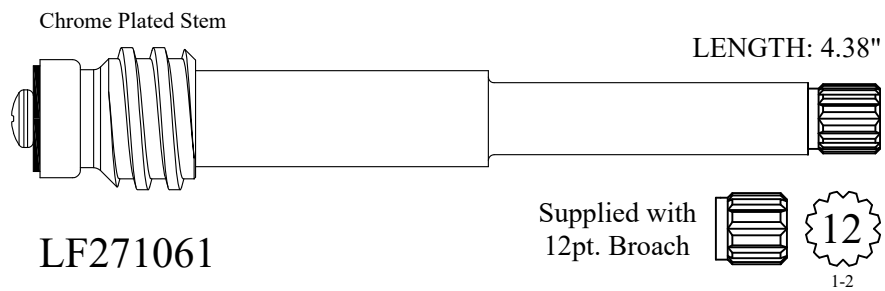
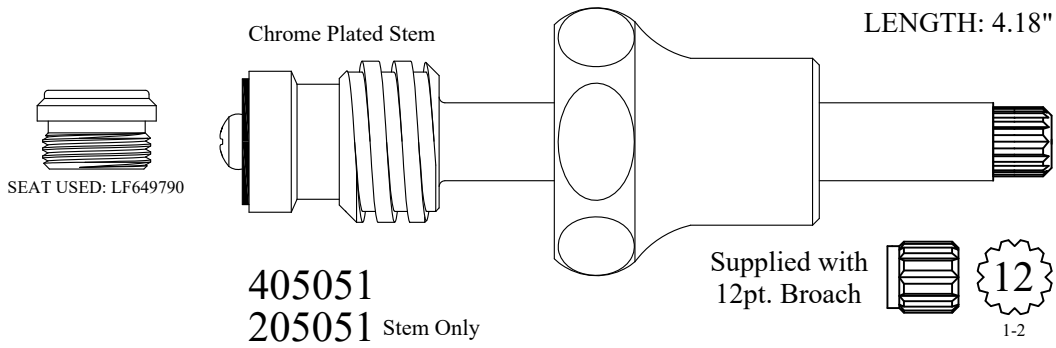
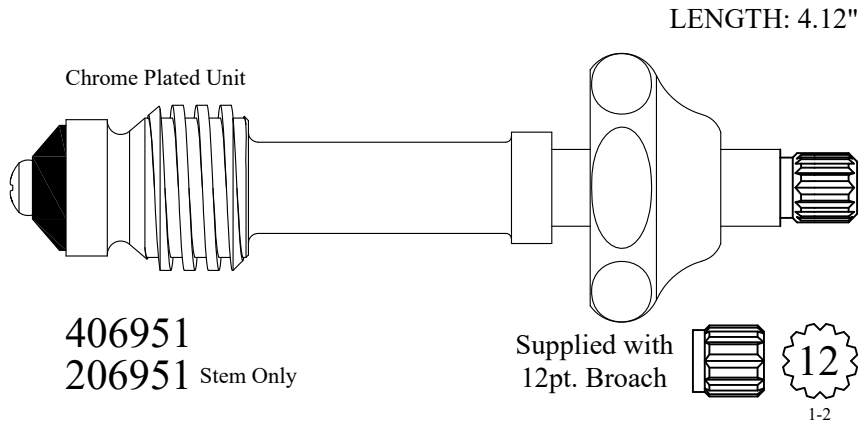
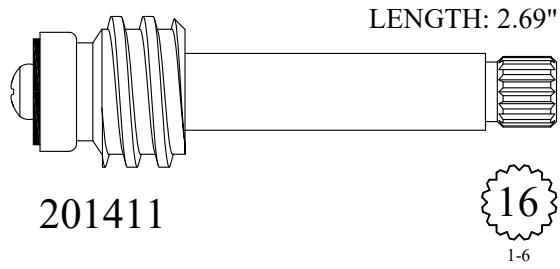

FOR MUELLER

LENGTH: 4.45"



406551
206551 Stem Only

Supplied with
12pt. Broach

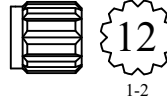

Chrome Plated Stem

LENGTH: 4.78"

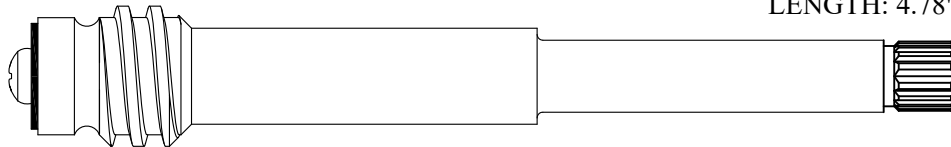

LF274061

Supplied with
12pt. Broach

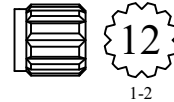

Chrome Plated Stem

LENGTH: 4.87"

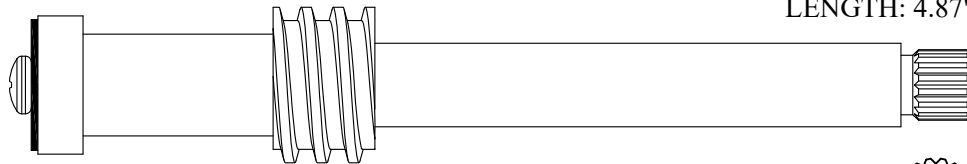

210021



Chrome Plated Stem

LENGTH: 5.03"

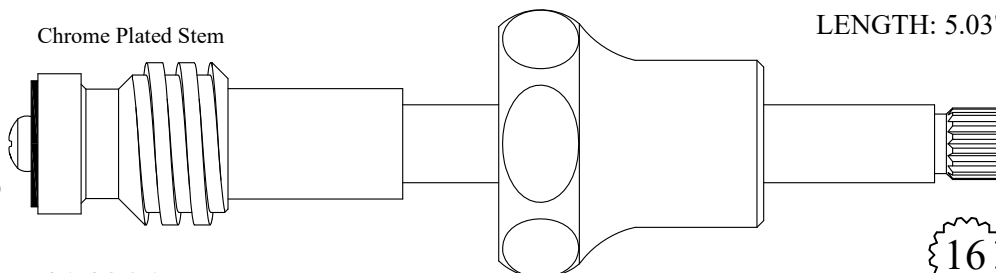

414801
214801 Stem Only



FOR MUELLER

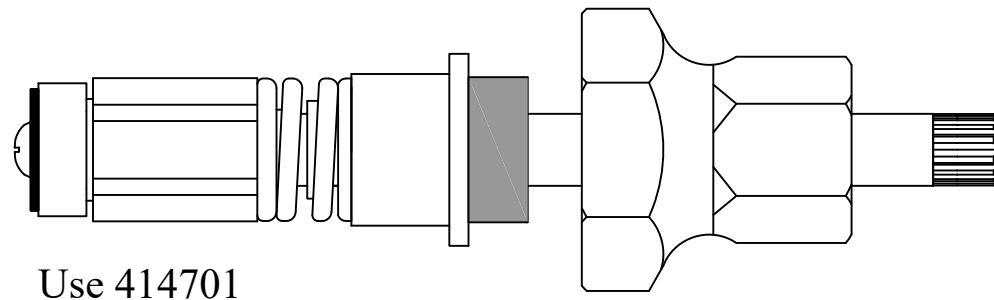
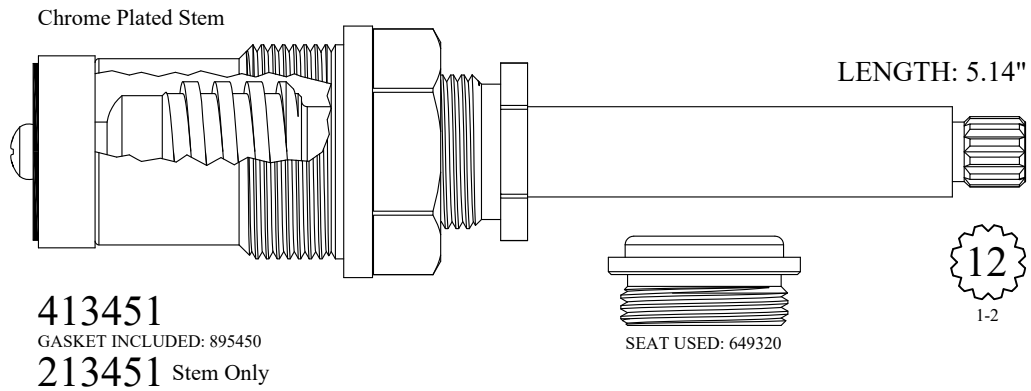
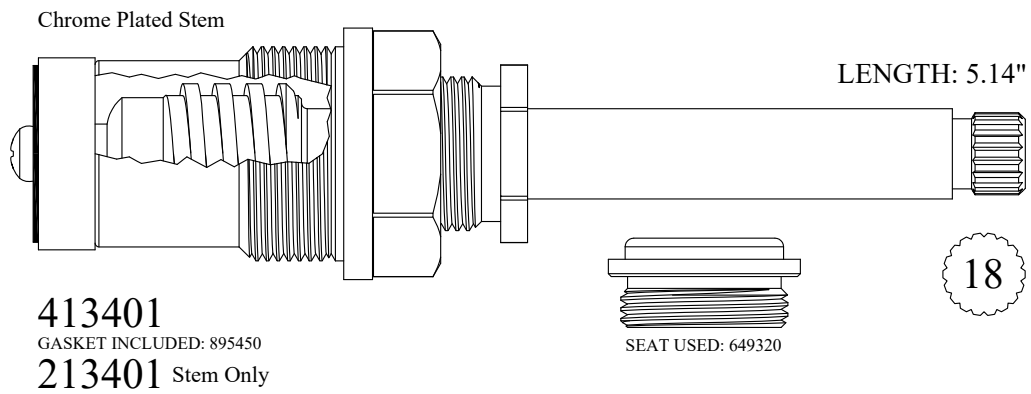
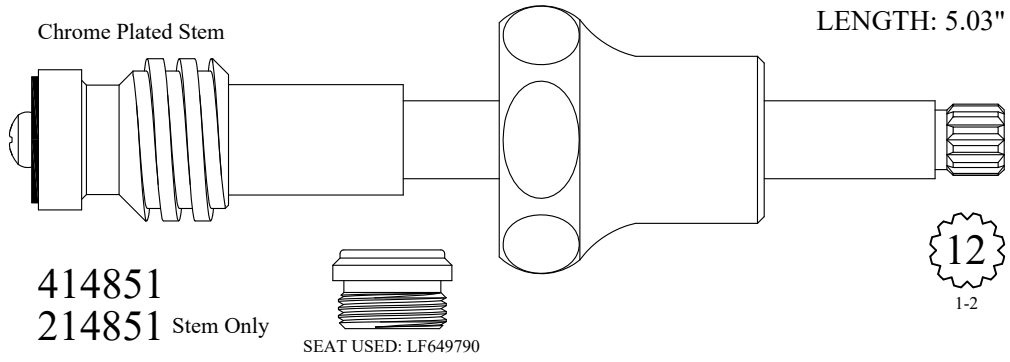

FOR MUELLER

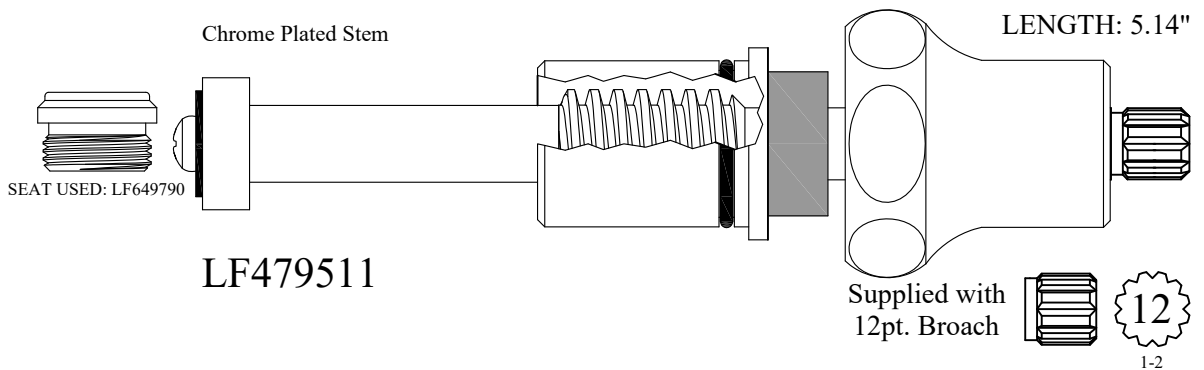
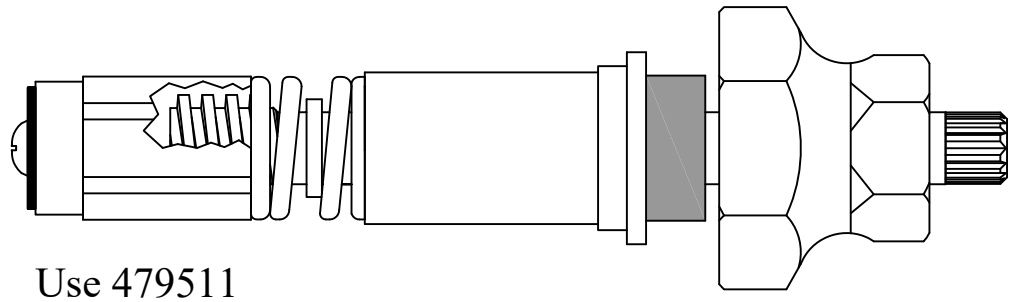
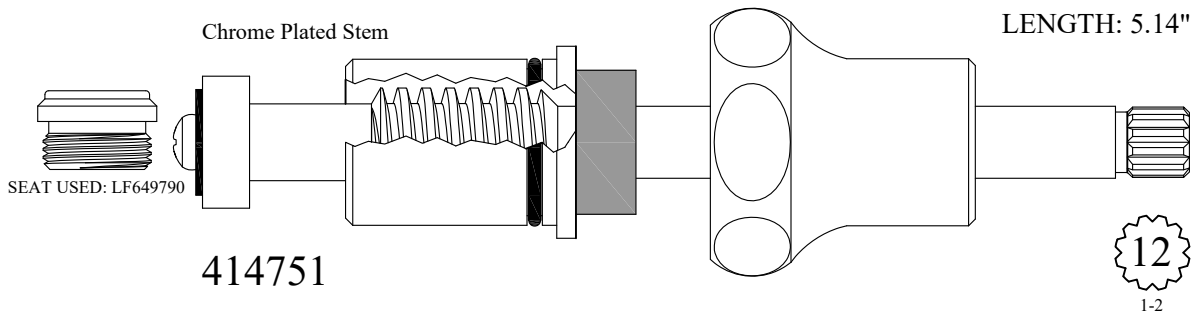
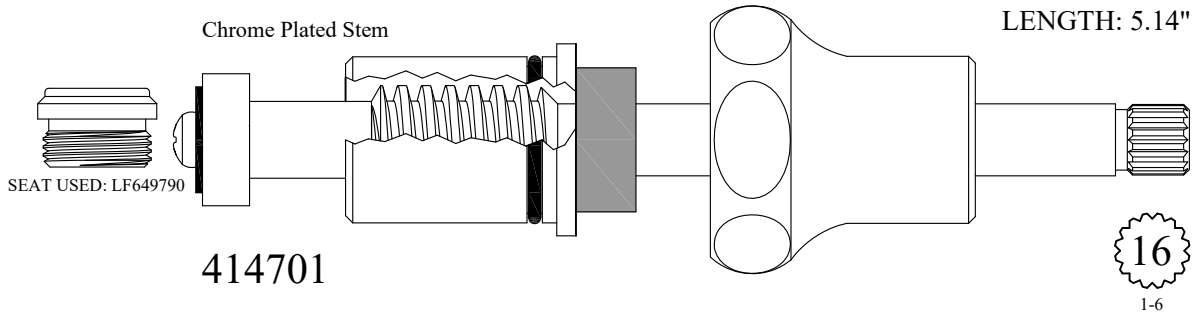

FOR MUELLER

Chrome Plated Stem

LENGTH: 5.30"



LF279511



Chrome Plated Unit

LENGTH: 5.43"



420251

220251 Stem Only

Supplied with
12pt. Broach

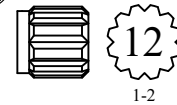

Chrome Plated Stem

LENGTH: 5.57"

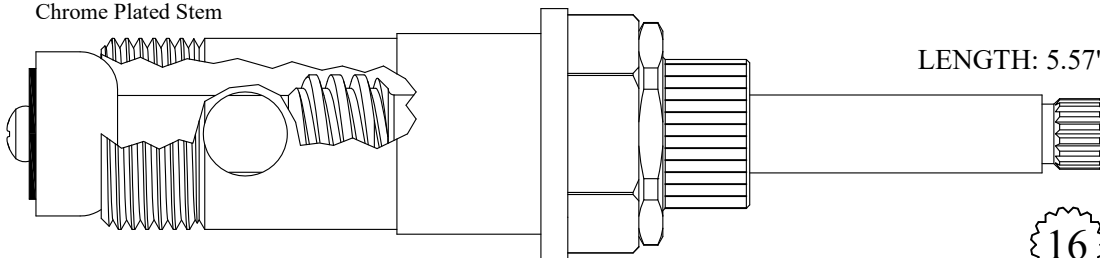

434821

GASKET INCLUDED: 895440



Chrome Plated Stem

LENGTH: 5.57"

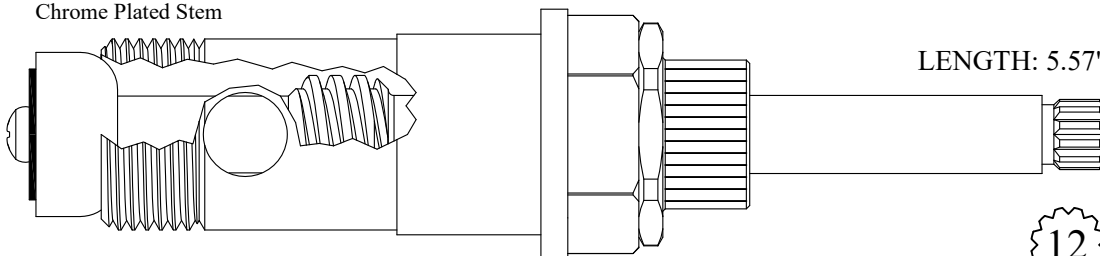

434871

GASKET INCLUDED: 895440

234871 Stem Only



FOR MUELLER

Chrome Plated Stem

OVERALL LENGTH: 5.90"
STEM LENGTH: 5.63"

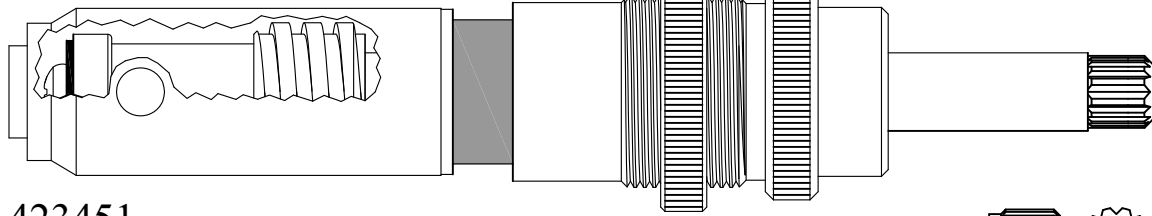

423451
223451 Stem Only

USES BARREL:
623401

Supplied with
12pt. Broach

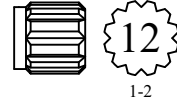

1-2

Chrome Plated Stem

LENGTH: 6.03"

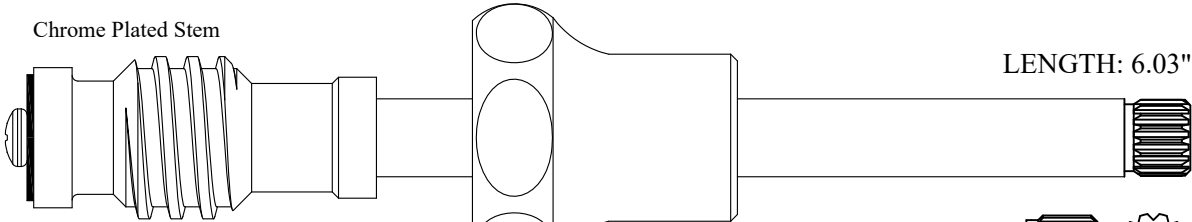

426161
226161 Stem Only

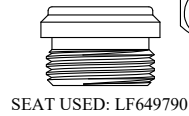

Supplied with
12pt. Broach

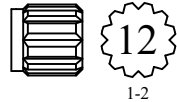

1-2

Chrome Plated Stem

OVERALL LENGTH: 6.14"
STEM LENGTH: 5.50"

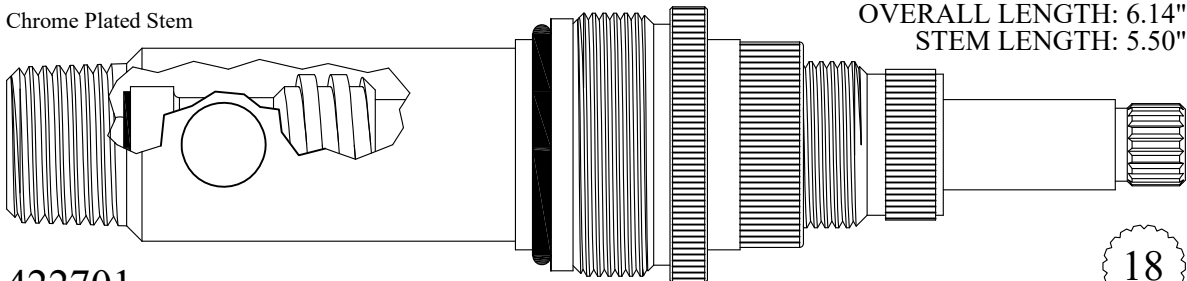

422701
GASKET: 891210 O-RING INCLUDED
222701 Stem Only



Chrome Plated Stem

OVERALL LENGTH: 6.14"
STEM LENGTH: 5.50"

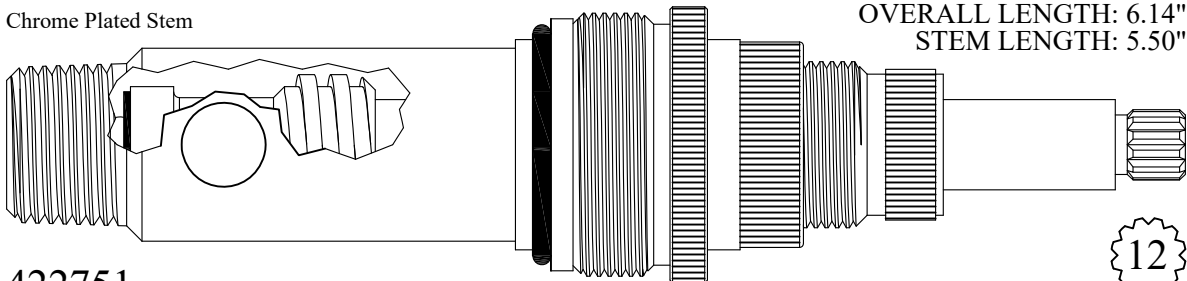

422751
GASKET: 891210 O-RING INCLUDED
222751 Stem Only



1-2

FOR MUELLER

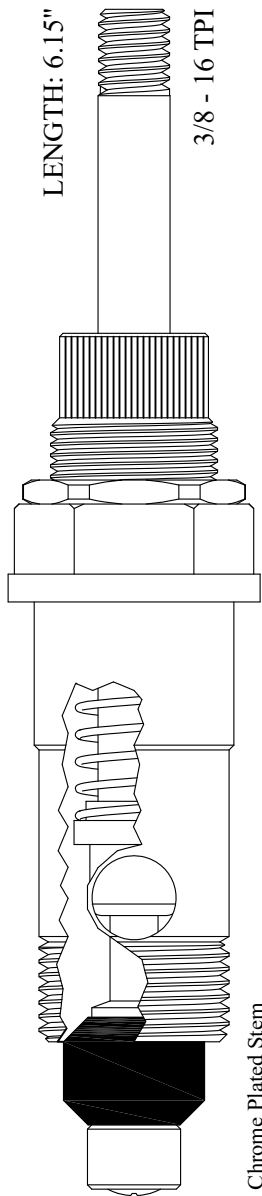

438200
GASKET INCLUDED: 895440
238200 Stem Only

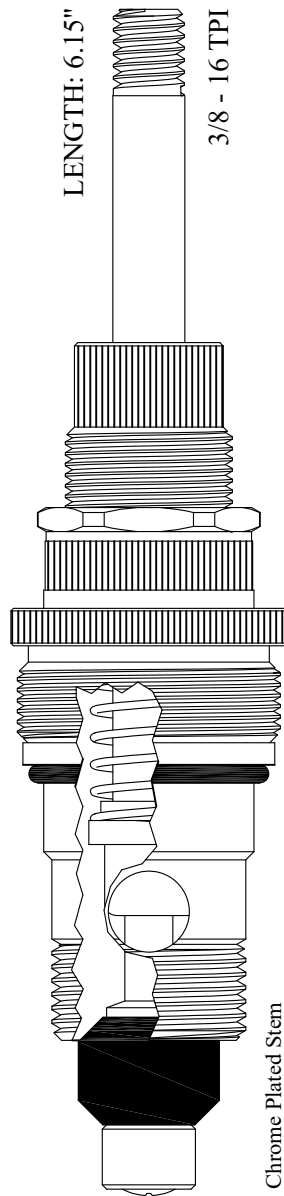

438210
238200 Stem Only

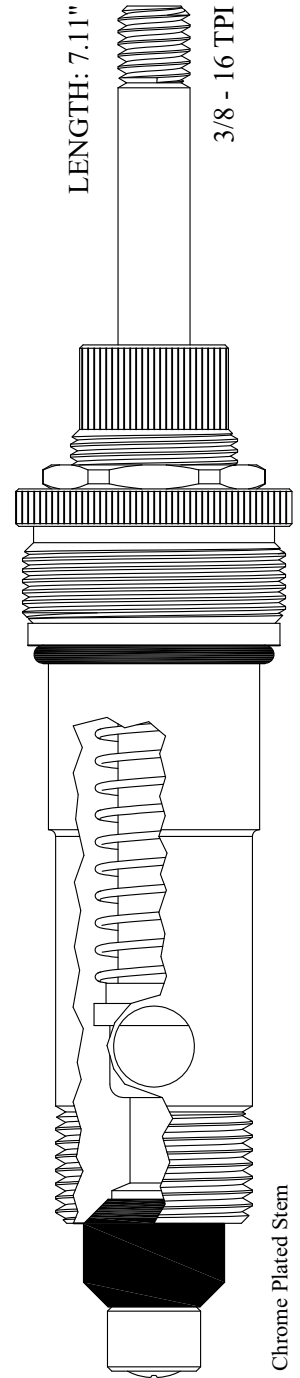

439640
239640 Stem Only

FOR MURRAY & SORENSON

Chrome Plated Stem

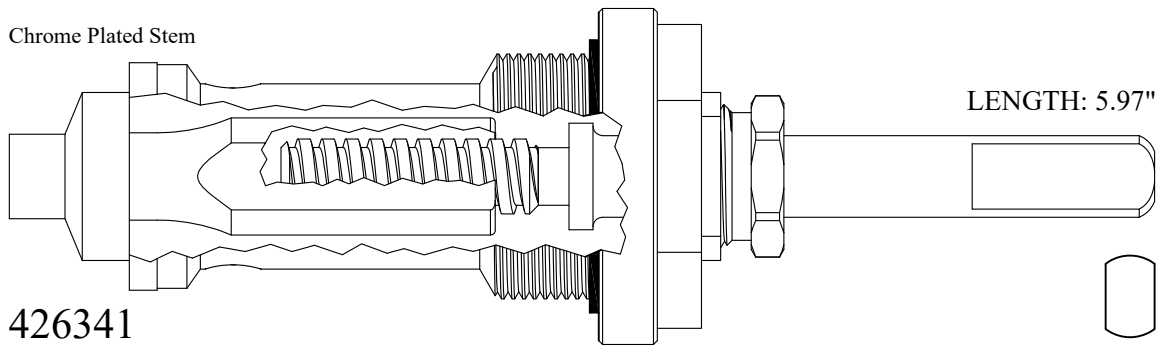

LENGTH: 5.97"

426341
226331 Stem Only
GASKET: 895460 INCLUDED

Chrome Plated Stem

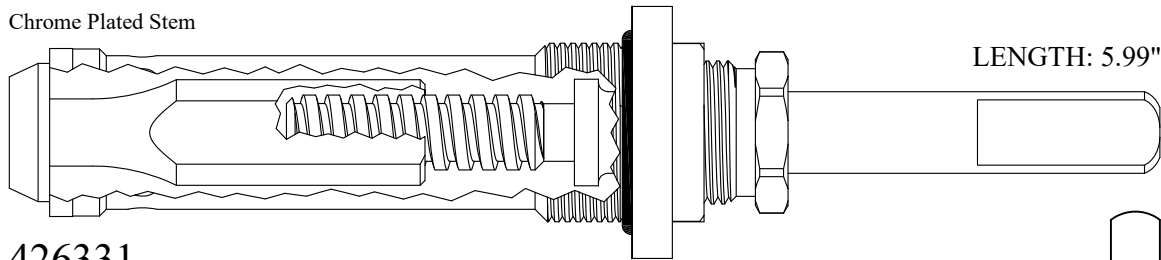

LENGTH: 5.99"

426331
226331 Stem Only
GASKET: 891180 O-RING INCLUDED

FOR NEWPORT BRASS



400791
GASKET: 891170 O-RING INCLUDED
OEM # 1-103

3-Hole - Plastic Body

LENGTH: 2.54"



230670
OEM # 1-075

20
3-20

Short Diverter Version

LENGTH: 2.60"

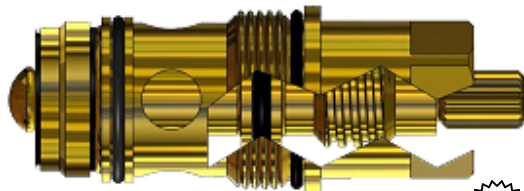

431271
GASKET: 890190 O-RING INCLUDED

20
3-20

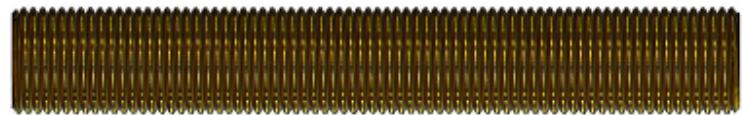

SEAT USED: 647650

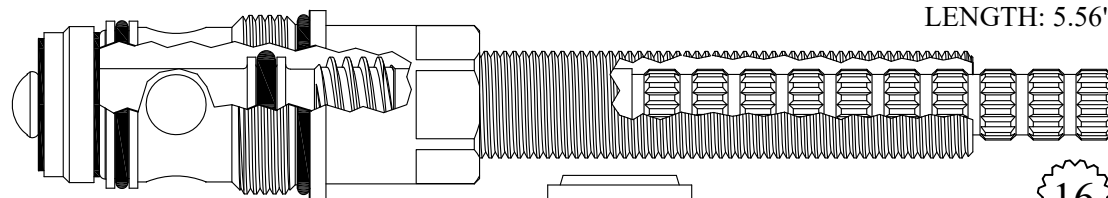

LENGTH: 5.56"

433371
GASKET: 890190 O-RING INCLUDED
OEM # VB1850

16



SEAT USED: 647650

FOR NEWPORT BRASS

Wall and Deck Models

LENGTH: 6.59"



3-Hole - Plastic Body

439160
239160

OEM # NEWPORT - 1-021

LENGTH: 7.07"



GASKET: 890190 O-RING INCLUDED

439371



SEAT USED: 647650

4-Port

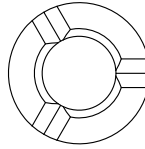

5-Port

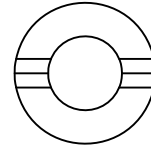

LENGTH: 8.17"



To identify a 4 or 5-Port Unit, look down the stem from the broach end at the dent bushing and refer to the images above

LENGTH: 6.05"

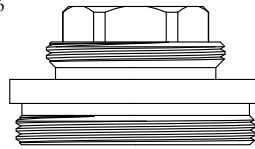
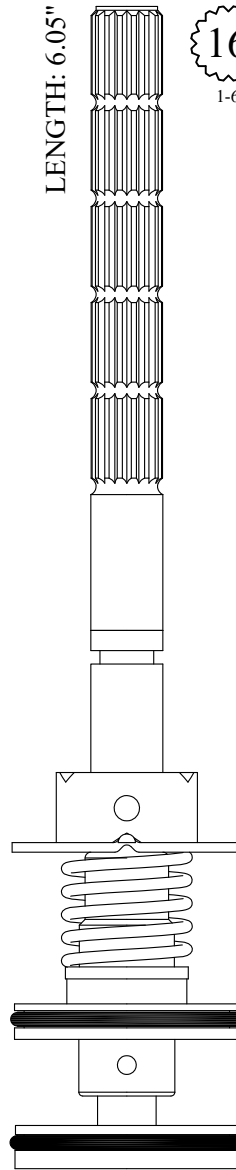

730560

Wall Model	
4-Port	238320
5-Port	238330
W/ 730560 Bonnet	
4-Port	438320
5-Port	438330

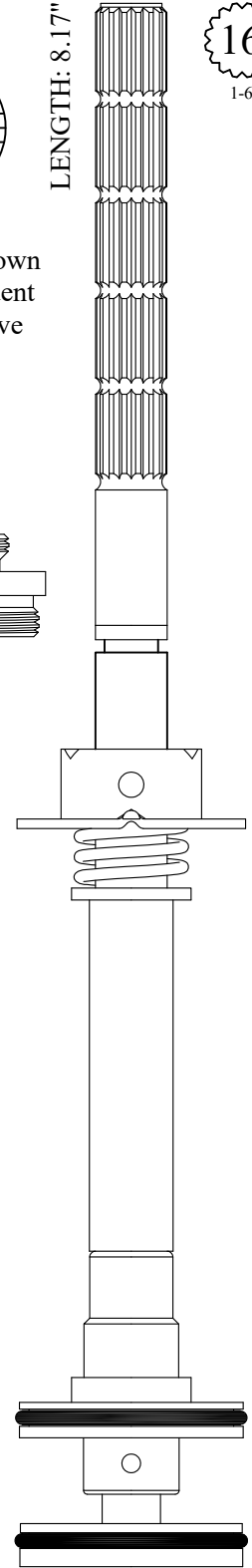

Deck Model	
4-Port	239860
5-Port	239870
W/ 730560 Bonnet	
4-Port	439860
5-Port	439870

FOR NIBCO

LENGTH: 2.00"



NI11438
OEM # P22



NI11439
OEM # P22LH

LENGTH: 2.24"

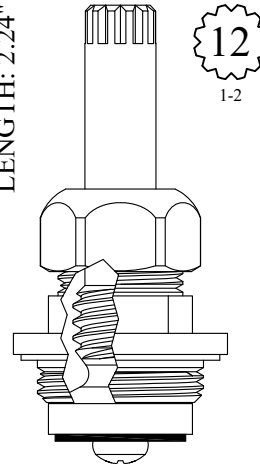

GASKET INCLUDED: 895400

191041

LENGTH: 2.55"

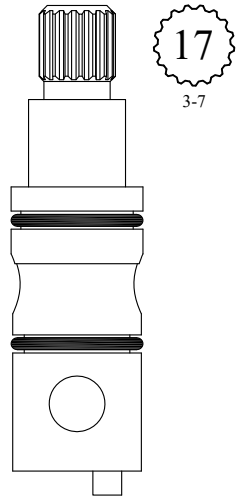

230730
OEM # N2601-4D-0

FOR NORCA

Nickel Plated Unit

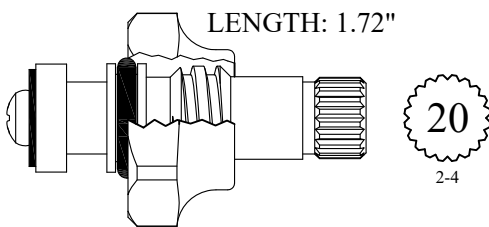

LF454181/ LF454182

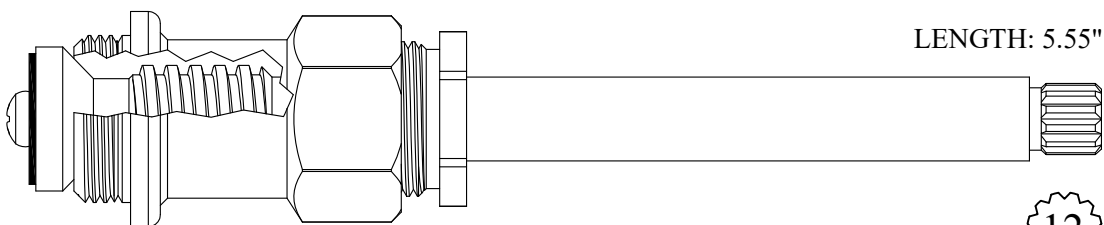

421631
GASKET INCLUDED: 895400

FOR ORION

LENGTH: 2.18"

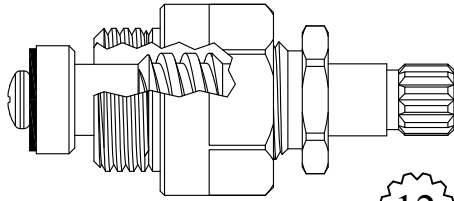

12
1-2

LF460601

GASKET INCLUDED: 895100

LENGTH: 4.47"

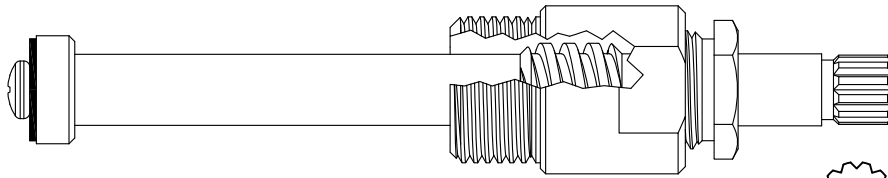

12
1-2

LF473101

LENGTH: 4.64"

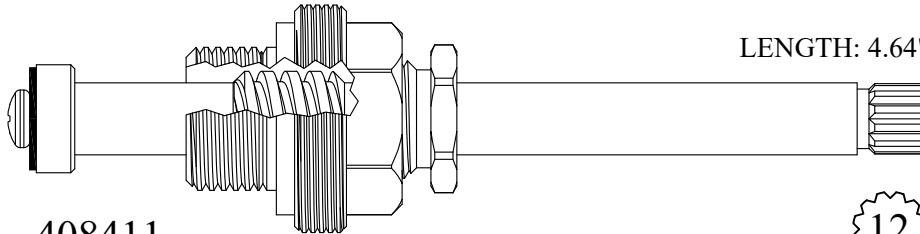

12
1-2

408411

GASKET INCLUDED: 895100

BARRY E.  WALTER  SR. CO.

FOR P.E. GUERIN

LENGTH: 1.88"

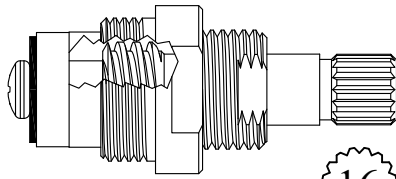

LF456321
LF456322

GASKET INCLUDED: 895100



Chrome Plated Stem

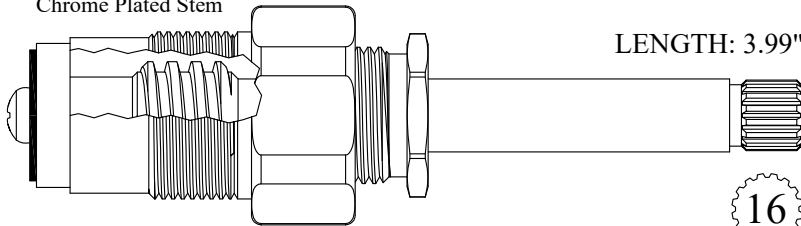

LENGTH: 3.99"

404421/ 404422

GASKET INCLUDED: 895400



Chrome Plated Stem

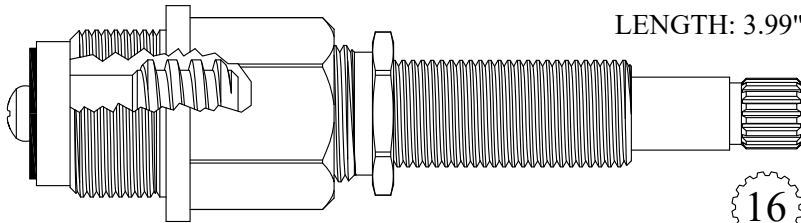

LENGTH: 3.99"

404431/ 404432

GASKET INCLUDED: 895400



SEAT USED: LF648130

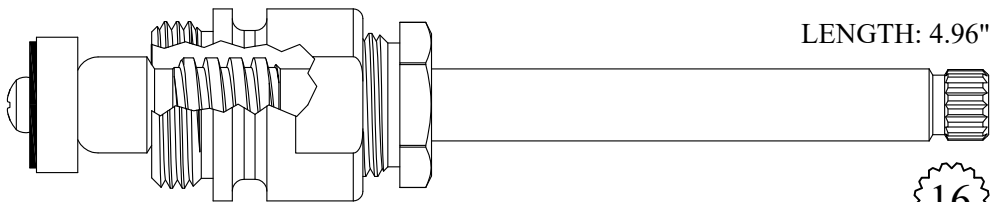

LENGTH: 4.96"

412811

GASKET INCLUDED: 895400

212811 Stem Only



SEAT USED: LF648130

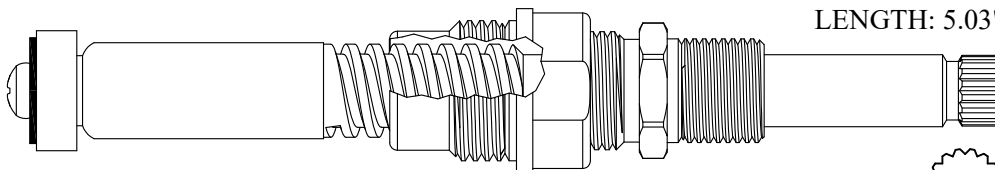

LENGTH: 5.03"

LF478701/ LF478702

GASKET INCLUDED: 895100



FOR PACIFIC

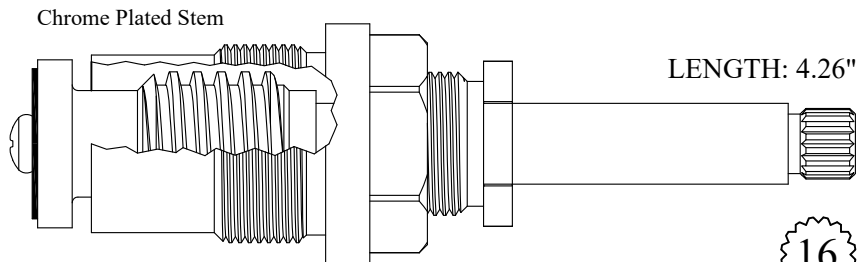

405921
GASKET INCLUDED: 895540
205921 Stem Only

1-6

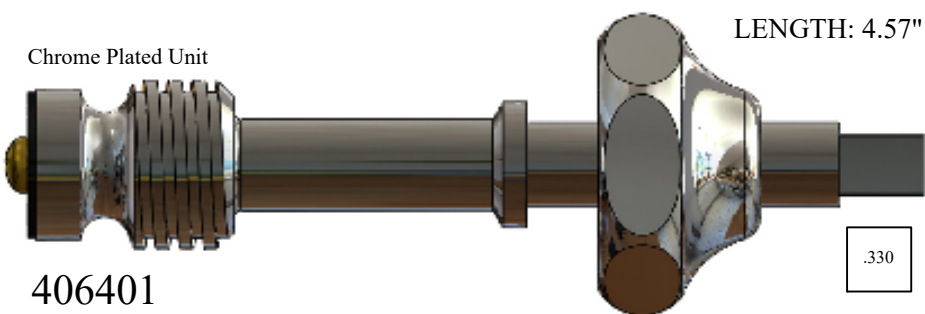

406401
206401 Stem Only

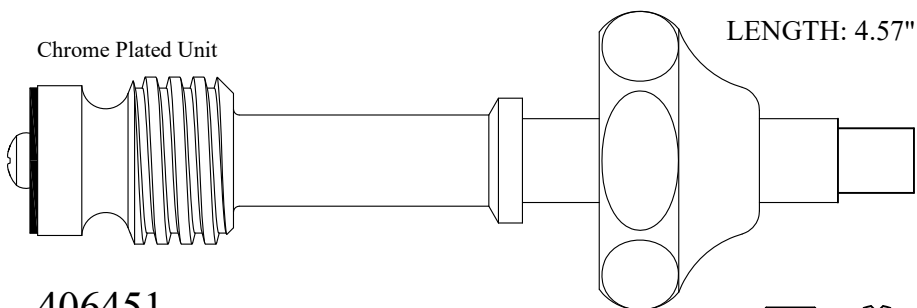

406451
206451 Stem Only

Supplied with
12pt. Broach



1-2

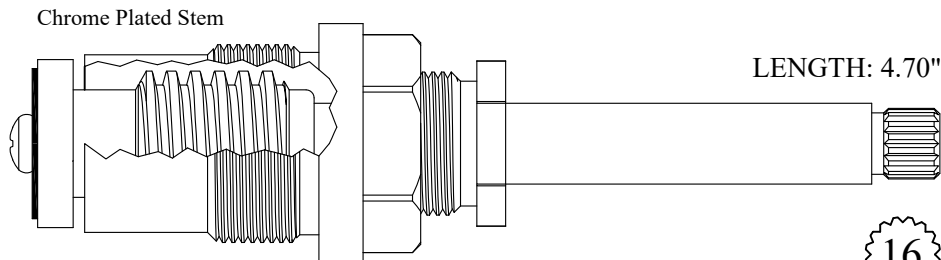

413321
GASKET INCLUDED: 895540
213321 Stem Only

1-6

FOR PAUL

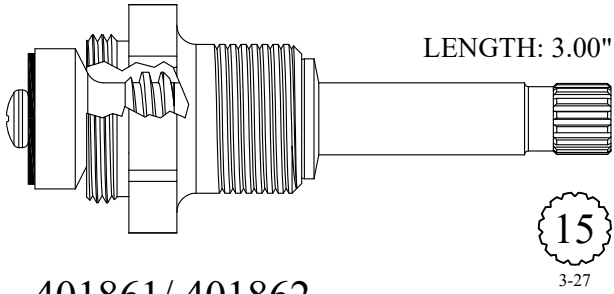

401861/ 401862
GASKET INCLUDED: 895400
201861/ 201862 Stem Only

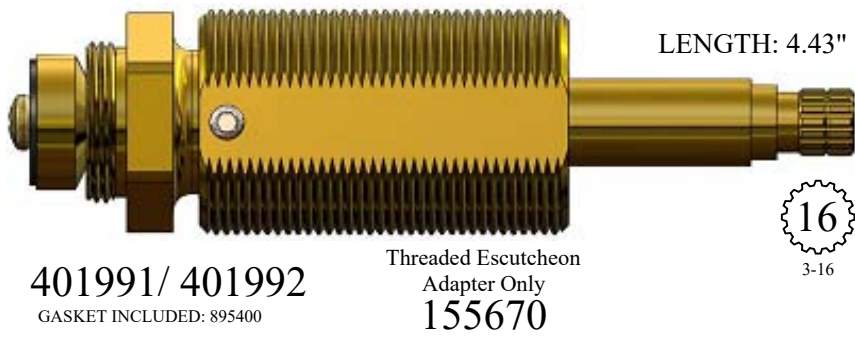

401991/ 401992
GASKET INCLUDED: 895400
Threaded Escutcheon Adapter Only
155670

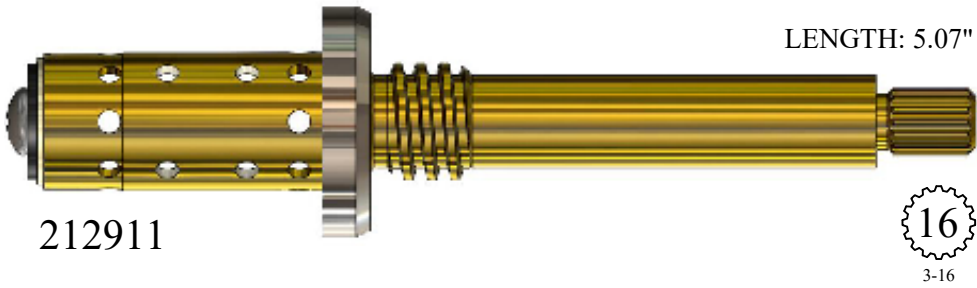

212911

Chrome Plated Stem

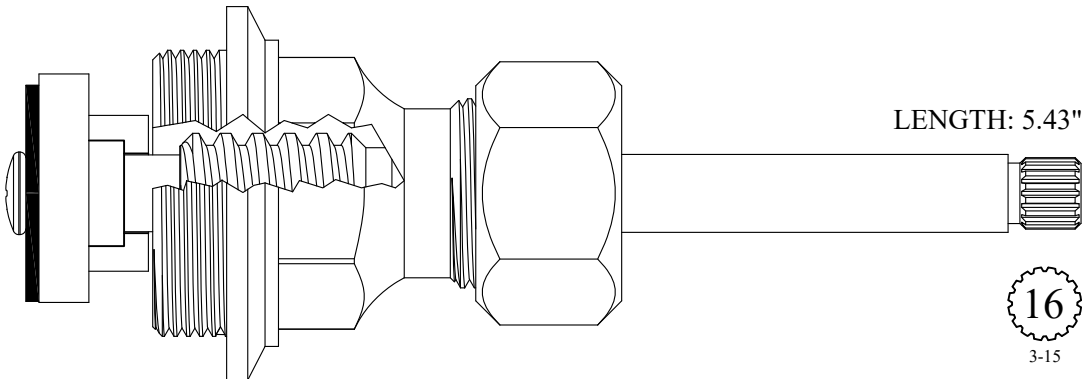

417321

FOR PEGASUS



GASKET: 891150 O-RING INCLUDED
431391



GASKET: 891150 O-RING INCLUDED
431781

FOR PERLICK

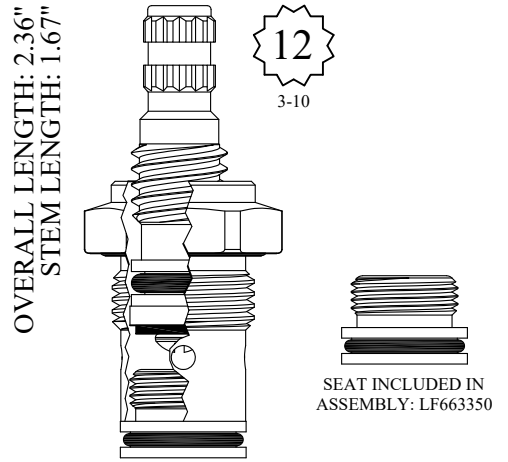

GASKET: 890180 O-RING INCLUDED
LF463351
OEM # 43161
LF463352
LF463351-2 Pair
OEM # 43146

FOR PHOENIX

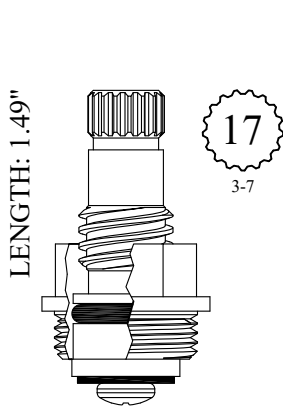

GASKET INCLUDED: 895100
400431



GASKET: 890170 O-RING INCLUDED
LF451171
OEM # 40-5-0 / 960-0

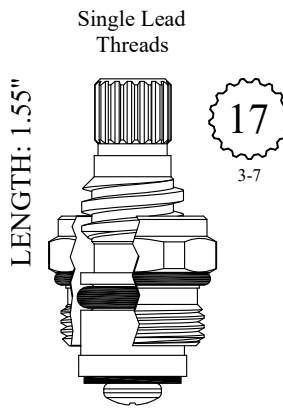

GASKET: 890170 O-RING INCLUDED
LF451181

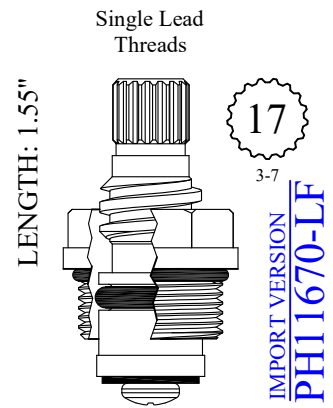
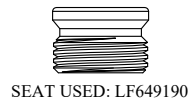

GASKET: 890170 O-RING INCLUDED
LF451211
OEM # 61-5-0
LF451212
OEM # 61-5-0LH

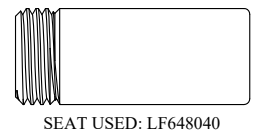

IMPORT VERSION
PH11670-LF

FOR PHOENIX

LENGTH: 1.55"

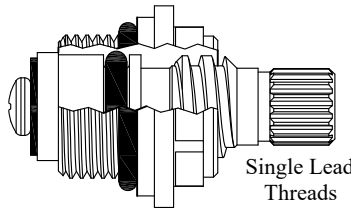

LF451221/ LF451222

GASKET: 891150 O-RING INCLUDED
OEM # 43-5-0/ 43-5-0LH

Plastic Cartridge

LENGTH: 3.07"



PH11560

OEM # 639-5-0

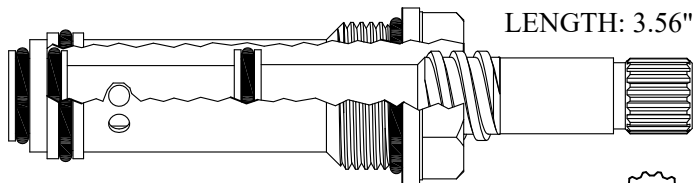

430771

GASKET: 890170 O-RING INCLUDED
OEM # 639-5-0

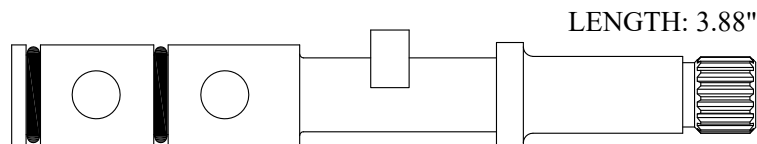

230370

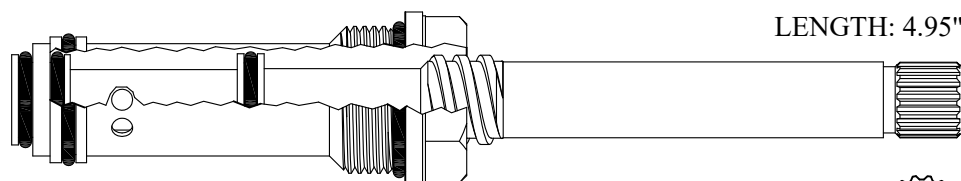

431821

GASKET: 890170 O-RING INCLUDED
OEM # 1639-5-0



FOR PHYLRICH



Short Diverter Version LENGTH: 2.60"



SEAT USED: 647650



431271

GASKET: 890190 O-RING INCLUDED

20

3-20

Polished Brass Stem

LENGTH: 4.70"

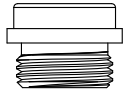

SEAT USED: LF648550

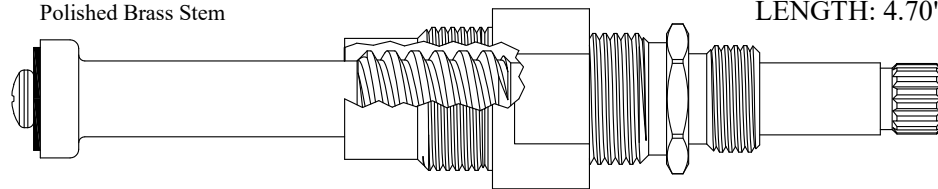

16

1-6

LF475091/ LF475092

GASKET INCLUDED: 895100

LF275091/ LF275092 Stem Only

Also available with chrome plated stem

LF475091-CP/ LF475092-CP

GASKET INCLUDED: 895100

LF275091-CP/ LF275092-CP Stem Only

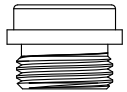

SEAT USED: LF648550

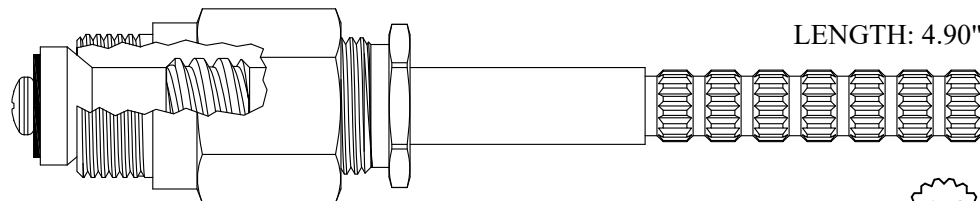

LENGTH: 4.90"

411031/ 411032

GASKET INCLUDED: 895100

OEM # 1549HSB-001/ 1549CSB-001

16

1-6

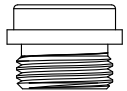

SEAT USED: LF648550

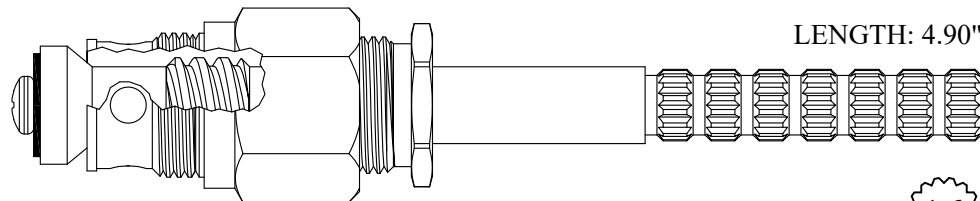

LENGTH: 4.90"

431941

GASKET INCLUDED: 895100

16

1-6

Polished Brass Stem

LENGTH: 4.91"

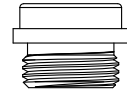

SEAT USED: LF648550

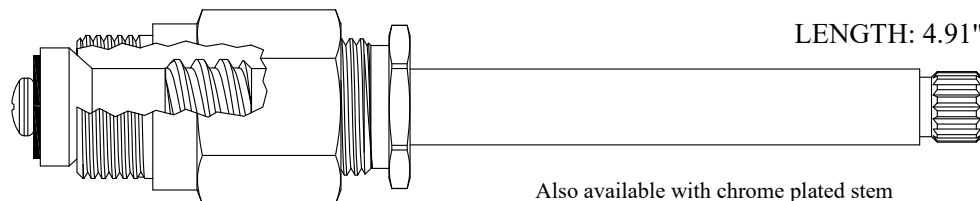

16

1-6

411041/ 411042

GASKET INCLUDED: 895100

211041/ 211042 Stem Only

Also available with chrome plated stem

411041-CP/ 411042-CP

GASKET INCLUDED: 895100

211041-CP/ 211042-CP Stem Only

FOR PHYLRICH

Polished Brass Stem

SEAT USED: LF648550

LENGTH: 4.91"

431951
GASKET INCLUDED: 895100

Also available with chrome plated stem
431951-CP
GASKET INCLUDED: 895100

16
1-6

SEAT USED: 648970

LENGTH: 4.95"

415641/ 415642
GASKET INCLUDED: 895400

16
1-6

SEAT USED: 648970

LENGTH: 4.98"

415541-CP/ 415542-CP
GASKET INCLUDED: 895400

Also available with Polished Brass stem
415541-PB/ 415542-PB
GASKET INCLUDED: 895400

215541-CP/ 215542-CP Stem Only
215541-PB/ 215542-PB Stem Only

16
1-6

Polished Brass Stem

SEAT USED: LF648550

LENGTH: 5.05"

LF480191/ LF480192
GASKET INCLUDED: 895100

Also available with chrome plated stem
LF480191-CP/ LF480192-CP
GASKET INCLUDED: 895100

LF280191/ LF280192 Stem Only
LF280191-CP/ LF280192-CP Stem Only

16
1-6

Polished Brass Stem

SEAT USED: 647650

LENGTH: 5.31"

433361
GASKET: 890190 O-RING INCLUDED

Also available with chrome plated stem
433361-CP

16
1-6

FOR PHYLRICH

LENGTH: 5.56"

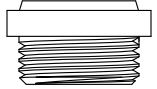

SEAT USED: 647650

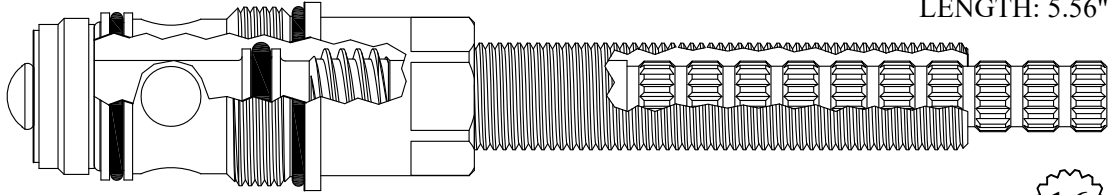

433371

GASKET: 890190 O-RING INCLUDED



Chrome Plated Stem

LENGTH: 5.74"



435371

GASKET: 890190 O-RING INCLUDED



SEAT USED: 648970

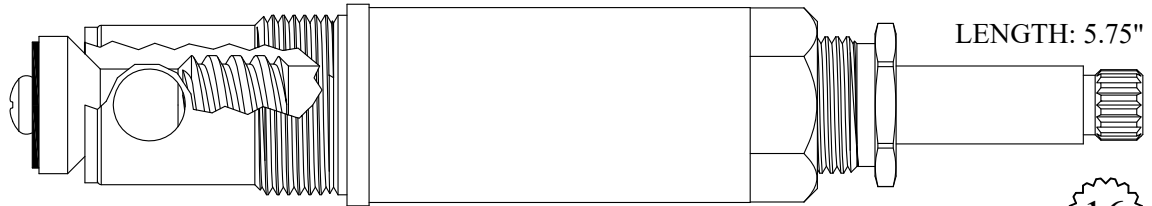

LENGTH: 5.75"

436131

GASKET INCLUDED: 895370

OEM # 1526-D-SB

236101 Stem Only

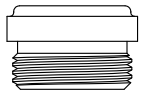

SEAT USED: 648970

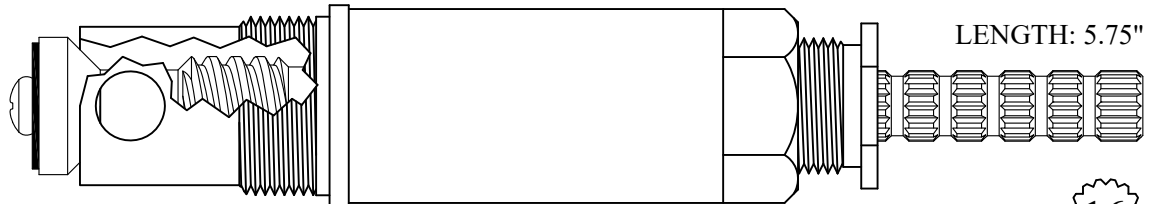

LENGTH: 5.75"

436171

GASKET INCLUDED: 895370



SEAT USED: 648970

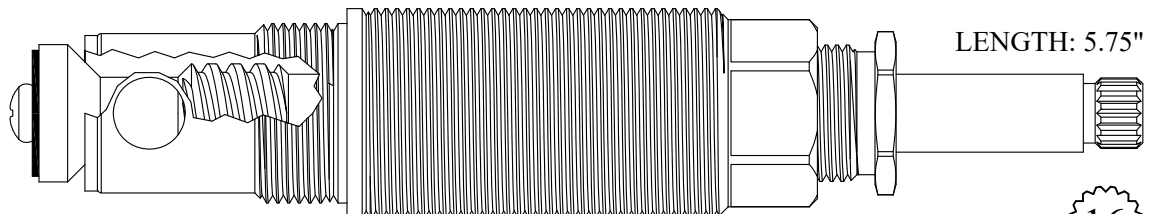

LENGTH: 5.75"

436141

236101 Stem Only

GASKET INCLUDED: 895370



FOR PHYLRICH

Wall and Deck Models

To identify a 4 or 5-Port Unit, look down the stem from the broach end at the dent bushing. Refer to the images below:

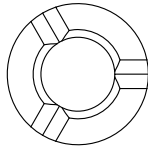

4-Port

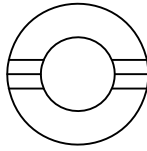

5-Port

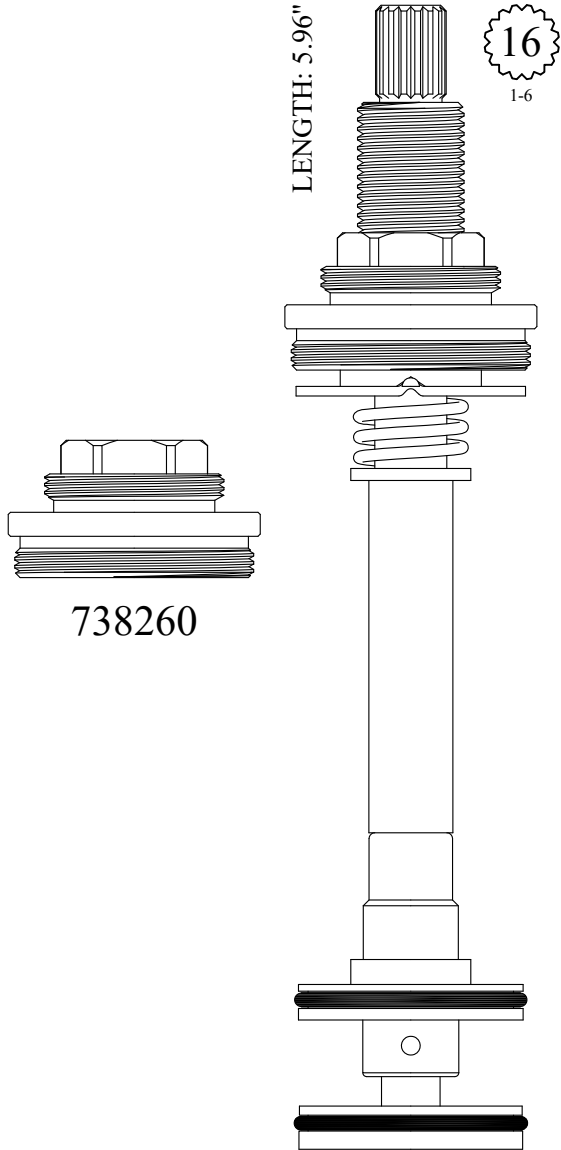

738260

Deck Model	
4-Port	238260
5-Port	238270
W/ 730560 Bonnet	
4-Port	438260
5-Port	438270

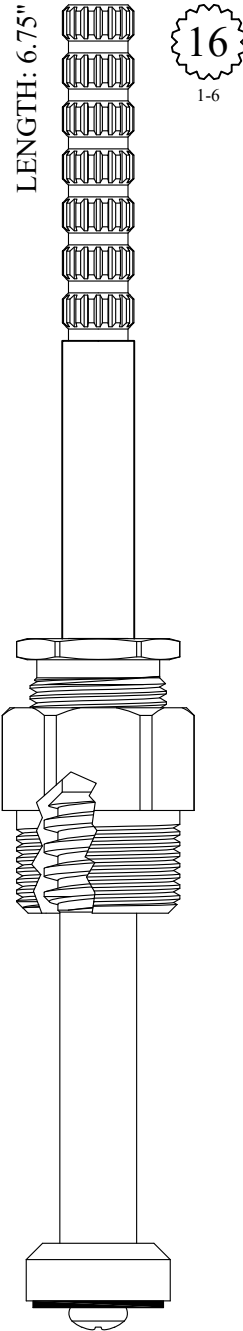

GASKET INCLUDED: 895400

427321
427322



SEAT USED: 648970

FOR PHYLRICH

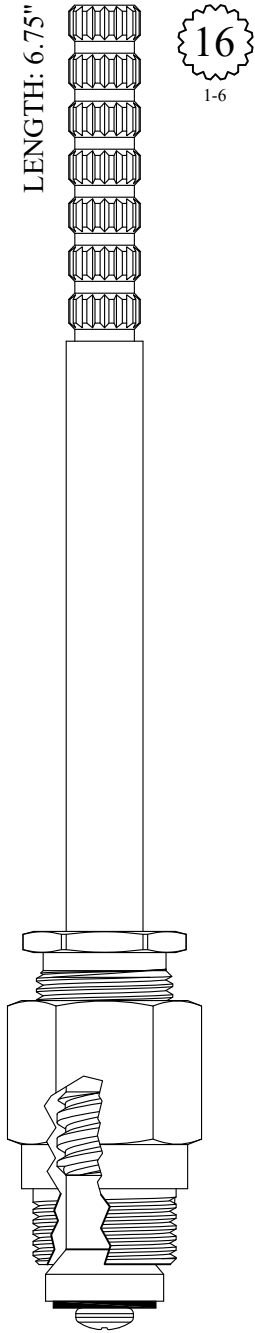

GASKET INCLUDED: 895100

427241
427242



SEAT USED: LF648550

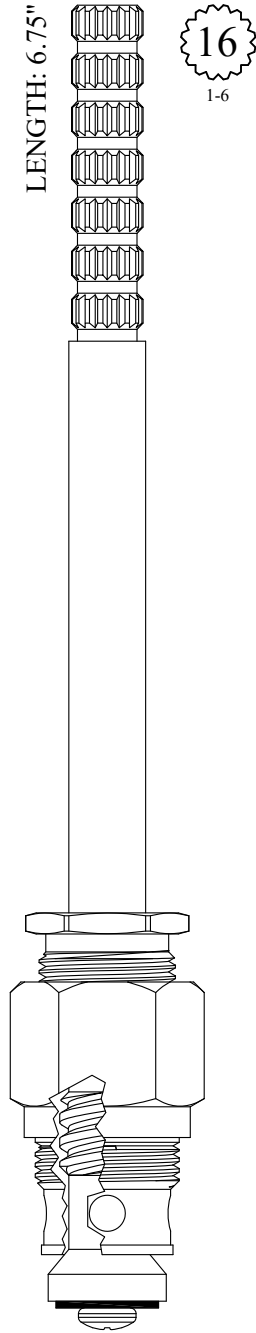

GASKET INCLUDED: 895100

439621



SEAT USED: LF648550

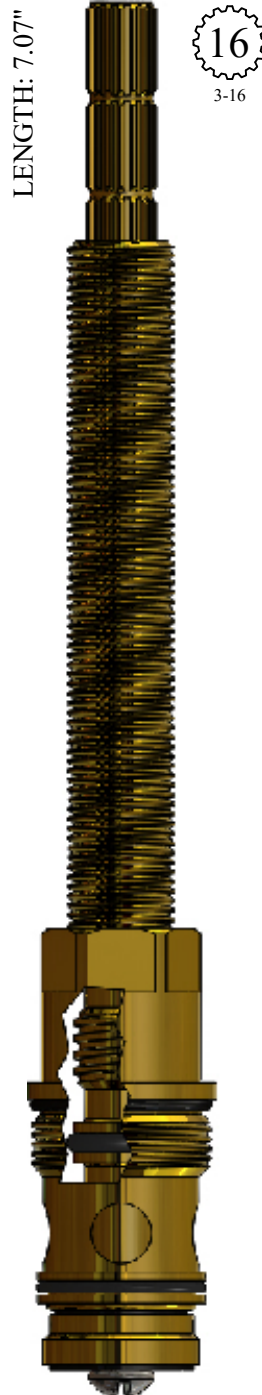

GASKET: 890190 O-RING INCLUDED

439371



SEAT USED: 647650

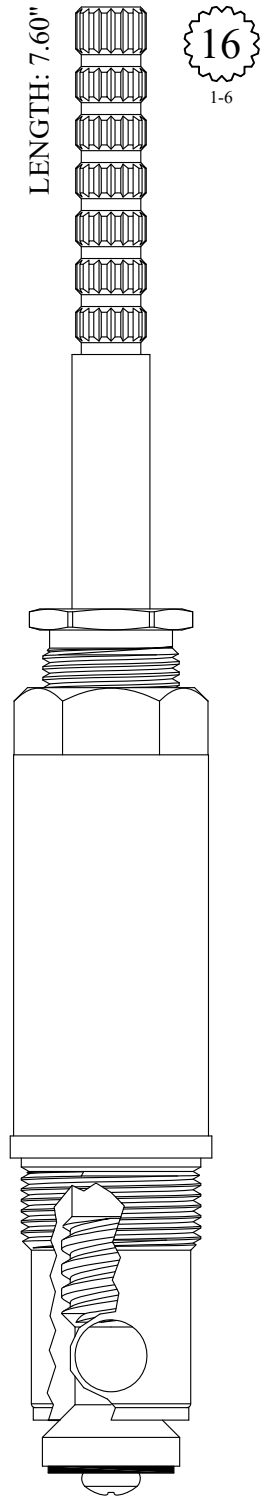

GASKET INCLUDED: 895370

439681



SEAT USED: 648970

FOR PIAZZA

LENGTH: 1.85"

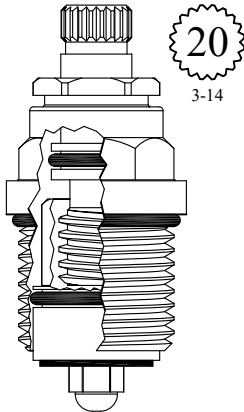

GASKET: 890180 O-RING INCLUDED

LF460802

LENGTH: 2.37"

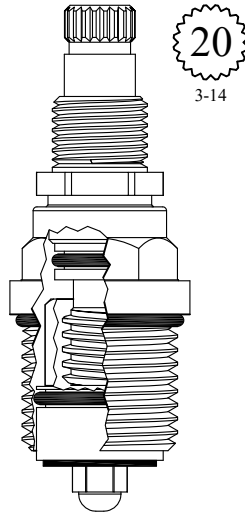

GASKET: 890180 O-RING INCLUDED

LF463702

LENGTH: 3.07"

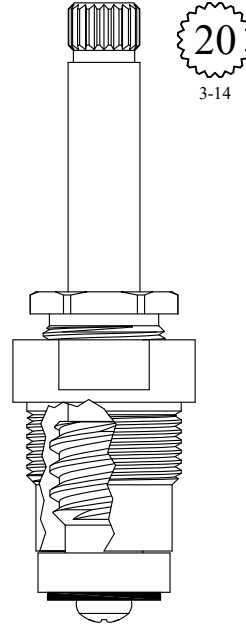

GASKET INCLUDED: 895150

401811

LENGTH: 3.26"

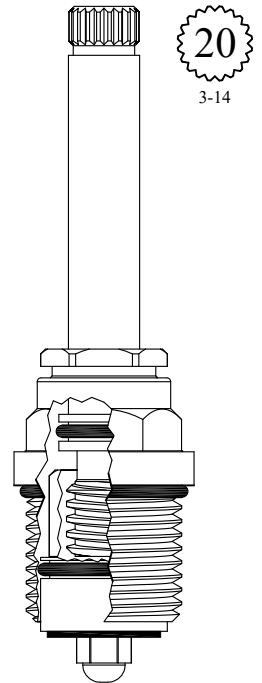

GASKET: 890180 O-RING INCLUDED

402252

FOR PILOT

Chrome Plated Sleeve & Push Button

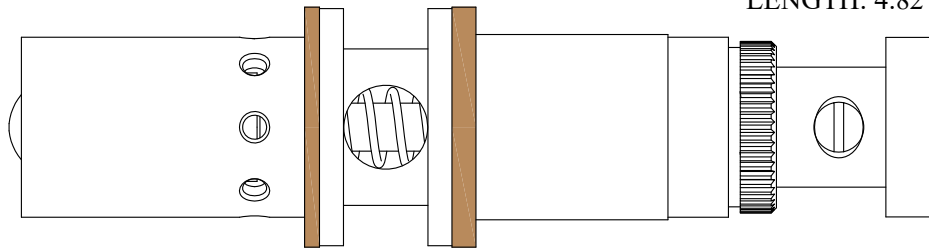

LENGTH: 4.82"

475700

GASKET: 894650 INCLUDED

FOR PORCHER

LENGTH: 2.02"

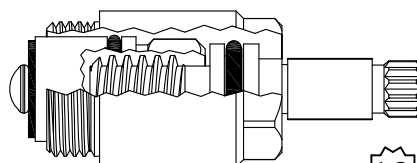

Chrome Plated Gland

LF458602

FOR POWERS

LENGTH: 1.25"



402111
OEM # 900-050

FOR POWERS



GASKET: 890180 O-RING INCLUDED

400831
OEM # 141.000

LENGTH: 1.73"

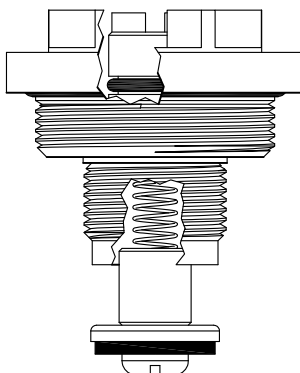

GASKET: 891230 O-RING INCLUDED

400471
200471 Stem Only
500470-KIT Retainer & Spring Only
OEM # 230-079

Also available as chrome plated unit
400471-CP
200471-CP Stem Only

LENGTH: 2.28"

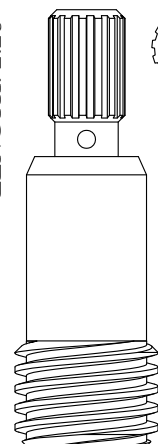

15
Small

201181
OEM # 277-079

LENGTH: 2.28"

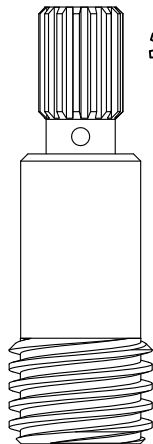

15
Large

201201
OEM # 420-122

LENGTH: 2.60"

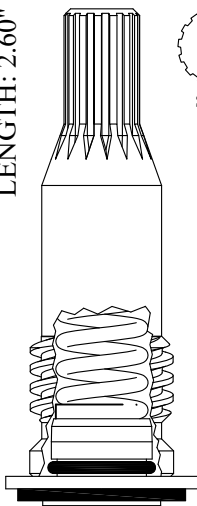

15
Small

201531
OEM # 420-139

LENGTH: 3.05"

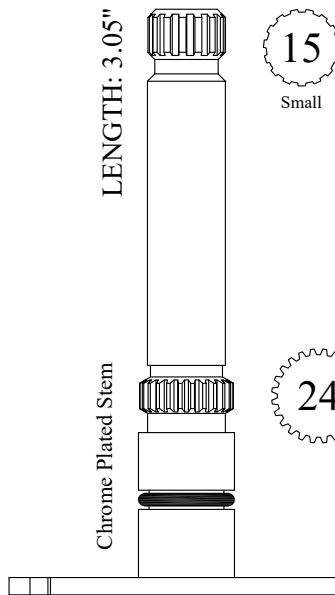

15
Small

24

201870

LENGTH: 3.37"

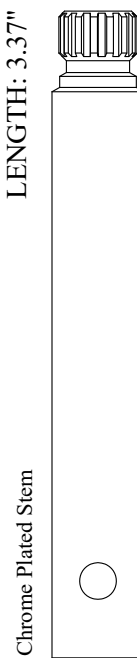

15
Small

117520

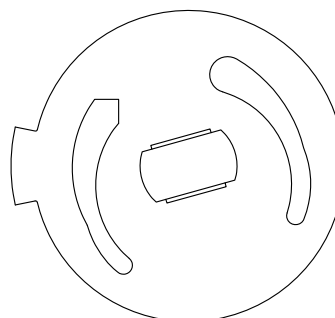

FOR PRECISION

3-Hole - Plastic Body

LENGTH: 2.54"



230670

OEM # NEWPORT 1-075

20
3-20

1-Hole - Plastic Body

LENGTH: 2.54"



231670

20
3-20

3-Hole - Plastic Body

LENGTH: 5.38"



233560

20
3-20

3-Hole - Plastic Body

LENGTH: 6.59"

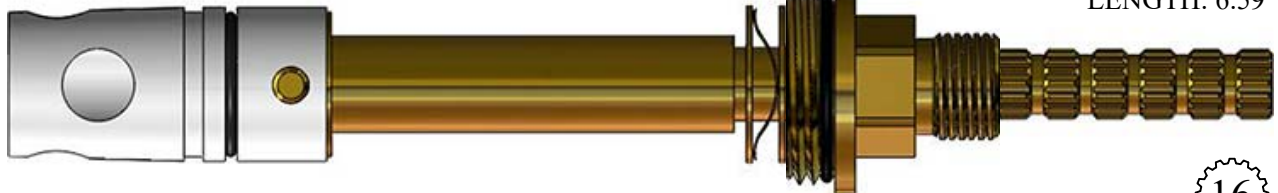

439160

239160

OEM # ALTMANS - ODC8

OEM # NEWPORT - 1-021

16
3-16

1-Hole - Plastic Body

LENGTH: 6.59"

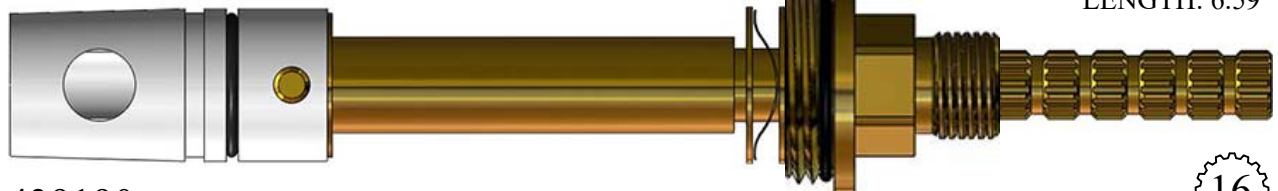

439190

239190 Stem Only

16
3-16

FOR PREMIER

1300DIVBOOT



Replacement Boot Only

STEM LENGTH: 2.92"



1300DIVERTER

Complete Diverter with Black Rubber Boot



1300DIV

Diverter WITHOUT Boot

FOR PRICE PFISTER



GASKET: 891130 O-RING INCLUDED

400501
OEM # 910-014

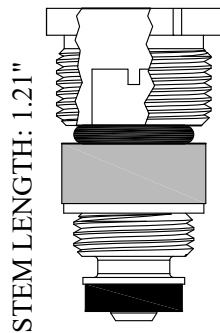

STEM LENGTH: 1.21"

400301
OEM # 910-671
200301 Stem Only

LENGTH: 1.41"

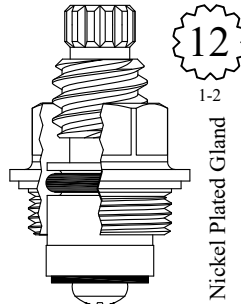

12
1-2
Nickel Plated Gland

GASKET INCLUDED: 895100

LF451031
OEM # 910-072
LF451032
OEM # 910-082

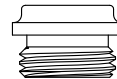

SEAT USED: LF648270

LENGTH: 1.42"

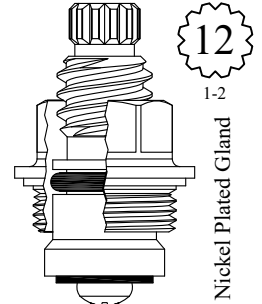

12
1-2
Nickel Plated Gland

GASKET INCLUDED: 895100

LF451041
LF451042

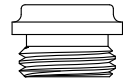

SEAT USED: LF648270

LENGTH: 1.53"

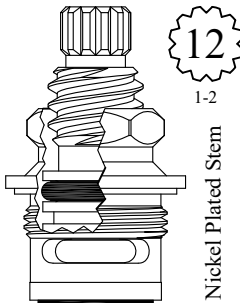

12
1-2
Nickel Plated Stem

GASKET INCLUDED: 895100

LF450951
LF450952

LENGTH: 1.63"

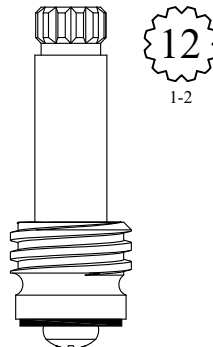

12
1-2

LF252401

LENGTH: 1.63"

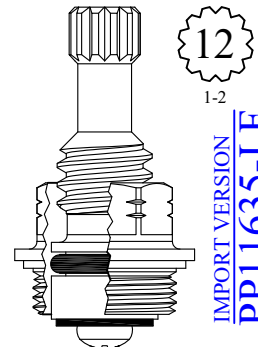

12
1-2

IMPORT VERSION
PPI1635-LF

GASKET INCLUDED: 895100

LF453051
OEM # 910-392
LF453052



SEAT USED: LF648270

FOR PRICE PFISTER

LENGTH: 1.63"

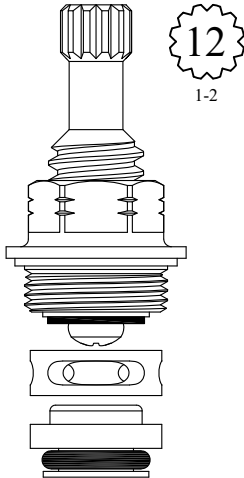

SEAT INCLUDED: LF648310

LF451001
GASKET INCLUDED: 895100
OEM # 910-394

LENGTH: 1.73"

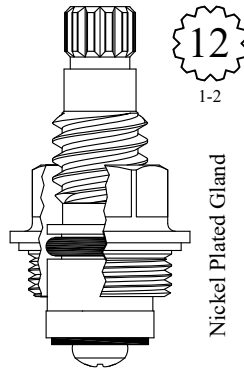

GASKET INCLUDED: 895100

LF454121
OEM # 910-282
LF454122
OEM # 910-292

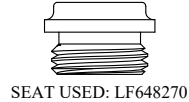

LENGTH: 1.75"

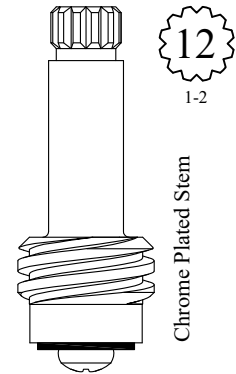

LF255161
LF255162



LENGTH: 1.76"

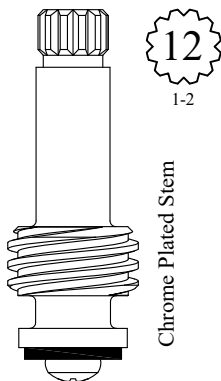

LF255061
LF255062



LENGTH: 1.77"

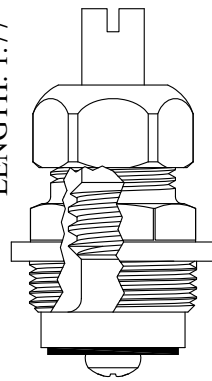

GASKET INCLUDED: 895400

400741
OEM # 910-192
200741 Stem Only
OEM # 910-191

LENGTH: 1.81"

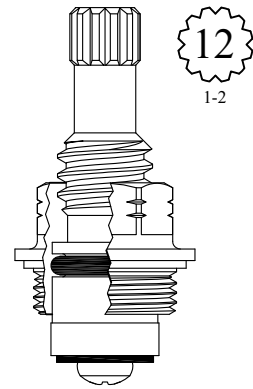

GASKET INCLUDED: 895100

LF456041
OEM # 910-402



FOR PRICE PFISTER

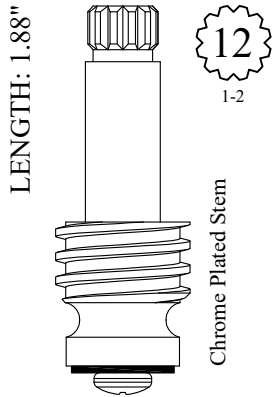

LF256251

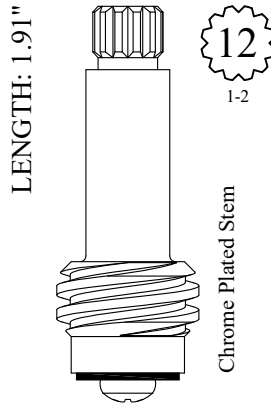

LF257051
LF257052

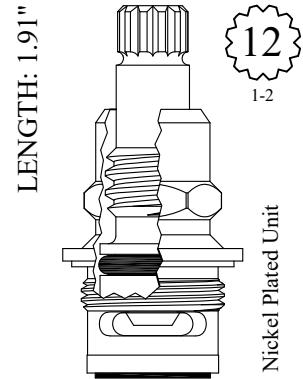

GASKET INCLUDED: 895190

LF457201
OEM # 910-681
LF457202
OEM # 910-691
[IMPORT VERSION](#)
[PP11636-LF](#)
[PP11637-LF](#)

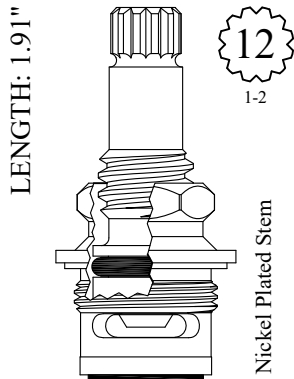

GASKET INCLUDED: 895190

LF457221
LF457222



PP11632
OEM # 974-013

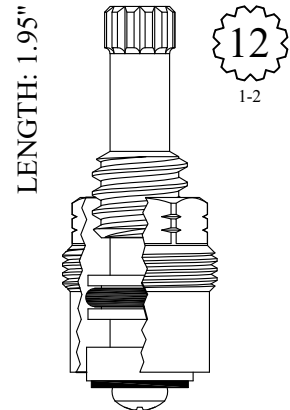

GASKET INCLUDED: 895060

LF458051
OEM # 910-492



FOR PRICE PFISTER

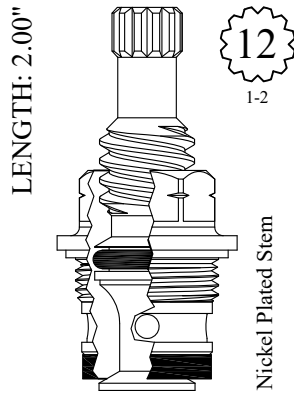

LF458072
GASKET INCLUDED: 895100
OEM # 910-651

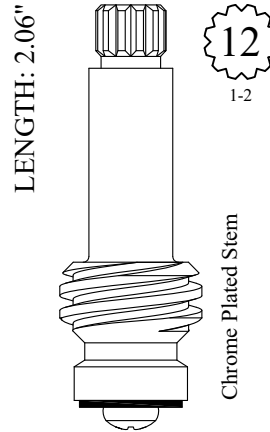

LF260081
LF260082

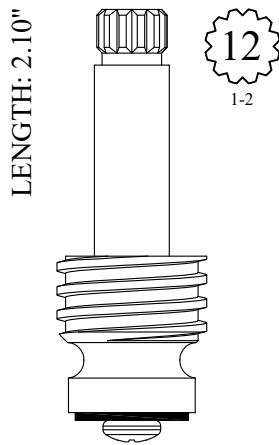

LF259251

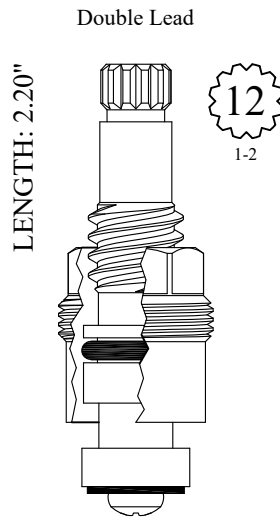

GASKET INCLUDED: 895060

LF461031
OEM # 910-202
LF461032
OEM # 910-212



SEAT USED: LF648270

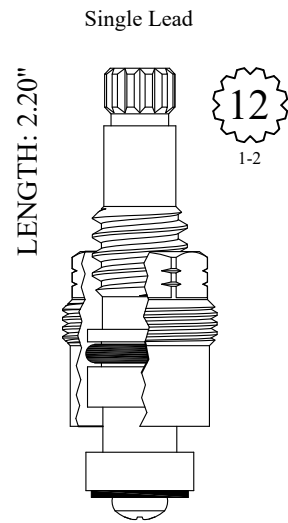

GASKET INCLUDED: 895060

LF461231
OEM # 910-412

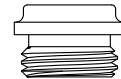

SEAT USED: LF648270

FOR PRICE PFISTER

LENGTH: 2.45"

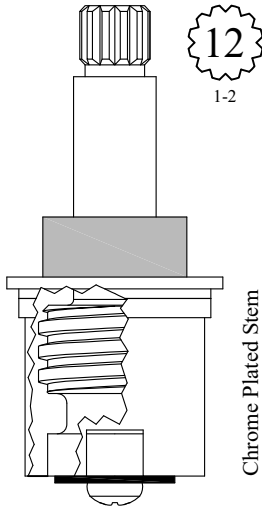

Chrome Plated Stem

401321
201351 Stem Only

Supplied with
12pt. Broach

LENGTH: 2.45"

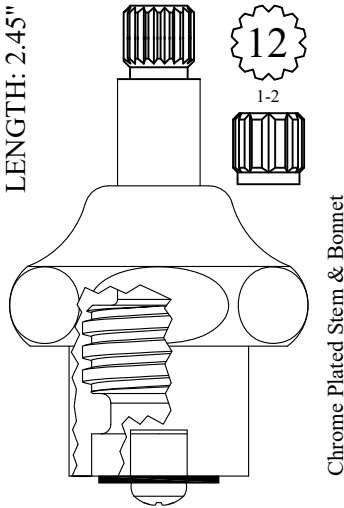

Chrome Plated Stem & Bonnet

401351
201351 Stem Only

LENGTH: 2.59"

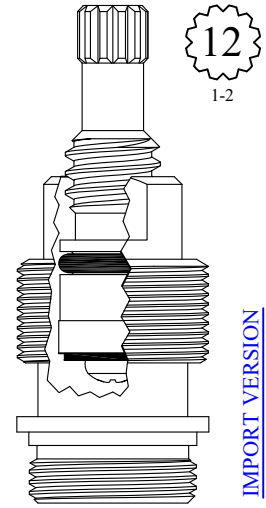

IMPORT VERSION
PP11640

GASKET INCLUDED: 895400

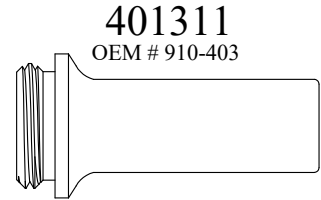

SEAT USED: 648290

401311
OEM # 910-403

LENGTH: 2.65"

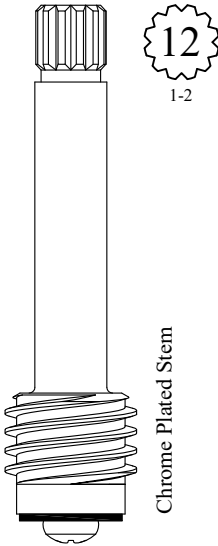

Chrome Plated Stem

LF265031
LF265032



SEAT USED: LF648270

LENGTH: 2.65"

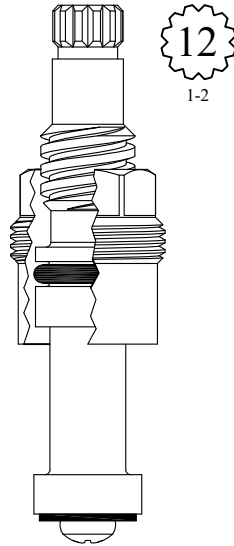

GASKET INCLUDED: 895060

LF465091
OEM # 910-262
LF465092
OEM # 910-272

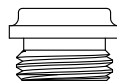

SEAT USED: LF648270

LENGTH: 2.74"

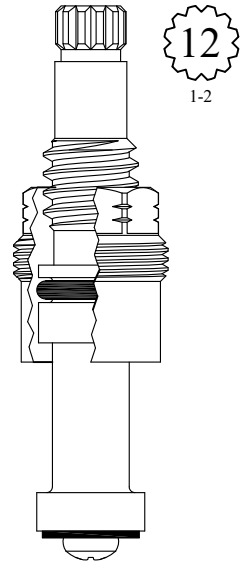

GASKET INCLUDED: 895060

LF465291
OEM # 910-422



SEAT USED: LF648270

FOR PRICE PFISTER

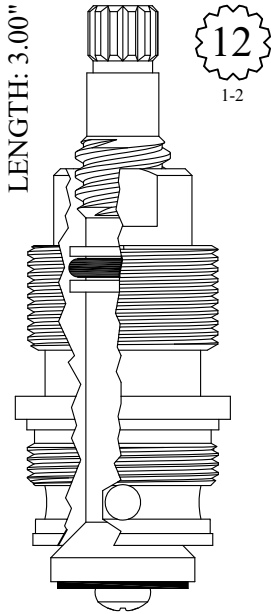

GASKET INCLUDED: 895550

430071-NS
OEM # 910-662



SEAT USED: 648370

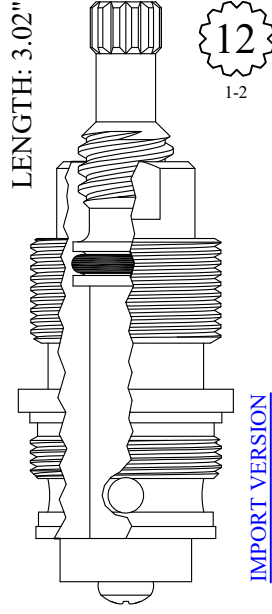

GASKET INCLUDED: 895550

430071

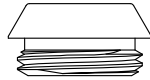

SEAT USED: 648370

IMPORT VERSION
PP11641

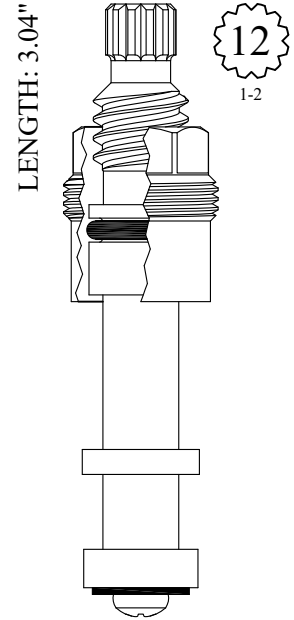

GASKET INCLUDED: 895060

LF467051
OEM # 910-222
LF467052
OEM # 910-232

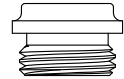

SEAT USED: LF648270

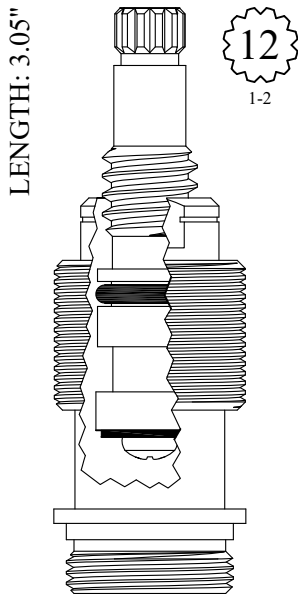

GASKET INCLUDED: 895400

402311
OEM # 910-413

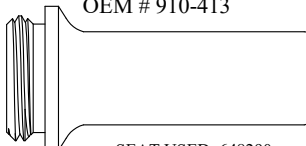

SEAT USED: 648290

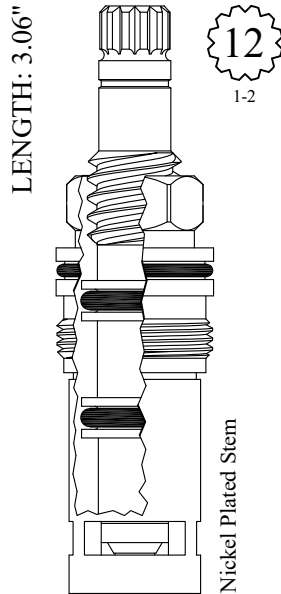

Nickel Plated Stem

LF467301
OEM # 910-830
LF467302
OEM # 910-835

IMPORT VERSION
PP11665-LF
PP1666-LF

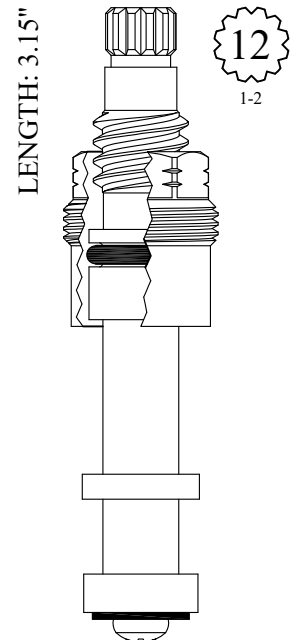

GASKET INCLUDED: 895060

LF467251
OEM # 910-432

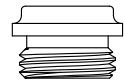

SEAT USED: LF648270

FOR PRICE PFISTER

LENGTH: 3.22"

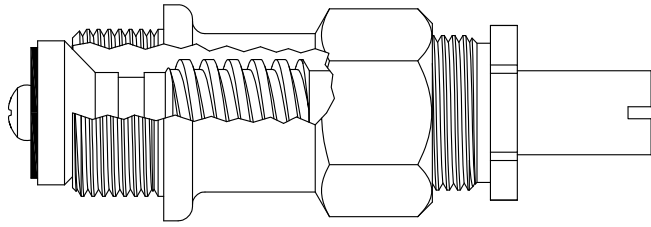

402621

GASKET INCLUDED: 895400

202621 Stem Only

LENGTH: 3.22"

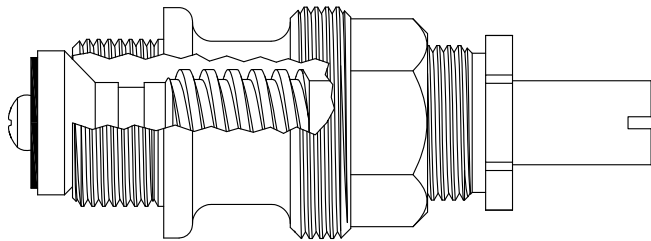

402671

GASKET INCLUDED: 895400

OEM # 910-033

202621 Stem Only

LENGTH: 3.58"

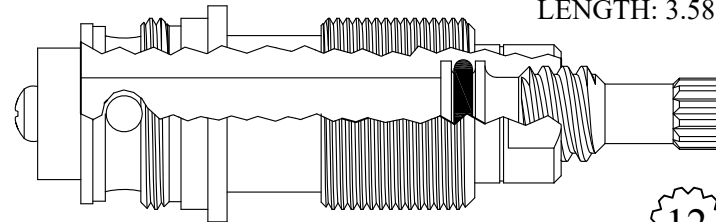

430091

GASKET INCLUDED: 895550

OEM # 910-121

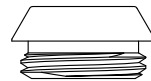

SEAT USED: 648370

12
1-2

LENGTH: 3.97"

Chrome Plated Unit

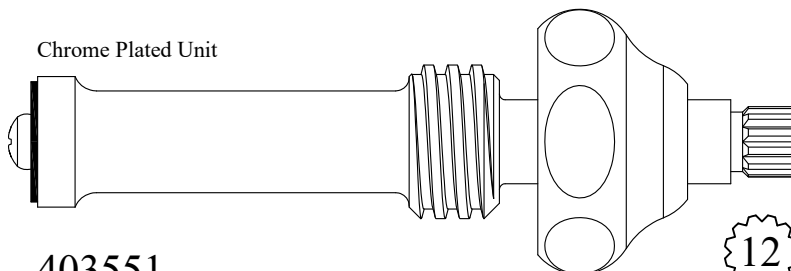

403551

203551 Stem Only

12
1-2

FOR PRICE PFISTER

Chrome Plated Stem

LENGTH: 4.22"

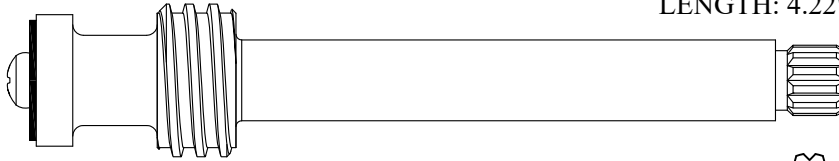

LF271071

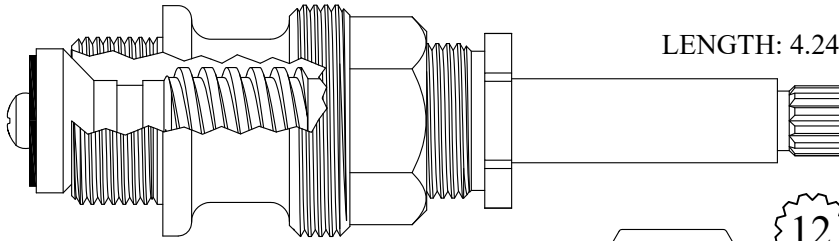

LENGTH: 4.24"

405101/ 405102

GASKET INCLUDED: 895400

OEM # 910-013/ 910-034

205101/ 205102 Stem Only

OEM # 910-011/ 910-035

IMPORT VERSION
PP21655



SEAT USED: 648370

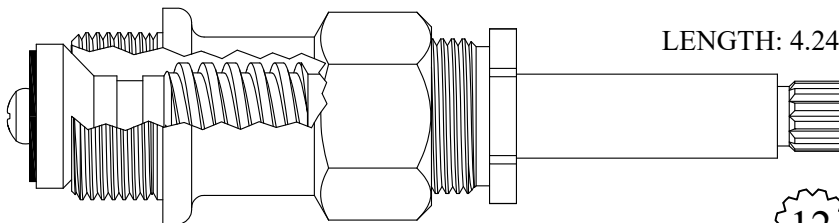

LENGTH: 4.24"

405111/ 405112

GASKET INCLUDED: 895400

OEM # 910-015

205101/ 205102 Stem Only

OEM # 910-011/ 910-035



SEAT USED: 648370

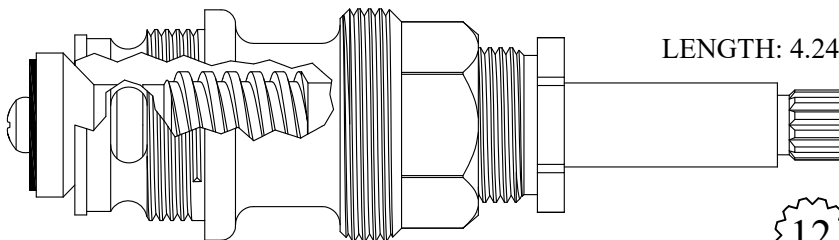

LENGTH: 4.24"

430301

GASKET: 895550

OEM # 910-021

230301 Stem Only

OEM # 910-022

IMPORT VERSION
PP21656

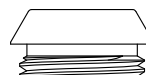

SEAT USED: 648370



FOR PRICE PFISTER

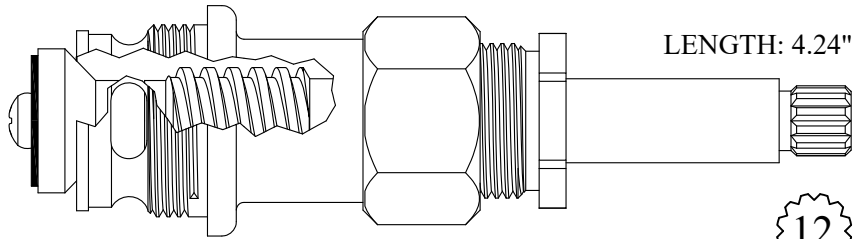

430311
GASKET INCLUDED: 895550
OEM # 910-023
230301 Stem Only

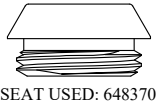

12
1-2

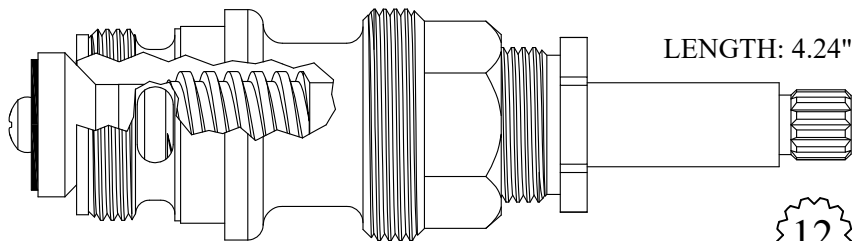

430331
GASKET INCLUDED: 895560
OEM # 910-021
230301 Stem Only

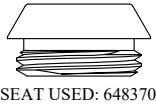

12
1-2

Chrome Plated Stem

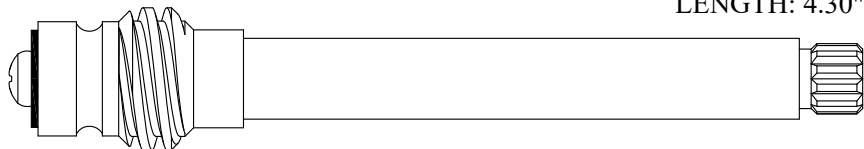

LF272031/ LF272032



12
1-2

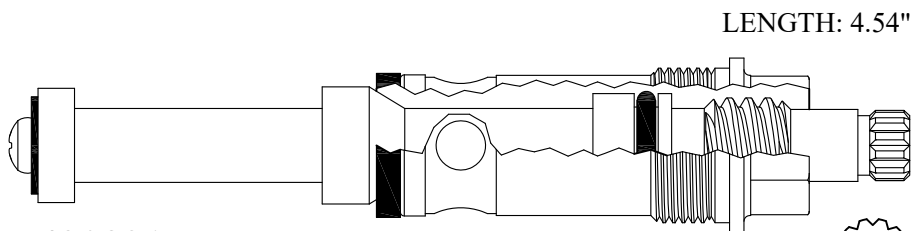

430821
GASKET: 895150
OEM # 910-442

12
1-2

FOR PRICE PFISTER

LENGTH: 4.55"

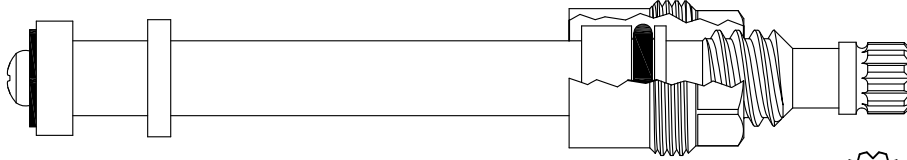

LF474011/ LF474012

GASKET INCLUDED: 895060
OEM # 910-300

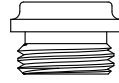

SEAT USED: LF648270



1-2

LENGTH: 4.69"

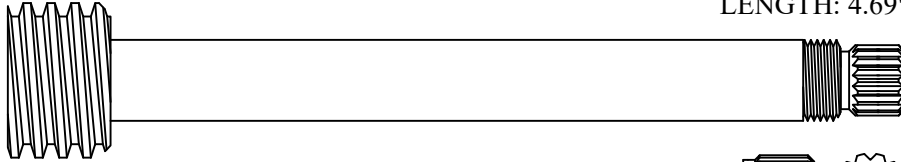

208971

Supplied with
12pt. Broach



1-2

LENGTH: 4.85"

Nickel Plated Stem

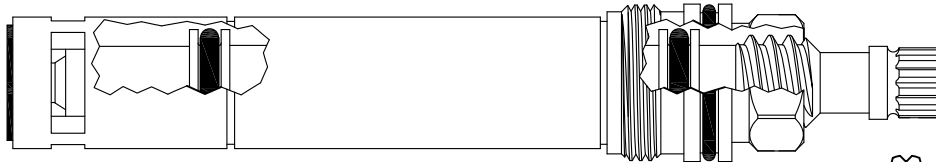

LF477201/ LF477202



1-2

LENGTH: 5.12"

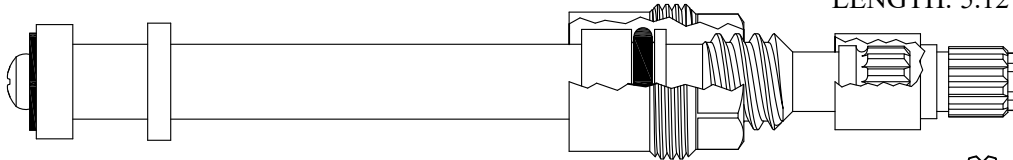

LF479401/ LF479402

GASKET INCLUDED: 895060
OEM # 910-333/ 910-334

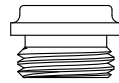

SEAT USED: LF648270



1-2

LENGTH: 5.42"

Nickel Plated Stem

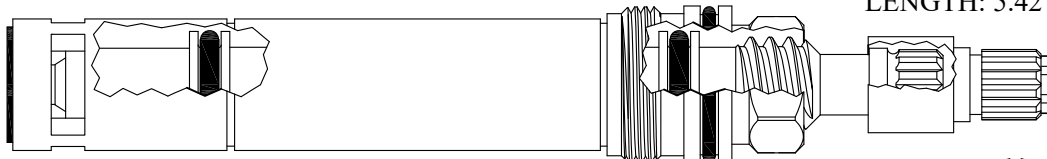

LF480381/ LF480382

OEM # 910-825/ 910-683



1-2

FOR PRICE PFISTER

Chrome Plated Stem & Esc Tube

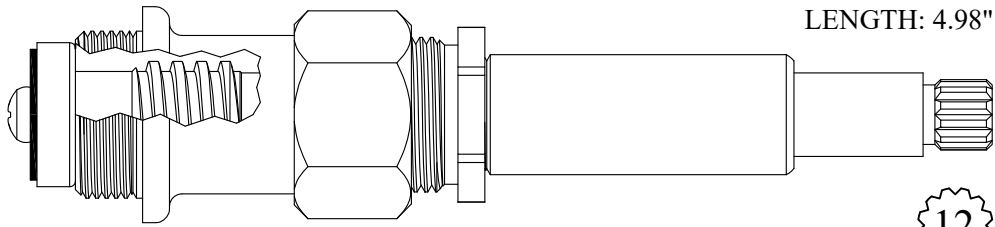

LENGTH: 4.98"

412901

GASKET INCLUDED: 895400
OEM # 910-044

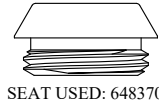

SEAT USED: 648370

12
1-2

Chrome Plated Stem

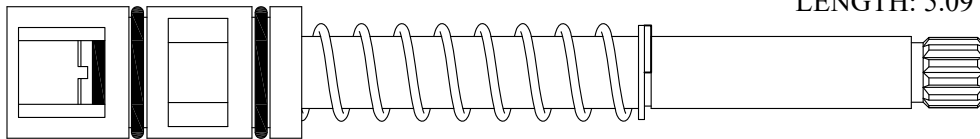

LENGTH: 5.09"

236260

OEM # 974-700

12
1-2

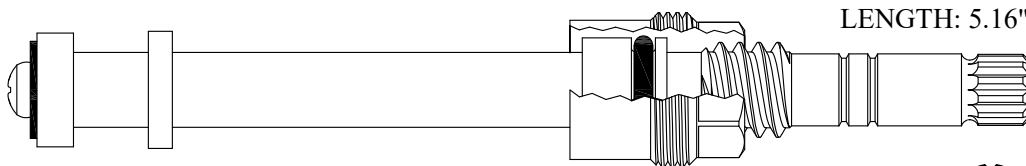

LENGTH: 5.16"

LF479501/ LF479502

GASKET INCLUDED: 895060

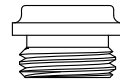

SEAT USED: LF648270

12
1-2

Chrome Plated Stem

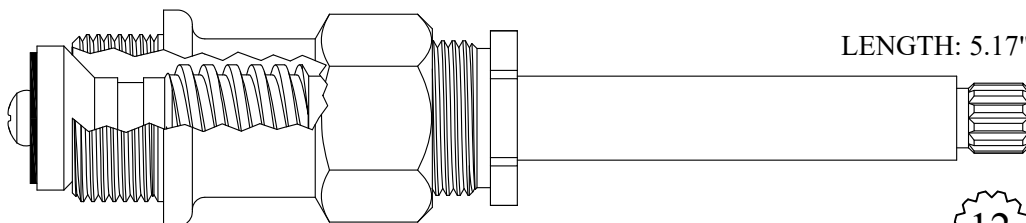

LENGTH: 5.17"

415301/ 415302

GASKET INCLUDED: 895400
OEM # 910-043

215301/ 215302 Stem Only

OEM # 910-041



SEAT USED: 648370

12
1-2

FOR PRICE PFISTER

Chrome Plated Stem

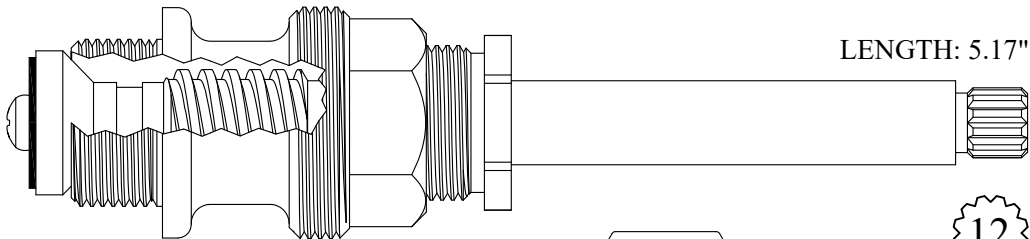

LENGTH: 5.17"

415311/ 415312

GASKET INCLUDED: 895400

215301/ 215302 Stem Only



SEAT USED: 648370



1-2

Chrome Plated Stem

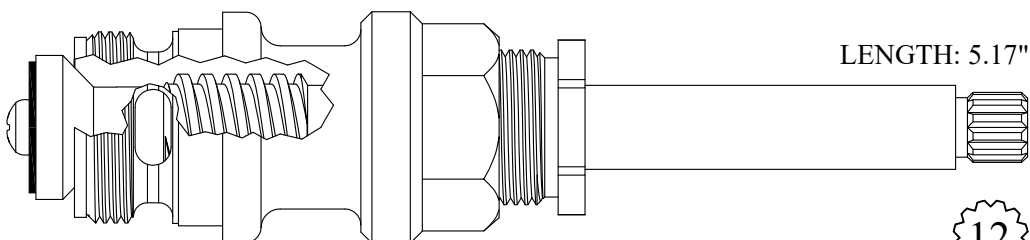

LENGTH: 5.17"

432001

GASKET INCLUDED: 895560

OEM # 910-052

232001 Stem Only

OEM # 910-051

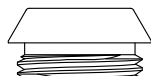

SEAT USED: 648370



1-2

Chrome Plated Stem

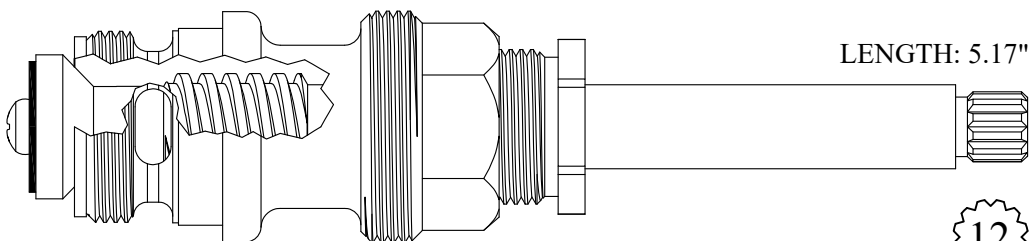

LENGTH: 5.17"

432011

GASKET INCLUDED: 895560

232001 Stem Only

OEM # 910-051

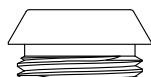

SEAT USED: 648370



1-2

Chrome Plated Stem

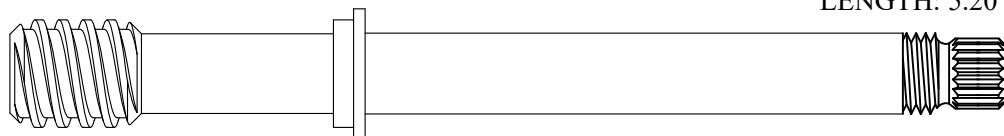

LENGTH: 5.20"

232651

Supplied with
12pt. Broach



1-2

FOR PRICE PFISTER

Nickel Plated Stem

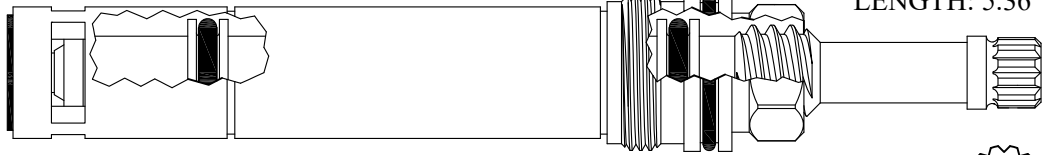

LENGTH: 5.36"

LF480401/ LF480402
OEM # 910-701/ 910-710



Chrome Plated Stem

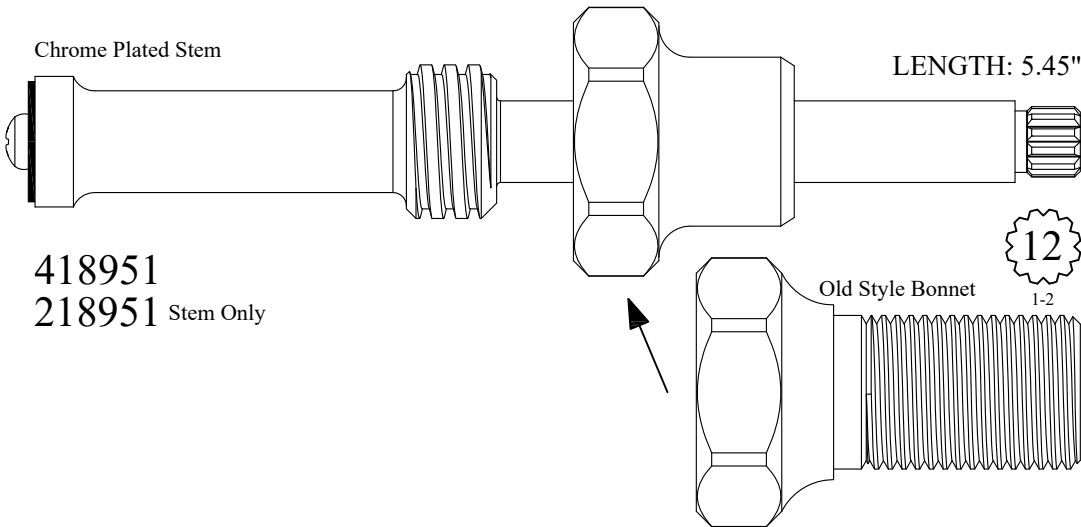

LENGTH: 5.45"

418951
218951 Stem Only



Chrome Plated Stem

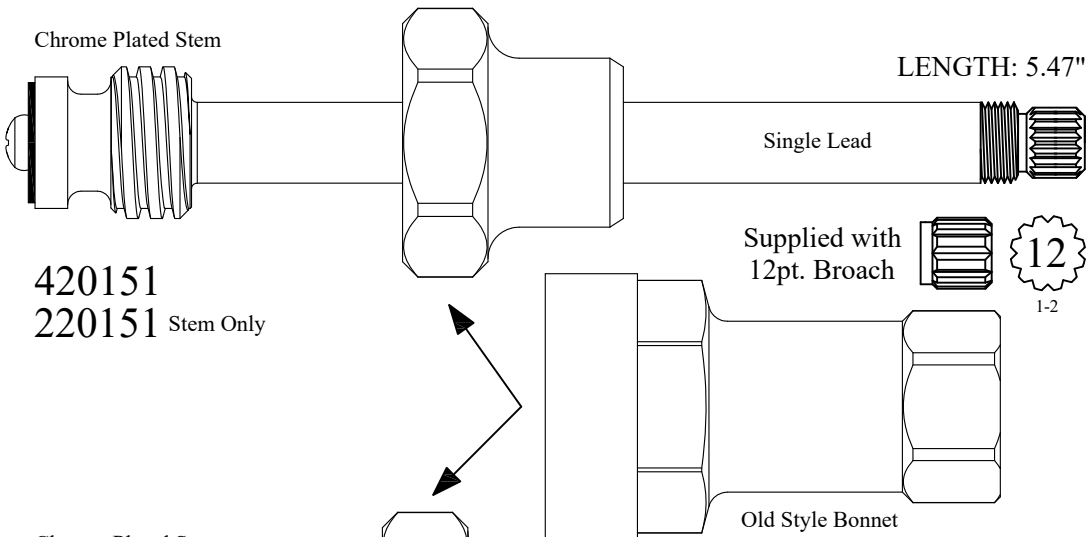

LENGTH: 5.47"

Single Lead

420151
220151 Stem Only

Supplied with
12pt. Broach



Chrome Plated Stem

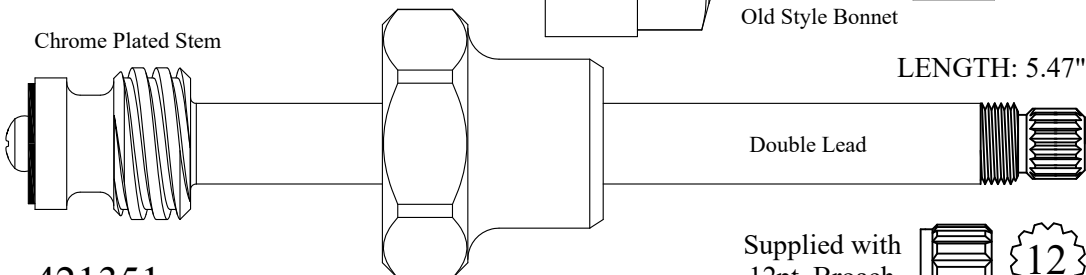

LENGTH: 5.47"

Double Lead

421351
221351 Stem Only

Supplied with
12pt. Broach



FOR PRICE PFISTER

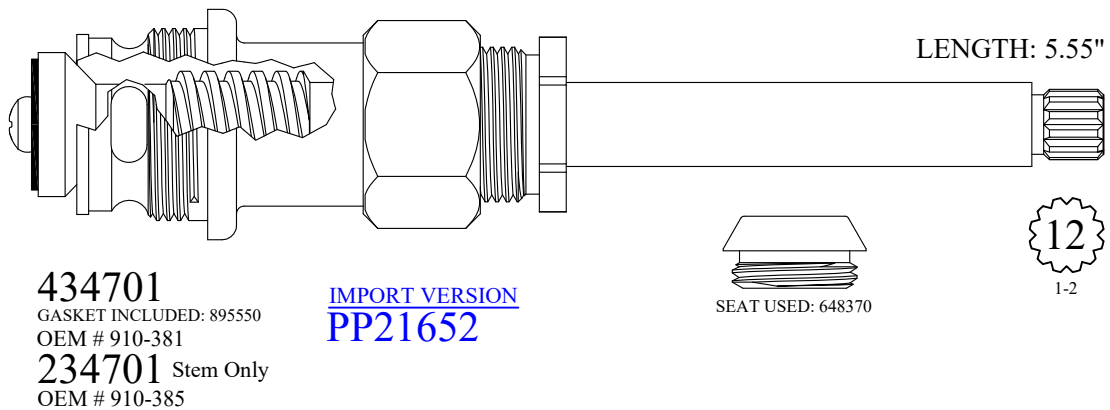
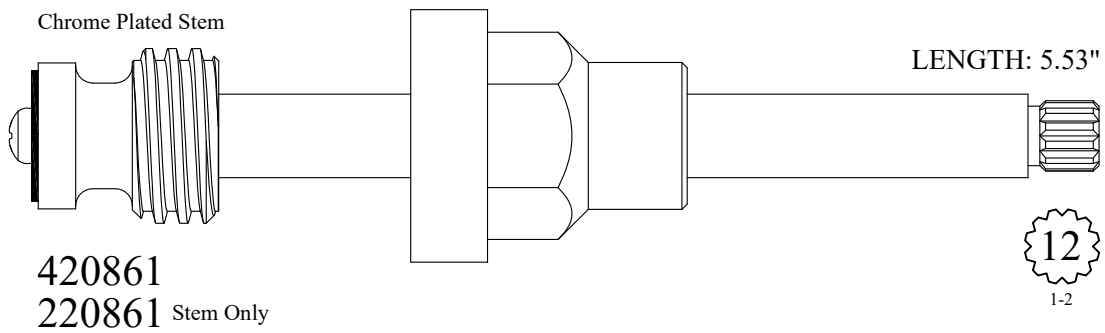
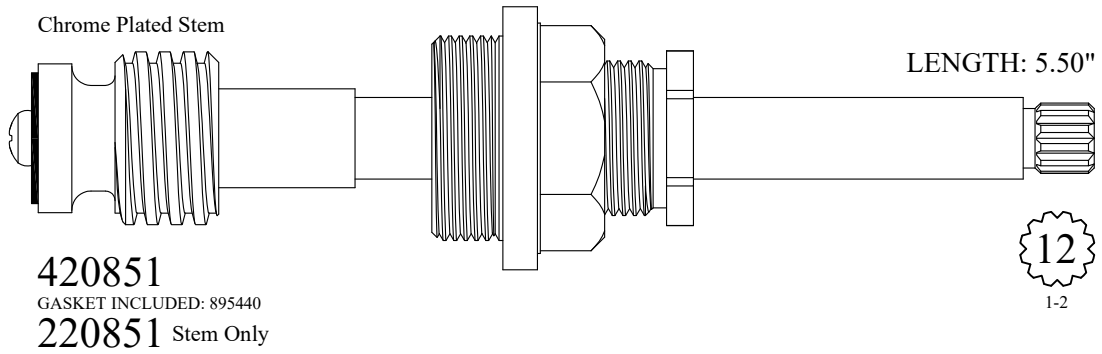
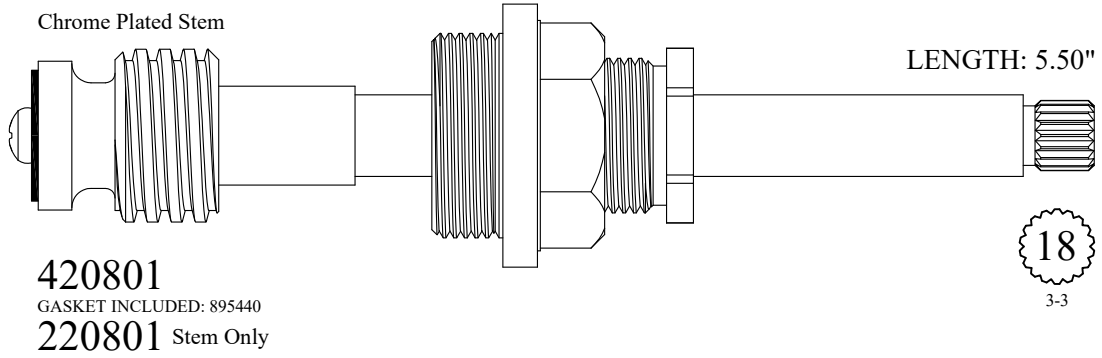

FOR PRICE PFISTER

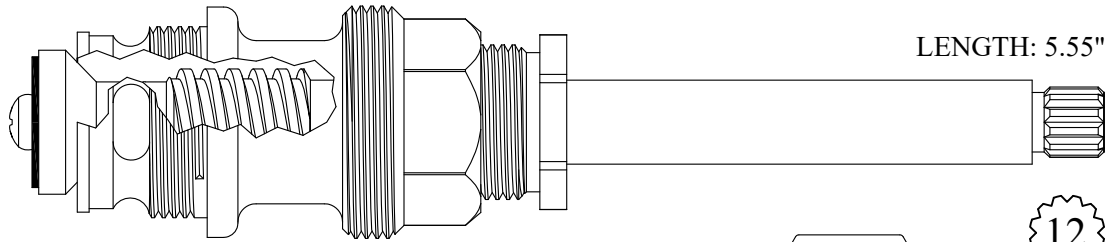

LENGTH: 5.55"

434711
GASKET INCLUDED: 895550
OEM # 910-382
234701 Stem Only

IMPORT VERSION
PP21654

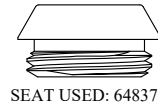

SEAT USED: 648370

12
1-2

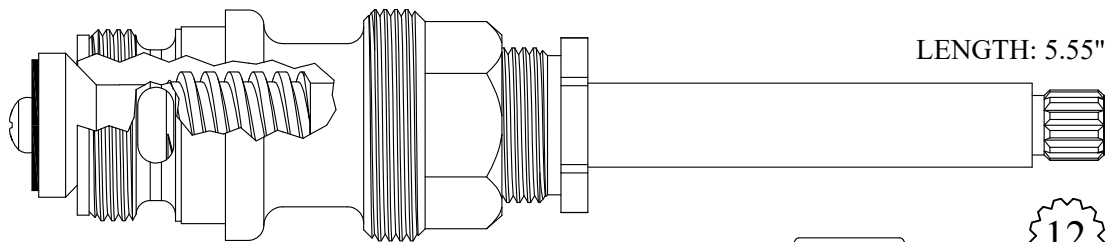

LENGTH: 5.55"

434751
GASKET INCLUDED: 895560
234701 Stem Only



SEAT USED: 648370

12
1-2

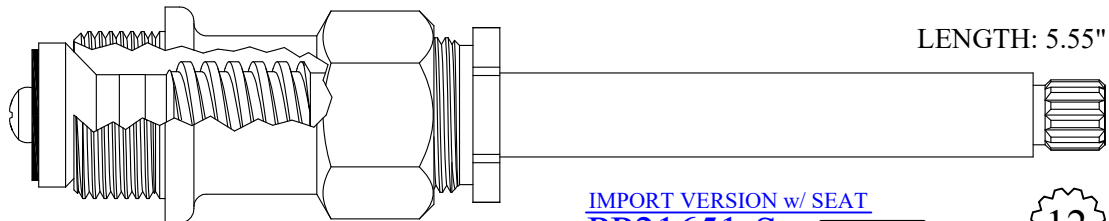

LENGTH: 5.55"

421601/ 421602
GASKET INCLUDED: 895400
OEM # 910-374
221601/ 221602 Stem Only
OEM # 910-371

IMPORT VERSION
PP21651

IMPORT VERSION w/ SEAT
PP21651-S

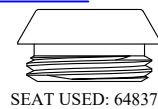

SEAT USED: 648370

12
1-2

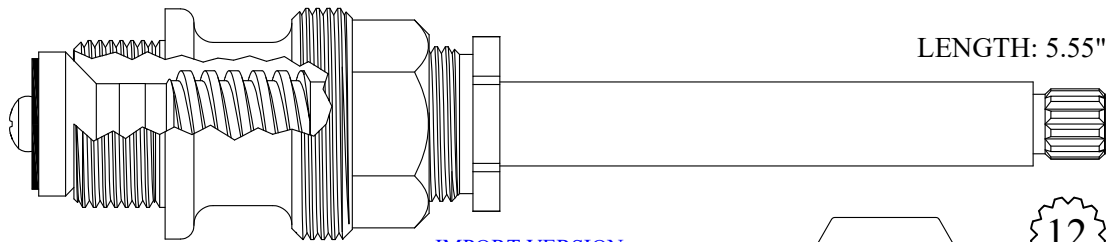

LENGTH: 5.55"

421611/ 421612
GASKET INCLUDED: 895400
OEM # 910-372
221601/ 221602 Stem Only
OEM # 910-371

IMPORT VERSION
PP21653

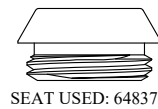

SEAT USED: 648370

12
1-2

FOR PRICE PFISTER

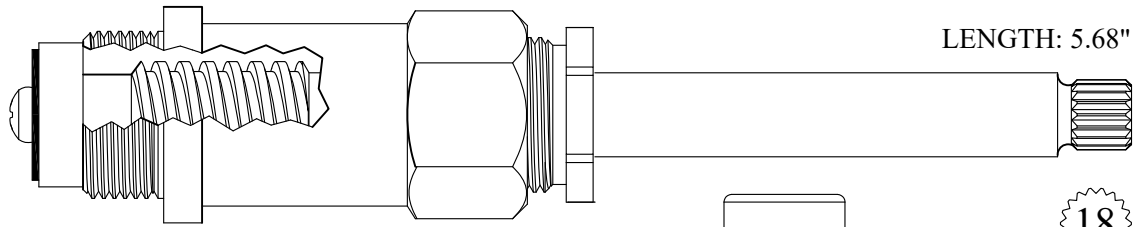

LENGTH: 5.68"

Use 421601

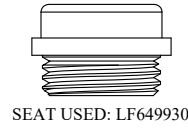

SEAT USED: LF649930

18
Old Style
Price Pfister

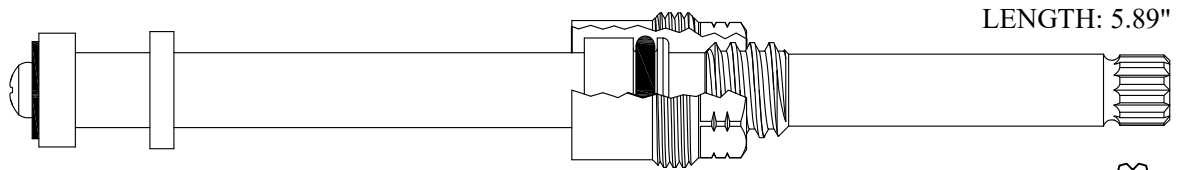

LENGTH: 5.89"

LF480071/ LF480072

GASKET INCLUDED: 895060
OEM # 910-523

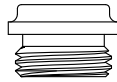

SEAT USED: LF648270

12
1-2

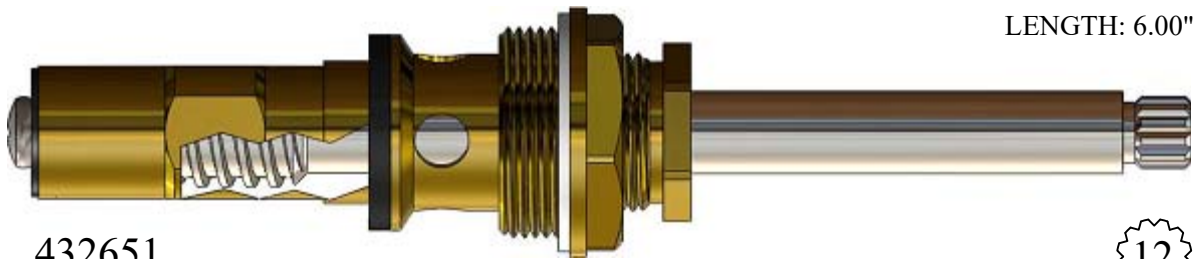

LENGTH: 6.00"

432651

GASKET INCLUDED: 895440

12
1-2

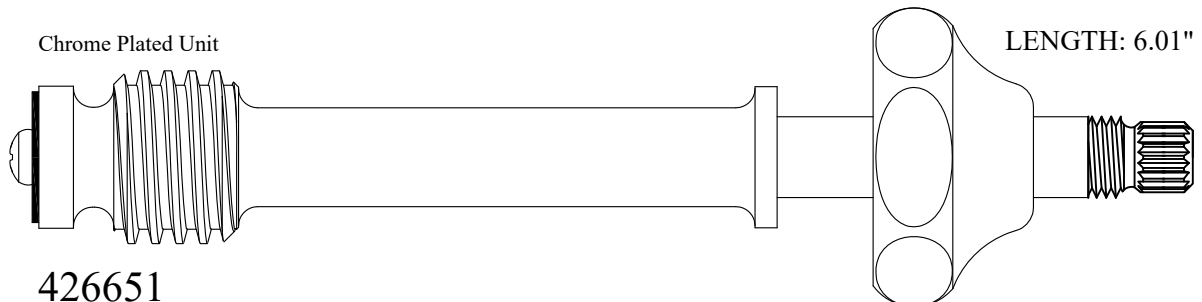

Chrome Plated Unit

LENGTH: 6.01"

426651

226651 Stem Only

Supplied with
12pt. Broach



12
1-2

FOR PRICE PFISTER

Chrome Plated Stem

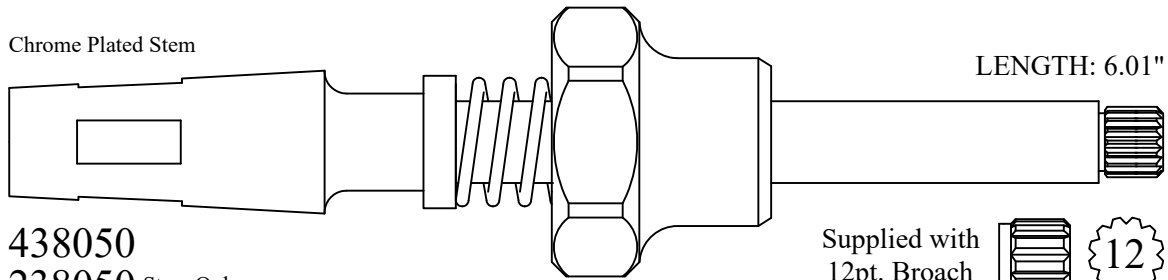

LENGTH: 6.01"

438050
238050 Stem Only

Supplied with
12pt. Broach  12
1-2

Chrome Plated Stem

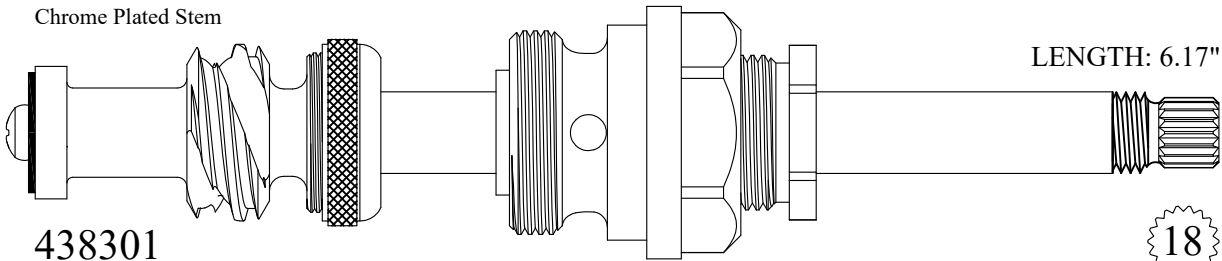

LENGTH: 6.17"

438301
GASKET INCLUDED: 895450
238301 Stem Only

18
Old Style
Price Pfister

Chrome Plated Stem

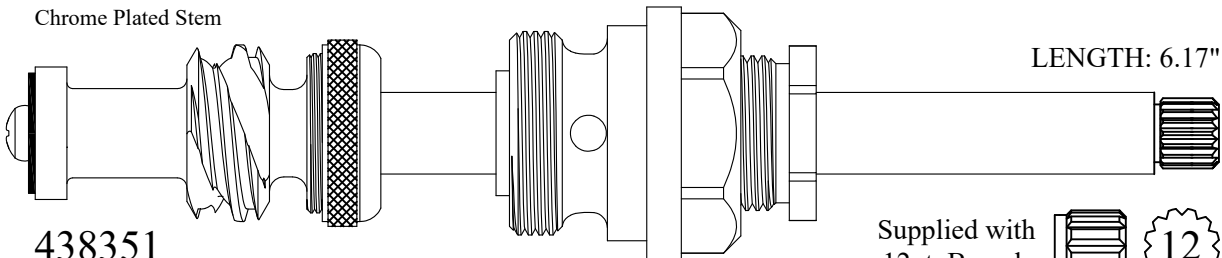

LENGTH: 6.17"

438351
GASKET INCLUDED: 895450
238351 Stem Only

Supplied with
12pt. Broach  12
1-2

Chrome Plated Stem

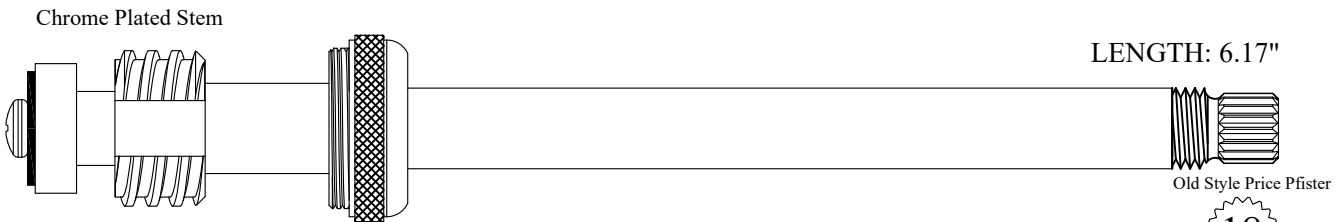

LENGTH: 6.17"

239152
GASKET INCLUDED: 895450

Old Style Price Pfister
18

Chrome Plated Unit

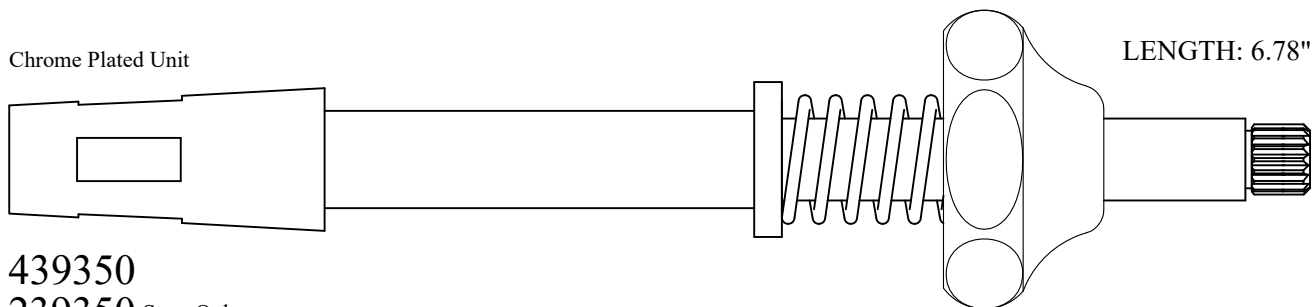

LENGTH: 6.78"

439350
239350 Stem Only

Supplied with
12pt. Broach  12
1-2

FOR PRINCIPE

LENGTH: 2.16"

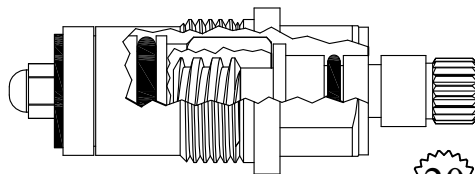

LF459812

GASKET INCLUDED: 895100

20
11/32
3-34

FOR PUBCO

Chrome Plated Stem

LENGTH: 2.25"

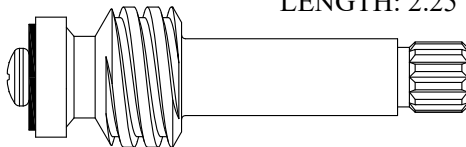

LF262041

LF262042

12
1-2

Chrome Plated Unit

LENGTH: 4.93"

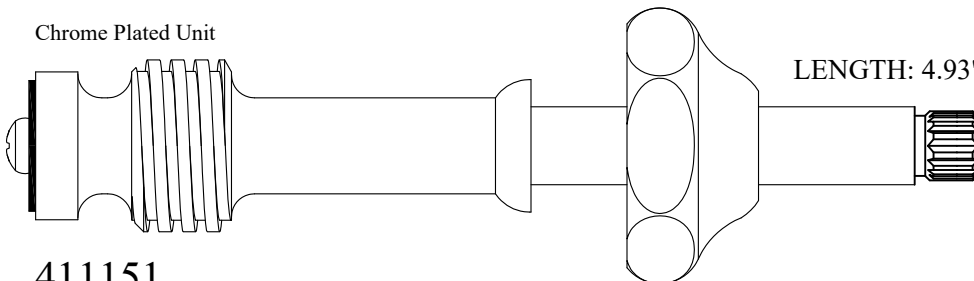

411151

211151 Stem Only

Supplied with
12pt. Broach



12
1-2

Chrome Plated Stem

LENGTH: 4.93"

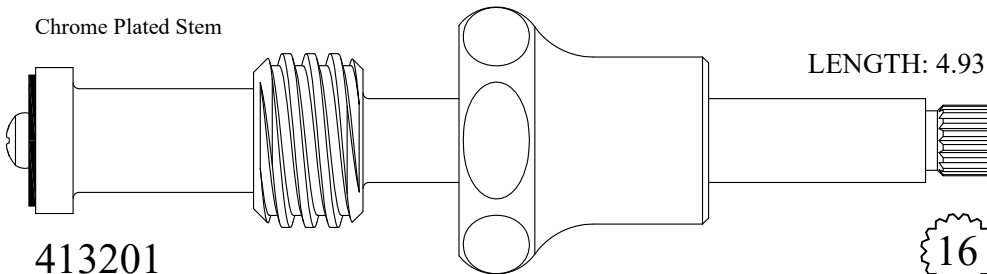

413201

213201 Stem Only

16
1-6

Chrome Plated Stem

LENGTH: 4.93"

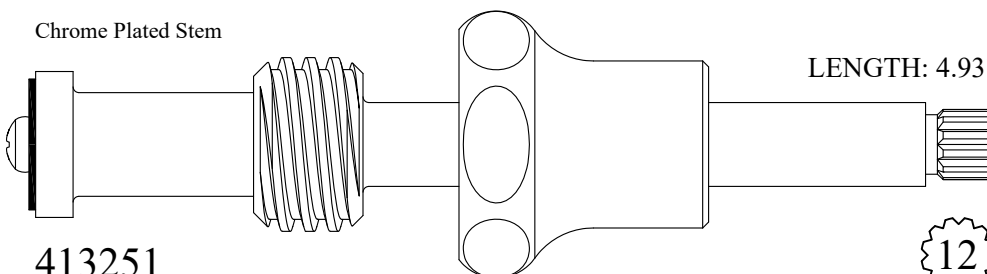

413251

213251 Stem Only

12
1-2

FOR PUBCO

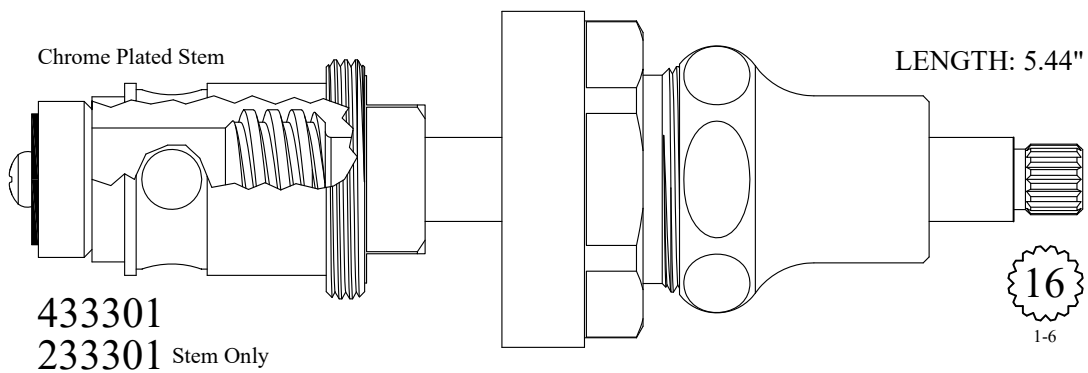
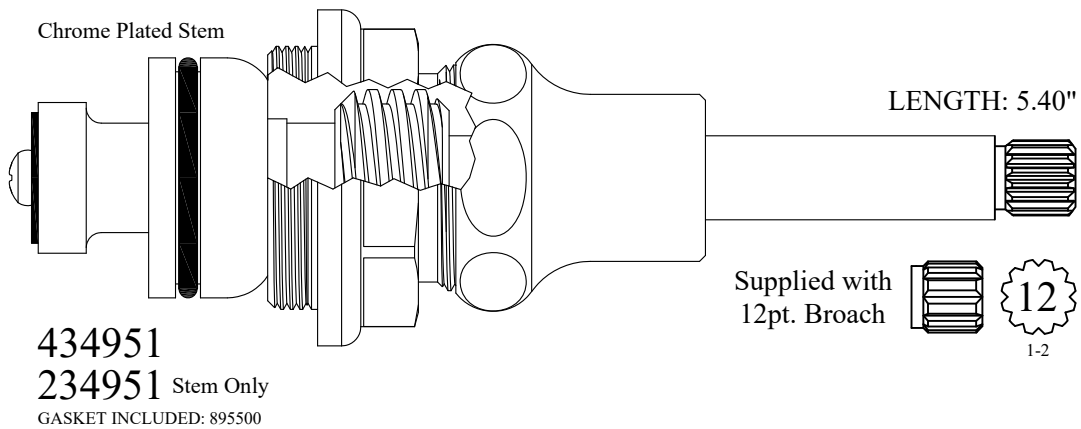
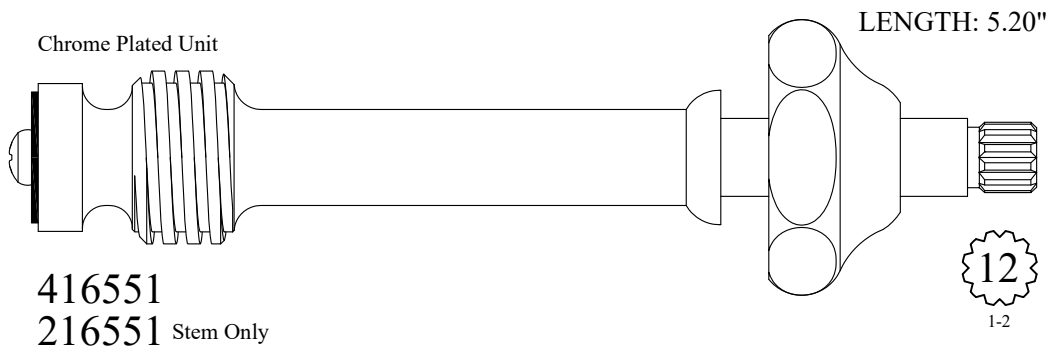
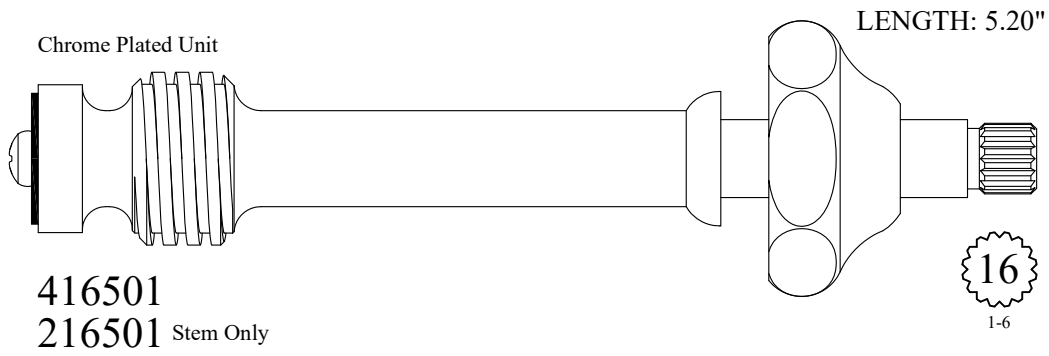

FOR PUBCO

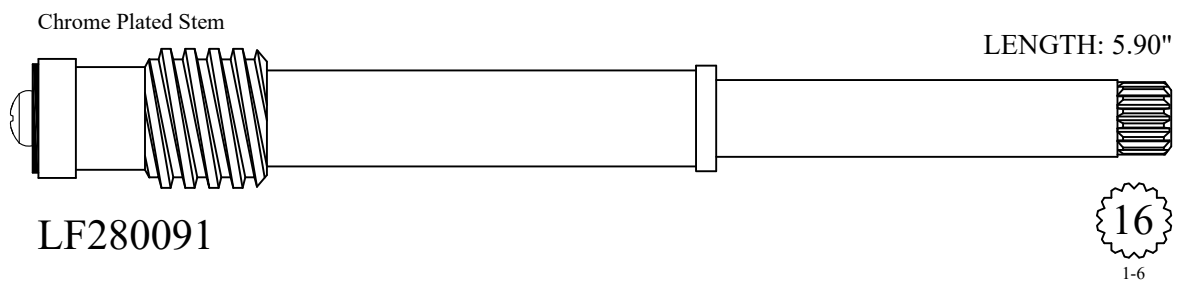
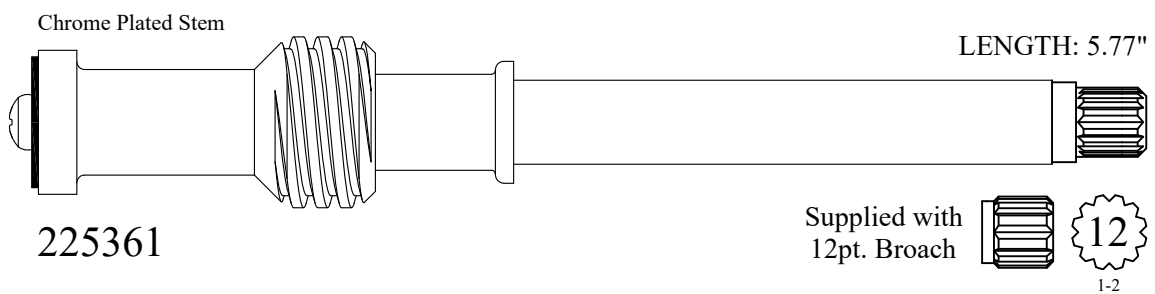
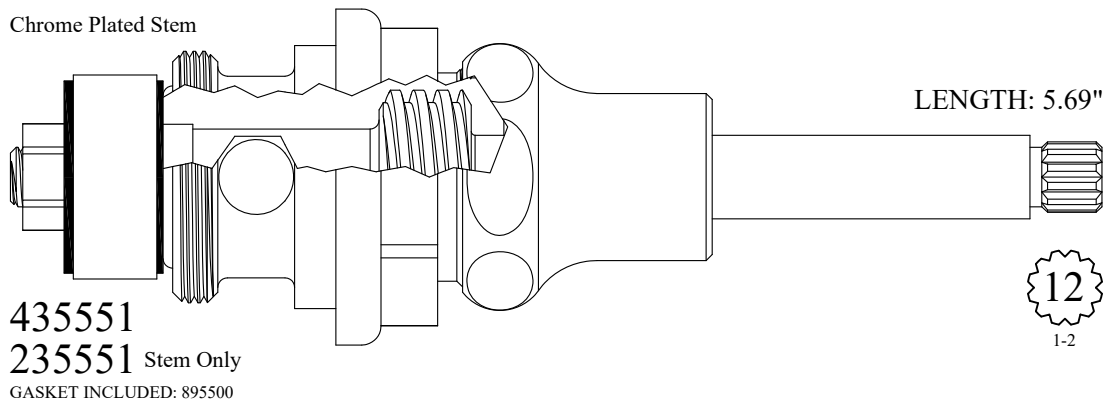
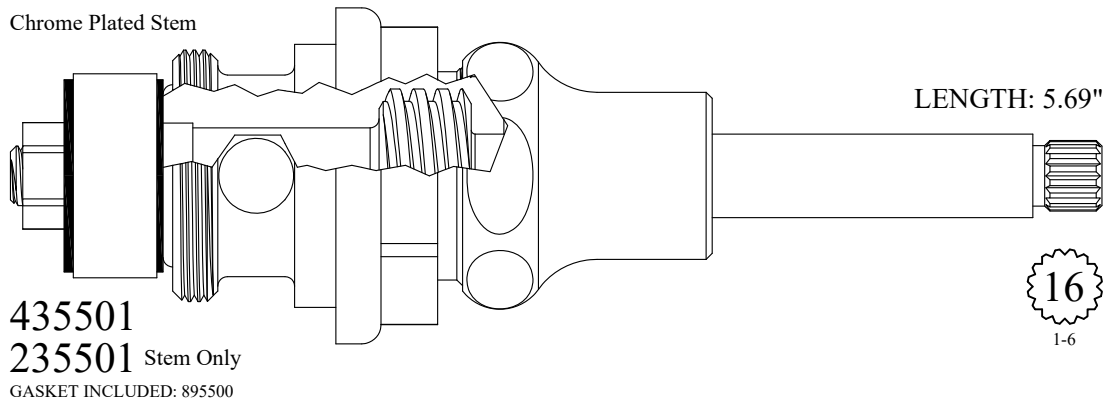
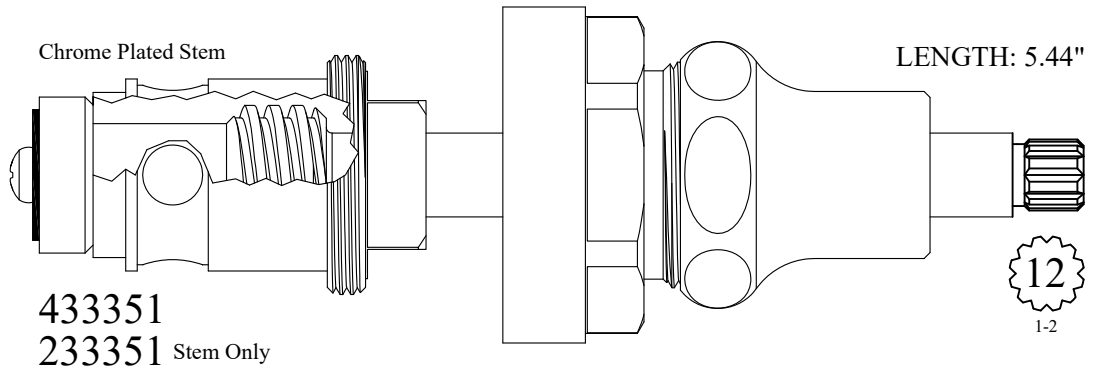

FOR QUEEN CITY

Chrome Plated Stem

LENGTH: 5.75"

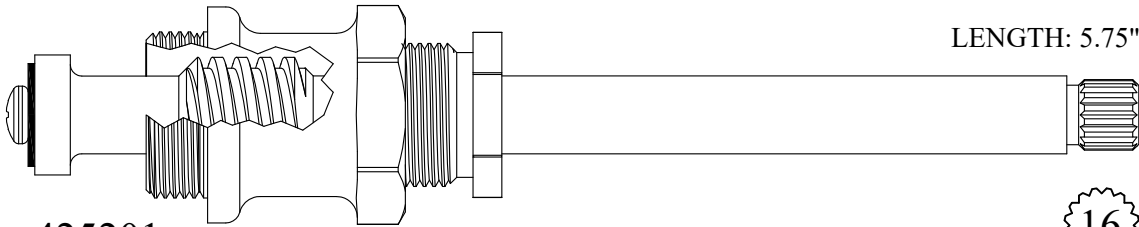
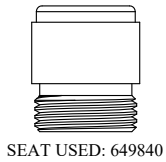

425201

GASKET INCLUDED: 895400

225201 Stem Only

16

1-6

Chrome Plated Stem

LENGTH: 5.75"

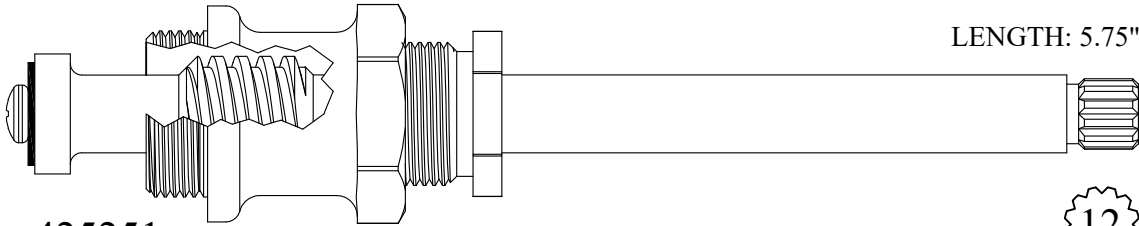
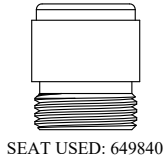

425251

GASKET INCLUDED: 895400

225251 Stem Only

12

1-2

Chrome Plated Stem

LENGTH: 5.87"

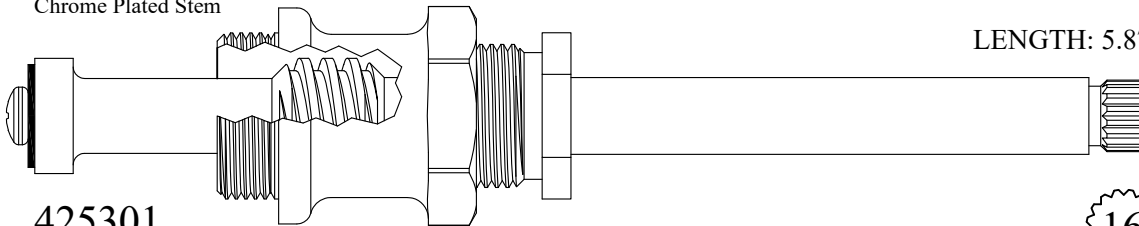
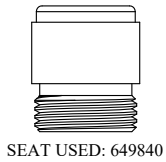

425301

GASKET INCLUDED: 895400

225302 Stem Only

16

1-6

Chrome Plated Stem

LENGTH: 5.87"

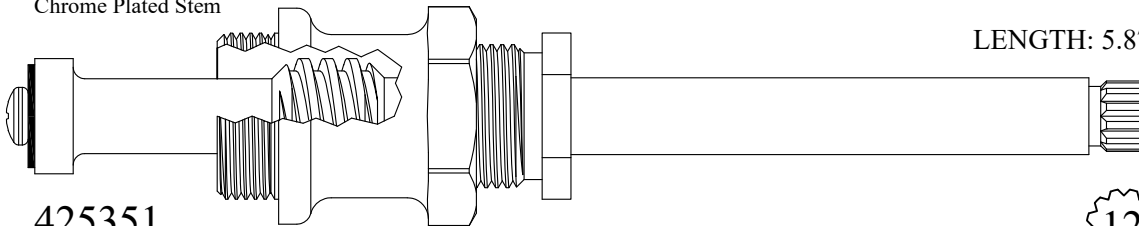
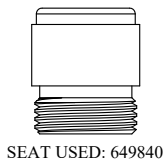

425351

GASKET INCLUDED: 895400

225352 Stem Only

12

1-2

Chrome Plated Stem

LENGTH: 5.89"

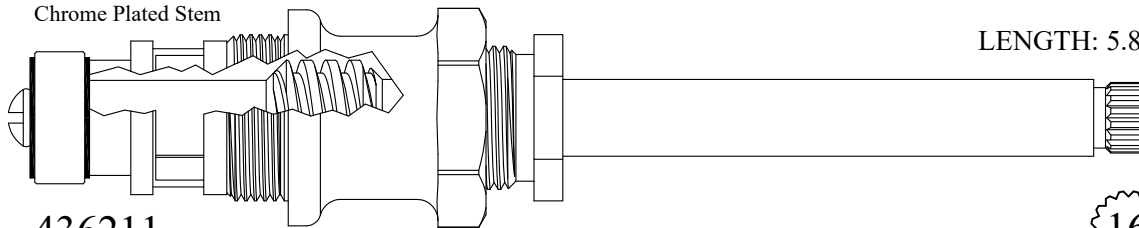
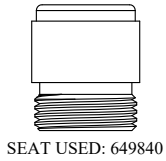

436211

GASKET INCLUDED: 895400

236211 Stem Only

16

1-6

FOR RAPETTI

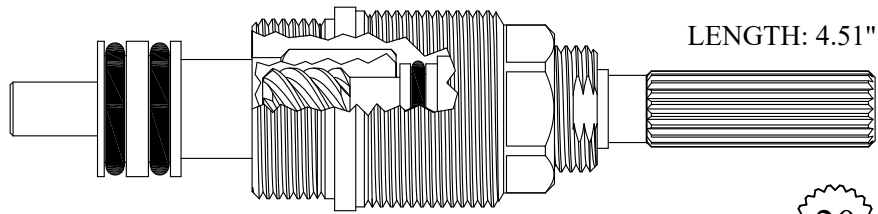

LENGTH: 4.51"

432071

GASKET INCLUDED: 895320

20

3-24

FOR REID WATSON

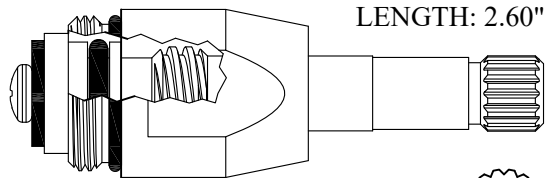

LENGTH: 2.60"

GASKET: 890170 O-RING INCLUDED

LF464501/ LF464502

16

1-5

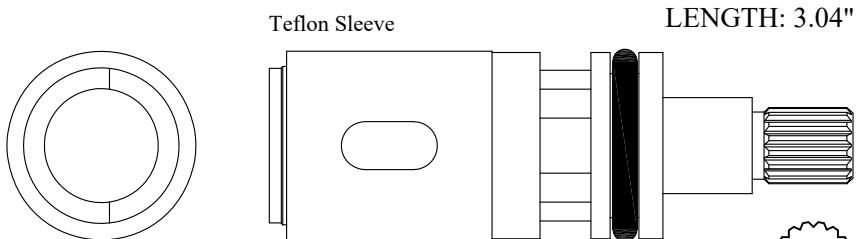

Teflon Sleeve

LENGTH: 3.04"

230470

16

1-5

FOR REID WATSON

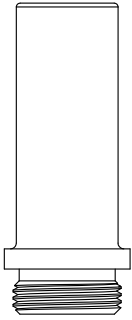

SEAT USED: LF649410

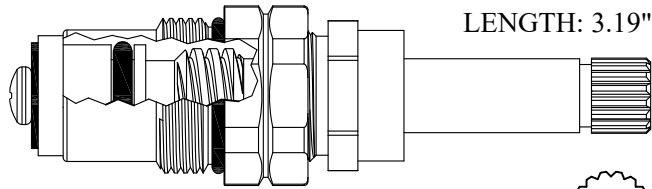

LENGTH: 3.19"

LF466701/ LF466702

GASKET: 890170 O-RING INCLUDED

16

1-5

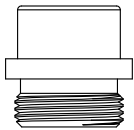

SEAT USED: 649300

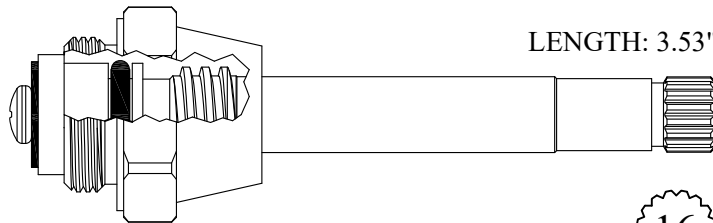

LENGTH: 3.53"

402921/ 402922

GASKET INCLUDED: 895150

16

1-5

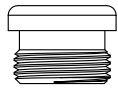

SEAT USED: LF648560

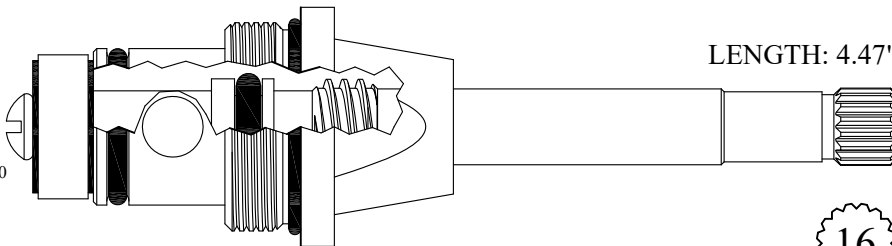

LENGTH: 4.47"

430531

GASKET: 890220 O-RING INCLUDED

16

1-5



SEAT USED: LF648130

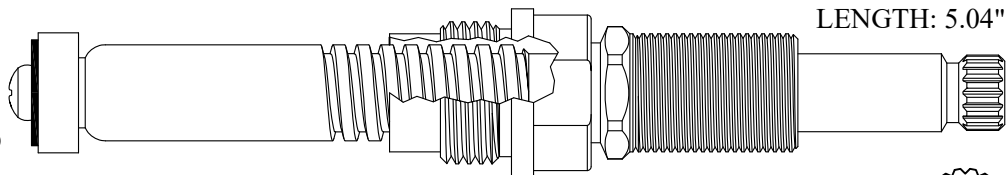

LENGTH: 5.04"

LF478711/ LF478712

GASKET INCLUDED: 895100

16

1-5

FOR RICHMOND RHEEM

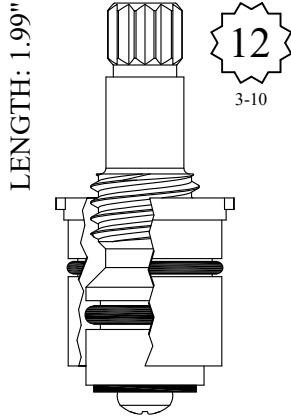

LF458131
LF458132

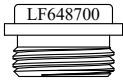

SEAT USED: LF648700 or LF647620

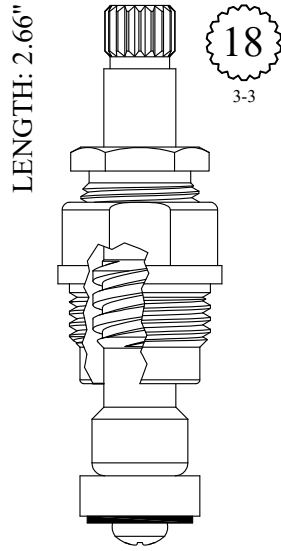
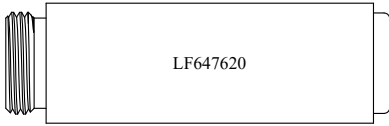

GASKET INCLUDED: 895100

LF465081
LF465082

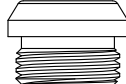

SEAT USED: LF648130

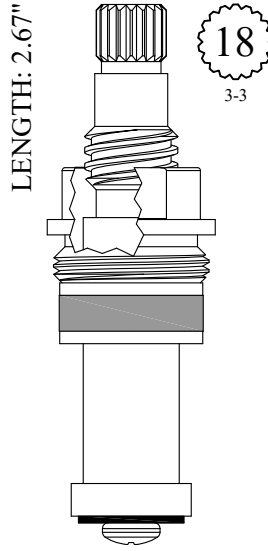

LF465111
LF465112

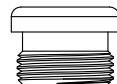

SEAT USED: LF648560

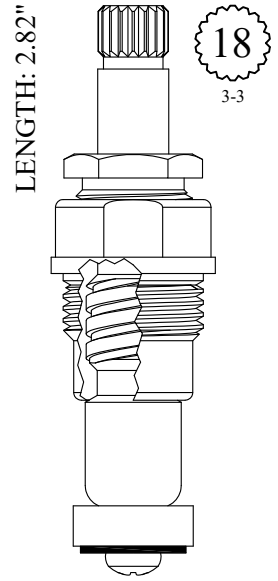

GASKET INCLUDED: 895100

LF465191
OEM # 02-A17 RH
LF465192
OEM # A17 LH



SEAT USED: LF648130

FOR ROBERTS BRASS

Chrome Plated Stem & Pkg Nut

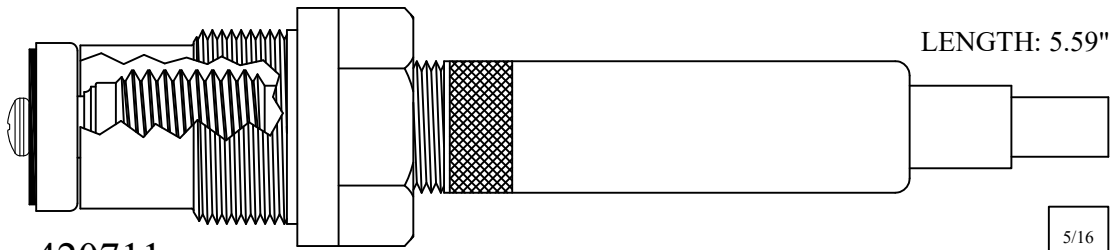

420711

GASKET INCLUDED: 895450

220711 Stem Only

Chrome Plated Stem & Pkg Nut

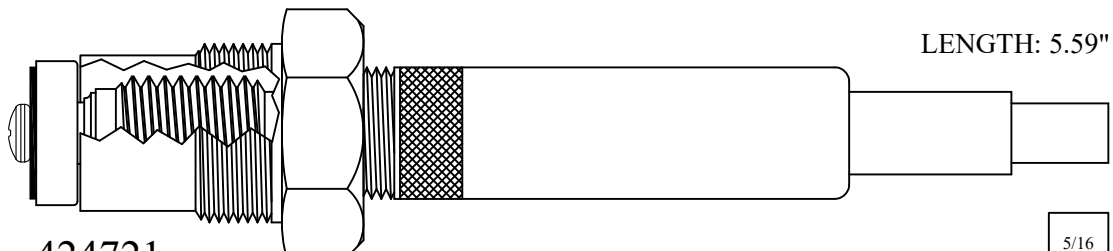

424721

GASKET INCLUDED: 895320

224721 Stem Only

FOR RODAC

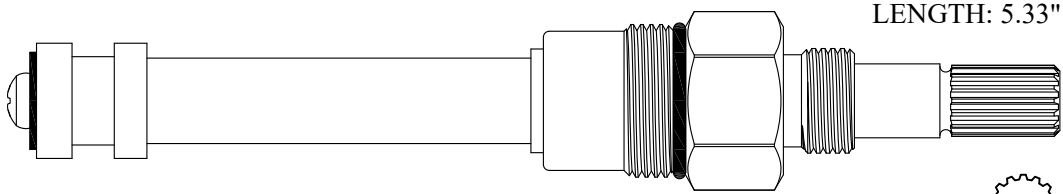

LENGTH: 5.33"

LF479801/ LF479802

GASKET: 890170 O-RING INCLUDED

16

3-16

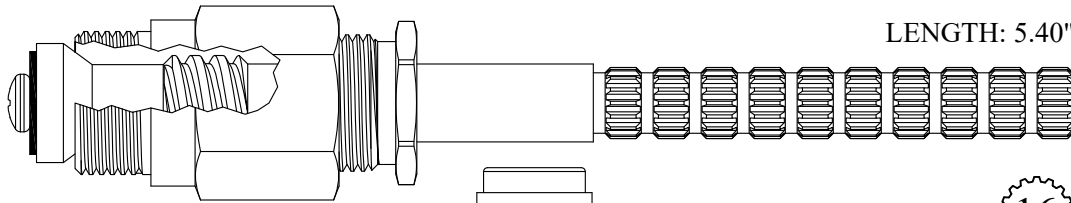

LENGTH: 5.40"

410991/ 410992

GASKET INCLUDED: 895100

SEAT USED: LF648550

16

3-16

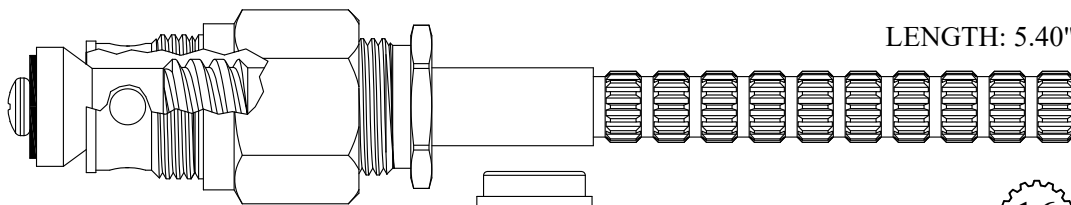

LENGTH: 5.40"

431931

GASKET INCLUDED: 895100

SEAT USED: LF648550

16

3-16

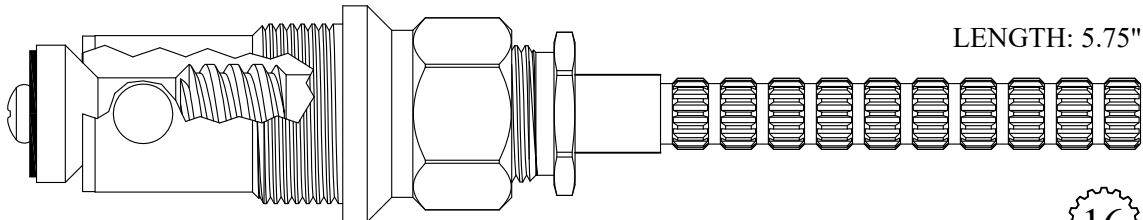

LENGTH: 5.75"

436151

GASKET INCLUDED: 895370

236151 Stem Only

SEAT USED: 648970

16

3-16

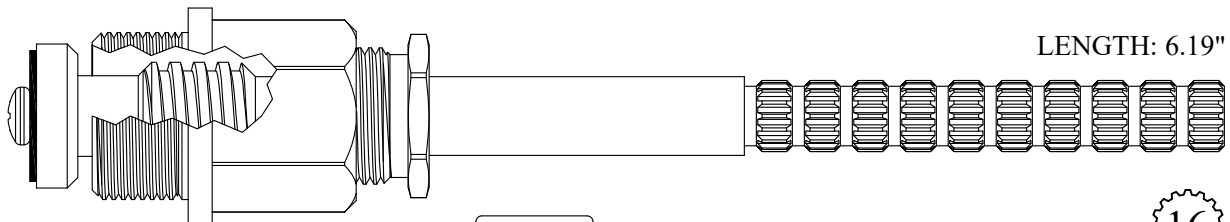

LENGTH: 6.19"

421711/ 421712

GASKET INCLUDED: 895400

221711/ 221712 Stem Only

SEAT USED: 648970

16

3-16

FOR ROHL

New Style - Manual

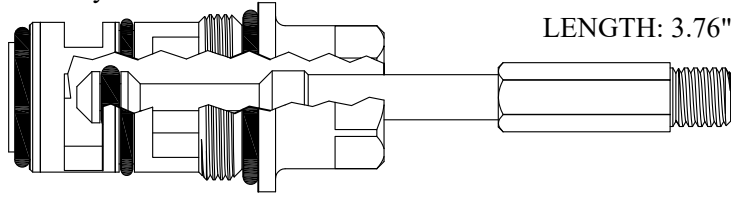

LENGTH: 3.76"

430850

GASKET: 894120 O-RING INCLUDED
OEM # 3104-0800

Old Style - Automatic with Brass Link

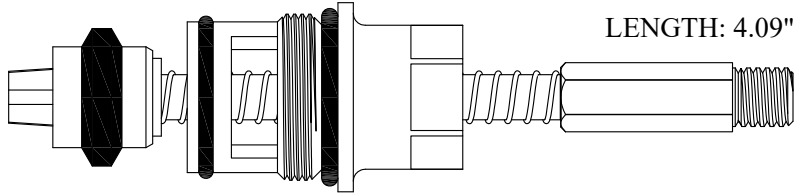

LENGTH: 4.09"

431130

GASKET: 894120 O-RING INCLUDED

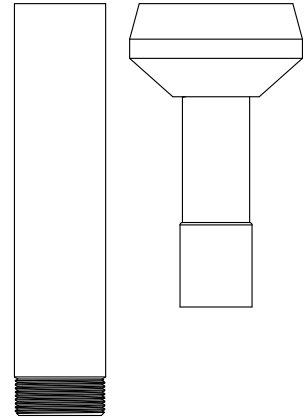

Chrome plated handle
& sleeve available

128540

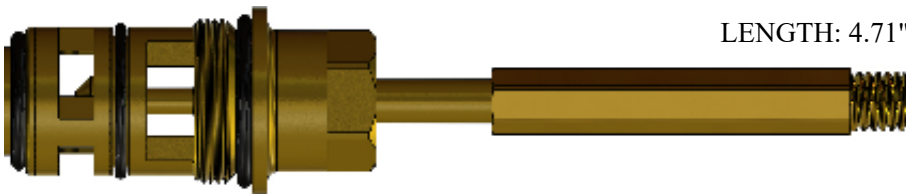

LENGTH: 4.71"

432850

GASKET: 894120 O-RING INCLUDED

THREAD
M8 X 1.25

FOR ROSS & GADE

Chrome Plated Stem

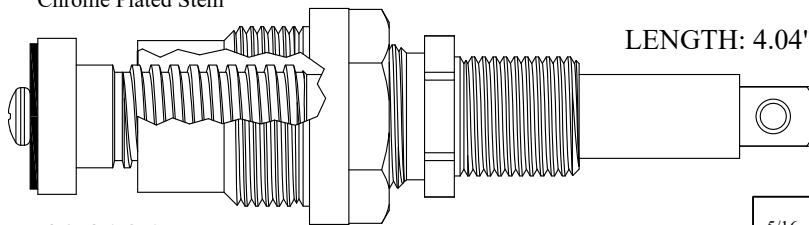

LENGTH: 4.04"

404131

GASKET INCLUDED: 895320

204131 Stem Only

5/16

Chrome Plated Stem

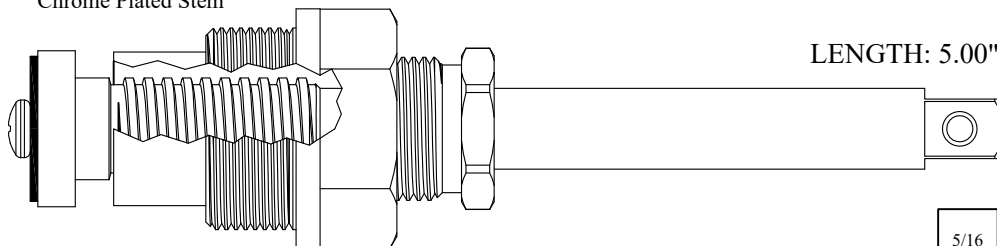

LENGTH: 5.00"

412241

GASKET INCLUDED: 895430

212241 Stem Only

5/16

FOR ROYAL BRASS

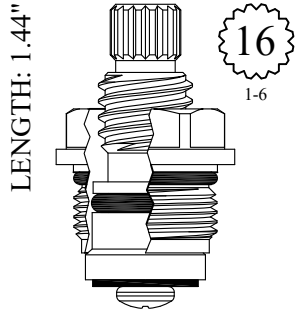

GASKET: 890160 O-RING INCLUDED

LF451131
OEM # U-185-R
LF451132
OEM # U-185-L

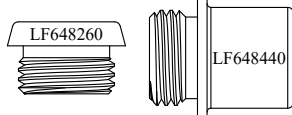

SEAT USED: LF648260 or LF648440

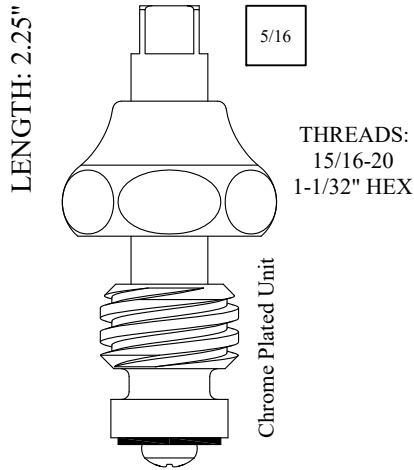

LF461831
LF461832
LF261831 Stem Only
LF261832 Stem Only

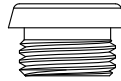

SEAT USED: LF648260

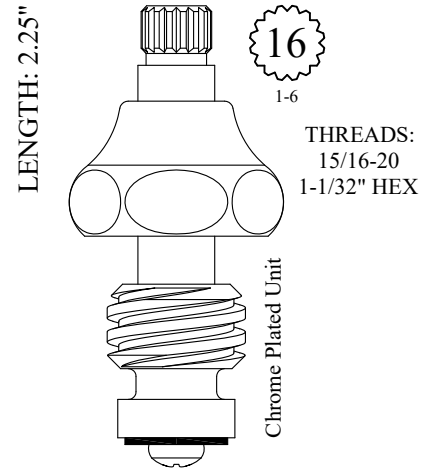

LF461841
LF461842
LF261841 Stem Only
LF261842 Stem Only
OEM # U-651-R
OEM # U-651-L

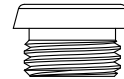

SEAT USED: LF648260

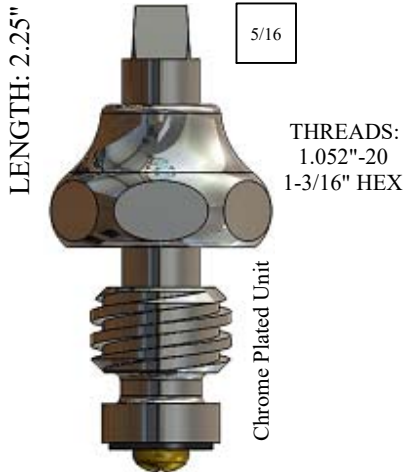

LF461881
LF461882
LF261831 Stem Only
LF261832 Stem Only

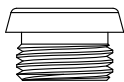

SEAT USED: LF648260



LF461891
LF461892
LF261841 Stem Only
LF261842 Stem Only



SEAT USED: LF648260

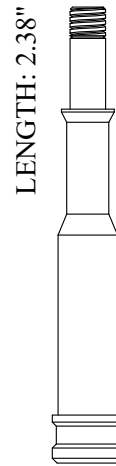

LF115960

FOR ROYAL BRASS

LENGTH: 2.40"

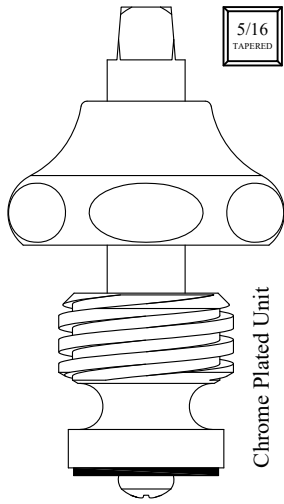

Chrome Plated Unit

LF463221
 LF463222
 LF263221 Stem Only
 LF263222 Stem Only

LENGTH: 2.40"

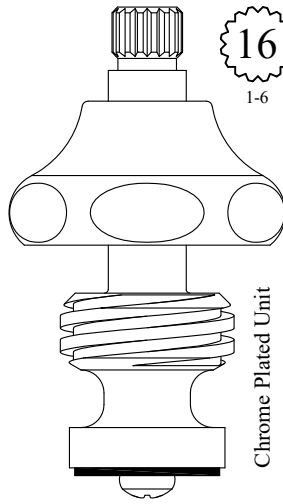

Chrome Plated Unit

LF463251
 LF463252
 LF263251 Stem Only
 OEM # U667R
 LF263252 Stem Only
 OEM # U667L

LENGTH: 2.55"

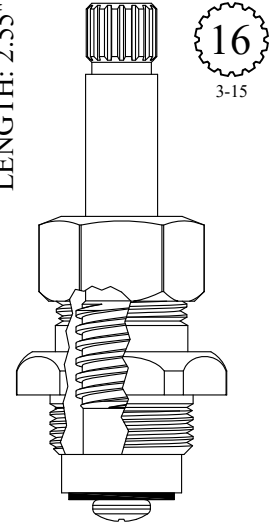

GASKET INCLUDED: 895100

LF463861
 OEM # U-2092

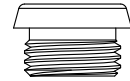

SEAT USED: LF648260

LENGTH: 2.60"

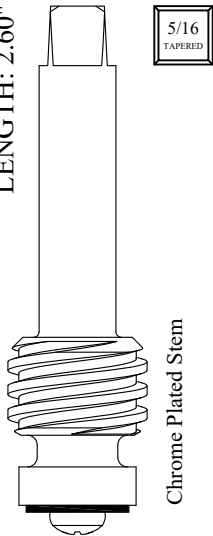

Chrome Plated Stem

LF264411
 LF264412



SEAT USED: LF648260

LENGTH: 2.60"

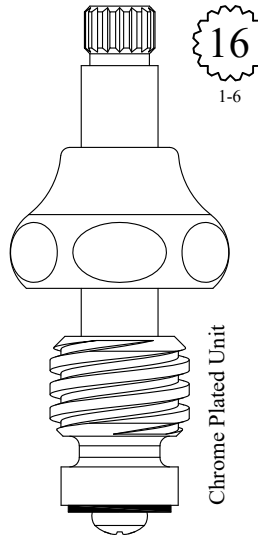

Chrome Plated Unit

LF464401
 LF464402
 LF264401 Stem Only
 OEM # U-652-R
 LF264402 Stem Only
 OEM # U-652-L

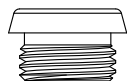

SEAT USED: LF648260

LENGTH: 2.63"

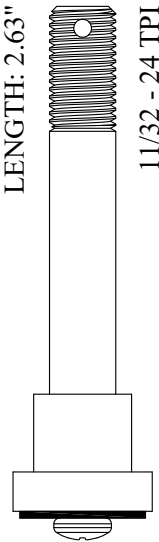

11/32 - 24 TPI

LF264700
 OEM # U-663

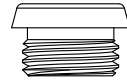

SEAT USED: LF648260

FOR ROYAL BRASS

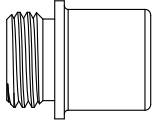

SEAT USED: LF648440



LENGTH: 3.93"

403441

GASKET INCLUDED: 895100

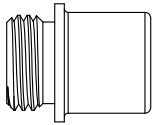

SEAT USED: LF648440

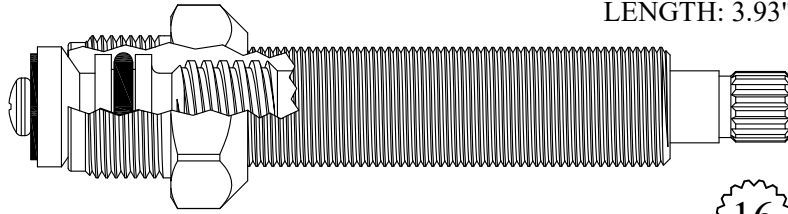

LENGTH: 3.93"

403621

GASKET INCLUDED: 895100

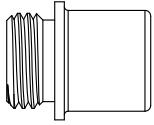

SEAT USED: LF648440

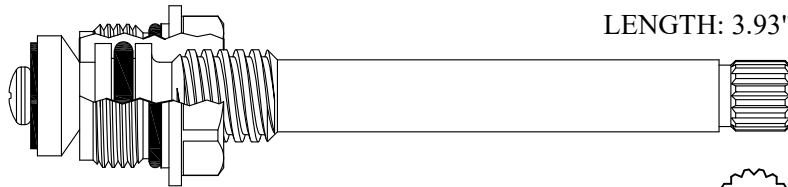

LENGTH: 3.93"

403521

GASKET: 890160 O-RING INCLUDED
OEM # U-275R

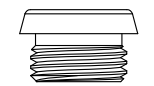

SEAT USED: LF648260

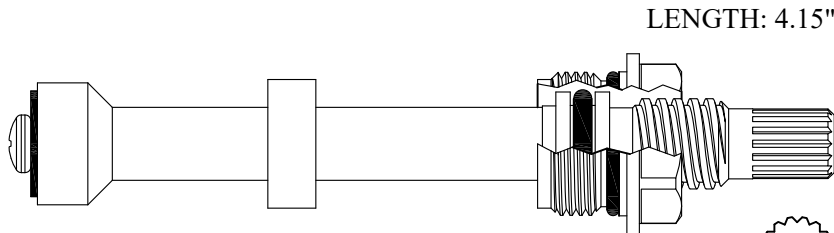

LENGTH: 4.15"

LF470301/ LF470302

GASKET: 890160 O-RING INCLUDED
OEM # U2097R/ U2097L



FOR ROYAL BRASS

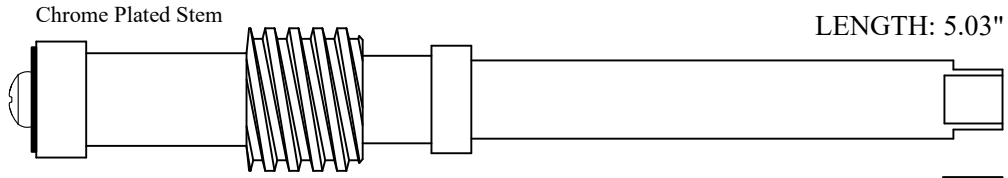

LF279011

5/16

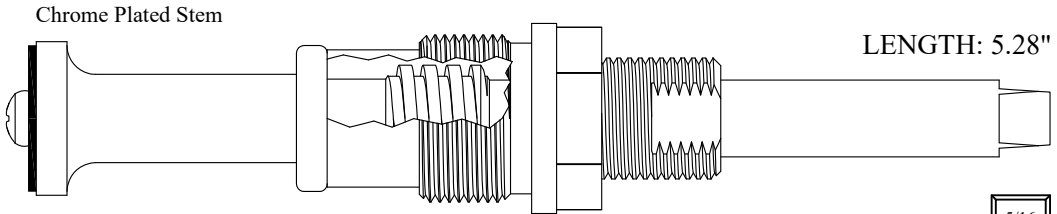

LF479901

LF279901 Stem Only

5/16
TAPERED

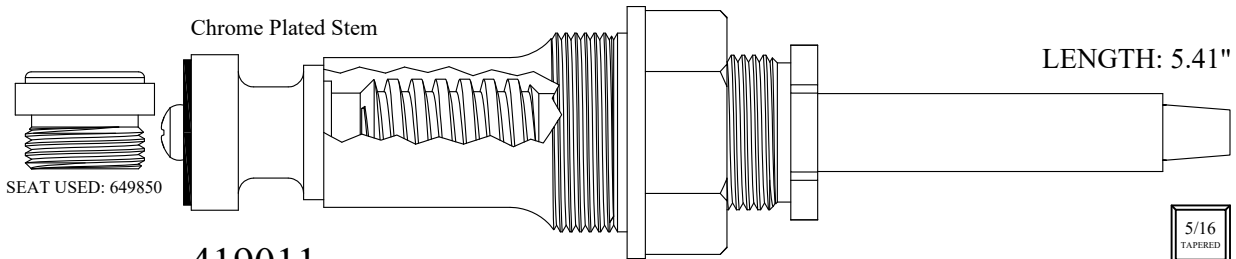

419011

GASKET INCLUDED: 895560

OEM # U678SQ-4019

219011 Stem Only

OEM # U-678

5/16
TAPERED

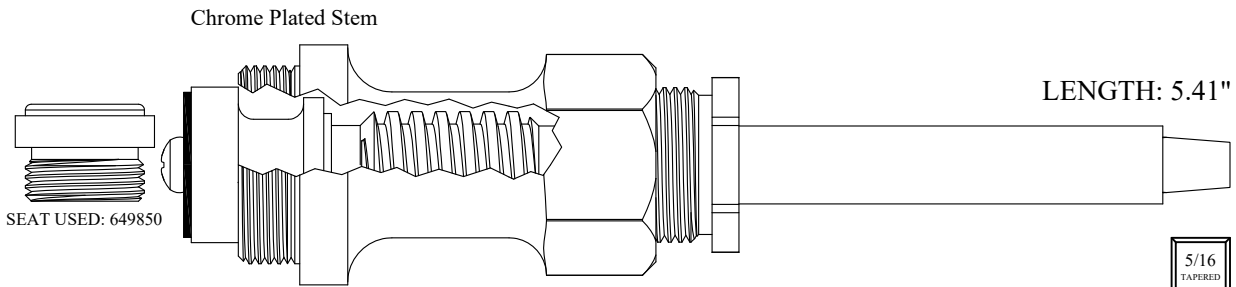

419021

219011 Stem Only

GASKET: 895560

OEM # U678SQ-5054

OEM # U-678

5/16
TAPERED

FOR ROYAL BRASS

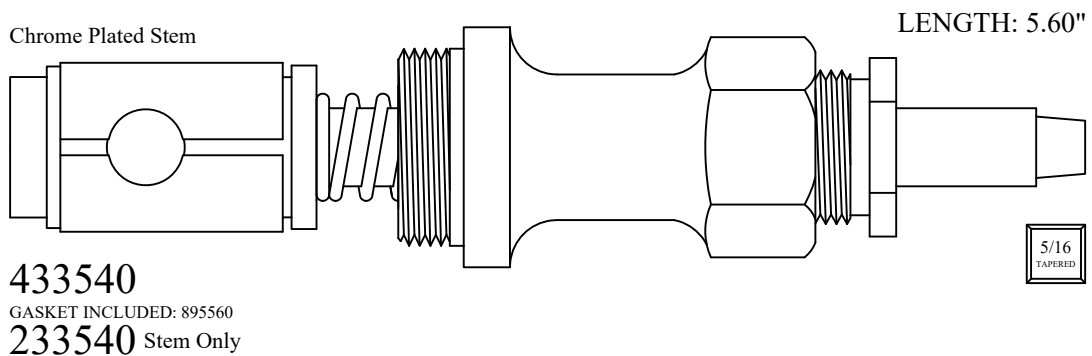
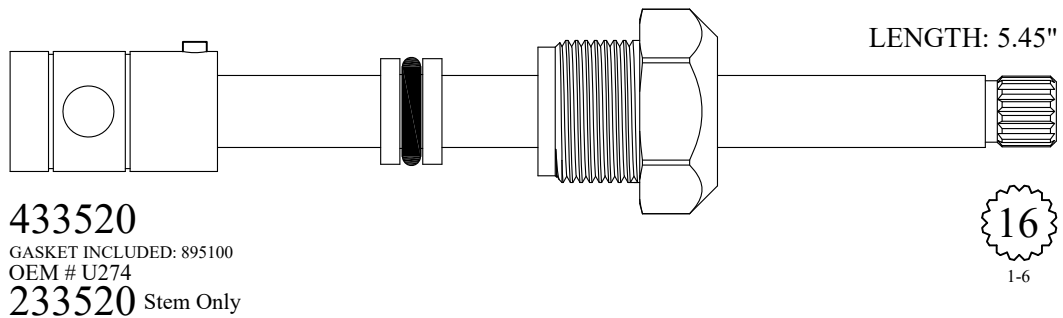
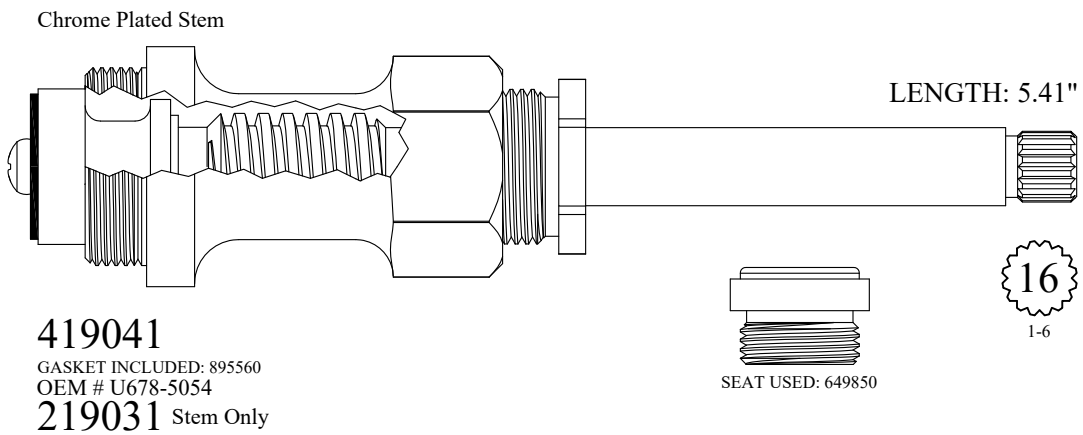
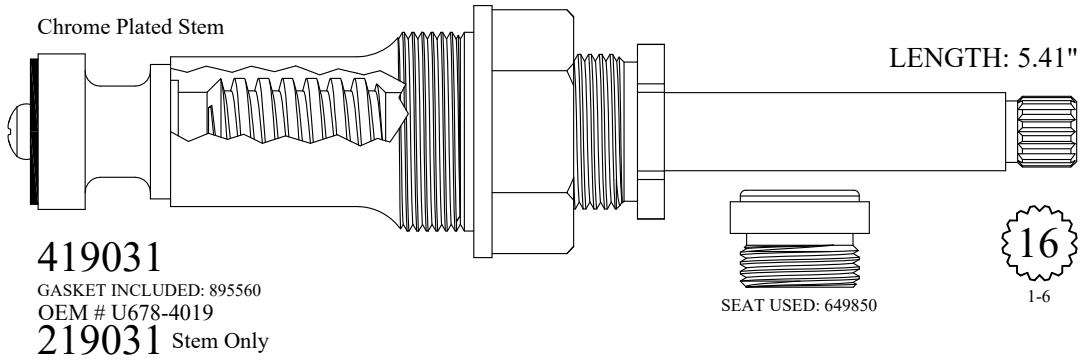

FOR ROYAL BRASS

Chrome Plated Stem

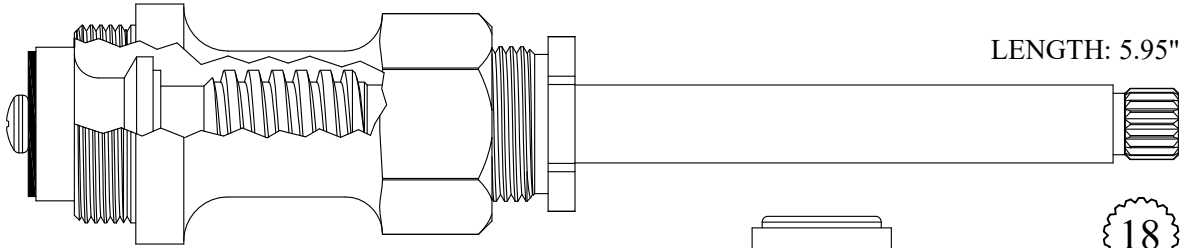

LENGTH: 5.95"

426001

GASKET INCLUDED: 895560

226001 Stem Only

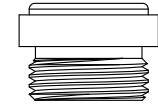

SEAT USED: 649850

18

3-3

Chrome Plated Stem

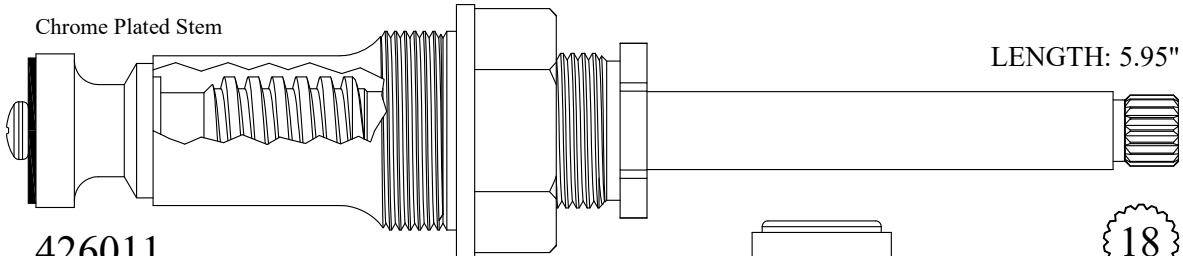

LENGTH: 5.95"

426011

GASKET INCLUDED: 895560

OEM # U678-4019LG

226001 Stem Only

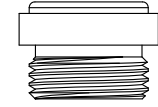

SEAT USED: 649850

18

3-3

Chrome Plated Stem

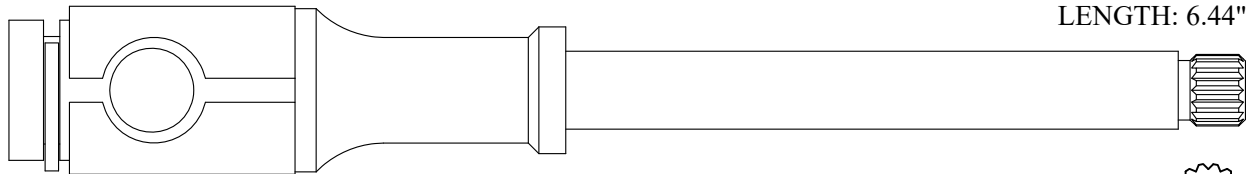

LENGTH: 6.44"

239420

16

1-6

Chrome Plated Stem

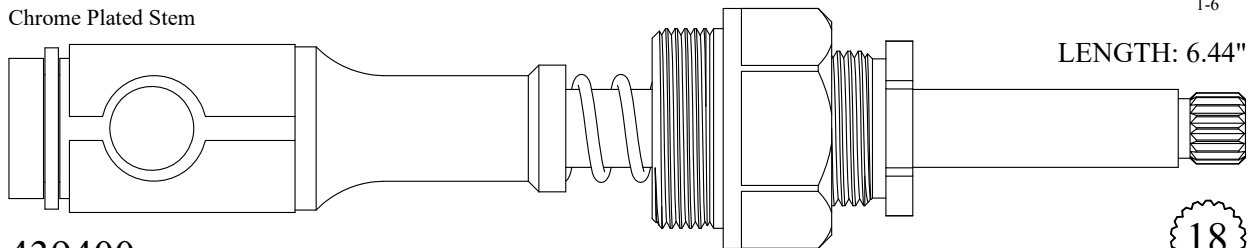

LENGTH: 6.44"

439400

GASKET INCLUDED: 895560

239400 Stem Only

18

3-3

Chrome Plated Stem

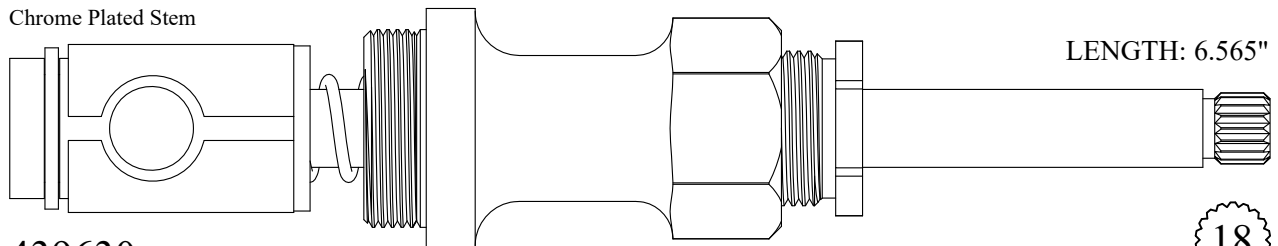

LENGTH: 6.565"

439630

GASKET INCLUDED: 895560

OEM # ROYU-099

239630 Stem Only

18

3-3

FOR RUGO

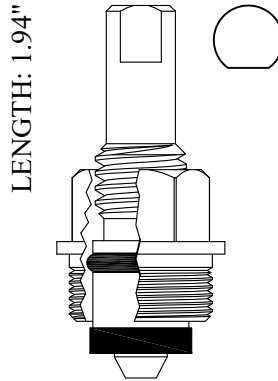

GASKET: 895100

LF458301

FOR SAVOY

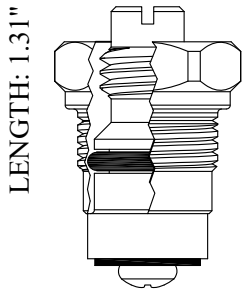

GASKET INCLUDED: 895100

400291

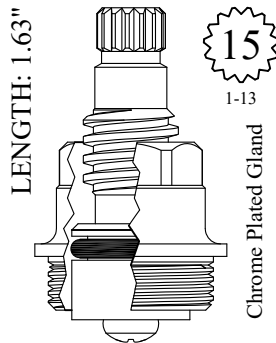

GASKET INCLUDED: 895150

LF452201
OEM # A-68
LF452202
OEM # 02-A68



SEAT USED: LF649740

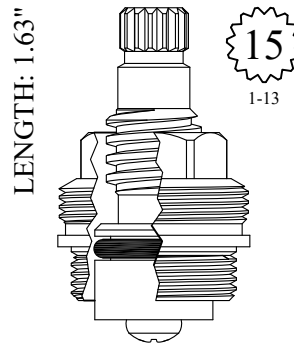

GASKET INCLUDED: 895150

LF452211
OEM # A-69
LF452212



SEAT USED: LF649740

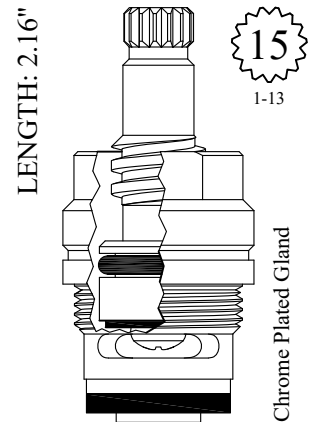

SEAT INCLUDED: LF648850

GASKET INCLUDED: 895150

LF459631
OEM # 02-A-55 R
LF459632
OEM # 02-A-55 L

Also available with Monel Seat
SEAT USED: LF648850-M

LF459631-M
LF459632-M

FOR SAVOY

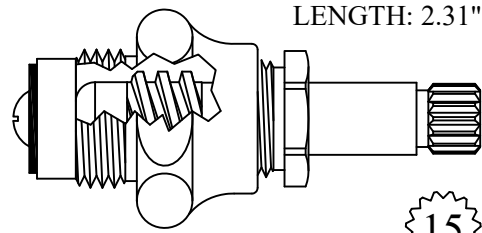

LF462121
GASKET INCLUDED: 895100
OEM # A-16

15
1-13

Chrome Plated Unit

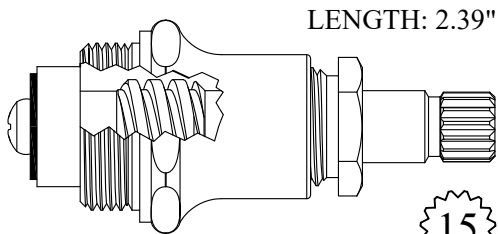

LF462081/ LF462082
GASKET INCLUDED: 895400
OEM # A-8/ 02-A8 LH (A-8)

15
1-13

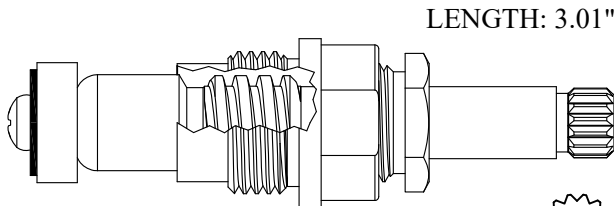

LF465211/ LF465212
GASKET INCLUDED: 895100
OEM # A-9

15
1-13

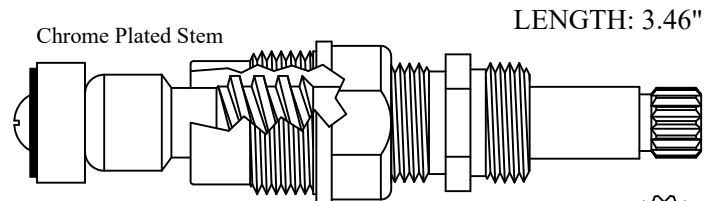

LF468051/ LF468052
GASKET INCLUDED: 895100
OEM # A-21 RH/ A-21 LH

15
1-13

FOR SAVOY

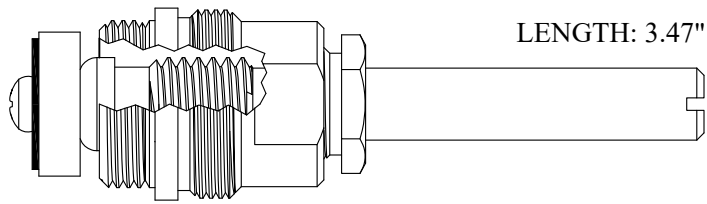

402831

GASKET INCLUDED: 895400
OEM # 02-A60 (A-60)

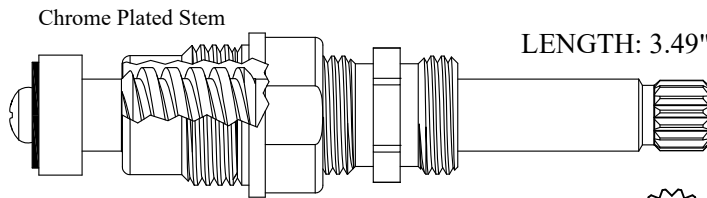
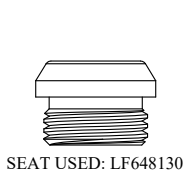

LF468021/ LF468022

GASKET INCLUDED: 895100
OEM # 02-A-12 R/ 02-A-12 L

15
1-13

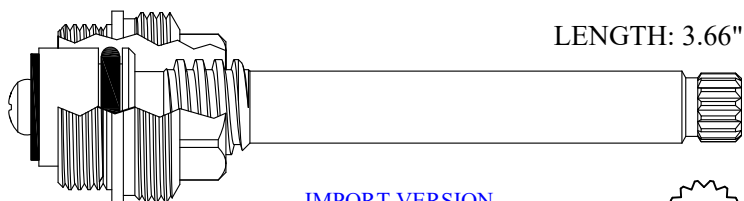
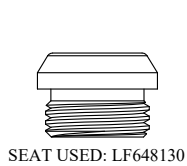

403321

GASKET INCLUDED: 895400
OEM # 02-A70

IMPORT VERSION
SV21970

15
1-13

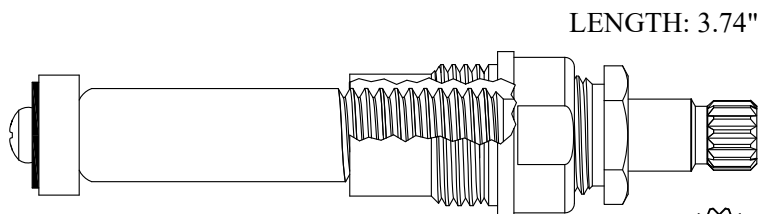

LF468801/ LF468802

GASKET INCLUDED: 895100
OEM # A48

15
1-13

FOR SAVOY

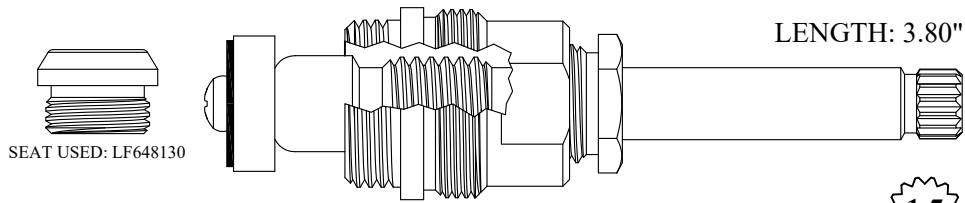

403411
GASKET INCLUDED: 895400
OEM # A-40
203411 Stem Only

15
1-13

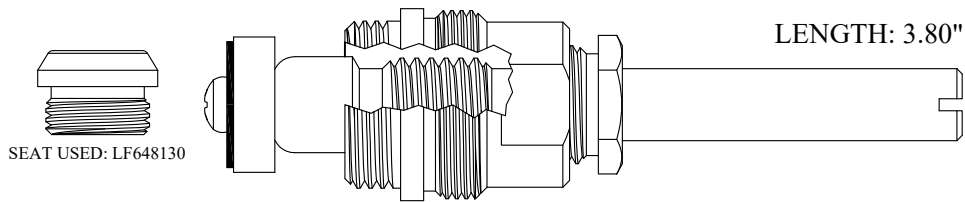

403561
GASKET INCLUDED: 895400

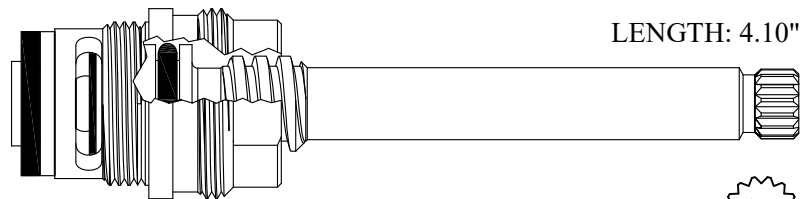

403341
GASKET INCLUDED: 895400

Also available with Monel Seat
SEAT INCLUDED: 648850-M

403341-M

15
1-13

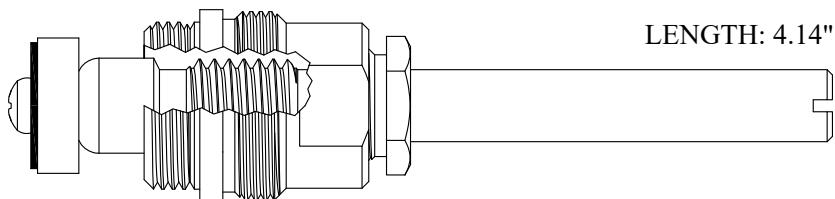

405521
GASKET INCLUDED: 895400

FOR SAVOY

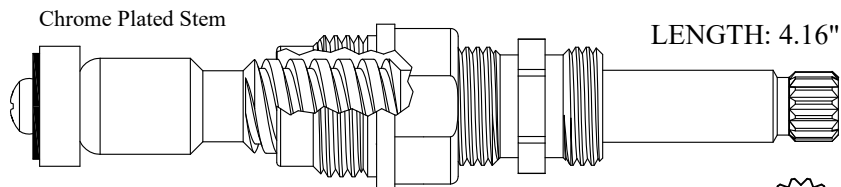
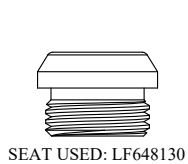

LF469011/ LF469012

GASKET INCLUDED: 895100

OEM # A-22

LF269011/ LF269012 Stem Only



1-13

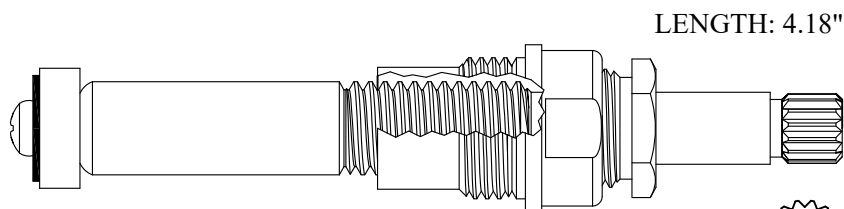

LF471231/ LF471232

GASKET INCLUDED: 895100

OEM # 02-A48 R/ 02-A48 LH

LF271231/ LF271232 Stem Only



1-13

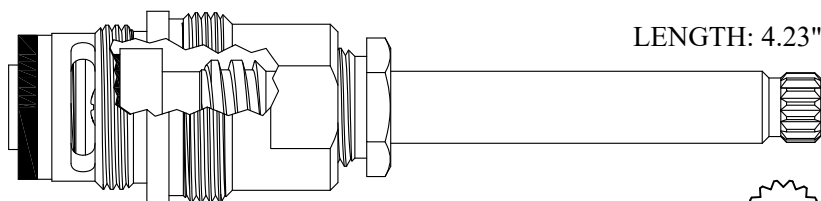

SEAT INCLUDED: LF648850

403311

GASKET INCLUDED: 895400

OEM # 02-A56

Also available with Monel Seat

SEAT INCLUDED: LF648850-M

403311-M

GASKET INCLUDED: 895400



1-13

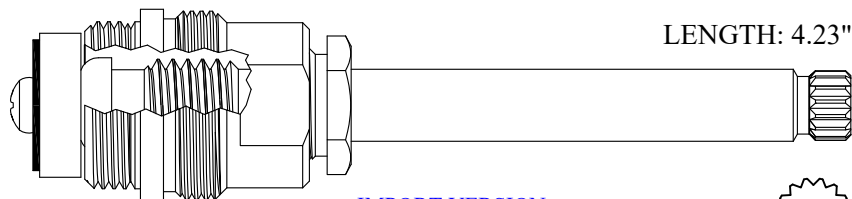

405631

GASKET INCLUDED: 895400

OEM # 02-A59

205631 Stem Only

IMPORT VERSION
SV21962



1-13

FOR SAVOY

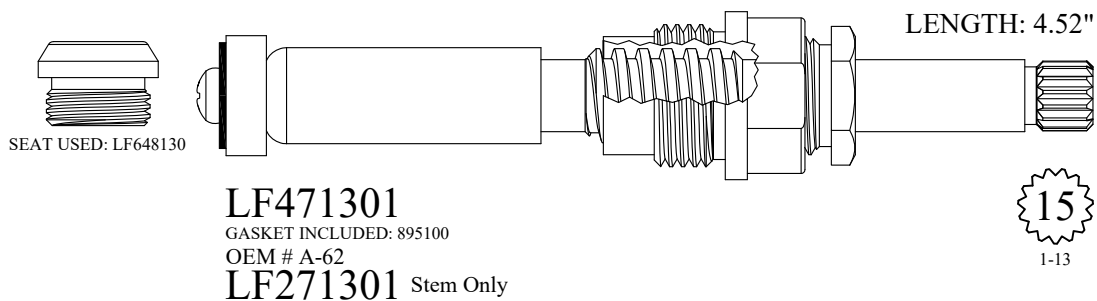
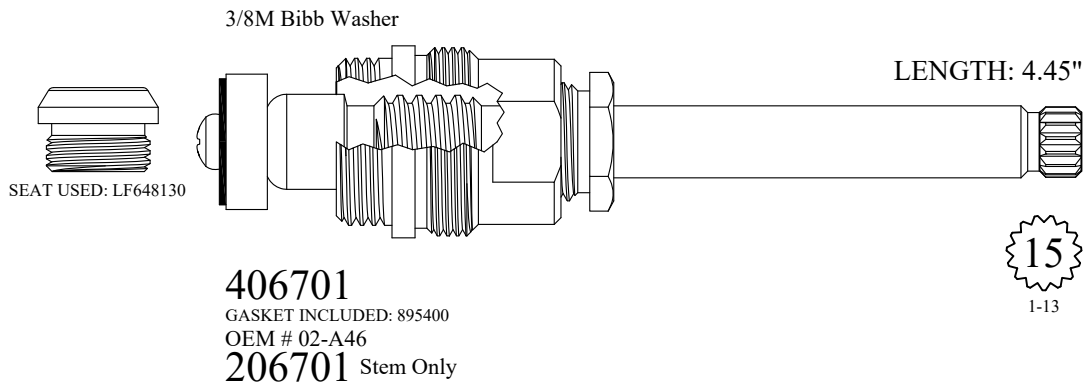
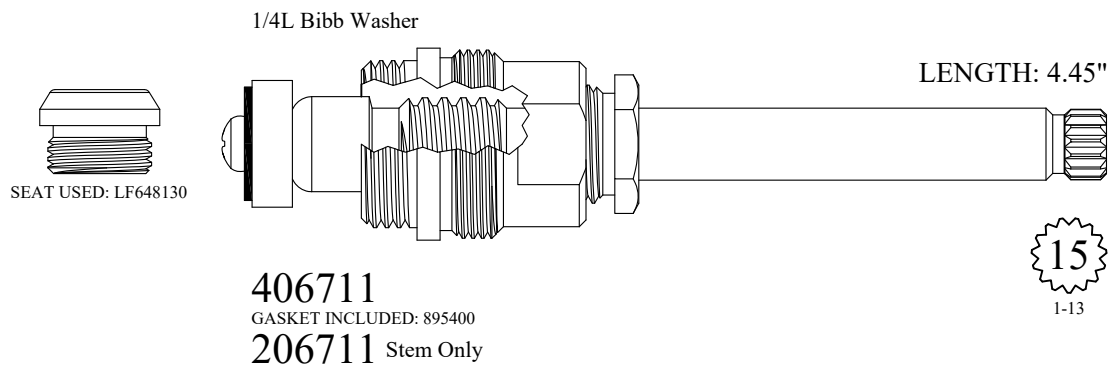
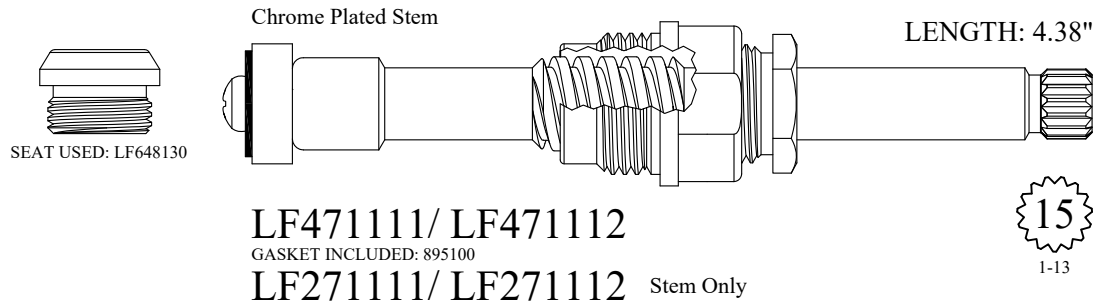

FOR SAVOY

Chrome Plated Stem

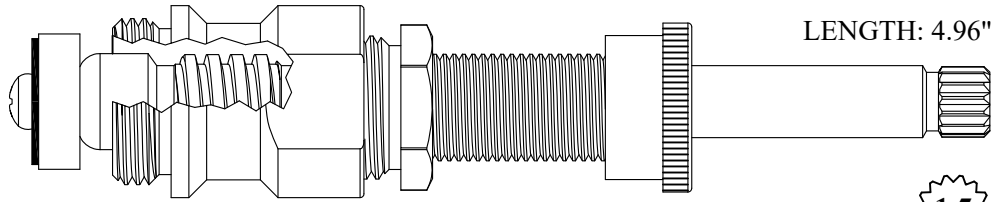

412711

GASKET INCLUDED: 895400

212801 Stem Only

OEM # 22



Chrome Plated Stem

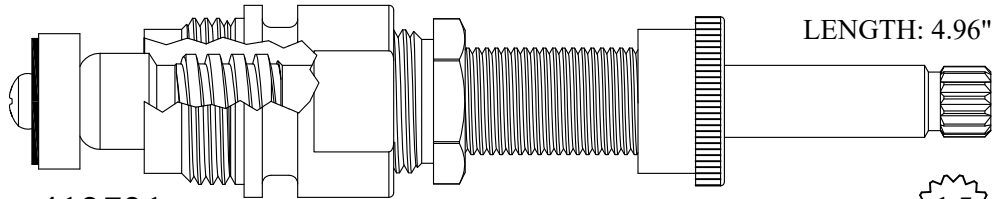

412721

GASKET INCLUDED: 895400

212801 Stem Only

OEM # 22



Chrome Plated Stem

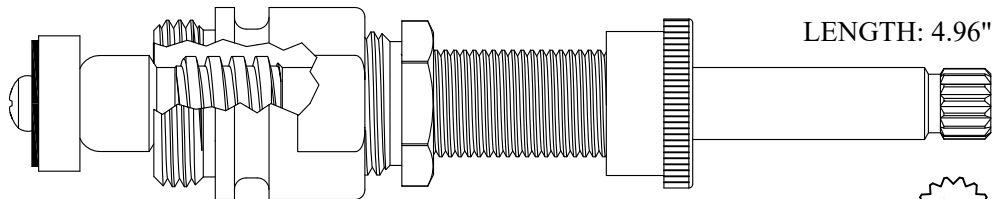

412731

GASKET INCLUDED: 895400

212801 Stem Only

OEM # 22



Chrome Plated Stem & Esc Tube

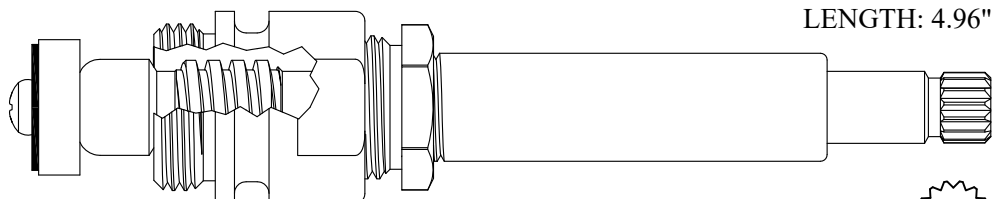

412741

GASKET INCLUDED: 895400

212801 Stem Only

OEM # 22

IMPORT VERSION
SV21961



Chrome Plated Stem & Esc Tube

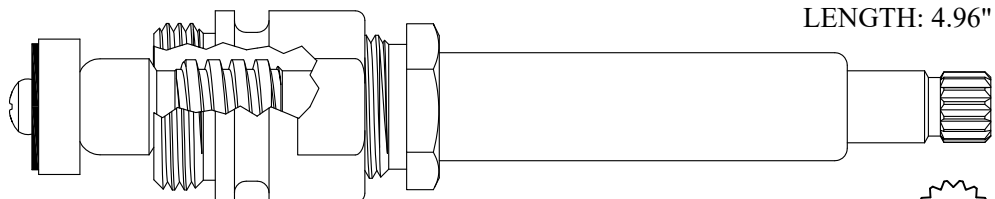

412801

GASKET INCLUDED: 895400

OEM # 02-A1

212801 Stem Only

OEM # 22



FOR SAVOY

Chrome Plated Stem & Esc Tube

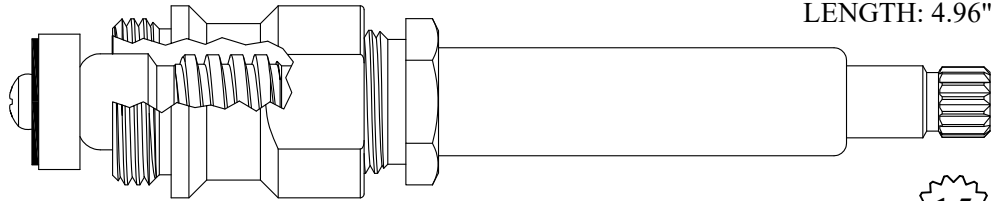

412821
GASKET: 895400
OEM # 02-A2
212801 Stem Only

15
1-13

Chrome Plated Stem

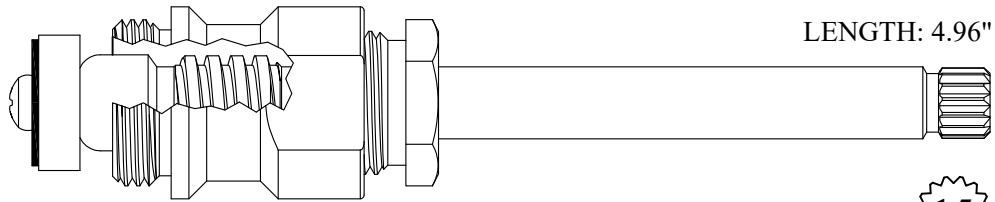

412821-LT
GASKET: 895400
212801 Stem Only

15
1-13

Chrome Plated Stem & Esc Tube

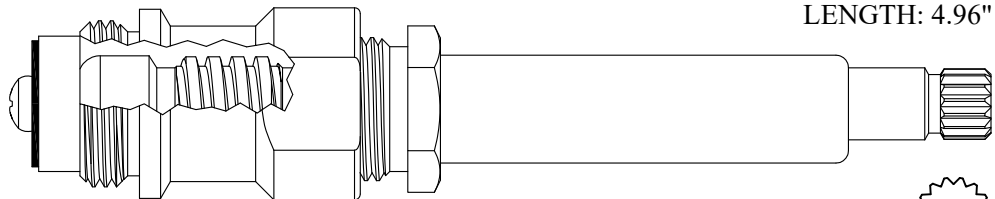

412831
GASKET: 895400
212801 Stem Only

15
1-13

Chrome Plated Stem & Esc Tube
5/8 Retainer

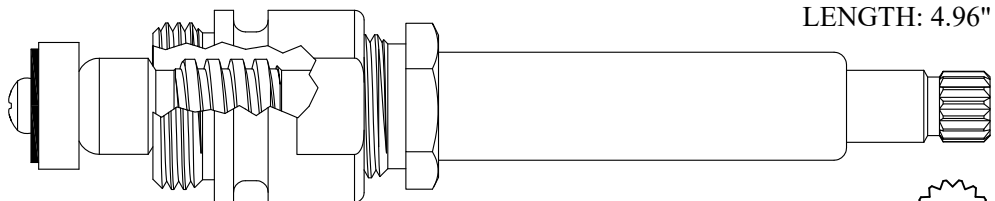

412841
GASKET: 895400
212841 Stem Only

15
1-13

FOR SAVOY

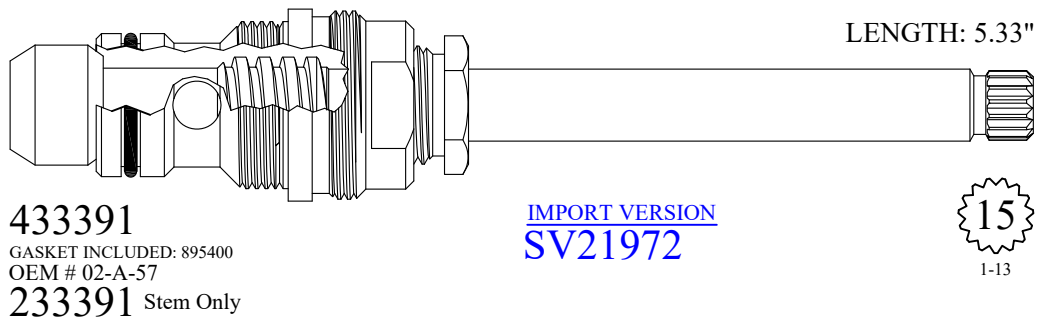
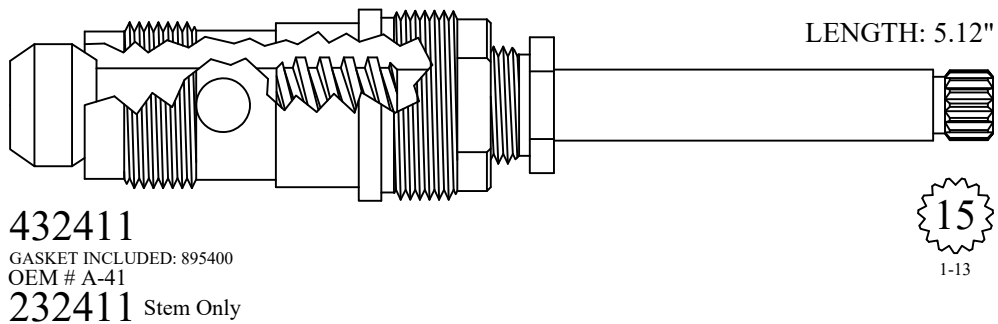
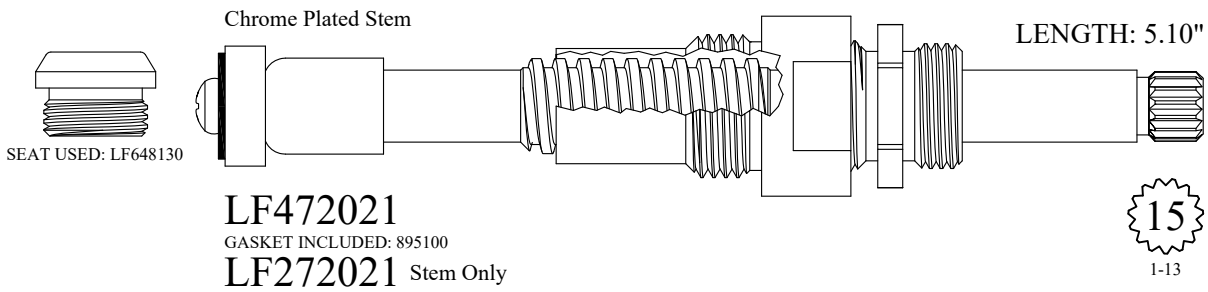
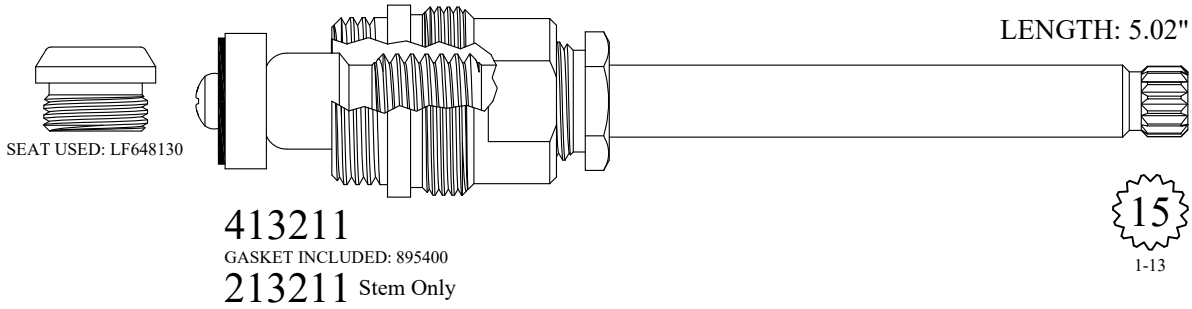

FOR SAVOY

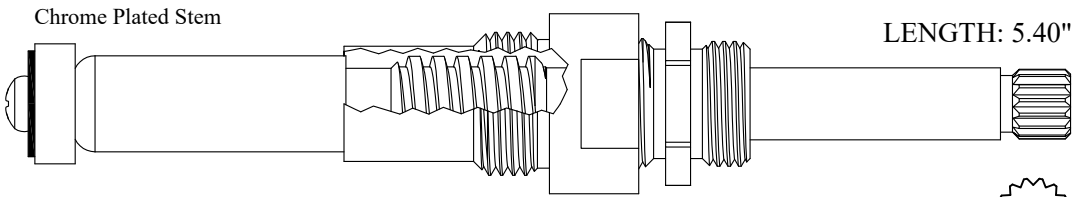

LF473011

GASKET INCLUDED: 895100
OEM # A-10

LF273011 Stem Only



15

1-13

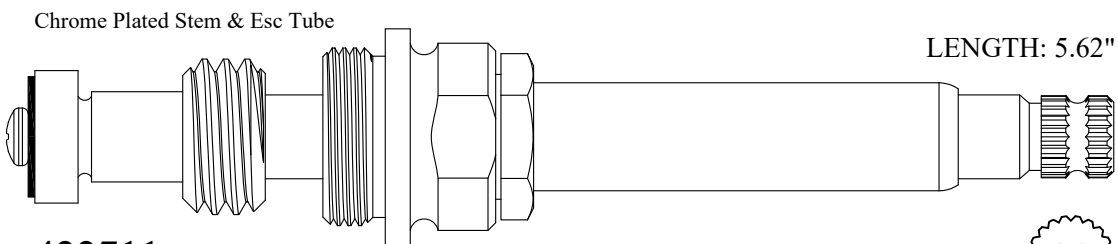

422711

GASKET INCLUDED: 895320
OEM # A-25

222711 Stem Only

OEM # 450

20

2-4

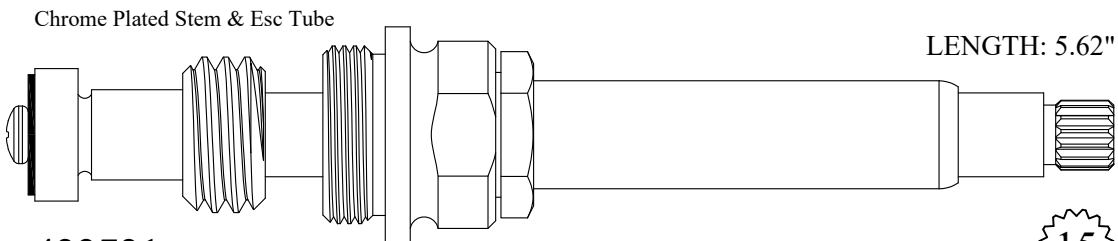

422721

GASKET INCLUDED: 895320

222721 Stem Only

15

1-13

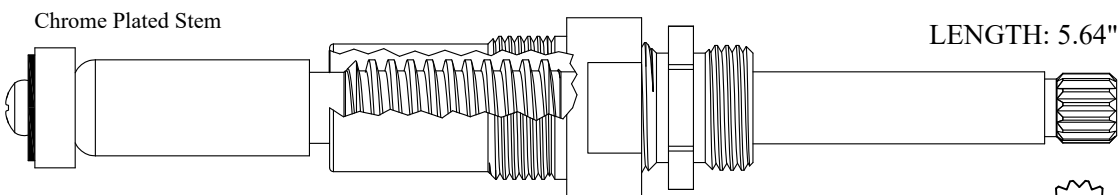

LF480351

GASKET INCLUDED: 895100

LF280351 Stem Only



15

1-13

FOR SAVOY

Chrome Plated Stem & Esc Tube

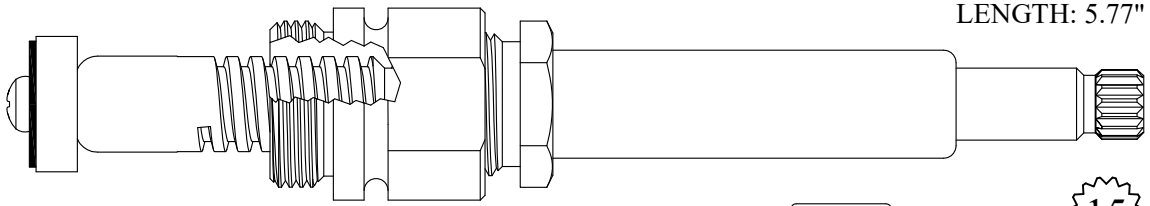

LENGTH: 5.77"

423211

GASKET INCLUDED: 895400

223411 Stem Only

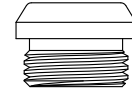

SEAT USED: LF648130

15

1-13

Chrome Plated Stem & Esc Tube

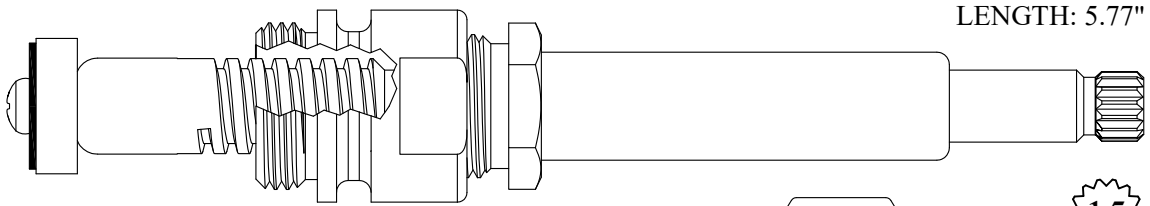

LENGTH: 5.77"

423411

GASKET INCLUDED: 895400

OEM # A-24

223411 Stem Only

IMPORT VERSION
SV21968

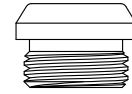

SEAT USED: LF648130

15

1-13

Chrome Plated Stem

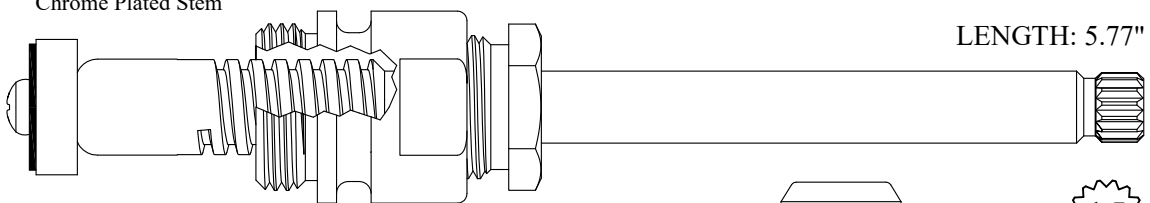

LENGTH: 5.77"

423411-LT

GASKET INCLUDED: 895400

223411 Stem Only

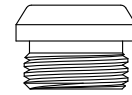

SEAT USED: LF648130

15

1-13

Chrome Plated Stem & Esc Tube

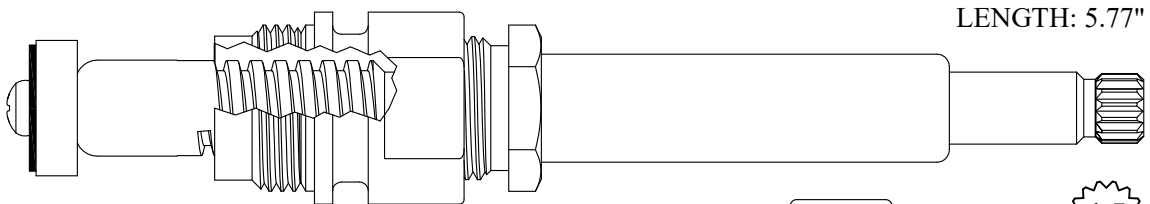

LENGTH: 5.77"

423511

GASKET INCLUDED: 895400

223411 Stem Only

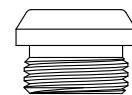

SEAT USED: LF648130

15

1-13

FOR SAVOY

Chrome Plated Stem & Esc Holder

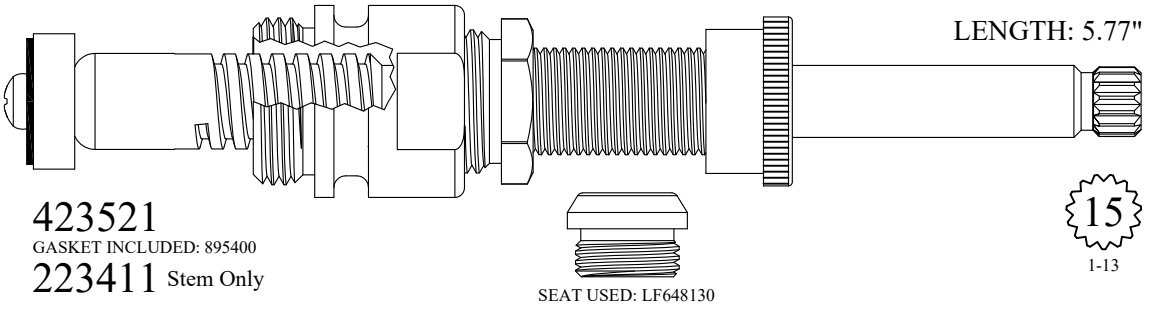

Chrome Plated Stem & Esc Tube

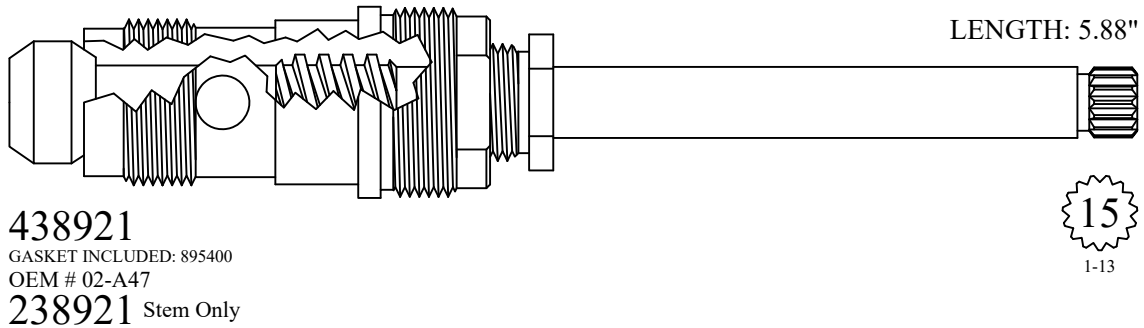
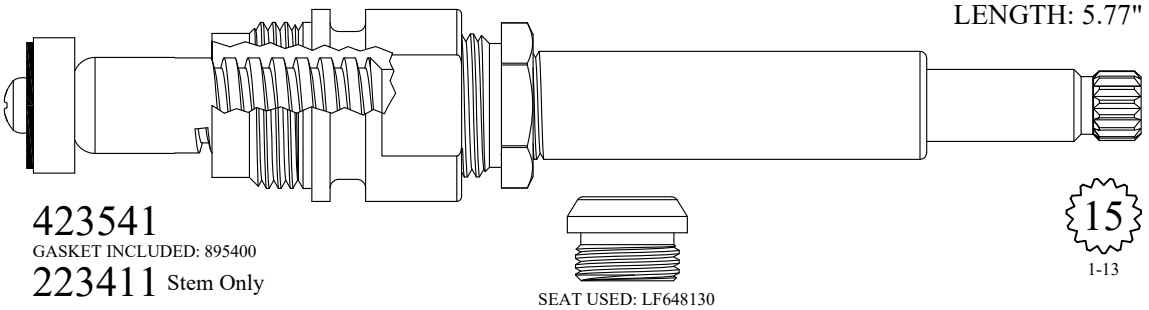

Chrome Plated Stem



FOR SAVOY

Chrome Plated Stem & Esc Tube

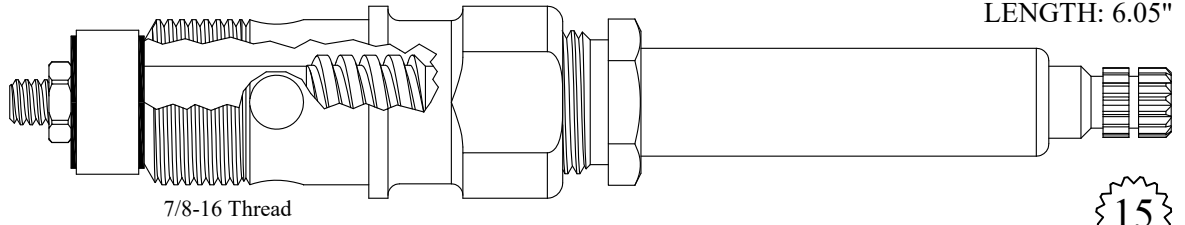

438931

GASKET INCLUDED: 895400

238931 Stem Only

15
1-13

Chrome Plated Stem & Esc Tube

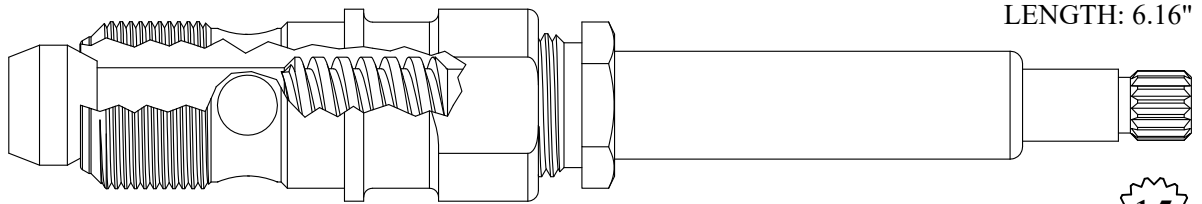

438911

GASKET INCLUDED: 895400

OEM # A-7

238911 Stem Only

15
1-13

Chrome Plated Stem & Esc Tube

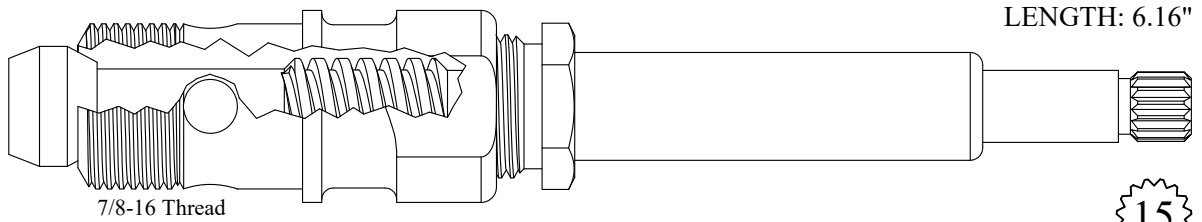

438941

GASKET INCLUDED: 895400

238911 Stem Only

15
1-13

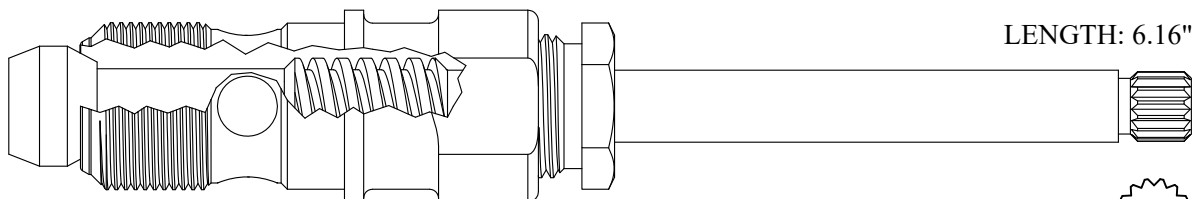

438951

GASKET INCLUDED: 895400

238951 Stem Only

15
1-13

FOR SAVOY



LENGTH: 6.24"

426741

GASKET INCLUDED: 895400

226741 Stem Only

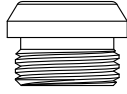

SEAT USED: LF648130

15

1-13

Chrome Plated Stem

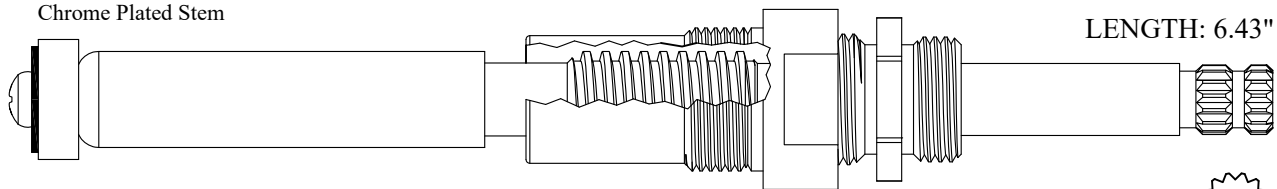

LENGTH: 6.43"

LF480561

GASKET INCLUDED: 895100

OEM # A-19

LF280561 Stem Only

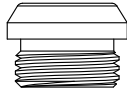

SEAT USED: LF648130

15

1-13

Chrome Plated Stem & Esc Tube

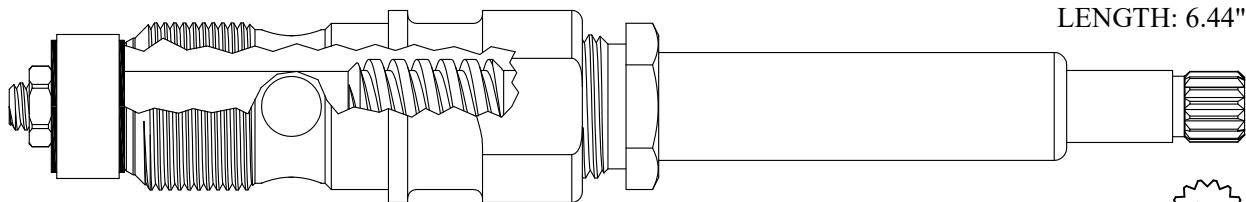

LENGTH: 6.44"

7/8-20 Thread

438901

GASKET INCLUDED: 895400

OEM # A-7K

238901 Stem Only

15

1-13

Chrome Plated Stem & Esc Tube

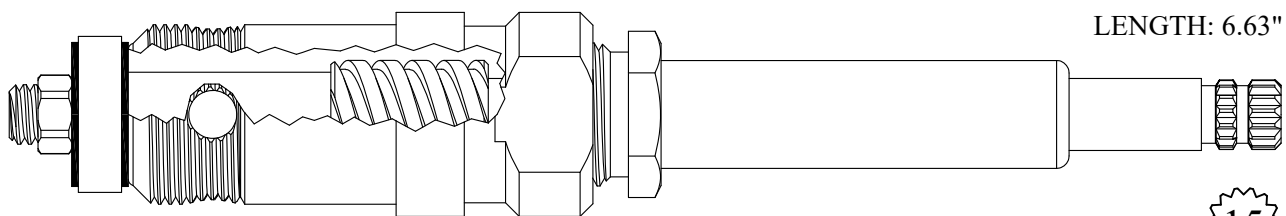

LENGTH: 6.63"

15/16-18 Thread

439121

GASKET INCLUDED: 895320

239121 Stem Only

15

1-13

FOR SAVOY

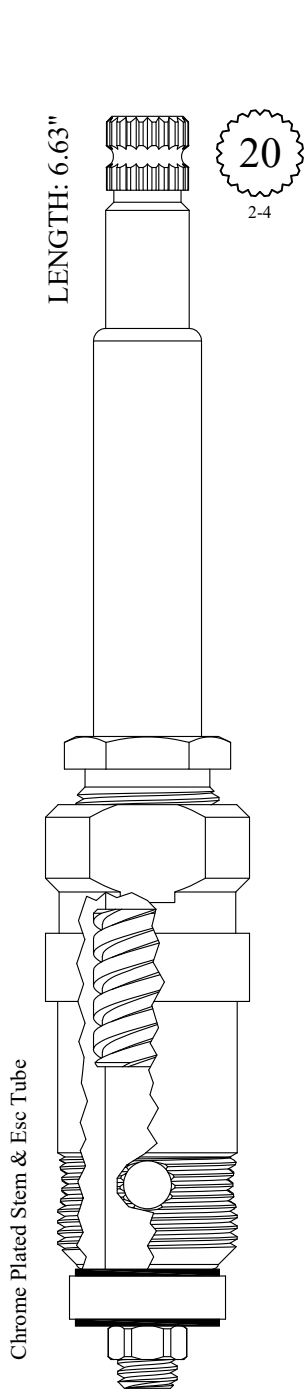

439131
GASKET INCLUDED: 895320
239131 Stem Only



414491
GASKET INCLUDED: 895400

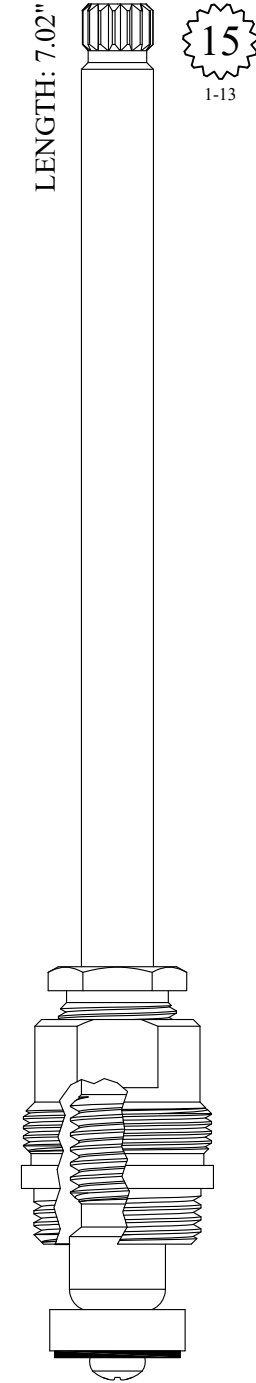

427081
GASKET INCLUDED: 895400



FOR SAYCO

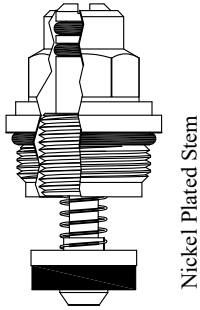

Nickel Plated Stem

GASKET: 890160 O-RING INCLUDED

400121
OEM # 8C 516887

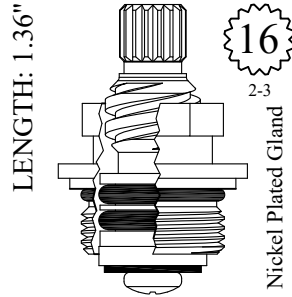

LENGTH: 1.36"

16
2-3

Nickel Plated Gland

GASKET: 890160 O-RING INCLUDED

LF450091
OEM # P068 or K4500R
LF450092
OEM # P069 or K4500L
IMPORT VERSION
SA11938-LF
SA11939-LF

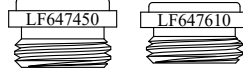

SEAT USED: LF647450 or LF647610

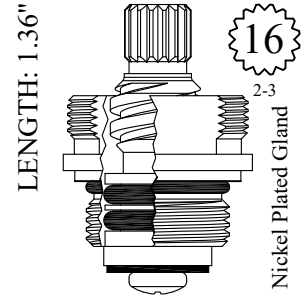

LENGTH: 1.36"

16
2-3

Nickel Plated Gland

GASKET: 890160 O-RING INCLUDED

LF451271
LF451272

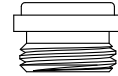

SEAT USED: LF647450

LENGTH: 1.37"

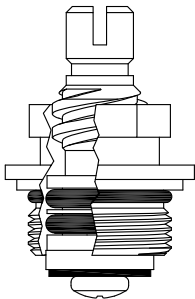

Nickel Plated Gland

GASKET: 890160 O-RING INCLUDED

400271
OEM # 247



SEAT USED: LF647450

LENGTH: 1.37"

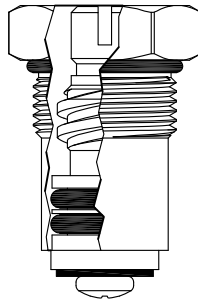

GASKET: 890170 O-RING INCLUDED

400281

LENGTH: 1.87"

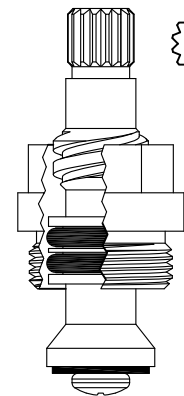

16
2-3

GASKET INCLUDED: 895100

LF456081
LF456082



SEAT USED: LF647450

FOR SAYCO

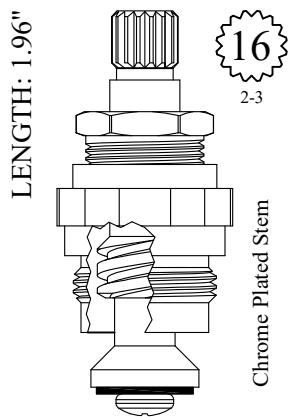

GASKET INCLUDED: 895100

LF458061
 LF458062
 LF258061 Stem Only
 OEM # 45
 LF258062 Stem Only



SEAT USED: LF647450

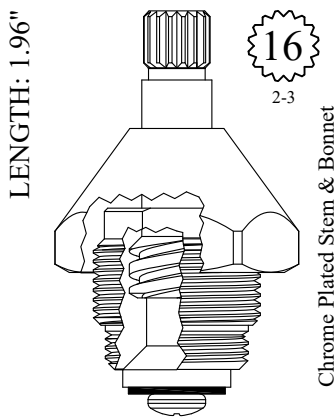

GASKET INCLUDED: 895100

LF459081
 LF459082
 LF258061 Stem Only
 LF258062 Stem Only



SEAT USED: LF647450

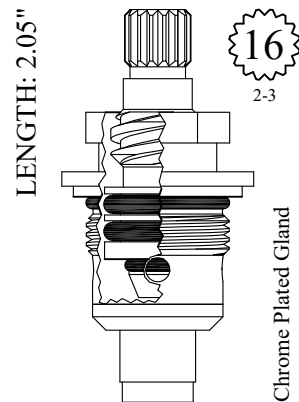

GASKET: 890160 O-RING INCLUDED
 SEAT INCLUDED: 652360

LF452361
 LF452362

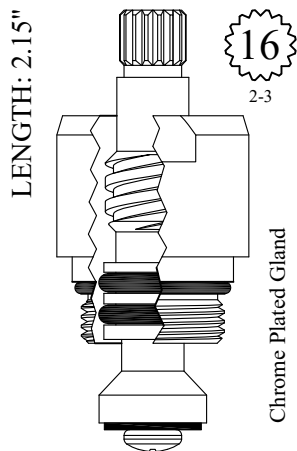

GASKET: 890170 O-RING INCLUDED

LF459111
 LF459112



SEAT USED: LF647450

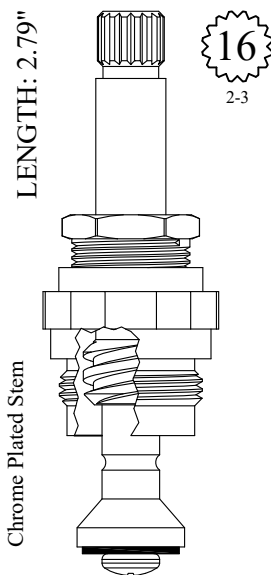

GASKET INCLUDED: 895100

LF466091
 LF466092
 LF266091 Stem Only
 LF266092 Stem Only



SEAT USED: LF647450

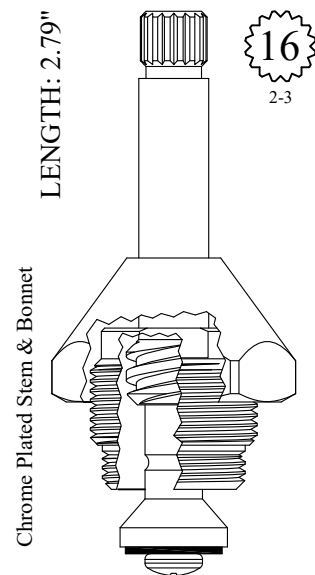

GASKET INCLUDED: 895100

LF466191
 LF466192
 LF266091 Stem Only
 LF266092 Stem Only

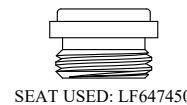

SEAT USED: LF647450

FOR SAYCO

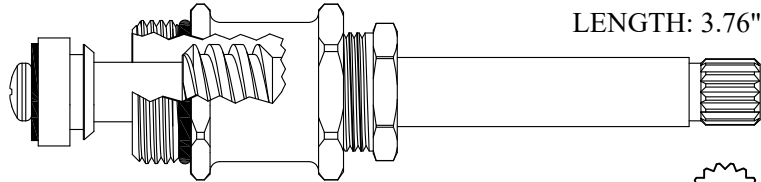
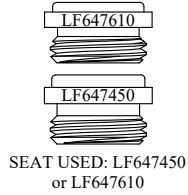

403031
GASKET: 890160 O-RING INCLUDED
203031 Stem Only

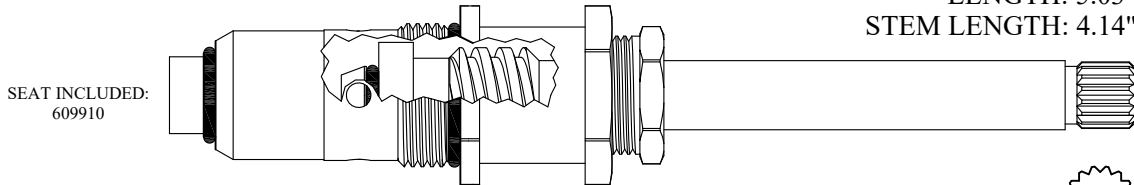

409911/ 409912
GASKET: 890160 O-RING INCLUDED
OEM # P1024/ P1025

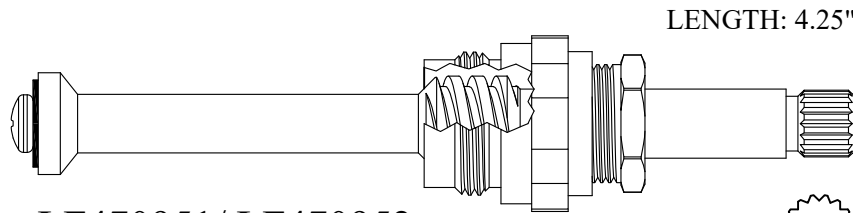

LF470951/ LF470952
GASKET INCLUDED: 895100
LF270951/ LF270952 Stem Only

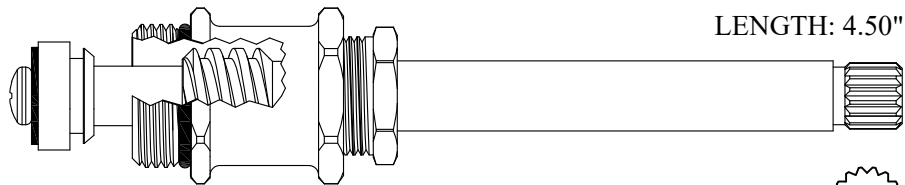
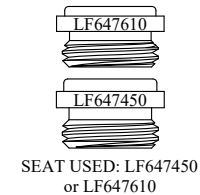

407201/ 407202
GASKET: 890160 O-RING INCLUDED
OEM # P002 or K 1-3/ P004
207201/ 207202 Stem Only
OEM # A027/ A038

IMPORT VERSION
SA21951
SA21952

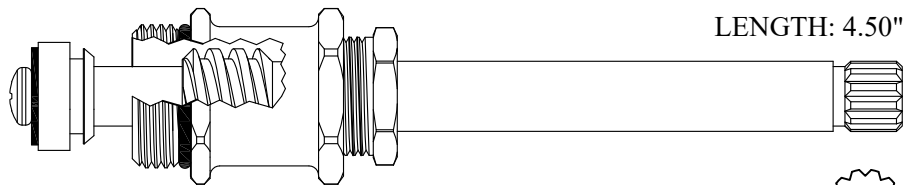
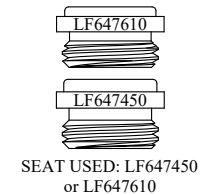

407251/ 407252
GASKET: 890160 O-RING INCLUDED
207251/ 207252 Stem Only



FOR SAYCO

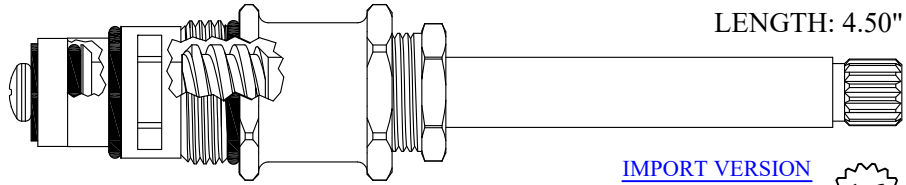
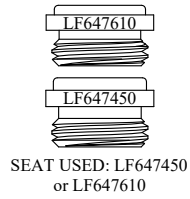

430701
GASKET: 890160 O-RING INCLUDED
OEM # P006 or KDA49
230701 Stem Only (Includes Cage)
OEM # 1D-1116

IMPORT VERSION
SA21953

16

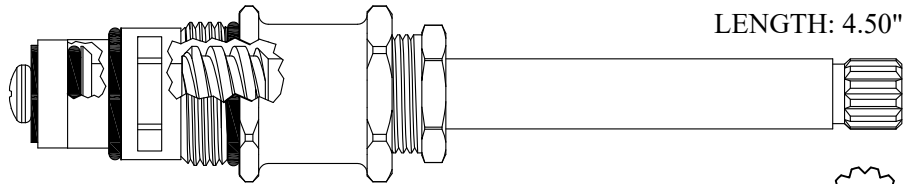
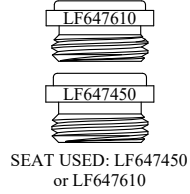

430751
GASKET: 890160 O-RING INCLUDED
207251 Stem Only

12
1-2

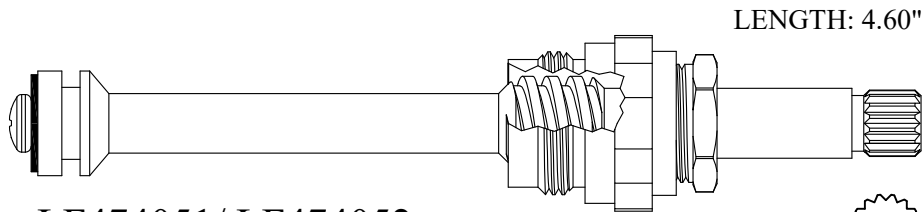

LF474051/ LF474052
GASKET USED: 895100
OEM # P178R / P178L
LF274051/ LF274052 Stem Only
OEM # 214

16
2-3

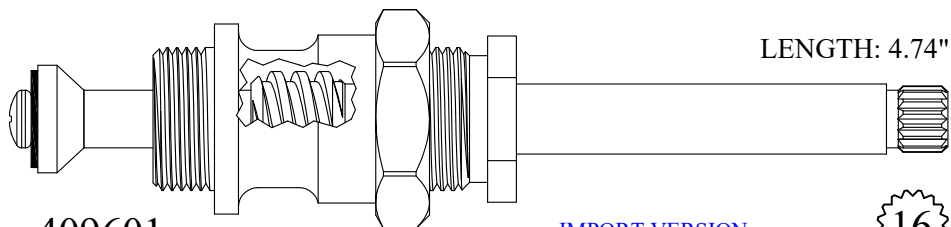

409601
GASKET USED: 895100
OEM # K1-1116/SBS1035
209601 Stem Only
OEM # 1-1116

IMPORT VERSION
SA21957

16
2-3

FOR SAYCO

Chrome Plated Stem

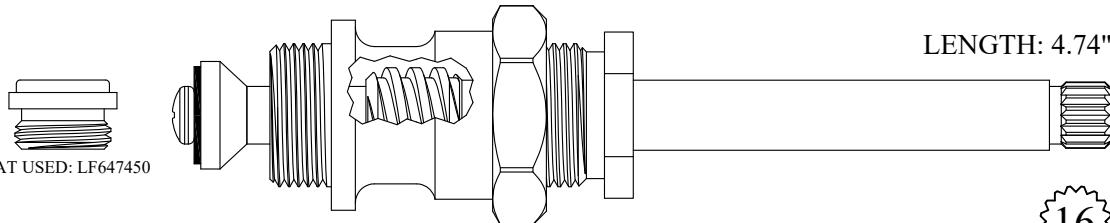

SEAT USED: LF647450

LENGTH: 4.74"

409611
GASKET USED: 895100
OEM # SBS1033
209611 Stem Only

16
2-3

Chrome Plated Stem

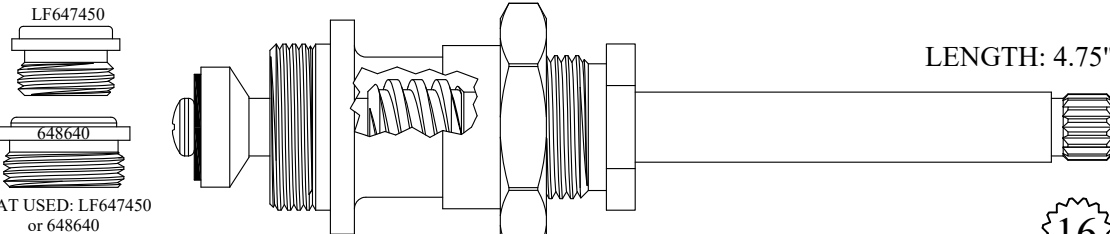

LF647450
648640

SEAT USED: LF647450
or 648640

LENGTH: 4.75"

409801
GASKET USED: 895400
OEM # KLOS-1
209801 Stem Only
OEM # LOS-1

16
2-3

SEAT INCLUDED:
652360



LENGTH: 5.20"
STEM LENGTH: 4.75"

LF479991/ LF479992

16
2-3

Chrome Plated Stem

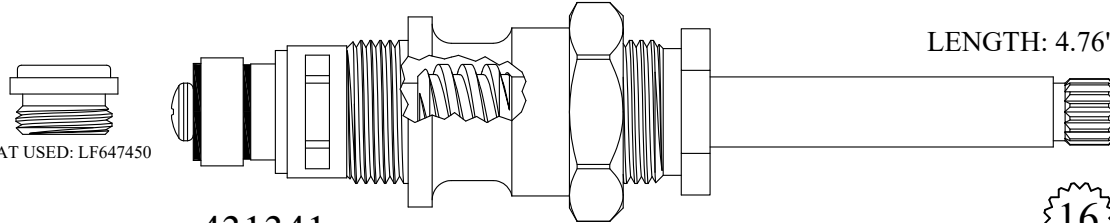

SEAT USED: LF647450

LENGTH: 4.76"

431341
GASKET INCLUDED: 895100
231341 Stem Only
OEM # OS-1D

16
2-3

FOR SAYCO

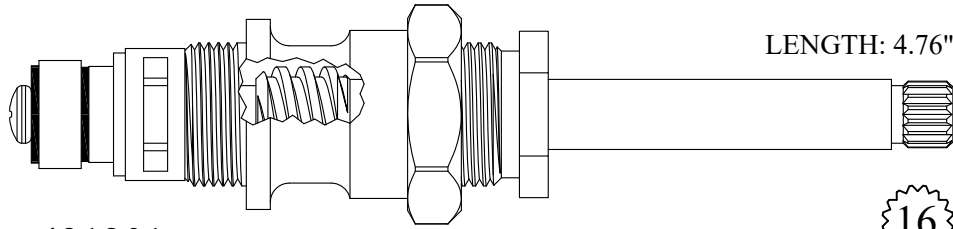

LENGTH: 4.76"

431201

GASKET INCLUDED: 895100

OEM # K1D-1116

231201 Stem Only

OEM # OS-1D

16

2-3

Chrome Plated Esc Tube

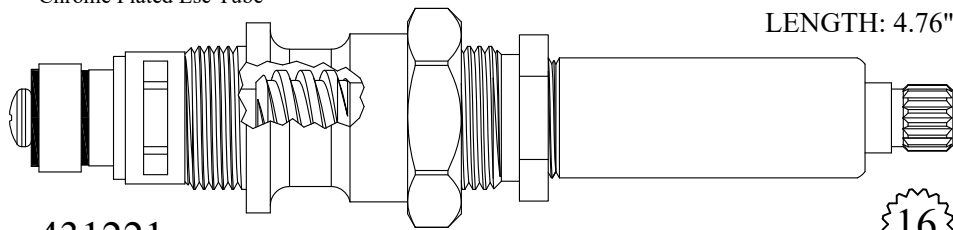

LENGTH: 4.76"

431221

GASKET INCLUDED: 895100

231201 Stem Only

16

2-3

Chrome Plated Stem

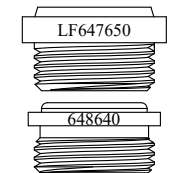

SEAT USED: LF647450
or 648640

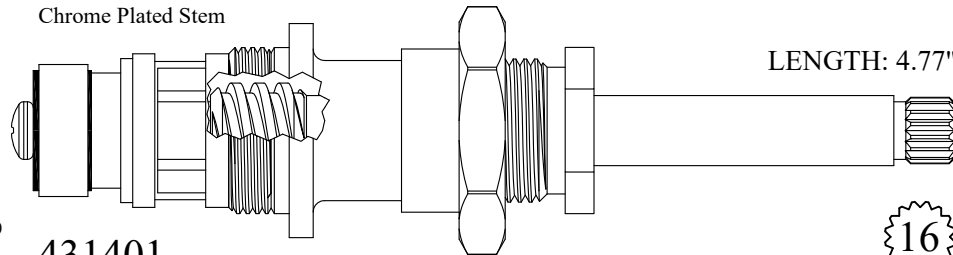

LENGTH: 4.77"

431401

GASKET USED: 895400

OEM # KLOS-1D

231401 Stem Only

OEM # LOS-1D

Stem also available less cage

231401-1

16

2-3

Chrome Plated Stem



SEAT USED: LF647450

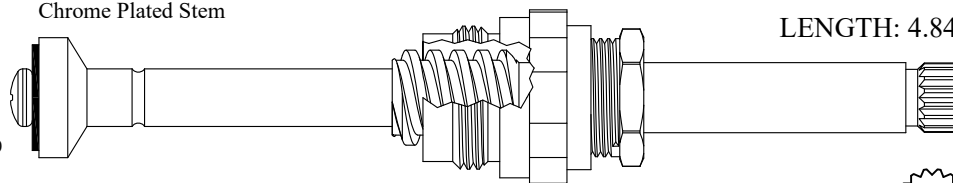

LENGTH: 4.84"

LF476051/ LF476052

GASKET USED: 895100

LF276051/ LF276052 Stem Only

16

2-3

FOR SCOVILLE

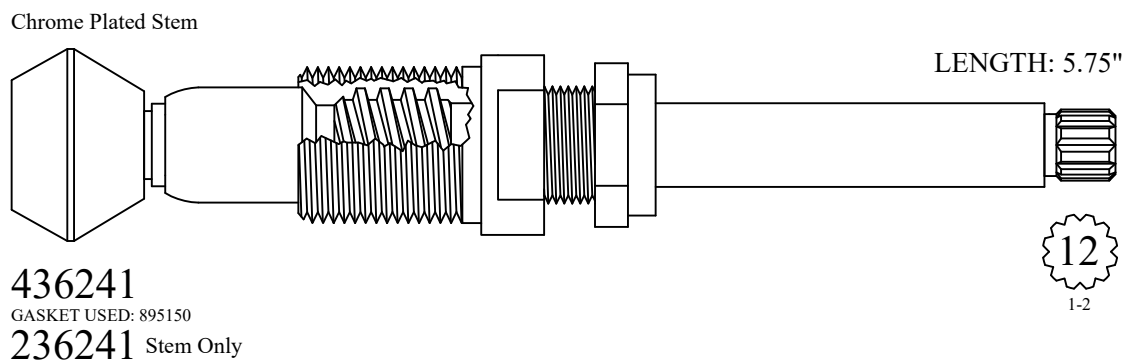
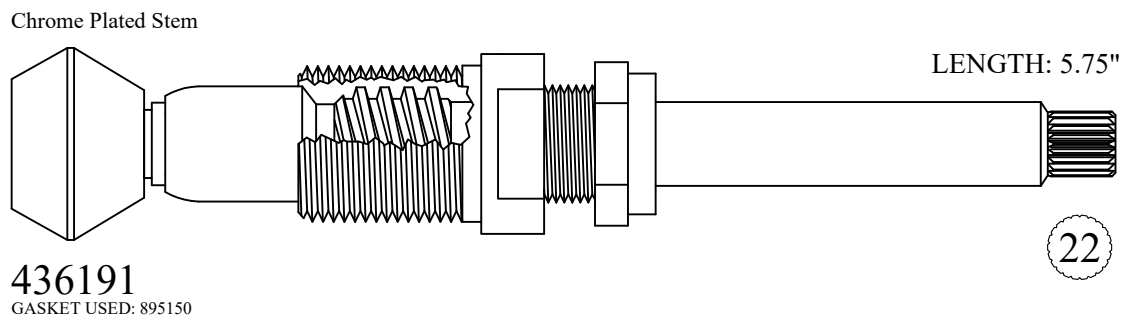
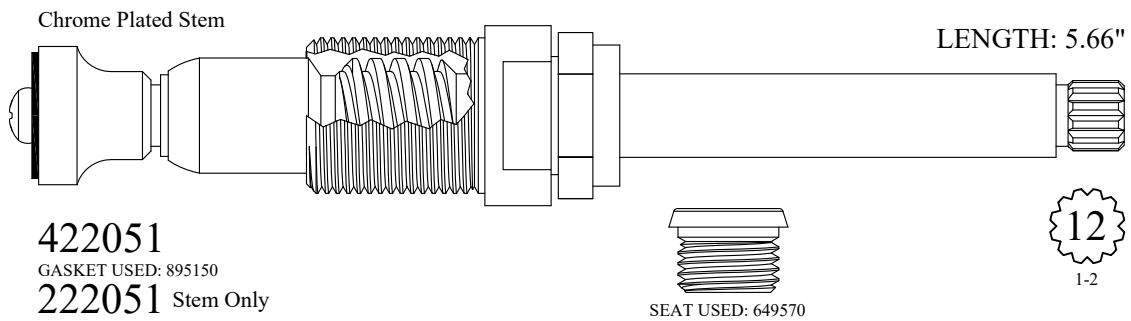
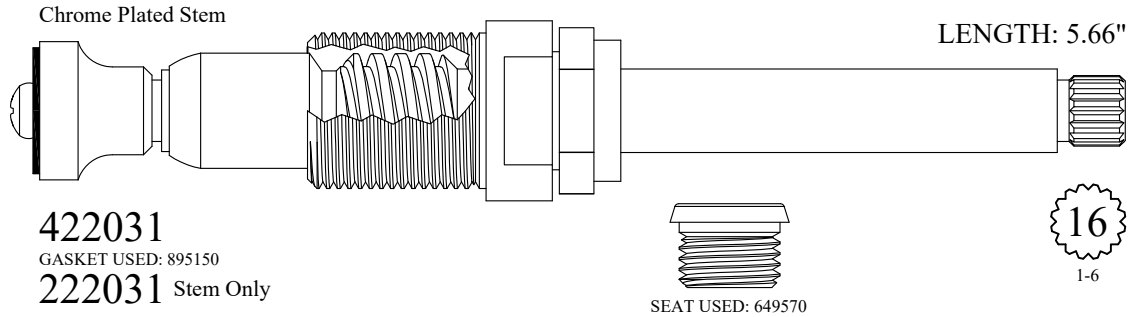
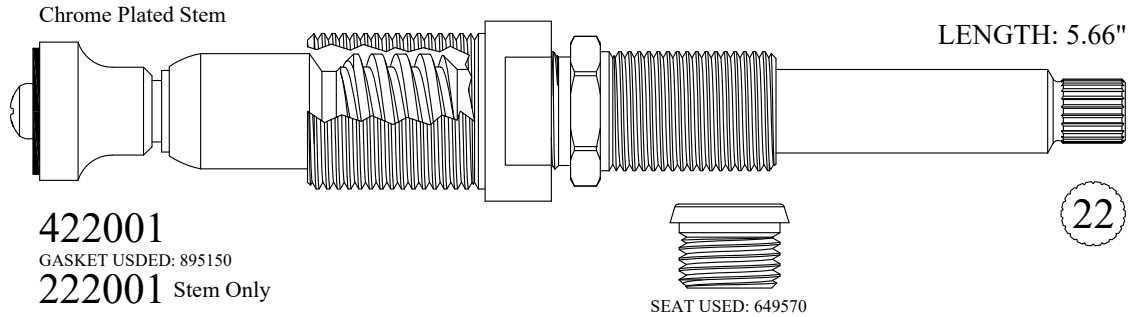

FOR SEARS - U/R - ELKAY

LENGTH: 1.50"

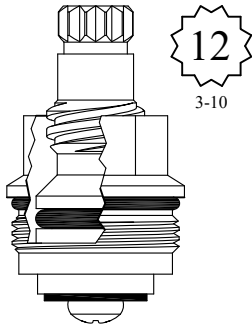

GASKET: 890180 O-RING INCLUDED

LF451091
LF451092



SEAT USED: LF648900

LENGTH: 1.63"

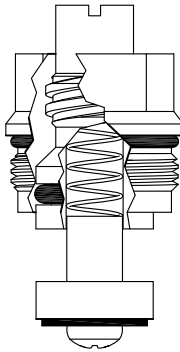

GASKET: 890180 O-RING INCLUDED

400261
OEM # 32406L

LENGTH: 1.74"

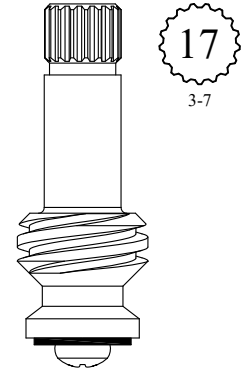

LF254141
LF254142

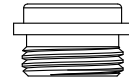

SEAT USED: LF648700

LENGTH: 1.75"

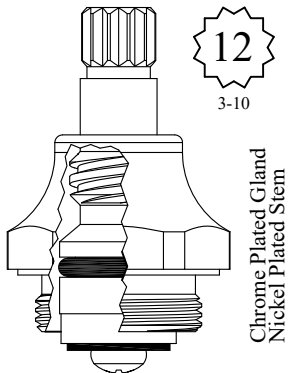

GASKET INCLUDED: 895150

LF454171
LF454172



SEAT USED: LF648700

LENGTH: 1.75"

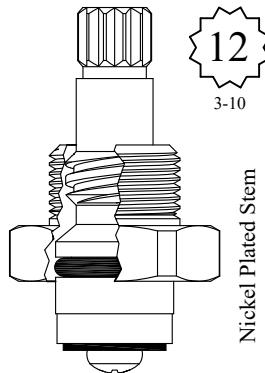

LF454221
LF454222



SEAT USED: LF648700

LENGTH: 1.75"

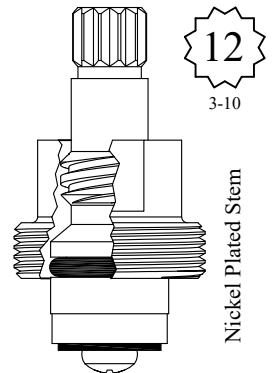

LF454231
LF454232

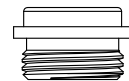

SEAT USED: LF648700

FOR SEARS - U/R - ELKAY

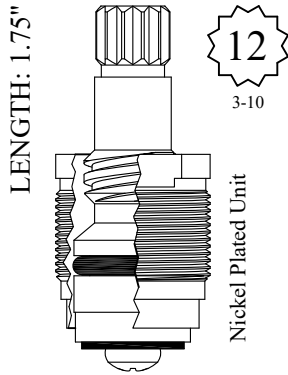

GASKET INCLUDED: 894670

LF455021
LF455022

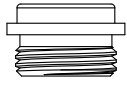

SEAT USED: LF648700

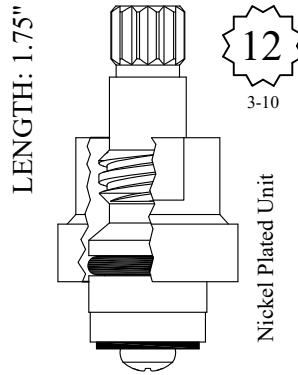

LF455041
LF455042

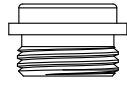

SEAT USED: LF648700

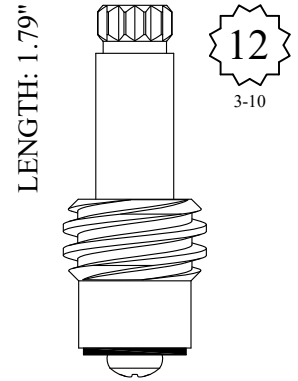

LF255101
LF255102

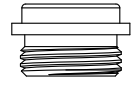

SEAT USED: LF648700

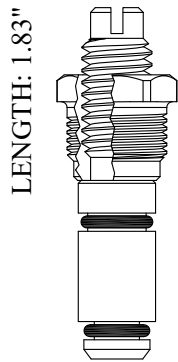

400361

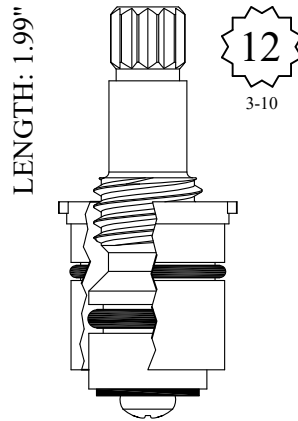

LF458131
LF458132

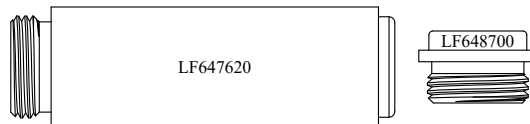

SEAT USED: LF647620 or LF648700

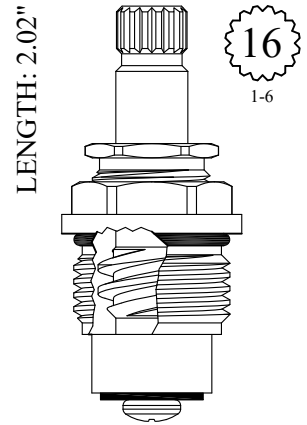

GASKET: 890170 O-RING INCLUDED

LF458281
LF458282

FOR SEARS - U/R - ELKAY

LENGTH: 2.18"

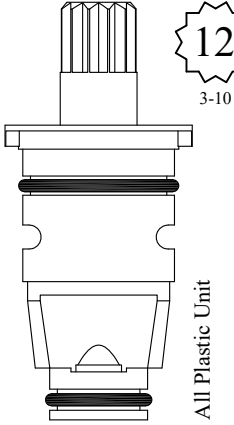

All Plastic Unit

459461 Red
459462 Blue

Single Lead

LENGTH: 2.22"

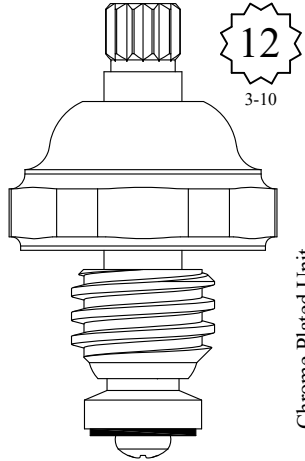

Chrome Plated Unit

LF463021
LF263021 Stem Only

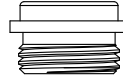

SEAT USED: LF648700

Double Lead

LENGTH: 2.22"

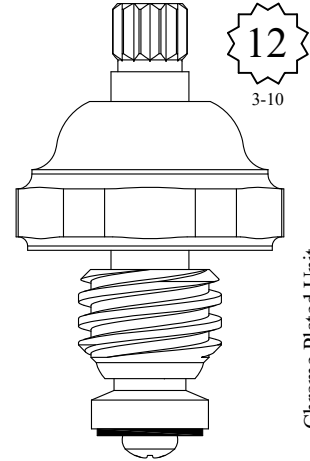

Chrome Plated Unit

LF463031
LF463032
LF263031 Stem Only
LF263032 Stem Only

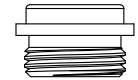

SEAT USED: LF648700

LENGTH: 2.25"



Also available with Bonnet Nut 759620
LF459621-N/ LF459622-N

LF459621
LF459622

LENGTH: 2.37"

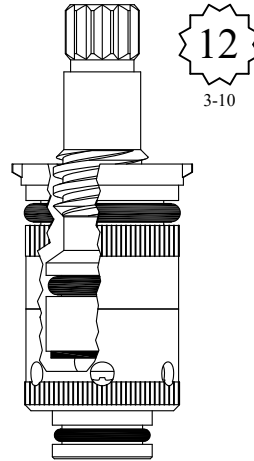

Also available less seat

LF461081-LS/ LF461082-LS

LF461081
OEM # P32008-R
LF461082
OEM # P32008-L

LENGTH: 2.37"

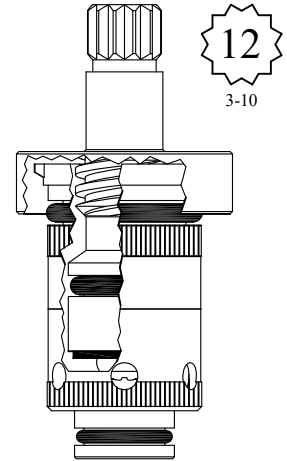

LF461181
LF461182

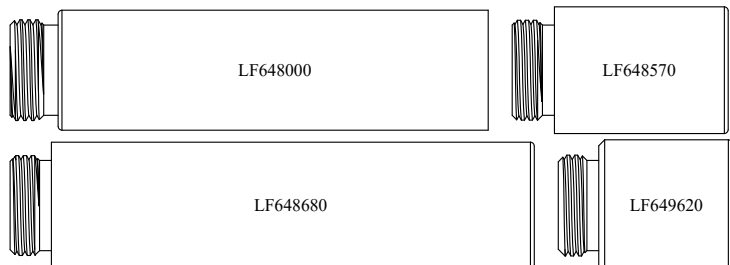

SEATS USED: LF648000, LF648570, LF648680 & LF649620

FOR SEARS - U/R - ELKAY

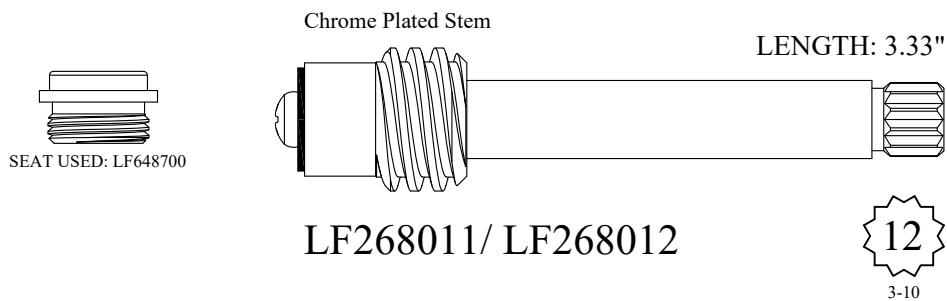
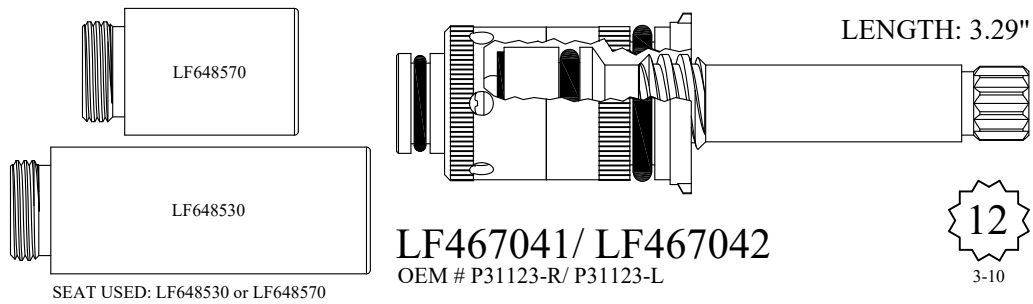
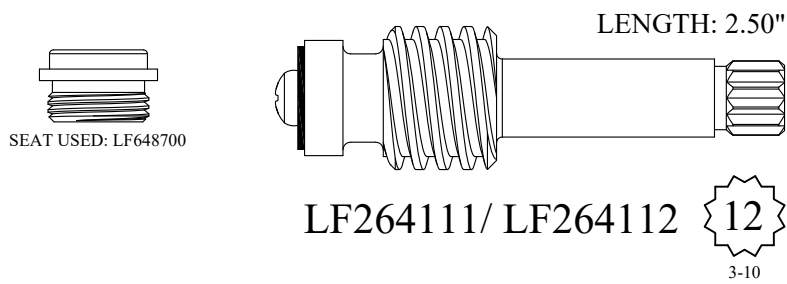
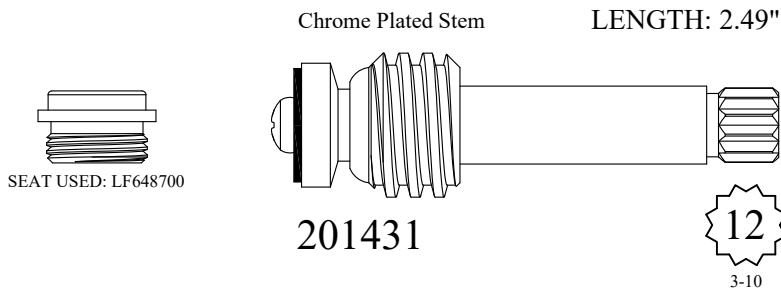

FOR SEARS - U/R - ELKAY

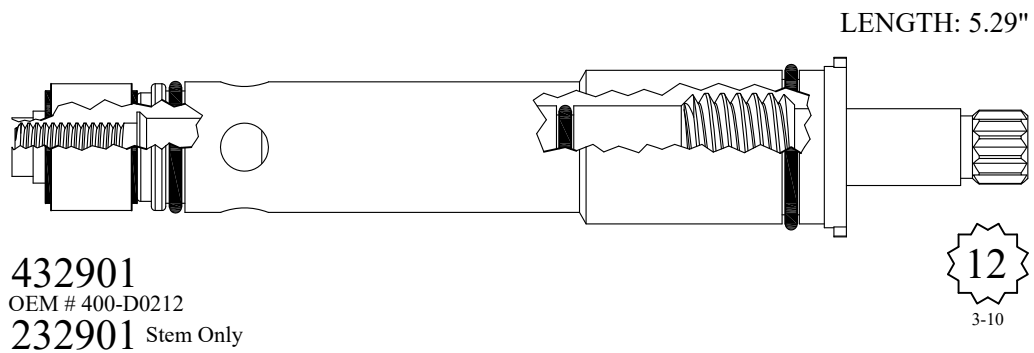
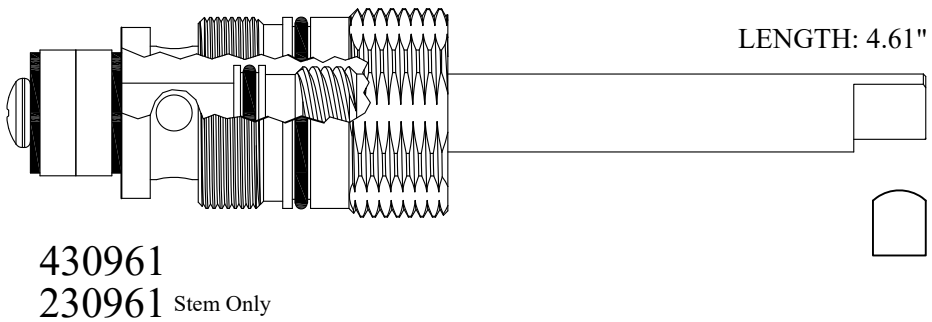
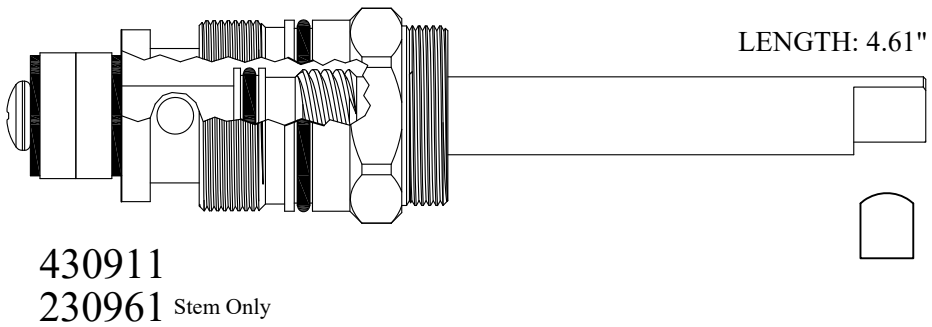
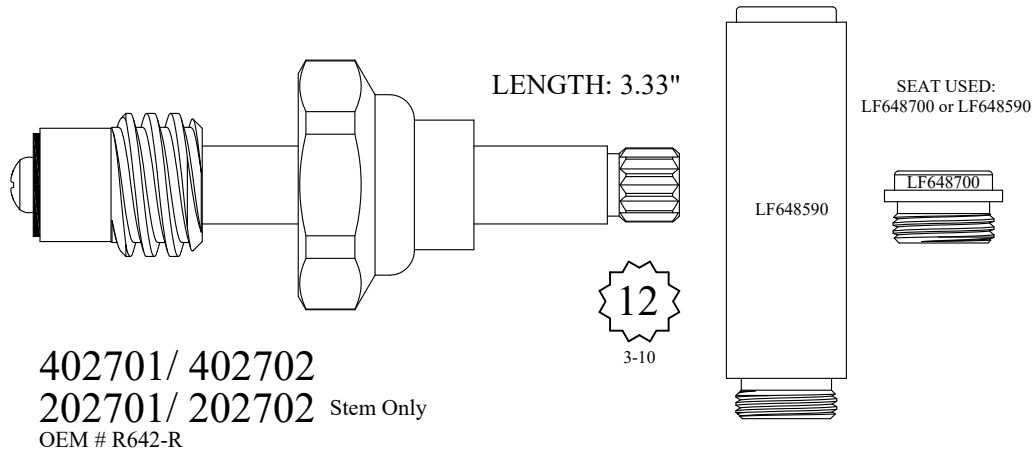

FOR SEARS - U/R - ELKAY

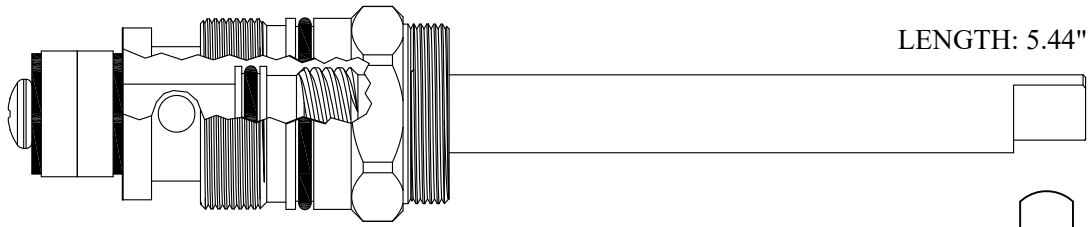

434741

GASKET INCLUDED: 890200

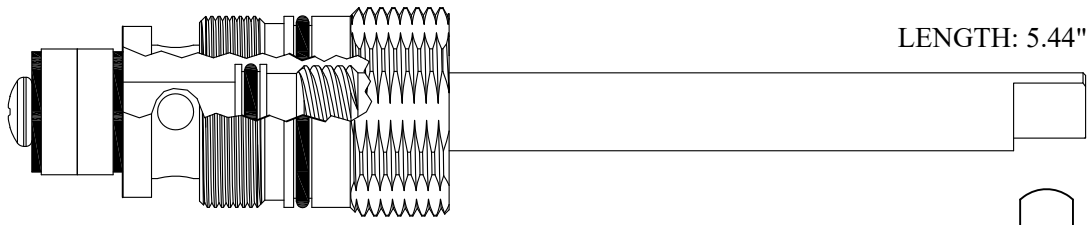

434841

GASKET INCLUDED: 890200

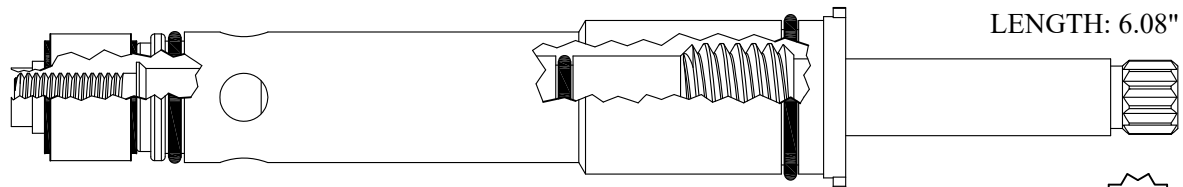

437011

OEM # 400-D0211

12
3-10

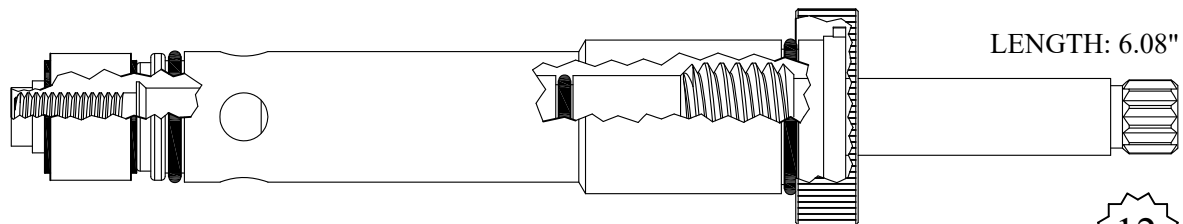

437021

12
3-10

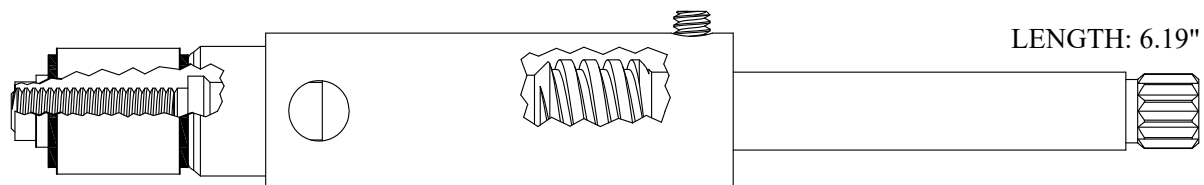

438411

OEM # XP7499

12
3-10

FOR SEPCO

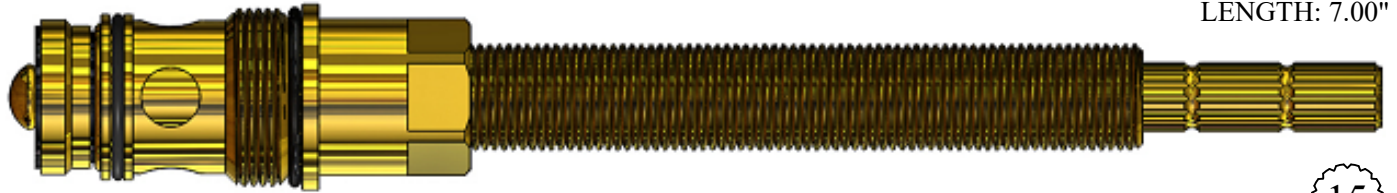

LENGTH: 7.00"

434371

GASKET INCLUDED: 890190

15

3-27

FOR SHERLE WAGNER

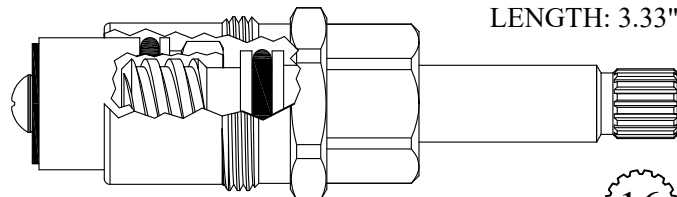

LENGTH: 3.33"

LF467501/ LF467502

GASKET INCLUDED: 895100

16
3-15

Polished Brass Stem

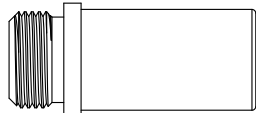

SEAT USED: LF648620

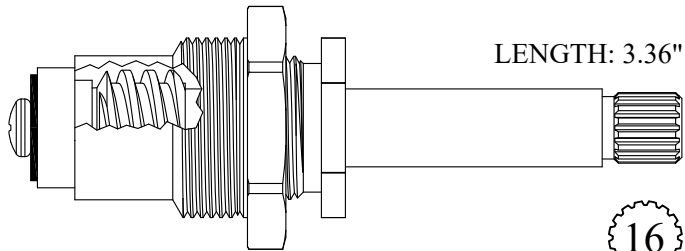

LENGTH: 3.36"

LF467111-PB/ LF467112-PB

GASKET INCLUDED: 895330

16
3-15

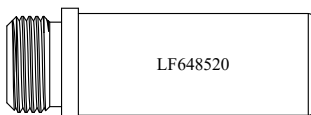

LF648520

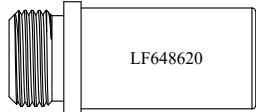

LF648620

SEAT USED: LF648520 or LF648620

Polished Brass Stem

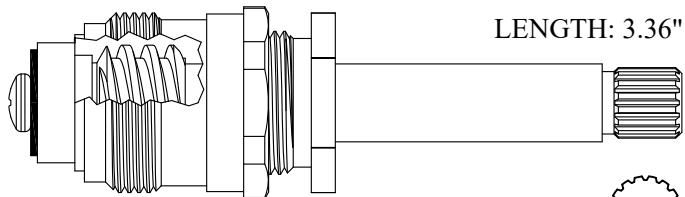

LENGTH: 3.36"

LF467611-PB/ LF467612-PB

GASKET INCLUDED: 895120

16
3-15

FOR SHERLE WAGNER

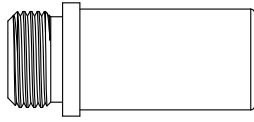

SEAT USED: LF648620



LENGTH: 3.90"

LF476081/ LF476082

GASKET: 891170 O-RING INCLUDED



3-15

FOR SIGMA

Chrome Plated Retainer



402121
OEM # 18.30.895



GASKET: 890150 O-RING INCLUDED

400681
OEM # 18.30.156

FOR SIGN OF THE CRAB

Chrome Bonnet
available separately

757500

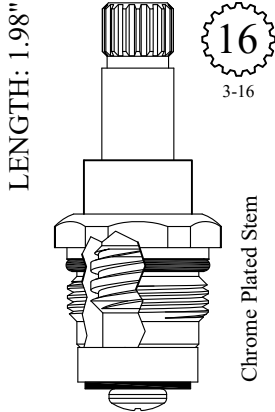
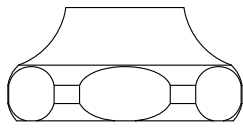

Chrome Plated Stem

Also available with polished brass stem

LF457501-PB / LF457502-PB

GASKET: 890160 O-RING INCLUDED

LF457501
OEM # PP0106H
LF457502
OEM # PP0106C

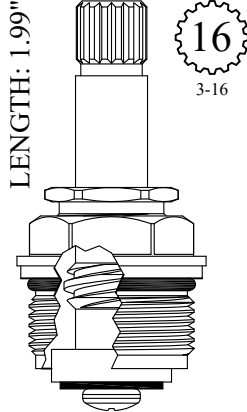

GASKET: 890180 O-RING INCLUDED

LF457721
OEM # PP0105H
LF457722
OEM # PP0105C

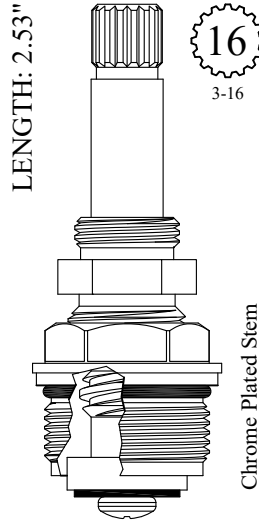

Chrome Plated Stem

GASKET: 890180 O-RING INCLUDED

LF464151
OEM # PP0101H
LF464152
OEM # PP0101C

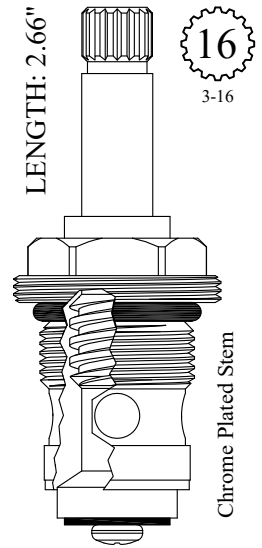

Chrome Plated Stem

GASKET: 891150 O-RING INCLUDED

430761
OEM # 167034

Chrome Plated Stem

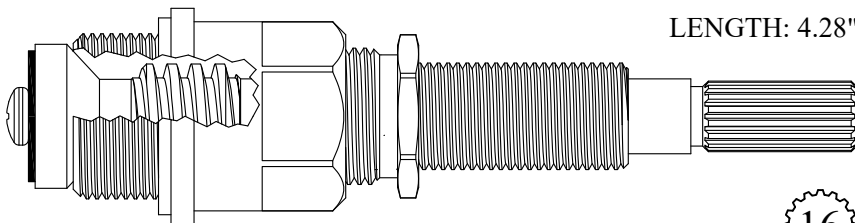

404841/ 404842

GASKET: 895390 INCLUDED
OEM # PP0102C/ PP0103C

Chrome Plated Stem

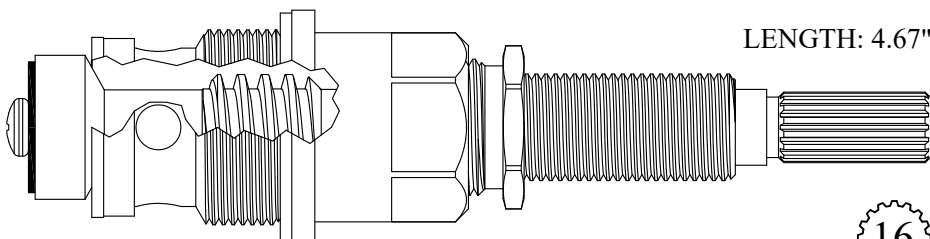

430971

GASKET: 895570 INCLUDED
OEM # PP0102C

FOR SPEAKMAN

LENGTH: 1.07"

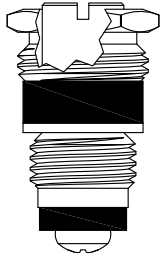

Nickel Plated Stem
Chrome Plated Pkg Nut

LF400111

OEM # G03-0206 & 01-0513

LF200111 Stem Only

OEM # G03-0206

LENGTH: 1.24"

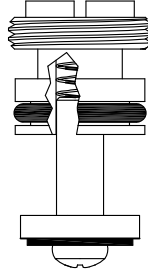

400220

LENGTH: 1.48"

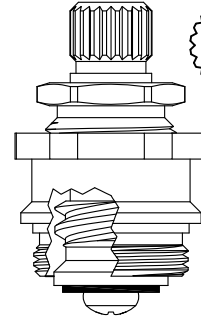

20

2-4

Nickel Plated Gland

GASKET INCLUDED: 895150

LF451081

OEM # G05-0349

LF451082

OEM # G05-0350

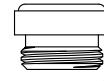

SEAT USED: LF648760

LENGTH: 1.63"

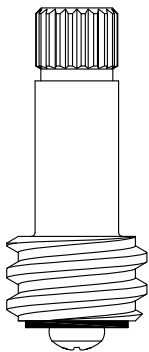

20

2-4

LF253071
LF253072

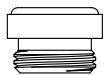

SEAT USED: LF648760

LENGTH: 1.64"

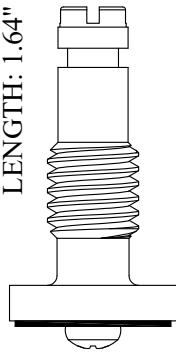

Chrome Plated Stem

252911
OEM # G03-0205

LENGTH: 1.75"

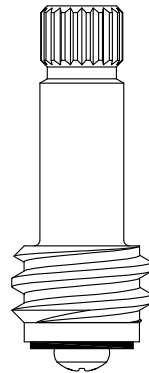

20

2-4

Chrome Plated Stem

LF256011
LF256012

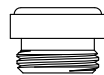

SEAT USED: LF648760

LENGTH: 1.85"

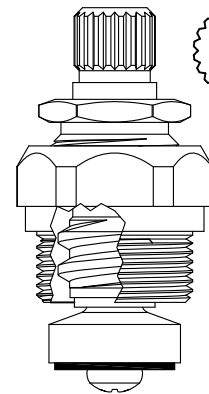

20

2-4

Chrome Plated Unit

LF456061
LF456062
GASKET INCLUDED: 895150
LF256061 Stem Only
LF256062 Stem Only



SEAT USED: LF648930

FOR SPEAKMAN

LENGTH: 2.00"

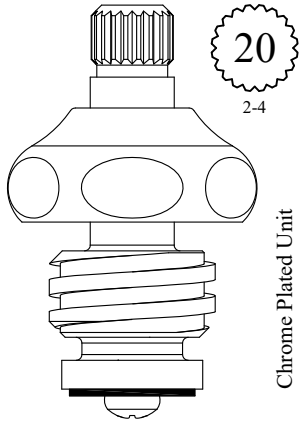

Chrome Plated Unit

LF457121
LF457122
LF257121 Stem Only
LF257122 Stem Only

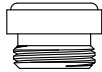

SEAT USED: LF648760

LENGTH: 2.20"

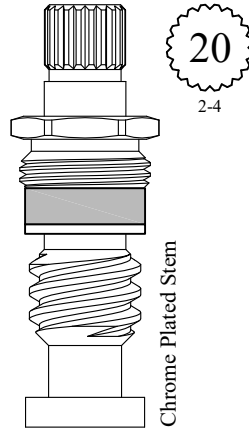

Chrome Plated Stem

401131
OEM # 03-0257
201131 Stem Only
OEM # 03-0352



SEAT USED: 648190

LENGTH: 2.24"

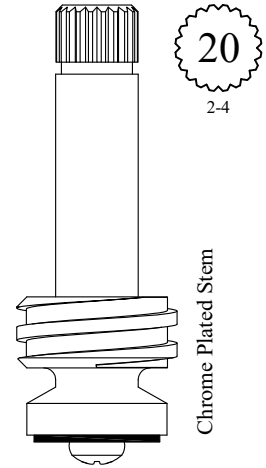

Chrome Plated Stem

LF263041
LF263042



SEAT USED: LF648930

LENGTH: 2.45"

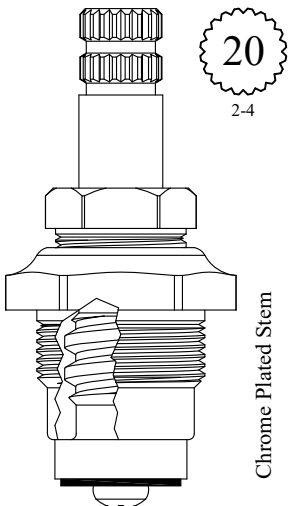

Chrome Plated Stem

LF463731
GASKET INCLUDED: 895400
LF263731 Stem Only

LENGTH: 2.48"

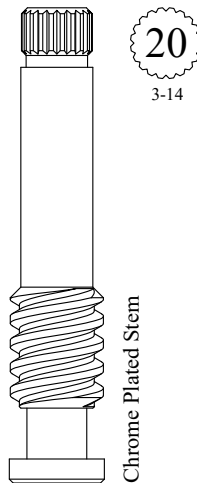

Chrome Plated Stem

201301
OEM # 03-0389

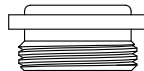

SEAT USED: 648190

LENGTH: 2.51"

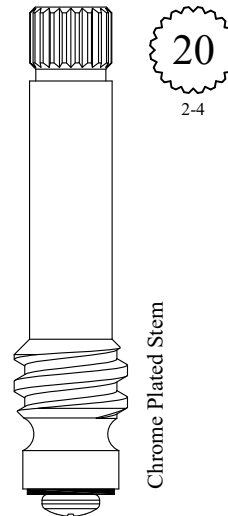

Chrome Plated Stem

LF264081
LF264082



SEAT USED: LF648760

LENGTH: 2.52"



LF264430
OEM # 03-0434

FOR SPEAKMAN

LENGTH: 2.54"

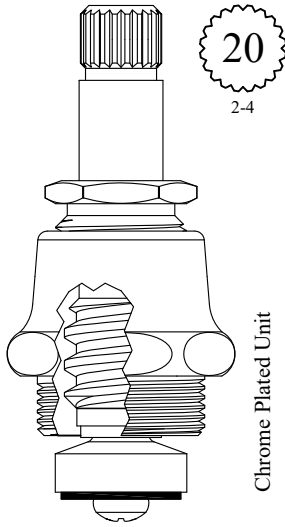

Chrome Plated Unit

GASKET INCLUDED: 895180

LF464051

OEM # G05-0199

LF464052

LF264051 Stem Only

LF264052 Stem Only



SEAT USED: LF648930

LENGTH: 2.60"

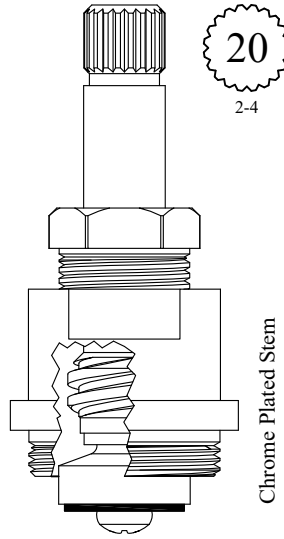

Chrome Plated Stem

GASKET INCLUDED: 895550

LF464071

LF264071 Stem Only

LENGTH: 2.63"

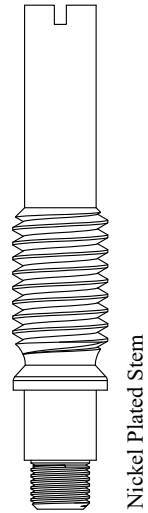

Nickel Plated Stem

264331

OEM # 03-0237

LENGTH: 2.79"

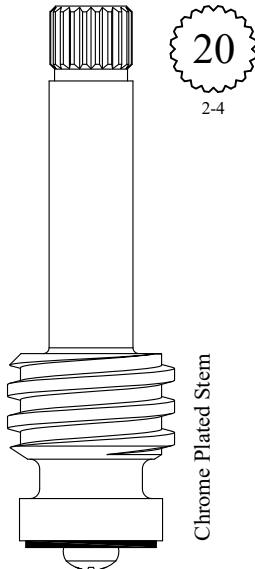

Chrome Plated Stem

LF265421

LENGTH: 2.88"

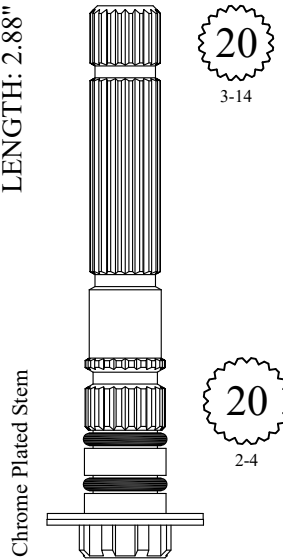

Chrome Plated Stem

201510

OEM # G03-0259

LENGTH: 2.88"

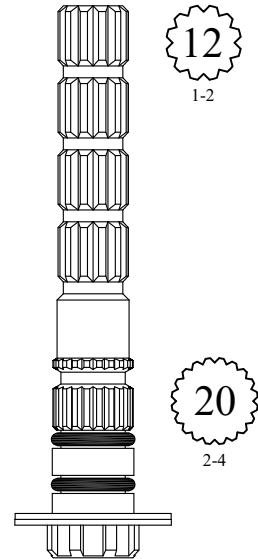

201540

FOR SPEAKMAN

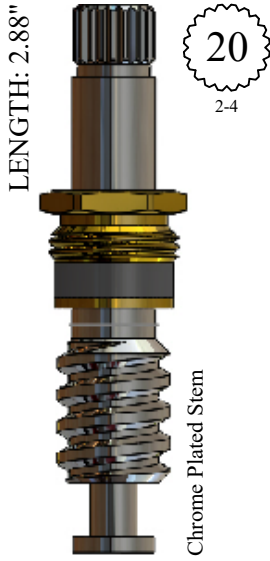

401681
201681 Stem Only
OEM # 03-0347

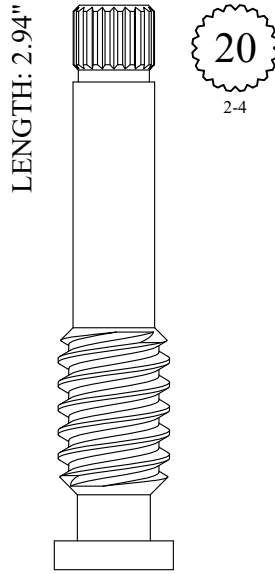

201701
OEM # 03-0278

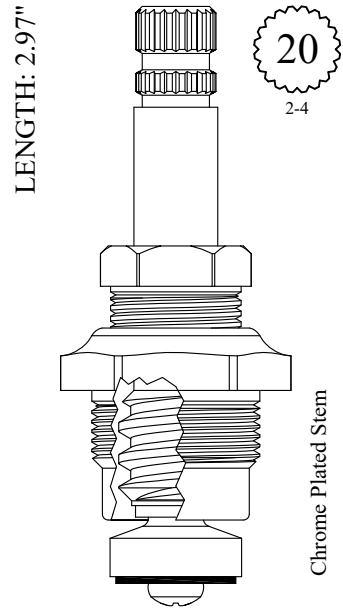

GASKET INCLUDED: 895400

LF467171
OEM # G03-0285
LF467172
LF267171 Stem Only
OEM # G03-0175
LF267172 Stem Only

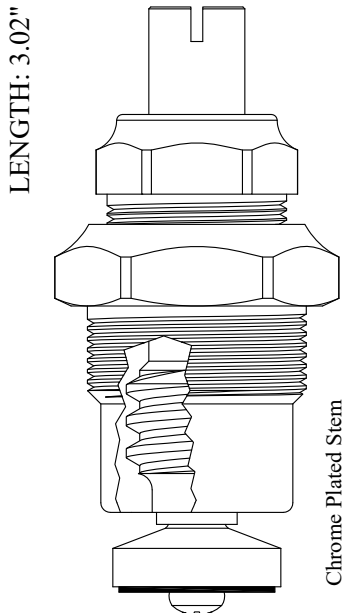

GASKET INCLUDED: 895450

402071
OEM # G03-0158
202071 Stem Only
OEM # G03-0113

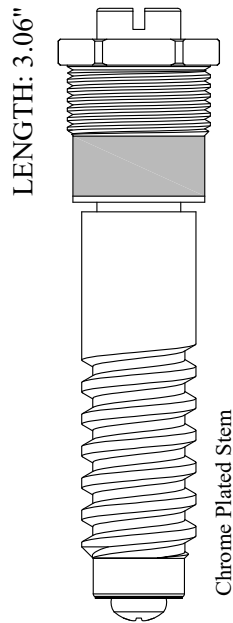
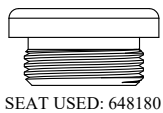

401901
201901 Stem Only
OEM # G03-0187

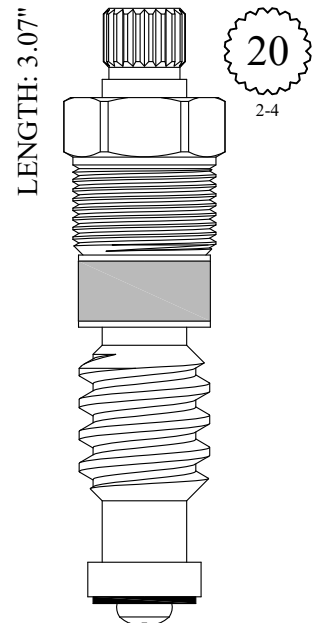

402201
202201 Stem Only
OEM # 03-0334



FOR SPEAKMAN

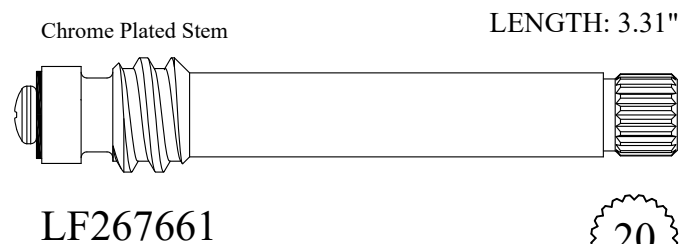
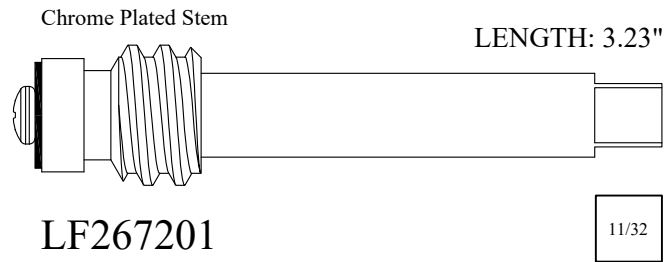
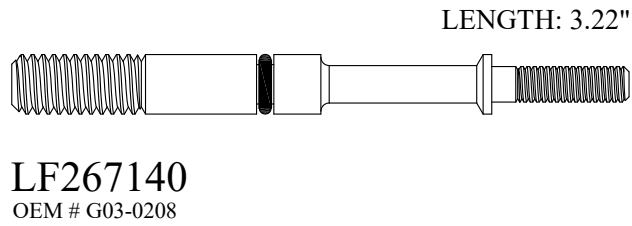
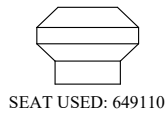
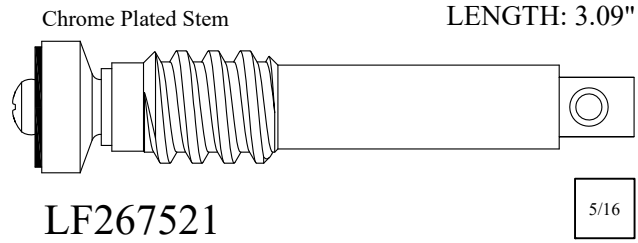

FOR SPEAKMAN

LENGTH: 3.37"

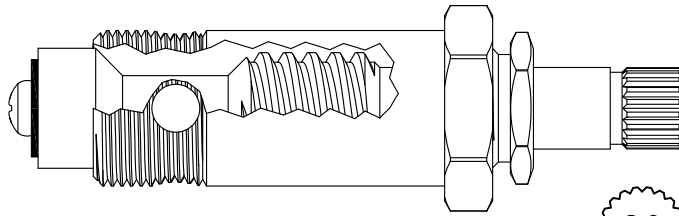

430111
GASKET INCLUDED: 895160
230111 Stem Only
OEM # 03-0335



LENGTH: 3.40"

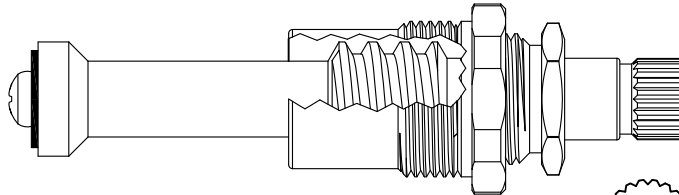

LF468501
LF268501 Stem Only
OEM # G03-0199



LENGTH: 3.44"

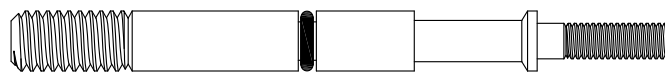
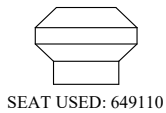

LF267900

Chrome Plated Stem

LENGTH: 3.69"



202980



FOR SPEAKMAN

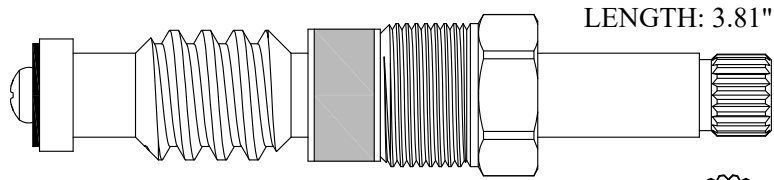

403301
203301 Stem Only
OEM # G03-0169

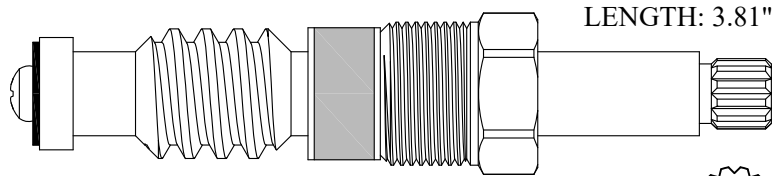

403351
203351 Stem Only

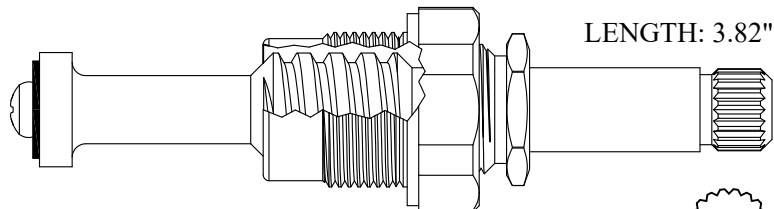

403241
GASKET INCLUDED: 895160
OEM # G05-0357
203241 Stem Only
OEM # G03-0200

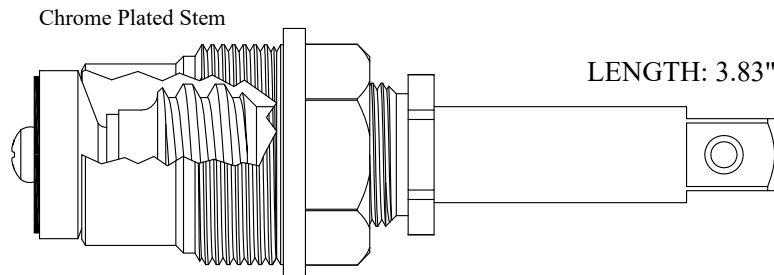
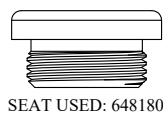

403401
203401 Stem Only

FOR SPEAKMAN

Chrome Plated Stem

LENGTH: 3.88"

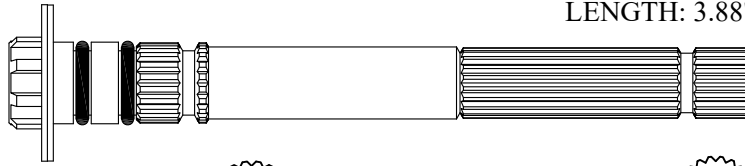

203470
OEM # G03-0365



SEAT USED: LF648930

Chrome Plated Stem

LENGTH: 3.88"

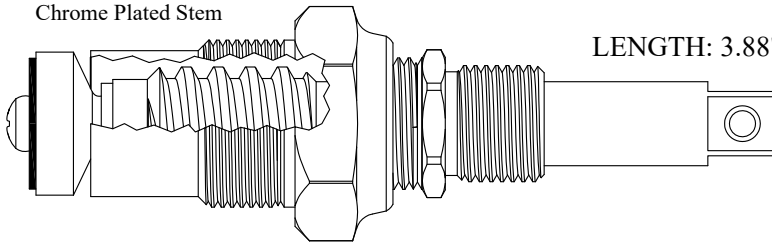

403531
GASKET INCLUDED: 895400
203531 Stem Only

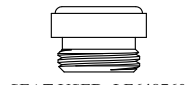

SEAT USED: LF648760

LENGTH: 3.88"

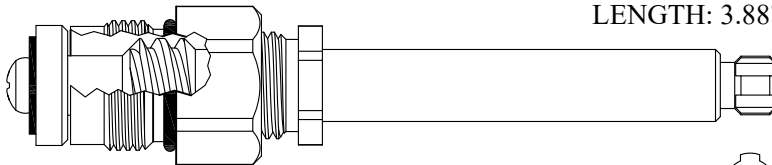

403781
GASKET: 890150 O-RING INCLUDED
OEM # G05-0407

Chrome Plated Stem

LENGTH: 4.00"

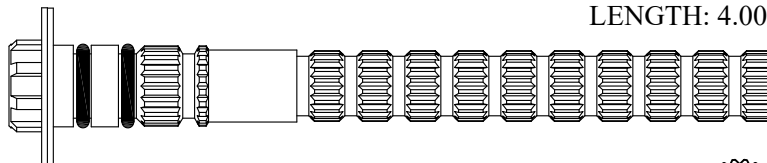

204030



FOR SPEAKMAN

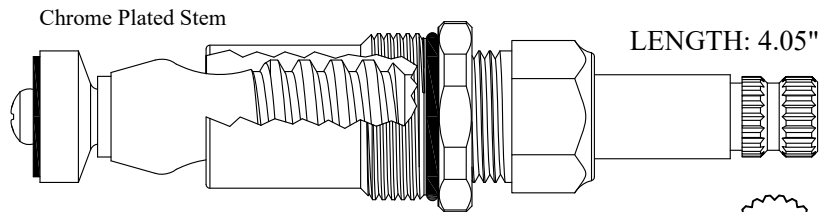
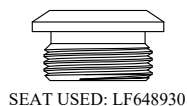

LF470101/ LF470102

GASKET: 890180 O-RING INCLUDED

OEM # G05-0313

LF270101/ LF270102 Stem Only

OEM # G03-0189

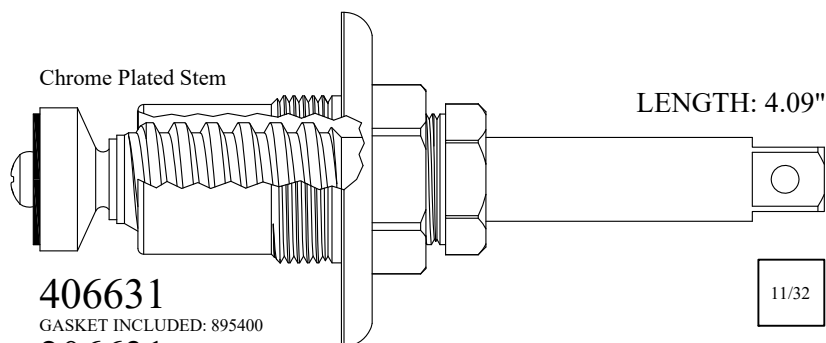
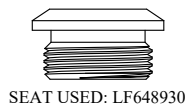

406631

GASKET INCLUDED: 895400

206631 Stem Only



403681

GASKET INCLUDED: 895180

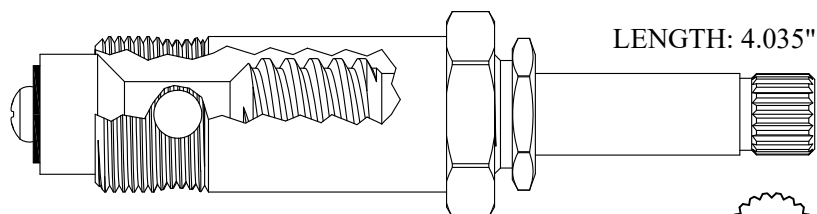
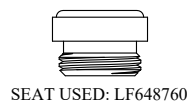

430121

GASKET INCLUDED: 895160

230121 Stem Only

OEM # G03-0172



FOR SPEAKMAN

Chrome Plated Stem

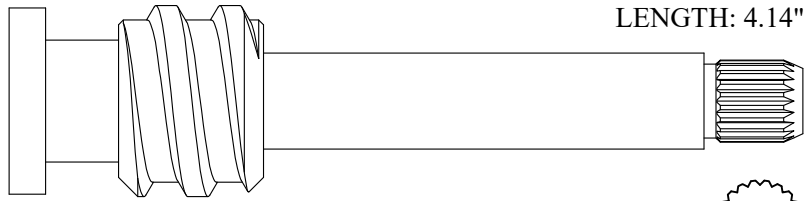

LENGTH: 4.14"

204511
OEM # 03-0304



SEAT USED: LF648760

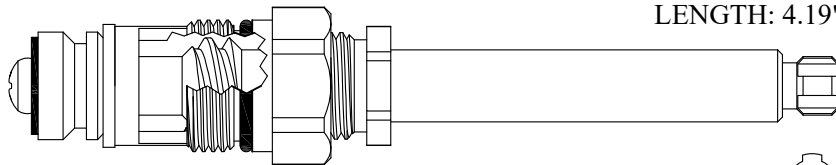

LENGTH: 4.19"

430381
OEM # G05-0408



Chrome Plated Stem



LENGTH: 4.33"

205611

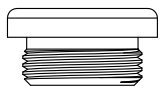

SEAT USED: 648180

Chrome Plated Stem

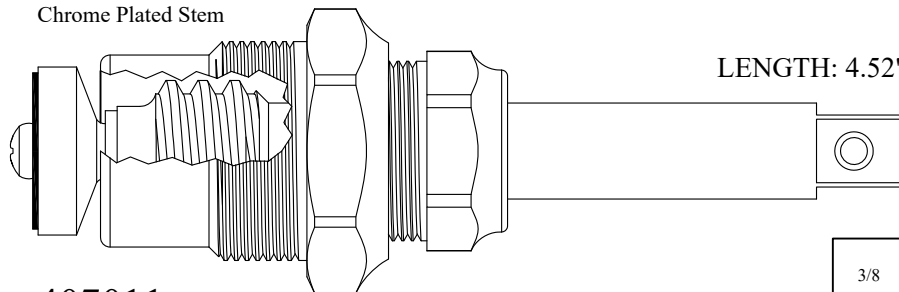

LENGTH: 4.52"

407011
GASKET INCLUDED: 895450
207011 Stem Only



FOR SPEAKMAN

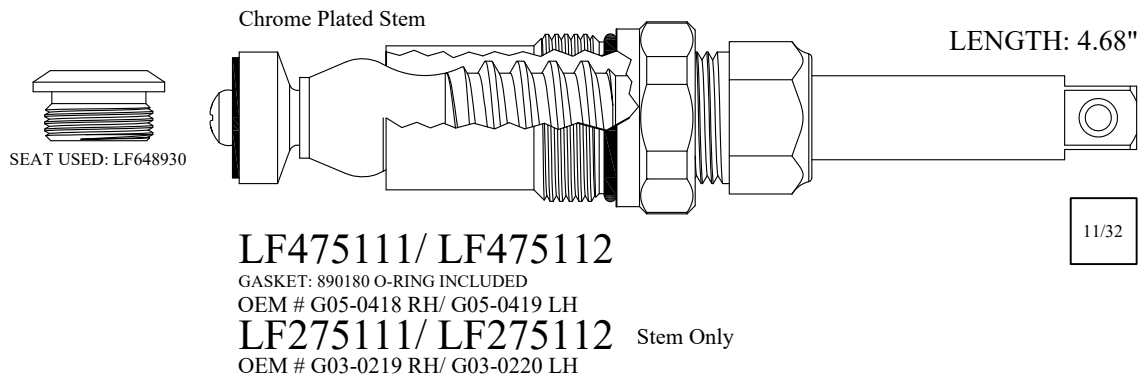
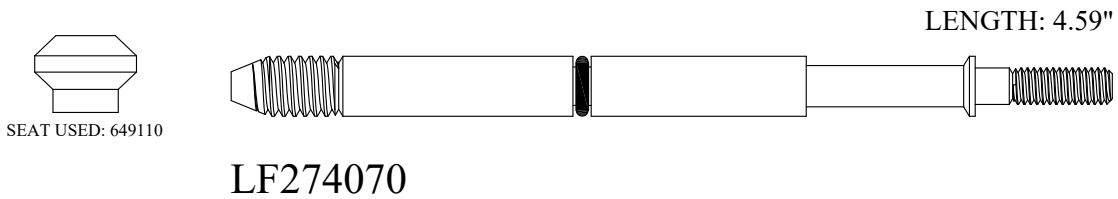
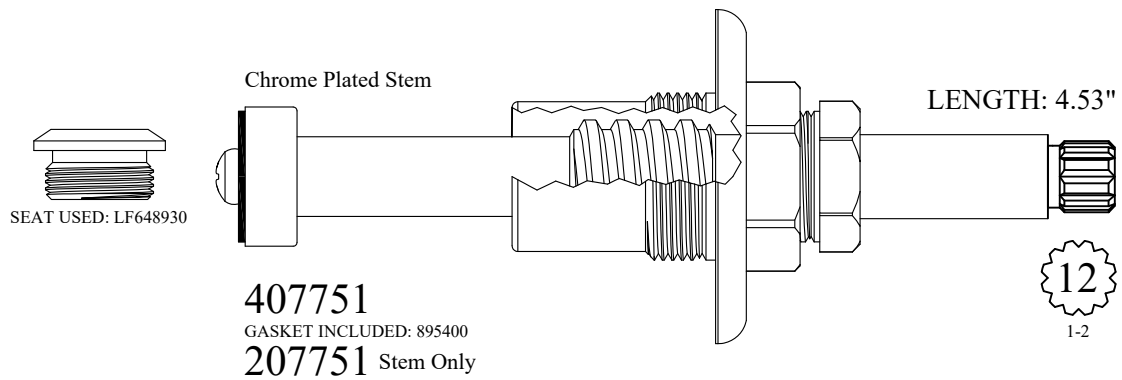
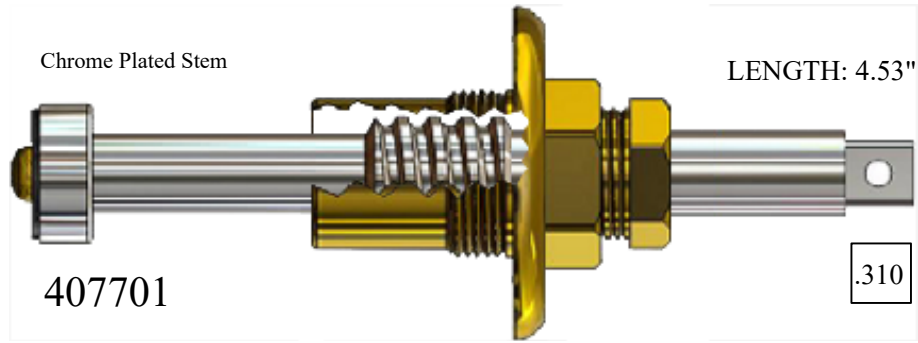

FOR SPEAKMAN

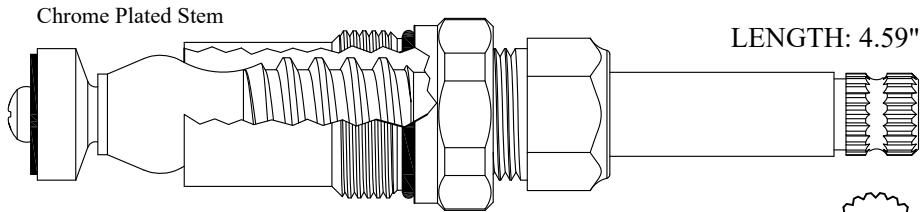
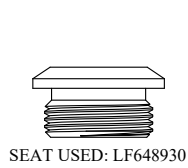

LF475011/ LF475012
GASKET: 890180 O-RING INCLUDED
LF275011/ LF275012 Stem Only

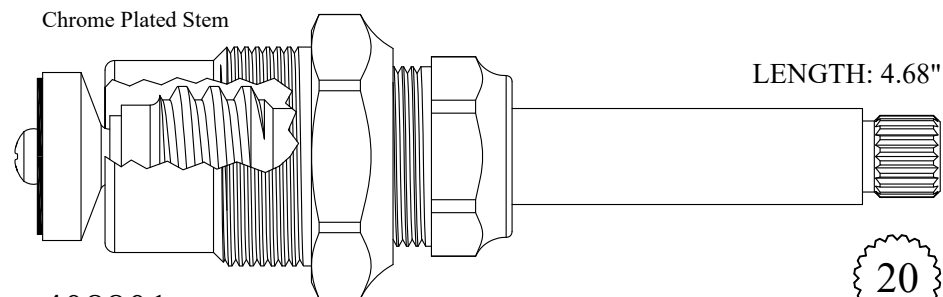
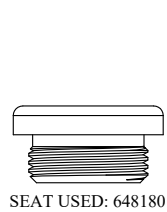

408801
GASKET INCLUDED: 895450
208801 Stem Only

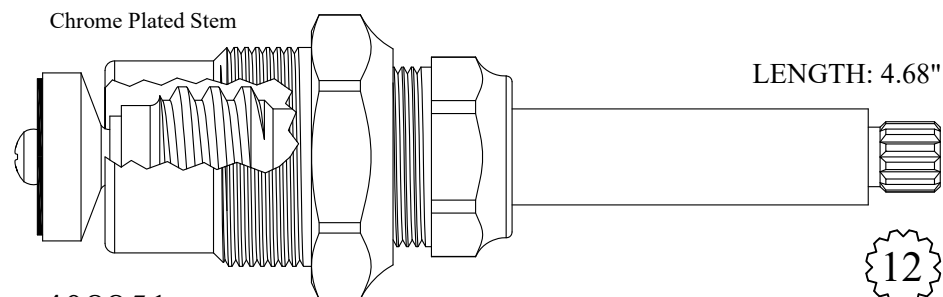
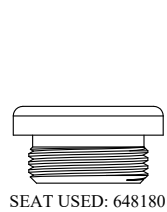

408851
GASKET INCLUDED: 895450
OEM # G05-0162
208851 Stem Only
OEM # G03-0122

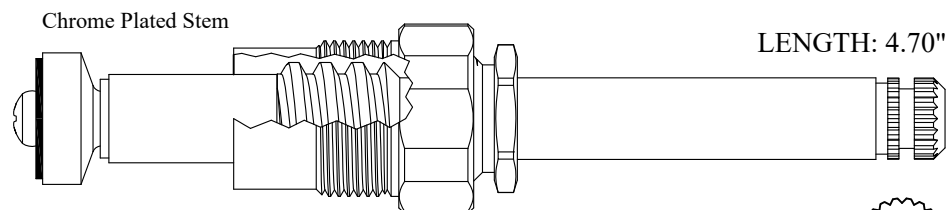
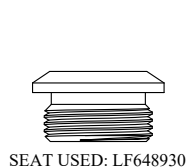

LF475081/ LF475082
GASKET INCLUDED: 895160
LF275081/ LF275082 Stem Only



FOR SPEAKMAN

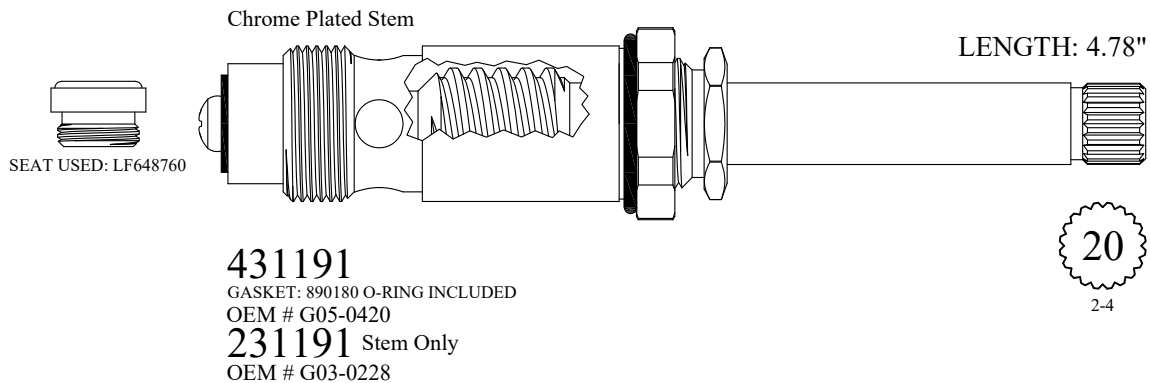
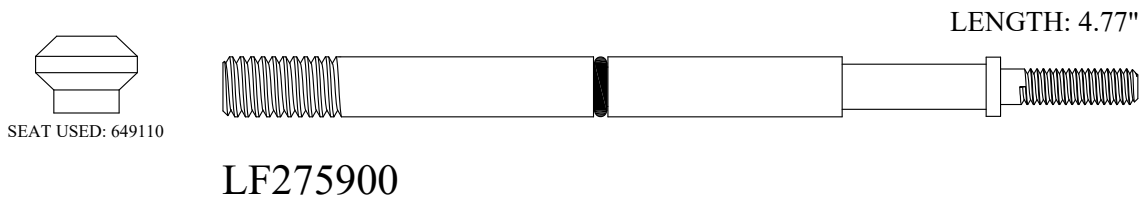
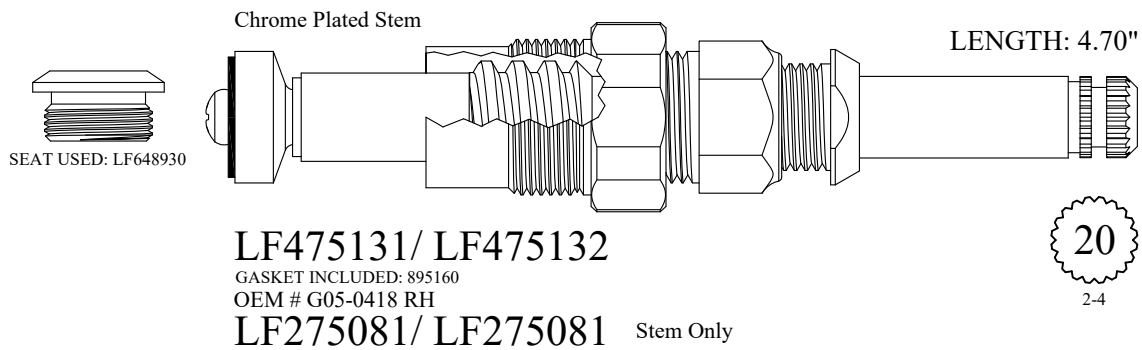
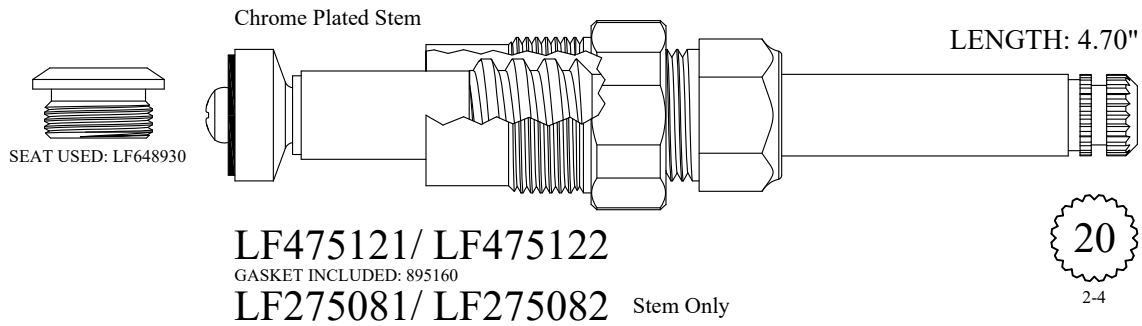

FOR SPEAKMAN

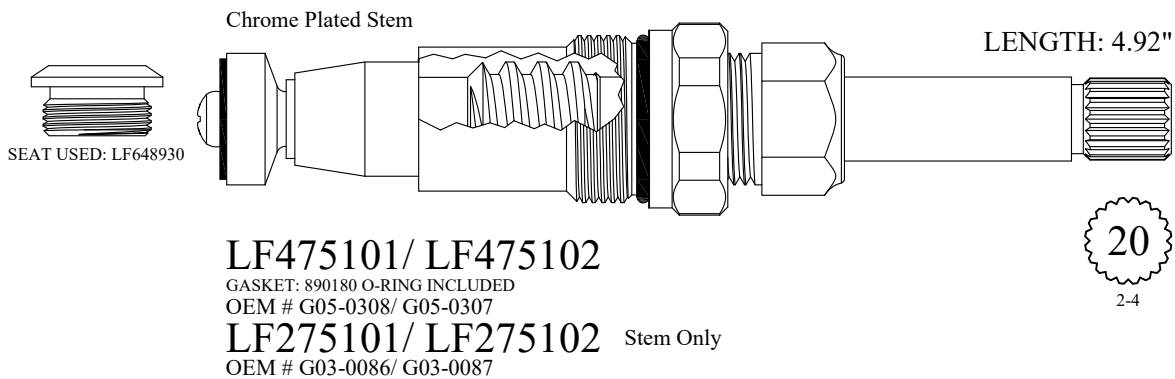
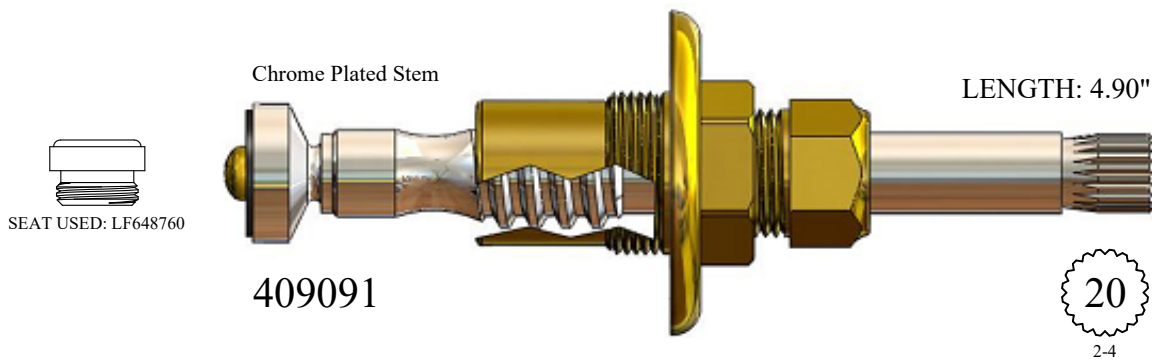
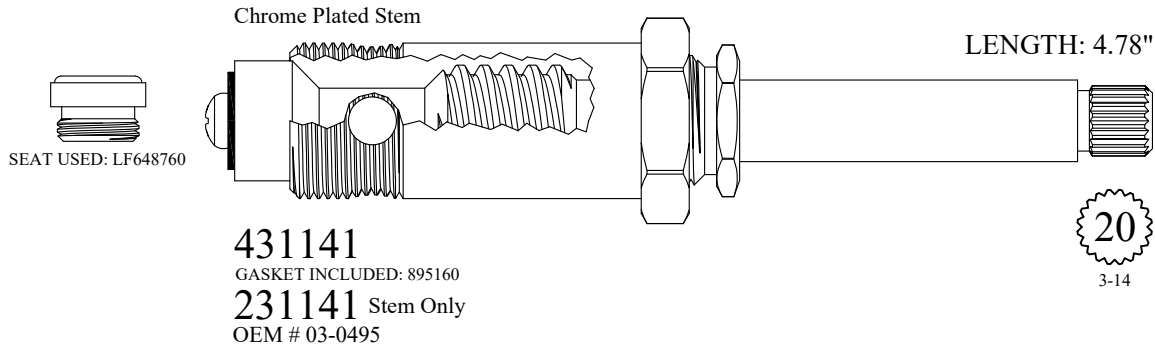

FOR SPEAKMAN

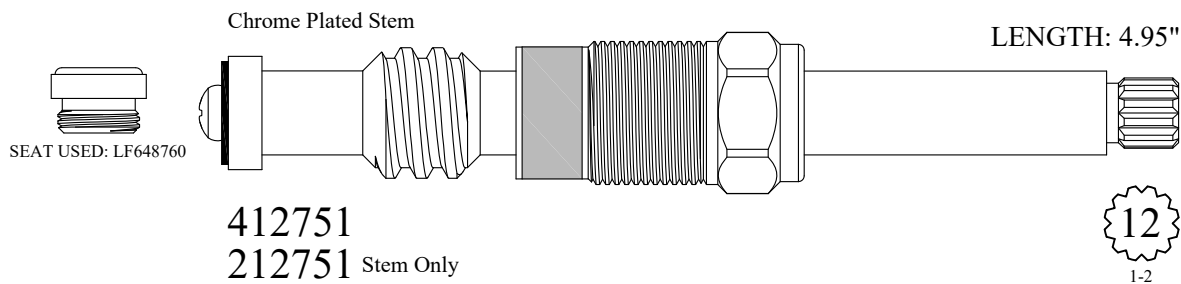
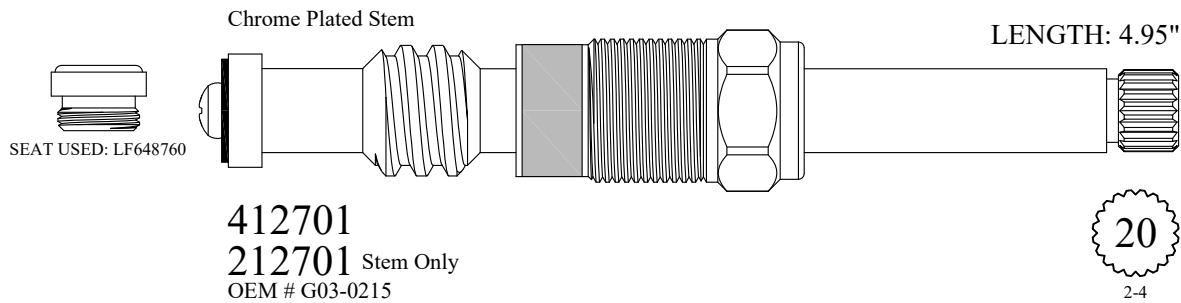
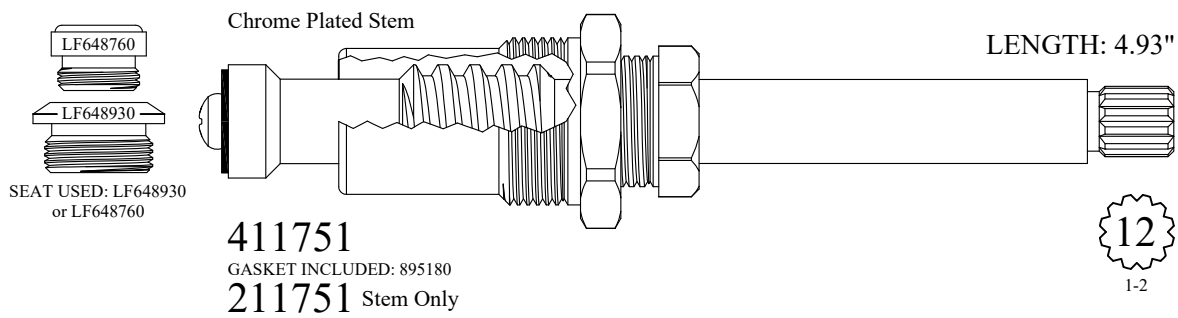
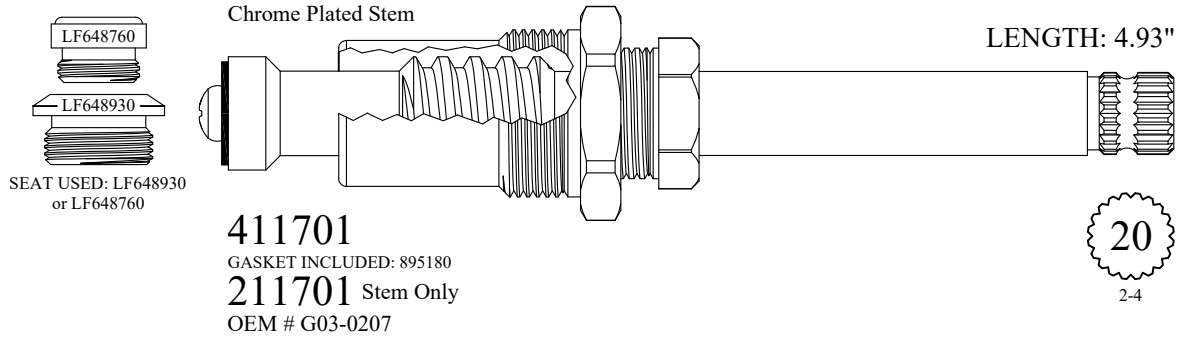

FOR SPEAKMAN

Chrome Plated Stem

SEAT USED: LF648930

LENGTH: 5.00"

431911
GASKET INCLUDED: 895160
231911 Stem Only

20
2-4

Chrome Plated Stem

SEAT USED: LF648930

LENGTH: 5.00"

LF476021/ LF476022
OEM # G05-0270
LF276021/ LF276022 Stem Only

Also available with Brushed Nickel Stem
LF476021-BN/ LF476022-BN
LF276021-BN/ LF276022-BN Stem Only

20
2-4

Chrome Plated Stem

SEAT USED: LF648930
or 648180

LENGTH: 5.05"

414301/ 414302
GASKET INCLUDED: 895570
OEM # G05-0303
214301/ 214302 Stem Only
OEM # G03-0112

20
2-4

Chrome Plated Stem

SEAT USED: LF648930
or 648180

LENGTH: 5.05"

414311
GASKET INCLUDED: 895550
214311 Stem Only

5/16

FOR SPEAKMAN

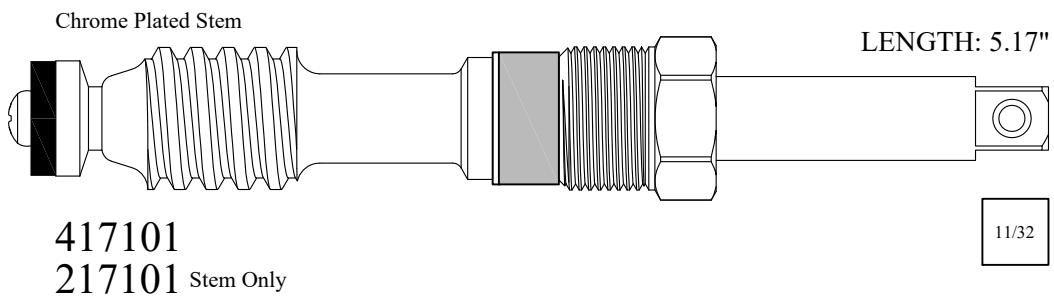
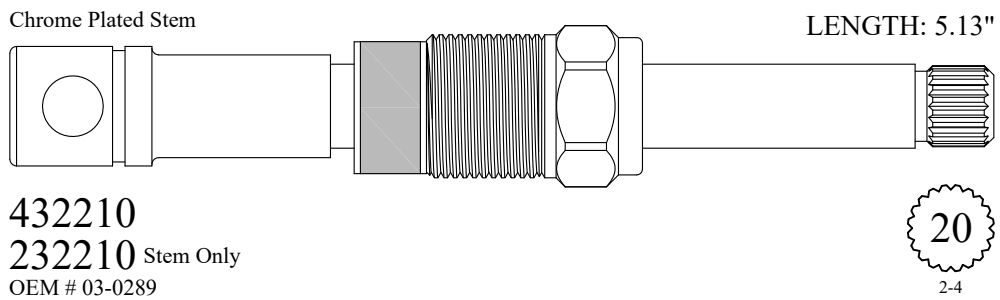
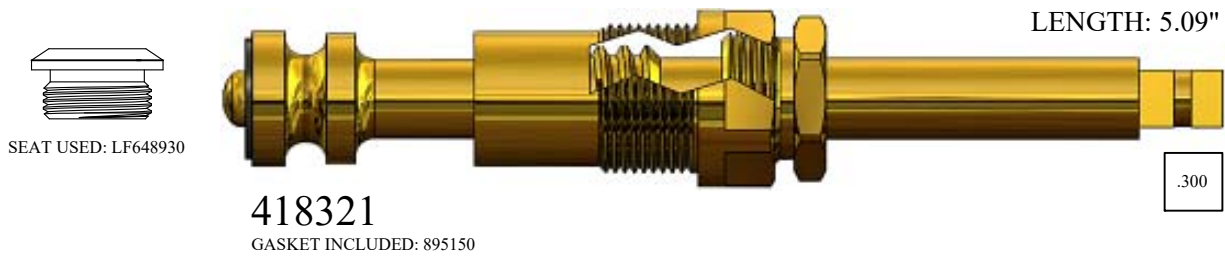
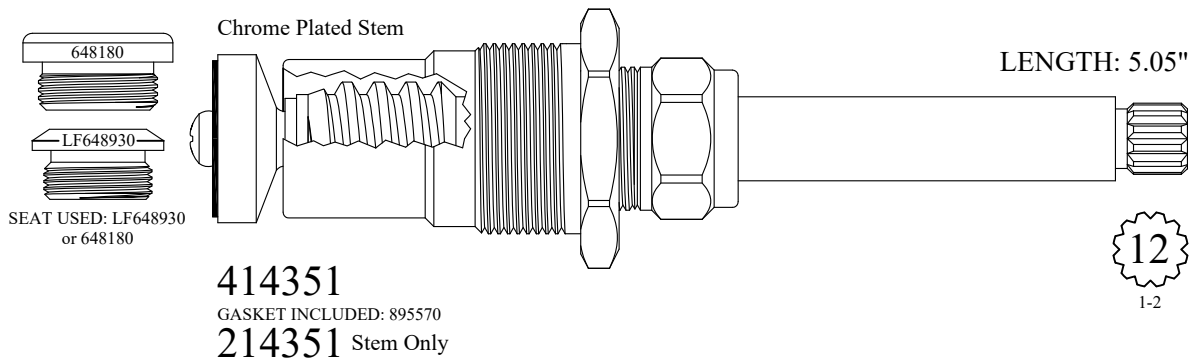

FOR SPEAKMAN

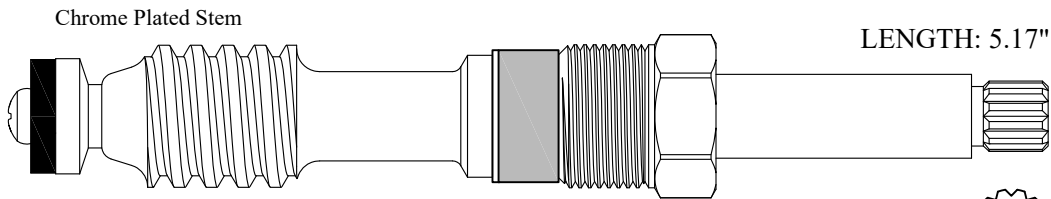

417151
217151 Stem Only

12
1-2

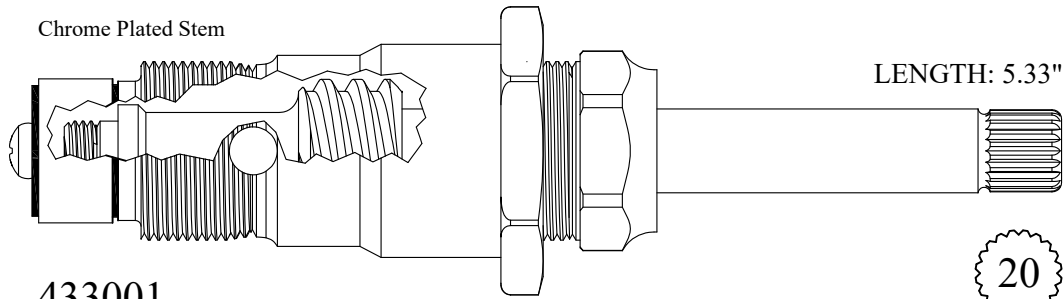

433001
GASKET INCLUDED: 895450
233001 Stem Only

20
2-4

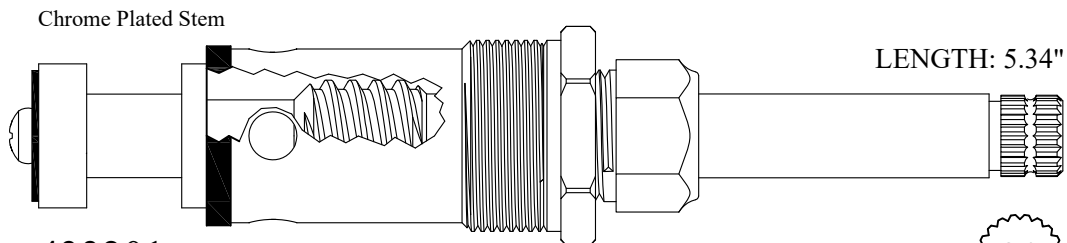

433201
OEM # G05-0305
233201 Stem Only
OEM # G03-0167

20
2-4

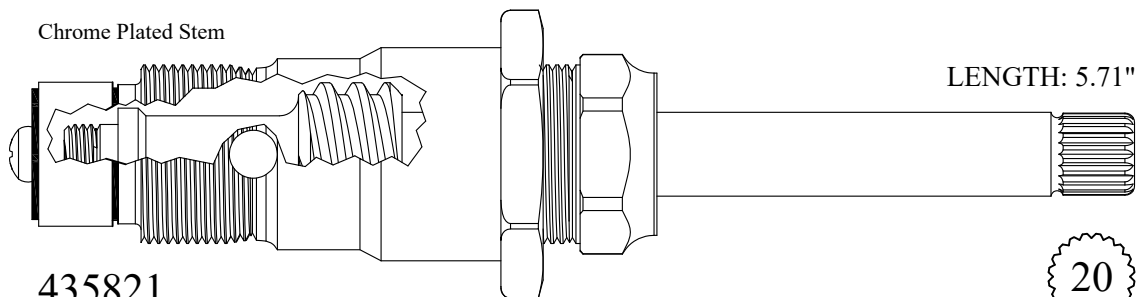

435821
GASKET INCLUDED: 895450
235821 Stem Only
OEM # 03-0232

20
2-4

FOR SPEAKMAN

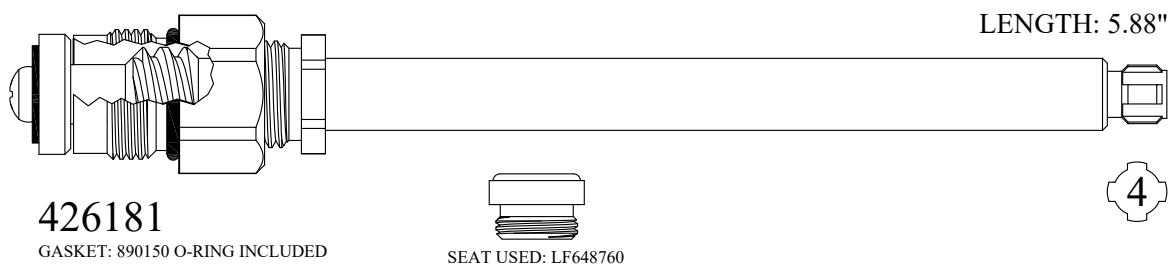
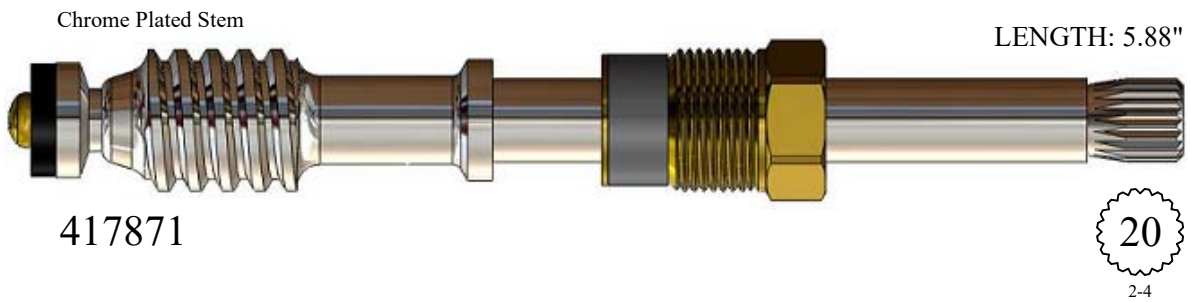
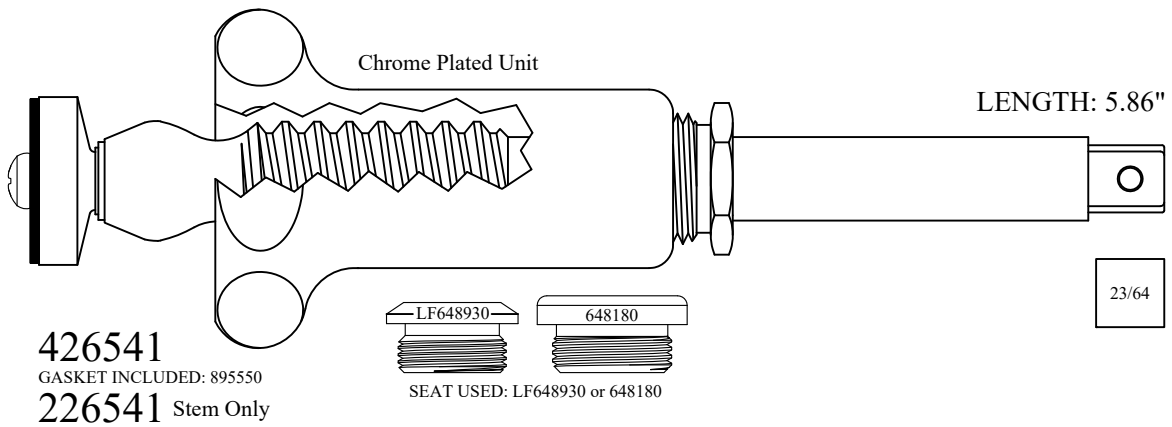
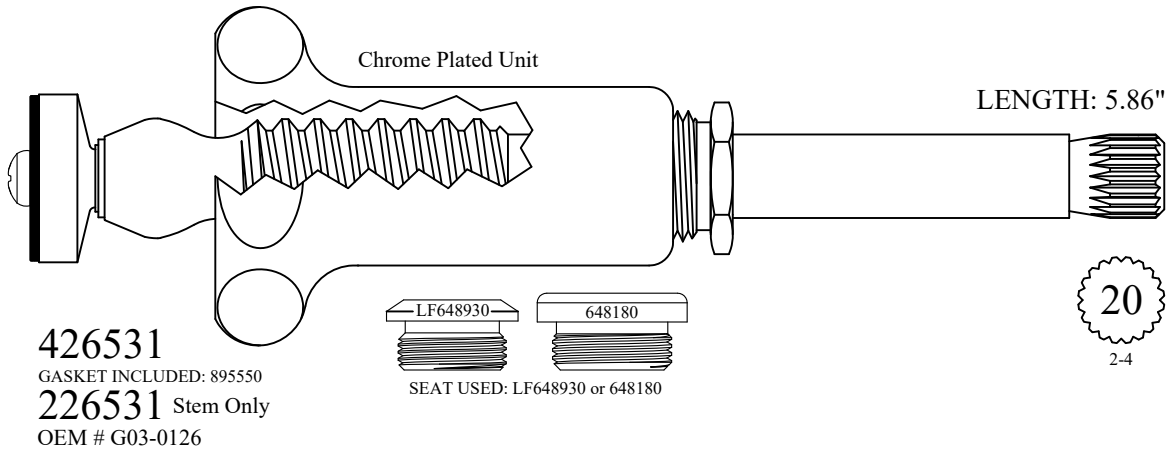

FOR SPEAKMAN

Chrome Plated Stem

LENGTH: 5.99"

426021/ 426022
GASKET INCLUDED: 895550
226021/ 226022 Stem Only

LF648930 648180

SEAT USED: LF648930 or 648180

20
2-4

Chrome Plated Stem

LENGTH: 5.99"

426041
GASKET INCLUDED: 895550
226041 Stem Only

LF648930 648180

SEAT USED: LF648930 or 648180

5/16

LENGTH: 6.18"

438821
GASKET: 890150 O-RING INCLUDED

SEAT USED: LF648760

4

Chrome Plated Stem

LENGTH: 6.57"

439211
GASKET INCLUDED: 895450
239211 Stem Only

20
2-4

FOR SPEAKMAN

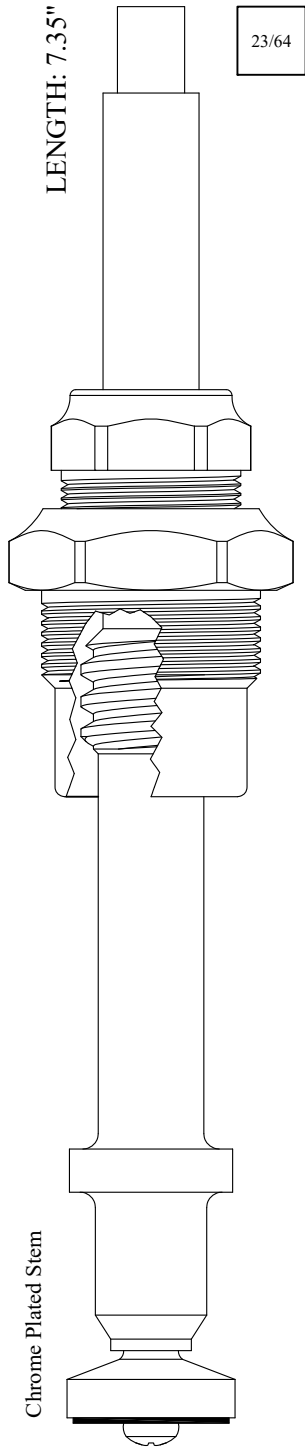

GASKET INCLUDED: 895450

428321
228321 Stem Only

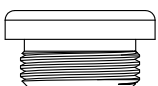

SEAT USED: 648180



LF480321

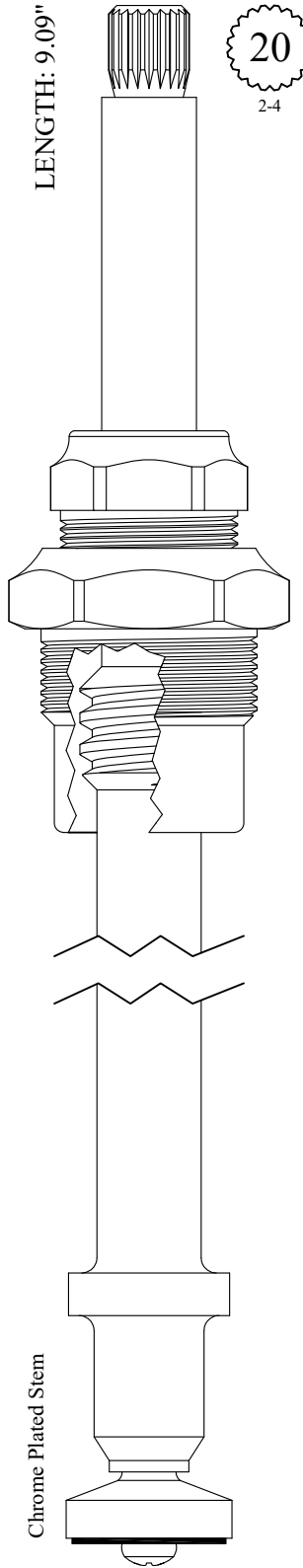

GASKET INCLUDED: 895450

428341
228341 Stem Only

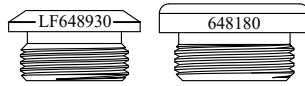

SEAT USED: LF648930 or 648180

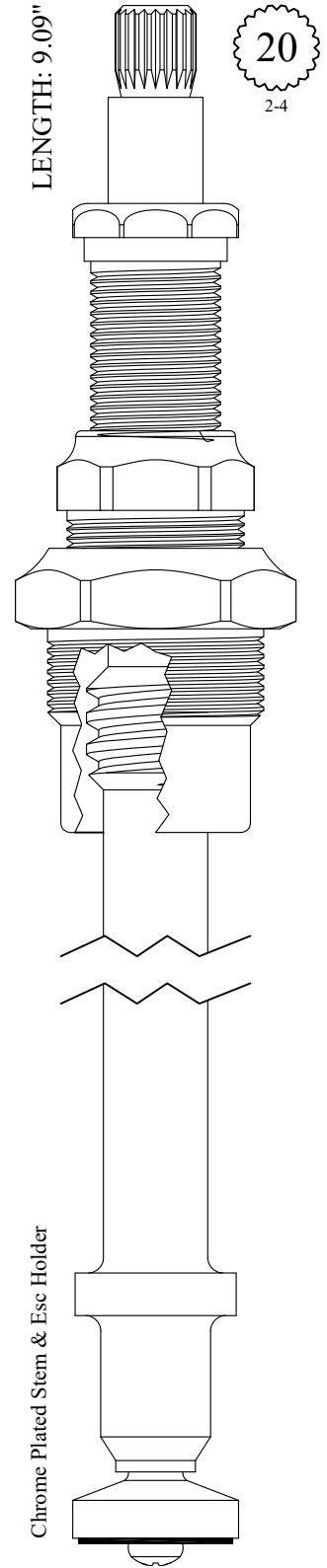

GASKET INCLUDED: 895450

428421
228421 Stem Only

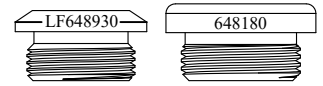

SEAT USED: LF648930 or 648180

FOR SPHINX



SEAT USED: LF649520

Chrome Plated Stem

LENGTH: 3.90"

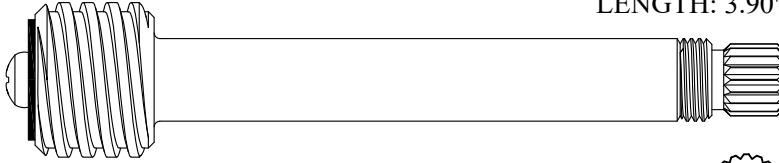

202221/ 202222

18
3-3

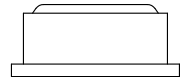

SEAT USED: LF649520

Chrome Plated Stem

LENGTH: 3.90"

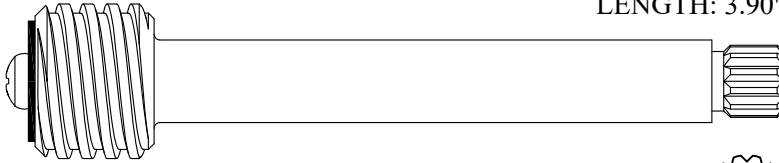

202271/ 202272

12
1-2

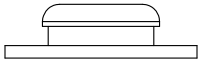

SEAT USED: LF649510

Chrome Plated Handle

LENGTH: 4.35"

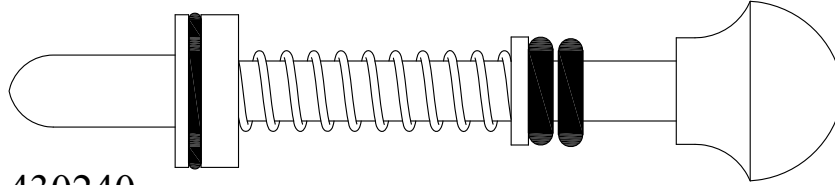

430240

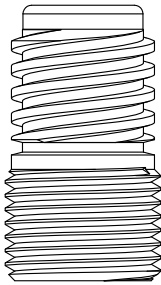

SEAT USED:
LF647941 FOR 416361
LF647942 FOR 416362

Chrome Plated Unit

LENGTH: 5.19"

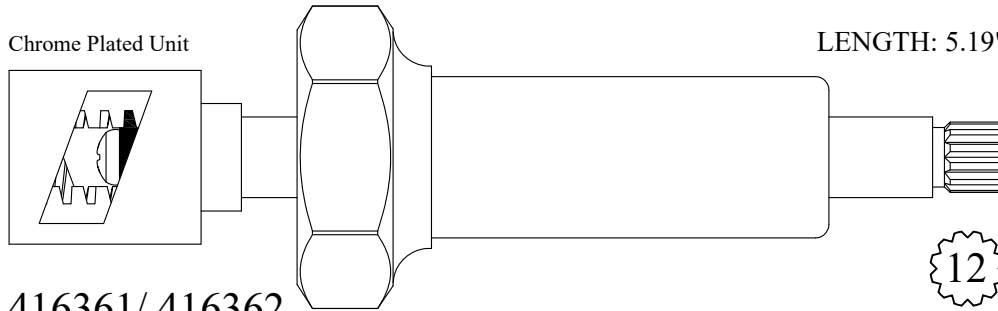

416361/ 416362
216361/ 216362 Stem Only

12
1-2

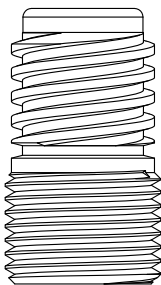

SEAT USED:
LF647941 FOR 416361
LF647942 FOR 416362

Chrome Plated Unit

LENGTH: 5.84"

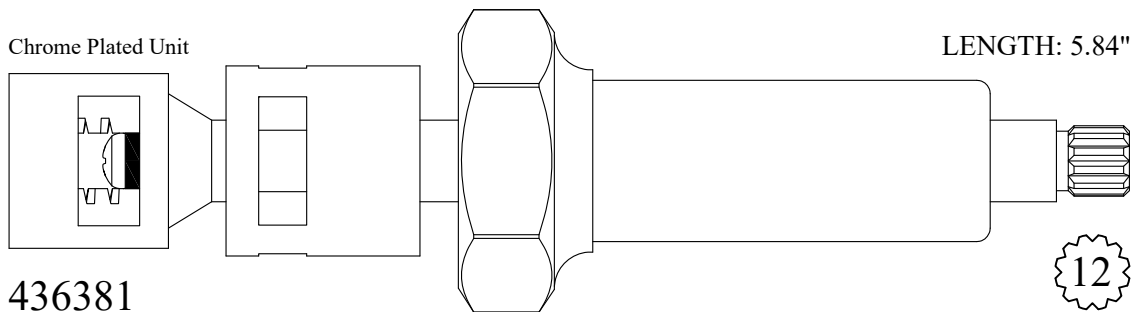

436381
236381 Stem Only

12
1-2

FOR STANDARD SANITARY

SPECIAL ORDER ONLY
Many different variations
available

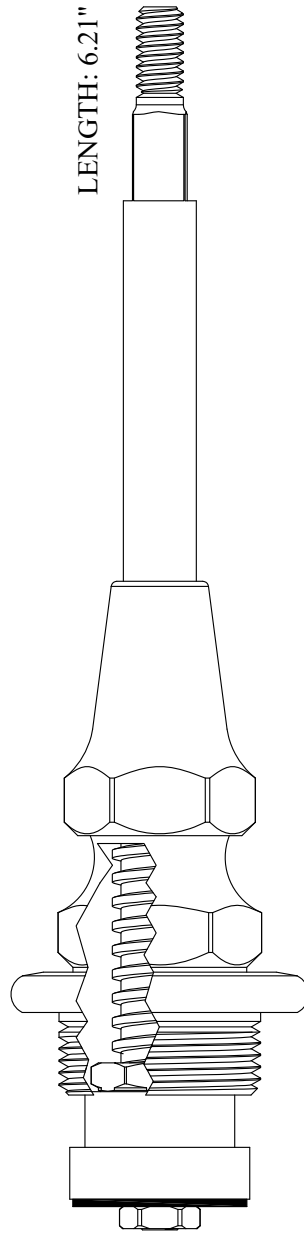
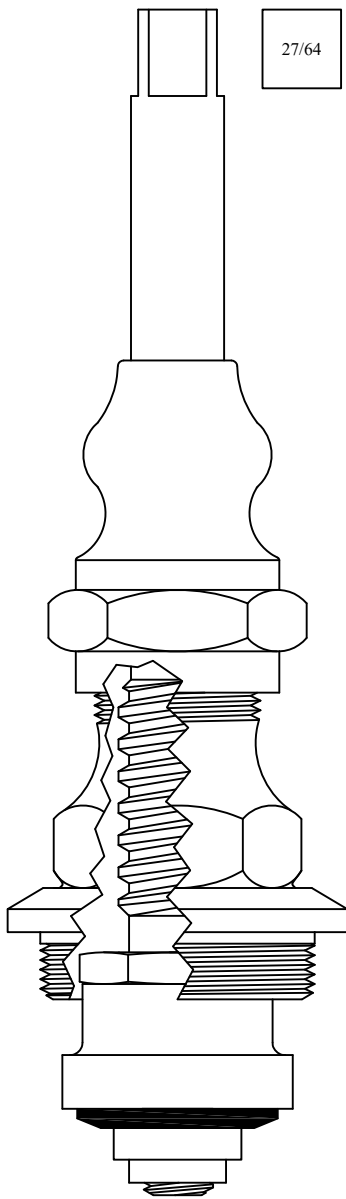

GASKET INCLUDED: 895440

427111

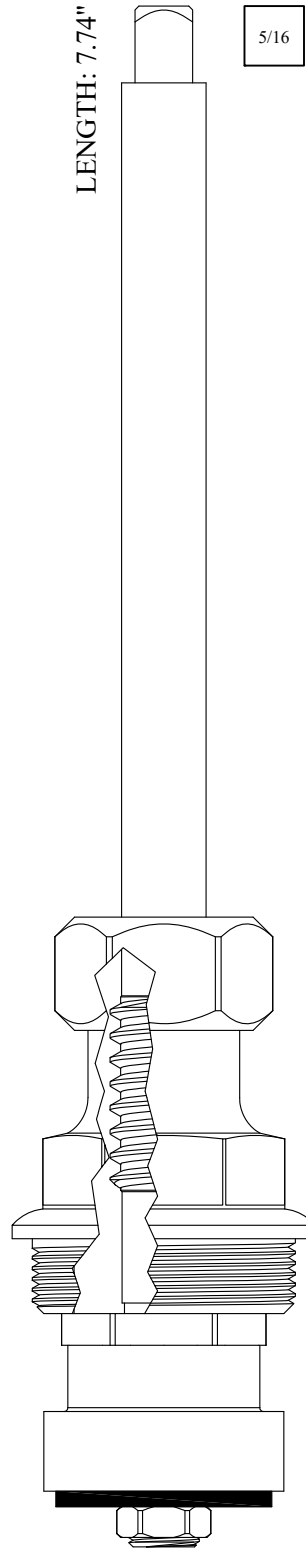

GASKET INCLUDED: 895500

427801

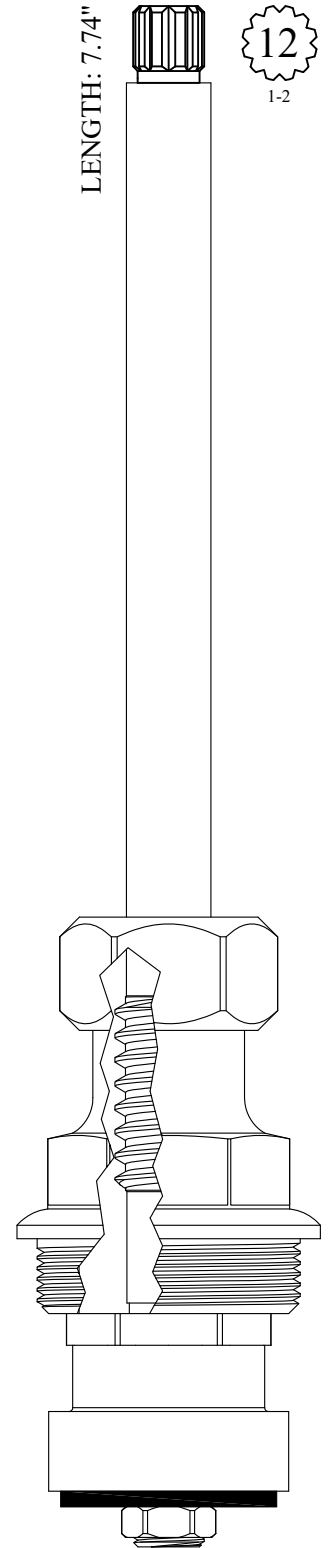

GASKET INCLUDED: 895500

427851

FOR STERLING BRASS

Chrome Plated Stem

LENGTH: 2.40"

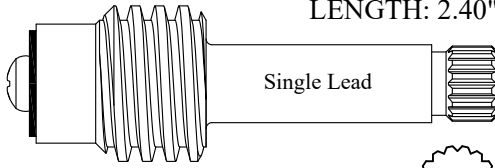

LF263511



Chrome Plated Stem

LENGTH: 2.40"

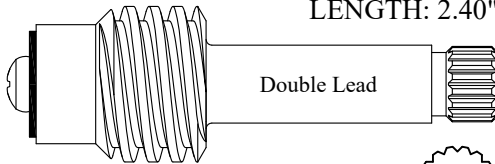

LF263521/ LF463522



Chrome Plated Stem

LENGTH: 3.99"

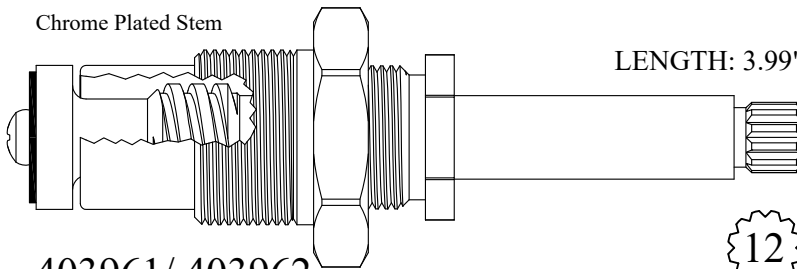

403961/ 403962

GASKET INCLUDED: 895370

203961/ 203962 Stem Only



Chrome Plated Unit

LENGTH: 4.65"

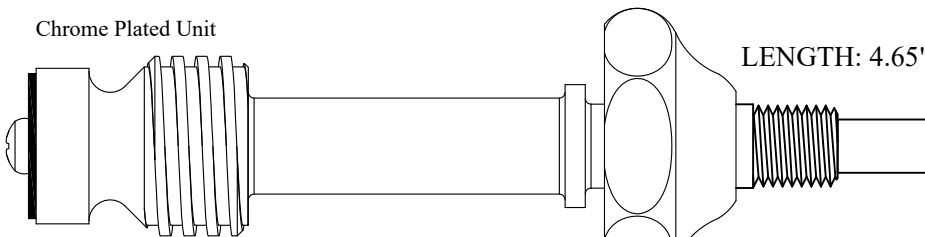

415151

215151 Stem Only

Supplied with
12pt. Broach

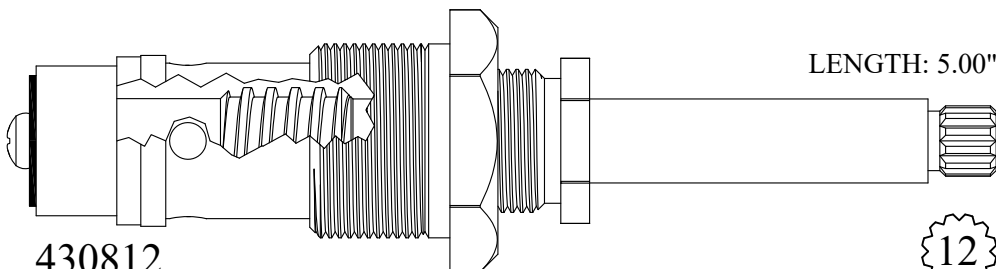

430812

GASKET INCLUDED: 895430

LENGTH: 5.00"



FOR STERLING BRASS

SEAT USED: LF649010

Chrome Plated Stem

LENGTH: 5.19"

416951/ 416952
GASKET INCLUDED: 895370
216951/ 216952 Stem Only

Supplied with 12pt. Broach

12
1-2

SEAT USED: LF649010

Chrome Plated Stem

LENGTH: 5.22"

419051
GASKET INCLUDED: 895370
219051 Stem Only

Supplied with 12pt. Broach

12
1-2

SEAT USED: LF649010

Chrome Plated Stem

LENGTH: 5.37"

419001
GASKET INCLUDED: 895370
219001 Stem Only

7/16 - 20 TPI

12
1-2

Chrome Plated Stem

LENGTH: 5.48"

426151
226151 Stem Only

Supplied with 12pt. Broach

12
1-2

FOR STERLING BRASS

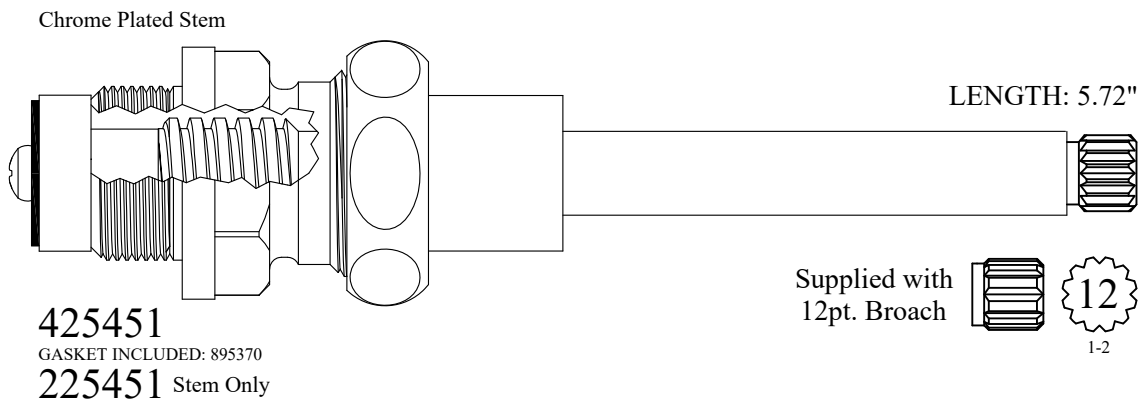
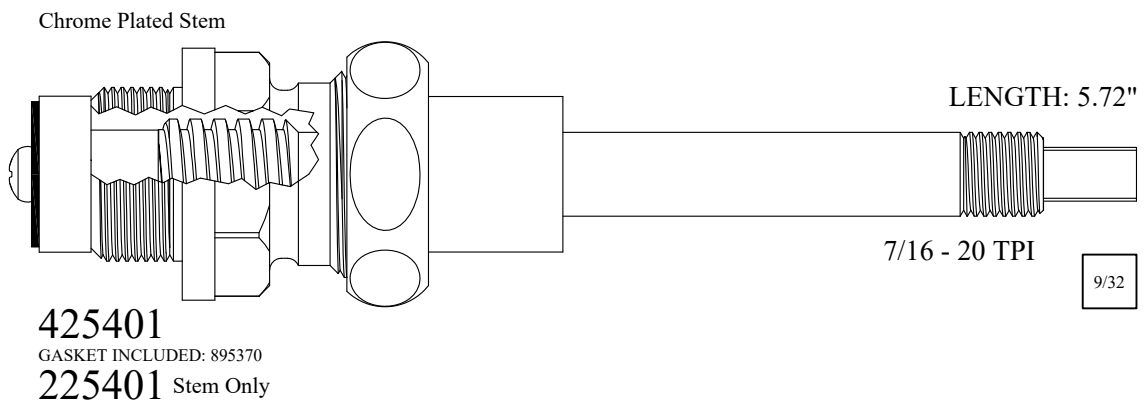
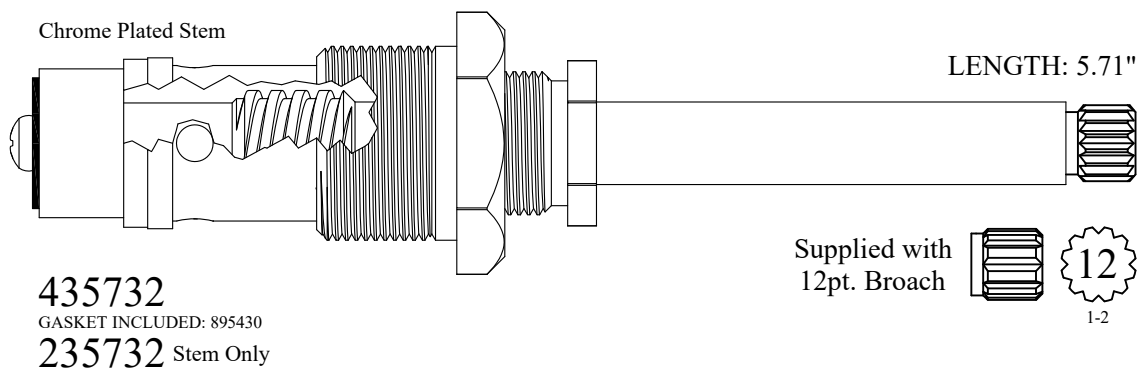
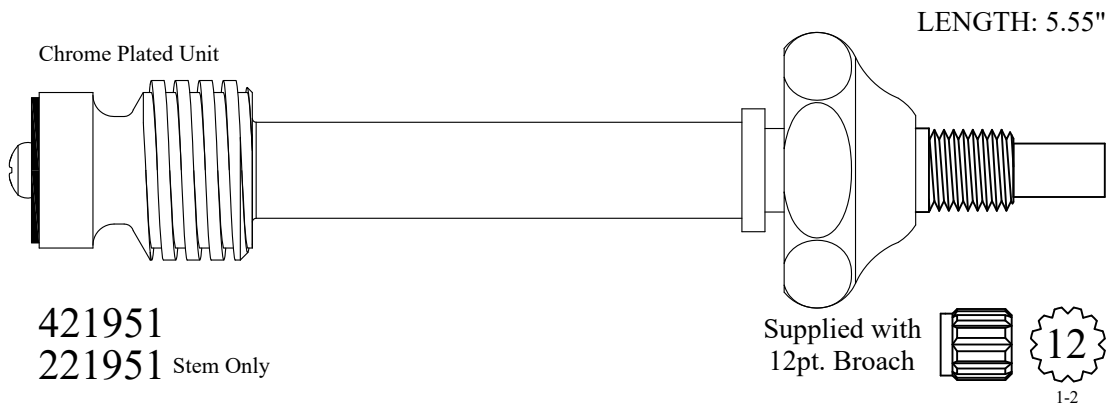

FOR STERLING BRASS

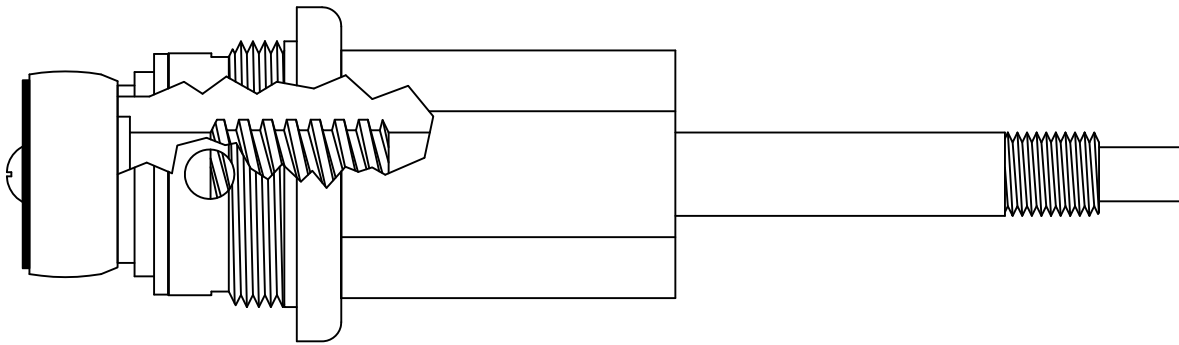
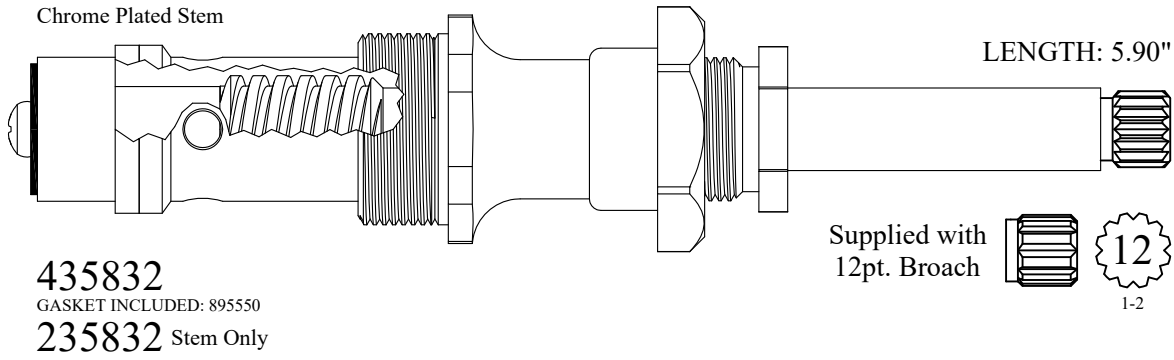

Not Available, Use 438101

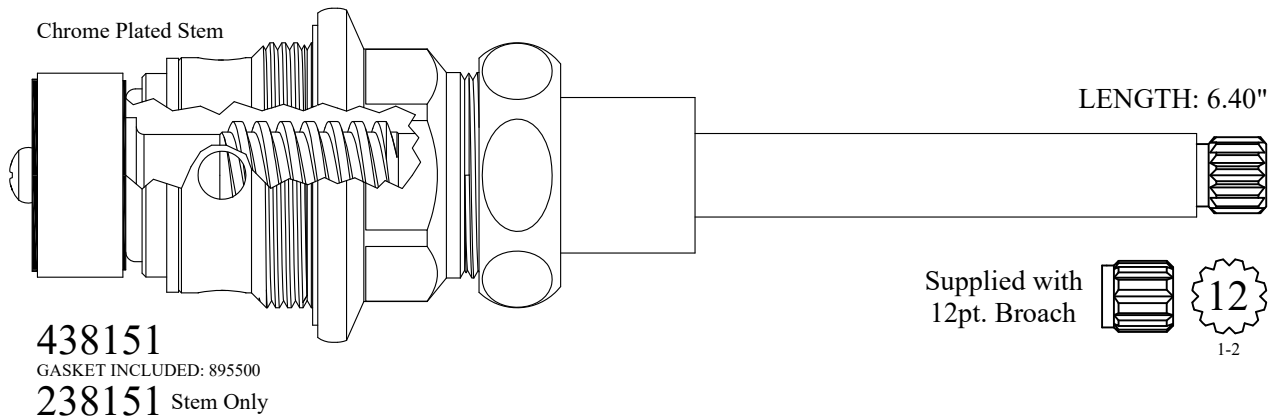
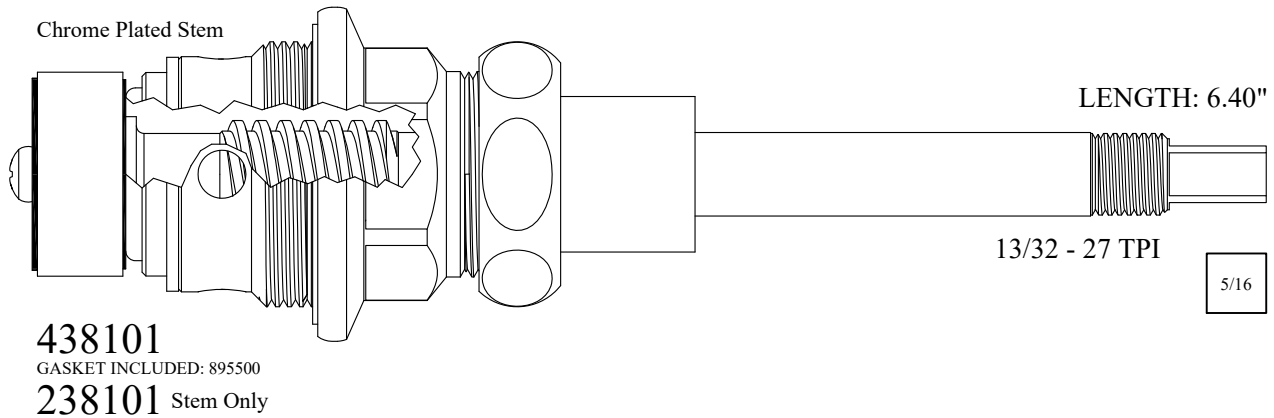

FOR STERLING FAUCET



LENGTH: 1.21"

400851

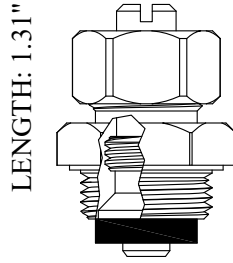

LENGTH: 1.31"

GASKET INCLUDED: 895110

400181

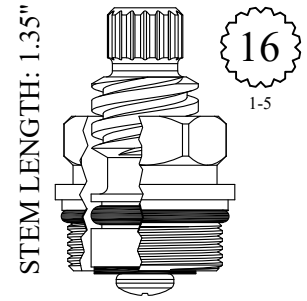

STEM LENGTH: 1.35"

GASKET: 890180 O-RING INCLUDED

LF450401
LF450402

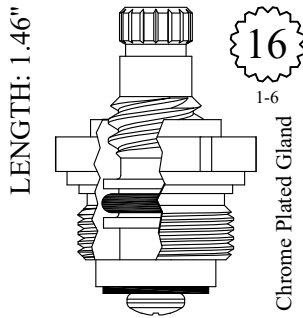

LENGTH: 1.46"

400511
OEM # A8109
400512
OEM # A8110



SEAT USED: LF648170

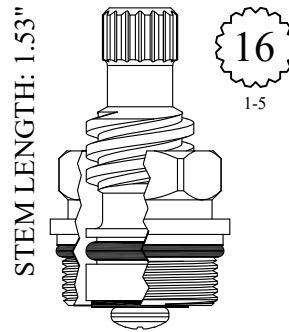

STEM LENGTH: 1.53"

GASKET: 890180 O-RING INCLUDED

LF451401
LF451402

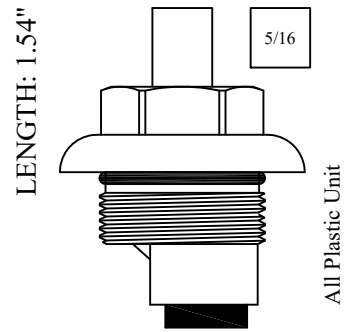

LENGTH: 1.54"

GASKET: 890180 O-RING INCLUDED

452290

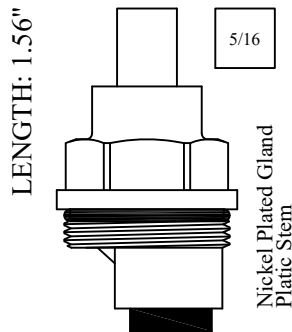

LENGTH: 1.56"

GASKET: 890180 O-RING INCLUDED

LF452300
OEM # 99B0796
252300 Stem Only

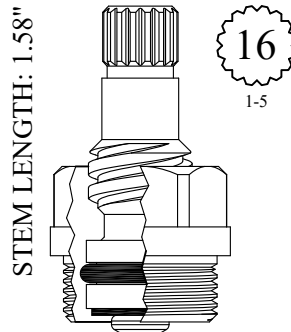

STEM LENGTH: 1.58"

GASKET INCLUDED: 895160

LF452091
OEM # A8079
LF452092
OEM # A8080



SEAT USED: LF648170

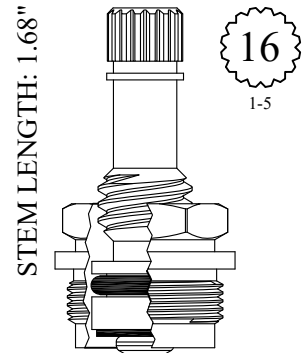

STEM LENGTH: 1.68"

GASKET INCLUDED: 895160

LF452951
OEM # A2698
LF452952
OEM # A2699



SEAT USED: LF648170

FOR STERLING FAUCET

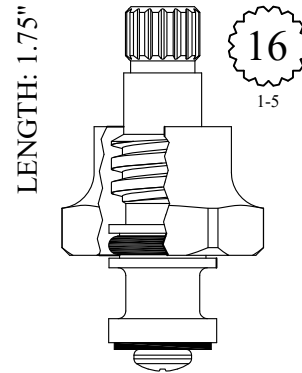
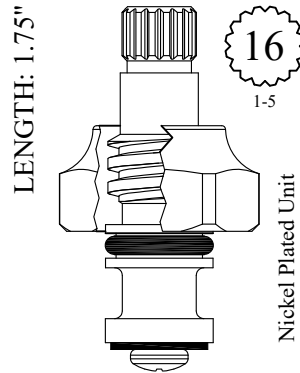
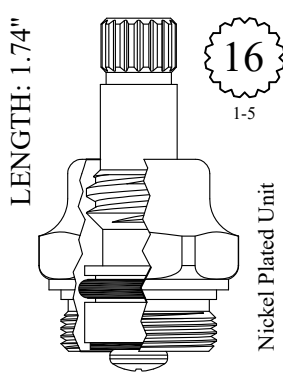
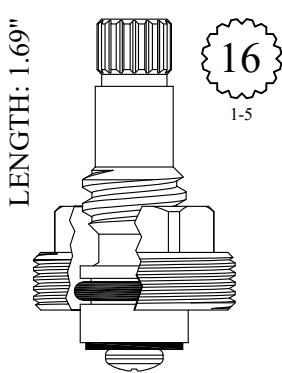

Also available as nickel plated unit
LF454111/ LF454112

GASKET INCLUDED: 895160

400711
 OEM # A1868
400712
 OEM # A1869

LF455131
 OEM # A8282
LF455132

LF454161
 OEM # A8171
LF454162
 OEM # A8172

454241
 OEM # A8358
454242
 OEM # A8359

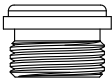

SEAT USED: LF648170

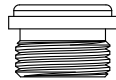

SEAT USED: LF648170

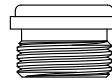

SEAT USED: LF648170

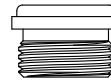

SEAT USED: LF648170

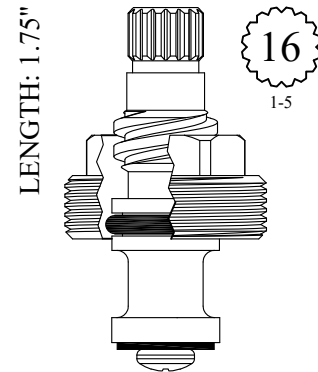
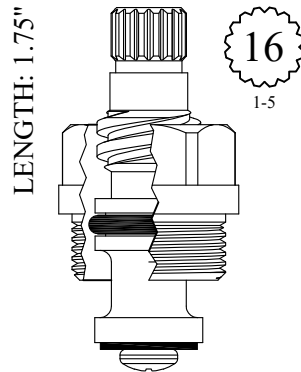
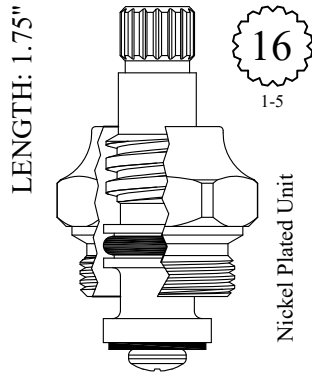

GASKET INCLUDED: 895160

GASKET INCLUDED: 895160

LF455031
 OEM # A8114
LF455032

LF455051
 OEM # A8062
LF455052
 OEM # A8063

LF455071
 OEM # A8125
LF455072
 OEM # A8126



SEAT USED: LF648170



SEAT USED: LF648170



SEAT USED: LF648170

FOR STERLING FAUCET

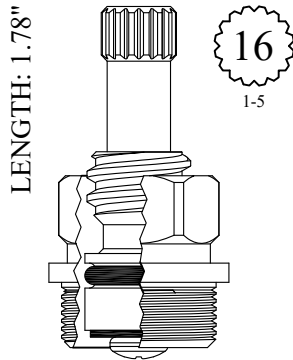

GASKET INCLUDED: 895160

LF453081
OEM # A8153
LF453082
OEM # A8154

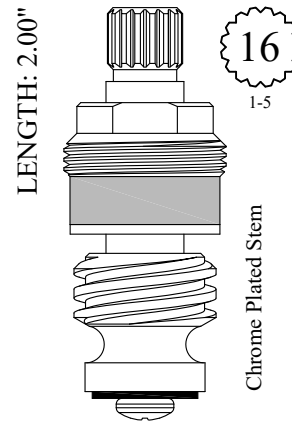

LF458091
LF458092
LF258091 Stem Only
LF458092 Stem Only

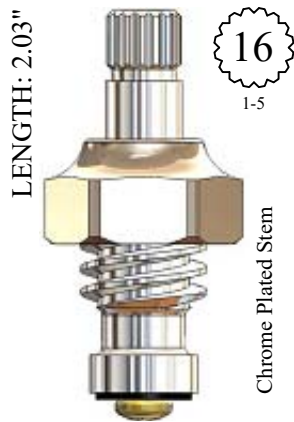

LF459071
LF459072
LF259071 Stem Only
LF259072 Stem Only

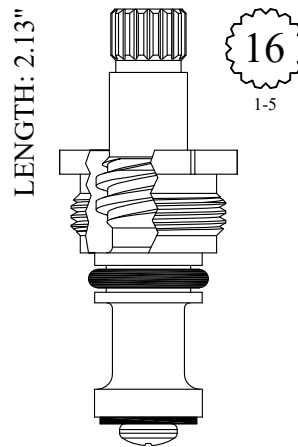
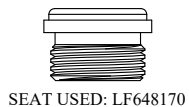

LF460101
LF460102

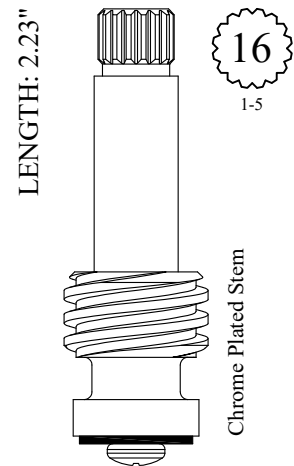

LF261051
OEM # 99S0064
LF261052



FOR STERLING FAUCET

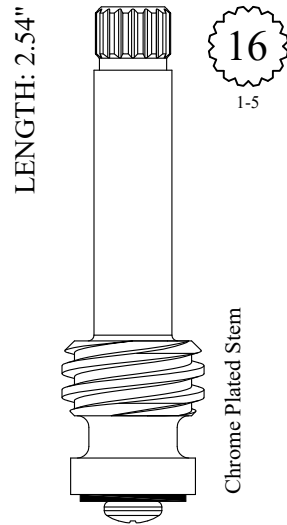
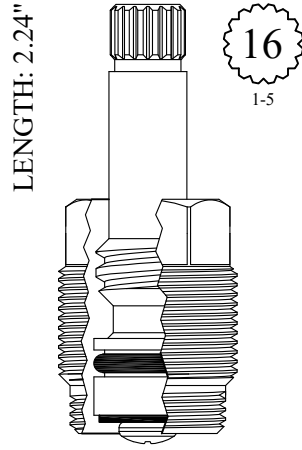

GASKET INCLUDED: 895160

401111 [IMPORT VERSION](#)
 OEM # A8133 [SL11965](#)
 401112
 OEM # A8132

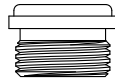

SEAT USED: LF648170

LF265011
 LF265012

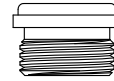

SEAT USED: LF648170

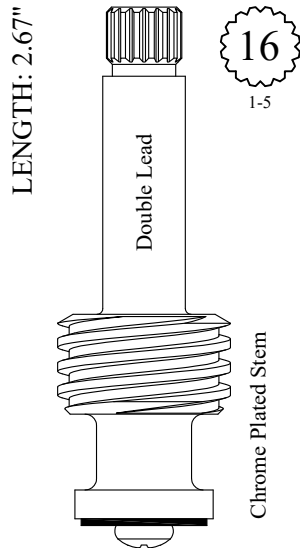

LF264861
 LF264862

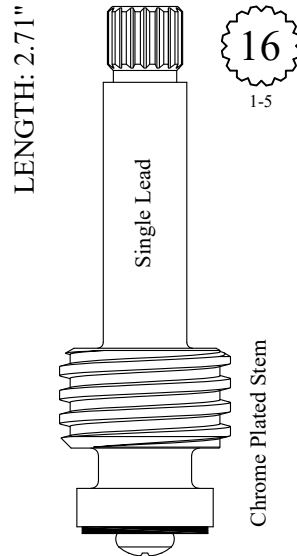

LF264871
 LF264872

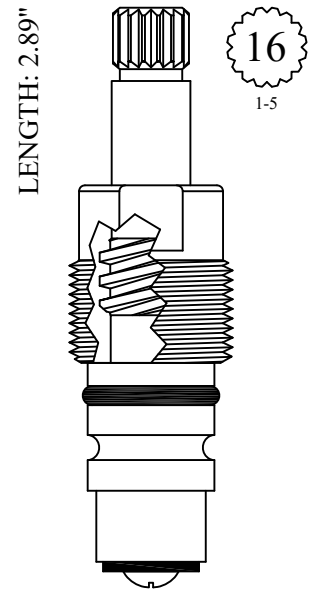

LF465621
 LF465622

FOR STERLING FAUCET

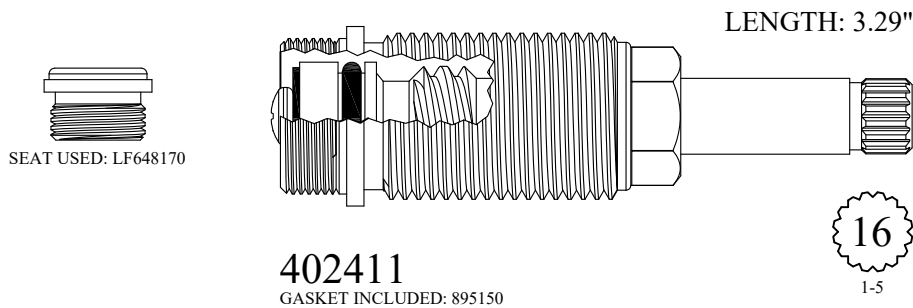
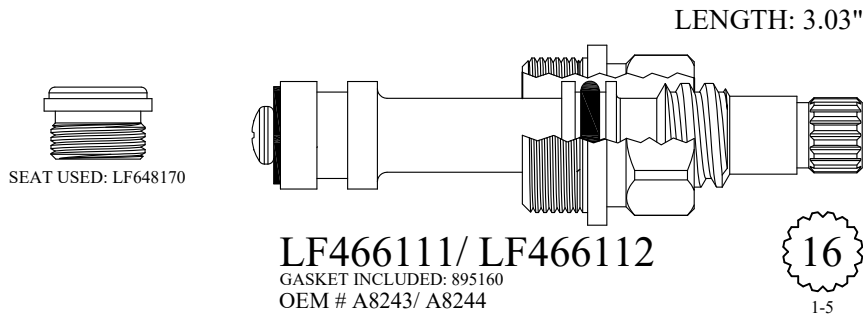
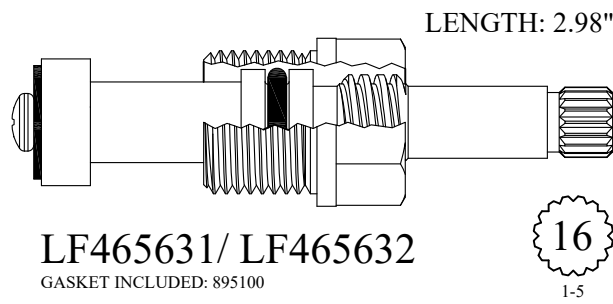
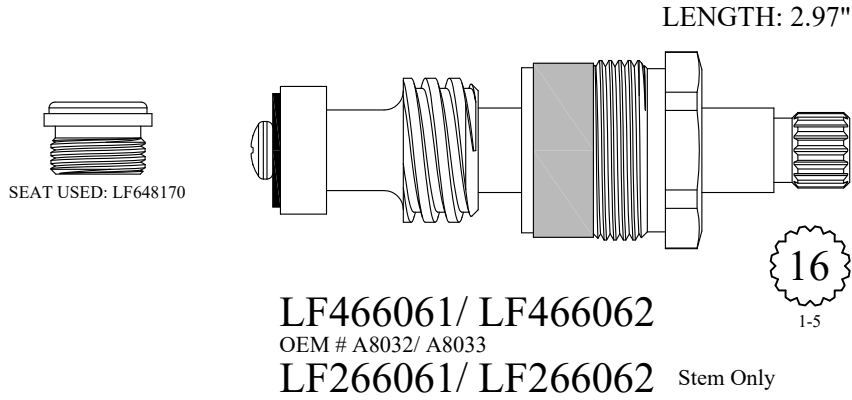

FOR STERLING FAUCET

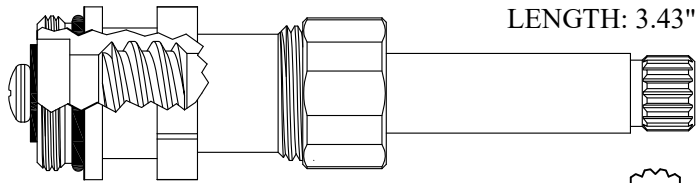

402821
GASKET: 890170 O-RING INCLUDED
OEM # A1656

16
1-5

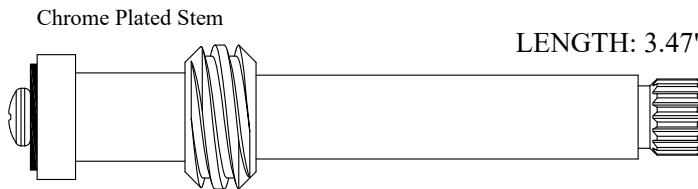

LF268161/ LF268162
OEM # 99S0235

16
1-5

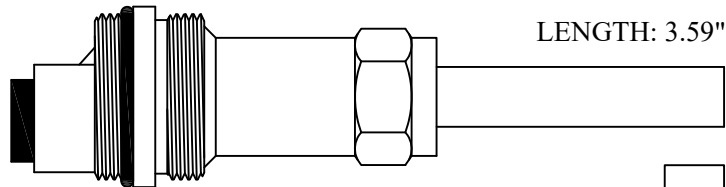

403220
203220 Stem Only
GASKET: 890190 O-RING INCLUDED

5/16



SL21995

5/16

FOR STERLING FAUCET

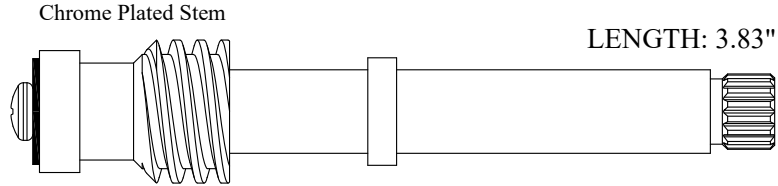

LF269041/ LF269042
OEM # 99S0160

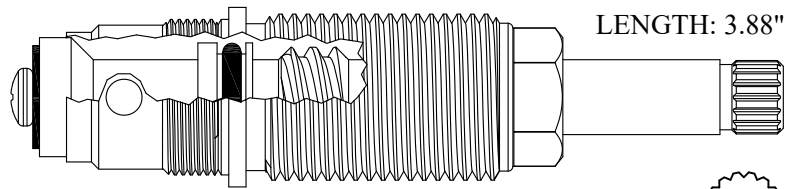

430181
GASKET INCLUDED: 895150

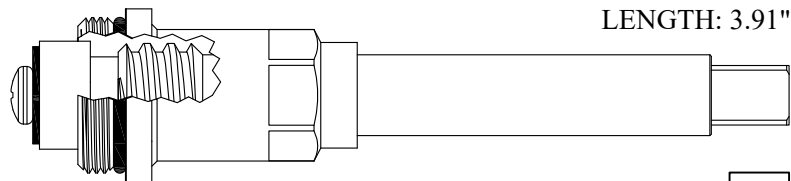

403931/ 403932
GASKET: 890170 O-RING INCLUDED
OEM # A2614

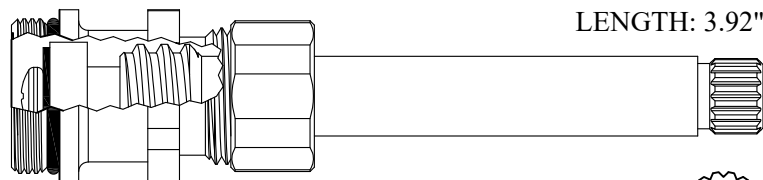
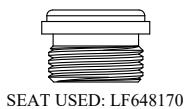

403331
GASKET: 890170 O-RING INCLUDED
OEM # A1656



FOR STERLING FAUCET

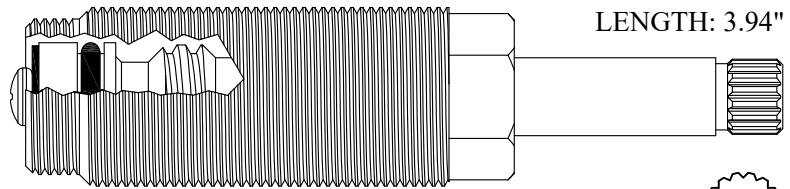

403511/ 403512
GASKET INCLUDED: 895150

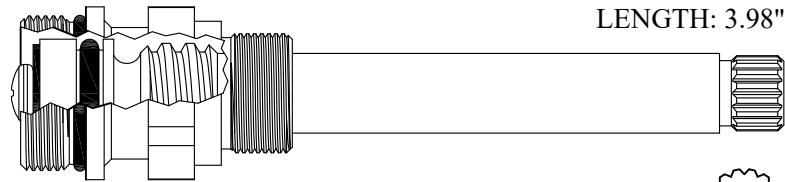

403921
GASKET: 890170 O-RING INCLUDED

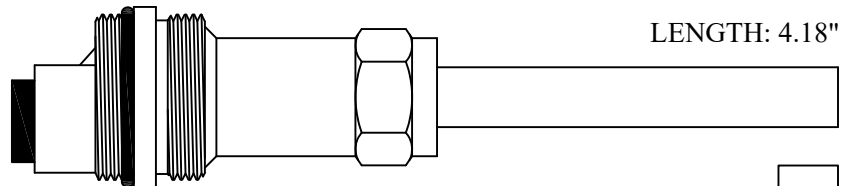

404810
204810 Stem Only
GASKET: 890190 O-RING INCLUDED



404890
GASKET: 890190 O-RING INCLUDED

IMPORT VERSION
SL21994



FOR STERLING FAUCET

LENGTH: 4.30"



SEAT USED: LF648170

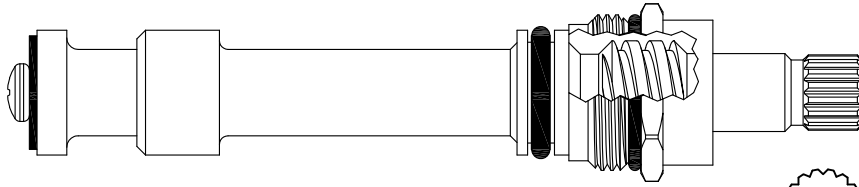

LF471001/ LF471002

GASKET: 890170 O-RING INCLUDED
OEM # A8136

16
1-5

LENGTH: 4.35"



SEAT USED: LF648170

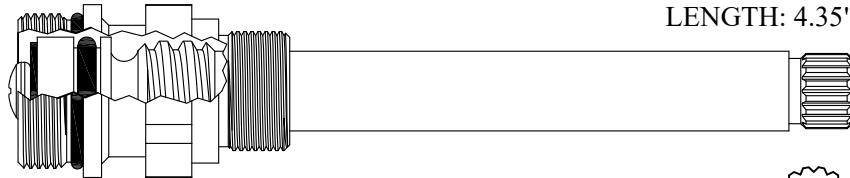

405181

GASKET: 890170 O-RING INCLUDED
OEM # 00A2361

IMPORT VERSION
SL21986

16
1-5

LENGTH: 4.38"

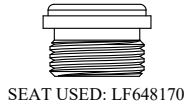

SEAT USED: LF648170

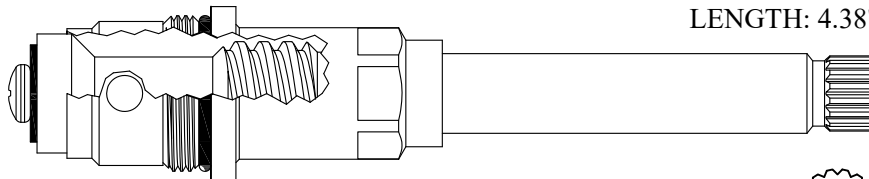

430231

GASKET: 890170 O-RING INCLUDED
OEM # A1657

16
1-5

LENGTH: 4.38"

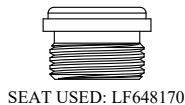

SEAT USED: LF648170

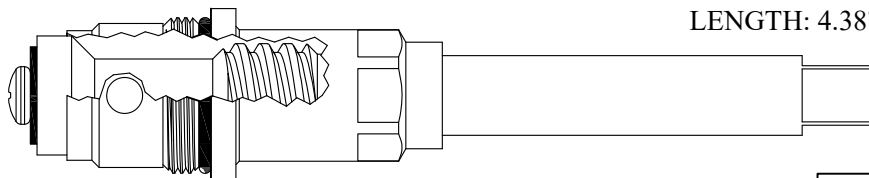

430261

GASKET: 890170 O-RING INCLUDED
OEM # 00A2064

5/16

FOR STERLING FAUCET

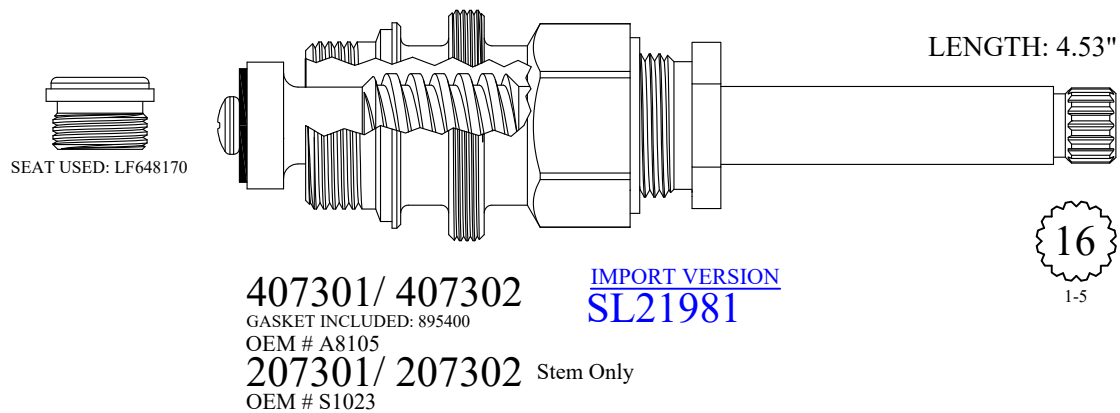
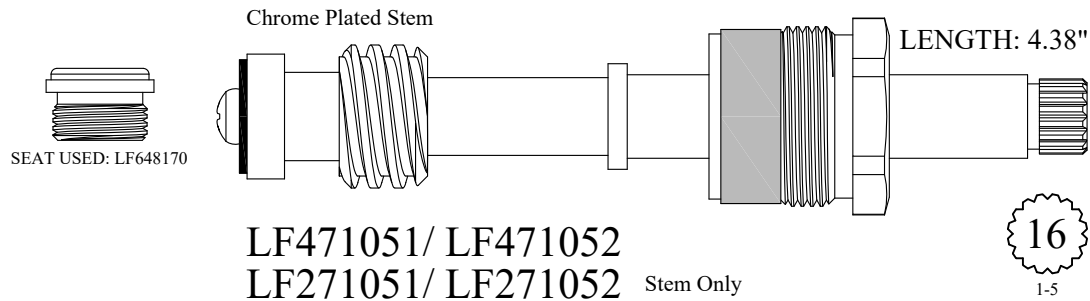
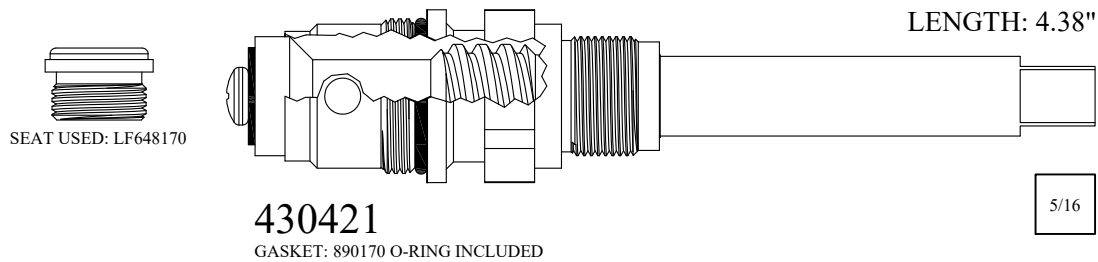
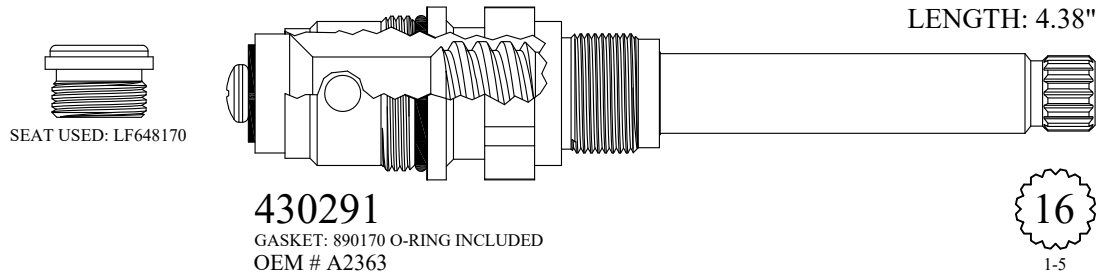

FOR STERLING FAUCET

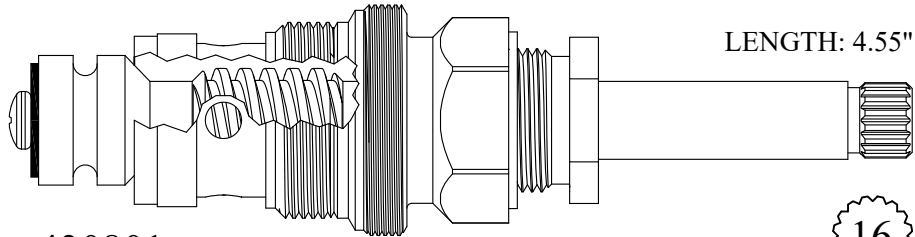

430801

GASKET INCLUDED: 895560
OEM # A8106

230801 Stem Only

OEM # S1025

IMPORT VERSION
SL21982

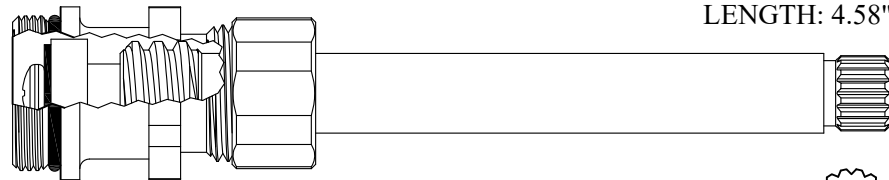

405841

GASKET: 890170 O-RING INCLUDED

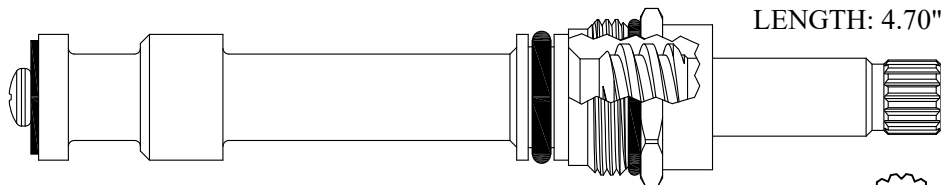

LF475021/ LF475022

GASKET: 890170 O-RING INCLUDED

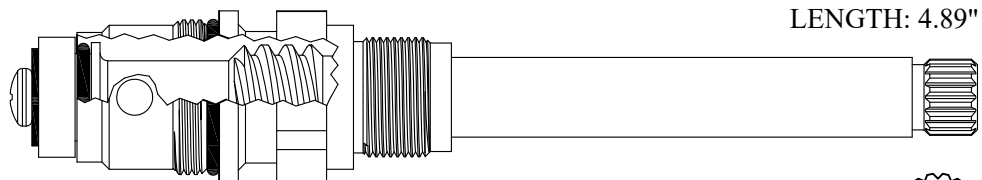

431481

GASKET: 890170 O-RING INCLUDED
OEM # 00A2363

IMPORT VERSION
SL21987



FOR STERLING FAUCET

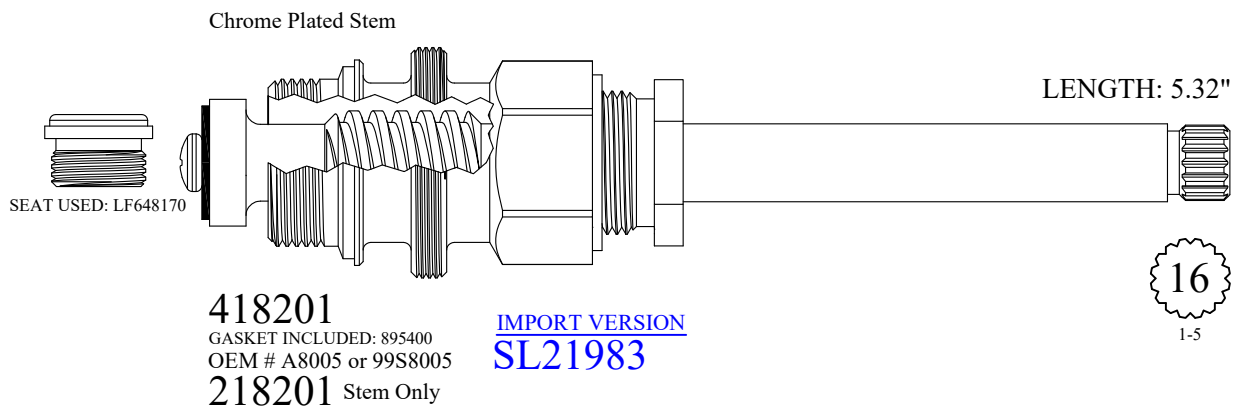
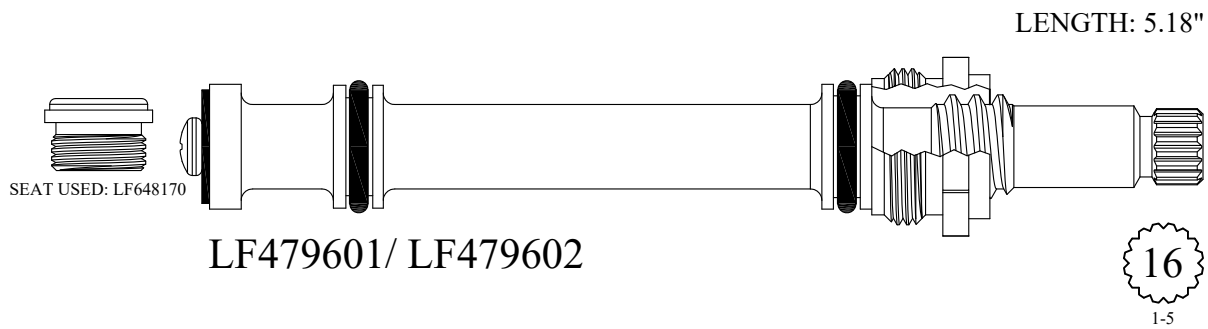
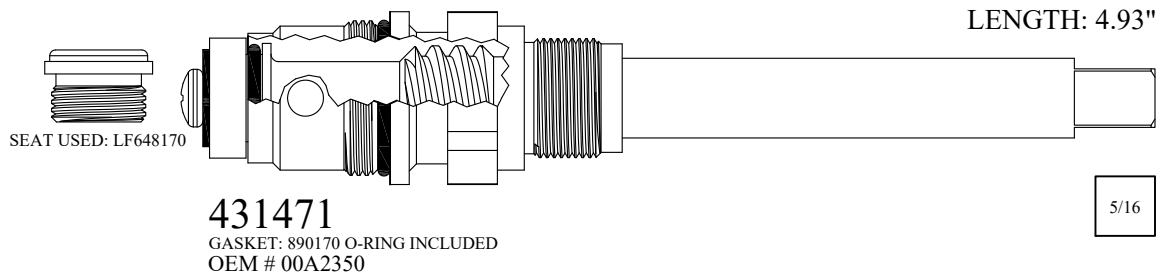
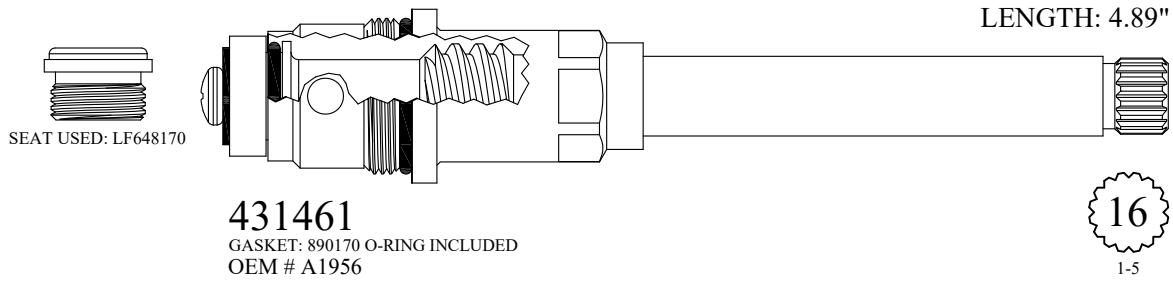

FOR STERLING FAUCET

Chrome Plated Stem

LENGTH: 5.32"

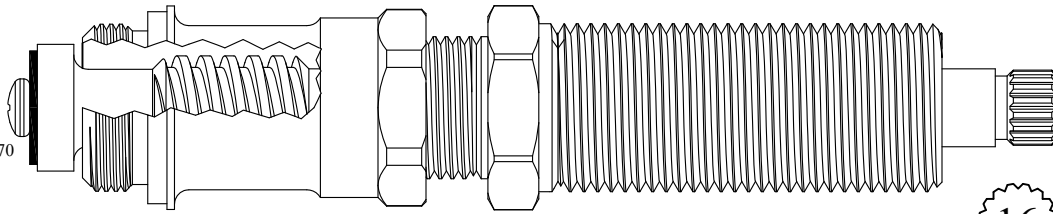

418231

GASKET INCLUDED: 895400

218201 Stem Only

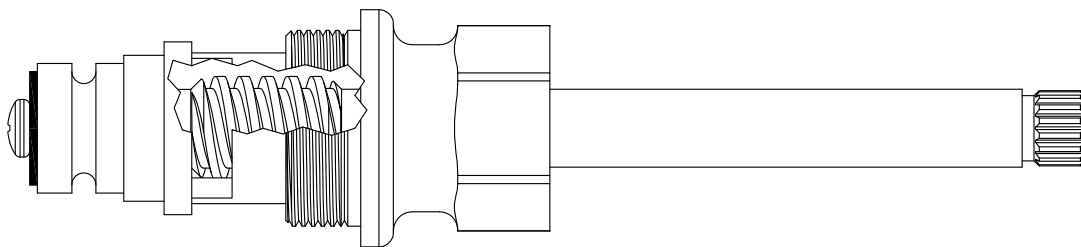

Not Available, Use 434001

Chrome Plated Stem

LENGTH: 5.47"

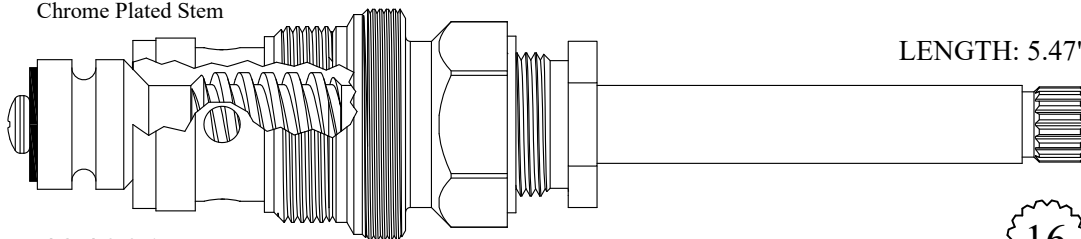

434001

GASKET INCLUDED: 895560

OEM # A8006 or 99S8006

234001 Stem Only

OEM # 99S0725

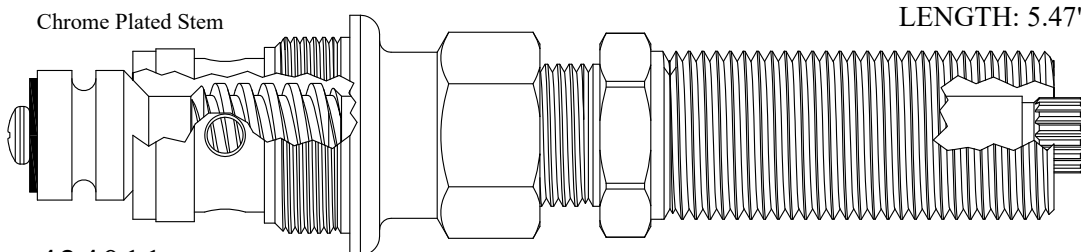

434011

GASKET INCLUDED: 895560

234001 Stem Only

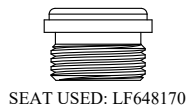

FOR STREAMLINER

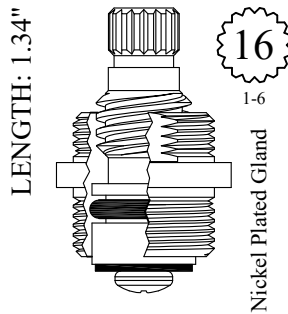

GASKET INCLUDED: 895100

LF450131
LF450132

FOR STREAMWAY

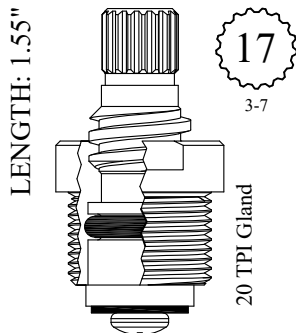

GASKET INCLUDED: 895100

LF451161
OEM # 960-0
LF451162
OEM # 5-118-0 LH



SEAT USED: LF649190

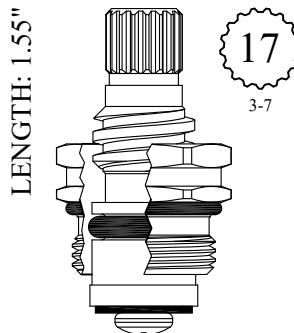

GASKET: 890170 O-RING INCLUDED

LF451171
OEM # 40-5-0 / 960-0
LF251111 Stem Only



SEAT USED: LF649190

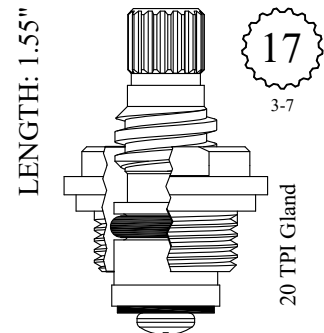

GASKET INCLUDED: 895100

LF452171
OEM # 5-108-0 RH
LF452172
OEM # 5-108-0 LH

IMPORT VERSION
SW11911
SW11912

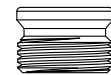

SEAT USED: LF649190

FOR STREAMWAY

LENGTH: 1.75"

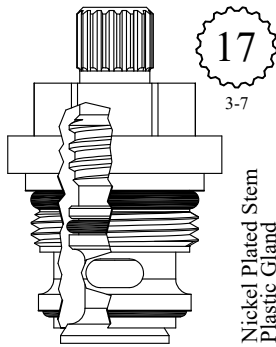

Nickel Plated Stem
Plastic Gland

GASKET: 891150 O-RING INCLUDED

LF454302
OEM # 5-P60

LENGTH: 1.88"

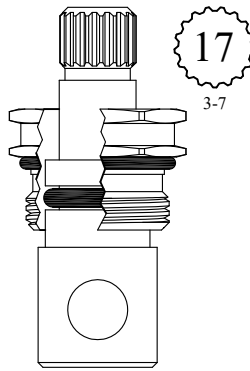

GASKET: 890170 O-RING INCLUDED

430010
230010 Stem Only

LENGTH: 1.97"

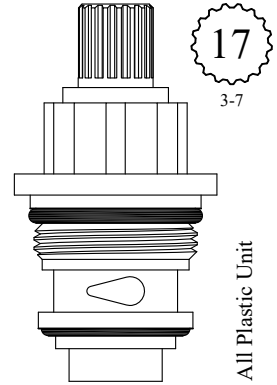

All Plastic Unit

GASKET: 891150 O-RING INCLUDED

454041
OEM # 14800
454042

LENGTH: 2.53"

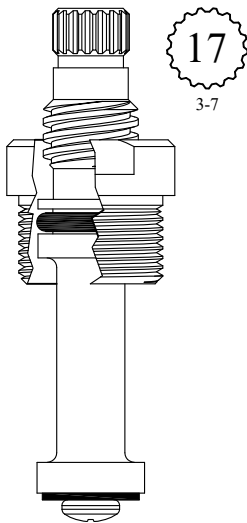

20 TPI Gland

GASKET INCLUDED: 895100

LF464121
LF464122



SEAT USED: LF648040

LENGTH: 2.53"

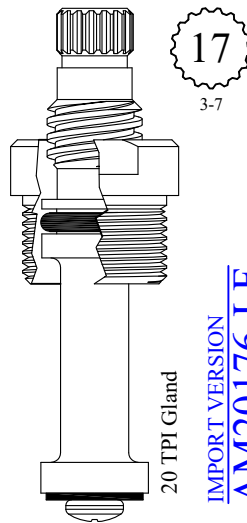

IMPORT VERSION
AM20176-LF

GASKET INCLUDED: 895100

LF464161
LF464162



SEAT USED: LF648040

LENGTH: 3.08"

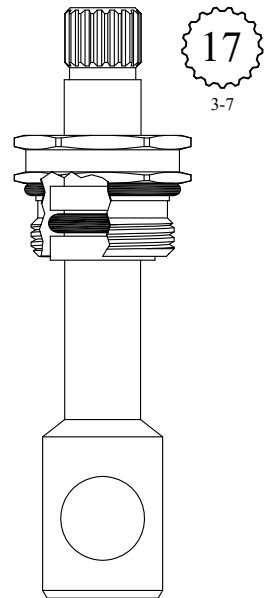

GASKET: 890170 O-RING INCLUDED

430050
230050 Stem Only

FOR STREAMWAY

Chrome Plated Stem

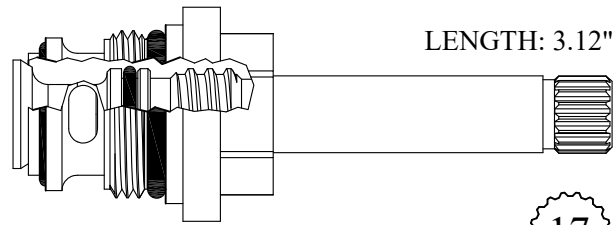

401832

GASKET: 891150 O-RING INCLUDED

17

3-7

18 TPI Gland

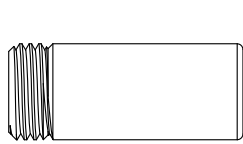

SEAT USED: LF648040

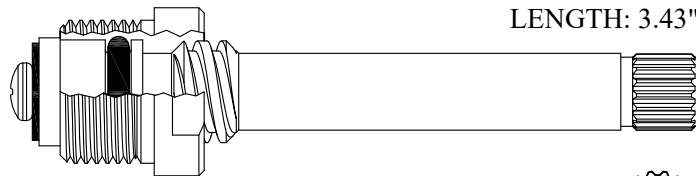

402711/ 402712

GASKET INCLUDED: 895100
OEM # 90181

17

3-7

20 TPI Gland

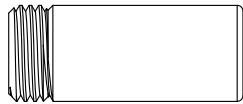

SEAT USED: LF648040

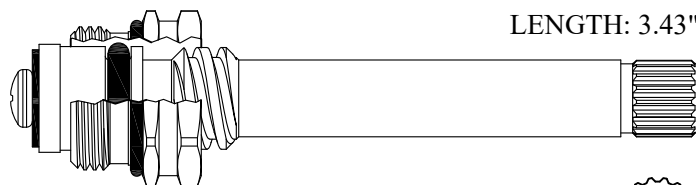

402721

GASKET: 890170 O-RING INCLUDED
OEM # 1610-5-0

17

3-7

Plastic Stem

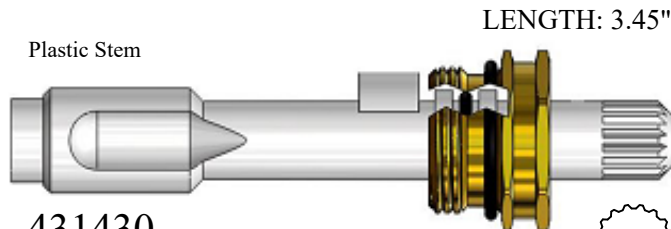

431430

GASKET: 890170 O-RING INCLUDED

17

3-7

FOR STREAMWAY

LENGTH: 3.48"

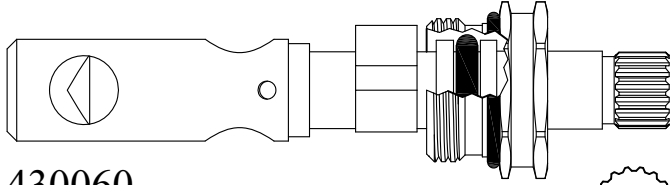

430060

GASKET: 890170 O-RING INCLUDED
OEM # MOEN 94614

230060 Stem Only

OEM # 94614 STEM



3-7

LENGTH: 3.48"

Plastic Stem

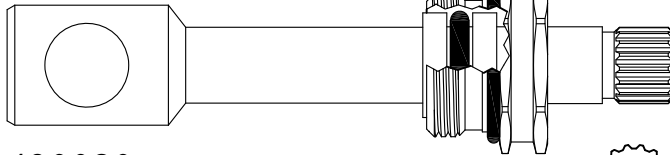

430080

GASKET: 890170 O-RING INCLUDED

230080 Stem Only



3-7

LENGTH: 4.49"

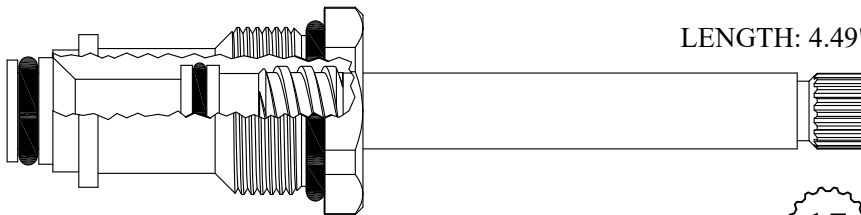

430521

GASKET: 891160 O-RING INCLUDED



3-7

LENGTH: 4.80"



431310

GASKET: 890170 O-RING INCLUDED

231310 Stem Only



3-7

FOR STREAMWAY

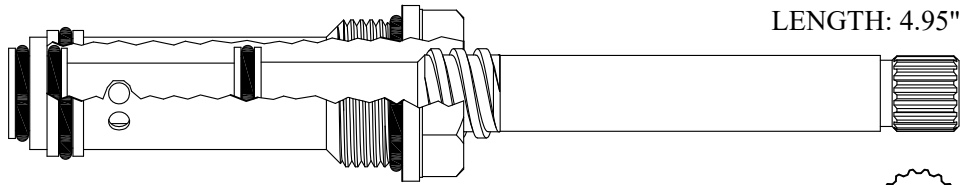

LENGTH: 4.95"

431821

GASKET: 890170 O-RING INCLUDED

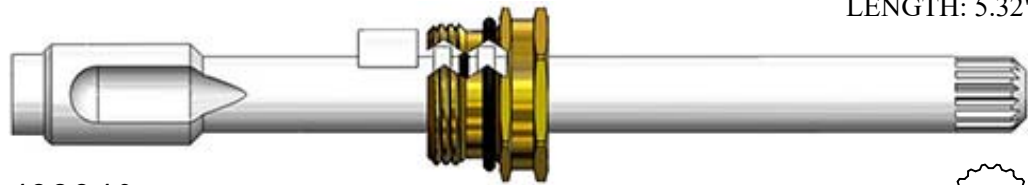

LENGTH: 5.32"

432940

GASKET: 890170 O-RING INCLUDED

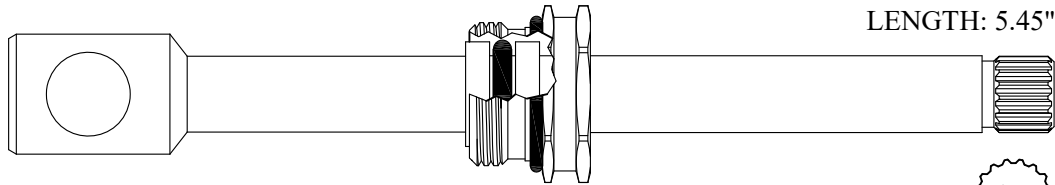

LENGTH: 5.45"

431821

GASKET: 890170 O-RING INCLUDED

234810 Stem Only



FOR SUNRISE / PRO PLUS

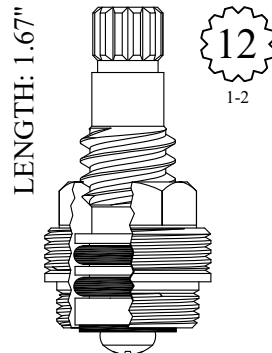

LENGTH: 1.67"



GASKET INCLUDED: 895100

LF453251
LF453252

FOR SYMMONS



LENGTH: 1.24"

Stop Unit for C-5
Replacement for
C32-11 & C32B-11



400521

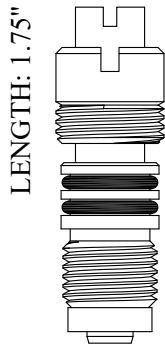

LENGTH: 1.75"

400661
OEM # T-52
200661 Stem Only
OEM # T-52A or NS-18

LENGTH: 2.34"



Diverter / Volume Spindle

160500
OEM # TA-25A

LENGTH: 2.34"



Volume Spindle

154340
OEM # TA-25B

Chrome Plated Push Button

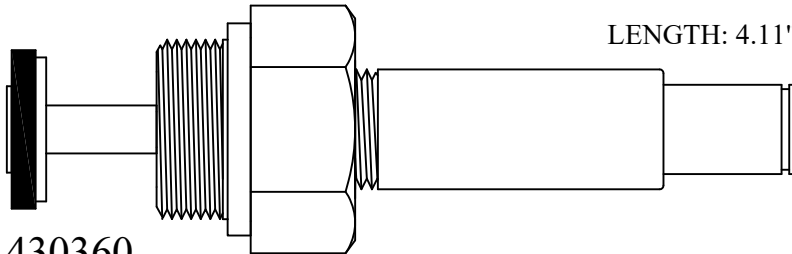

LENGTH: 4.11"

430360
GASKET: 895350 INCLUDED
OEM # TS-30

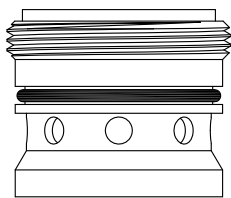

SEAT KIT USED: 106090

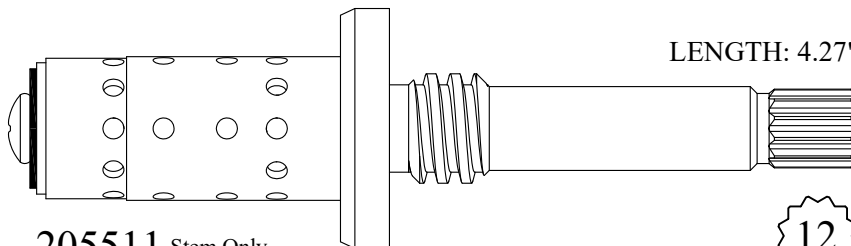

LENGTH: 4.27"

205511 Stem Only
GASKET: 895500 INCLUDED
OEM # TA-10



Symmons Small

Bonnet Assmby Only
705511
OEM # T-12A

Complete unit with Bonnet
Assembly also available
405511

Also available:
SPINDLE MAX FLOW
205511-MF
GASKET: 895500 INCLUDED
OEM # TA-10-NYC

FOR SYMMONS



431840
GASKET: 891180 O-RING INCLUDED
Diverter for 4-458 & 4-459

12

Symmons Small

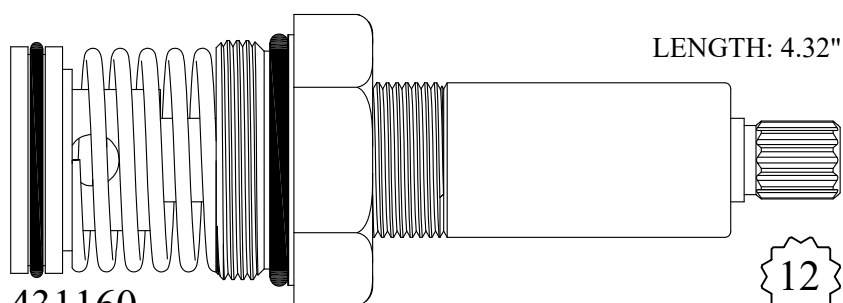

431160
GASKET: 891220 O-RING INCLUDED
OEM # LD-7RR
231160 Stem Only

12

Symmons Small

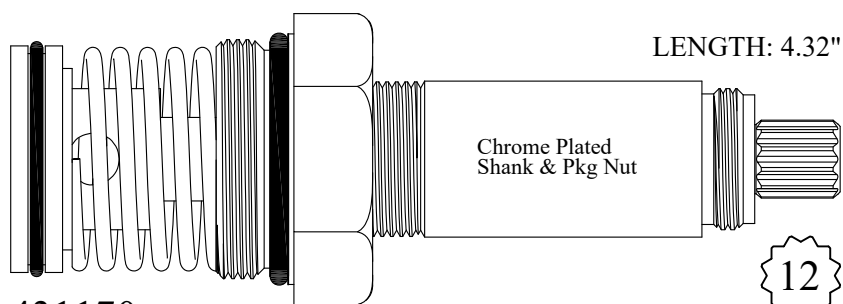

431170
GASKET: 891220 O-RING INCLUDED
OEM # LD-7RRE
231160 Stem Only

12

Symmons Small

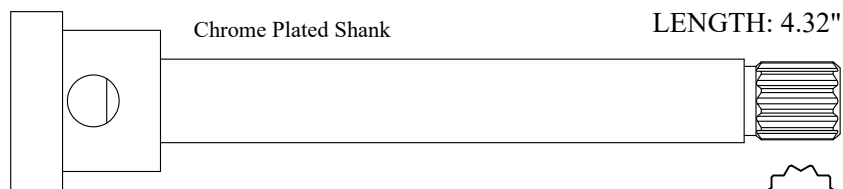

231640

12

Symmons Small

FOR SYMMONS

Chrome Plated Push Button

LENGTH: 4.47"

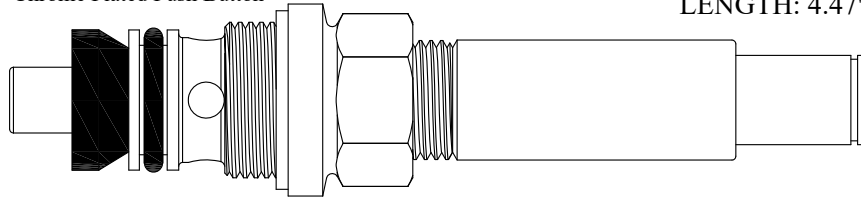

430720

GASKET INCLUDED: 895150
OEM # NTS-30

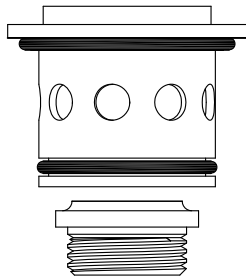

SEAT KIT USED: 130540

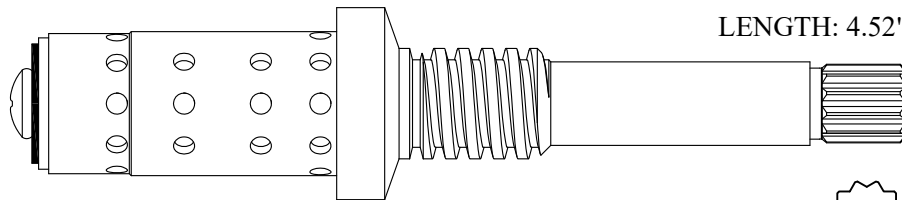

LENGTH: 4.52"

207231

OEM # J-4



Symmons Small

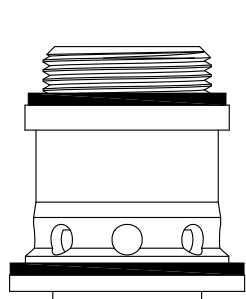

SEAT USED: 647970

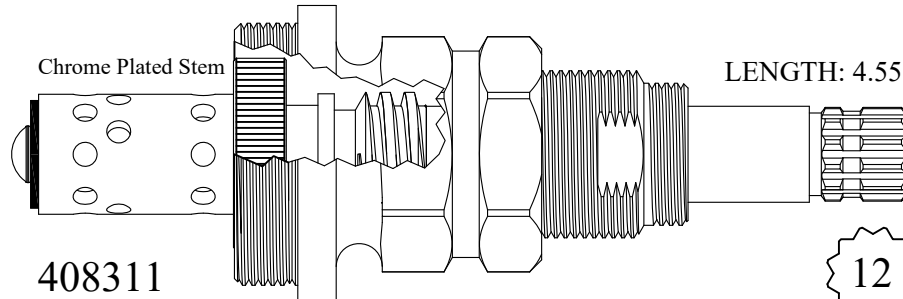

Chrome Plated Stem

LENGTH: 4.55"

408311

GASKET INCLUDED: 895500
OEM # WO-50

208311 Stem Only



Symmons Large

Chrome Plated Push Button

LENGTH: 4.63"

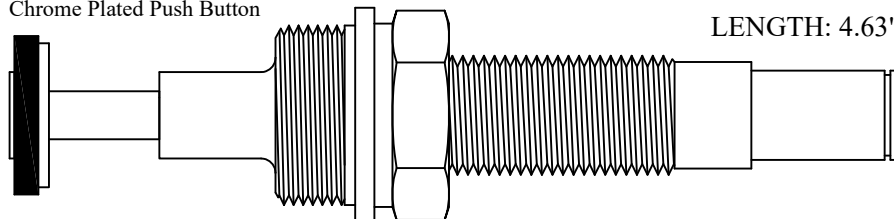

430830

GASKET INCLUDED: 895350
OEM # SD-20

FOR SYMMONS

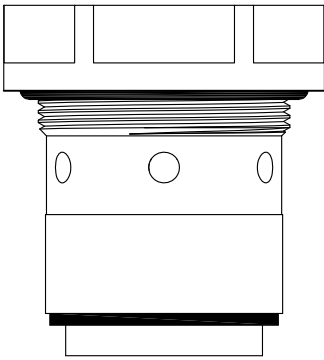

SEAT USED: 647640

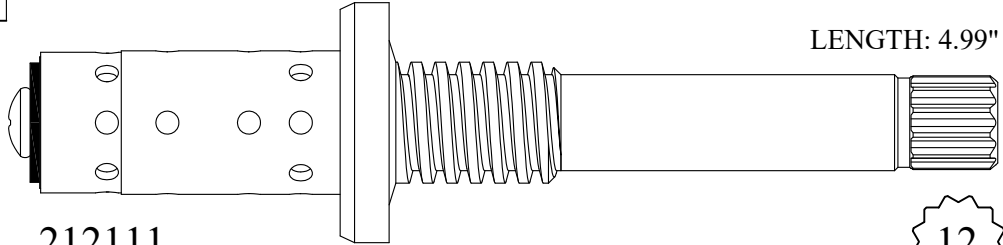

LENGTH: 4.99"

212111
OEM # C-5



Symmons Large

Chrome Plated Gland & Push Button

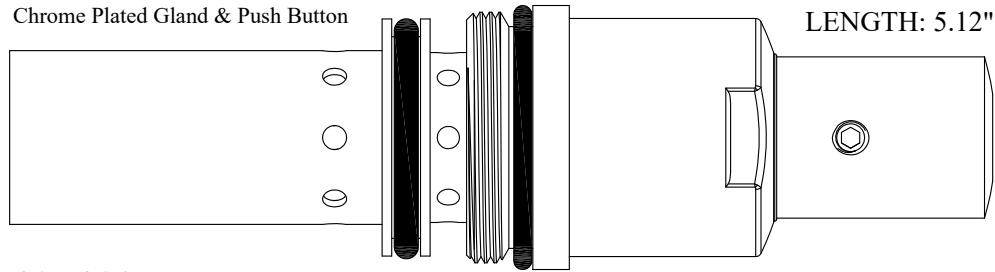

LENGTH: 5.12"

415410
OEM # NS-1

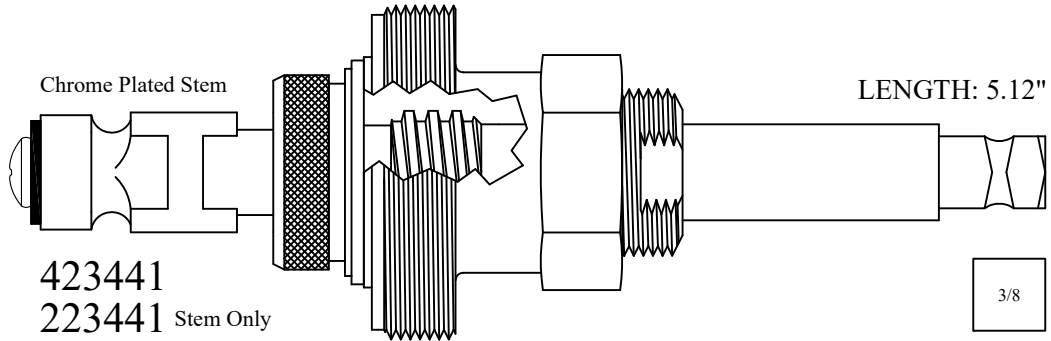

LENGTH: 5.12"

Chrome Plated Stem

423441
223441 Stem Only



3/8

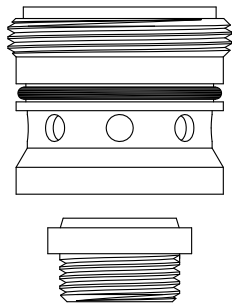

SEAT KIT USED: 106090

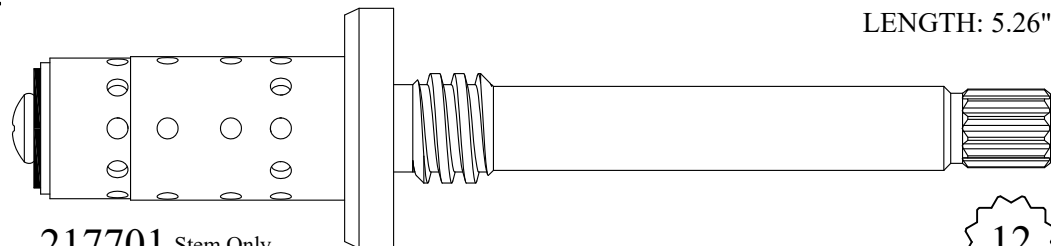

LENGTH: 5.26"

217701 Stem Only
GASKET INCLUDED: 895500
OEM # TA-10-EXT-1



Symmons Large

Bonnet Assembly Only
717701

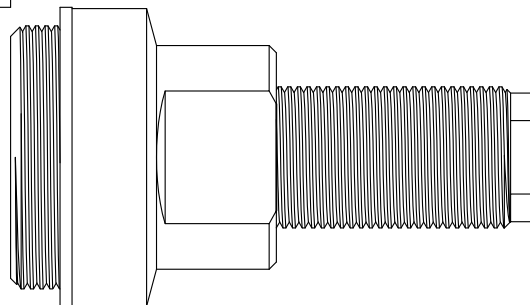

Complete unit
also available
417701

FOR SYMMONS

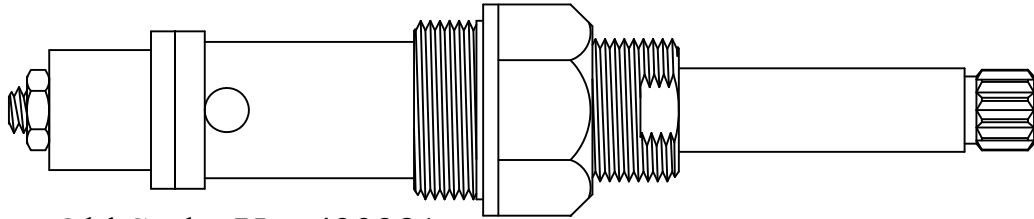

Old Style, Use 433281

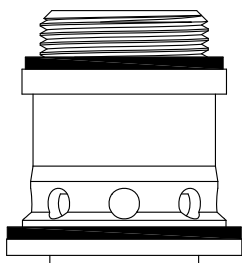

SEAT USED: 647970

Chrome Plated Stem

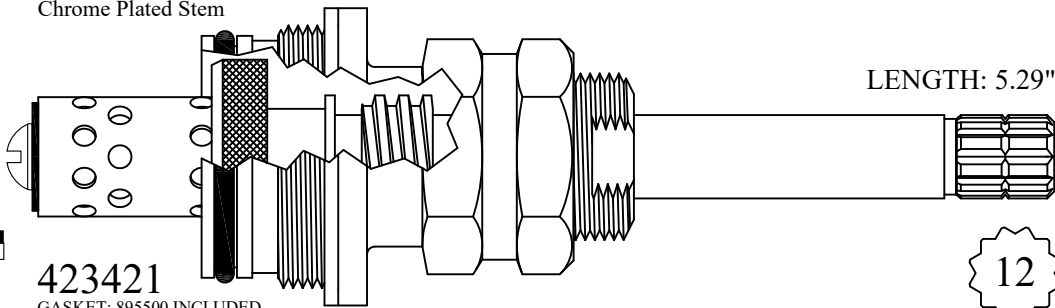

LENGTH: 5.29"

423421

GASKET: 895500 INCLUDED
OEM # TS-50

223421 Stem Only



Symmons Large

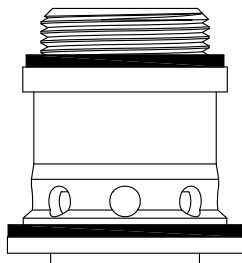

SEAT USED: 647970

Chrome Plated Stem

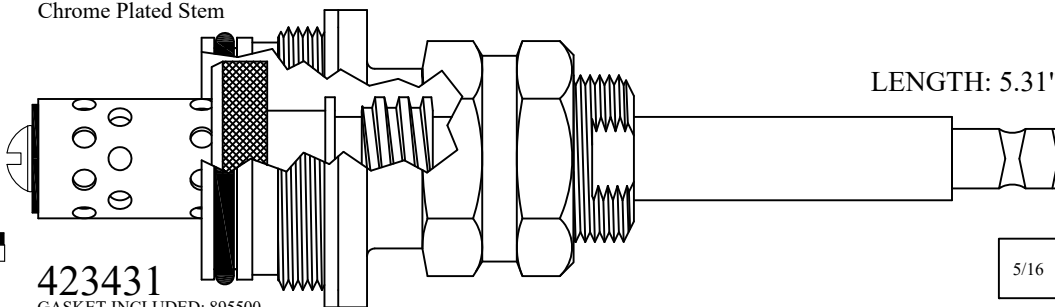

LENGTH: 5.31"

423431

GASKET INCLUDED: 895500
OEM # TS-4 & TS-3

223431 Stem Only

OEM # TS-4



5/16

Chrome Plated Stem

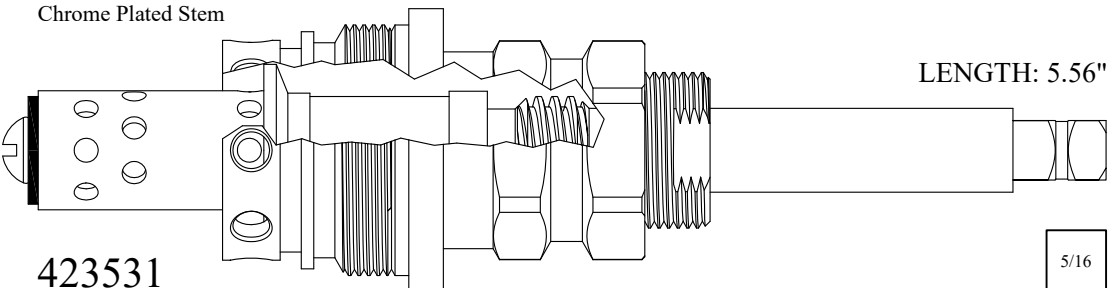

LENGTH: 5.56"

423531

GASKET INCLUDED: 895500
OEM # NTS-50

223531 Stem Only



5/16

FOR SYMMONS

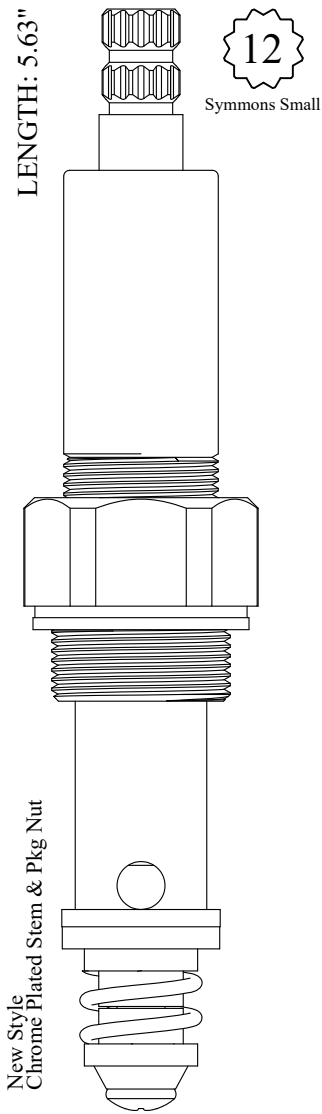

GASKET INCLUDED: 895350

435781

OEM # LLD-20 (NEW STYLE)

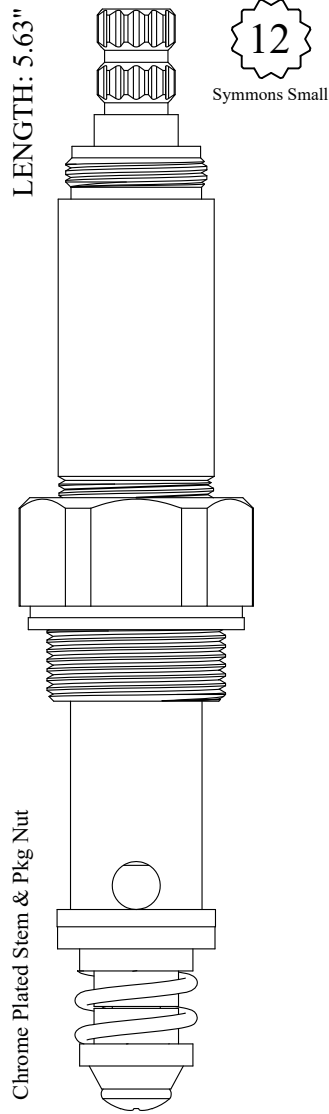

GASKET INCLUDED: 895350

435791

OEM # LLD-20E

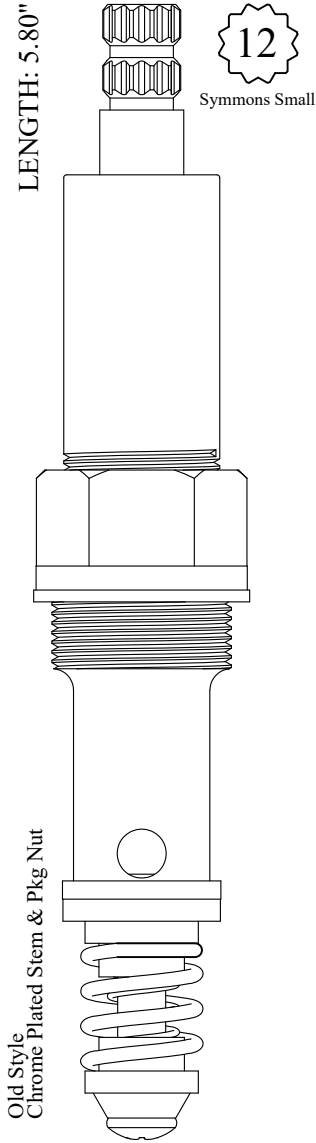

GASKET INCLUDED: 895350

433281

OEM # LLD-20 (OLD STYLE)



GASKET: 8991170 & 891180 O-RING INCLUDED

439440

FOR T & S

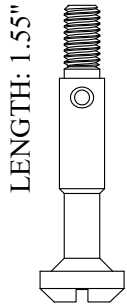

LF107910

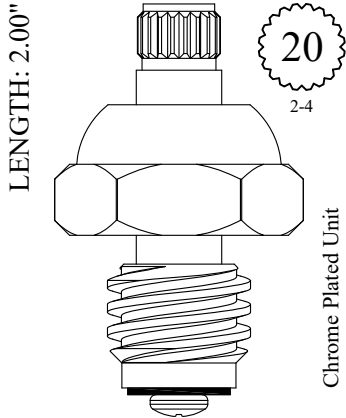

LF458201
OEM # 009753-24
LF458202
OEM # 009754-24
LF258201 Stem Only
OEM # 000800-25
LF258202 Stem Only
OEM # 000801-25



SEAT USED: LF647700

Also available:
Complete Unit w/ Handle
LF458201-3341
LF458202-3341



Handle Pair
available with
these 3 stem units

Also available:
Complete Unit w/ Handle
LF464181-3341
LF464182-3341

IMPORT VERSION W/ HANDLE
TS12013-LF
TS12014-LF

Also available
w/ White Plastic Button

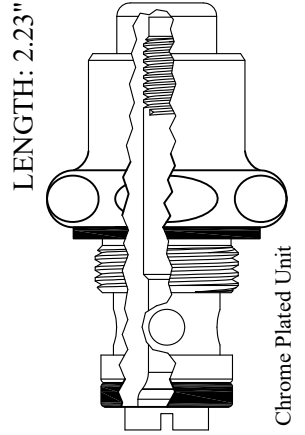

GASKET INCLUDED: 895260

LF462400
OEM # 002856-40
With White Plastic Button
LF462400-P
OEM # 002983-40

Also available:
Complete Unit w/ Handle
LF464181-NS-3341
LF464182-NS-3341

New Style

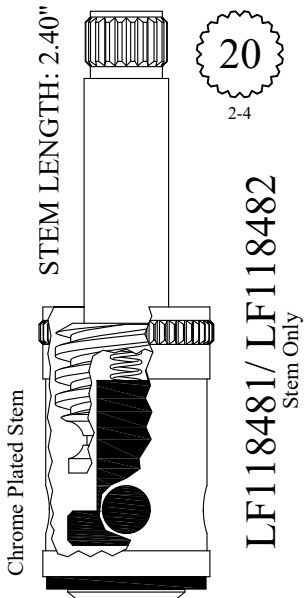

LF118481/ LF118482
Stem Only

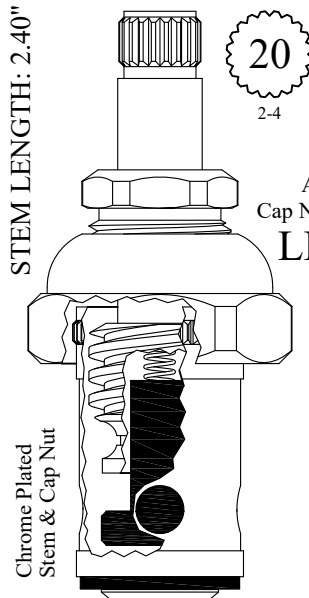

Also available:
Cap Nut Assembly Only
LF764060



Also available:
Cap Nut Assembly Only
LF764060-NS

Chrome Plated
Stem & Bonnet

USES BARREL: LF664061/LF664062

USES BARREL: LF664061/LF664062

LF464181-LB
OEM # 001907-25
LF464182-LB
OEM # 001908-25
LF264181 Stem W/
Spring & Retainer
OEM # 001907-25 W/SEAT & SPRING
LF264182 Stem W/
Spring & Retainer
OEM # 001908-25 W/SEAT & SPRING

LF464181
OEM # 012443-40
LF464181
OEM # 012442-40
IMPORT VERSION
TS12009-LF
TS12010-LF

LF464181-NS
OEM # 012443-40NS
LF464181-NS
OEM # 012442-40NS

FOR T & S

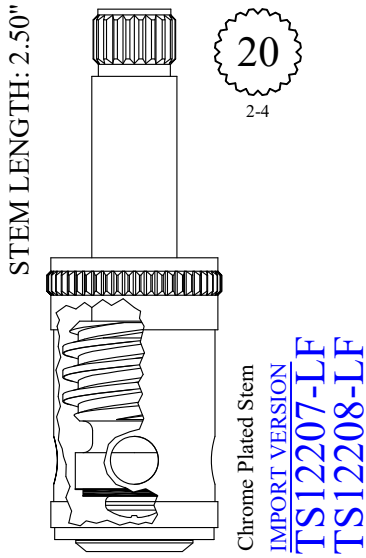

USES BARREL: LF664061/LF664062

LF464061-LB

OEM # 000811-25

LF464062-LB

OEM # 000812-25

LF264061 Stem Only

OEM # 000811-25

LF264062 Stem Only

OEM # 000812-25

Also available: Complete Unit with Handle

LF464061-3341

LF464062-3341

IMPORT VERSION W/ HANDLE

TS12015-LF

TS12016-LF

TS33410



Handle Pair available with these 2 stem units

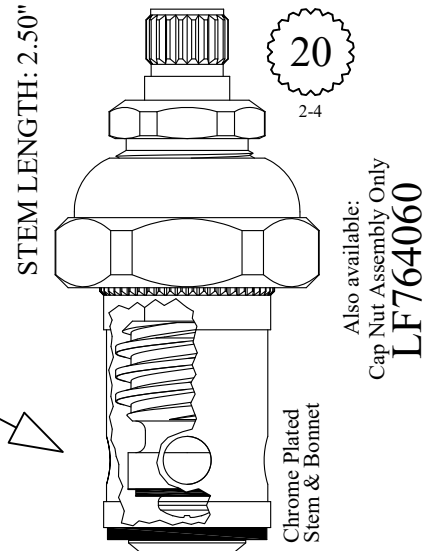

INCLUDES BARREL: LF664061/LF664062

LF464061

OEM # 005960-40

LF464062

OEM # 005959-40

LF264061 Stem Only

OEM # 000811-25

LF264062 Stem Only

OEM # 000812-25

Also available: Complete New Style Unit with Handle

LF464061-NS-3341

LF464062-NS-3341

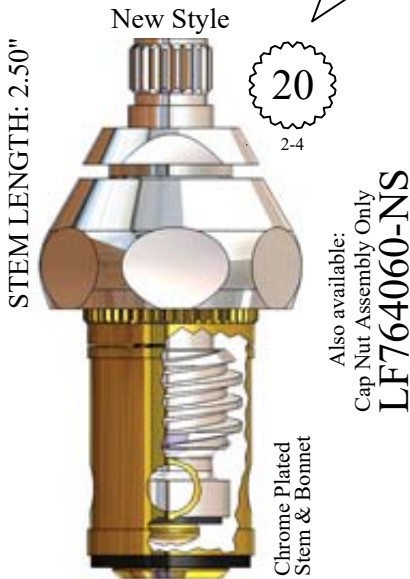

INCLUDES BARREL: LF664061/LF664062

LF464061-NS

OEM # 005960-40NS

LF464062-NS

OEM # 005959-40NS

LF264061 Stem Only

OEM # 000811-25

LF264062 Stem Only

OEM # 000812-25

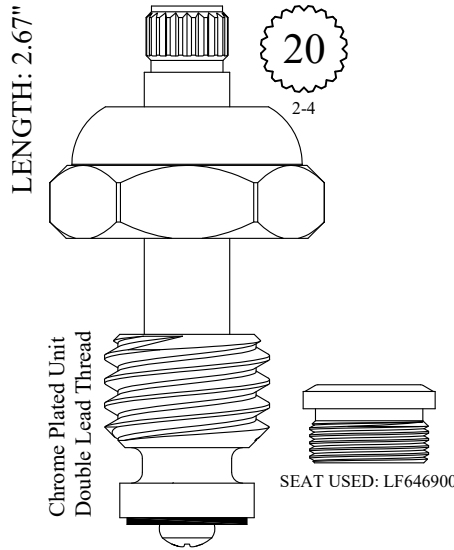

LF465021

OEM # 015294-40

LF465022

LF265021 Stem Only

OEM # 015295-40

LF265022 Stem Only

OEM # 012370-25

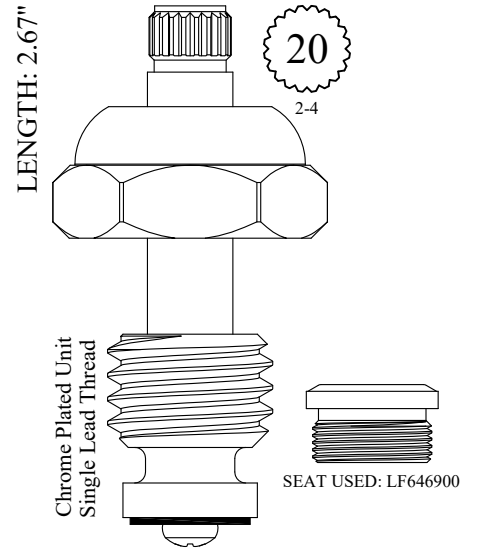

LF465181

LF265181 Stem Only

FOR T & S

Chrome Plated Unit

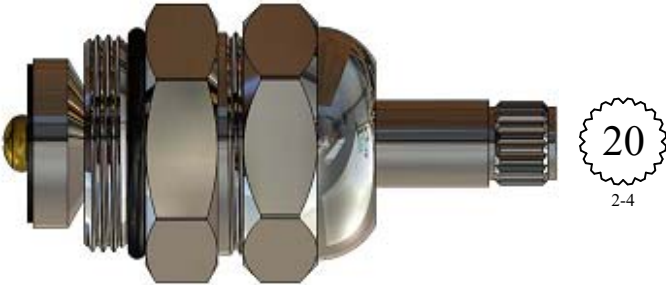

LF465781/ LF465782

GASKET: 891200 O-RING INCLUDED
OEM # 006482-40

Chrome Plated Unit

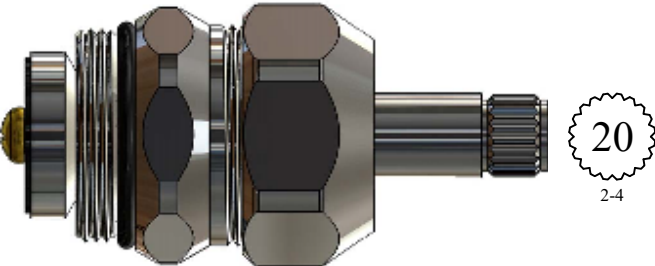

LF465781-NS/ LF465782-NS

GASKET: 891200 O-RING INCLUDED
OEM # 006482-40

Chrome Plated Unit
w/ Button

LENGTH: 2.98"

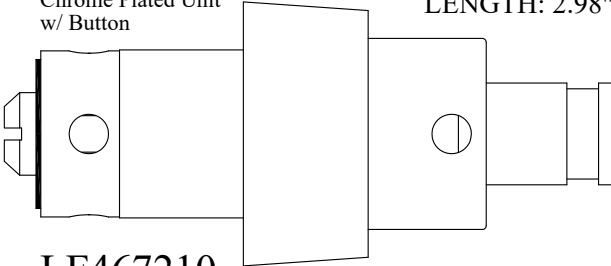

LF467210

Chrome Plated Stem

LENGTH: 3.18"

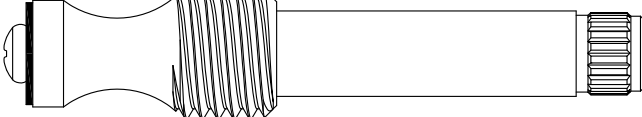

LF268401



2-4

FOR TANNER

LENGTH: 2.29"

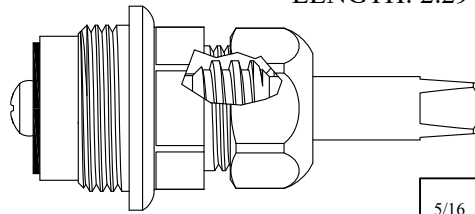

462561

GASKET INCLUDED: 895400

5/16
Tapered

LENGTH: 2.31"

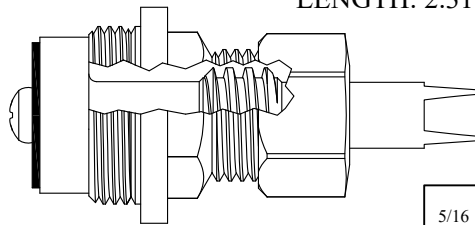

468031

GASKET INCLUDED: 895370

5/16
Tapered

LENGTH: 2.77"

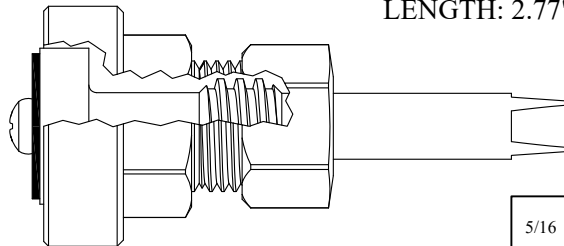

465251

GASKET INCLUDED: 894860

5/16
Tapered

LENGTH: 3.01"

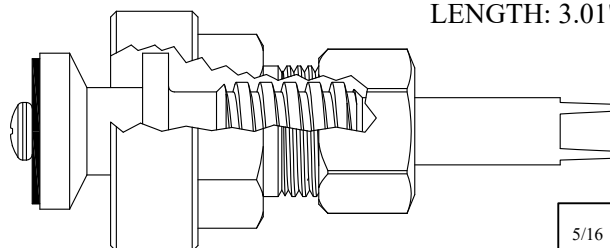

466341

GASKET INCLUDED: 894860

5/16
Tapered

FOR TANNER

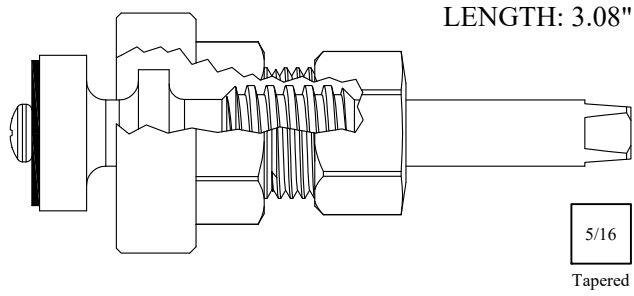

466371

GASKET INCLUDED: 894860

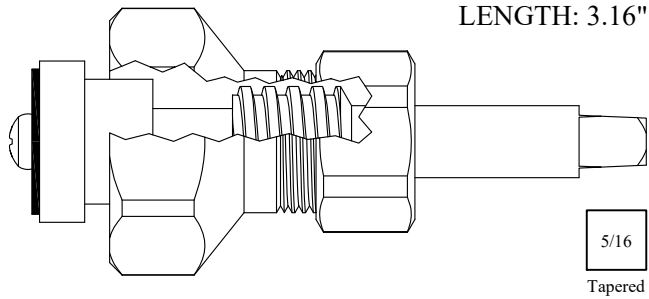

466601

GASKET INCLUDED: 895540

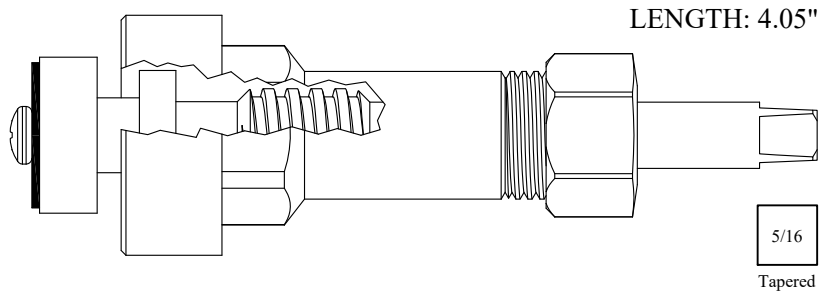

470811

GASKET INCLUDED: 894860

FOR TECK



LF154130

OEM # 7725701

FOR TEMPRESS

Old Style - Automatic

LENGTH: 3.59"

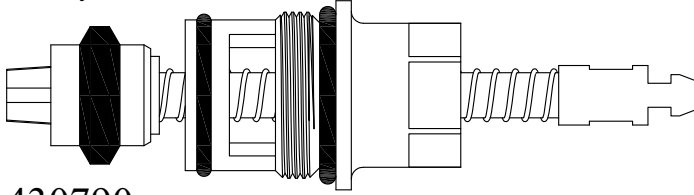

430790

GASKET: 894120 O-RING INCLUDED
OEM # 1533-6000 / 1-043 / 18.30.069

New Style - Manual

LENGTH: 3.76"

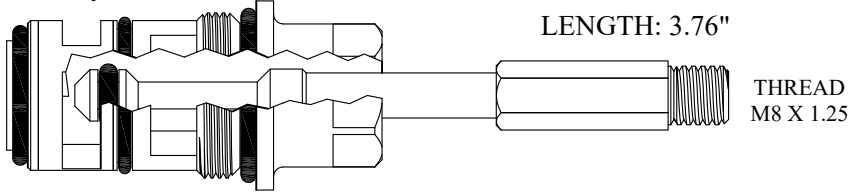

THREAD
M8 X 1.25

430850

GASKET: 894120 O-RING INCLUDED

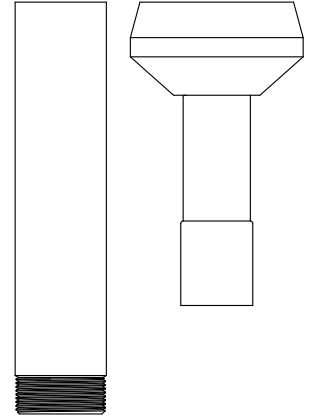

Chrome plated handle
& sleeve available

128540

Old Style - NO LONGER AVAILABLE - Use 430850

LENGTH: 4.09"

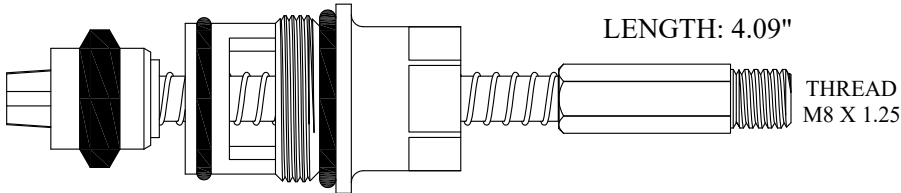

THREAD
M8 X 1.25

OEM # 47689000

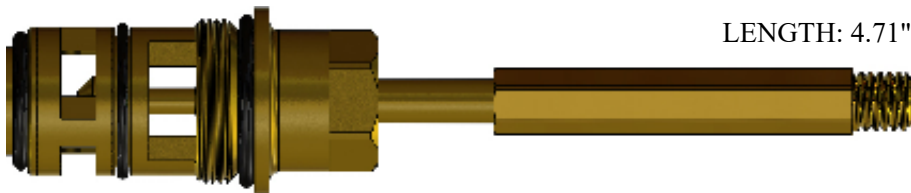

LENGTH: 4.71"

THREAD
M8 X 1.25

432850

GASKET: 894120 O-RING INCLUDED

FOR TOTO

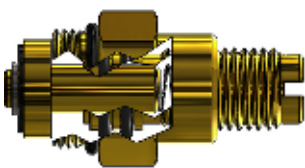

400881

GASKET: 890150 O-RING INCLUDED

FOR TWYFORD BATH

LENGTH: 2.35"

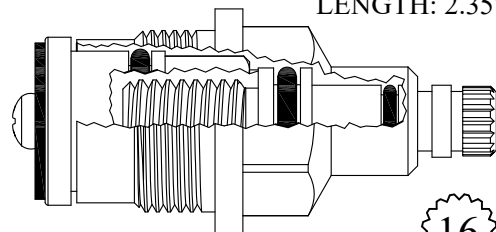

401372

GASKET INCLUDED: 895370



1-6

FOR UNION BRASS / GOPHER

LENGTH: 1.38"

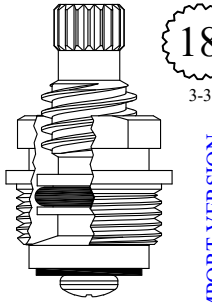

18
3-3

IMPORT VERSION
UN12101-LF
UN12102-LF

GASKET INCLUDED: 895100

LF450071
OEM # 1837 AH/80037
LF450072
OEM # 1837 AC/80038

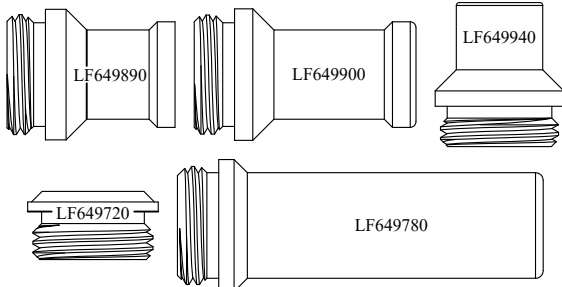

SEATS USED: LF649720,
LF649780, LF649890,
LF649900 or LF649940

LENGTH: 1.75"

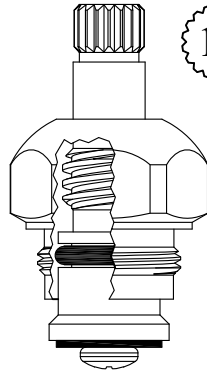

18
3-3

Nickel Plated Unit

GASKET INCLUDED: 895100

LF455011
LF455012

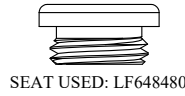

SEAT USED: LF648480

LENGTH: 1.81"

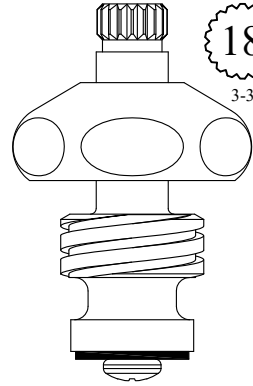

18
3-3

Nickel Plated Unit

LF455121
LF455122
LF255121 Stem Only
OEM # P-107
LF255122 Stem Only

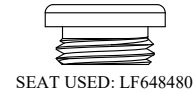

SEAT USED: LF648480

LENGTH: 2.39"

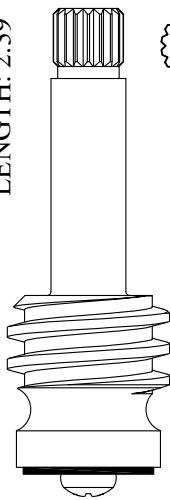

18
3-3

Chrome Plated Stem

LF264191
LF264192



USE
402001
402002
or Import Versions

LENGTH: 3.13"

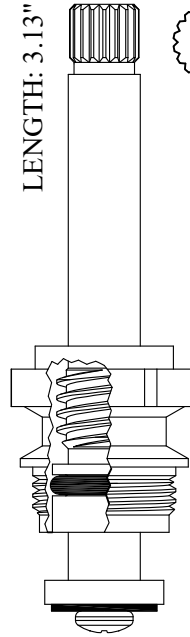

18
3-3

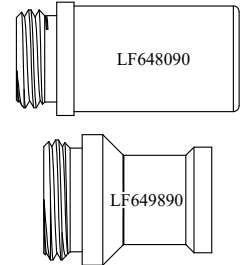

SEATS USED: LF648090 or LF649890

IMPORT VERSION
UN22110
UN22111

GASKET INCLUDED: 895100

402001
OEM # 80039 (1840A-H)
402002
OEM # 80040 (1840A-C)

FOR UNION BRASS / GOPHER

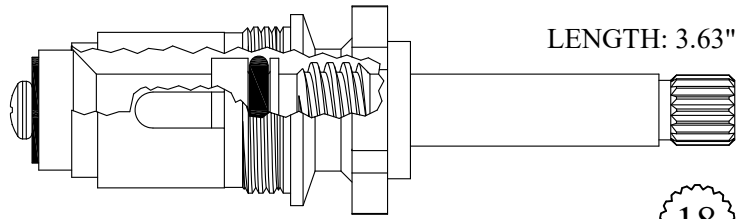

430151
 GASKET INCLUDED: 895400
 OEM # 86553

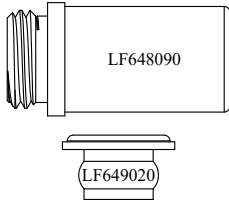

SEATS USED: LF648090 or LF649020

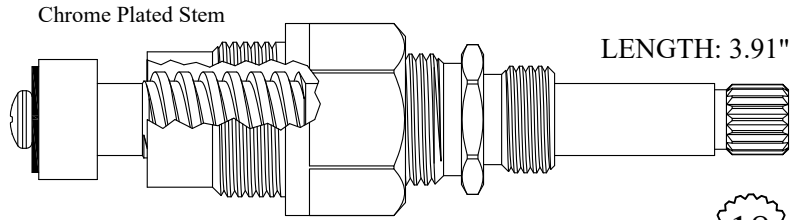

LF469051/ LF469052
 GASKET INCLUDED: 895150
 OEM # P-106
LF269051/ LF269052 Stem Only

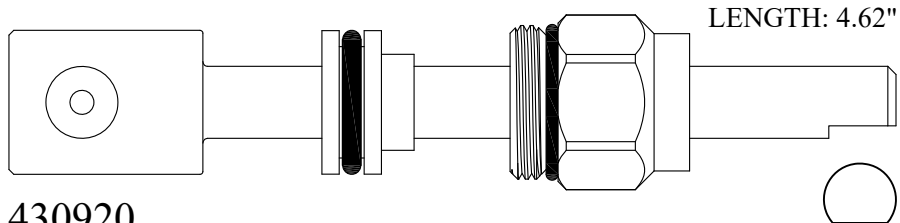

430920
 GASKET: 890170 O-RING INCLUDED
 OEM # 83410
230920 Stem Only
 OEM # 3410

IMPORT VERSION
UN22117

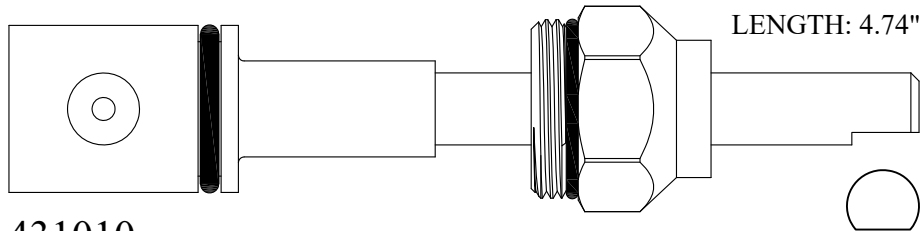

431010
 GASKET: 890190 O-RING INCLUDED
 OEM # 83407
231010 Stem Only

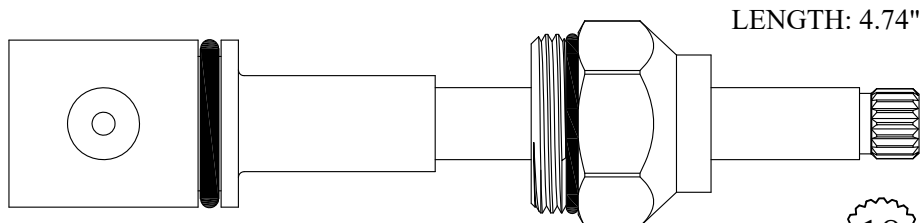

IMPORT VERSION
UN22119
 GASKET: 890190 O-RING INCLUDED



FOR UNION BRASS / GOPHER

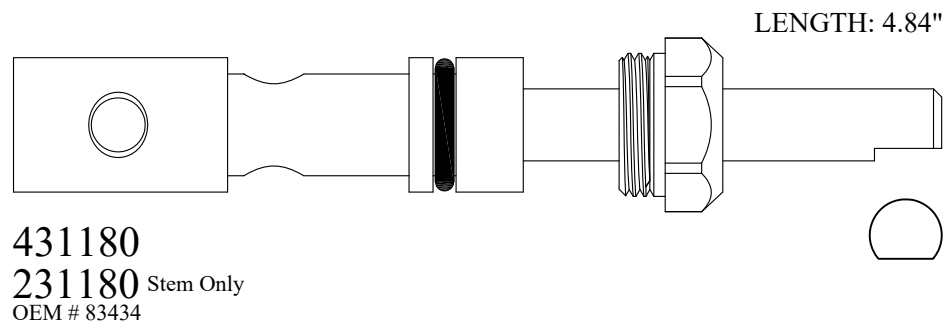
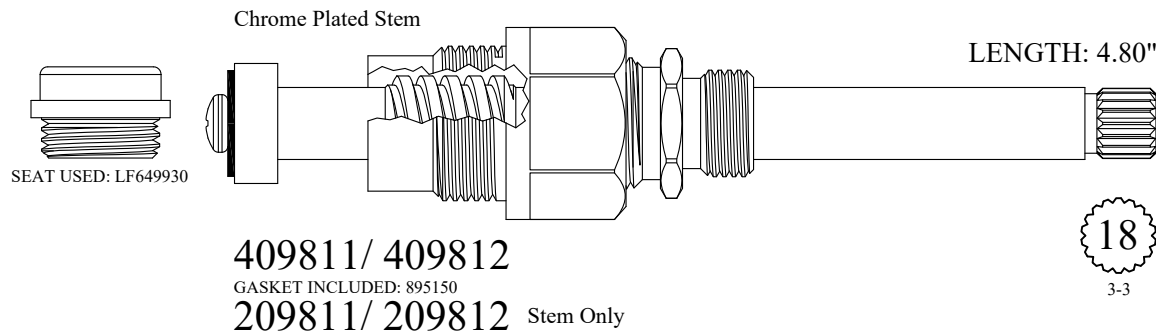
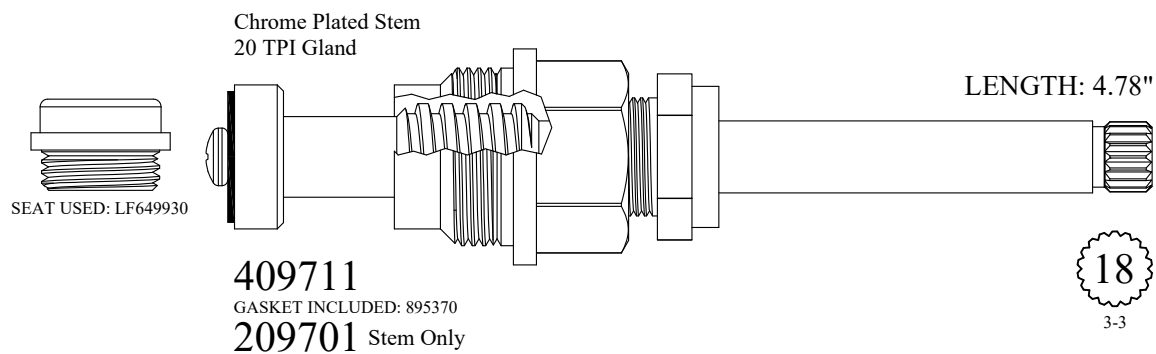
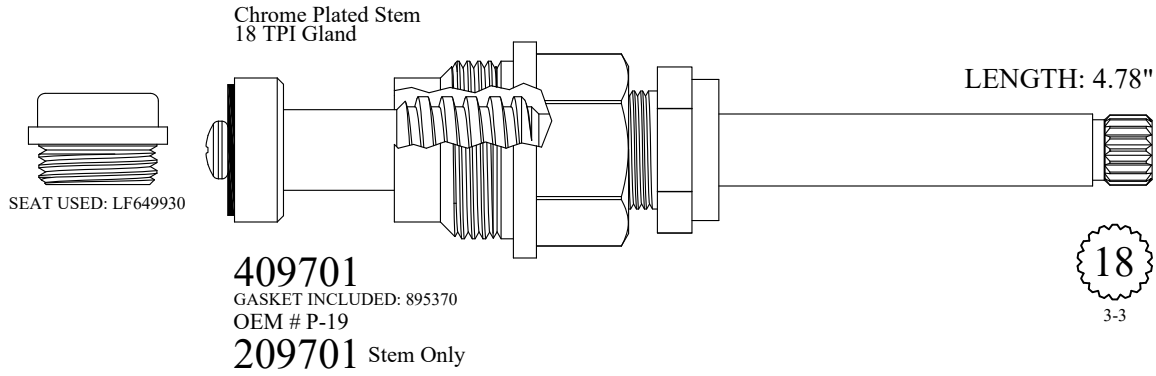

FOR UNION BRASS / GOPHER



LENGTH: 4.84"

431280

18
3-3

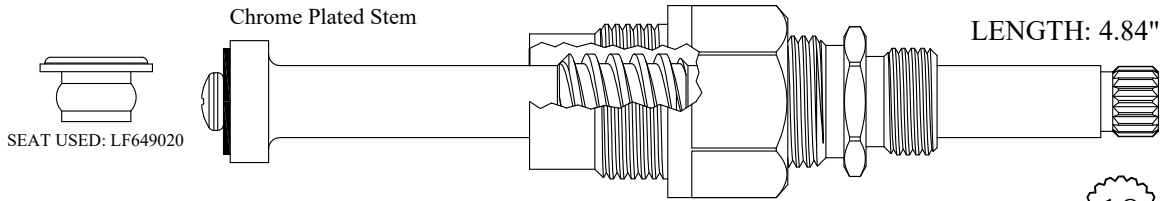

LENGTH: 4.84"

LF477031/ LF477032
LF277031/ LF277032 Stem Only
GASKET INCLUDED: 895150
OEM # P-139

18
3-3

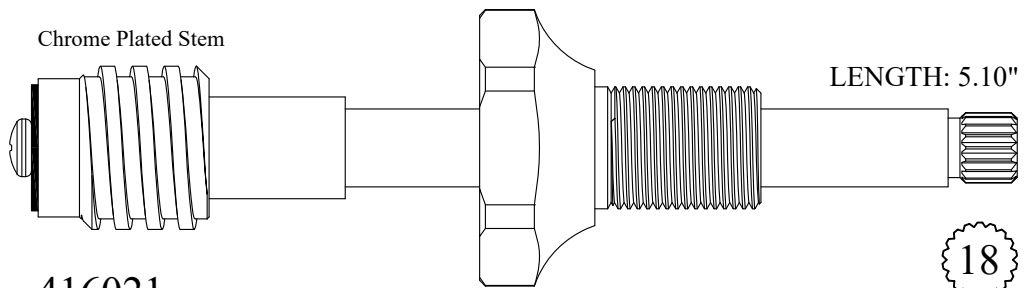

LENGTH: 5.10"

416021
216021 Stem Only

18
3-3

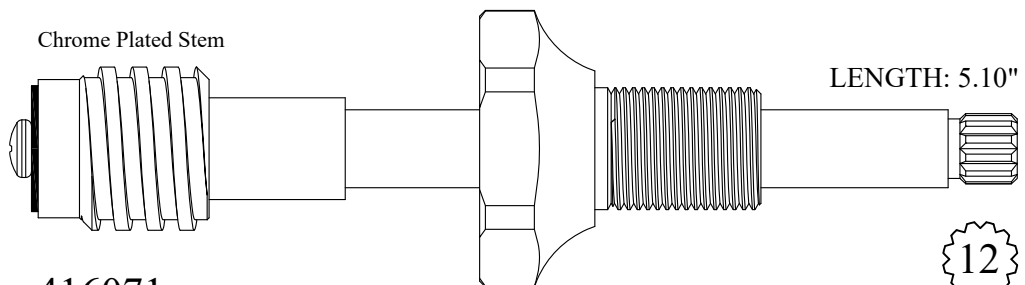

LENGTH: 5.10"

416071
216071 Stem Only

12
1-2

FOR UNION BRASS / GOPHER

LENGTH: 5.10"

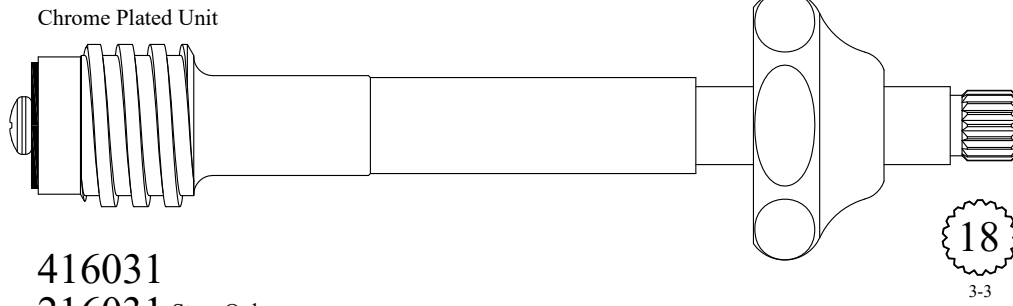

416031
216031 Stem Only

LENGTH: 5.10"

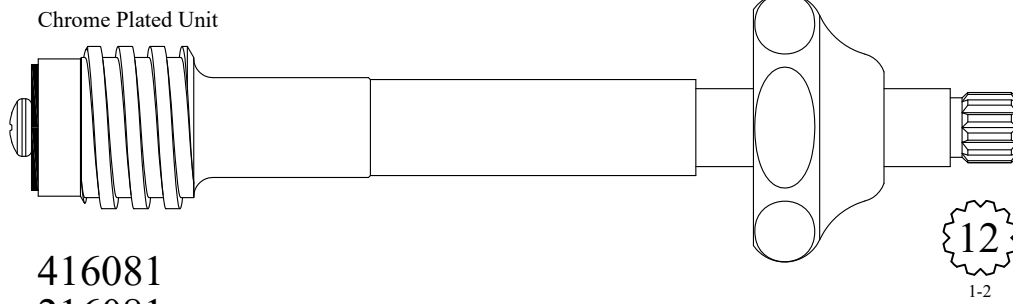

416081
216081 Stem Only

LENGTH: 5.18"

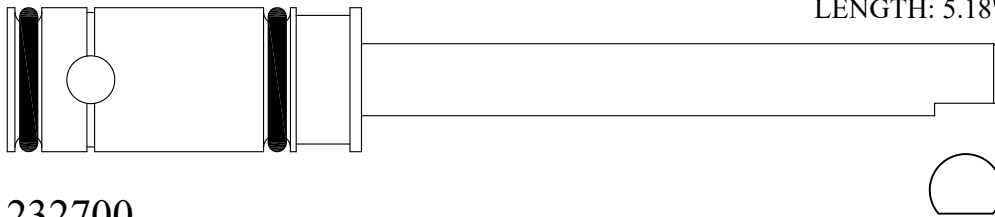

232700
OEM # 1542-F

LENGTH: 5.27"

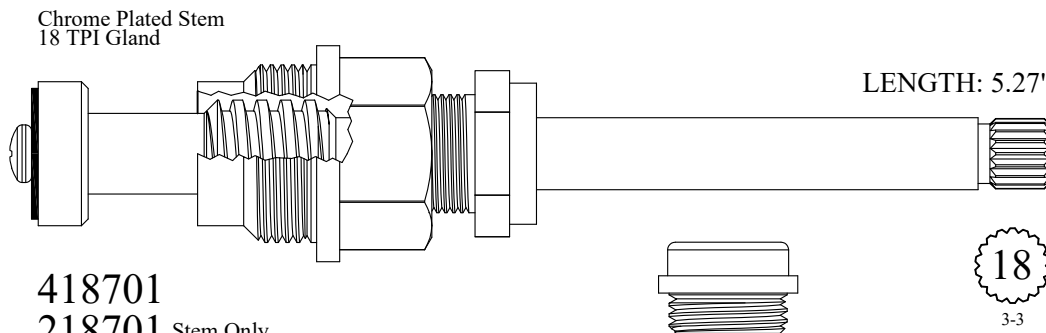

418701
218701 Stem Only
GASKET INCLUDED: 895370
OEM # P-19/80033

FOR UNION BRASS / GOPHER

Chrome Plated Stem
18 TPI Gland

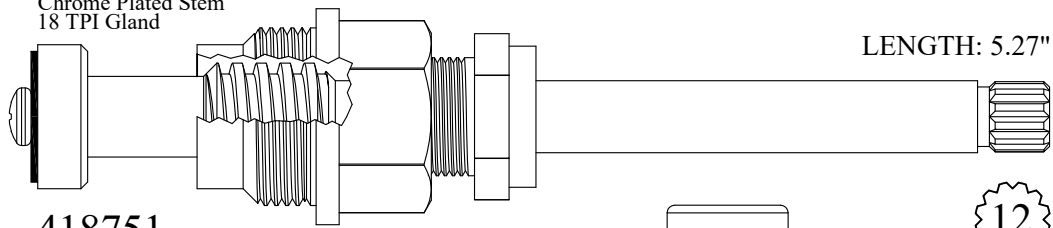

418751
GASKET INCLUDED: 895370
218751 Stem Only

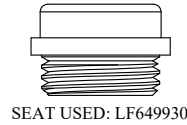

12
1-2

Chrome Plated Stem
20 TPI Gland

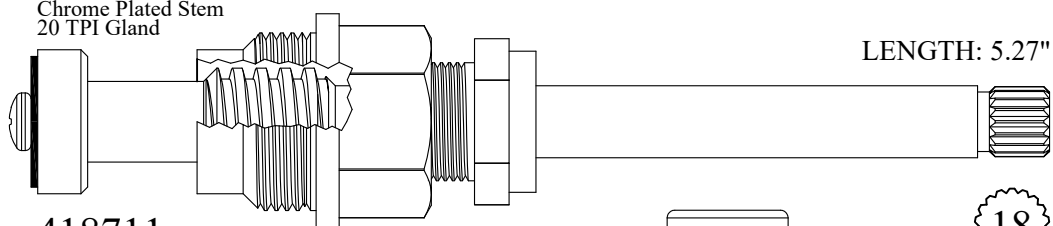

418711
GASKET INCLUDED: 895370
218701 Stem Only

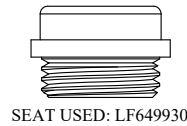

18
3-3

Chrome Plated Stem

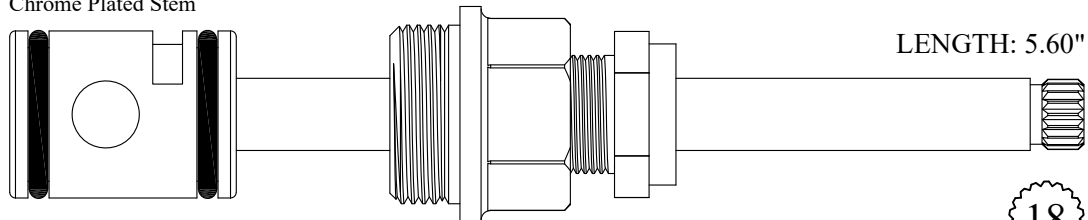

435200
235200 Stem Only

18
3-3

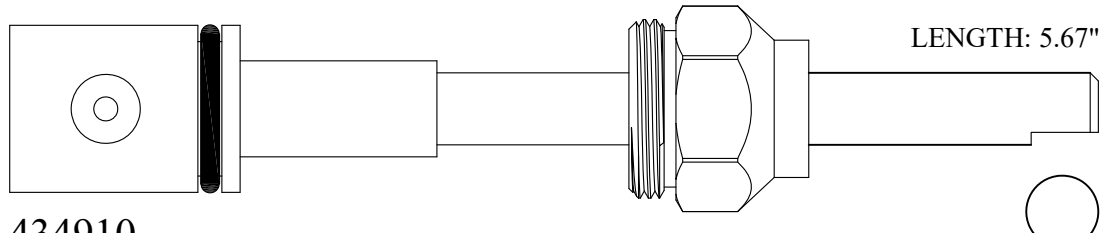

434910
234910 Stem Only

18
3-3

Chrome Plated Stem

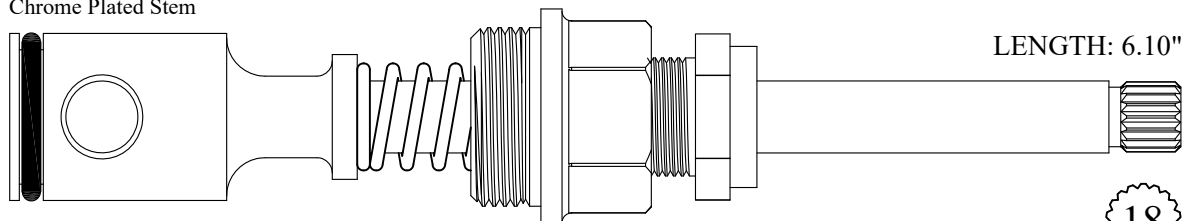

437900
GASKET INCLUDED: 895330
237900 Stem Only

18
3-3

FOR UNITED

LENGTH: 5.08"

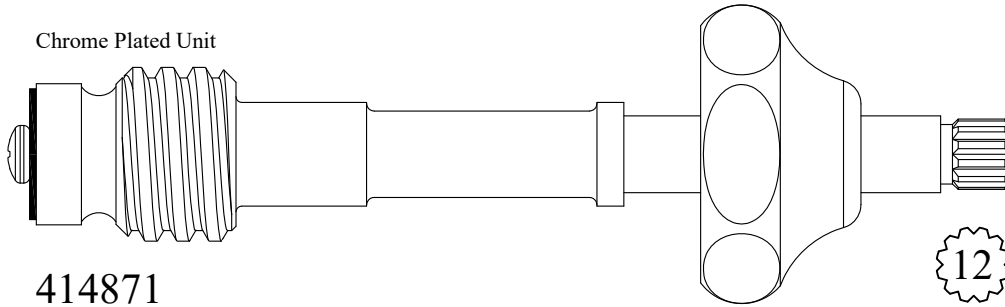

Chrome Plated Unit

414871
214871 Stem Only

12
1-2

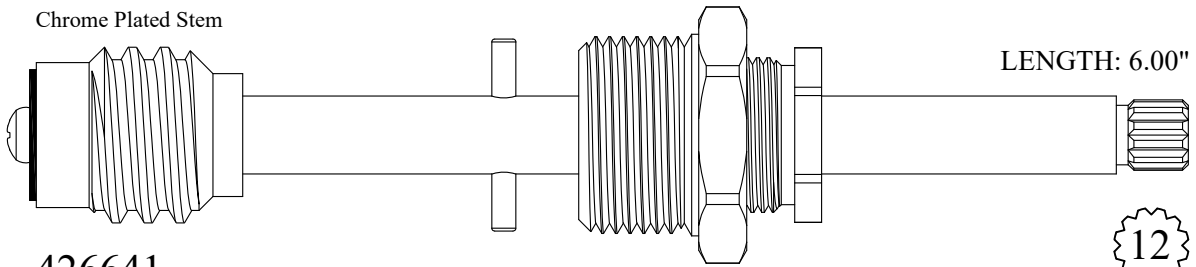

Chrome Plated Stem

426641
226641 Stem Only

LENGTH: 6.00"

12
1-2

FOR UNIVERSAL BRASS

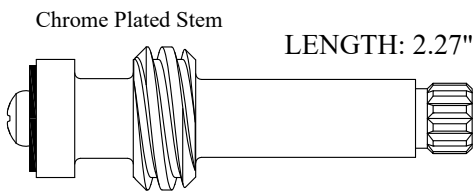

Chrome Plated Stem

LENGTH: 2.27"

LF263061
LF263062

12
1-2

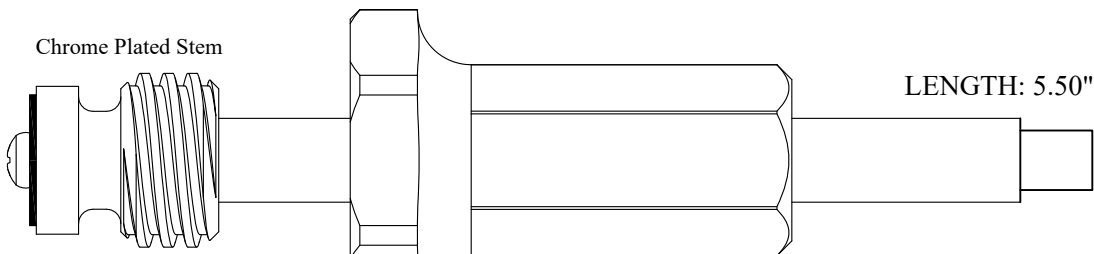

Chrome Plated Stem

LENGTH: 5.50"

424201
224201 Stem Only

Supplied with
12pt. Broach

12
1-2

Supplied with
New Style Bonnet

FOR URREA

FOR WATTS

LENGTH: 1.70"

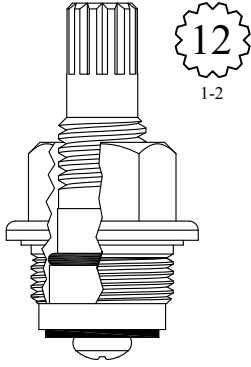

LF453401

LENGTH: 1.97"

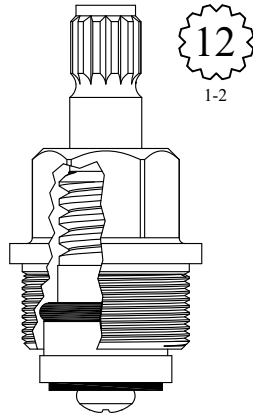

GASKET INCLUDED: 895180

LF458401

LENGTH: 2.70"

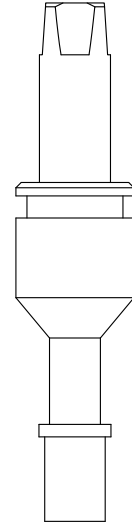

130990

FOR VALLEY

LENGTH: 1.85"



VA12241
OEM # V6804

LENGTH: 2.50"



VA12241
OEM # V6860

LENGTH: 7.72"



VA12242
OEM # V6856BG

FOR WATER SAVER

LENGTH: 1.50"

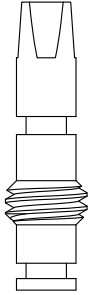

LF251341
OEM # BV112B-R

LENGTH: 2.18"

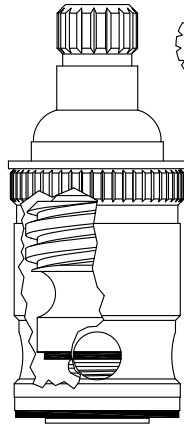

17

Chrome Plated Stem
Stainless Steel Seat

SEAT INCLUDED: LF648600

LF461301
OEM # BNV100-RH
LF461302
OEM # BNV100-LH

LENGTH: 2.18"

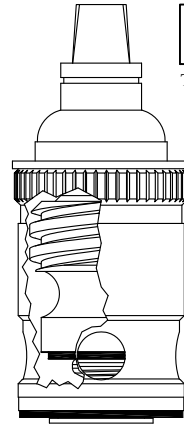

5/16
Tapered

Chrome Plated Stem
Stainless Steel Seat

SEAT INCLUDED: LF648600

LF461311
OEM # BNV200-RH
LF461312
OEM # BNV200-LH

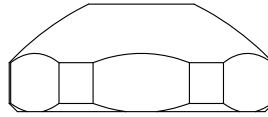

Chrome Plated Bonnet also available

761300

LENGTH: 2.53"

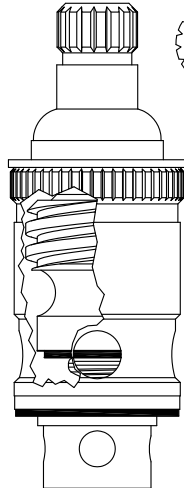

17

Chrome Plated Stem
Stainless Steel Seat

SEAT INCLUDED: LF649880

LF464041
OEM # BNV100AC-RH
LF464042
OEM # BNV100AC-LH

LENGTH: 2.53"

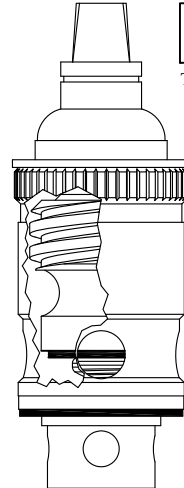

5/16
Tapered

Chrome Plated Stem
Stainless Steel Seat

SEAT INCLUDED: LF649880

LF464441
OEM # BNV200AC-RH
LF464442
OEM # BNV200AC-LH

FOR WEST BRASS

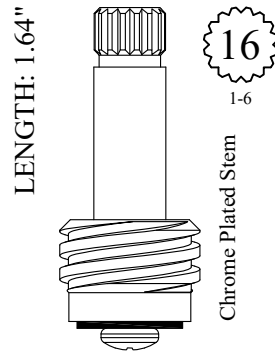

LF252111
LF252112

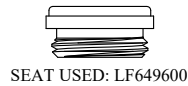

SEAT USED: LF649600

FOR WEST BRASS (ITALY)

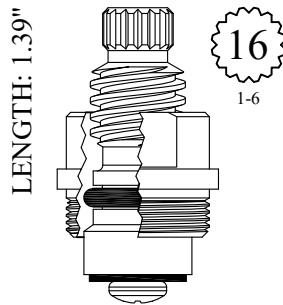

GASKET INCLUDED: 895100

LF450121
LF450122

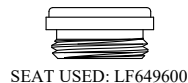

SEAT USED: LF649600

FOR WEST BRASS (JAPAN)

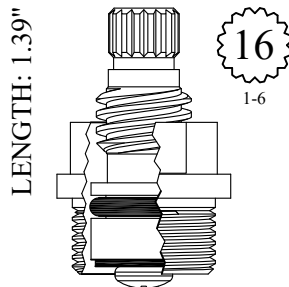

GASKET INCLUDED: 895100

LF450081
LF450082



SEAT USED: LF649600

FOR WILLOUGHBY

REPAIR KIT AVAILABLE

145450

KIT INCLUDES:

BEVELED BIBB WASHER

15.5MM x 3MM O-RING

.312 x .187 x .062 O-RING

.84 x .625 x .105 WASHER

6-32 x 1/4" BIBB SCREW

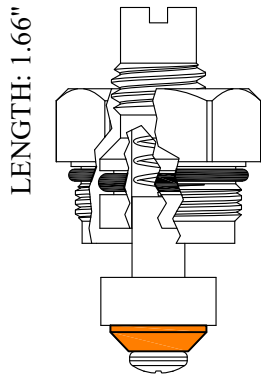

GASKET: 890190 O-RING INCLUDED

LF400451
OEM # 600089

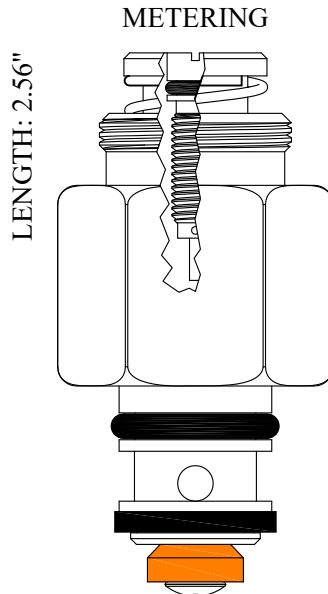

LF465480
OEM # 600275

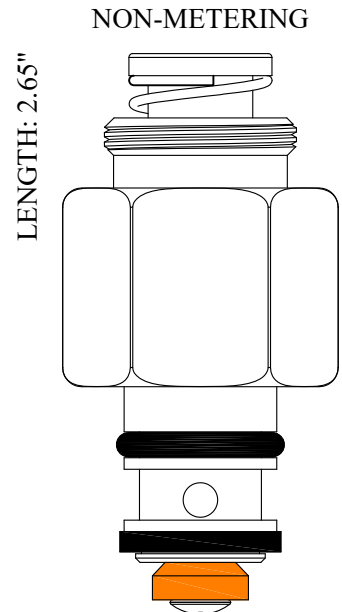

LF465470
OEM # 600276

Send Your Orders To:

BARRY E.  SR. CO.

E-mail: orderdesk@barrywalter.com

Fax: 1.800.886.9831

Phone: 1.800.767.5552

FOR WOLVERINE

LENGTH: 1.90"

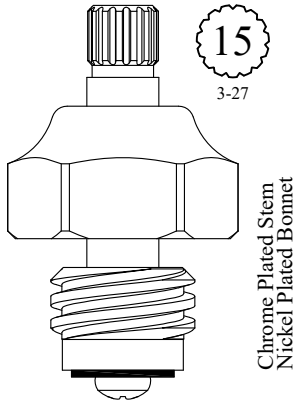

Chrome Plated Stem
Nickel Plated Bonnet

LF457161
LF457162
LF257161 Stem Only
LF257162 Stem Only



SEAT USED: LF649200

LENGTH: 1.92"

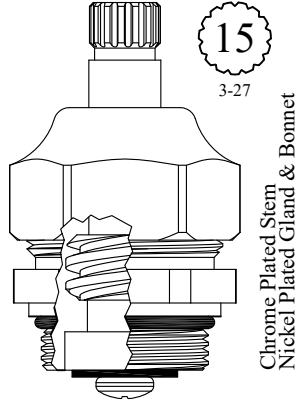

Chrome Plated Stem
Nickel Plated Gland & Bonnet

GASKET: 890190 O-RING INCLUDED

LF457081
LF457082

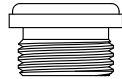

SEAT USED: LF649200

LENGTH: 2.25"

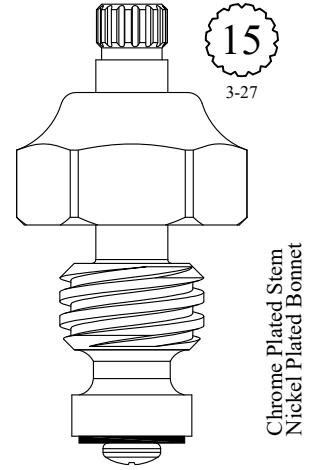

Chrome Plated Stem
Nickel Plated Bonnet

LF463081
LF463082
LF263081 Stem Only
LF263082 Stem Only

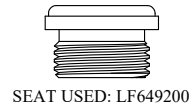

SEAT USED: LF649200

LENGTH: 2.47"

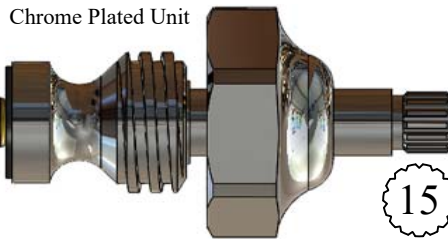

Chrome Plated Unit



SEAT USED: LF648320

LF463581/ LF463582

GASKET INCLUDED: 890160
OEM # 490-6953-00

Chrome Plated Gland

LENGTH: 3.86"

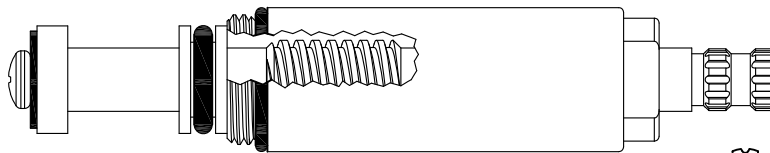

403541/ 403542

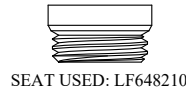

SEAT USED: LF648210

Chrome Plated Stem

LENGTH: 4.40"

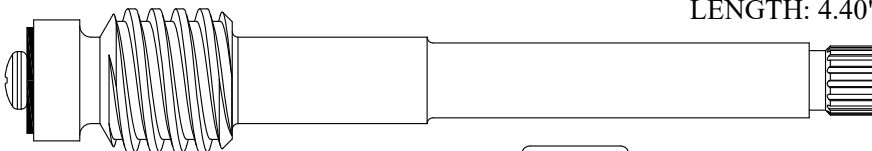

LF271081/ LF271082



SEAT USED: LF649200

15
3-27

FOR WOLVERINE

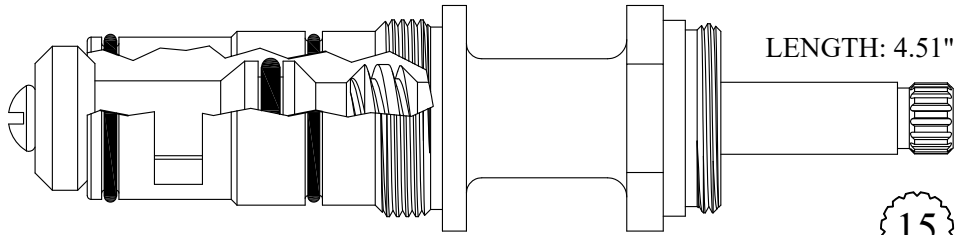

431071

15
3-27

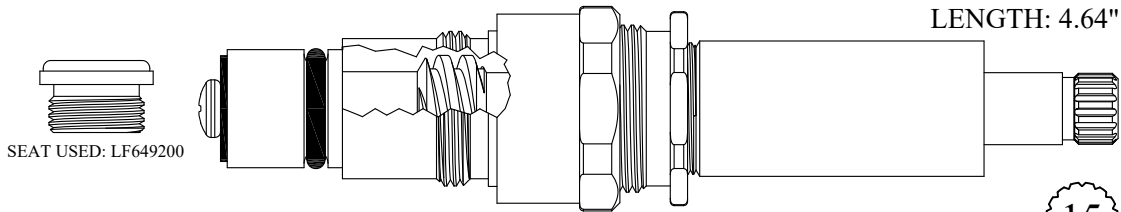

407901

GASKET INCLUDED: 895150

15
3-27

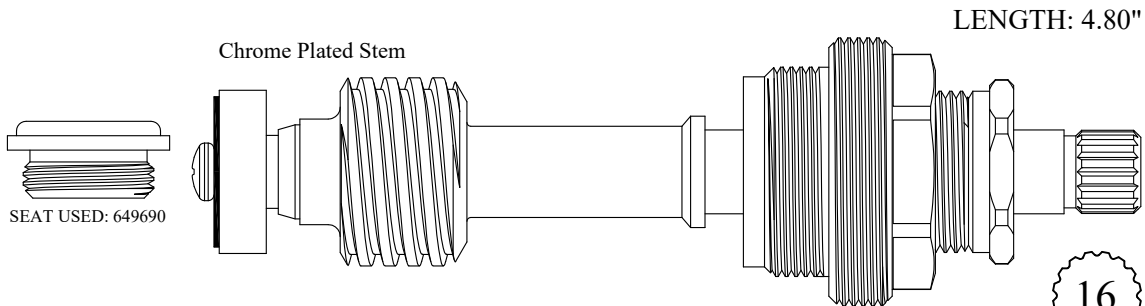

410101/ 410102

GASKET INCLUDED: 895450

210101/ 210102 Stem Only

16
3-26

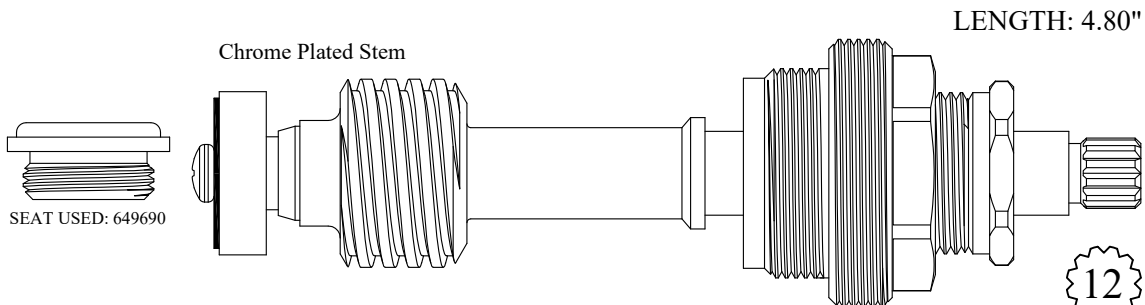

410151/ 410152

GASKET INCLUDED: 895450

210151/ 210152 Stem Only

12
1-2

FOR WOLVERINE

Chrome Plated Gland

LENGTH: 4.90"

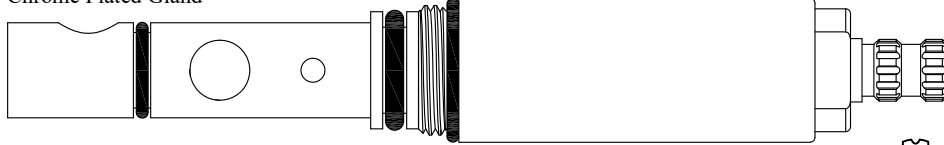

431240

GASKET: 890160 O-RING INCLUDED

12

3-5

Chrome Plated Stem

LENGTH: 5.18"

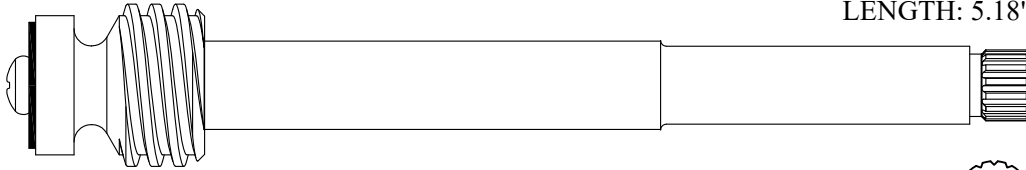

215921

15

3-27

Chrome Plated Stem

LENGTH: 5.18"

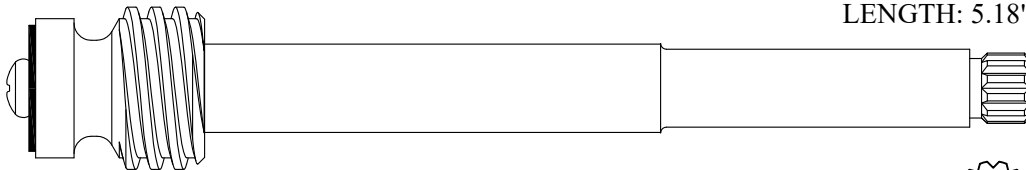

215971

12

1-2

Chrome Plated Stem

LENGTH: 5.18"

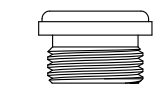

SEAT USED: LF649200

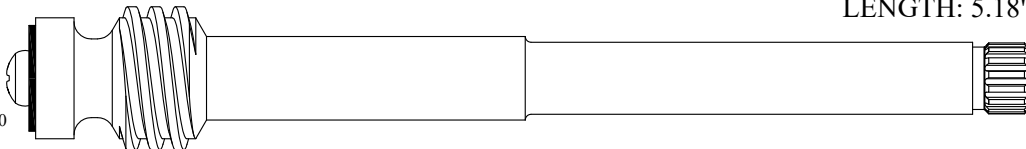

LF280021/ LF280022

15

3-27

FOR WOLVERINE

Chrome Plated Stem

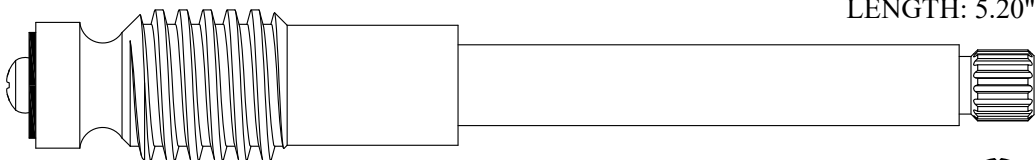

LENGTH: 5.20"

LF279821/ LF279822

15

3-27

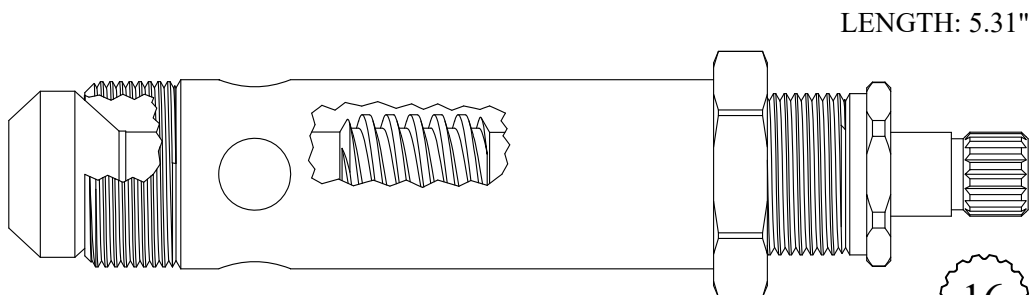

LENGTH: 5.31"

433381

GASKET INCLUDED: 895550

233381 Stem Only

16

3-26

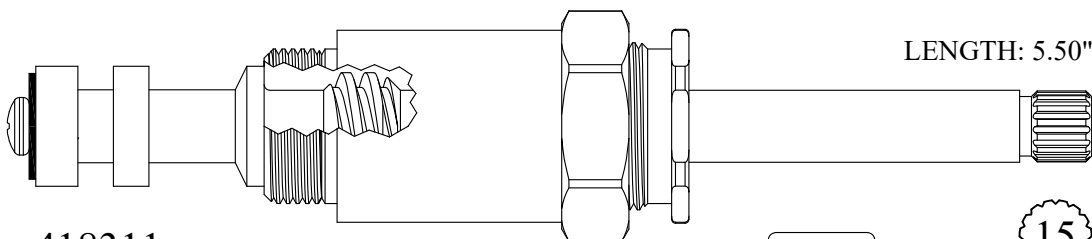

LENGTH: 5.50"

418311

GASKET INCLUDED: 895150

15

3-27

SEAT USED: LF649200

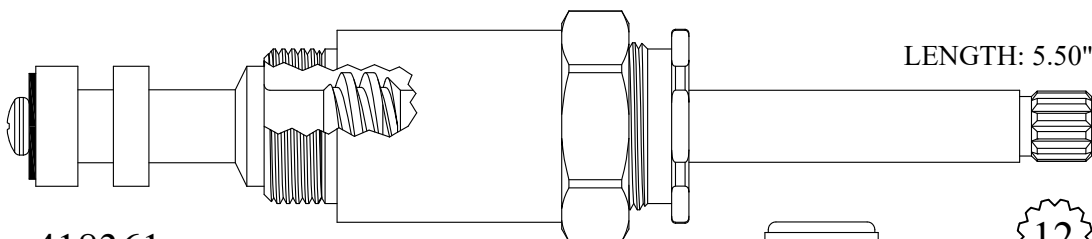

LENGTH: 5.50"

418361

GASKET INCLUDED: 895150

12

1-2

SEAT USED: LF649200

FOR WOLVERINE

Chrome Plated Stem

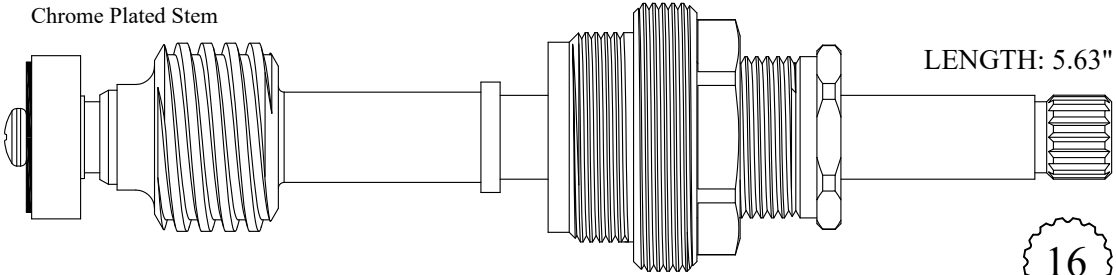

LENGTH: 5.63"

422011/ 422012

GASKET INCLUDED: 895450

222011/ 222012 Stem Only



SEAT USED: 649690

16

3-26

Chrome Plated Stem

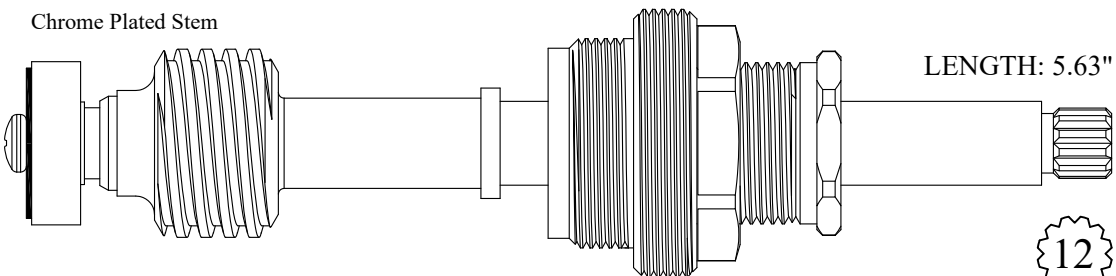

LENGTH: 5.63"

422061/ 422062

GASKET INCLUDED: 895450

222061/ 222062 Stem Only



SEAT USED: 649690

12

1-2

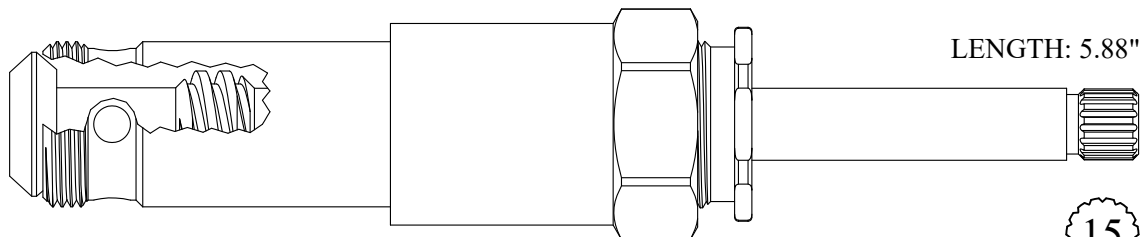

LENGTH: 5.88"

436711

GASKET INCLUDED: 895400

15

3-27

Chrome Plated Stem

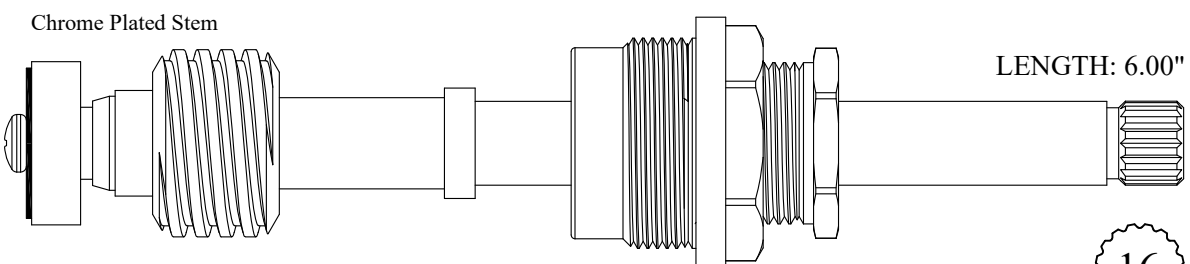

LENGTH: 6.00"

426201

GASKET INCLUDED: 895450

226201 Stem Only

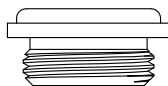

SEAT USED: 649690

16

3-26

FOR WOLVERINE

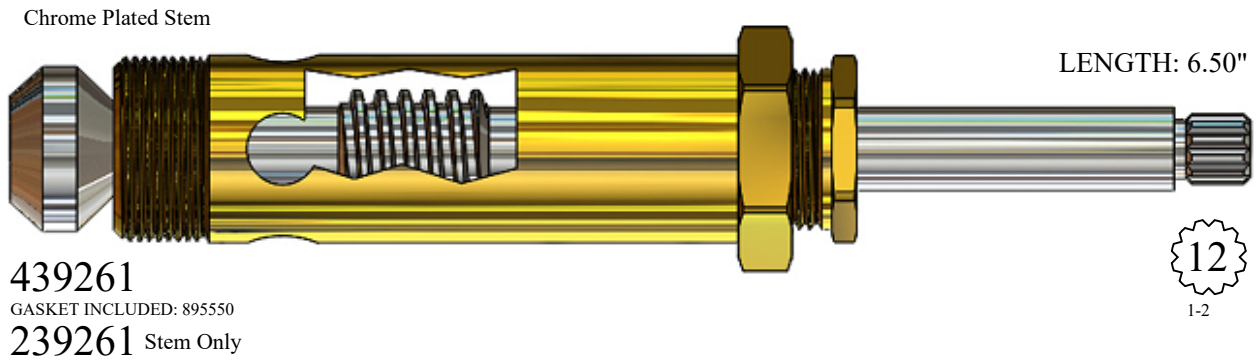
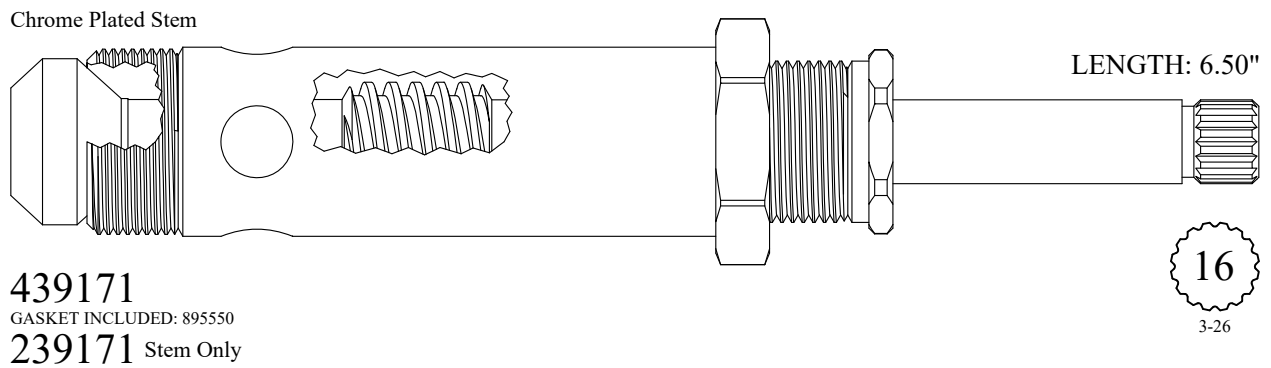
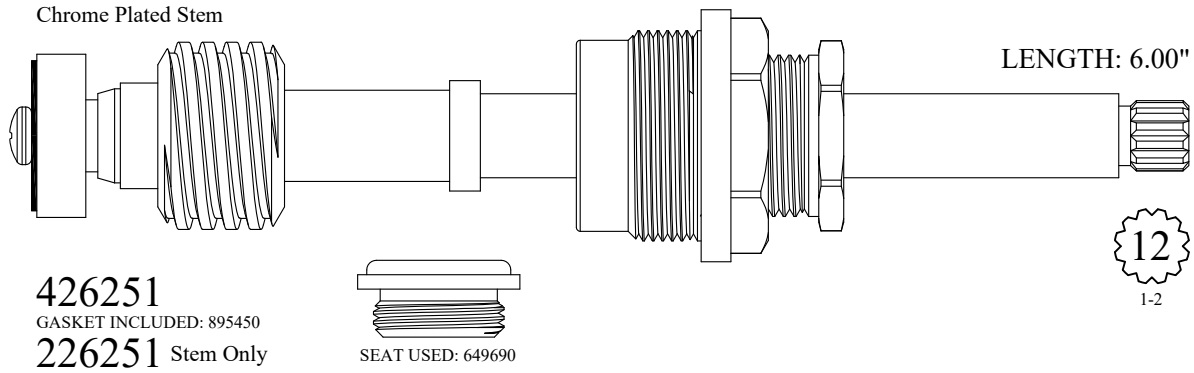

FOR YUGO

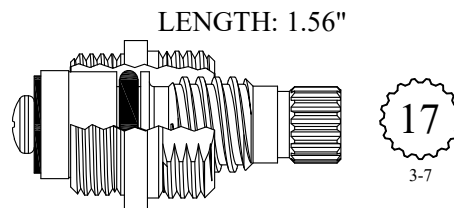

LF452191/ LF452192
GASKET INCLUDED: 895100

FOR ZURN

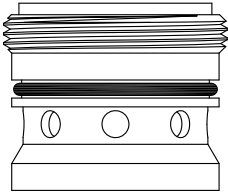

SEAT KIT USED: 106090

205511 Stem Only
GASKET: 895500 INCLUDED
OEM # TA-10/Zurn RK7000-50

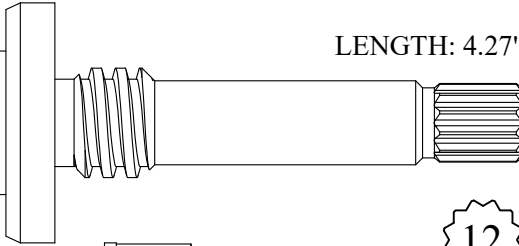

LENGTH: 4.27"



Symmons Small

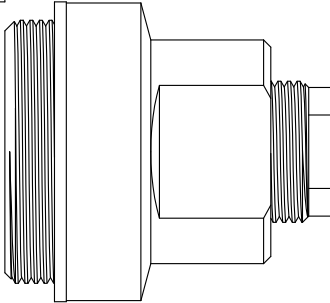

Also available with
bonnet assembly
#705511
405511

UNKNOWN

LENGTH: 1.19"



401001

UNKNOWN
LENGTH: 1.29"



400781

UNKNOWN
STEM LENGTH: 1.39"



GASKET INCLUDED: 895110

400761

LENGTH: 1.66"

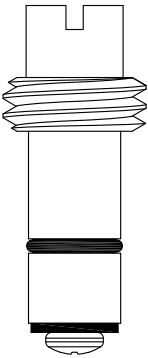

200611

LENGTH 1.70"

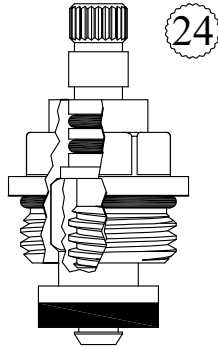

GASKET: 890170 O-RING INCLUDED

LF455942

LENGTH: 1.75"

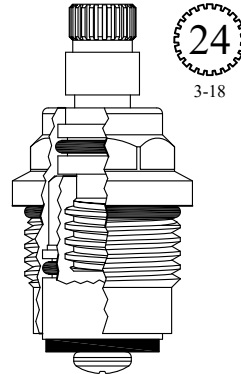

GASKET: 890170 O-RING INCLUDED

LF455422

STEM LENGTH: 1.75"
LENGTH: 1.85"

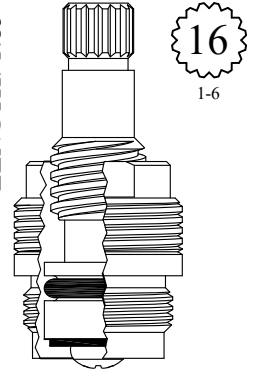

LF454051
LF454052

LENGTH: 1.76"



GASKET: 890170 O-RING INCLUDED

LF453281
LF453282

LENGTH: 1.78"

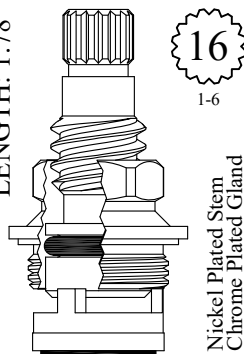

GASKET INCLUDED: 895100

LF455141
LF455142

Nickel Plated Stem
Chrome Plated Gland

LENGTH: 1.82"



GASKET: 890170 O-RING INCLUDED

LF455701
LF455702

UNKNOWN
LENGTH: 1.82"



200841

UNKNOWN

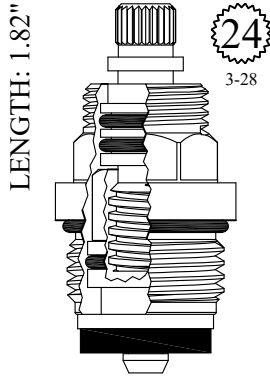

GASKET: 890170 O-RING INCLUDED

LF456422

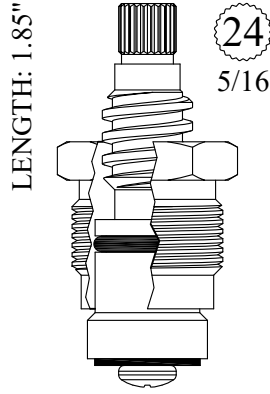

LF456141

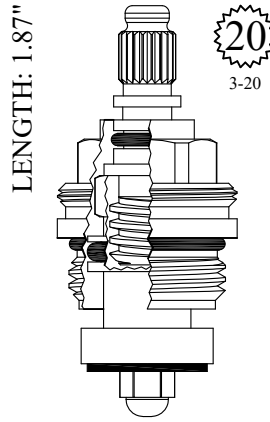

GASKET: 890170 O-RING INCLUDED

LF456462



400801
400802



431580

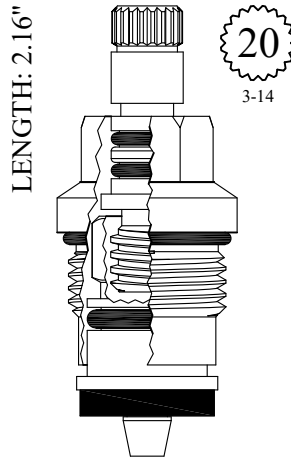

GASKET: 890180 O-RING INCLUDED

LF459482

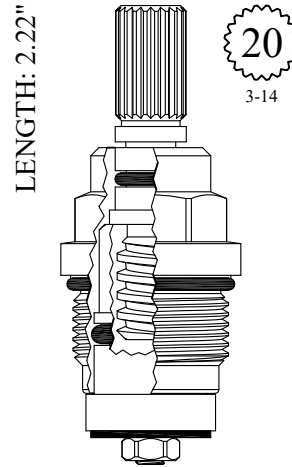

GASKET: 890180 O-RING INCLUDED

LF460272

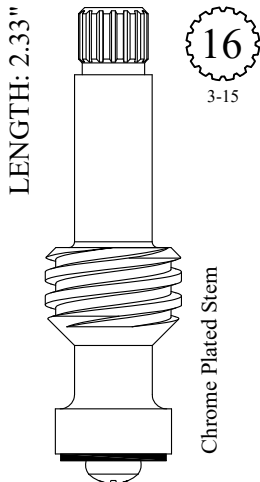

201191
201192

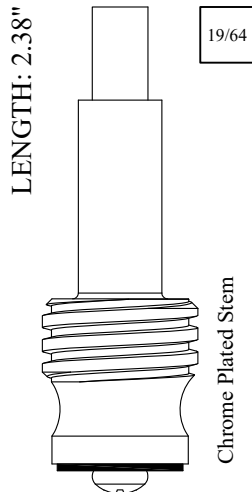

201331



GASKET: 890170 & 890190 O-RING INCLUDED

431720

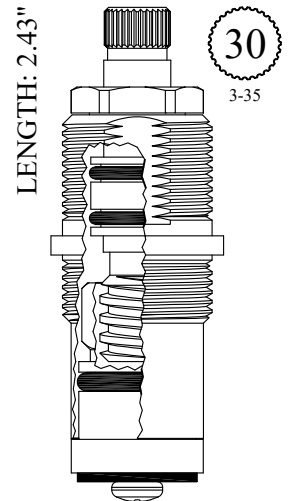

LF463302

UNKNOWN

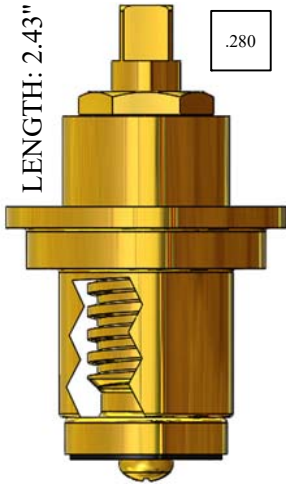

483511

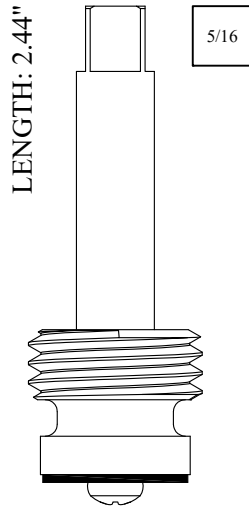

152981

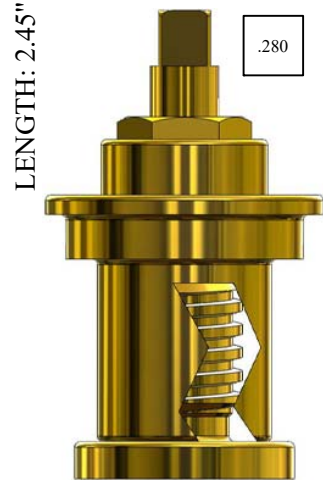

483491

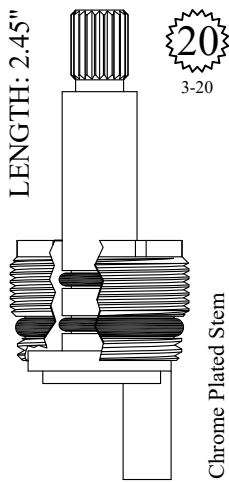

GASKET: 891150 O-RING INCLUDED

431100

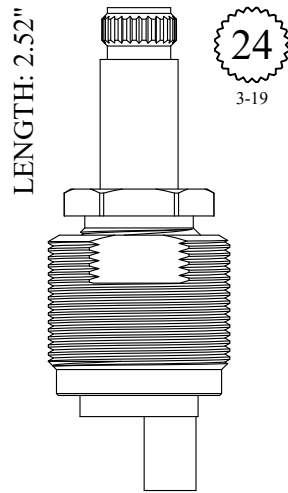

430680
230680 Stem Only

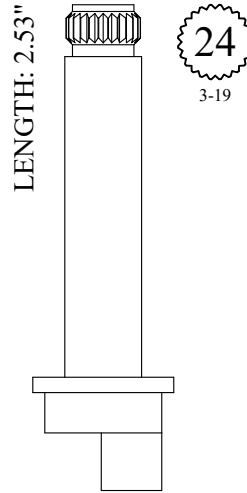

230890

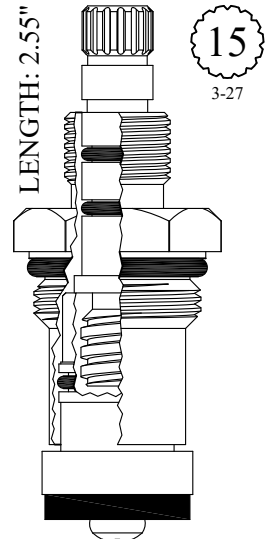

GASKET INCLUDED: 891160

LF464391
LF464392

UNKNOWN

LENGTH: 2.62"

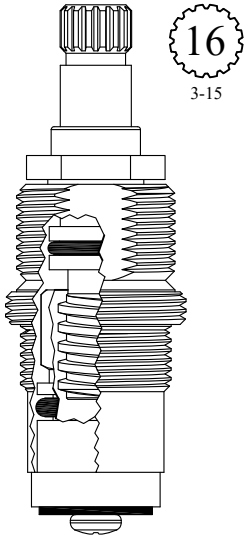

GASKET INCLUDED: 895140

LF464602

LENGTH: 2.69"

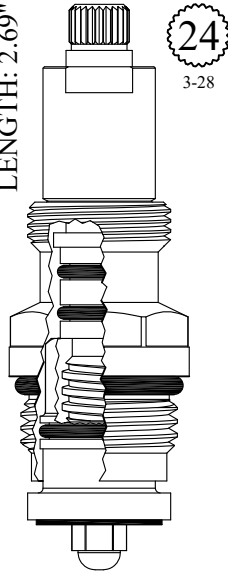

GASKET: 891150 O-RING INCLUDED

LF464712

LENGTH: 2.64"



465971

LENGTH: 2.78"

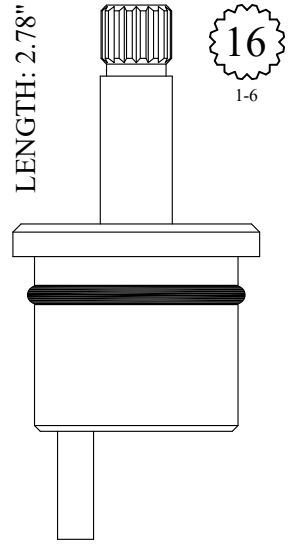

230860

LENGTH: 2.83"

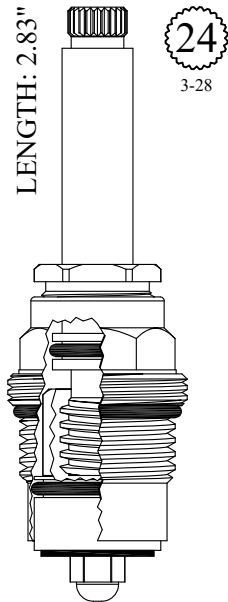

GASKET: 890180 O-RING INCLUDED

LF464962

LENGTH: 2.85"

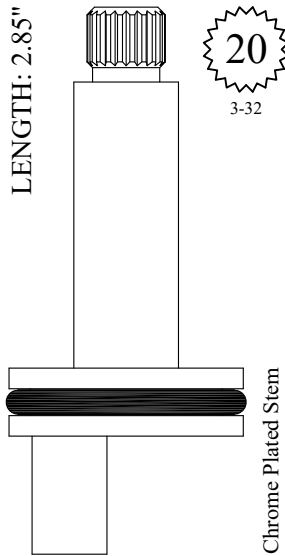

231090

LENGTH: 2.90"



LF465500

LENGTH: 2.94"

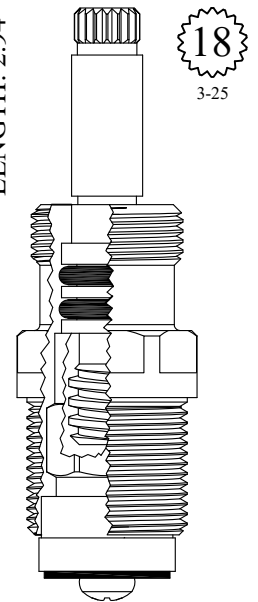

GASKET INCLUDED: 895180

401722

UNKNOWN

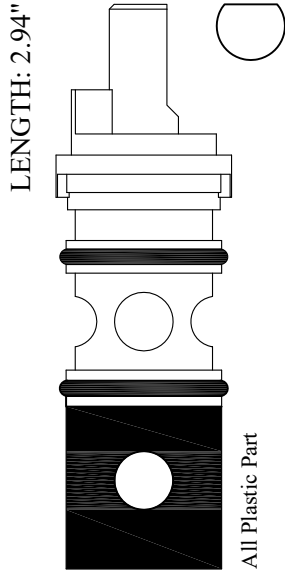

430160

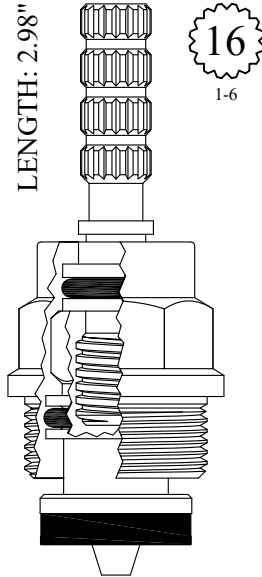

GASKET INCLUDED: 895330

LF465702

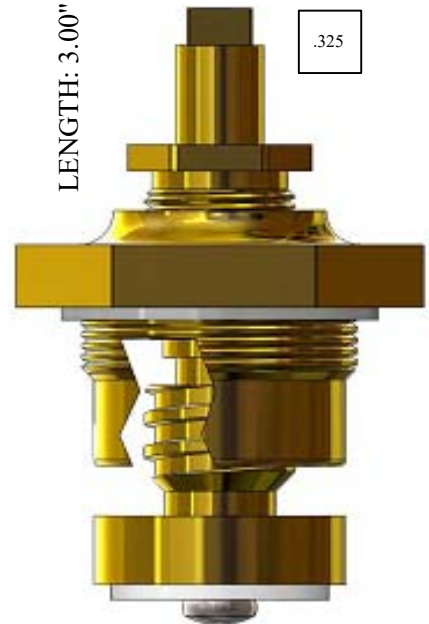

GASKET INCLUDED: 895500

465991

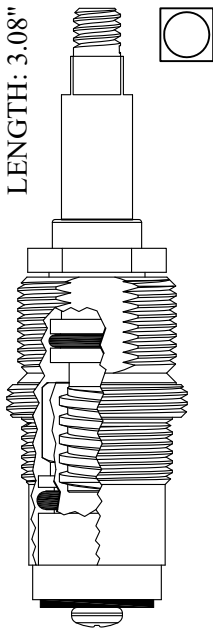

GASKET INCLUDED: 895160

LF466532

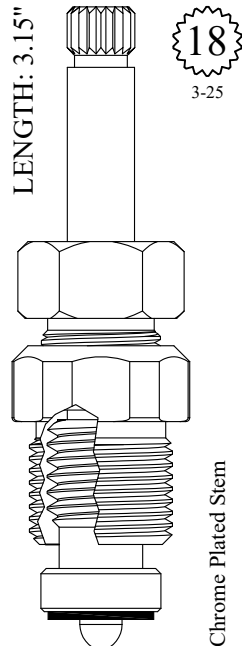

GASKET INCLUDED: 895100

LF466811

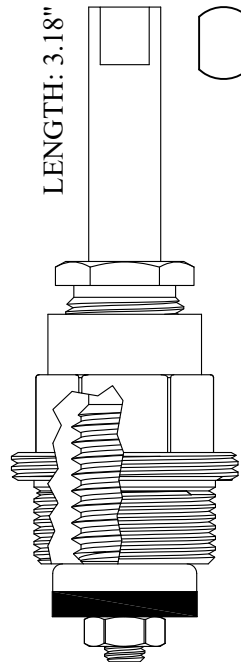

GASKET INCLUDED: 895330

401751

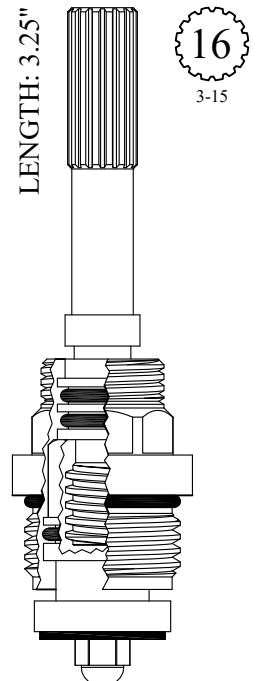

GASKET: 890170 O-RING INCLUDED

402472

UNKNOWN

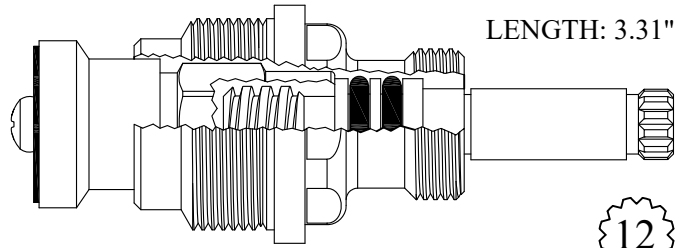

402522
GASKET INCLUDED: 895450

12
1-2

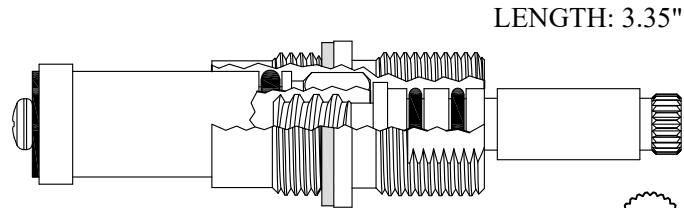

LF466822
GASKET INCLUDED: 895100

24
3-28

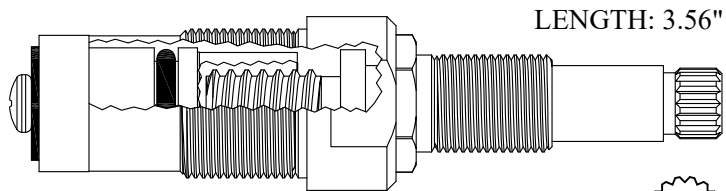

402782
GASKET INCLUDED: 895140

16
1-6

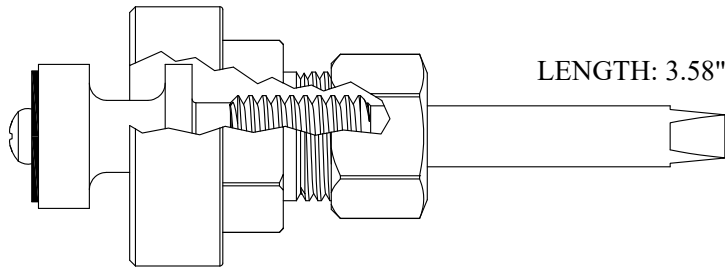

468231
GASKET INCLUDED: 894970

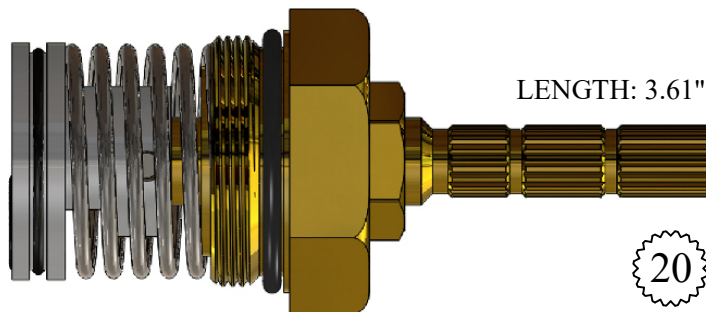

431770
GASKET: 891220 O-RING INCLUDED

20
3-14

UNKNOWN

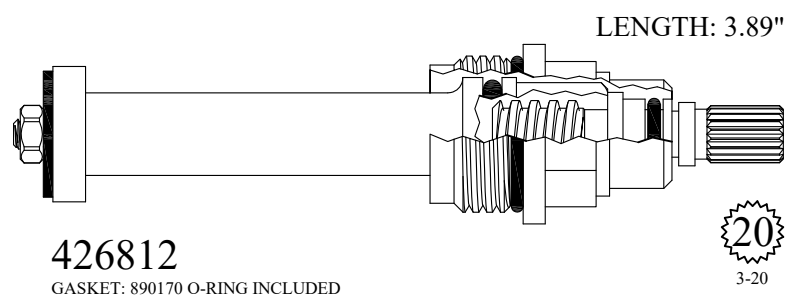
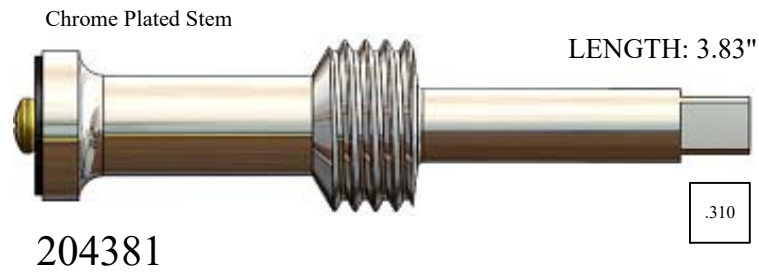
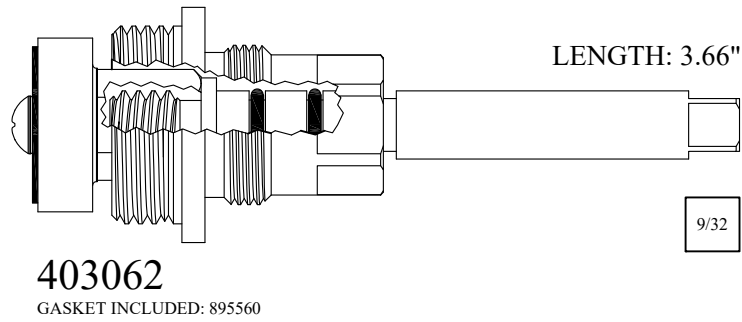
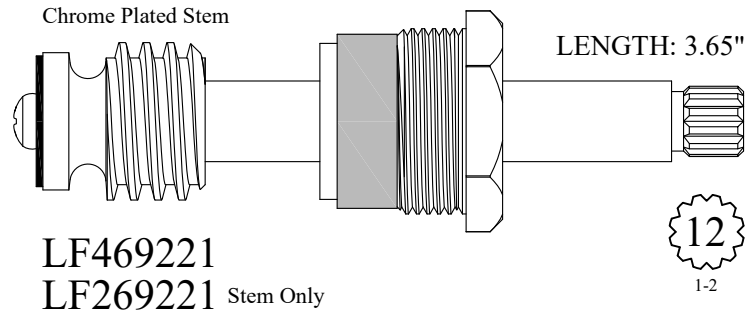

UNKNOWN



LENGTH: 3.91"

431491

GASKET INCLUDED: 895560

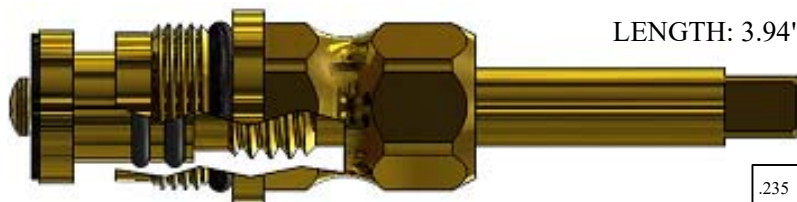

LENGTH: 3.94"

LF470241/ LF470242

GASKET: 891160 O-RING INCLUDED

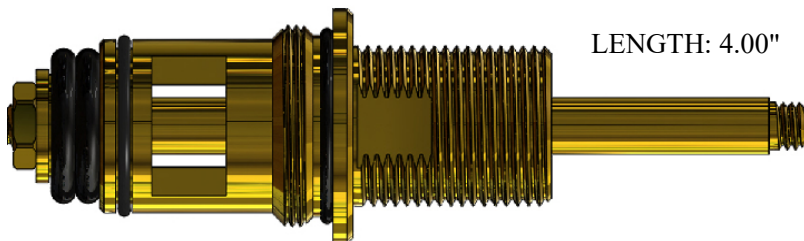

LENGTH: 4.00"

431650

GASKET: 890190 O-RING INCLUDED

1/4-20
Thread

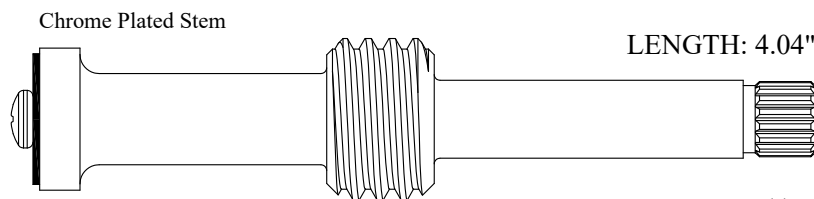

Chrome Plated Stem

LENGTH: 4.04"

204061

Supplied with
12pt. Broach



1-2

UNKNOWN

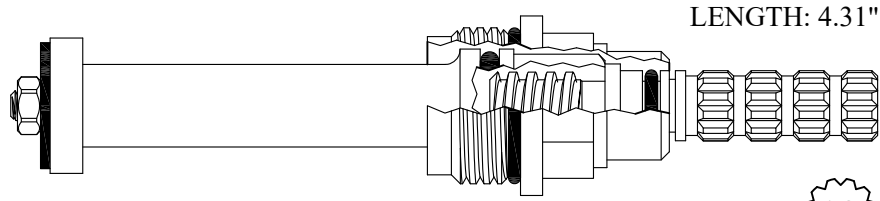

426862

GASKET: 890170 O-RING INCLUDED

12

1-2

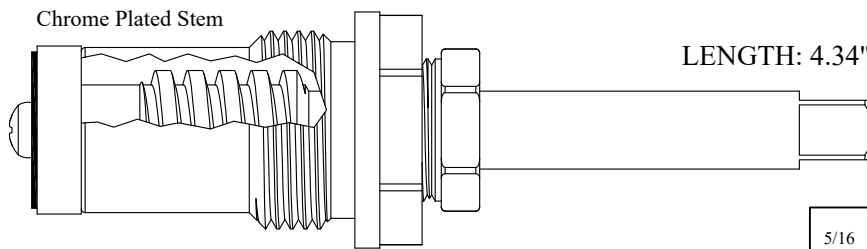

405321

GASKET INCLUDED: 895560

205321 Stem Only

5/16

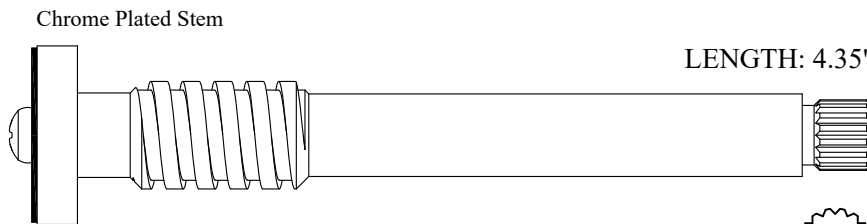

206211

16

1-6



208041

.280

UNKNOWN

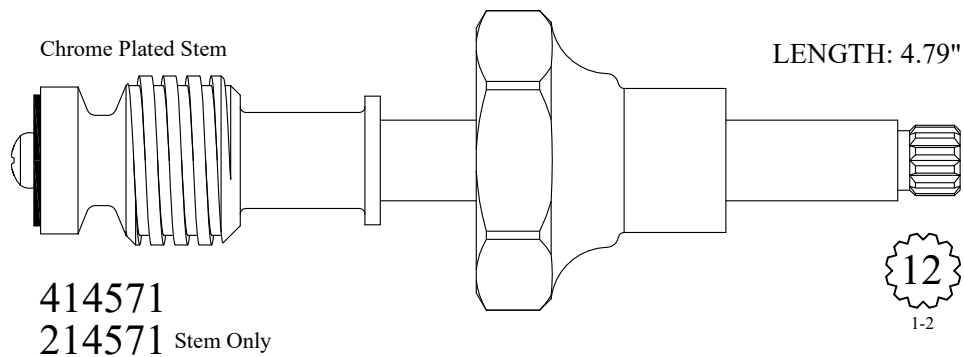
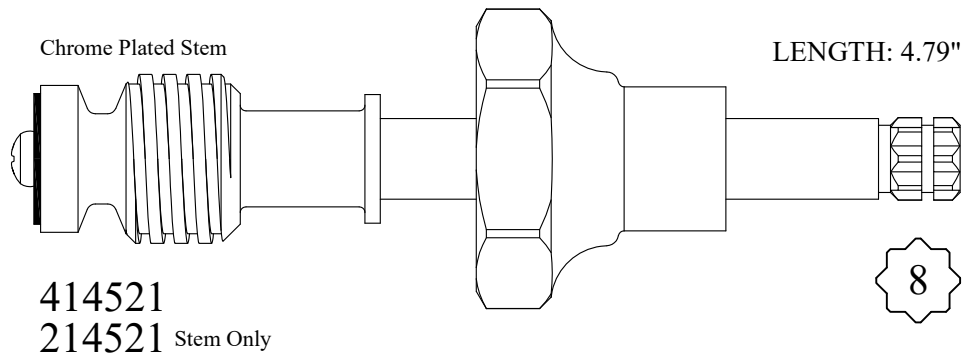
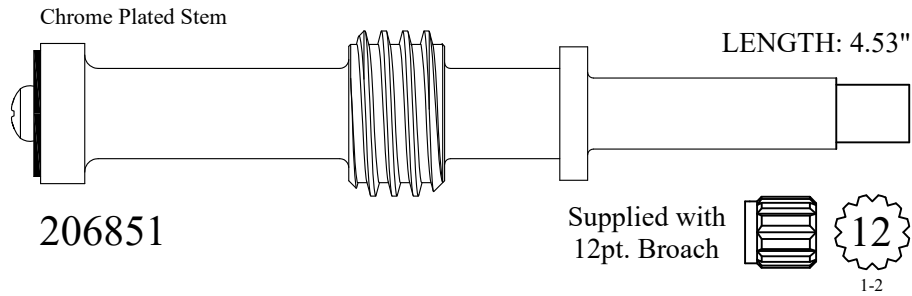
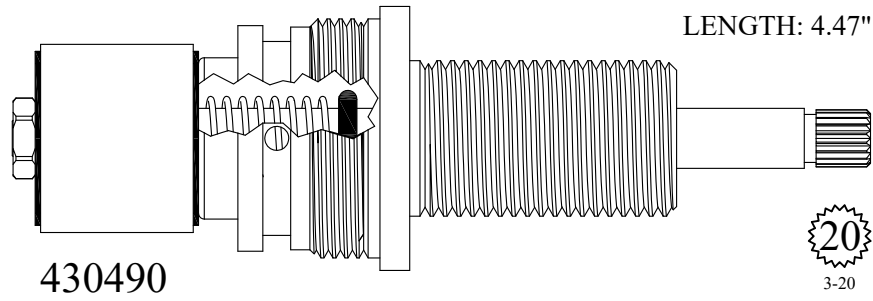
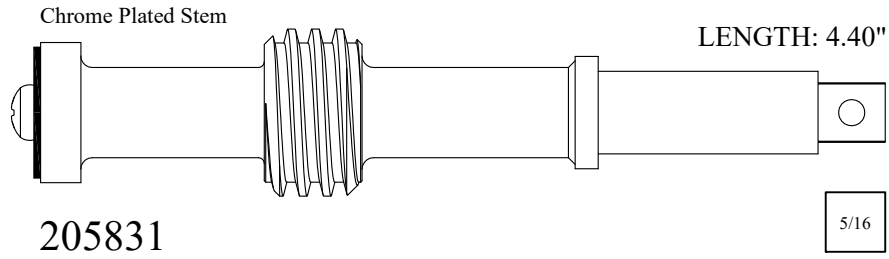

UNKNOWN

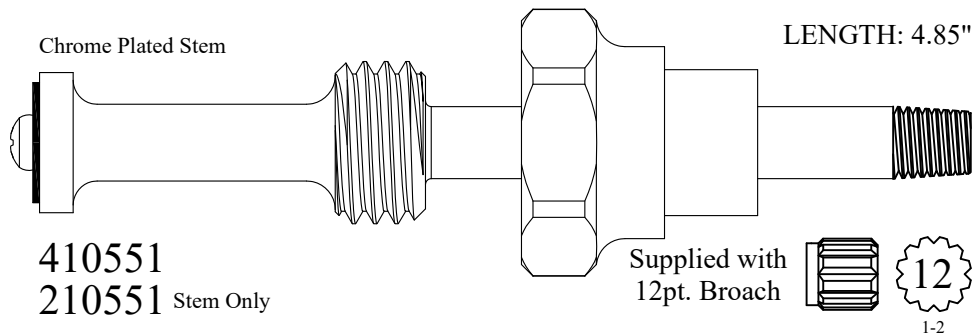
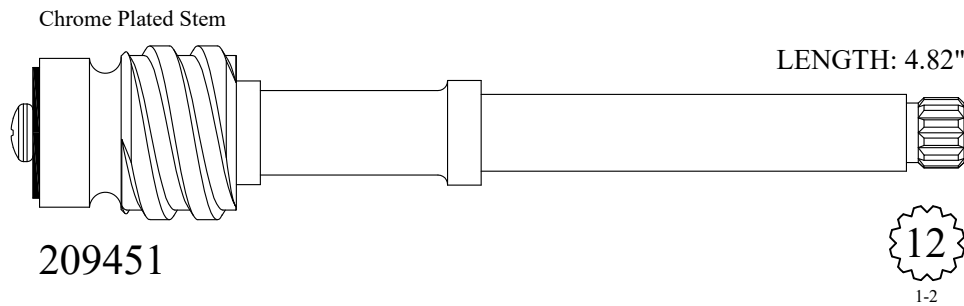
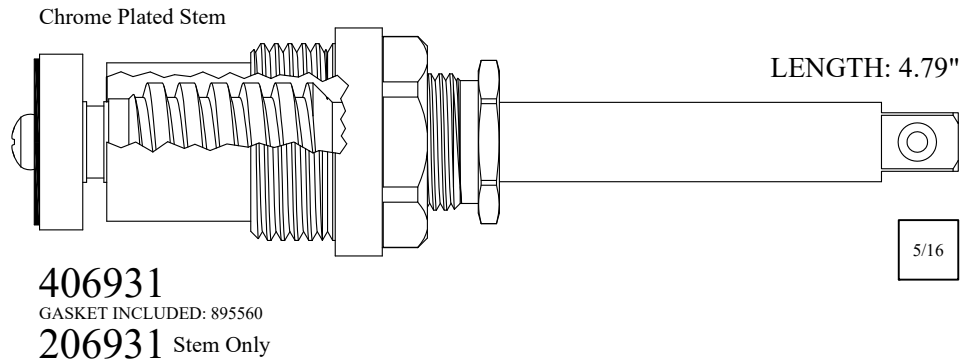

UNKNOWN

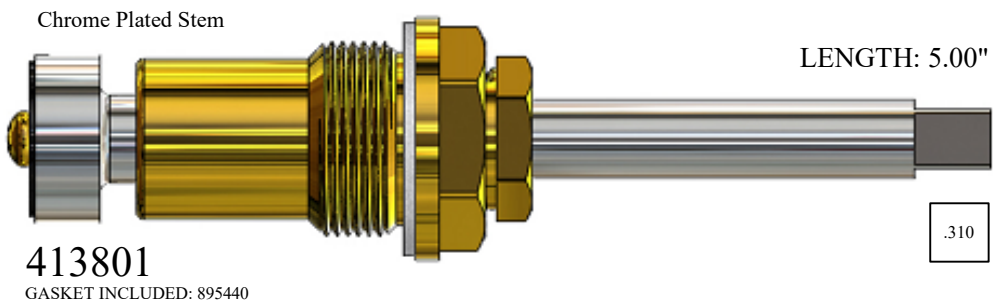
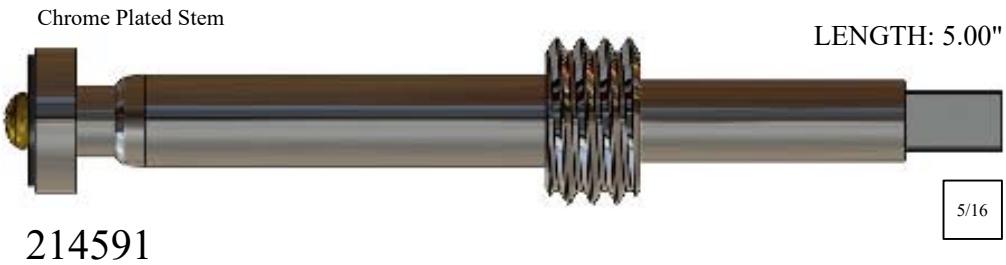
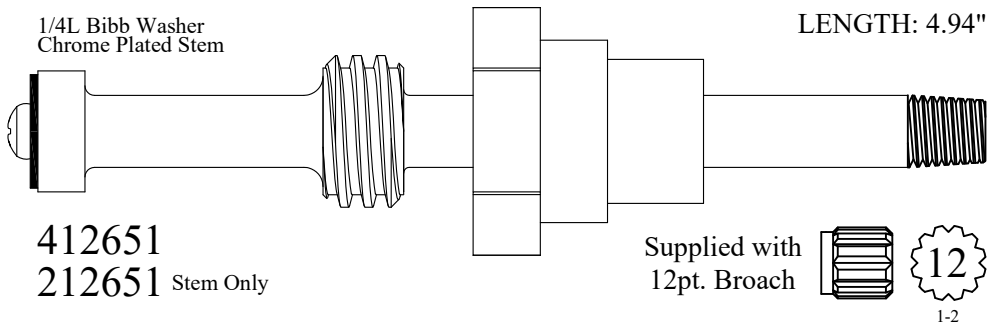
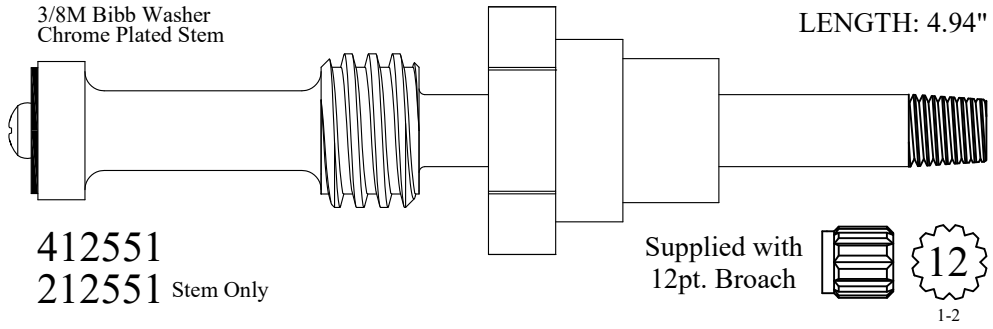

UNKNOWN

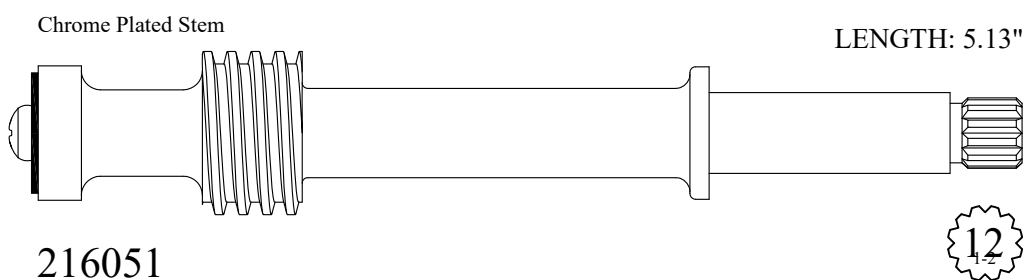
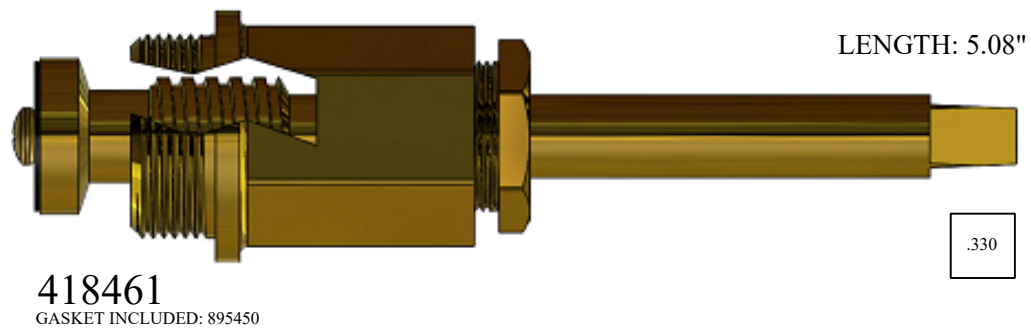
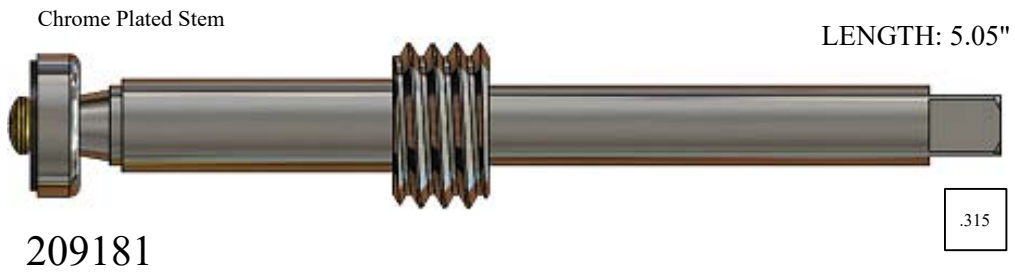
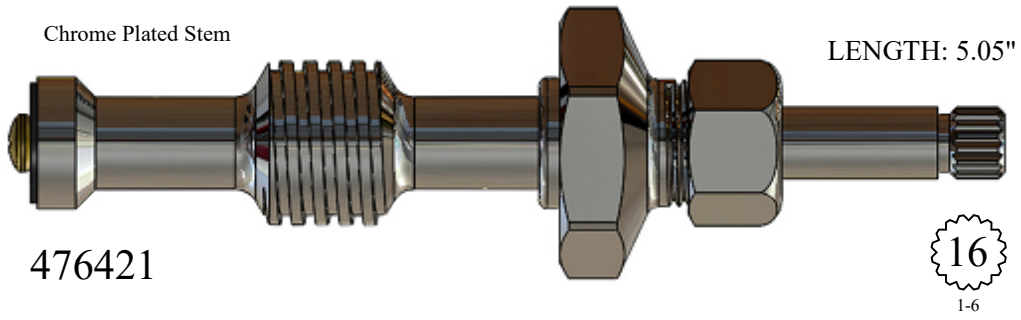
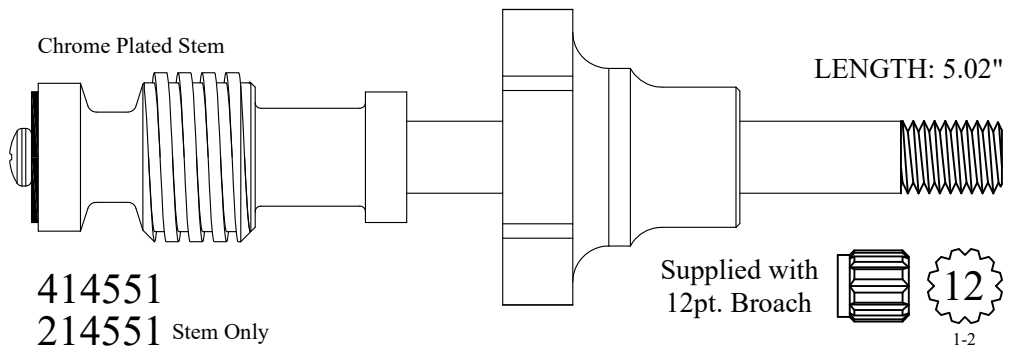

UNKNOWN

Chrome Plated Stem

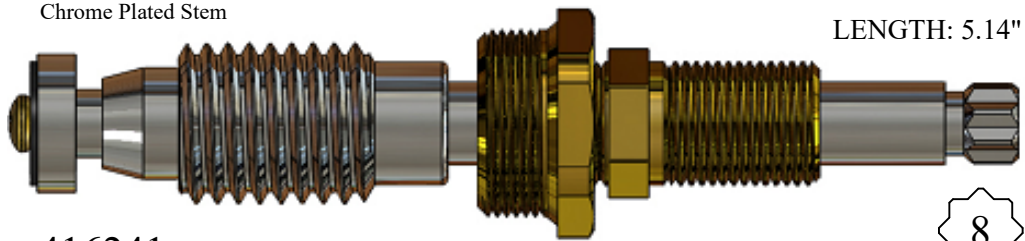

LENGTH: 5.14"

416241

GASKET INCLUDED: 895550

8



LENGTH: 5.18"

219511

12

1-2

Chrome Plated Stem

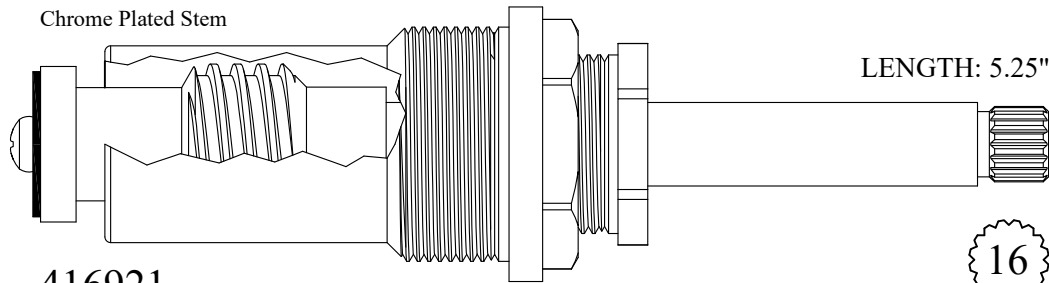

LENGTH: 5.25"

416921

16

1-5

Chrome Plated Stem

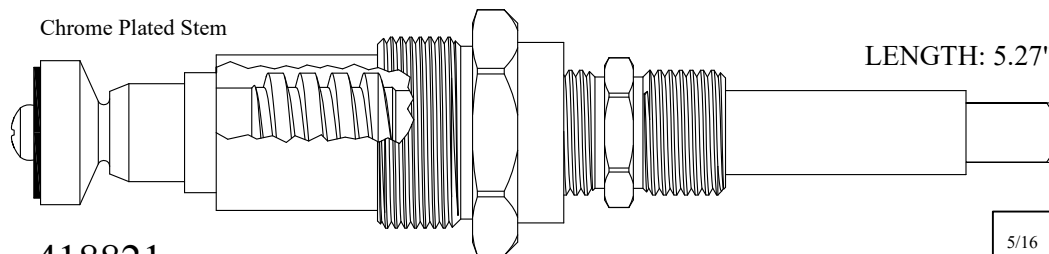

LENGTH: 5.27"

418821

GASKET INCLUDED: 895550

218821 Stem Only

5/16

UNKNOWN

Chrome Plated Stem

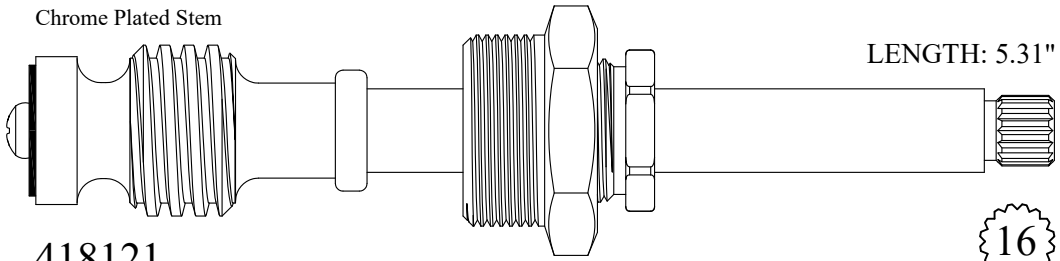

LENGTH: 5.31"

418121

GASKET INCLUDED: 895550

218121 Stem Only

16
1-6

Chrome Plated Stem

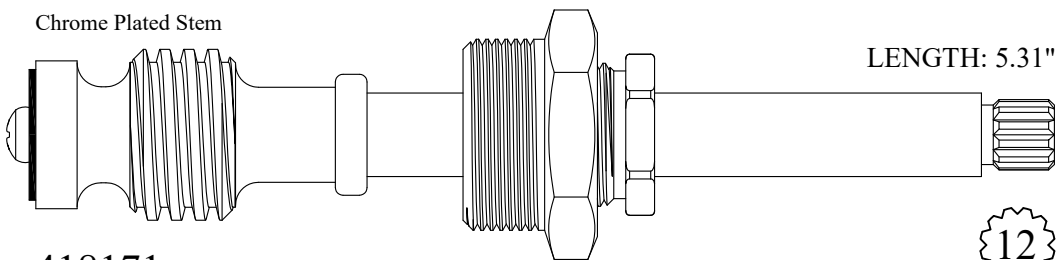

LENGTH: 5.31"

418171

GASKET INCLUDED: 895340

218171 Stem Only

12
1-2

Chrome Plated Stem

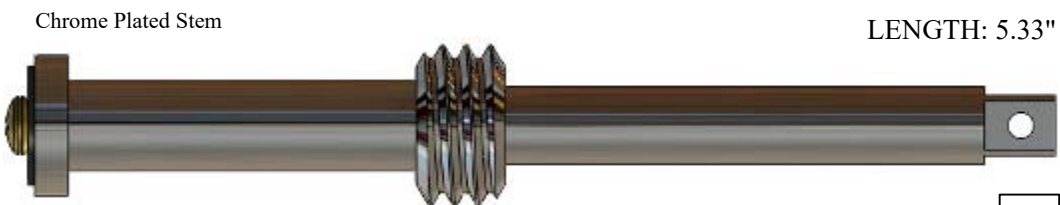

LENGTH: 5.33"

217741

.315

Chrome Plated Stem

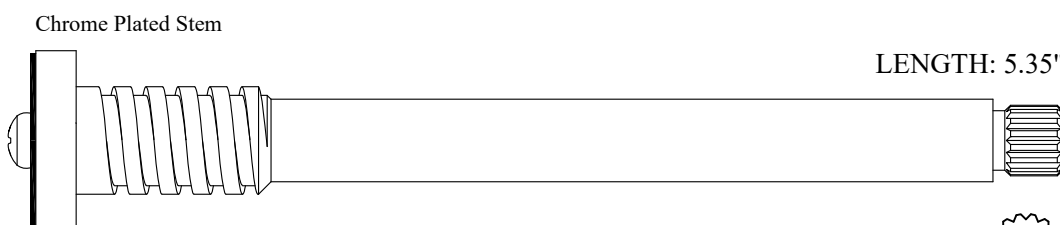

LENGTH: 5.35"

218111

16
1-6

UNKNOWN

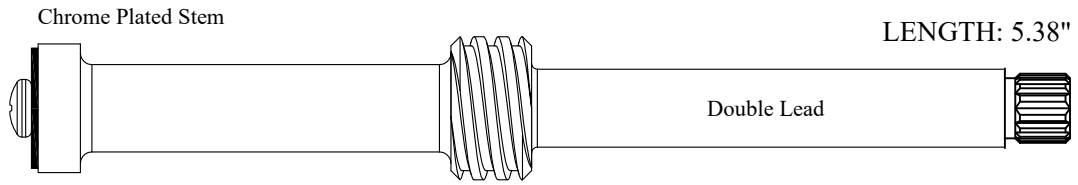

219161/ 219162

Supplied with
12pt. Broach

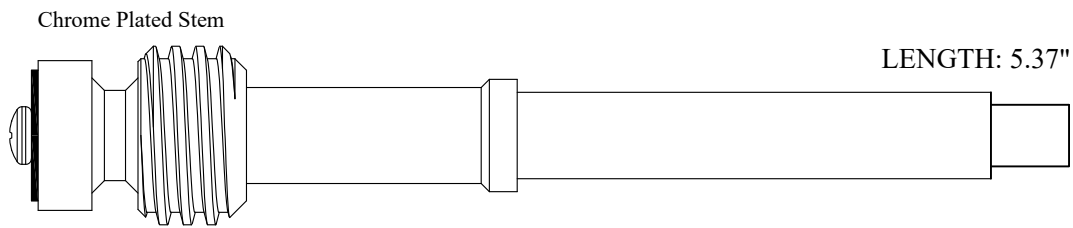
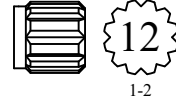

224151

Supplied with
12pt. Broach

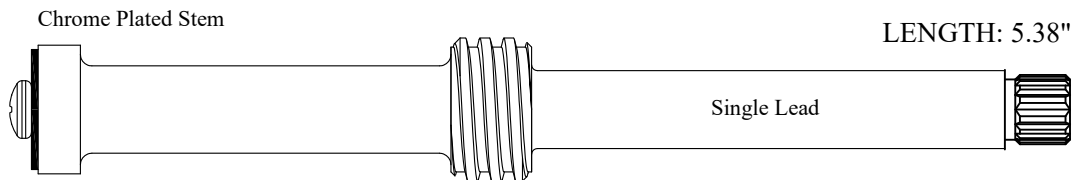
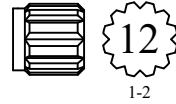

219151

Supplied with
12pt. Broach

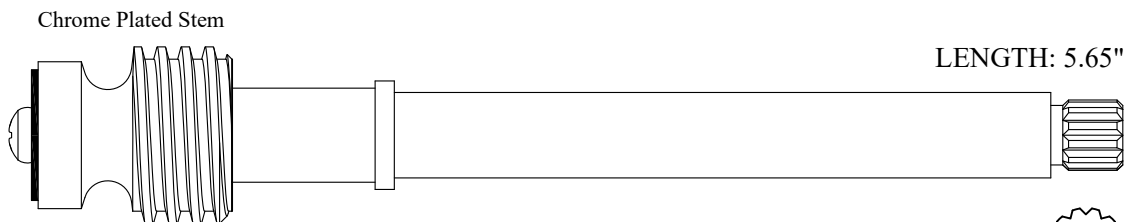
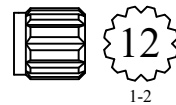

223751



UNKNOWN

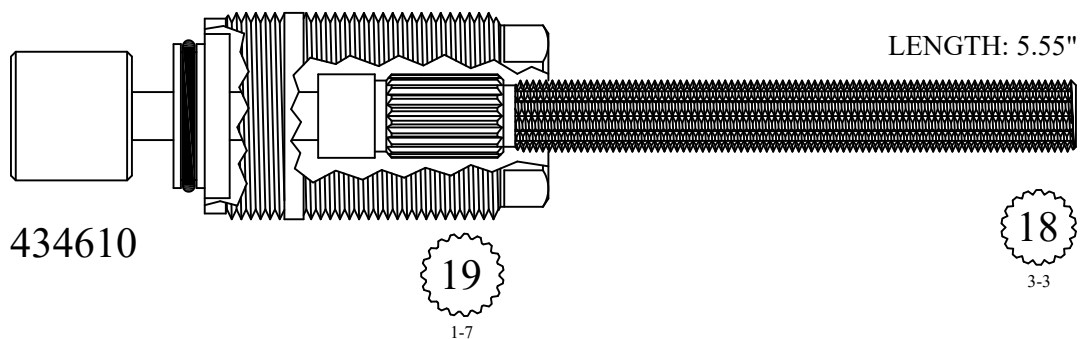
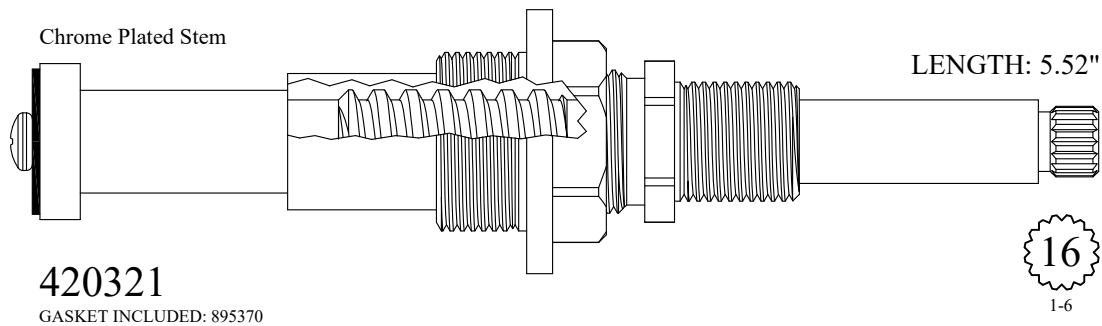
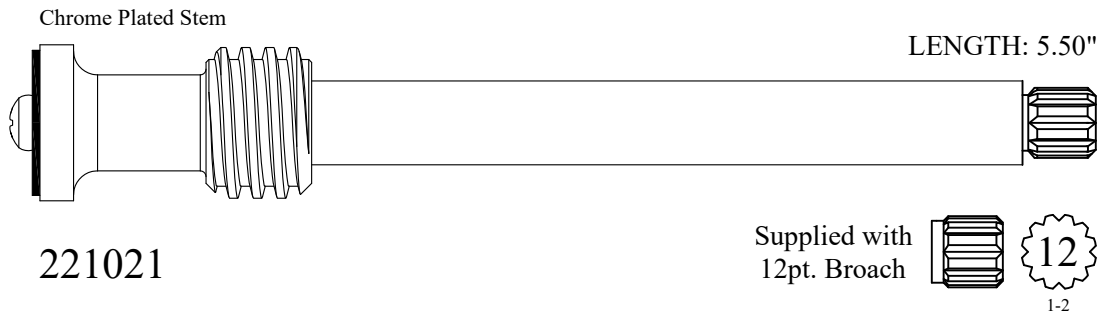
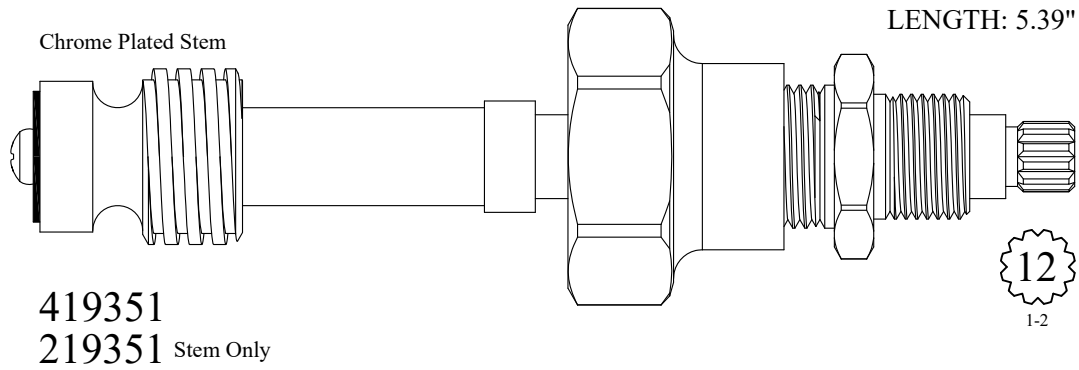

UNKNOWN

Chrome Plated Stem

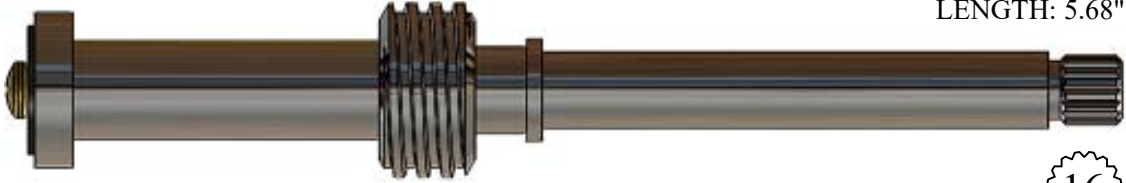

LENGTH: 5.68"

224331

16
1-6

Chrome Plated Stem

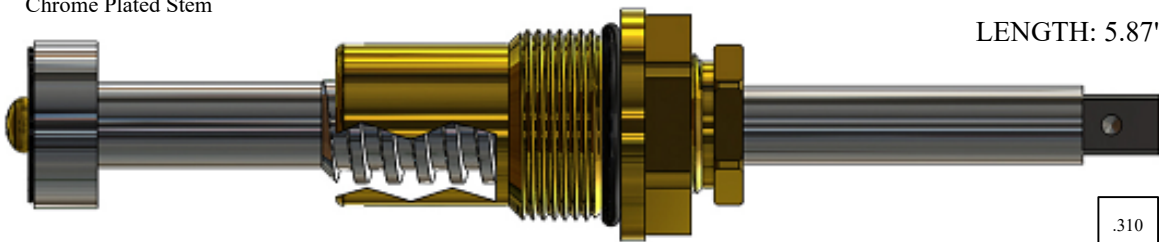

LENGTH: 5.87"

425971

GASKET: 891180 O-RING INCLUDED

.310

Chrome Plated Stem

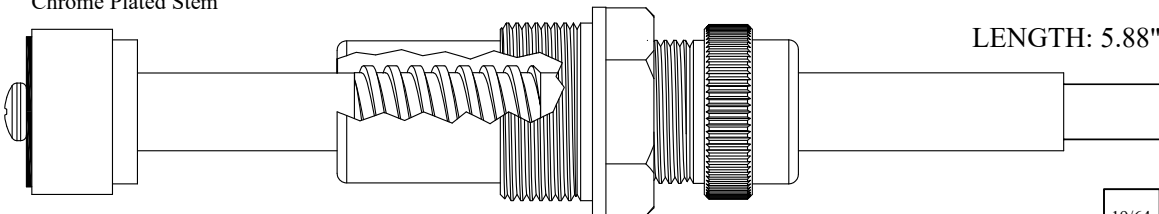

LENGTH: 5.88"

426261

GASKET INCLUDED: 895320

19/64

LENGTH: 5.90"



237080

16
1-6

UNKNOWN

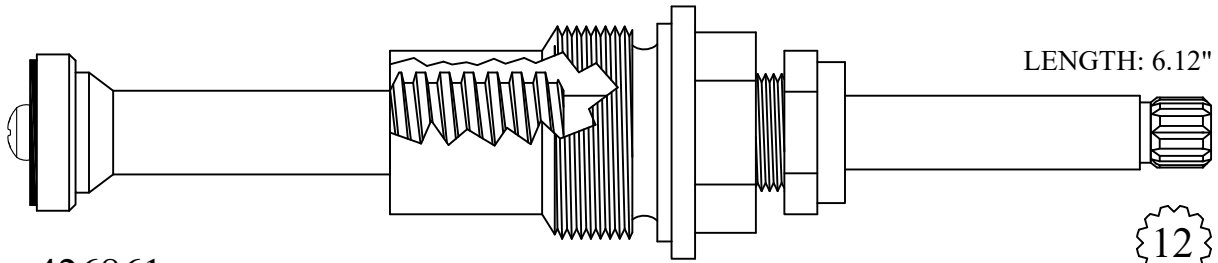

426861

GASKET INCLUDED: 895450

12
1-2

Chrome Plated Unit



427401

.280

Chrome Plated Stem



226981

.310

Chrome Plated Stem

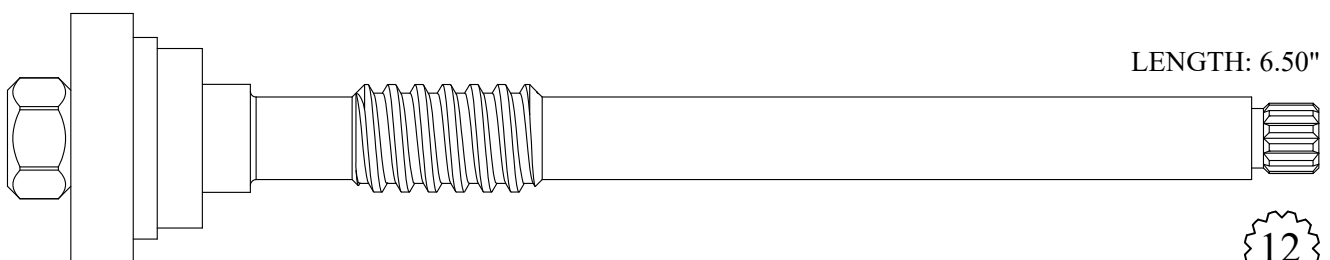

227461

12
1-2