

FOR CONCINNY  
LENGTH: 0.94"

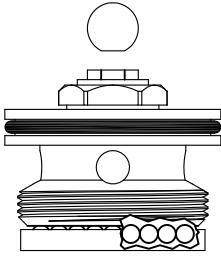

LF450111  
LF450112



SEAT USED: 647140

FOR MILWAUKEE  
LENGTH: 1.04"

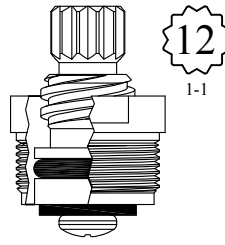

GASKET: 895100

LF450011  
LF450012



SEAT USED: LF649040

FOR SPEAKMAN  
LENGTH: 1.07"

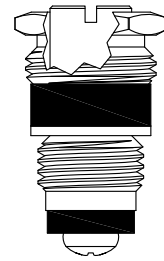

Nickel Plated Stem  
Chrome Plated Pkg Nut

LF400111  
LF200111 Stem Only

FOR CRANE  
LENGTH: 1.15"

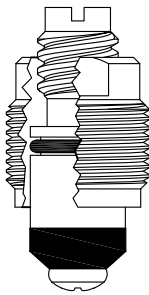

400201  
200201 Stem Only

FOR CRANE  
LENGTH: 1.15"

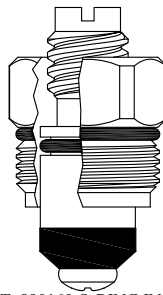

GASKET: 890160 O-RING INCLUDED

400211  
200201 Stem Only

FOR ELJER  
LENGTH: 1.16"

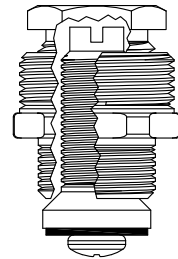

GASKET: 895060

400101

FOR GERBER  
LENGTH: 1.19"

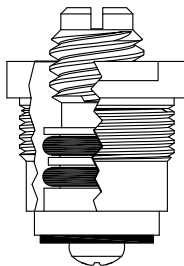

GASKET: 895150

400381

FOR GRAND HAVEN  
LENGTH: 1.19"

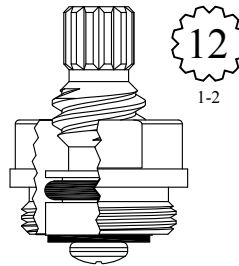

GASKET: 895160

LF450021



SEAT USED: LF649270

FOR ELJER  
LENGTH: 1.19"

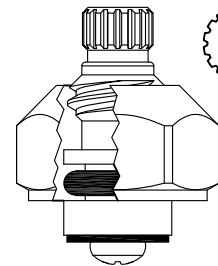

16  
3-15

Nickel Plated Gland

LF450031  
LF450032

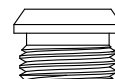

SEAT USED: LF648320

FOR CONCINITY  
LENGTH: 1.19"

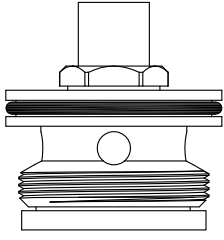

LF450161  
LF450162



SEAT USED: 647140

FOR DELTA  
LENGTH: 1.20"

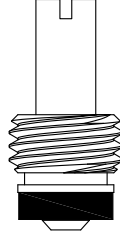

200141

FOR SPEAKMAN  
LENGTH: 1.24"

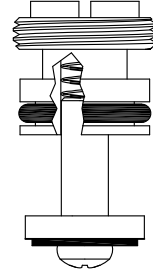

400220

FOR ARROWHEAD  
LENGTH: 1.24"

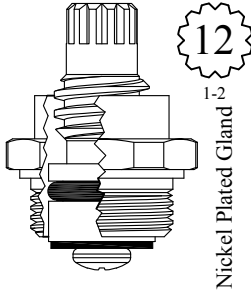

Nickel Plated Gland

GASKET: 895100

LF450041  
LF450042



SEAT USED: LF648230

FOR ELJER  
LENGTH: 1.25"

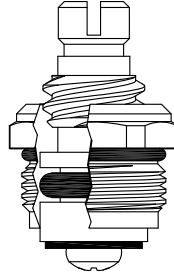

GASKET: 890160 O-RING INCLUDED

400131

FOR LAWLER  
LENGTH: 1.25"



LF200751

FOR ELJER  
LENGTH: 1.25"

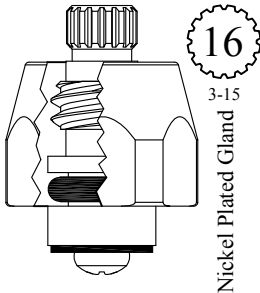

Nickel Plated Gland

LF450231  
LF450232

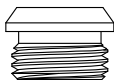

SEAT USED: LF648320

FOR ELJER  
LENGTH: 1.25"

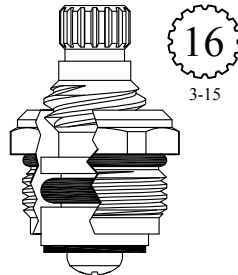

GASKET: 890160 O-RING INCLUDED

LF450851  
LF450852



SEAT USED: LF648320

FOR ELJER  
LENGTH: 1.25"

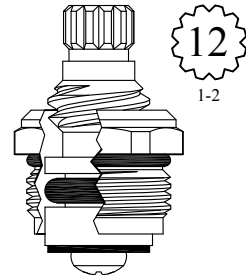

GASKET: 890160 O-RING INCLUDED

LF450861  
LF450862

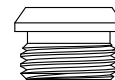

SEAT USED: LF648320

FOR BURLINGTON  
LENGTH: 1.26"

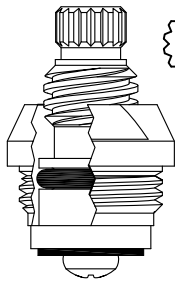

16

Nickel Plated Gland

GASKET: 895100

LF450061  
LF450062



SEAT USED: LF648700

FOR STERLING FAUCET  
LENGTH: 1.31"

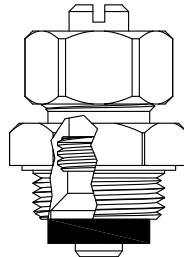

GASKET: 895100

400181

FOR SAVOY  
LENGTH: 1.31"

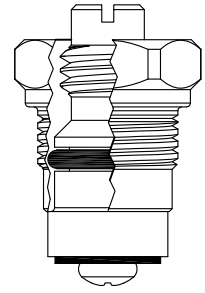

GASKET: 895100

400291

FOR STREAMLINER  
LENGTH: 1.34"

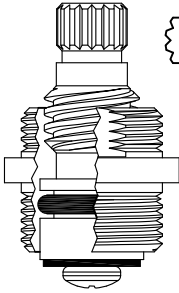

16

Nickel Plated Gland

GASKET: 895100

LF450131  
LF450132

FOR INDIANA  
LENGTH: 1.34"

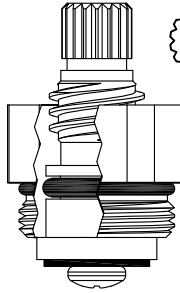

18

Nickel Plated Gland

GASKET: 890170 O-RING INCLUDED

450971

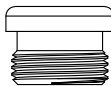

SEAT USED: LF648560

FOR INDIANA  
LENGTH: 1.34"

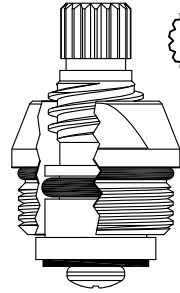

18

Nickel Plated Gland

GASKET: 890170 O-RING INCLUDED

LF451011  
LF451012

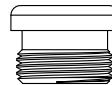

SEAT USED: LF648560

FOR CRANE  
LENGTH: 1.35"

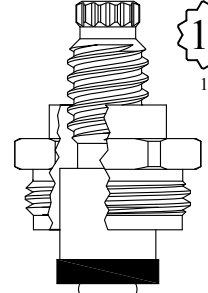

12

Nickel Plated Gland

GASKET: 895180

400411  
400412

FOR SAYCO  
LENGTH: 1.36"

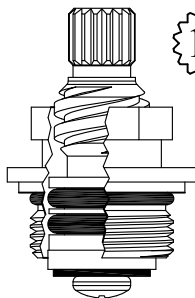

16

Nickel Plated Gland

GASKET: 890160 O-RING INCLUDED

LF450091  
LF450092

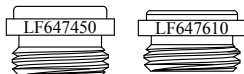

SEAT USED: LF647450 or LF647610

FOR INDIANA  
LENGTH: 1.36"

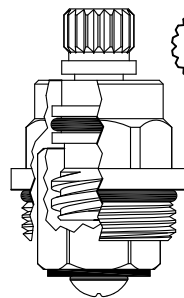

18

Chrome Plated Gland

GASKET: 890170 O-RING INCLUDED

LF450501  
LF450502

FOR SAYCO  
LENGTH: 1.36"

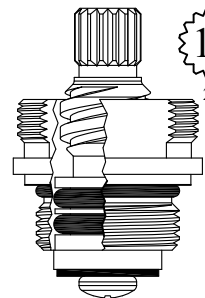

16

Nickel Plated Gland

GASKET: 890160 O-RING INCLUDED

LF451271  
LF451272



SEAT USED: LF647450

FOR SAYCO  
LENGTH: 1.37"

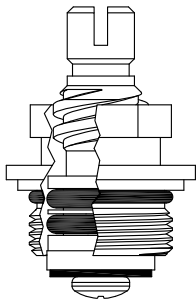

Nickel Plated Gland

GASKET: 890160 O-RING INCLUDED

400271

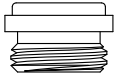

SEAT USED: LF647450

FOR SAYCO  
LENGTH: 1.37"

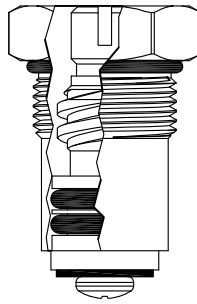

GASKET: 890170 O-RING INCLUDED

400281

FOR KOHLER  
LENGTH: 1.37"

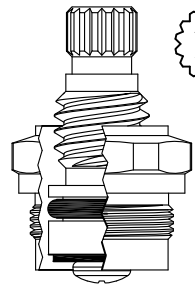

16  
1-5

Nickel Plated Gland

GASKET: 895100

LF450051  
LF450052

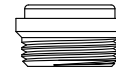

SEAT USED: LF648070

FOR STERLING FAUCET  
LENGTH: 1.37"

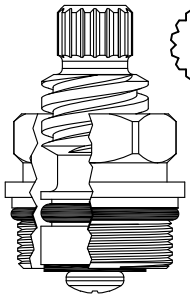

16  
1-5

GASKET: 890180 O-RING INCLUDED

LF450401  
LF450402

FOR UNION BRASS  
LENGTH: 1.38"

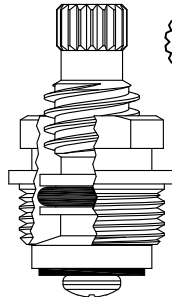

18  
3-3

GASKET: 895100

LF450071  
LF450072

FOR ELJER  
LENGTH: 1.38"

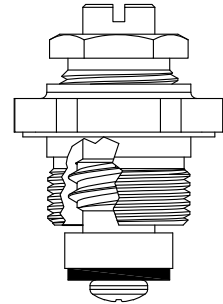

GASKET: 895100

400331  
200331

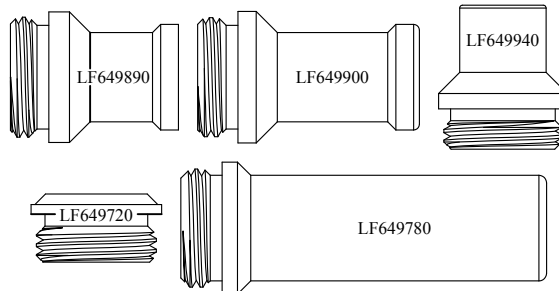

SEATS USED: LF649720,  
LF649780, LF649890,  
LF649900 or LF649940



FOR WEST BRASS (JAPAN)  
LENGTH: 1.39"

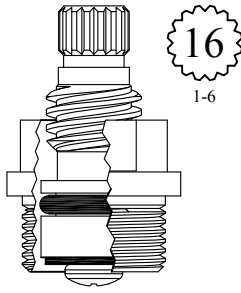

GASKET: 895100

LF450081  
LF450082



SEAT USED: LF649600

FOR WEST BRASS (ITALY)  
LENGTH: 1.39"

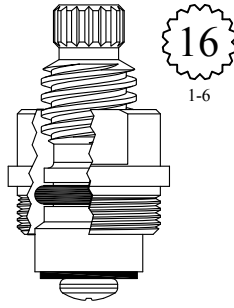

GASKET: 895100

LF450121  
LF450122



SEAT USED: LF649600

Ceramic Conversion for:  
Aqua-Seal

FOR AM STD  
LENGTH: 1.39"

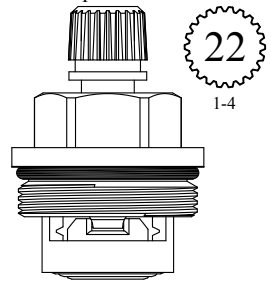

GASKET: 890180 O-RING INCLUDED

SEAL: 898500

DISC SET: 112530-PKG

LF450931  
LF450932

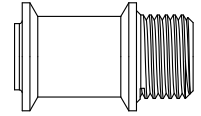

SEAT INCLUDED: LF646950

FOR ARTISTIC BRASS  
LENGTH: 1.40"

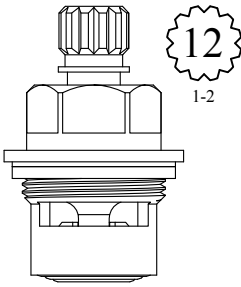

SEAL: 898500  
DISC SET: 112530-PKG

LF450941  
LF450942

FOR BRIGGS  
LENGTH: 1.40"

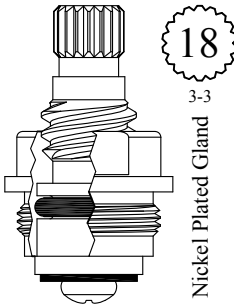

GASKET: 895100

LF452031  
LF452032



SEAT USED: LF648120

FOR PRICE PFISTER  
LENGTH: 1.41"

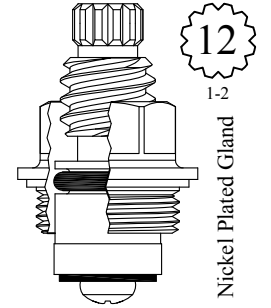

GASKET: 895100

LF451031  
LF451032

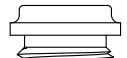

SEAT USED: LF648270

FOR INDIANA  
LENGTH: 1.41"

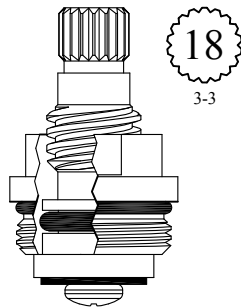

GASKET: 890170 O-RING INCLUDED

LF451121  
LF451122

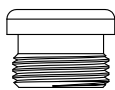

SEAT USED: LF648560

FOR PRICE PFISTER  
LENGTH: 1.42"

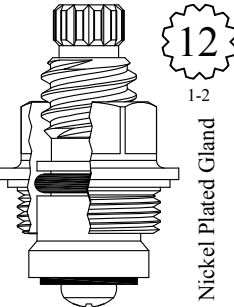

GASKET: 895100

LF451041  
LF451042

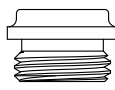

SEAT USED: LF648270

FOR ARROWHEAD  
LENGTH: 1.43"

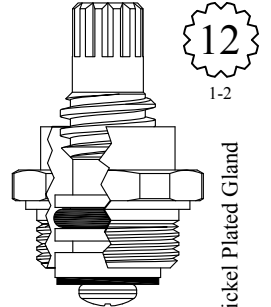

GASKET: 895100

LF452021  
LF452022



SEAT USED: LF648230

FOR MILWAUKEE  
LENGTH: 1.43"

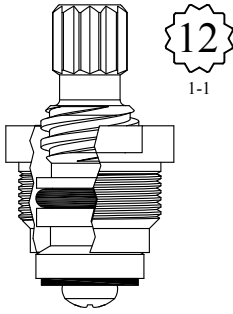

GASKET: 895100

LF451301  
LF451302

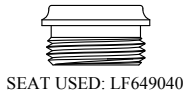

SEAT USED: LF649040

FOR CRANE  
LENGTH: 1.43"

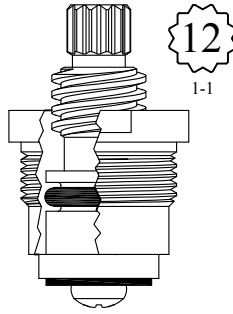

GASKET: 895180

LF451021  
LF451022

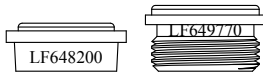

SEAT USED: LF648200 or LF649770

FOR ELJER  
LENGTH: 1.44"

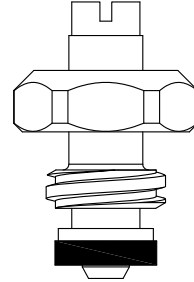

400251

FOR CRANE  
LENGTH: 1.44"

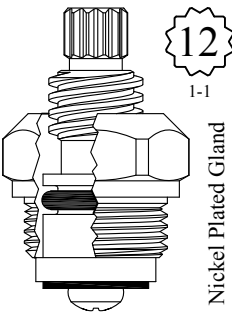

GASKET: 895100

LF451061  
LF451062

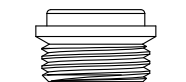

SEAT USED: LF649430

FOR CENTRAL  
LENGTH: 1.44"

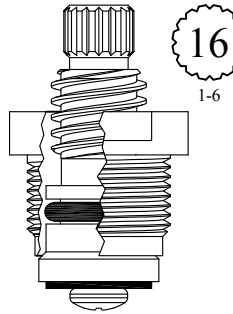

GASKET: 895100

LF451071  
LF451072



SEAT USED: LF648550

FOR ROYAL BRASS  
LENGTH: 1.44"

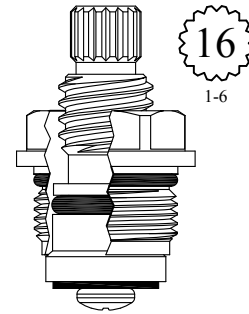

GASKET: 890160 O-RING INCLUDED

LF451131  
LF451132

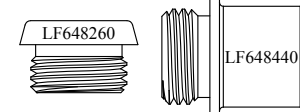

SEAT USED: LF648260 or LF648440

FOR DICK BROS.  
LENGTH: 1.45"

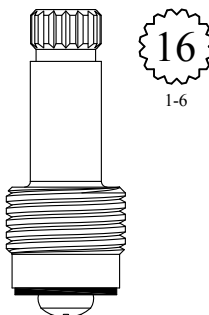

LF253011  
LF253012

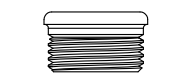

SEAT USED: LF649760

FOR GERBER  
LENGTH: 1.45"

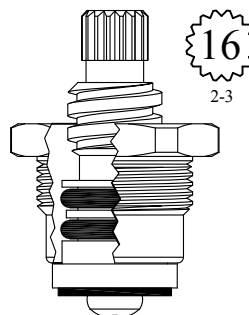

GASKET: 895150

LF451051  
LF451052

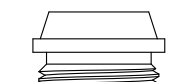

SEAT USED: LF649150

FOR HARCRAFT  
LENGTH: 1.45"

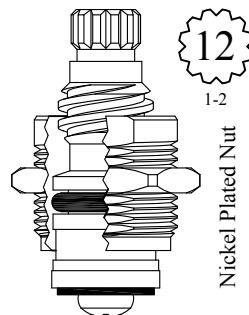

GASKET: 895040

LF451101

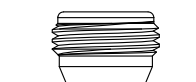

SEAT USED: LF648670

FOR HARCRAFT  
LENGTH: 1.45"

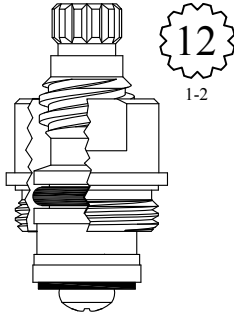

GASKET: 895100

LF451241  
LF451242

FOR GERBER  
LENGTH: 1.45"

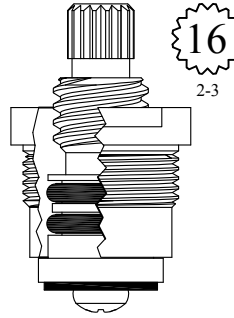

GASKET: 895150

LF451251  
LF451252

FOR UNION BRASS  
LENGTH: 1.45"

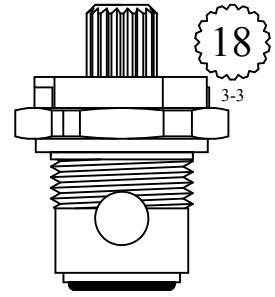

GASKET: 895100

LF452121  
LF452122



SEAT USED: LF649150

FOR STERLING FAUCET  
LENGTH: 1.46"

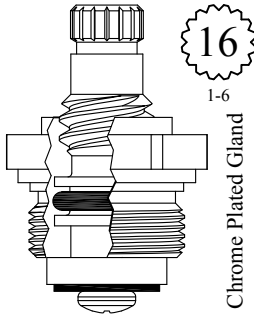

400511  
400512



SEAT USED: LF648170

FOR ARROWHEAD  
LENGTH: 1.46"

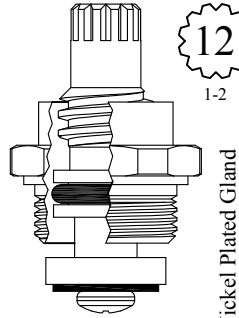

GASKET: 895100

LF450101  
LF450102

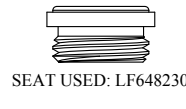

SEAT USED: LF648230

FOR INDIANA  
LENGTH: 1.46"

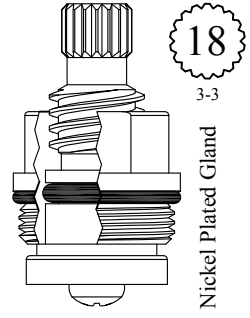

GASKET: 890180 O-RING INCLUDED

LF451141  
LF451142

FOR BARNES  
LENGTH: 1.47"

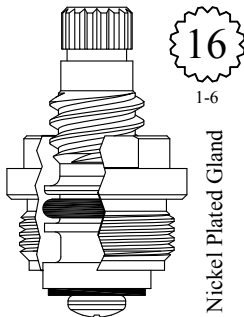

GASKET: 895100

LF452051  
LF452052



SEAT USED: LF648350

FOR MANSFIELD  
LENGTH: 1.48"

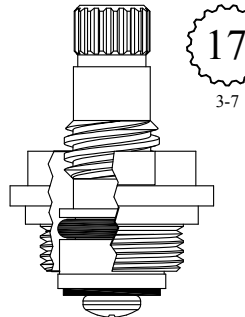

GASKET: 895100

LF450981  
LF450982

FOR SPEAKMAN  
LENGTH: 1.48"

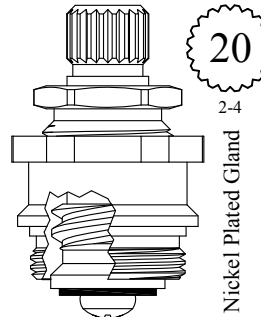

GASKET: 895150

LF451081  
LF451082



SEAT USED: LF648760

FOR PHOENIX  
LENGTH: 1.49"

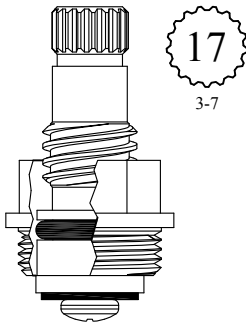

GASKET: 895100

400431

FOR SAYCO  
LENGTH: 1.49"

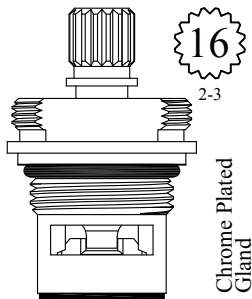

Chrome Plated  
Gland

GASKET: 890170 O-RING INCLUDED  
SEAL: 898540  
DISC SET: 112530-PKG

LF451231  
LF451232

FOR WATER SAVER  
LENGTH: 1.50"

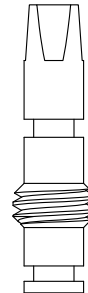

LF251341

FOR SEARS  
LENGTH: 1.50"

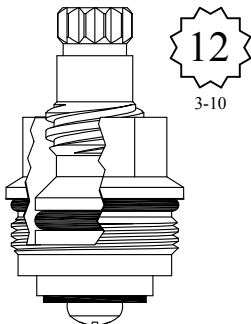

GASKET: 890180 O-RING INCLUDED

LF451091  
LF451092

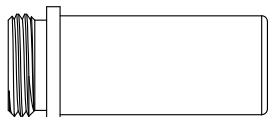

SEAT USED: LF648900

FOR CENTRAL  
LENGTH: 1.50"

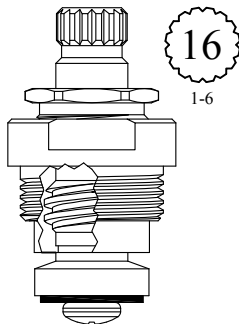

GASKET: 895100

LF452041  
LF452042



SEAT USED: LF648550

UNKNOWN  
LENGTH: 1.52"

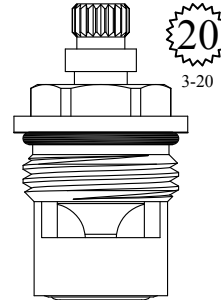

GASKET: 890170 O-RING INCLUDED  
SEAL: 898500  
DISC SET: 112530-PKG

LF450991  
LF450992

FOR PRICE PFISTER  
LENGTH: 1.53"

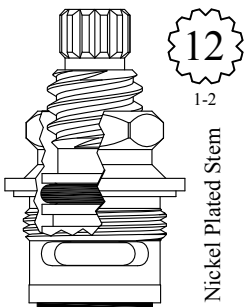

Nickel Plated  
Stem

GASKET: 895100

LF450951  
LF450952

FOR ARTISTIC BRASS  
LENGTH: 1.53"

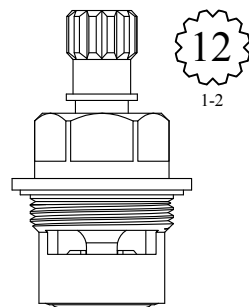

SEAL: 898500  
DISC SET: 112530-PKG

LF451191  
LF451192

FOR STERLING FAUCET  
LENGTH: 1.54"

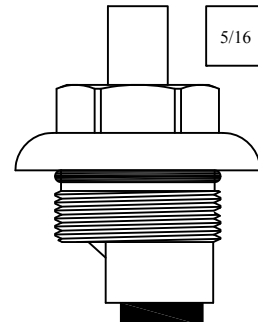

All Plastic  
Unit

GASKET: 890180 O-RING INCLUDED

452290

FOR T & S  
LENGTH: 1.55"

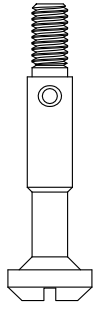

LF107910

UNKNOWN  
LENGTH: 1.54"

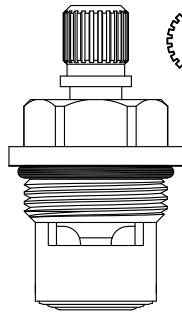

24  
3-18

Chrome Plated Unit

GASKET: 890170 O-RING INCLUDED  
SEAL: 898500  
DISC SET: 112530-PKG

LF451201  
LF451202

Single Lead  
FOR PHOENIX  
LENGTH: 1.55"

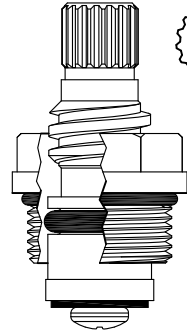

17  
3-7

GASKET: 890170 O-RING INCLUDED

LF451211  
LF451212

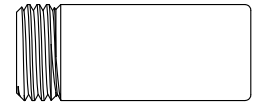

SEAT USED: LF648040

FOR PHOENIX  
LENGTH: 1.55"

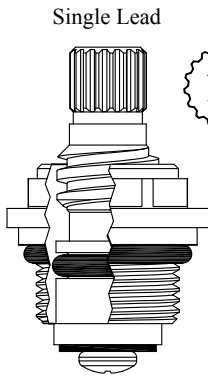

Single Lead

17  
3-7

GASKET: 891150 O-RING INCLUDED

LF451221  
LF451222



SEAT USED: LF649190

FOR AM BRASS  
LENGTH: 1.55"

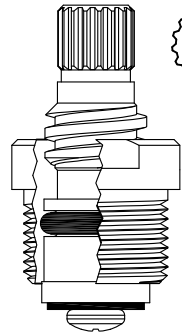

17  
3-7

18 TPI Gland

GASKET: 895100

LF451111  
LF451112

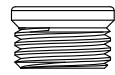

SEAT USED: LF648410

FOR STREAMWAY  
LENGTH: 1.55"

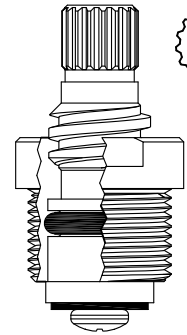

17  
3-7

20 TPI Gland

GASKET: 895100

LF451161  
LF451162

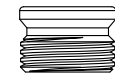

SEAT USED: LF649190

FOR AM BRASS  
LENGTH: 1.55"

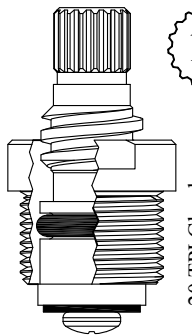

17  
3-7

20 TPI Gland

GASKET: 895100

LF451161  
LF451162



SEAT USED: LF648410

FOR PHOENIX  
FOR STREAMWAY  
LENGTH: 1.55"



17  
3-7

Double Lead

GASKET: 890170 O-RING INCLUDED

LF451171  
LF251111 Stem Only



SEAT USED: LF649190

FOR PHOENIX  
LENGTH: 1.55"



17  
3-7

Single Lead

GASKET: 890170 O-RING INCLUDED

LF451181



SEAT USED: LF649190

FOR STERLING FAUCET  
LENGTH: 1.55"

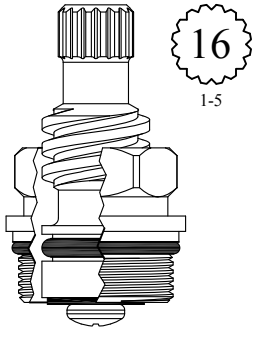

GASKET: 890180 O-RING INCLUDED

LF451401  
LF451402

FOR AM BRASS  
LENGTH: 1.55"

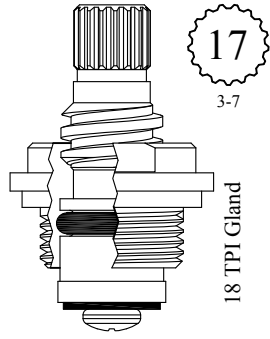

GASKET: 895100

LF452071  
LF452072



SEAT USED: LF648410

FOR STREAMWAY  
LENGTH: 1.55"

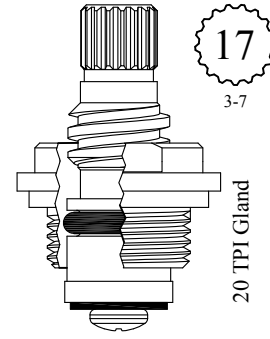

GASKET: 895100

LF452171  
LF452172



SEAT USED: LF649190

FOR YUGO  
LENGTH: 1.56"

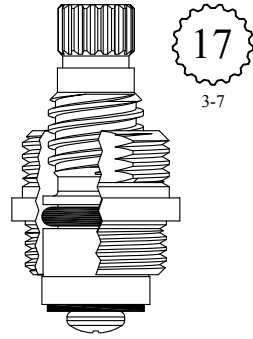

GASKET: 895100

LF452191  
LF452192

FOR STERLING FAUCET  
LENGTH: 1.56"

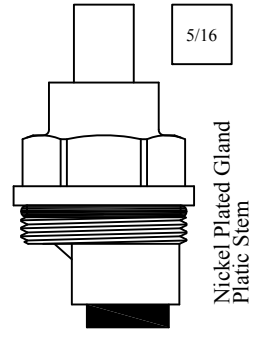

GASKET: 890180 O-RING INCLUDED

LF452300  
252300 Stem Only

FOR BORG-WARNER  
FOR GRAND HAVEN  
LENGTH: 1.56"

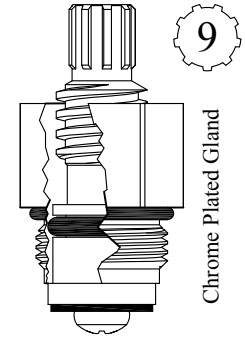

GASKET: 890160 O-RING INCLUDED

LF452861



SEAT USED: LF649050

FOR CRANE  
LENGTH: 1.57"

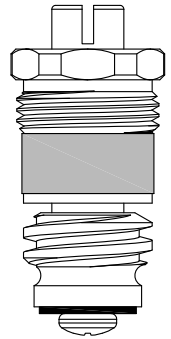

452821  
252821 Stem Only

FOR AUBURN BRASS  
LENGTH: 1.57"

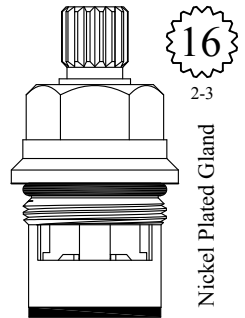

GASKET: 890160 O-RING INCLUDED  
SEAL: 893030  
DISC SET: 151380-PKG

LF450901  
LF450902

FOR GLACIER BAY  
LENGTH: 1.58"

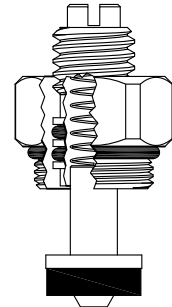

GASKET: 890150 O-RING INCLUDED

400231

FOR BURLINGTON  
LENGTH: 1.58"

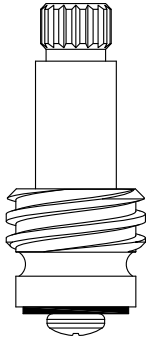

16  
1-6

LF253061  
LF253062



SEAT USED: LF648700

FOR DICK BROS.  
LENGTH: 1.59"

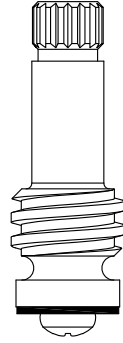

16  
1-6

LF253161  
LF253162

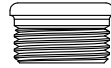

SEAT USED: LF649760

UNKNOWN  
LENGTH: 1.59"

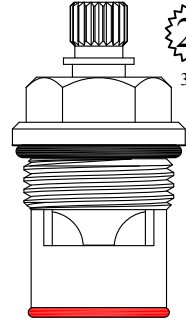

20  
3-20

GASKET: 890170 O-RING INCLUDED  
SEAL: 898580-R/B  
DISC SET: 151380-PKG

LF451261  
LF451262

FOR AM STD  
LENGTH: 1.59"

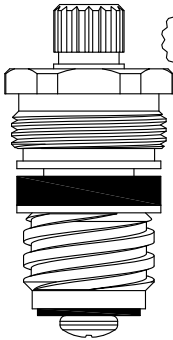

16

LF452011  
LF452012  
LF252081 Stem Only  
LF252082 Stem Only



SEAT USED: LF648350

FOR AM STD  
LENGTH: 1.59"

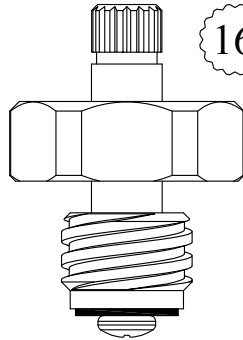

16

LF452081  
LF452082  
LF252081 Stem Only  
LF252082 Stem Only



SEAT USED: LF648350

FOR ADVANCED TABCO  
LENGTH: 1.60"

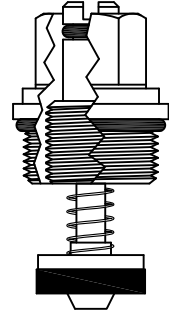

GASKET: 890170 O-RING INCLUDED

400241

FOR MIXET  
LENGTH: 1.60"

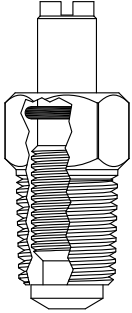

400721

Single Lead

FOR DICK BROS.  
LENGTH: 1.60"

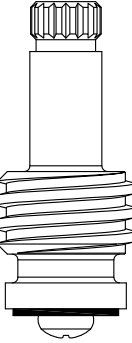

LF252251

Double Lead

FOR DICK BROS.  
LENGTH: 1.60"

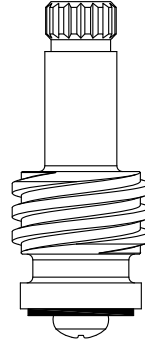

LF253151  
LF253152

Gland turns  
clockwise  
into valve body

FOR CHG  
FOR ADVANCED TABCO  
LENGTH: 1.61"

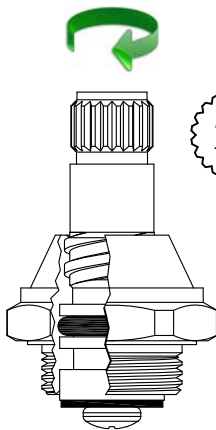

Chrome Plated Unit

GASKET: 895100

LF455411  
LF455412



SEAT USED: LF648270

Gland turns  
counter-clockwise  
into valve body

FOR CHG  
FOR ADVANCED TABCO  
LENGTH: 1.61"

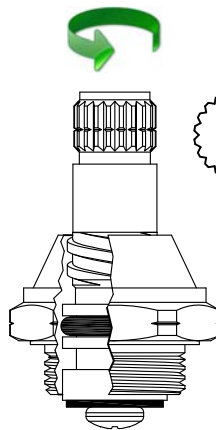

Chrome Plated Unit

GASKET: 895100

LF455462



SEAT USED: LF648270

FOR ELJER  
LENGTH: 1.62"

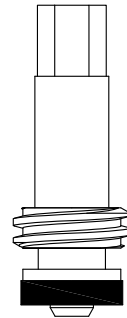

200351



FOR DICK BROS.  
LENGTH: 1.62"

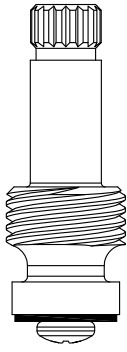

16  
1-6

LF252151  
LF252152

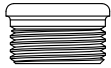

SEAT USED: LF649760

FOR AM STD  
LENGTH: 1.62"

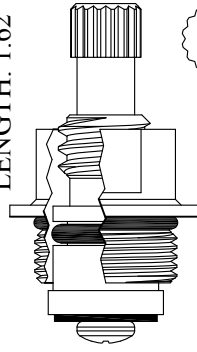

16

Nickel Plated Gland

GASKET: 890160 O-RING INCLUDED

LF453041  
LF453042

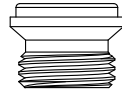

SEAT USED: LF648350

FOR SEARS  
LENGTH: 1.63"

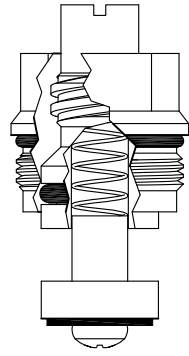

GASKET: 890180 O-RING INCLUDED

400261

FOR PRICE PFISTER  
LENGTH: 1.63"

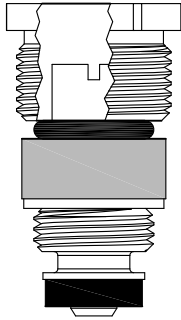

400301  
200301 Stem Only

FOR PRICE PFISTER  
LENGTH: 1.63"

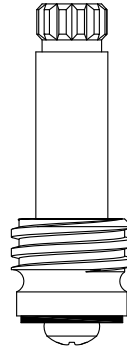

12  
1-2

LF252401

FOR SPEAKMAN  
LENGTH: 1.63"

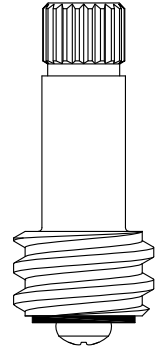

20  
2-4

LF253071  
LF253072

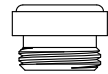

SEAT USED: LF648760

FOR PRICE PFISTER  
LENGTH: 1.63"

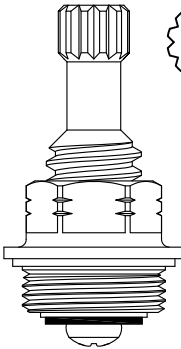

12  
1-2

GASKET: 895100  
SEAT INCLUDED: LF648310

LF451001

UNKNOWN  
LENGTH: 1.63"

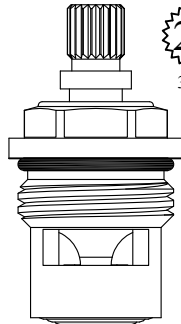

20  
3-20

GASKET: 890170 O-RING INCLUDED  
SEAL: 898500  
DISC SET: 112530-PKG

LF451281  
LF451282

FOR SAVOY  
LENGTH: 1.63"

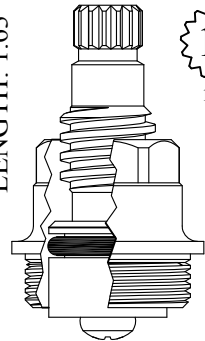

15  
1-13

Chrome Plated Gland

GASKET: 895150

LF452201  
LF452202

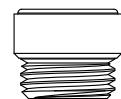

SEAT USED: LF649740

FOR SAVOY  
LENGTH: 1.63"

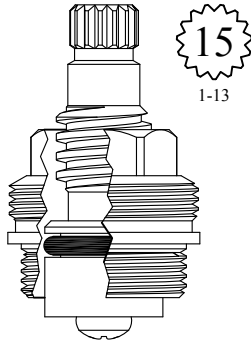

GASKET: 895150

LF452211  
LF452212

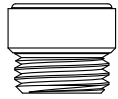

SEAT USED: LF649740

FOR BRIGGS  
LENGTH: 1.63"

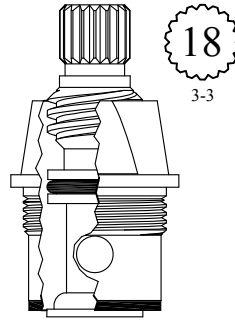

GASKET: 895100

LF453031  
LF453032

FOR PRICE PFISTER  
LENGTH: 1.63"

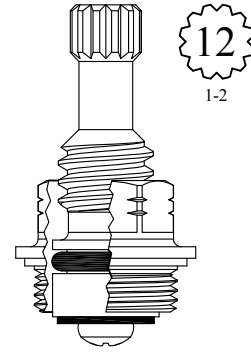

GASKET: 895100

LF453051  
LF453052

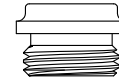

SEAT USED: LF648270

FOR SPEAKMAN  
LENGTH: 1.64"

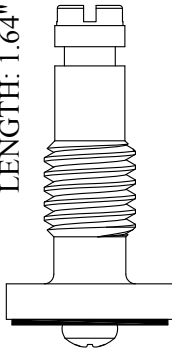

Chrome Plated Stem

252911

FOR MOEN  
STEM LENGTH: 1.48"

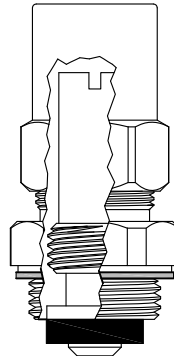

11/16-20 TPI Gland

GASKET: 895110 INCLUDED

400311

FOR MOEN  
STEM LENGTH: 1.48"

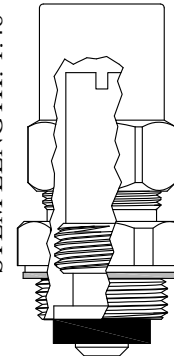

11/16-27 TPI Gland

GASKET: 895110 INCLUDED

400321

FOR MOEN  
STEM LENGTH: 1.48"

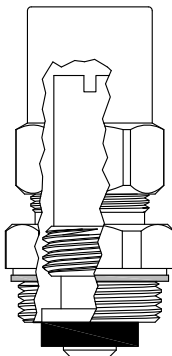

3/4-20 TPI Gland

GASKET: 895110 INCLUDED

400341

FOR WEST BRASS  
LENGTH: 1.64"

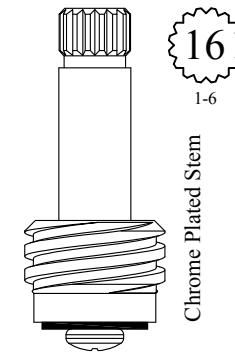

16  
1-6

Chrome Plated Stem

LF252111  
LF252112



SEAT USED: LF649600

FOR INDIANA  
LENGTH: 1.64"

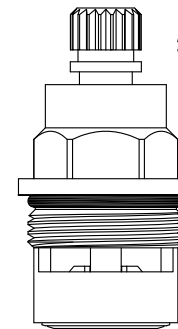

18  
3-3

Chrome Plated Gland

GASKET: 890170 O-RING INCLUDED  
SEAL: 898510-W  
DISC SET: 151380-PKG

LF451901  
LF451902

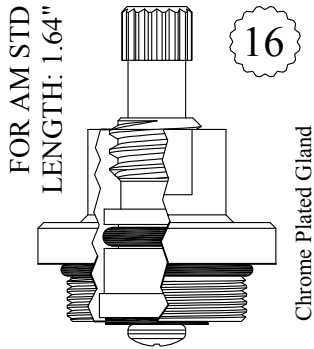

GASKET: 890200 O-RING INCLUDED

LF453141

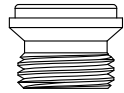

SEAT USED: LF648350

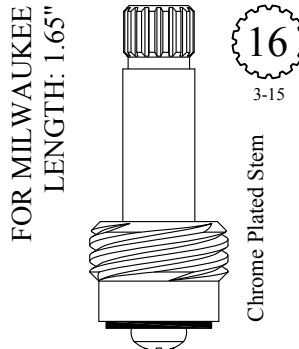

201211  
201212



SEAT USED: 648370

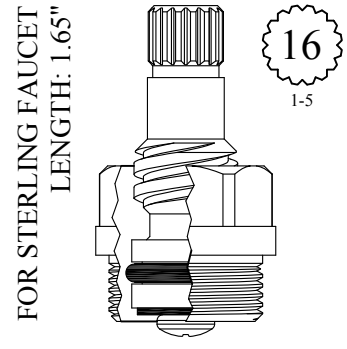

GASKET: 895160

LF452091  
LF452092



SEAT USED: LF648170

Gland turns  
clockwise  
into valve body



Knurled lock ring also available

952900

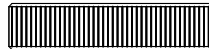

GASKET: 890170 O-RING INCLUDED

SEAL: 898570-R/B  
DISC SET: 151380-PKG

LF452601  
LF452602

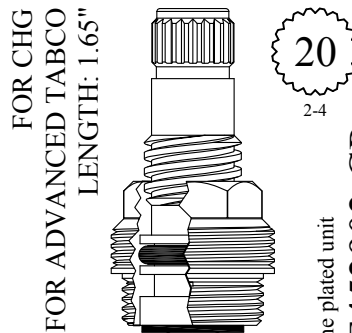

GASKET: 895100

LF452901  
LF452902

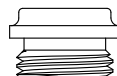

SEAT USED: LF648270

Also available as chrome plated unit  
**LF452901-CP/ LF452902-CP**

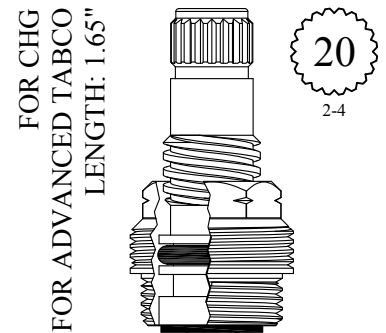

GASKET: 895100

LF452922



SEAT USED: LF648270

Gland turns  
counter-clockwise  
into valve body



FOR GERBER  
LENGTH: 1.65"

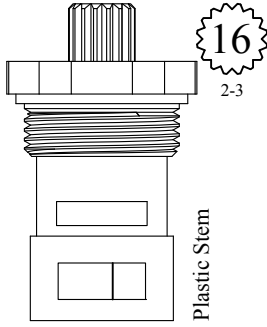

GASKET: 895150

LF453171  
LF453172



SEAT USED: LF649150

UNKNOWN  
LENGTH: 1.66"

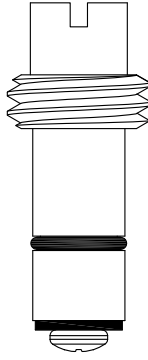

200611

FOR WILLOUGHBY  
LENGTH: 1.66"

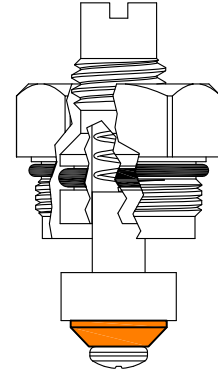

GASKET: 890190 O-RING INCLUDED

LF400451

FOR HARCRAFT  
LENGTH: 1.67"

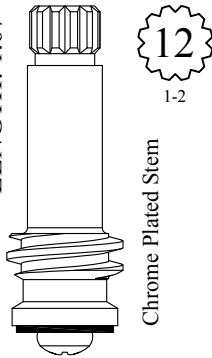

Chrome Plated Stem

LF254021  
LF254022

FOR SUNRISE / PRO PLUS  
LENGTH: 1.67"

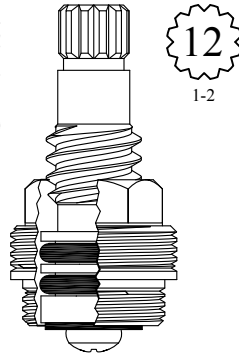

GASKET: 895100

LF453251  
LF453252

UNKNOWN  
LENGTH: 1.68"

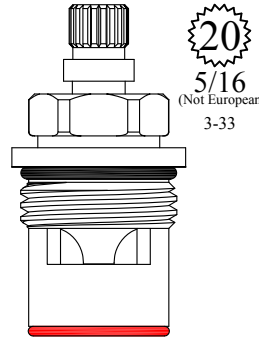

GASKET: 890170 O-RING INCLUDED  
SEAL: 898580-R/B  
DISC SET: 151380-PKG

LF452611  
LF452612

FOR ADVANCED TABCO  
LENGTH: 1.68"

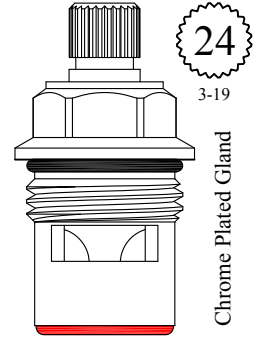

Chrome Plated Gland

GASKET: 890170 O-RING INCLUDED  
SEAL: 898570-R/B  
DISC SET: 151380-PKG

LF452621  
LF452622

FOR CAMBRIDGE  
LENGTH: 1.68"

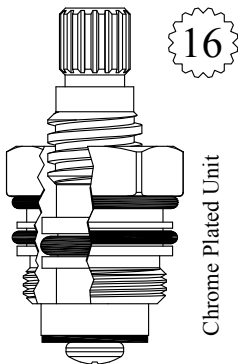

Chrome Plated Unit

GASKET: 890170 O-RING INCLUDED

LF452961  
LF452962

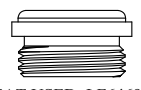

SEAT USED: LF646940

FOR AM STD  
LENGTH: 1.69"

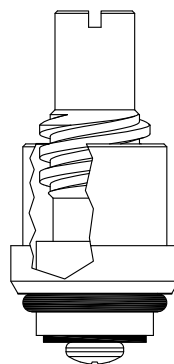

GASKET: 891130

453181  
253181 Stem Only

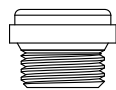

SEAT USED: LF648990

FOR MICHIGAN BRASS  
LENGTH: 1.69"

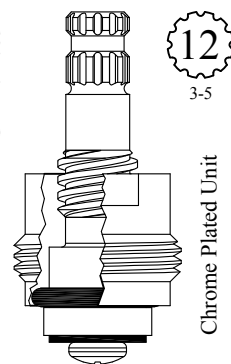

Chrome Plated Unit

GASKET: 891120 O-RING INCLUDED

400621  
400622

FOR STERLING FAUCET  
LENGTH: 1.69"

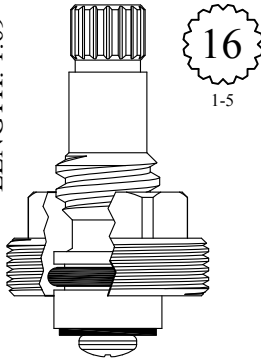

16  
1-5

400711  
400712

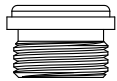

SEAT USED: LF648170

UNKNOWN  
LENGTH: 1.69"

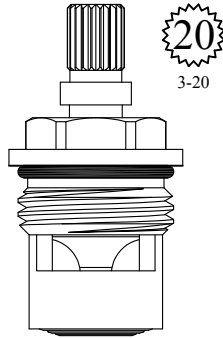

20  
3-20

GASKET: 890170 O-RING INCLUDED  
SEAL: 898500  
DISC SET: 112530-PKG

LF452381  
LF452382

Also available with locknut:  
LF453091-N / LF453092-N

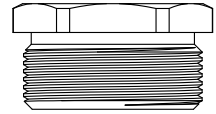

FOR AM STD  
LENGTH: 1.69"

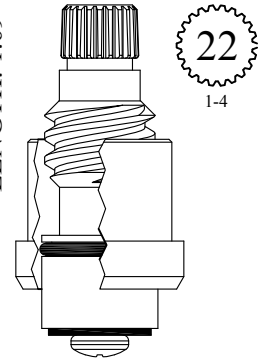

22  
1-4

GASKET: 891130

LF453091  
LF453092



SEAT USED: LF648990

FOR AM STD  
LENGTH: 1.69"

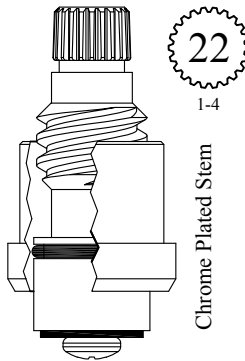

22  
1-4

Chrome Plated Stem

GASKET: 891130

LF453101  
LF453102

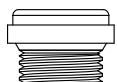

SEAT USED: LF648990

FOR AM STD  
LENGTH: 1.69"

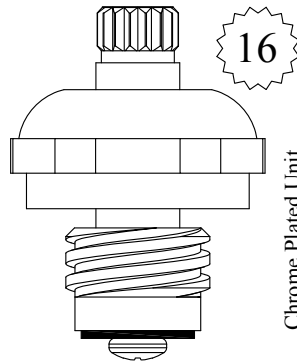

16

Chrome Plated Unit

LF454011  
LF454012

LF254011 Stem Only

LF254012 Stem Only



SEAT USED: LF648100

FOR ACORN  
LENGTH: 1.70"

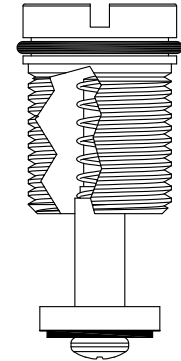

LF400190

FOR MIXET  
LENGTH: 1.70"

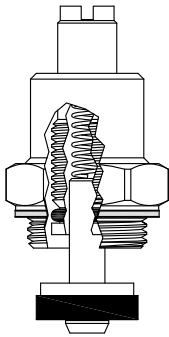

GASKET: 895060 INCLUDED

400371

FOR ROYAL BRASS  
LENGTH: 1.70"

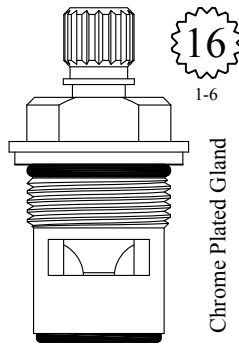

GASKET: 890160 O-RING INCLUDED  
SEAL: 898540  
DISC SET: 112530-PKG

LF451501  
LF451502

Chrome Plated Gland

FOR EMCO  
LENGTH: 1.70"

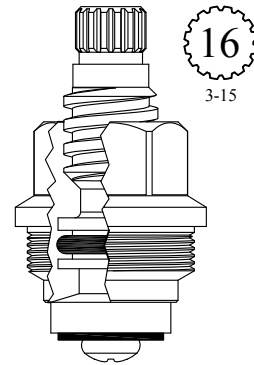

GASKET: 895180

LF452701  
LF452702

Also available with  
stainless steel knurled ring:  
LF453021-SS / LF453022-SS  
Also available with locknut:  
LF453021-N / LF453022-N

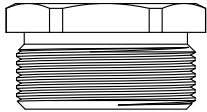

FOR AM STD  
LENGTH: 1.70"

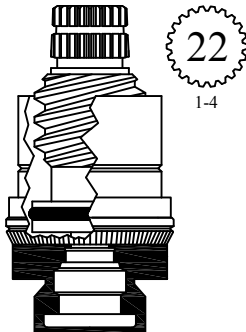

LF453021  
LF453022



SEAT USED: LF648990

FOR URREA  
LENGTH: 1.70"

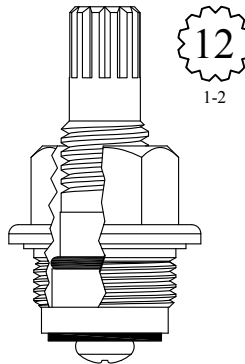

LF453401

FOR AM STD  
LENGTH: 1.71"

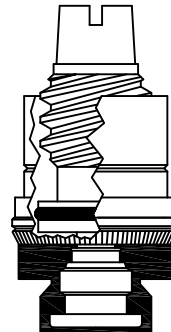

453191

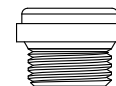

SEAT USED: LF648990

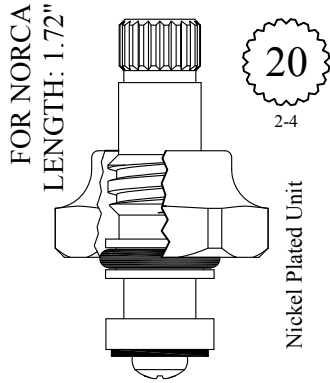

LF454181  
LF454182

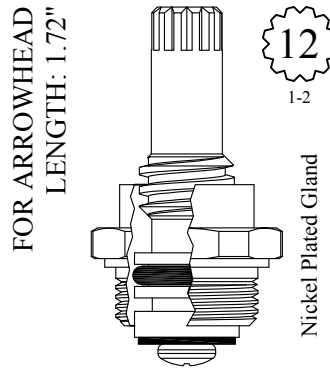

GASKET: 895100  
LF454191  
LF454192

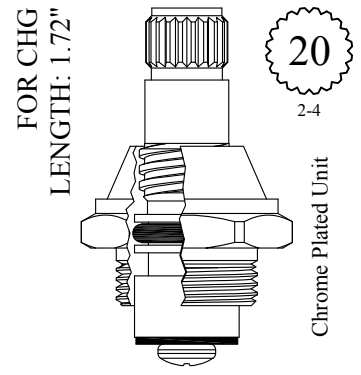

GASKET: 895100  
LF455401  
LF455402



Also available as chrome plated unit

400471-CP  
200471-CP Stem Only

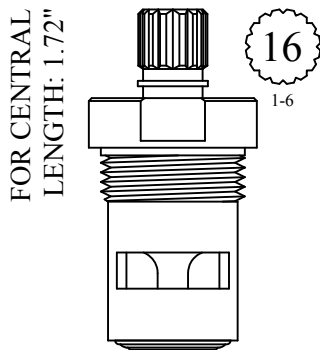

GASKET INCLUDED: 895270  
SEAL: 898500  
DISC SET: 112530-PKG  
LF455901  
LF455902

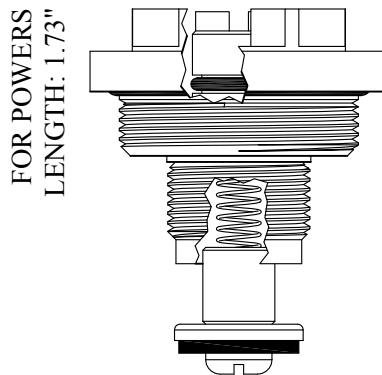

GASKET: 891230 O-RING INCLUDED

400471  
200471 Stem Only  
500470-KIT Retainer & Spring Only

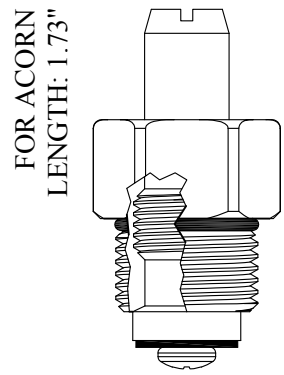

GASKET: 890160 O-RING INCLUDED

LF454071  
LF254071 Stem Only

FOR PRICE PFISTER  
LENGTH: 1.73"

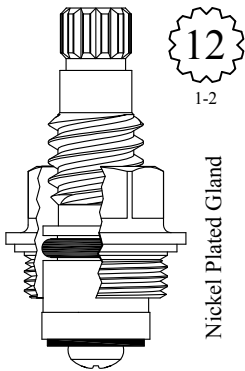

12  
1/2

Nickel Plated Gland

GASKET: 895100

LF454121  
LF454122



SEAT USED: LF648270

FOR SAYCO  
LENGTH: 1.74"

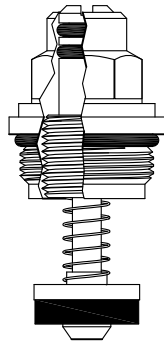

Nickel Plated Stem

GASKET: 890160 O-RING INCLUDED

400121

FOR AM STD  
LENGTH: 1.74"

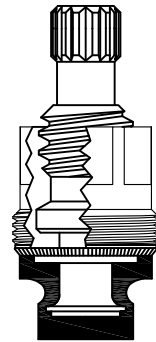

16

Special w/ Hex Gland

SEAT: LF647910  
OR LF649650

452991

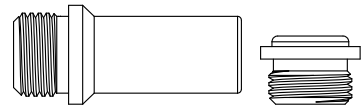

SEAT USED: LF647910 or LF649650

FOR SEARS  
LENGTH: 1.74"

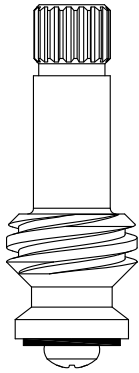

17  
3-7

LF254141  
LF254142



SEAT USED: LF648700

FOR AM STD  
LENGTH: 1.74"

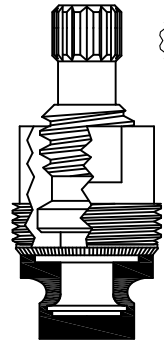

16

LF453001  
LF453002



SEAT USED: LF647910 or LF649650

FOR MILWAUKEE  
LENGTH: 1.74"

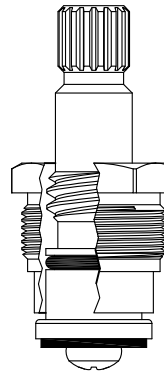

16  
3-15

LF453121  
LF453122



SEAT USED: LF649040

GASKET: 199930



FOR MILWAUKEE  
LENGTH: 1.74"

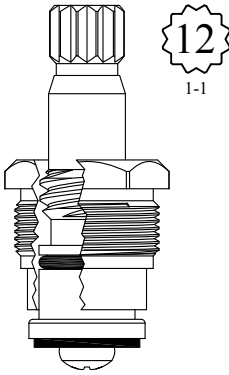

GASKET: 199930

LF453241  
LF453242

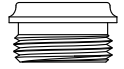

SEAT USED: LF649040

FOR CRANE  
LENGTH: 1.74"

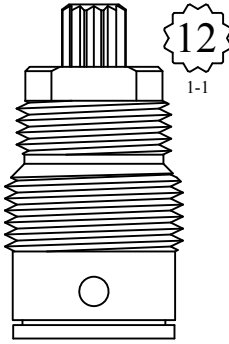

GASKET: 895250

LF453300

FOR INDIANA  
LENGTH: 1.74"

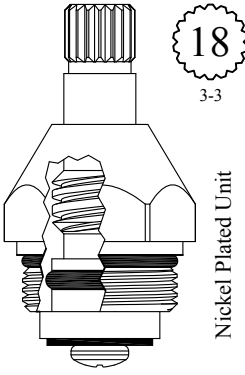

GASKET: 890170 O-RING INCLUDED

LF454031  
LF454032

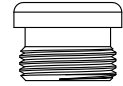

SEAT USED: LF648560

FOR STERLING FAUCET  
LENGTH: 1.74"

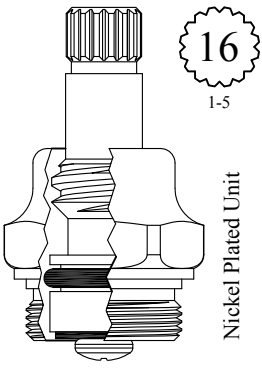

GASKET: 895160

LF455131  
LF455132

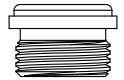

SEAT USED: LF648170

FOR SYMMONS  
LENGTH: 1.75"



400661  
200661 Stem Only

FOR STERLING FAUCET  
LENGTH: 1.75"

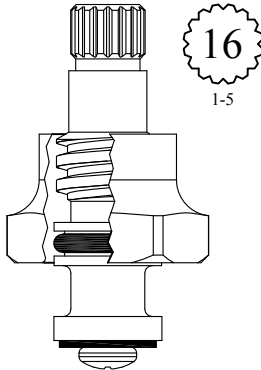

454241  
454242

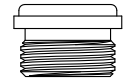

SEAT USED: LF648170

Also available as nickel plated unit  
LF454111/ LF454112

FOR PRICE PFISTER  
LENGTH: 1.75"

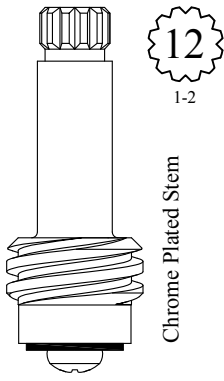

Chrome Plated Stem

LF255161  
LF255162



SEAT USED: LF648270

FOR SPEAKMAN  
LENGTH: 1.75"

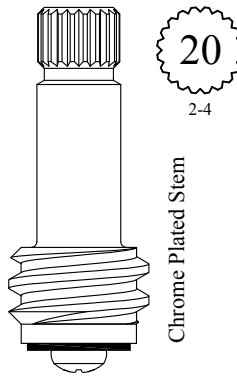

Chrome Plated Stem

LF256011  
LF256012

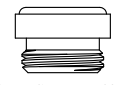

SEAT USED: LF648760

FOR GERBER  
LENGTH: 1.75"

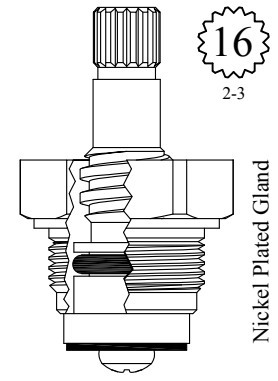

Nickel Plated Gland

GASKET: 895150

LF453111  
LF453112

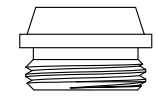

SEAT USED: LF649150

FOR ARROWHEAD  
LENGTH: 1.75"

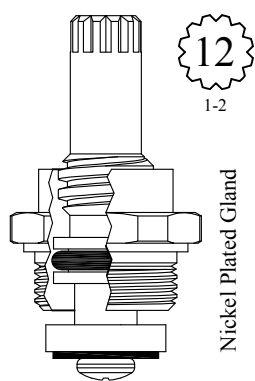

Nickel Plated Gland

GASKET: 895100

LF454091  
LF454092



SEAT USED: LF648230

FOR BRIGGS  
LENGTH: 1.75"

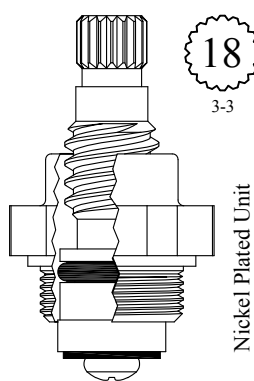

Nickel Plated Unit

GASKET: 895100

LF454101  
LF454102

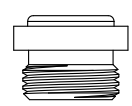

SEAT USED: LF648120

LENGTH: 1.75"

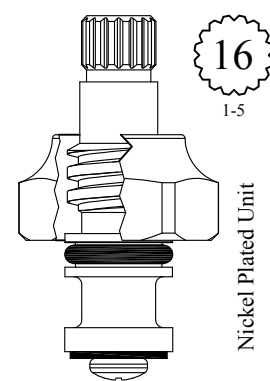

Nickel Plated Unit

LF454161  
LF454162



SEAT USED: LF648170

FOR SEARS  
LENGTH: 1.75"

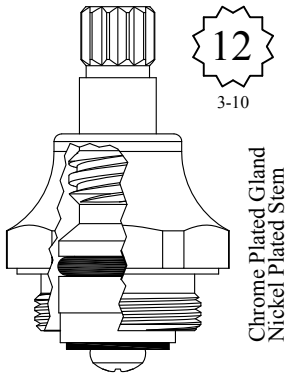

GASKET: 895150

LF454171  
LF454172



SEAT USED: LF648700

FOR SEARS  
LENGTH: 1.75"

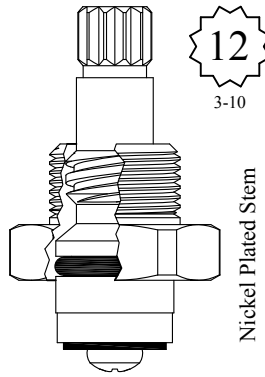

LF454221  
LF454222

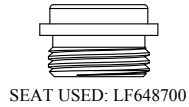

SEAT USED: LF648700

FOR SEARS  
LENGTH: 1.75"

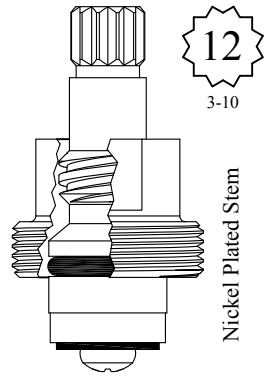

LF454231  
LF454232



SEAT USED: LF648700

FOR STREAMWAY  
LENGTH: 1.75"

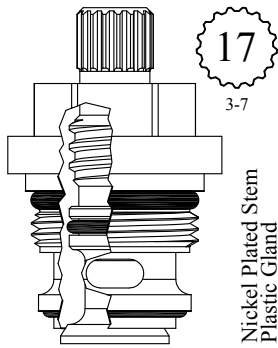

GASKET: 891150 O-RING INCLUDED

LF454302

FOR UNION BRASS  
LENGTH: 1.75"

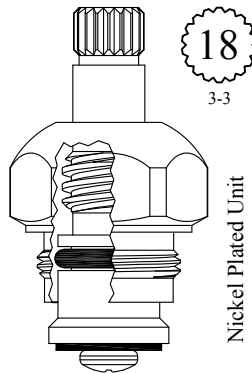

GASKET: 895100

LF455011  
LF455012

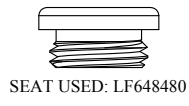

SEAT USED: LF648480

FOR SEARS  
FOR MILWAUKEE  
LENGTH: 1.75"

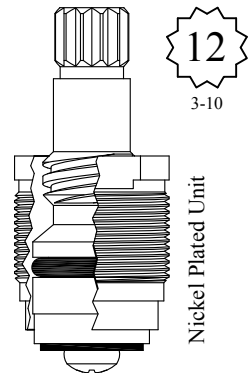

GASKET: 894670

LF455021  
LF455022



SEAT USED: LF648700

FOR STERLING FAUCET  
LENGTH: 1.75"

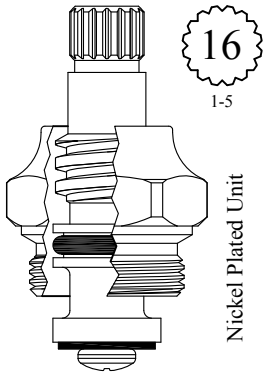

GASKET: 895160

LF455031  
LF455032

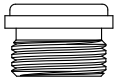

SEAT USED: LF648170

FOR SEARS  
LENGTH: 1.75"

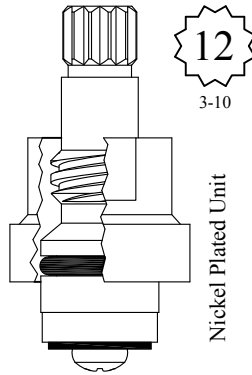

3-10

Nickel Plated Unit

LF455041  
LF455042



SEAT USED: LF648700

FOR STERLING FAUCET  
LENGTH: 1.75"

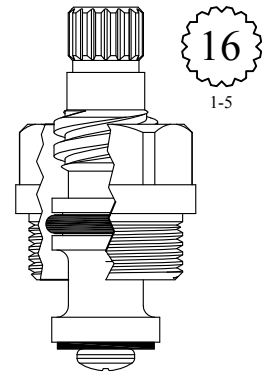

1-5

GASKET: 895160

LF455051  
LF455052

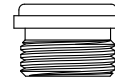

SEAT USED: LF648170

FOR STERLING FAUCET  
LENGTH: 1.75"

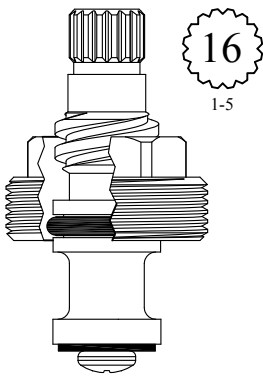

1-5

Chrome Plated Unit

LF455071  
LF455072

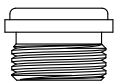

SEAT USED: LF648170

FOR AM STD  
LENGTH: 1.75"

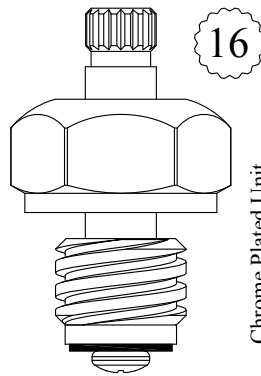

16

LF455081  
LF455082  
LF255081 Stem Only  
LF255082 Stem Only

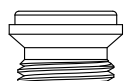

SEAT USED: LF648350

FOR MICHIGAN BRASS  
LENGTH: 1.75"

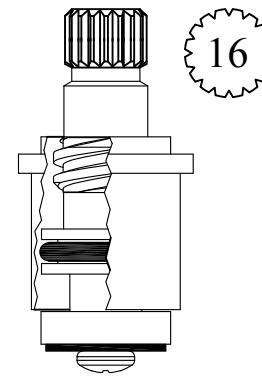

16

GASKET: 895140

LF455091  
LF455092

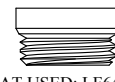

SEAT USED: LF648210

FOR DONNER  
LENGTH: 1.75"

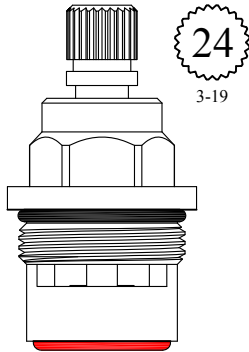

GASKET: 890180 O-RING INCLUDED  
SEAL: 898570-R/B  
DISC SET: 151380-PKG

LF455301  
LF455302

FOR DONNER  
LENGTH: 1.75"

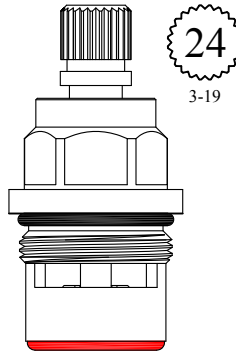

GASKET: 890170 O-RING INCLUDED  
SEAL: 898570-R/B  
DISC SET: 151380-PKG

LF455311  
LF455312

UNKNOWN  
LENGTH: 1.75"

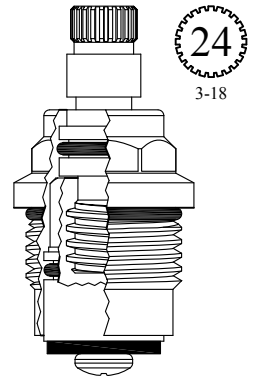

GASKET: 890170 O-RING INCLUDED

LF455422

FOR PRICE PFISTER  
LENGTH: 1.76"

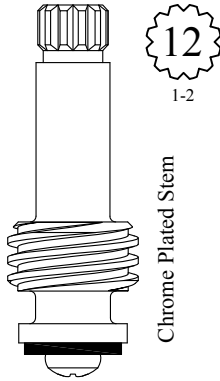

LF255061  
LF255062



SEAT USED: LF648270

FOR GERBER  
LENGTH: 1.76"

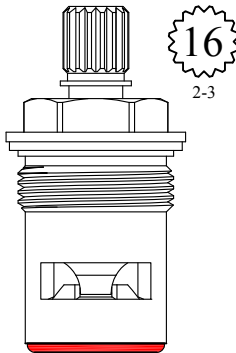

GASKET: 895140 INCLUDED  
SEAL: 898570-R/B  
DISC SET: 151380-PKG

LF455951  
LF455952

FOR AM STD  
LENGTH: 1.77"

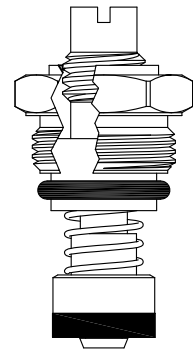

400171

FOR PRICE PFISTER  
LENGTH: 1.77"

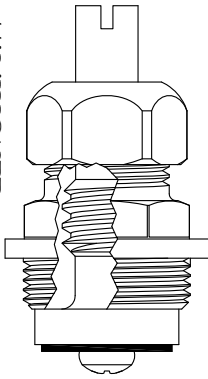

GASKET: 895400

400741  
200741 Stem Only

FOR BARDES  
LENGTH: 1.77"

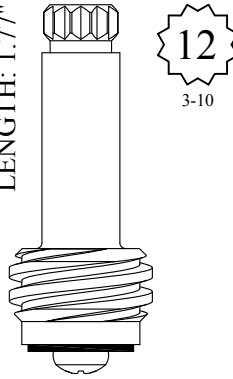

3-10

LF254001  
LF254002

FOR STERLING FAUCET  
LENGTH: 1.77"

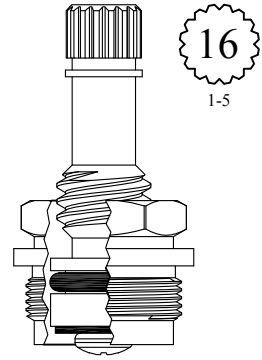

1-5

GASKET: 895160

LF452951  
LF452952

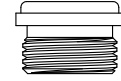

SEAT USED: LF648170

FOR BRADLEY  
LENGTH: 1.78"

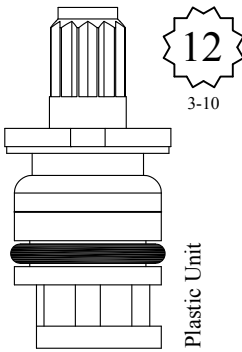

3-10

Plastic Unit

453201

FOR PRICE PFISTER  
LENGTH: 1.78"

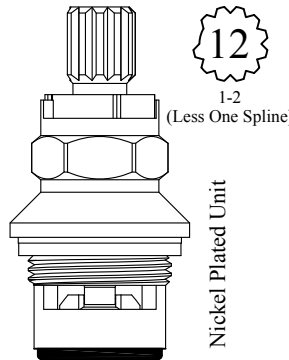

1-2  
(Less One Spline)

Nickel Plated Unit

GASKET: 895190 INCLUDED  
SEAL: 898540  
DISC SET: 112530-PKG

LF452801  
LF452802

FOR STERLING FAUCET  
LENGTH: 1.78"

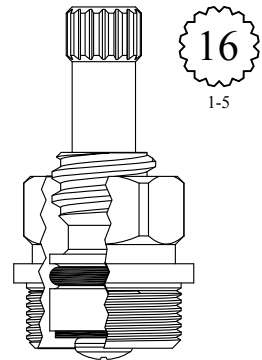

1-5

GASKET: 895160

LF453081  
LF453082

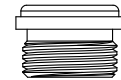

SEAT USED: LF648170

UNKNOWN  
LENGTH: 1.78"

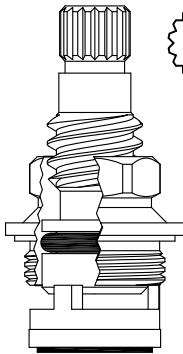

Nickel Plated Stem  
Chrome Plated Gland

GASKET: 895100

LF455141  
LF455142

UNKNOWN  
LENGTH 1.78"

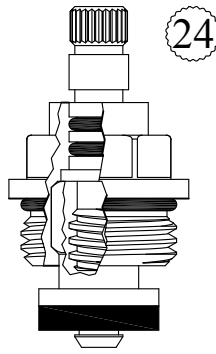

GASKET: 890170 O-RING INCLUDED

LF455942

FOR DELTA  
LENGTH: 1.79"

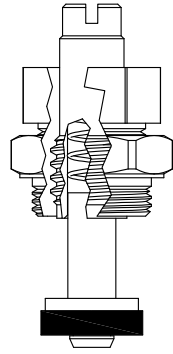

GASKET: 895060 INCLUDED

400151

FOR SEARS  
LENGTH: 1.79"

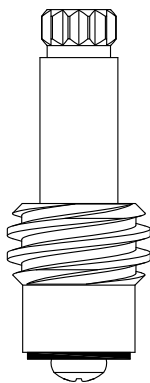

LF255101  
LF255102



SEAT USED: LF648700

FOR MICHIGAN BRASS  
LENGTH: 1.79"

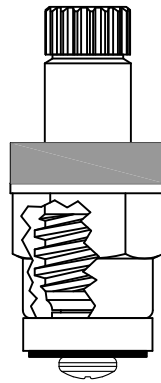

LF454151  
LF454152

FOR MOEN  
LENGTH: 1.79"

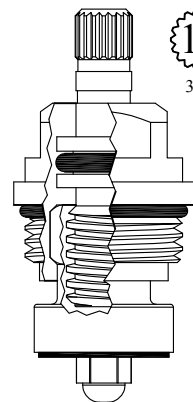

GASKET: 890180 O-RING INCLUDED

LF455362

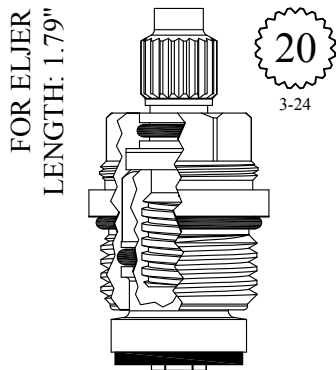

GASKET: 890170 O-RING INCLUDED

**LF455962**

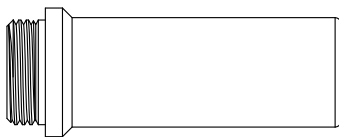

SEAT USED: LF647430

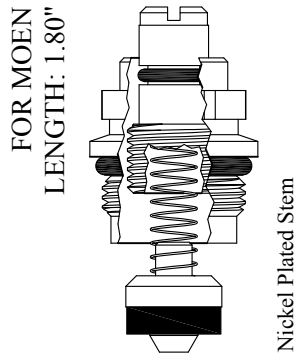

GASKET: 891140 O-RING INCLUDED

**400421**

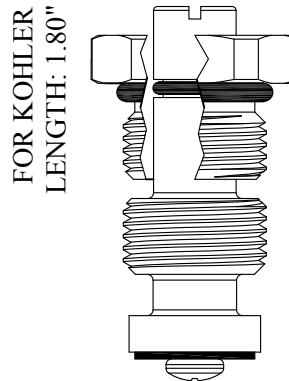

GASKET: 891140 O-RING INCLUDED

**400921**

**200921** Stem Only

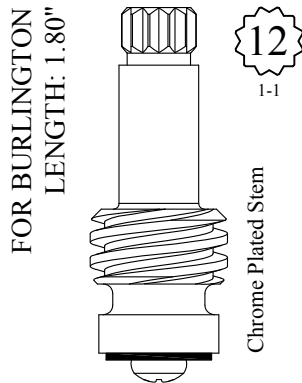

**LF255111**  
**LF255112**

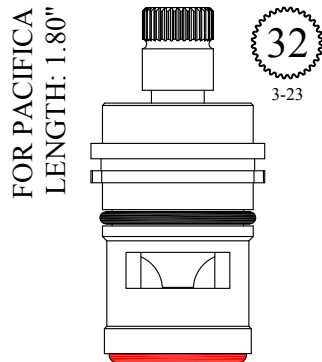

GASKET: 890170 O-RING INCLUDED  
SEAL: 898570-R/B  
DISC SET: 151380-PKG

**LF456221**  
**LF456222**

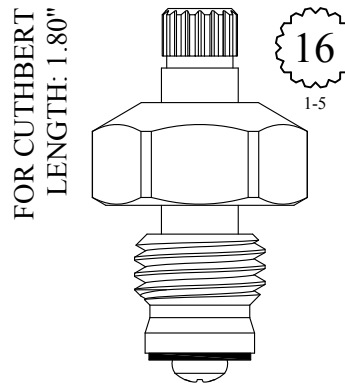

**LF456971**  
**LF256971** Stem Only



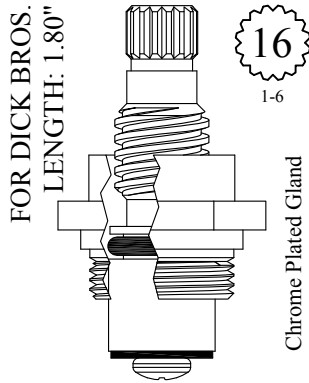

GASKET: 895100

LF457071  
LF457072

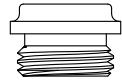

SEAT USED: LF648270

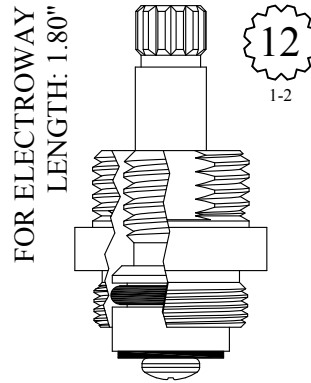

LF457141  
LF457142

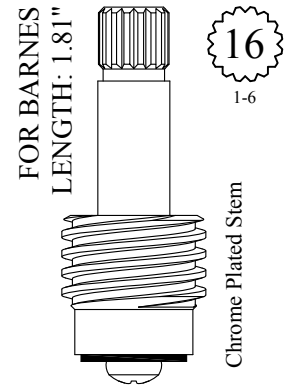

LF260131  
LF260132



SEAT USED: LF648350

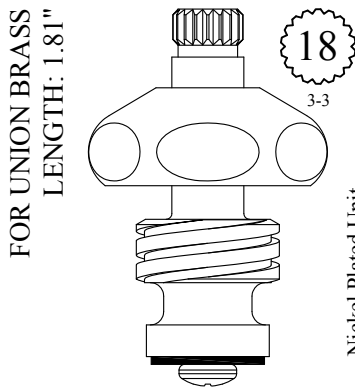

LF455121  
LF455122  
LF255121 Stem Only  
LF255122 Stem Only



SEAT USED: LF648480

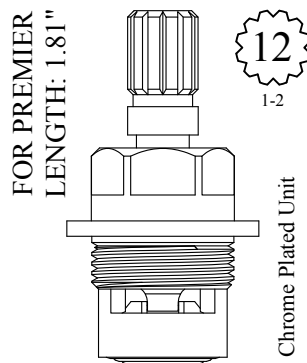

SEAL: 898500  
DISC SET: 112530-PKG

LF455981  
LF455982

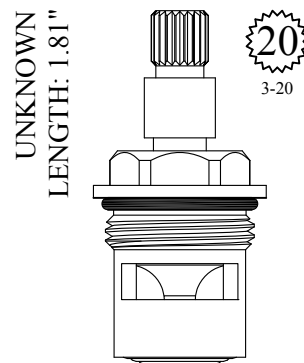

GASKET: 890170 O-RING INCLUDED

SEAL: 898500  
DISC SET: 112530-PKG

LF456031  
LF456032

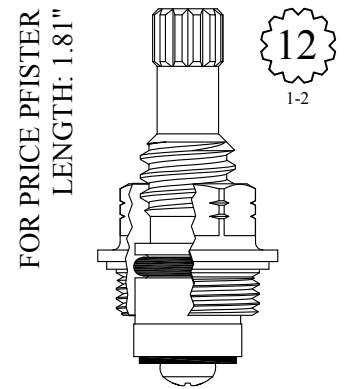

GASKET: 895100

LF456041

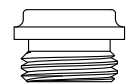

SEAT USED: LF648270

FOR GRAND HAVEN  
LENGTH: 1.81"

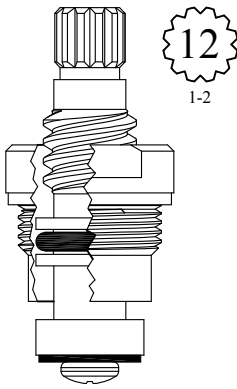

1-2

GASKET: 895100

LF456071  
LF456072



SEAT USED: LF649270

FOR CRANE  
LENGTH: 1.81"  
STEM LENGTH: 1.00"

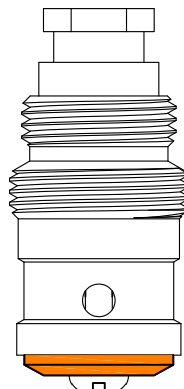

STEM LENGTH: 0.87"



Shorter version stem available

LF103990

GASKET: 895250

LF458700  
LF258700 Stem Only

FOR LARDEN  
LENGTH: 1.82"

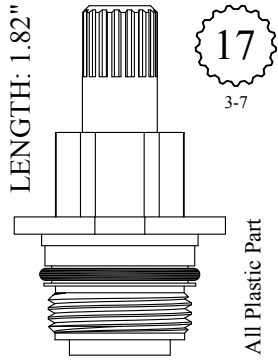

3-7

All Plastic Part

454351

FOR BARNES  
LENGTH: 1.82"

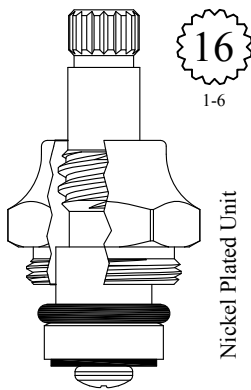

1-6

Nickel Plated Unit

LF456051  
LF456052



SEAT USED: LF648350

FOR SEARS  
LENGTH: 1.83"

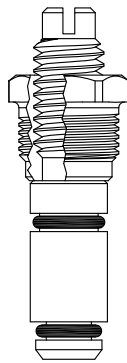

400361

IMPORT  
LENGTH: 1.83"

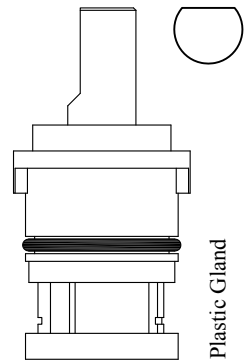

Plastic Gland

456211  
456212

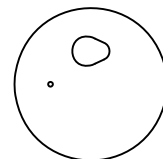

FOR GERBER  
LENGTH: 1.83"

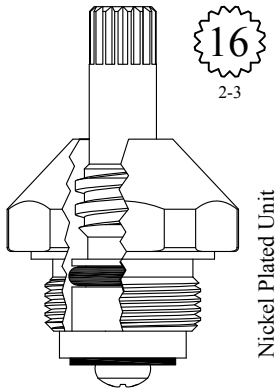

GASKET: 895150

LF454131  
LF454132

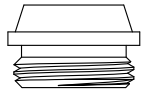

SEAT USED: LF649150

FOR KINGSBURY  
LENGTH: 1.83"

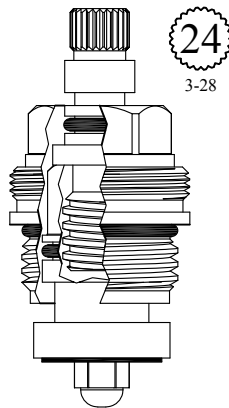

GASKET: 890170 O-RING INCLUDED

LF455972

FOR DICK BROS.  
LENGTH: 1.84"

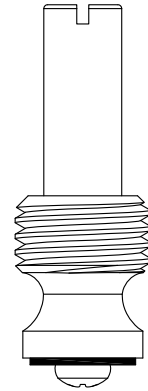

LF257001

FOR AM STD  
LENGTH: 1.84"

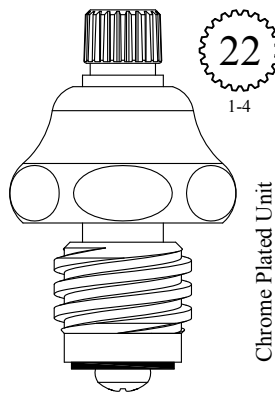

Chrome Plated Unit

LF456021  
LF456022

LF256021 Stem Only

LF256022 Stem Only

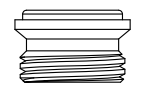

SEAT USED: LF648220

FOR ARROWHEAD  
LENGTH: 1.84"

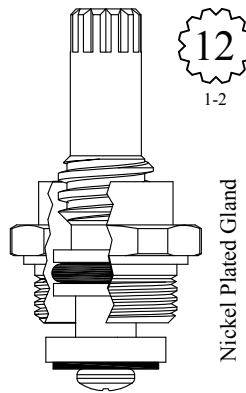

Nickel Plated Gland

GASKET: 895100

LF457031  
LF457032



SEAT USED: LF648230

FOR DICK BROS.  
LENGTH: 1.85"

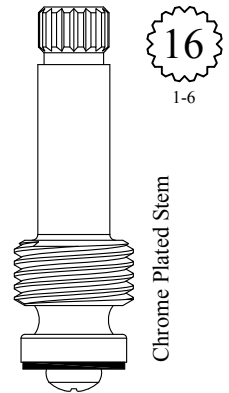

Chrome Plated Stem

LF257061  
LF257062



SEAT USED: LF649760

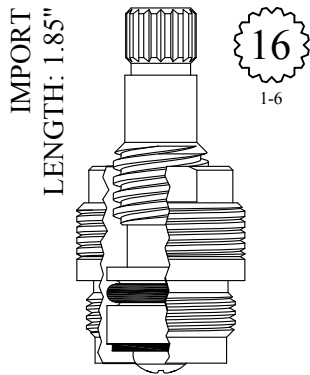

LF454051  
LF454052

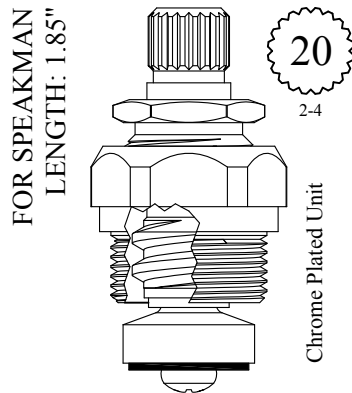

GASKET: 895150  
LF456061  
LF456062  
LF256061 Stem Only  
LF256062 Stem Only

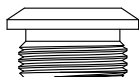

SEAT USED: LF648930

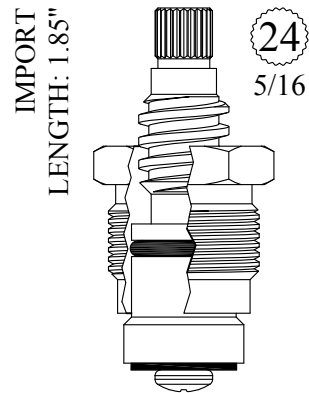

LF456141

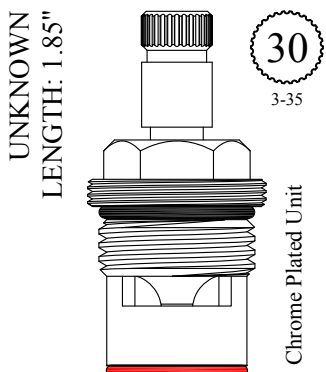

GASKET: 890170 O-RING INCLUDED  
SEAL: 898580-R/B  
DISC SET: 151380-PKG

LF456481  
LF456482

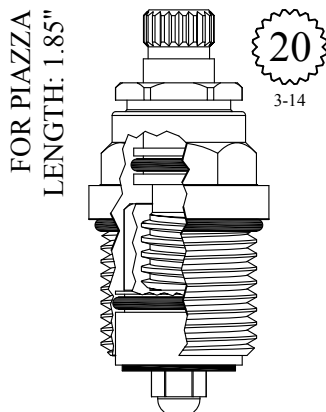

GASKET: 890180 O-RING INCLUDED

LF460802

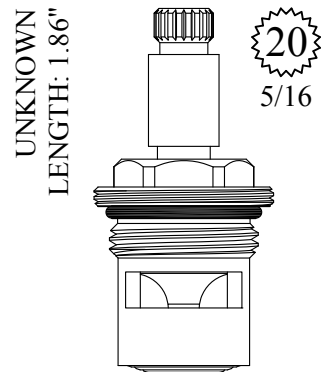

GASKET: 890170 O-RING INCLUDED  
SEAL: 898500  
DISC SET: 112530-PKG

LF456251  
LF456252

UNKNOWN  
LENGTH: 1.86"

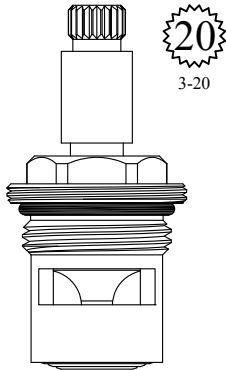

GASKET: 890170 O-RING INCLUDED  
SEAL: 898500  
DISC SET: 112530-PKG

LF456271  
LF456272

UNKNOWN  
LENGTH: 1.86"

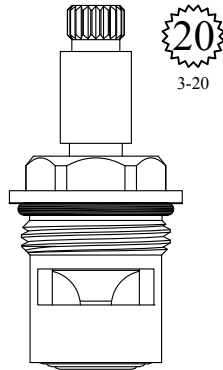

GASKET: 890170 O-RING INCLUDED  
SEAL: 898500  
DISC SET: 112530-PKG

LF456281  
LF456282

UNKNOWN  
LENGTH: 1.86"

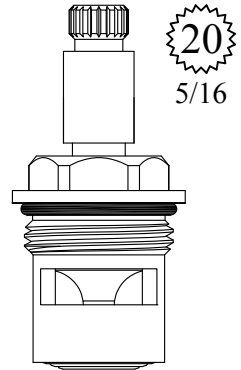

GASKET: 890170 O-RING INCLUDED  
SEAL: 898500  
DISC SET: 112530-PKG

LF456291  
LF456292

FOR SAYCO  
LENGTH: 1.87"

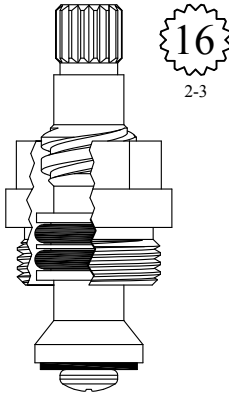

GASKET: 895100

LF456081  
LF456082



SEAT USED: LF647450

FOR T & S  
LENGTH: 1.87"

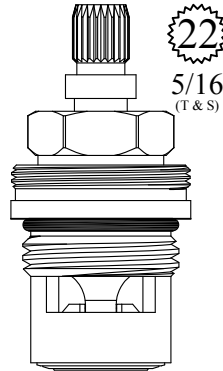

GASKET: 890170 O-RING INCLUDED  
SEAL: 898500  
DISC SET: 112530-PKG

LF456261  
LF456262

FOR AM STD  
LENGTH: 1.87"

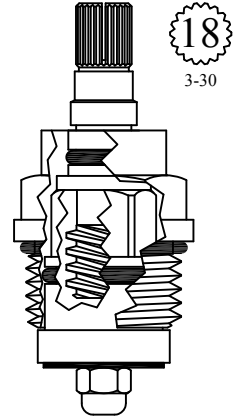

GASKET: 890180 O-RING INCLUDED

LF456302

FOR AM STD  
LENGTH: 1.87"

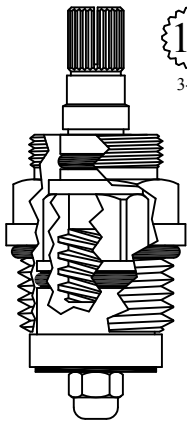

18  
3-30

GASKET: 890180 O-RING INCLUDED

LF456312

FOR GLACIER BAY  
LENGTH: 1.87"

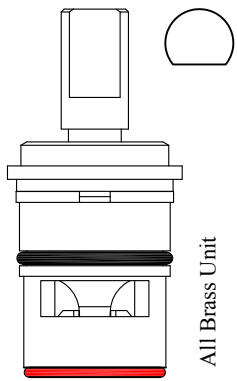

All Brass Unit

GASKET: 890170 O-RING INCLUDED  
SEAL: 898580-R/B  
DISC SET: 151380-PKG

LF456341  
LF456342

FOR MOUNTAIN  
LENGTH: 1.87"

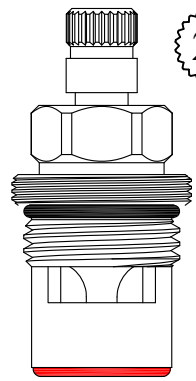

24  
3-19

GASKET: 890170 O-RING INCLUDED  
SEAL: 898570-R/B  
DISC SET: 151380-PKG

LF456371  
LF456372

UNKNOWN  
LENGTH: 1.87"

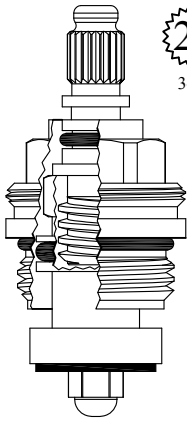

20  
3-20

GASKET: 890170 O-RING INCLUDED

LF456462

FOR AM KITCHEN  
LENGTH: 1.87"

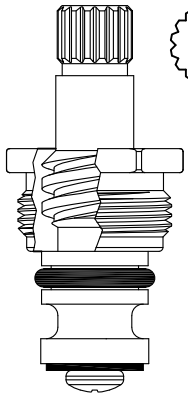

16  
1-5

LF457091  
LF457092

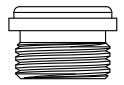

SEAT USED: LF648170

FOR MOUNTAIN  
LENGTH: 1.87"

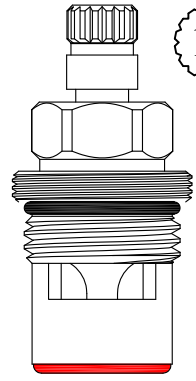

16  
1-6

GASKET: 890170 O-RING INCLUDED  
SEAL: 898570-R/B  
DISC SET: 151380-PKG

LF456381  
LF456382

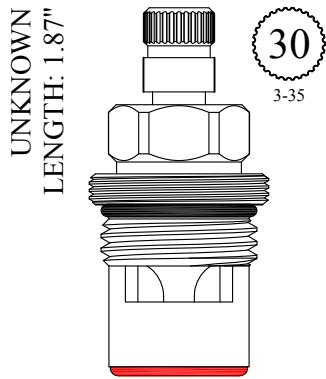

GASKET: 890170 O-RING INCLUDED  
SEAL: 898570-R/B  
DISC SET: 151380-PKG

LF456411  
LF456412

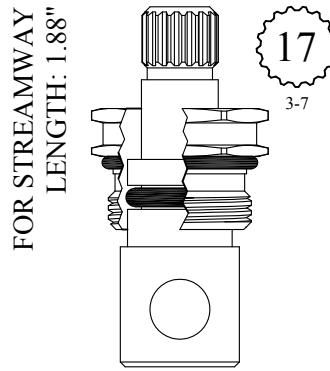

GASKET: 890170 O-RING INCLUDED

430010  
230010 Stem Only

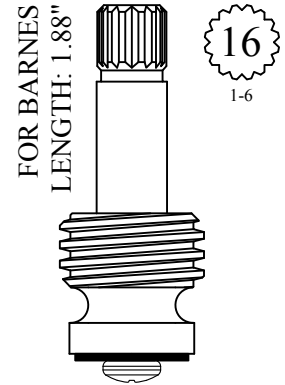

LF256101  
LF256102

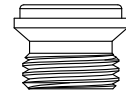

SEAT USED: LF648350

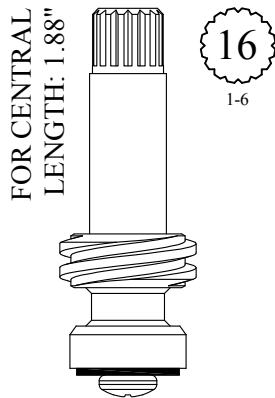

LF256111  
LF256112

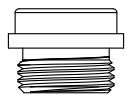

SEAT USED: LF648550

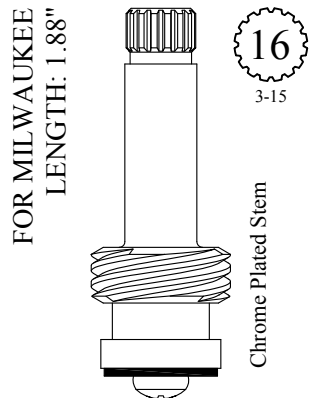

LF256121  
LF256122



SEAT USED: LF649040

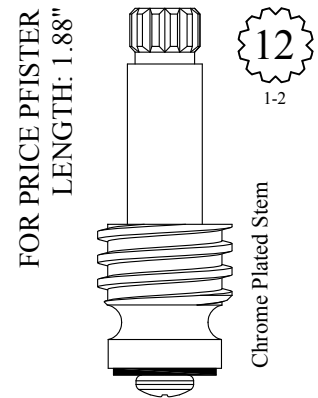

LF256251

UNKNOWN  
LENGTH: 1.88"

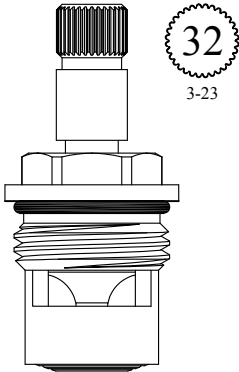

GASKET: 890170 O-RING INCLUDED  
SEAL: 898500  
DISC SET: 112530-PKG

LF455381  
LF455382

FOR BELVEDERE  
LENGTH: 1.88"

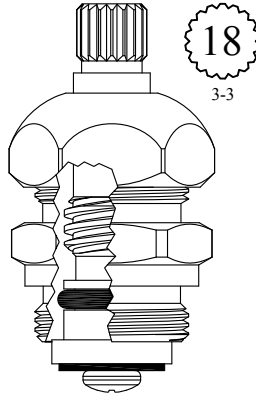

GASKET: 895150

LF456131  
LF456132



SEAT USED: LF648500

FOR GLACIER BAY  
LENGTH: 1.88"

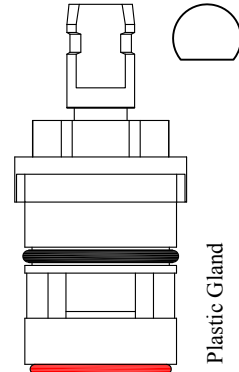

GASKET: 890170 O-RING INCLUDED  
SEAL: 898580-R  
DISC SET: 115520-PKG

LF456201  
LF456202

FOR GLACIER BAY  
LENGTH: 1.88"

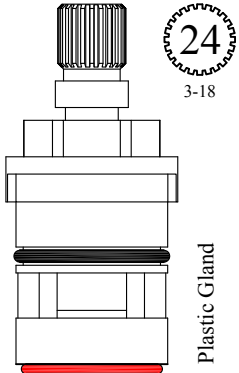

GASKET: 890170 O-RING INCLUDED  
SEAL: 898580-R  
DISC SET: 115520-PKG

LF456231  
LF456232

FOR P.E. GUERIN  
LENGTH: 1.88"

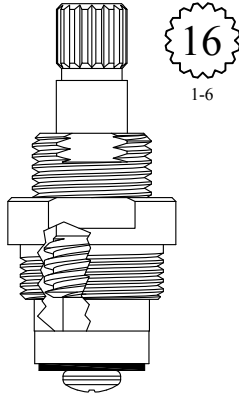

GASKET: 895100

LF456321  
LF456322

FOR BURLINGTON  
LENGTH: 1.88"

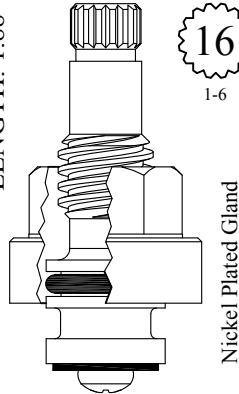

LF457011  
LF457012



SEAT USED: LF648700



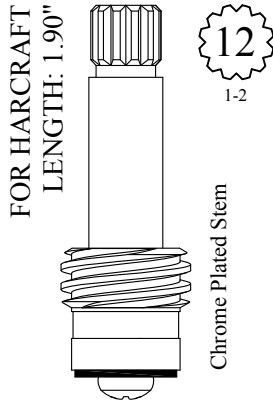

LF257111  
LF257112

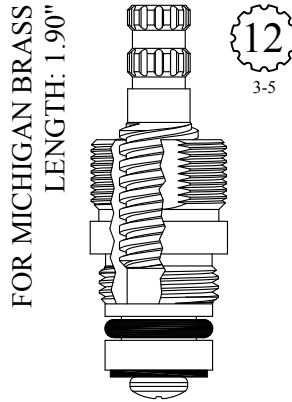

LF456821  
LF456822

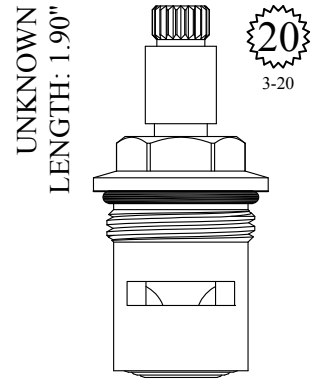
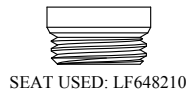

GASKET: 890170 O-RING INCLUDED  
SEAL: 898500  
DISC SET: 112530-PKG

LF456881  
LF456882

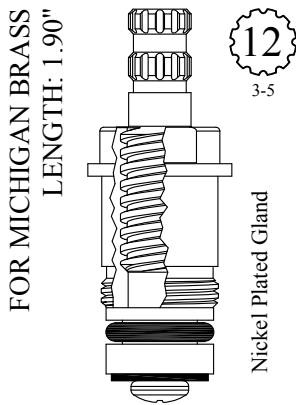

LF457021  
LF457022

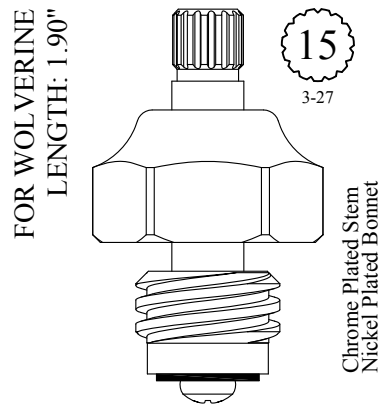
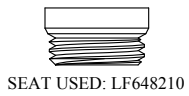

LF457161  
LF457162  
LF257161 Stem Only  
LF257162 Stem Only

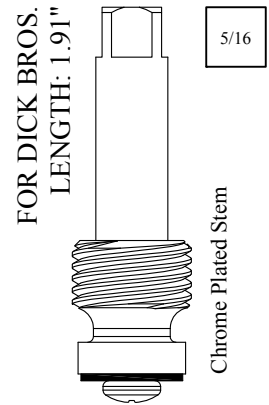

258211

FOR INDIANA  
LENGTH: 1.91"

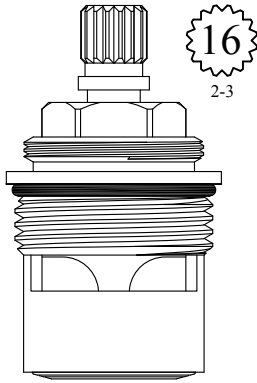

GASKET: 890210 O-RING INCLUDED  
SEAL: 898520  
DISC SET: 109850-PKG

400811  
400812

FOR PRICE PFISTER  
LENGTH: 1.91"

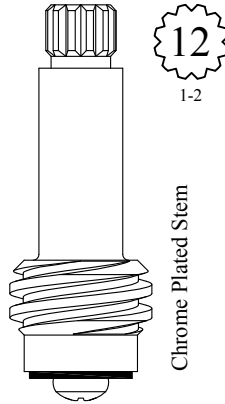

Chrome Plated Stem

LF257051  
LF257052

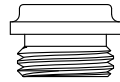

SEAT USED: LF648270

FOR GLACIER BAY  
LENGTH: 1.91"

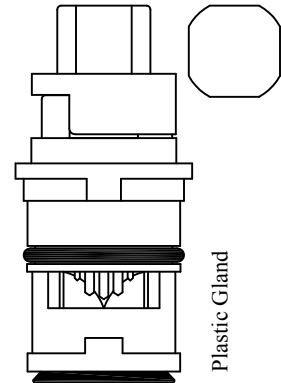

Plastic Gland

GASKET: 890170 O-RING INCLUDED  
SEAL: 898510  
DISC SET: 151380-PKG

LF456351  
LF456352

FOR DORNBRACHT  
LENGTH: 1.91"

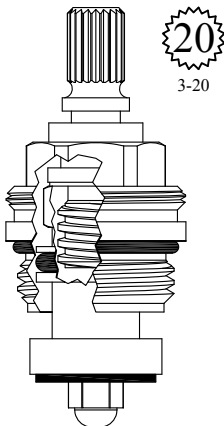

GASKET: 890170 O-RING INCLUDED

LF456362



SEAT USED: LF647110

FOR AM STD  
LENGTH: 1.91"

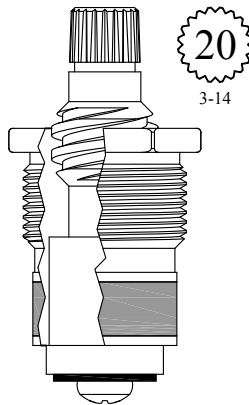

3-14

LF457101

LF457102

LF257101 Stem Only

LF257102 Stem Only



SEAT USED: LF648220

FOR PRICE PFISTER  
LENGTH: 1.91"

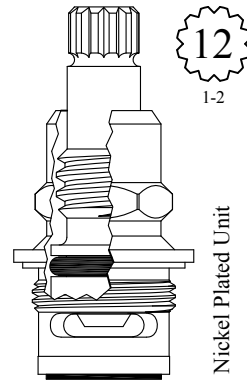

Nickel Plated Unit

GASKET: 895190

LF457201

LF457202

FOR PRICE PFISTER  
LENGTH: 1.91"

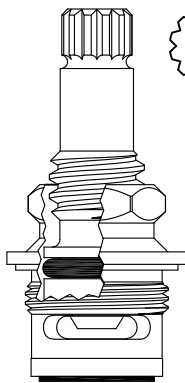

12  
1-2

Nickel Plated Stem

GASKET: 895190

LF457221  
LF457222

UNKNOWN  
LENGTH: 1.91"

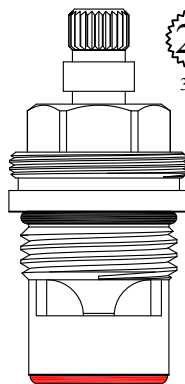

24  
3-28

GASKET: 890170 O-RING INCLUDED  
SEAL: 898570-R/B  
DISC SET: 151380-PKG

LF459131  
LF459132

FOR MILWAUKEE  
LENGTH: 1.92"

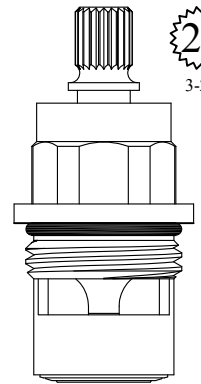

20  
3-20

GASKET: 890170 O-RING INCLUDED  
SEAL: 898510-W  
DISC SET: 151380-PKG

LF456401  
LF456402

UNKNOWN  
LENGTH: 1.92"

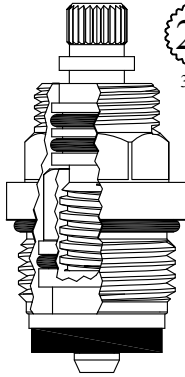

24  
3-28

GASKET: 890170 O-RING INCLUDED

LF456422

FOR WOLVERINE  
LENGTH: 1.92"

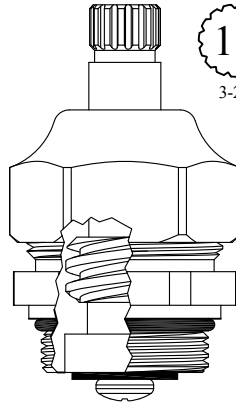

15  
3-27

Chrome Plated Stem  
Nickel Plated Gland & Bonnet

GASKET: 890190 O-RING INCLUDED

LF457081  
LF457082

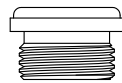

SEAT USED: LF649200

FOR COYNE DELANEY  
LENGTH: 1.93"

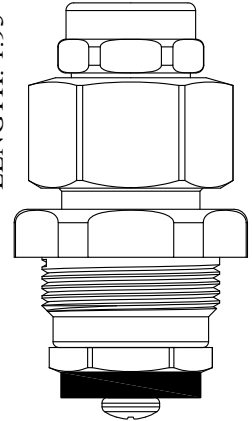

Chrome Plated Unit

GASKET INCLUDED: 895370

460302

FOR DOBO  
LENGTH: 1.93"

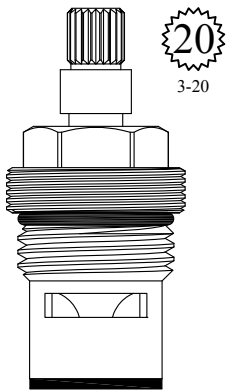

GASKET: 890170 O-RING INCLUDED  
SEAL: 853030  
DISC SET: 151380-PKG

**LF456391**  
**LF456392**

FOR SIMBOLO  
LENGTH: 1.92"

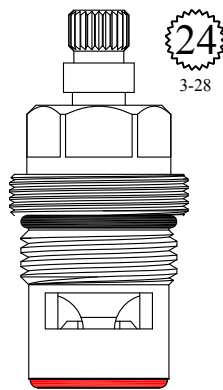

GASKET: 890170 O-RING INCLUDED  
SEAL: 898570-R/B  
DISC SET: 151380-PKG

**LF456911**  
**LF456912**

FOR NICOLAZZI  
LENGTH: 1.92"

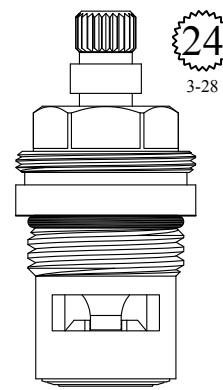

GASKET: 890170 O-RING INCLUDED  
SEAL: 898510-W  
DISC SET: 151380-PKG

**LF456921**  
**LF456922**

FOR AQUASOURCE  
LENGTH 1.94"

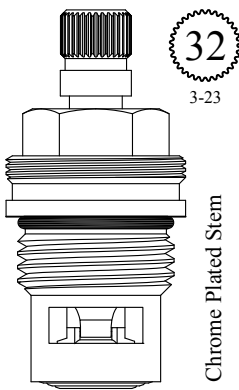

GASKET: 890170 O-RING INCLUDED  
SEAL: 898500  
DISC SET: 112530-PKG

**LF457311**  
**LF457312**

FOR OMNI  
LENGTH: 1.95"

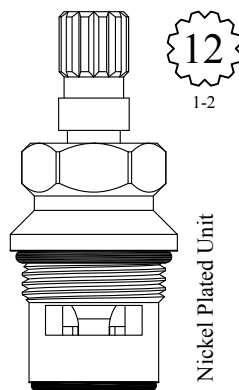

GASKET: 890170 O-RING INCLUDED  
SEAL: 898540  
DISC SET: 112530-PKG

**LF458821**  
**LF458822**

FOR CHATSWORTH  
LENGTH: 1.94"

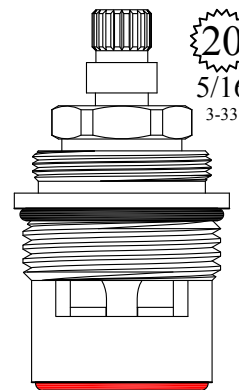

GASKET: 890210 O-RING INCLUDED  
SEAL: 898610-R  
DISC SET: 109850-PKG

**400971**  
**400972**

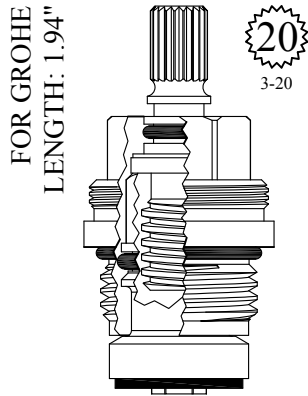

GASKET: 890170 O-RING INCLUDED

**LF457282**



SEAT USED: LF647580

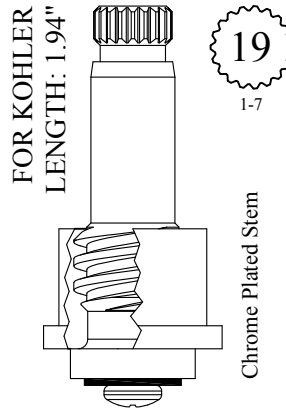

**LF458041**  
**LF458042**  
**LF258041** Stem Only  
**LF258042** Stem Only



SEAT USED: LF647230

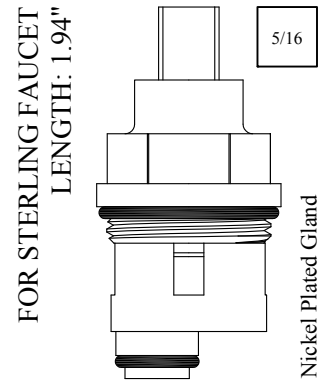

GASKET: 890180 O-RING INCLUDED

**LF458171**  
**LF458172**

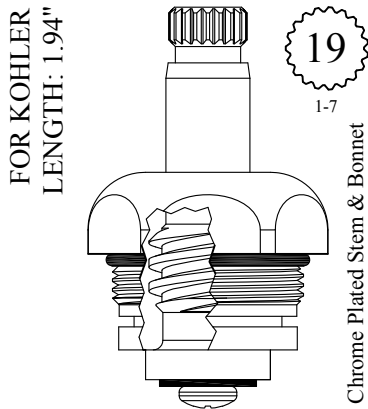

GASKET: 890210 O-RING INCLUDED

**LF458241**  
**LF458242**  
**LF258041** Stem Only  
**LF258042** Stem Only

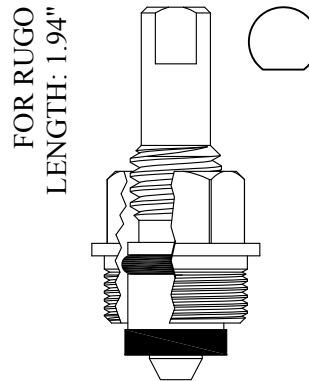

GASKET: 895100

**LF458301**

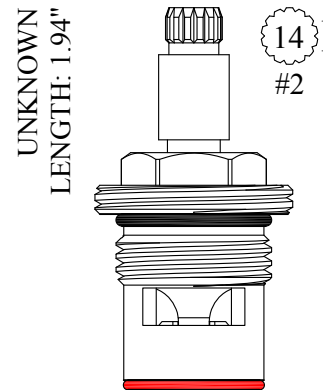

GASKET: 890170 O-RING INCLUDED  
SEAL: 898580-R/B  
DISC SET: 151380-PKG

**LF458431**  
**LF458432**

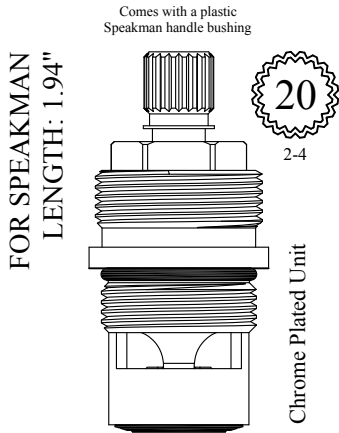

GASKET: 890170 O-RING INCLUDED  
SEAL: 898510-W  
DISC SET: 151380-PKG

**LF458801**  
**LF458802**

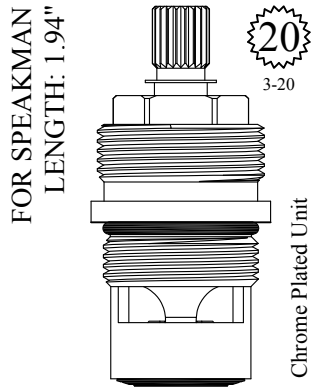

GASKET: 890170 O-RING INCLUDED  
SEAL: 898510-W  
DISC SET: 151380-PKG

**LF458811**  
**LF458812**

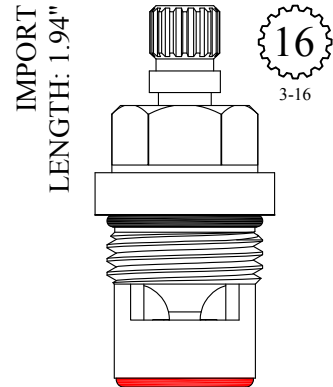

GASKET: 890170 O-RING INCLUDED  
SEAL: 898570-R/B  
DISC SET: 151380-PKG

**LF458871**  
**LF458872**

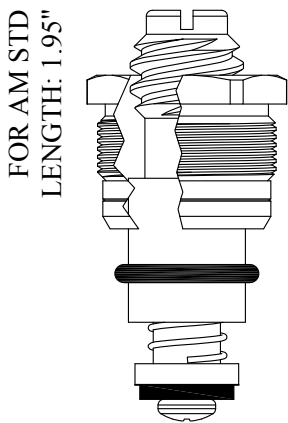

**400591**  
**200591** Stem Only

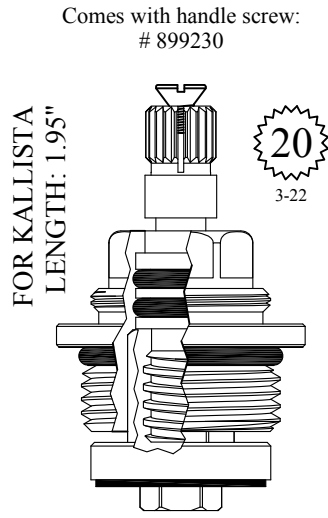

GASKET: 891180 O-RING INCLUDED

**401072**

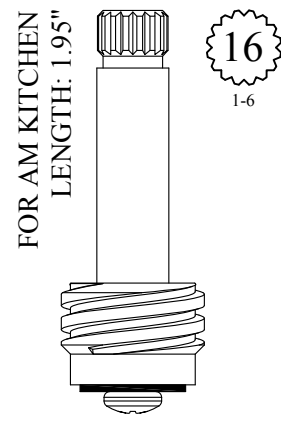

**LF258021**  
**LF258022**



FOR SISCO  
LENGTH: 1.95"

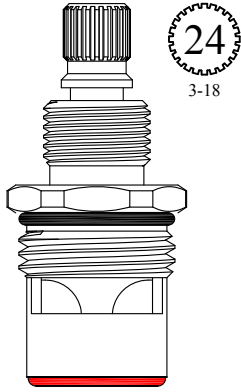

GASKET: 890170 O-RING INCLUDED  
SEAL: 898570-R/B  
DISC SET: 151380-PKG

LF456901  
LF456902

FOR BRIGGS  
LENGTH: 1.95"

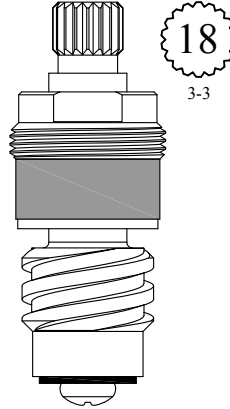

LF457131  
LF457132  
LF257131 Stem Only  
LF257132 Stem Only



FOR ELJER  
LENGTH 1.95"

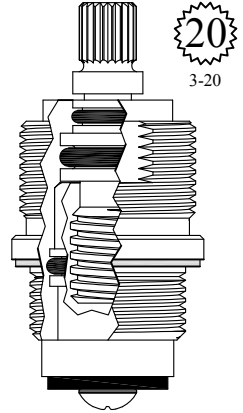

GASKET: 895160 INCLUDED

LF457242



FOR MILWAUKEE  
LENGTH: 1.95"

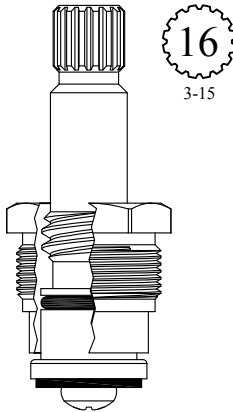

GASKET: 199930

LF457301

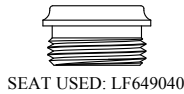

FOR GLACIER BAY  
LENGTH: 1.95"

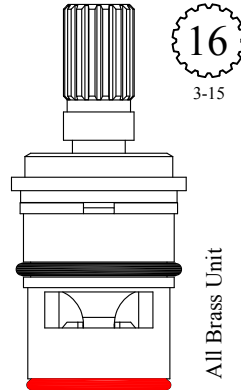

GASKET: 890170 O-RING INCLUDED  
SEAL: 898580-R/B  
DISC SET: 151380-PKG

LF457611  
LF457612

FOR PRICE PFISTER  
LENGTH: 1.95"

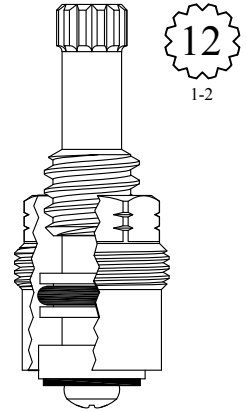

GASKET: 895060

LF458051



Comes with handle screw:  
# 899230

FOR ELJER  
LENGTH: 1.95"

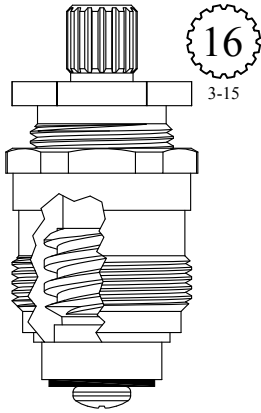

GASKET: 895120

LF458101  
LF458102  
LF258101 Stem Only  
LF258102 Stem Only



SEAT USED: LF648160

FOR KALLISTA  
LENGTH: 1.95"

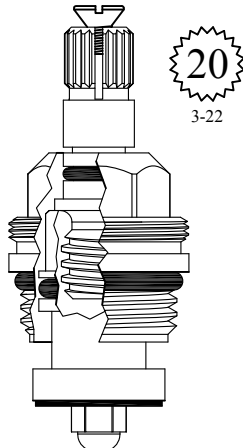

GASKET: 891150 O-RING INCLUDED

LF458502

FOR AM STD  
LENGTH: 1.96"

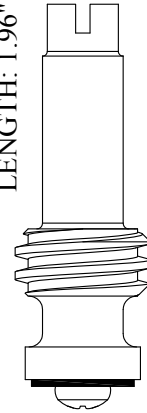

257351

FOR GERBER  
LENGTH: 1.96"

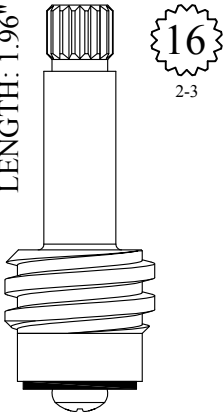

LF259021  
LF259022



SEAT USED: LF649150

FOR SAYCO  
LENGTH: 1.96"

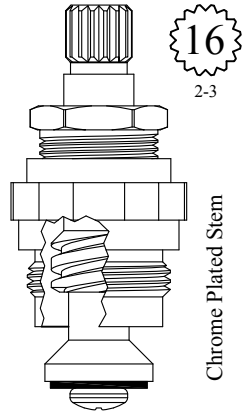

GASKET: 895100

LF458061  
LF458062  
LF258061 Stem Only  
LF258062 Stem Only

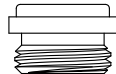

SEAT USED: LF647450

FOR AM STD  
LENGTH: 1.96"

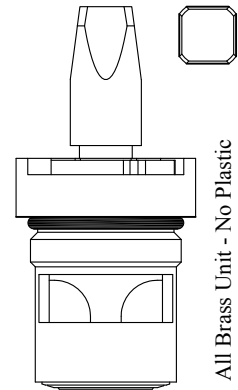

GASKET: 890170 O-RING INCLUDED  
SEAL: 898510-W  
DISC SET: 151380-PKG

LF458901  
LF458902

All Brass Unit - No Plastic



FOR SAYCO  
LENGTH: 1.96"

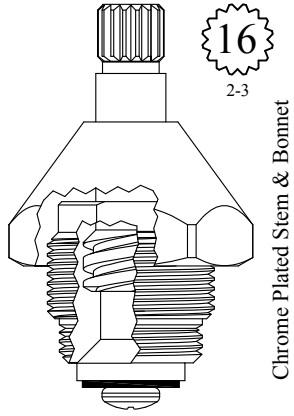

GASKET: 895100

- LF459081
- LF459082
- LF258061 Stem Only
- LF258062 Stem Only

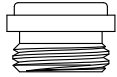

SEAT USED: LF647450

FOR STREAMWAY  
LENGTH: 1.97"

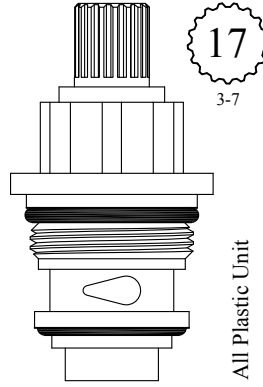

GASKET: 891150 O-RING INCLUDED

- 454041
- 454042

FOR DICK BROS.  
LENGTH: 1.97"

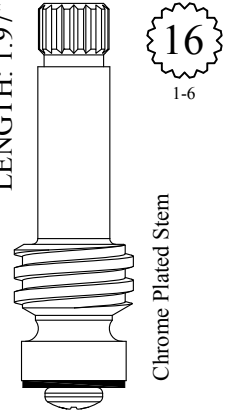

- LF257271
- LF257272

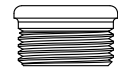

SEAT USED: LF649760

FOR RAPETTI  
FOR ELJER  
LENGTH 1.97"

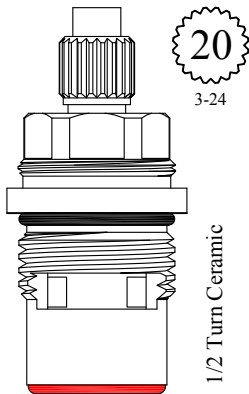

GASKET: 890170 O-RING INCLUDED  
SEAL: 898570-R/B  
DISC SET: 124290-PKG

- LF457361
- LF457362

FOR BROADWAY  
LENGTH 1.97"

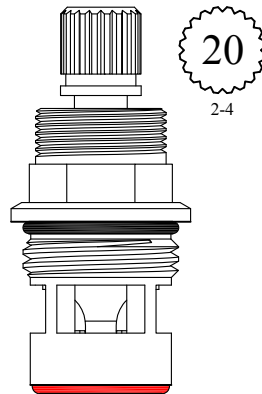

GASKET: 890170 O-RING INCLUDED  
SEAL: 898570-R/B  
DISC SET: 151380-PKG

- LF457601
- LF457602

FOR ARTISTIC BRASS  
LENGTH 1.97"

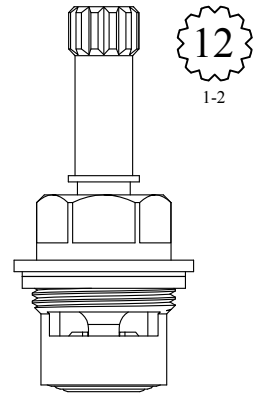

GASKET: 895100 INCLUDED  
SEAL: 898500  
DISC SET: 112530-PKG

- LF458151
- LF458152

FOR ARTISTIC BRASS  
LENGTH: 1.97"

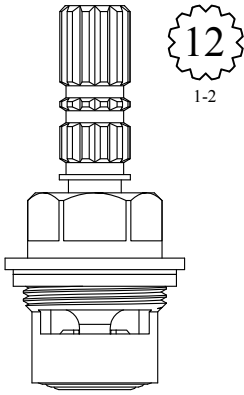

SEAL: 898500  
DISC SET: 112530-PKG  
**LF458161**  
**LF458162**

FOR URREA  
LENGTH: 1.97"

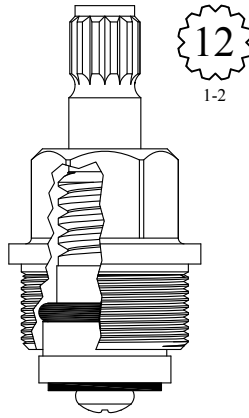

GASKET: 895180  
**LF458401**

FOR KOHLER  
LENGTH: 1.98"

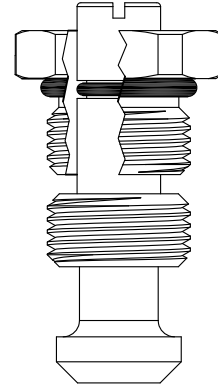

GASKET: 891140 O-RING INCLUDED  
**400911**  
**200911** Stem Only

FOR CRANE  
LENGTH: 1.97"

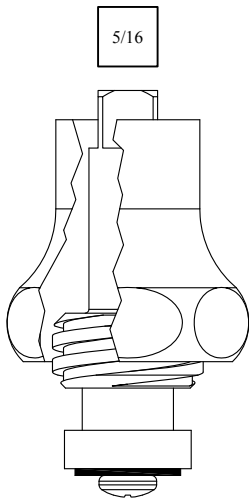

Also available with chrome plated bonnet  
**461541-CP**

**461541**  
**261541** Stem Only

FOR DICK BROS.  
LENGTH: 1.98"

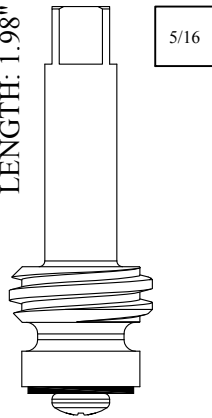

**LF256711**

FOR PRICE PFISTER  
LENGTH: 1.98"

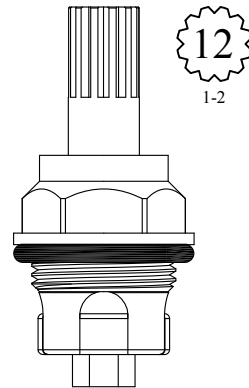

GASKET: 891100 O-RING INCLUDED  
**LF456331**  
**LF456332**

Chrome Bonnet  
available separately

757500

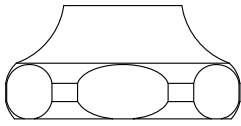

FOR SIGN OF THE CRAB  
LENGTH: 1.98"

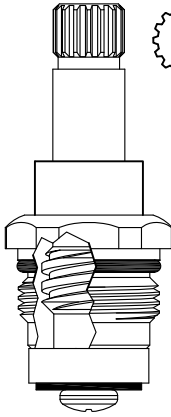

16  
3-16

Chrome Plated Stem

Also available with polished brass stem

LF457501-PB / LF457502-PB

GASKET: 890160 O-RING INCLUDED

LF457501  
LF457502

FOR ELJER  
LENGTH: 1.98"

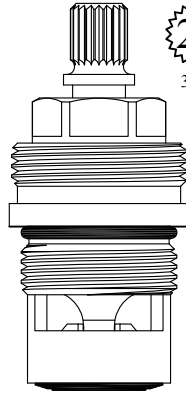

20  
3-20

GASKET: 890170 O-RING INCLUDED  
SEAL: 898510  
DISC SET: 151380-PKG

LF457701  
LF457702

FOR SIGN OF THE CRAB  
LENGTH: 1.99"

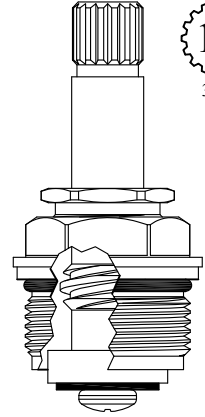

16  
3-16

GASKET: 890180 O-RING INCLUDED

LF457721  
LF457722

FOR SEARS  
FOR RICHARD RHEEM  
LENGTH: 1.99"

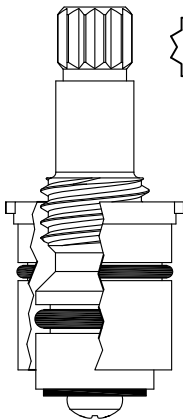

12  
3-10

LF458131  
LF458132

FOR BRIGGS  
LENGTH: 2.00"

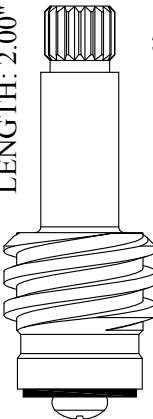

18  
3-3

Chrome Plated Stem

LF255181  
LF255182

FOR PEGASUS  
FOR SIGN OF THE CRAB  
LENGTH: 2.00"

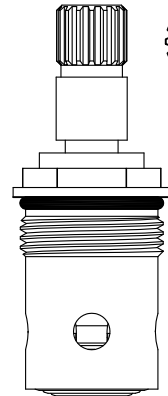

16  
3-16

GASKET: 890160 O-RING INCLUDED  
SEAL: 898500  
DISC SET: 112530-PKG

LF457901  
LF457902

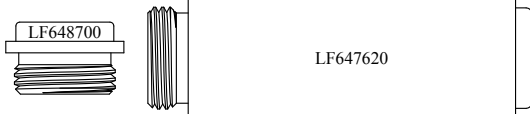

SEAT USED: LF648700 or LF647620

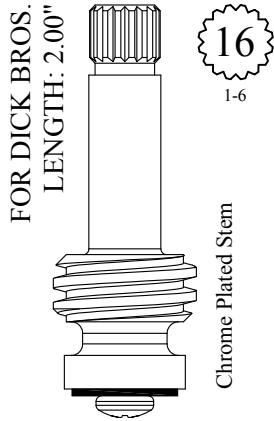

LF256701  
LF256702

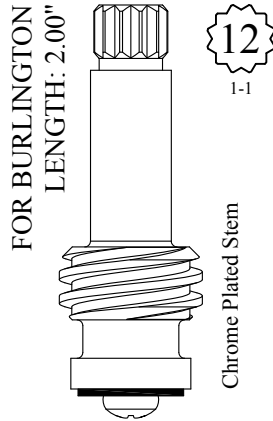

LF260071  
LF260072

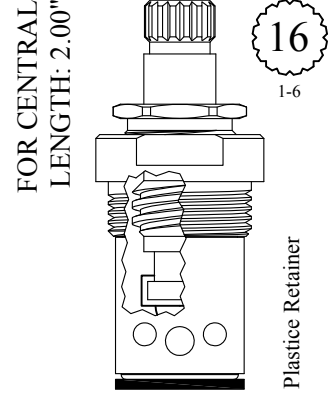

GASKET: 895100

LF453501  
LF453502

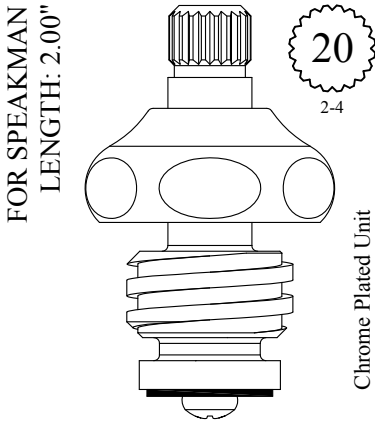

LF457121  
LF457122  
LF257121 Stem Only  
LF257122 Stem Only

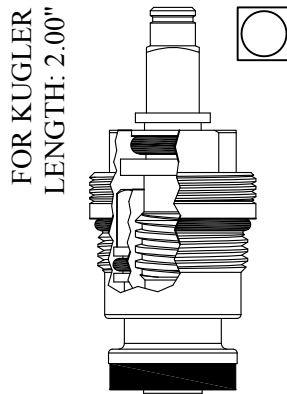

GASKET: 890170 O-RING INCLUDED

LF457262

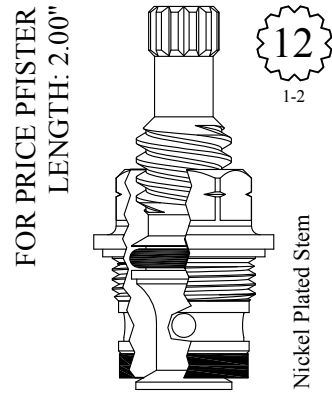

GASKET: 895100

LF458072

FOR STERLING FAUCET  
LENGTH: 2.00"

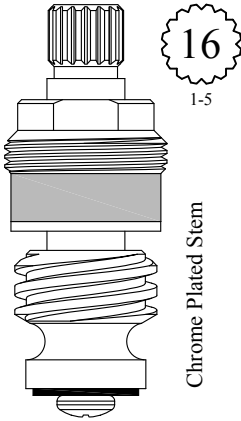

LF458091  
LF458092  
LF258091 Stem Only  
LF458092 Stem Only



FOR T & S  
LENGTH: 2.00"

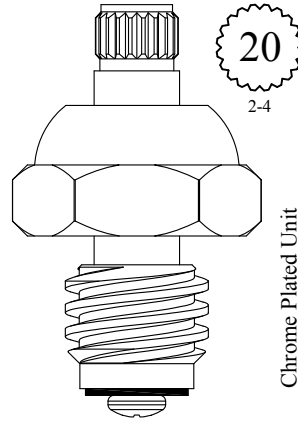

LF458201  
LF458202  
LF258201 Stem Only  
LF258202 Stem Only



FOR MUELLER  
LENGTH: 2.00"

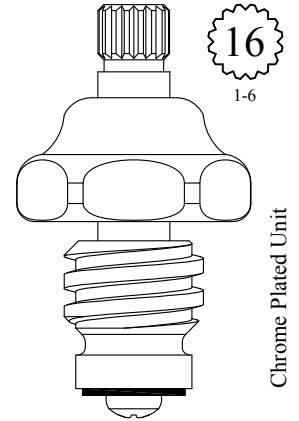

LF459011  
LF459012  
LF259011 Stem Only  
LF259012 Stem Only

FOR KOHLER  
LENGTH: 2.00"

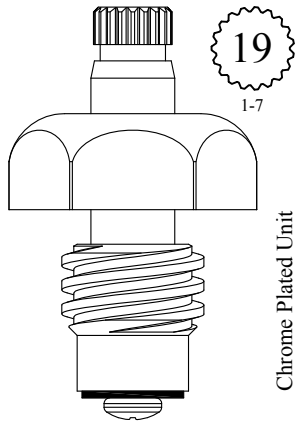

LF459041  
LF459042  
LF259041 Stem Only  
LF259042 Stem Only



FOR MUELLER  
LENGTH: 2.00"

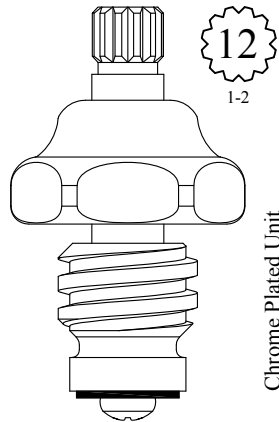

LF459061  
LF459062  
LF259061 Stem Only  
LF259062 Stem Only

FOR FOREMOST  
LENGTH: 2.00"

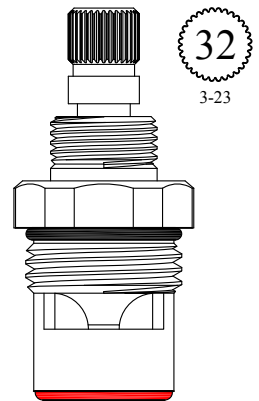

GASKET: 890170 O-RING INCLUDED  
SEAL: 898580-R/B  
DISC SET: 151380-PKG

LF459271  
LF459272

UNKNOWN  
LENGTH: 2.00"

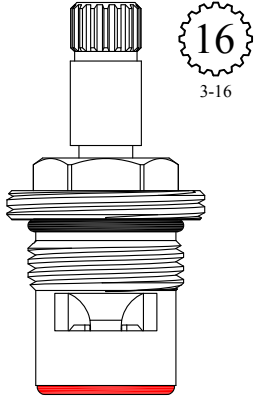

GASKET: 890170 O-RING INCLUDED  
SEAL: 898570-R/B  
DISC SET: 151380-PKG

**LF459431**  
**LF459432**

FOR CENTRAL  
LENGTH: 2.01"

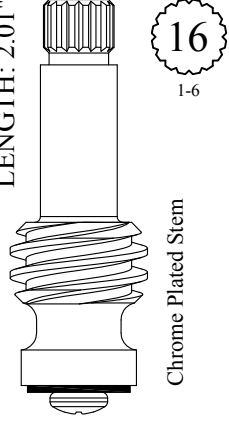

Chrome Plated Stem

**LF258081**  
**LF258082**

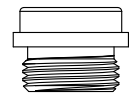

SEAT USED: LF648550

FOR INDIANA  
LENGTH: 2.01"

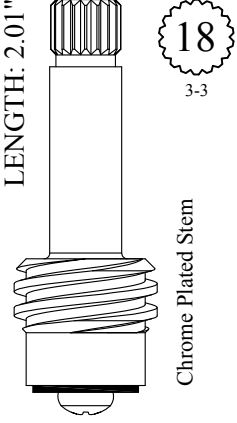

Chrome Plated Stem

**LF259031**  
**LF259032**

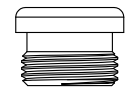

SEAT USED: LF648560

FOR GLACIER BAY  
LENGTH: 2.00"

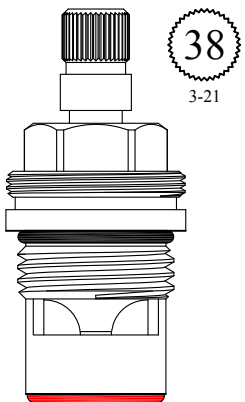

GASKET: 890170 O-RING INCLUDED  
SEAL: 898570-R/B  
DISC SET: 151380-PKG

**LF458341**  
**LF458342**

FOR SEARS  
LENGTH: 2.02"

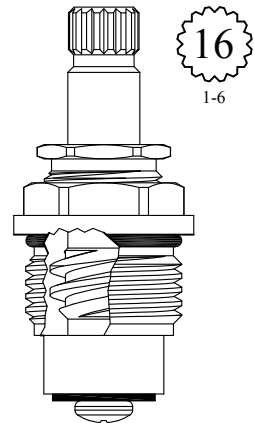

GASKET: 890170 O-RING INCLUDED

**LF458281**  
**LF458282**

FOR PORCHER  
LENGTH: 2.02"

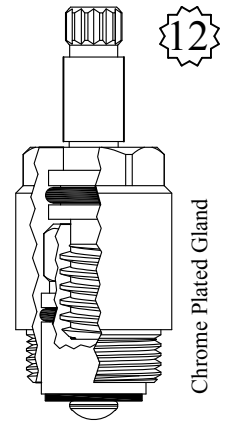

Chrome Plated Gland

**LF458602**

FOR PAINI  
LENGTH 2.02"

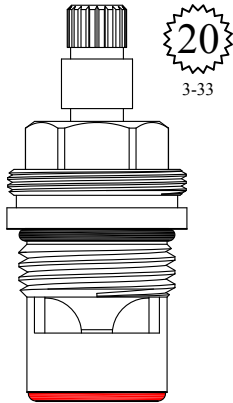

GASKET: 890170 O-RING INCLUDED  
SEAL: 898570-R/B  
DISC SET: 151380-PKG

LF458891  
LF458892

FOR BALOCCHI  
LENGTH 2.02"

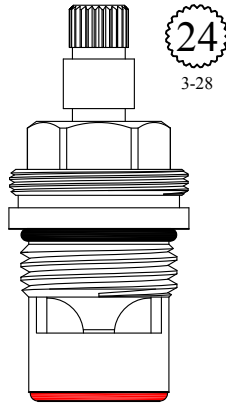

GASKET: 890170 O-RING INCLUDED  
SEAL: 898570-R/B  
DISC SET: 151380-PKG

LF459341  
LF459342

FOR STERLING FAUCET  
LENGTH: 2.03"

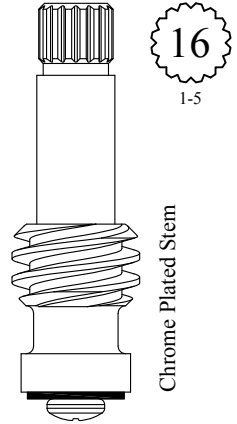

LF259071  
LF259072

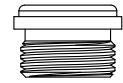

SEAT USED: LF648170

FOR FRANKE

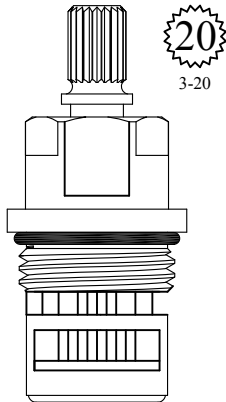

Not Available  
USE LF458941/LF458942

FOR FRANKE  
LENGTH: 2.03"

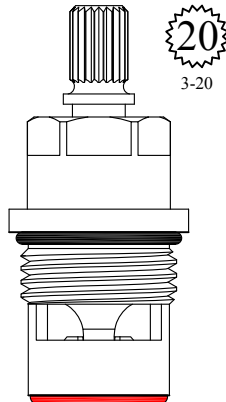

GASKET: 890170 O-RING INCLUDED  
SEAL: 898570-R/B  
DISC SET: 151380-PKG

LF458941  
LF458942

FOR SEARS  
LENGTH 2.03"

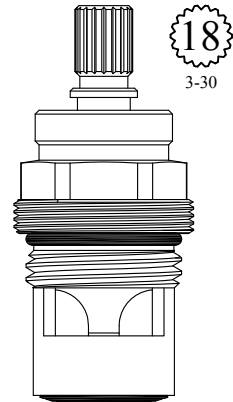

GASKET: 890170 O-RING INCLUDED  
SEAL: 898510  
DISC SET: 151380-PKG

LF459171  
LF459172

FOR SEARS  
LENGTH 2.03"

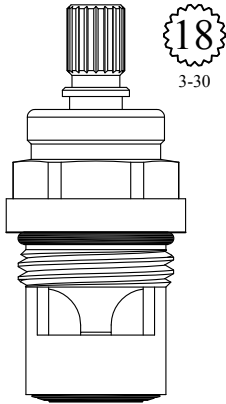

18  
3-30

GASKET: 890170 O-RING INCLUDED  
SEAL: 898510  
DISC SET: 151380-PKG

LF459181  
LF459182

UNKNOWN  
LENGTH 2.03"

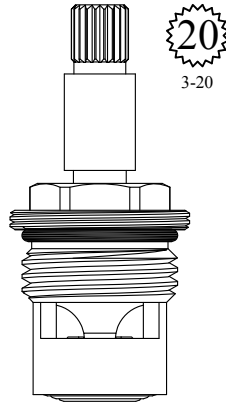

20  
3-20

GASKET: 890170 O-RING INCLUDED  
SEAL: 898500  
DISC SET: 112530-PKG

LF459281  
LF459282

UNKNOWN  
LENGTH: 2.03"

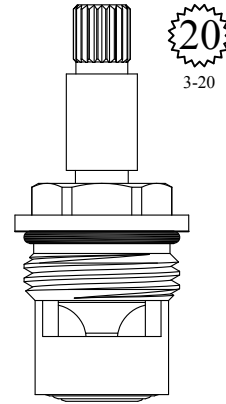

20  
3-20

GASKET: 890170 O-RING INCLUDED  
SEAL: 898500  
DISC SET: 112530-PKG

LF459381  
LF459382

FOR SEPCO  
LENGTH: 2.04"

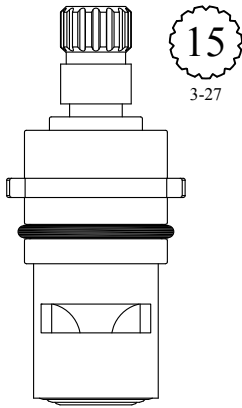

15  
3-27

SEAL: 898500  
DISC SET: 112530-PKG

LF458841  
LF458842

UNKNOWN  
LENGTH 2.04"

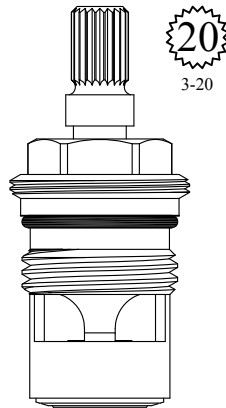

20  
3-20

GASKET: 890170 O-RING INCLUDED  
SEAL: 898510-W  
DISC SET: 151380-PKG

LF459161  
LF459162

IMPORT  
LENGTH 2.04"

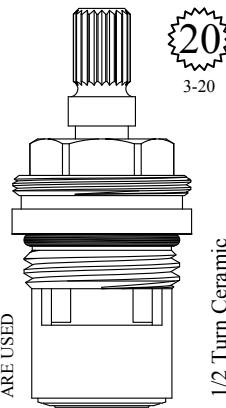

20  
3-20

GASKET: 890170 O-RING INCLUDED  
SEAL: 898510-W  
DISC SET: 124290-PKG  
FITS ALL BODIES  
WHERE 459201/459202  
ARE USED  
1/2 Turn Ceramic

LF459211  
LF459212

FOR SEARS  
LENGTH 2.04"

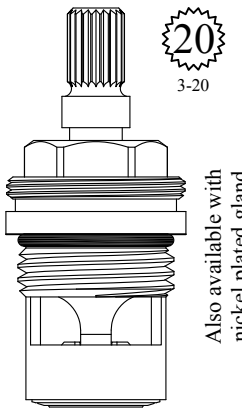

20  
3-20

GASKET: 890170 O-RING INCLUDED  
SEAL: 898510-W  
DISC SET: 151380-PKG

LF459201  
LF459202

Also available with  
nickel plated gland  
LF459201-NP / LF459202-NP

FOR CONCINITY  
LENGTH 2.04"

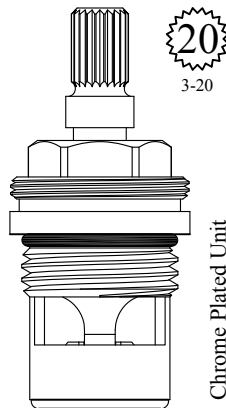

20  
3-20

GASKET: 890170 O-RING INCLUDED  
SEAL: 898570-W  
DISC SET: 151380-PKG

LF459231  
LF459232

Chrome Plated Unit

FOR SIGN OF THE CRAB  
LENGTH: 2.04"

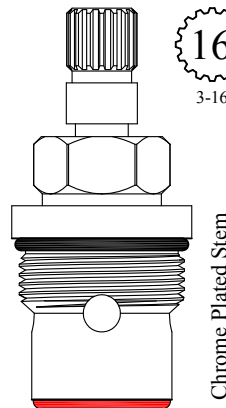

16  
3-16

GASKET: 890170 O-RING INCLUDED  
SEAL: 898570-R/B  
DISC SET: 151380-PKG

LF459371  
LF459372

Chrome Plated Stem



FOR SPRINGHOUSE  
LENGTH: 2.04"

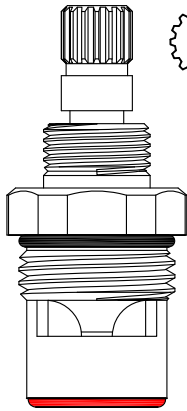

16  
3-16

GASKET: 890170 O-RING INCLUDED  
SEAL: 898580-R/B  
DISC SET: 151380-PKG

LF459771  
LF459772

FOR ARSELUX  
LENGTH: 2.04"

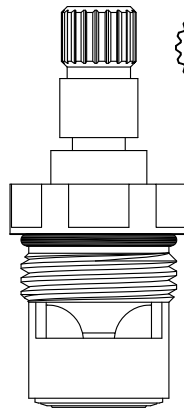

19  
1-7

GASKET: 890170 O-RING INCLUDED  
SEAL: 898510  
DISC SET: 151380-PKG

LF461501  
LF461502

FOR MILWAUKEE  
LENGTH: 2.05"

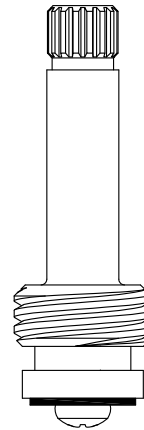

16  
3-15

LF259051  
LF259052

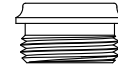

SEAT USED: LF649040

FOR METCRAFT  
LENGTH: 2.05"

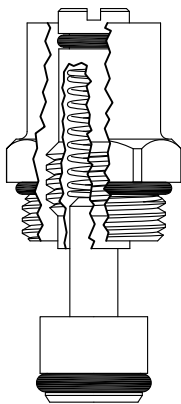

GASKET: 890170 O-RING INCLUDED

LF400751

FOR SAYCO  
LENGTH: 2.05"

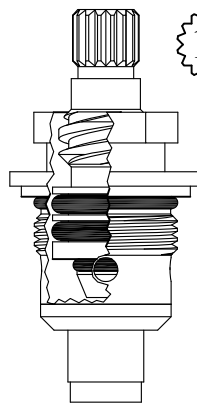

16  
2-3

GASKET: 890160 O-RING INCLUDED  
SEAT INCLUDED: 652360

LF452361  
LF452362

FOR MILWAUKEE  
LENGTH: 2.05"

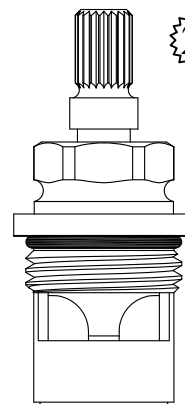

20  
3-20

GASKET: 890170 O-RING INCLUDED  
SEAL: 898510-W  
DISC SET: 151380-PKG

LF458191  
LF458192

FOR BELMONT  
LENGTH: 2.05"

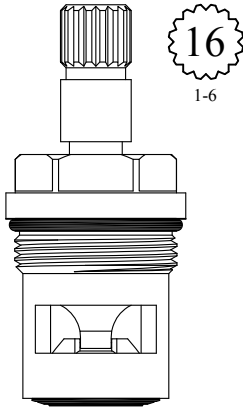

GASKET: 890170 O-RING INCLUDED  
SEAL: 898510  
DISC SET: 151380-PKG

LF459261  
LF459262

FOR KOHLER  
LENGTH: 2.05"



GASKET: 890170 O-RING INCLUDED  
SEAL: 898510  
DISC SET: 151380-PKG

LF459331  
LF459332

Nickel Plated Gland

Also available with

19pt Kohler Adapter Broach #121230  
LF460331 / LF460332

FOR OTTONE & MELODA  
LENGTH: 2.05"

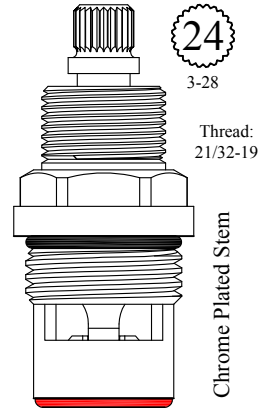

GASKET: 890170 O-RING INCLUDED  
SEAL: 898570-R/B  
DISC SET: 151380-PKG

LF459691  
LF459692

Thread:  
21/32-19

Chrome Plated Stem

FOR DORNBRACHT  
LENGTH: 2.05"

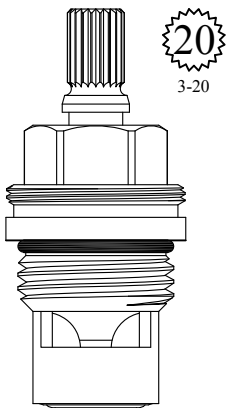

GASKET: 890170 O-RING INCLUDED  
SEAL: 898500  
DISC SET: 112530-PKG

LF459751  
LF459752

FOR PRICE PFISTER  
LENGTH: 2.06"

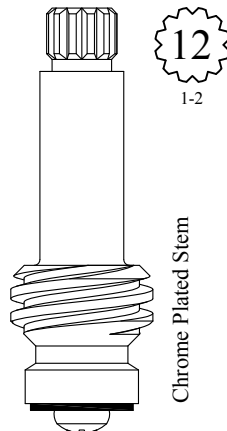

12  
1-2

Chrome Plated Stem

LF260081  
LF260082

UNKNOWN  
LENGTH: 2.06"

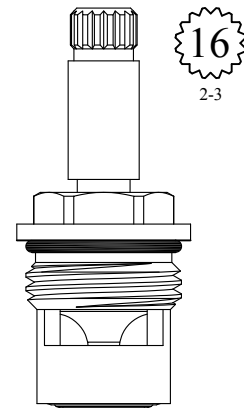

GASKET: 890170 O-RING INCLUDED  
SEAL: 898500  
DISC SET: 112530-PKG

LF457291  
LF457292

16  
2-3

FOR HELVIX  
LENGTH: 2.06"

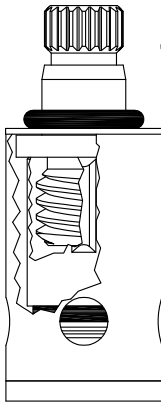

19  
1-7

LF458992

FOR KRONIN BY VIOLA  
LENGTH: 2.06"

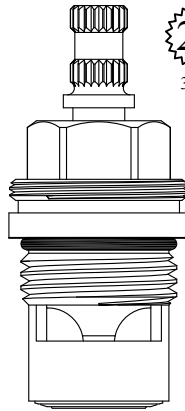

20  
3-20

GASKET: 890170 O-RING INCLUDED  
SEAL: 898510-W  
DISC SET: 151380-PKG

LF459291  
LF459292

FOR EMCO  
LENGTH: 2.07"

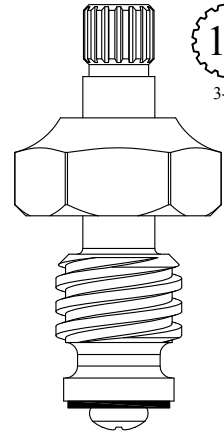

16  
3-15

LF184561  
LF184631 Stem Only

FOR BARNES  
LENGTH: 2.07"

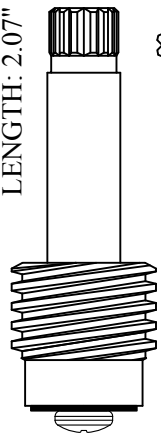

16  
1-6

Chrome Plated Stem

LF263101  
LF263102



SEAT USED: LF648350

UNKNOWN  
LENGTH 2.07"

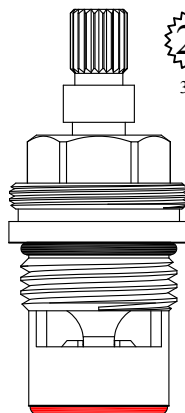

20  
3-20

GASKET: 890170 O-RING INCLUDED  
SEAL: 898570-R/B  
DISC SET: 151380-PKG

LF458861  
LF458862

FOR DELTA  
LENGTH: 2.07"

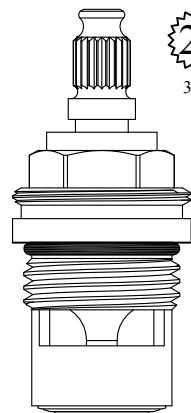

20  
3-20

GASKET: 890170 O-RING INCLUDED  
SEAL: 898510-W  
DISC SET: 151380-PKG

LF459191  
LF459192

FOR MANGORI  
LENGTH: 2.07"

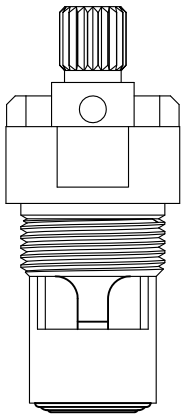

20  
11/32  
3-34

SEAL: 898500  
DISC SET: 112530-PKG  
LF459471  
LF459472

FOR BRIGGS  
LENGTH: 2.08"

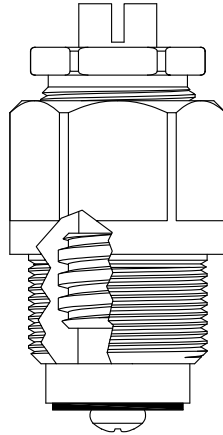

GASKET: 895370

401461  
201461 Stem Only

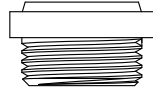

SEAT USED: 647650

FOR NICOLAZZI  
LENGTH: 2.08"

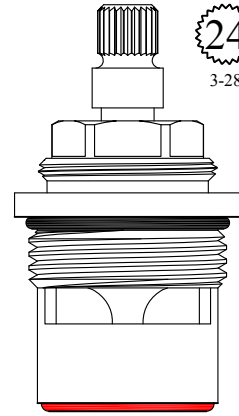

24  
3-28

GASKET: 890210 O-RING INCLUDED  
SEAL: 898610-R/B  
DISC SET: 109850-PKG

401011  
401012

FOR AM BRASS  
LENGTH: 2.08"

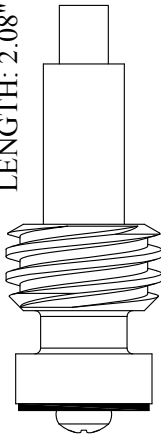

Chrome Plated Stem

LF260501

FOR AM BRASS  
LENGTH: 2.08"

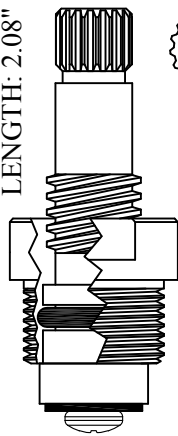

17  
3-7

GASKET: 895100

LF458141  
LF458142



SEAT USED: LF648410

FOR WELLINGTON  
LENGTH: 2.08"

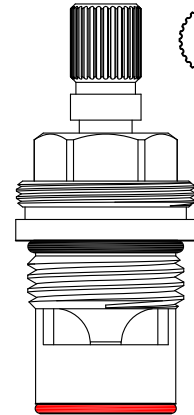

30  
3-35

GASKET: 890170 O-RING INCLUDED  
SEAL: 898580-R/B  
DISC SET: 151380-PKG

LF459351  
LF459352

Nickel Plated Unit

Comes with handle screw:  
# 899230

FOR KALLISTA  
LENGTH: 2.08"

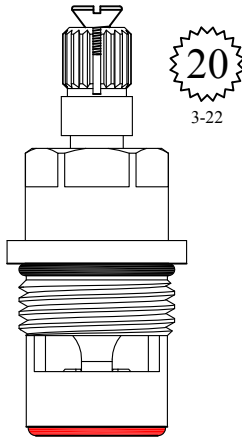

GASKET: 890170 O-RING INCLUDED  
SEAL: 898570-R/B  
DISC SET: 151380-PKG

LF459401  
LF459402

FOR ZURN  
LENGTH: 2.08"

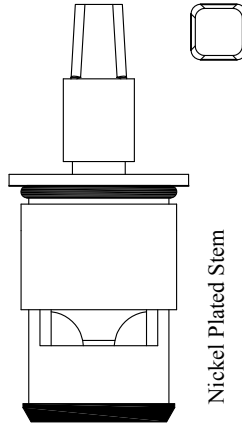

SEAL: 898590  
DISC SET: 151380-PKG

LF459441  
LF459442

FOR AVILION  
FOR FRANKE  
LENGTH: 2.08"

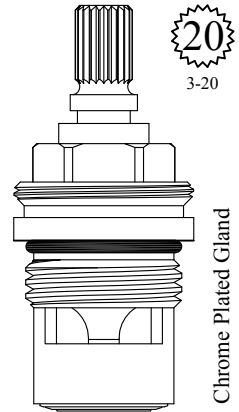

GASKET: 890170 O-RING INCLUDED  
SEAL: 898510-W  
DISC SET: 151380-PKG

LF459491  
LF459492

FOR CRANE  
CERAMIC CONVERSION FOR DIAL-EZE  
LENGTH: 2.08"

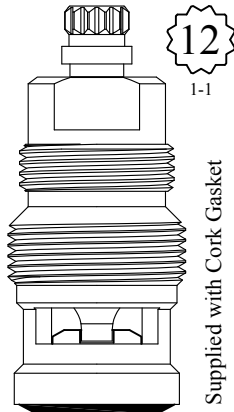

GASKET: 895250 INCLUDED  
DISC SET: 151380-PKG

LF459521  
LF459522

FOR ROHL  
FOR FRANKE  
LENGTH: 2.08"

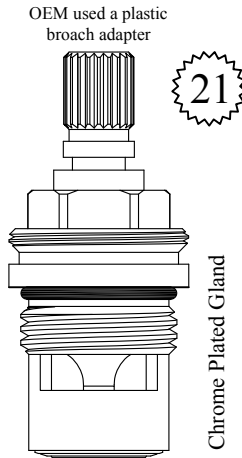

GASKET: 890170 O-RING INCLUDED  
SEAL: 898510-W  
DISC SET: 151380-PKG

LF459541  
LF459542

UNKNOWN  
LENGTH: 2.08"

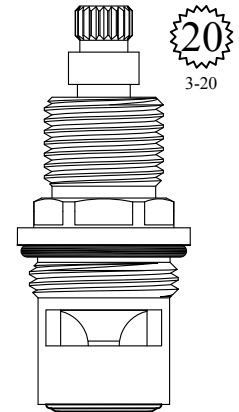

GASKET: 890170 O-RING INCLUDED  
SEAL: 898500  
DISC SET: 112530-PKG

LF459591  
LF459592

FOR PAUL  
FOR PHYLRICH  
LENGTH: 2.08"

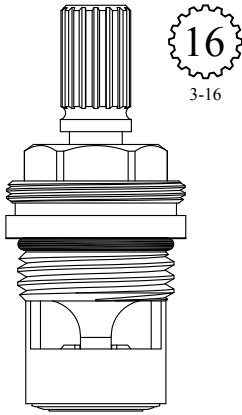

GASKET: 890170 O-RING INCLUDED  
SEAL: 898510-W  
DISC SET: 151380-PKG

LF461901  
LF461902

FOR SANTEC  
LENGTH: 2.08"

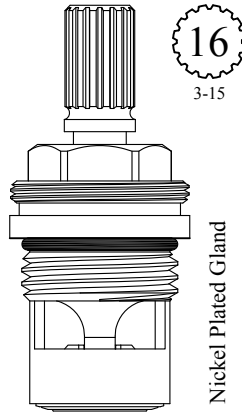

GASKET: 890170 O-RING INCLUDED  
SEAL: 898510-W  
DISC SET: 151380-PKG

LF461911  
LF461912

FOR BORG-WARNER  
LENGTH: 2.09"

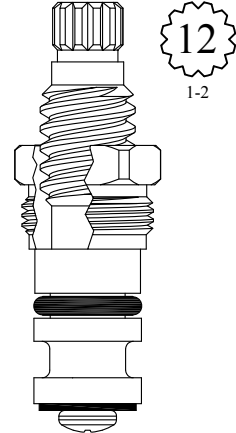

LF459091  
LF459092

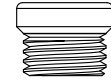

SEAT USED: LF649050

Comes with handle screw:  
# 899230

CERAMIC 1/4 TURN

FOR KALLISTA  
LENGTH: 2.09"

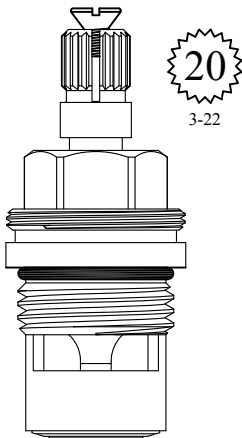

GASKET: 890170 O-RING INCLUDED  
SEAL: 898510-W  
DISC SET: 151380-PKG

LF459391  
LF459392

FOR CHICAGO  
LENGTH: 2.09"

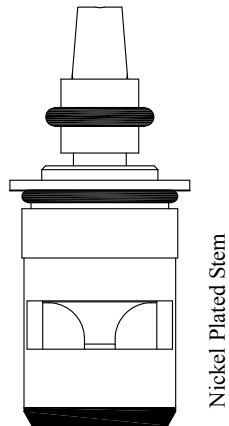

GASKET: 890170 O-RING INCLUDED  
SEAL: 898590  
DISC SET: 151380-PKG

LF459411  
LF459412

UNKNOWN  
LENGTH: 2.09"

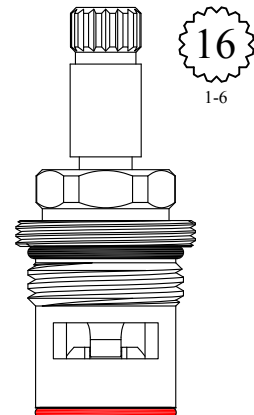

GASKET: 890170 O-RING INCLUDED  
SEAL: 898580-R/B  
DISC SET: 151380-PKG

LF459531  
LF459532

FOR PRICE PFISTER  
LENGTH: 2.10"

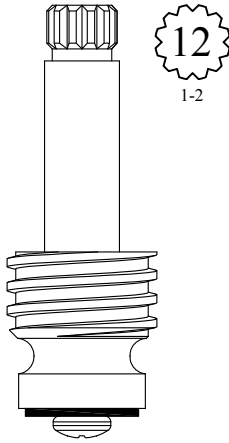

LF259251

FOR ELK  
LENGTH: 2.10"

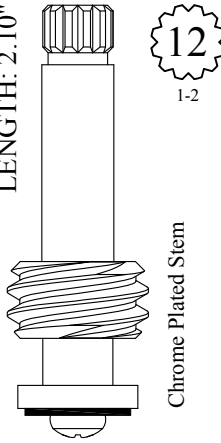

LF261101  
LF261102

FOR METCRAFT  
LENGTH: 2.10"

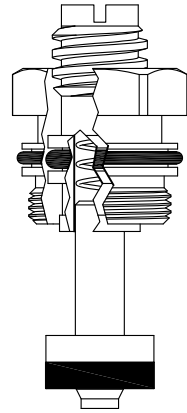

LF400441

FOR METCRAFT  
LENGTH: 2.10"

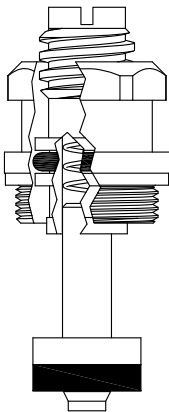

GASKET: 895100 INCLUDED

LF400461

FOR SISCO  
LENGTH: 2.10"

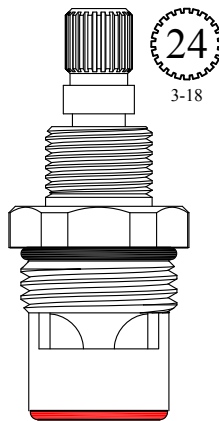

GASKET: 890170 O-RING INCLUDED  
SEAL: 898580-R/B  
DISC SET: 151380-PKG

LF459221  
LF459222

FOR JADO  
LENGTH 2.10"

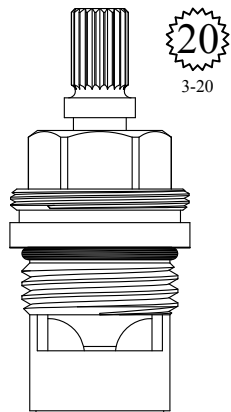

GASKET: 890170 O-RING INCLUDED  
SEAL: 898510-W  
DISC SET: 151380-PKG

LF459301  
LF459302

FOR SANTEC  
LENGTH: 2.10"

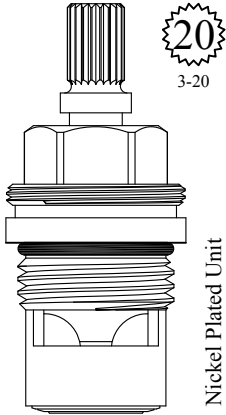

Nickel Plated Unit

GASKET: 890170 O-RING INCLUDED  
SEAL: 898510-W  
DISC SET: 151380-PKG

LF459311  
LF459312

FOR BROADWAY  
LENGTH: 2.10"

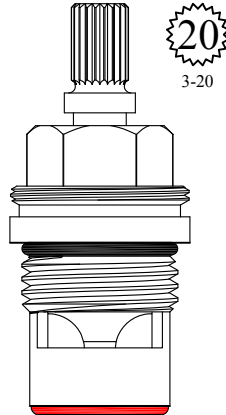

GASKET: 890170 O-RING INCLUDED  
SEAL: 898570-R/B  
DISC SET: 151380-PKG

LF459321  
LF459322

FOR SEARS  
LENGTH: 2.10"

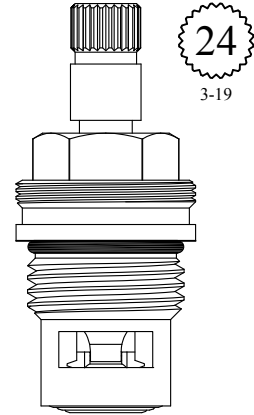

GASKET: 890170 O-RING INCLUDED  
SEAL: 898500  
DISC SET: 112530-PKG

LF459581  
LF459582

FOR AM STD  
LENGTH: 2.11"

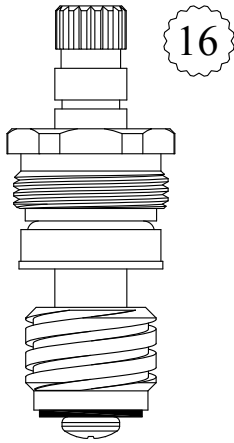

IMPORT  
LENGTH: 2.11"

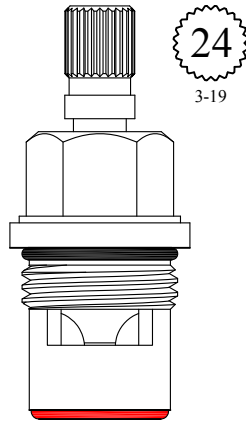

GASKET: 890170 O-RING INCLUDED  
SEAL: 898570-R/B  
DISC SET: 151380-PKG

LF459421  
LF459422

UNKNOWN  
LENGTH: 2.11"

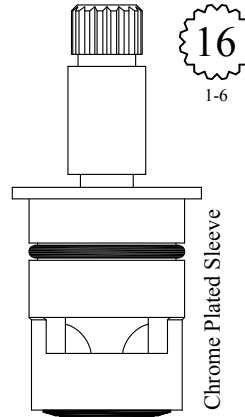

SEAL: 898510  
DISC SET: 151380-PKG

LF459641  
LF459642

UNKNOWN  
LENGTH: 2.11"

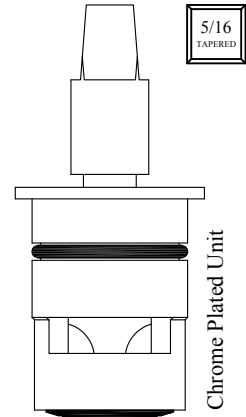

SEAL: 898510  
DISC SET: 151380-PKG

LF459671  
LF459672



SEAT USED: LF648350



FOR ARMONIA  
LENGTH: 2.11"

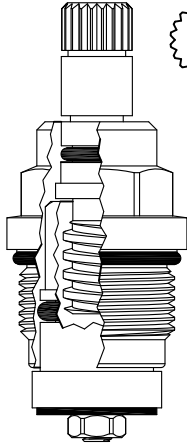

20  
3-14

19 TPI Gland Fine Thread

GASKET: 890180 O-RING INCLUDED

LF460172

FOR ARMONIA  
LENGTH: 2.11"

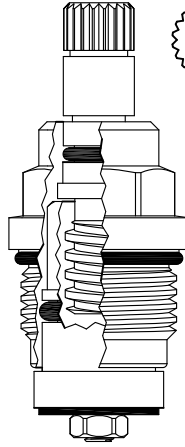

20  
3-14

14 TPI Gland Coarse Thread

GASKET: 890180 O-RING INCLUDED

LF460182

FOR REID WATSON  
LENGTH: 2.12"

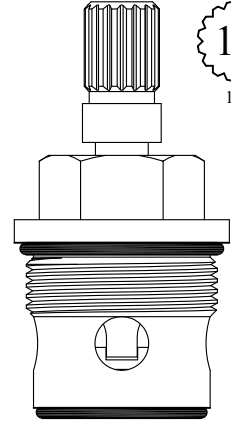

16  
1-5

GASKET: 890210 O-RING INCLUDED  
SEAL: 898530  
DISC SET: 109850-PKG

401151  
401152

FOR KOHLER  
LENGTH: 2.12"

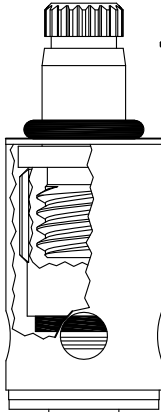

19  
1-7

Chrome Plated Stem  
Plastic Plunger

Also available with  
Brass Plunger

SEAT: LF649460 INCLUDED

LF459101  
LF459102  
LF259101 Stem Only  
LF259102 Stem Only

LF459101-B / LF459102-B

FOR KOHLER  
LENGTH: 2.12"

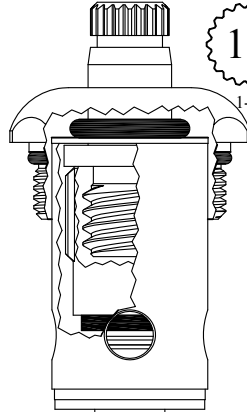

19  
1-7

Chrome Plated Stem & Bonnet  
Plastic Plunger

GASKET: 890210 O-RING INCLUDED  
SEAT: LF649460 INCLUDED

LF459141  
LF459142  
LF259101 Stem Only  
LF259102 Stem Only

FOR GROHE  
LENGTH: 2.12"

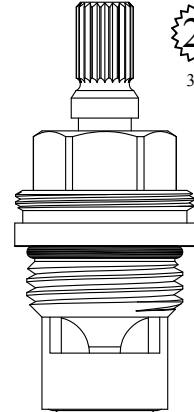

20  
3-20

GASKET: 890170 O-RING INCLUDED  
SEAL: 898500  
DISC SET: 112530-PKG

LF459501  
LF459502

FOR KOHLER  
 CERAMIC CONVERSION FOR LF459101/2  
 LENGTH: 2.12"

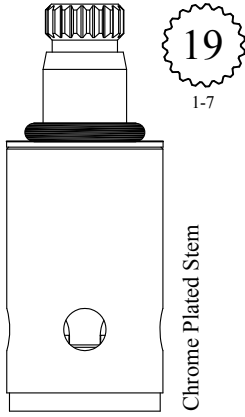

Chrome Plated Stem

DISC SET: 151380-PKG

LF459601  
 LF459602

FOR ELJER  
 LENGTH: 2.12"

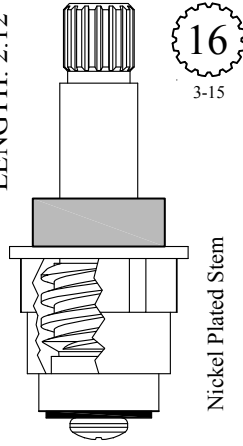

Nickel Plated Stem

LF460091  
 LF460092  
 LF260091 Stem Only  
 LF260092 Stem Only

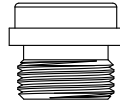

SEAT USED: LF648160

FOR ELJER  
 LENGTH: 2.12"

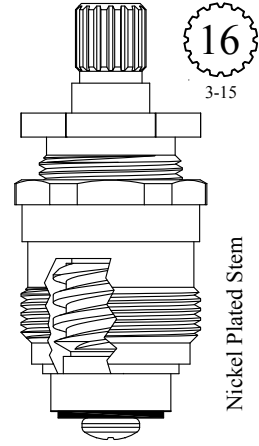

Nickel Plated Stem

GASKET: 895120

LF460111  
 LF460112  
 LF260091 Stem Only  
 LF260092 Stem Only



SEAT USED: LF648160

FOR AM STD  
 LENGTH: 2.12"

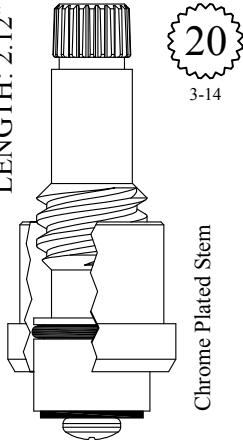

Chrome Plated Stem

GASKET: 891130

LF460121



SEAT USED: LF648990

FOR ELJER  
 LENGTH: 2.12"

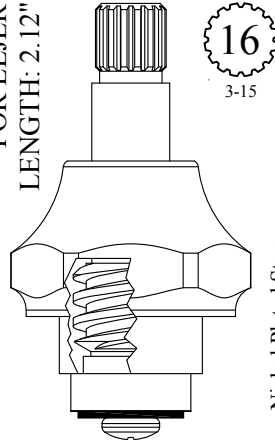

Nickel Plated Stem  
 Chrome Plated Bonnet

LF460191  
 LF460192  
 LF260091 Stem Only  
 LF260092 Stem Only



SEAT USED: LF648160

UNKNOWN  
 LENGTH: 2.12"

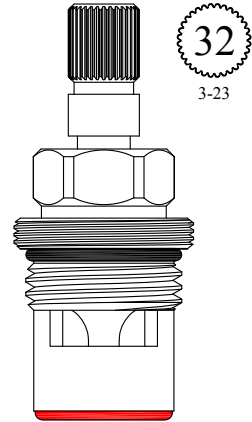

3-23

GASKET: 890170 O-RING INCLUDED  
 SEAL: 898570-R/B  
 DISC SET: 151380-PKG

LF460371  
 LF460372

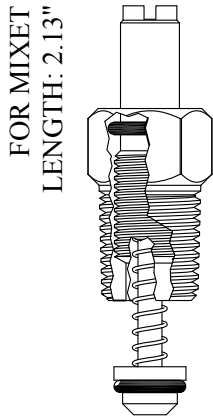

FOR MIXET  
LENGTH: 2.13"

400731

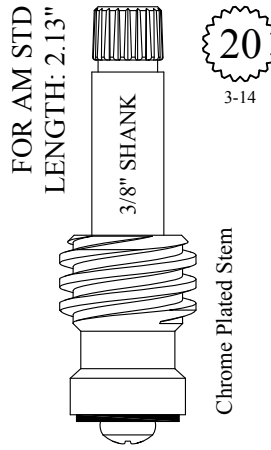

FOR AM STD  
LENGTH: 2.13"

20  
3-14

3/8" SHANK

Chrome Plated Stem

LF260031  
LF260032

USES BARREL:  
LF647021/LF647022

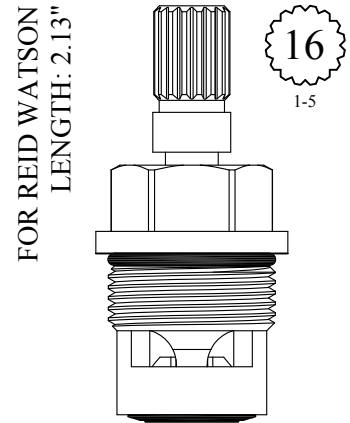

FOR REID WATSON  
LENGTH: 2.13"

16  
1-5

GASKET: 890180 O-RING INCLUDED  
SEAL: 898510  
DISC SET: 151380-PKG

LF459451  
LF459452

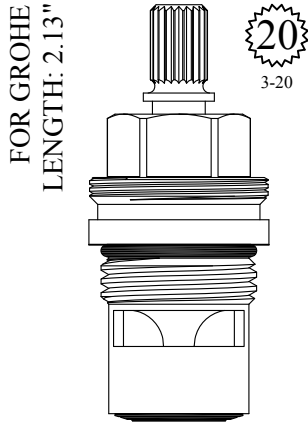

FOR GROHE  
LENGTH: 2.13"

20  
3-20

GASKET: 890170 O-RING INCLUDED  
SEAL: 898510  
DISC SET: 151380-PKG

LF459701  
LF459702

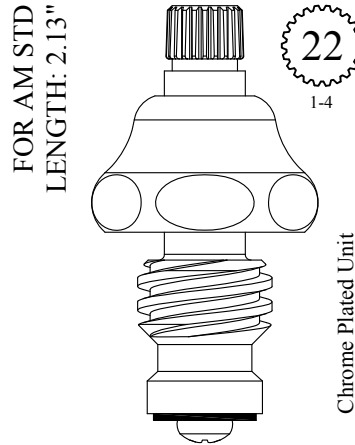

FOR AM STD  
LENGTH: 2.13"

22  
1-4

Chrome Plated Unit

LF460021  
LF460022  
LF260021 Stem Only  
LF260022 Stem Only

SEAT USED: LF648360

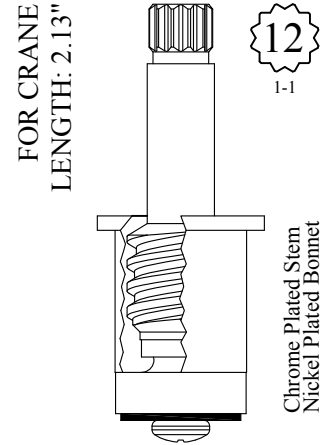
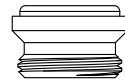

FOR CRANE  
LENGTH: 2.13"

12  
1-1

Chrome Plated Stem  
Nickel Plated Bonnet

LF460041  
LF460042

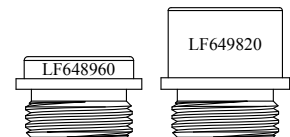

SEAT USED: LF648960 or LF649820

FOR CENTRAL  
LENGTH: 2.13"

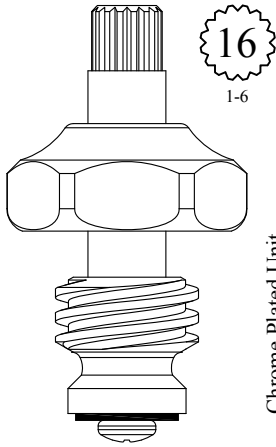

Chrome Plated Unit

LF460061  
LF460062  
LF260061 Stem Only  
LF260062 Stem Only

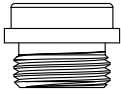

SEAT USED: LF648550

FOR STERLING FAUCET  
LENGTH: 2.13"

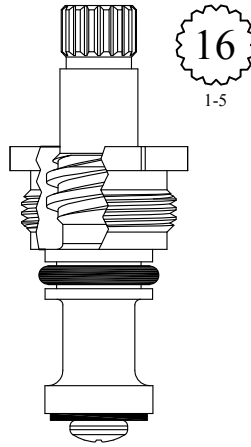

LF460101  
LF460102

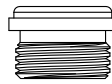

SEAT USED: LF648170

FOR KOHLER  
LENGTH: 2.13"

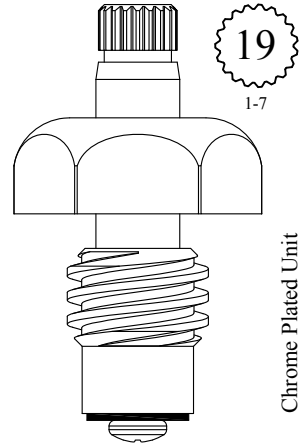

Chrome Plated Unit

LF460161  
LF460162  
LF260161 Stem Only  
LF260162 Stem Only



SEAT USED: LF648730

FOR ACORN  
LENGTH: 2.14"

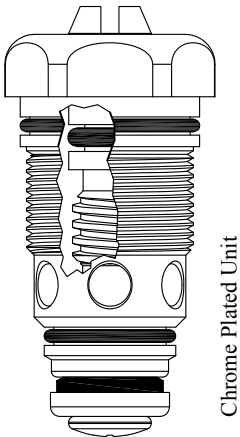

Chrome Plated Unit

461922

FOR AM BRASS  
LENGTH: 2.14"

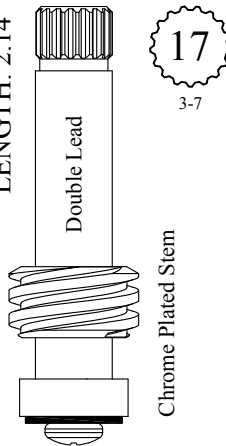

3-7

Chrome Plated Stem

LF260011  
LF260012



SEAT USED: LF648410

FOR AM BRASS  
LENGTH: 2.14"

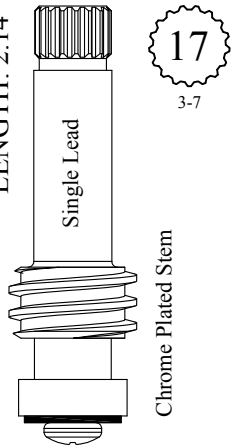

3-7

Chrome Plated Stem

LF260211  
LF260212



SEAT USED: LF648410

FOR ELJER  
LENGTH: 2.14"

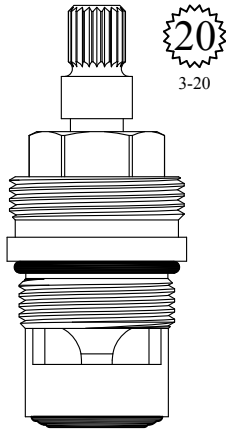

GASKET: 890170 O-RING INCLUDED  
SEAL: 898510  
DISC SET: 151380-PKG

LF459571  
LF459572

FOR KINGSTON BRASS  
LENGTH: 2.14"

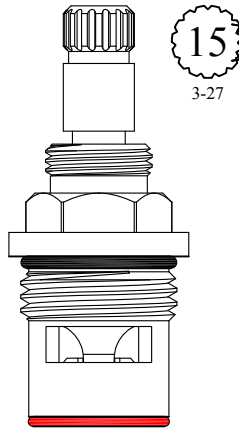

GASKET: 890170 O-RING INCLUDED  
SEAL: 898580-R/B  
DISC SET: 151380-PKG

LF459711  
LF459712

Comes with handle screw:  
# 899230

FOR KALLISTA  
LENGTH: 2.14"

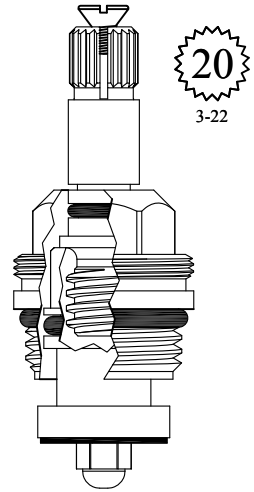

LF459801  
LF459802

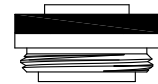

SEAT USED: LF648850-M

FOR MUELLER  
LENGTH: 2.15"

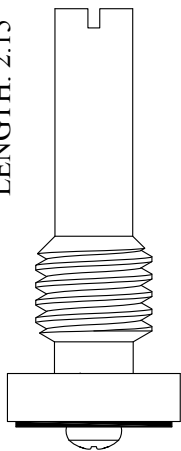

Chrome Plated Stem

201141

UNKNOWN  
LENGTH: 2.15"

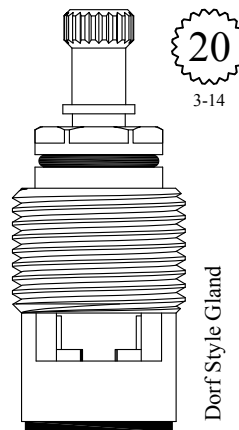

Dorf Style Gland

LF458981

FOR SAYCO  
LENGTH: 2.15"

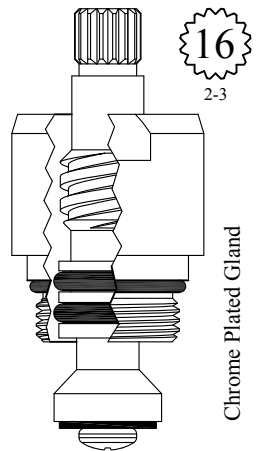

Chrome Plated Gland

GASKET: 890170 O-RING INCLUDED

LF459111  
LF459112



SEAT USED: LF647450

FOR OTTONE & MELODA  
LENGTH: 2.15"

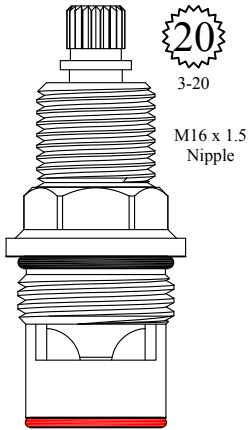

20  
3-20

M16 x 1.5  
Nipple

GASKET: 890170 O-RING INCLUDED  
SEAL: 898580-R/B  
DISC SET: 151380-PKG

LF460841  
LF460842

FOR DORNBRACHT  
LENGTH: 2.16"

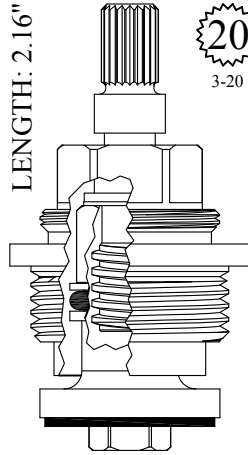

20  
3-20

401082



SEAT USED: LF647120

FOR DELTA  
LENGTH: 2.16"

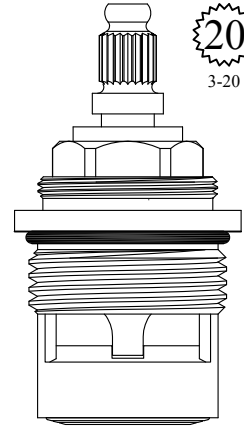

20  
3-20

SEAL: 898520  
DISC SET: 109850-PKG

401101  
401102

FOR GERBER  
LENGTH: 2.20"

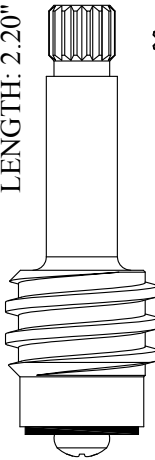

16  
2-3

LF261111  
LF261112

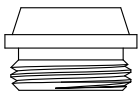

SEAT USED: LF649150

FOR ACORN  
LENGTH: 2.16"

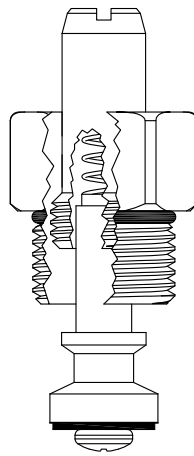

GASKET: 890160 O-RING INCLUDED

LF400571  
LF200571 Stem Only

UNKNOWN  
LENGTH: 2.16"

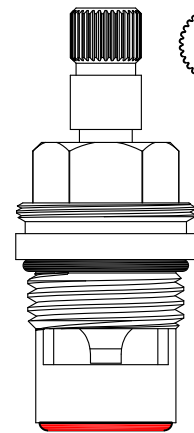

32  
3-23

GASKET: 890170 O-RING INCLUDED  
SEAL: 898570-R/B  
DISC SET: 151380-PKG

LF459361  
LF459362

FOR SAVOY  
LENGTH: 2.16"

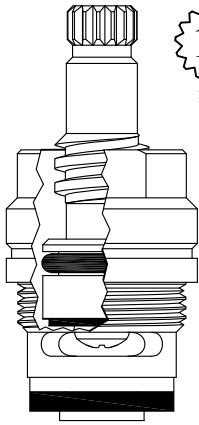

15  
1-13

Chrome Plated Gland

Also available with monel seat LF648850-M  
LF459631-M / LF459632-M

GASKET: 895150  
SEAT INCLUDED: LF648850

LF459631  
LF459632

FOR PRINCIPE  
LENGTH: 2.16"

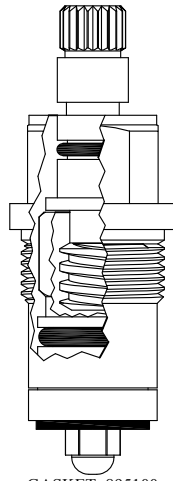

20  
11/32  
3-34

GASKET: 895100

LF459812

FOR BRIGGS  
LENGTH: 2.16"

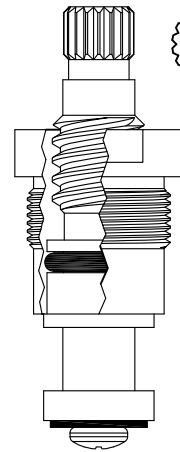

18  
3-3

GASKET: 895100

LF461011  
LF461012

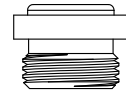

SEAT USED: LF648120

FOR AM STD  
LENGTH: 2.16"

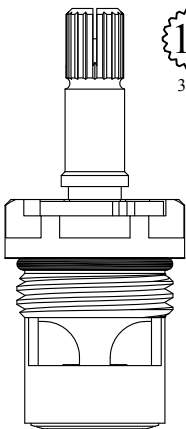

18  
3-30

All Brass Unit

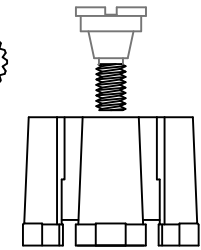

Available with Handle  
Bushing and Screw  
LF461721

GASKET: 890170 O-RING INCLUDED  
SEAL: 898510-W  
DISC SET: 151380-PKG

LF461701  
LF461702

FOR SEPCO  
LENGTH: 2.16"

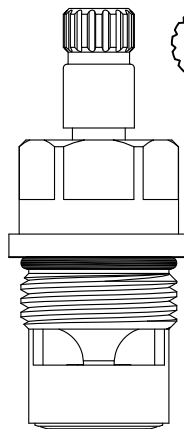

15  
3-27

GASKET: 890170 O-RING INCLUDED  
SEAL: 898510-W  
DISC SET: 151380-PKG

LF462451  
LF462452

FOR SAYCO  
LENGTH 2.17"

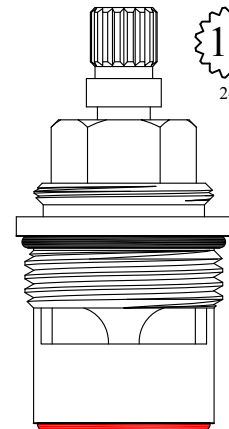

16  
2-3

GASKET: 890210 O-RING INCLUDED  
SEAL: 898610-R/B  
DISC SET: 109850-PKG

401051  
401052

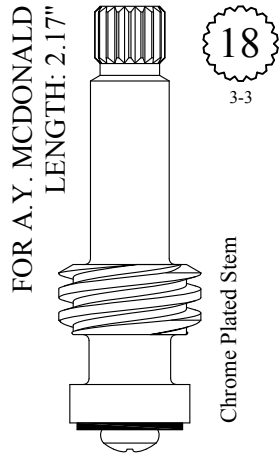

LF261161  
LF261162

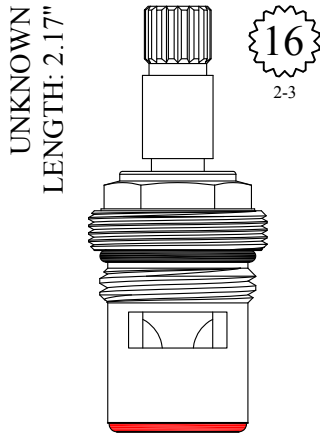

GASKET: 890170 O-RING INCLUDED  
SEAL: 898570-R/B  
DISC SET: 151380-PKG

LF459661  
LF459662

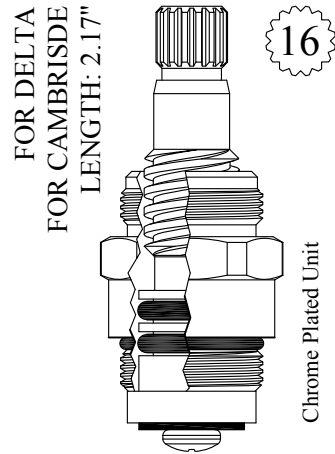

LF460291  
LF460292

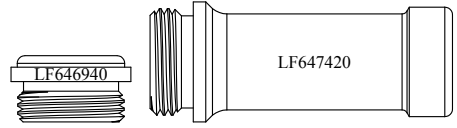

SEAT USED: LF646940 or LF647420

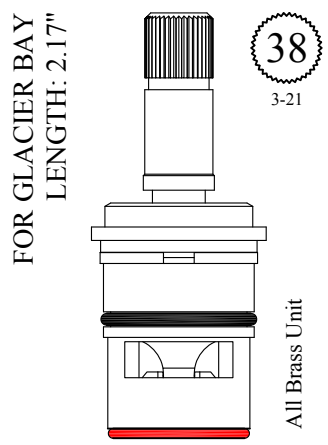

GASKET: 890170 O-RING INCLUDED  
SEAL: 898580-R/B  
DISC SET: 151380-PKG

LF460611  
LF460612

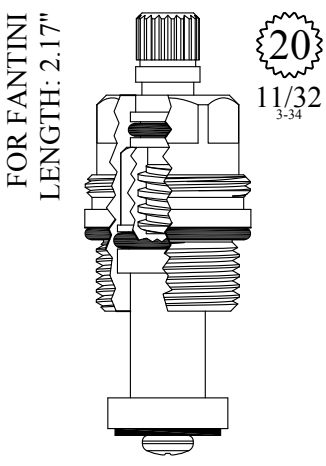

GASKET: 890170 O-RING INCLUDED

LF463332

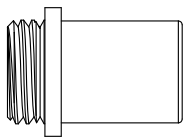

SEAT USED: LF647210

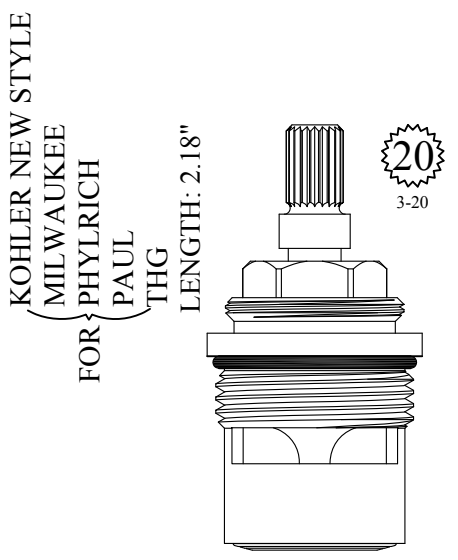

GASKET: 890210 O-RING INCLUDED  
SEAL: 898520  
DISC SET: 109850-PKG

401121  
401122



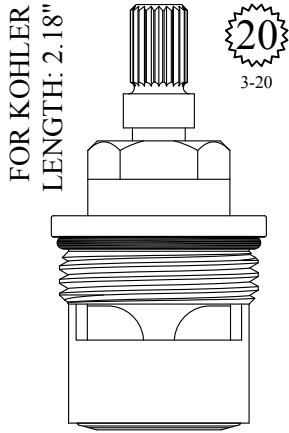

FOR KOHLER  
LENGTH: 2.18"

20  
3-20

GASKET: 890210 O-RING INCLUDED  
SEAL: 898520  
DISC SET: 109850-PKG

401271  
401272

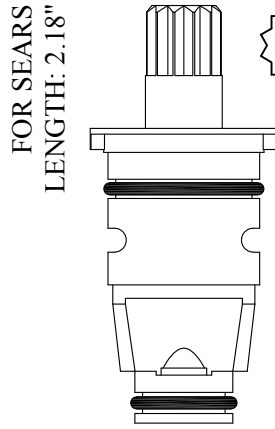

FOR SEARS  
LENGTH: 2.18"

12  
3-10

All Plastic Unit

459461 Red  
459462 Blue

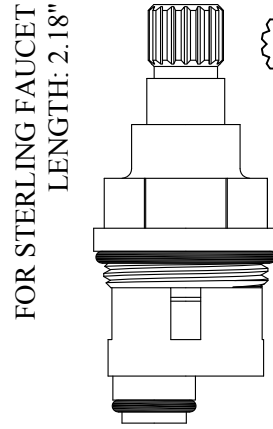

FOR STERLING FAUCET  
LENGTH: 2.18"

16  
1-5

Nickel Plated Gland

GASKET: 890180 O-RING INCLUDED

LF458181  
LF458182

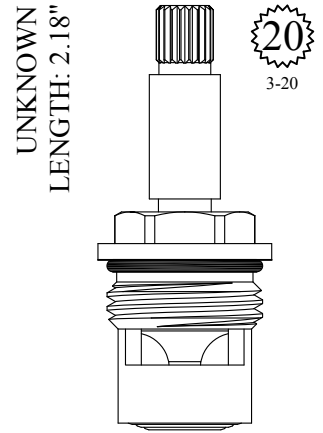

UNKNOWN  
LENGTH: 2.18"

20  
3-20

GASKET: 890170 O-RING INCLUDED  
SEAL: 898500  
DISC SET: 112530-PKG

LF459561  
LF459562

Also available with cap nut  
LF461171-N / LF461172-N

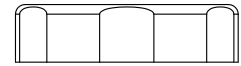

Replaces Midcor  
Cartridge

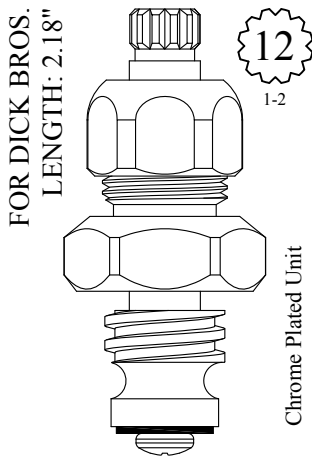

FOR DICK BROS.  
LENGTH: 2.18"

12  
1-2

Chrome Plated Unit

LF459901  
LF259901 Stem Only

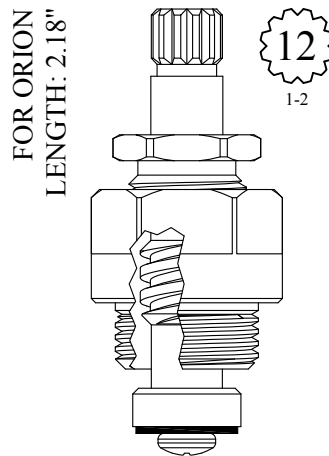

FOR ORION  
LENGTH: 2.18"

12  
1-2

GASKET: 895100

LF460601

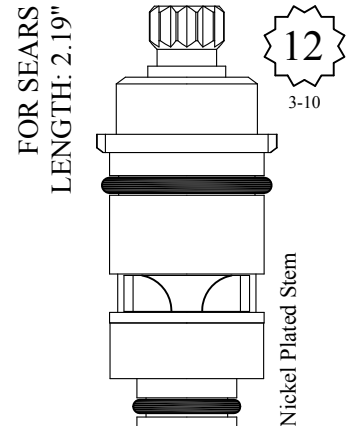

FOR SEARS  
LENGTH: 2.19"

12  
3-10

Nickel Plated Stem

DISC SET: 151380-PKG

LF461171  
LF461172

FOR WATER SAVER  
LENGTH: 2.18"

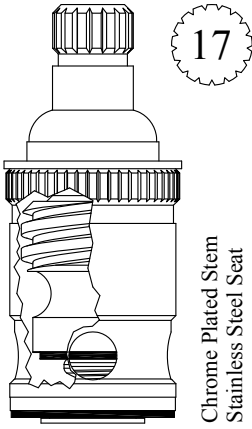

Chrome Plated Stem  
Stainless Steel Seat

SEAT INCLUDED: LF648600

LF461301  
LF461302

FOR WATER SAVER  
LENGTH: 2.18"

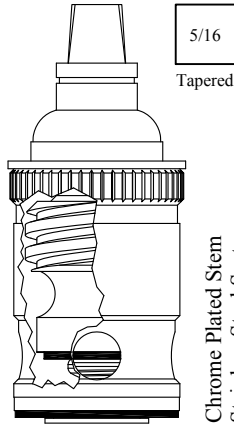

Chrome Plated Stem  
Stainless Steel Seat

SEAT INCLUDED: LF648600

LF461311  
LF461312

FOR WATER SAVER  
LENGTH: 2.18"

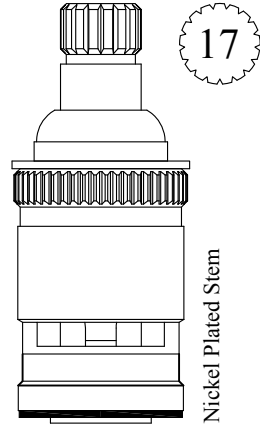

Nickel Plated Stem

DISC SET: 151380-PKG

LF461321  
LF461321

FOR BRIGGS  
LENGTH: 2.19"

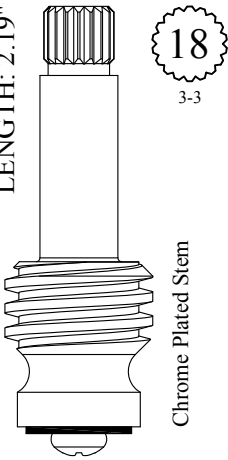

Chrome Plated Stem

201221



SEAT USED: LF649790

FOR DICK BROS.  
LENGTH: 2.19"

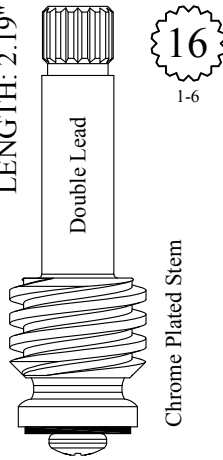

Chrome Plated Stem

LF258111  
LF258112



SEAT USED: LF649760

FOR DICK BROS.  
LENGTH: 2.19"

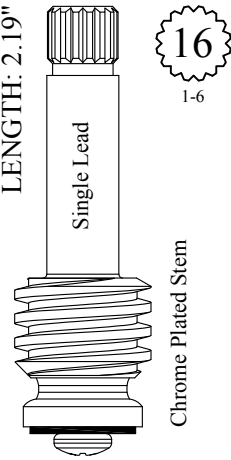

Chrome Plated Stem

LF261061  
LF261062

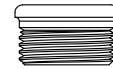

SEAT USED: LF649760

FOR AM BRASS  
LENGTH: 2.19"

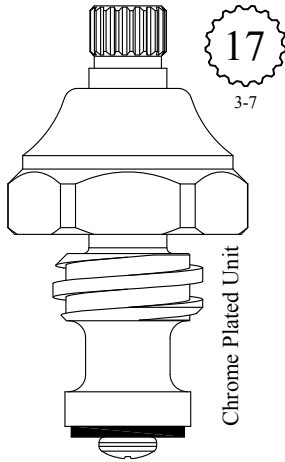

Chrome Plated Unit

LF460241  
LF460242  
LF260241 Stem Only  
LF260242 Stem Only

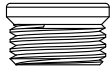

SEAT USED: LF648410

FOR SEARS  
LENGTH: 2.19"

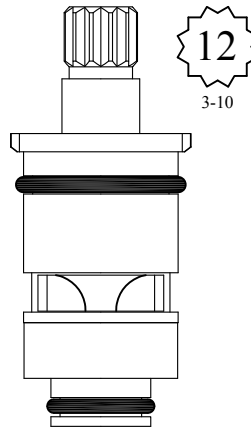

DISC SET: 151380-PKG

LF461071  
LF461072

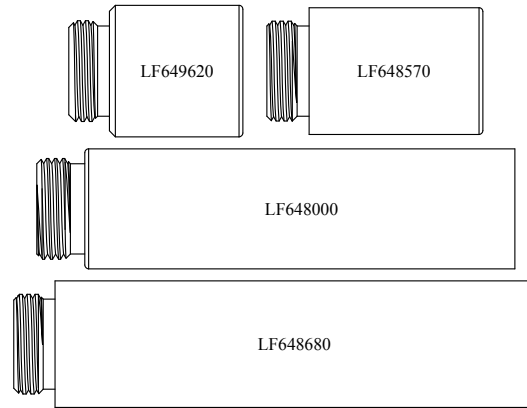

SEATS USED: LF648000, LF648570, LF648680 & LF649620

FOR SYSTEM  
LENGTH: 2.19"

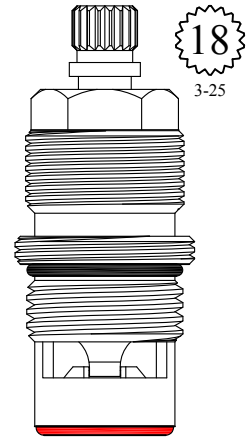

GASKET: 890170 O-RING INCLUDED  
SEAL: 898570-R/B  
DISC SET: 151380-PKG

LF460711  
LF460712

Also available with cap nut

LF461171-N / LF461172-N

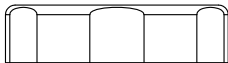

Replaces Midcor  
Cartridge

FOR SEARS  
LENGTH: 2.19"

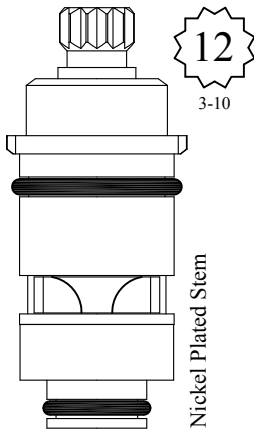

Nickel Plated Stem

DISC SET: 151380-PKG

LF461171  
LF461172

LENGTH: 2.20"

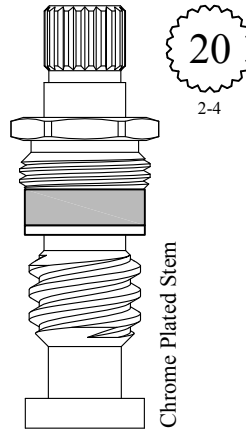

Chrome Plated Stem

401131  
201131 Stem Only

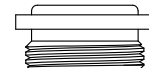

SEAT USED: 648190

FOR DORNBRACHT  
LENGTH: 2.20"

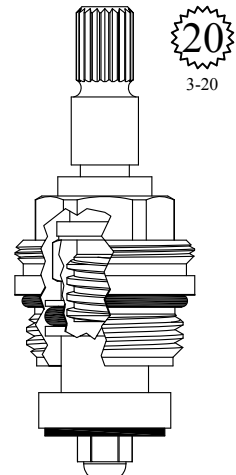

GASKET: 890170 O-RING INCLUDED

LF459512



SEAT USED: LF647110

Double Lead

FOR PRICE PFISTER  
LENGTH: 2.20"

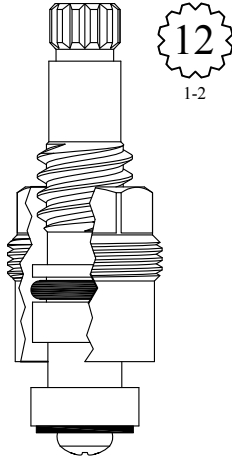

GASKET: 895060

LF461031  
LF461032



SEAT USED: LF648270

Single Lead

FOR PRICE PFISTER  
LENGTH: 2.20"

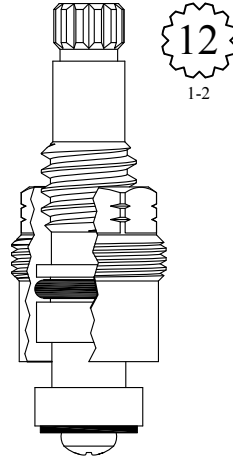

GASKET: 895060

LF461231

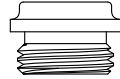

SEAT USED: LF648270

FOR CRANE  
LENGTH: 2.20"

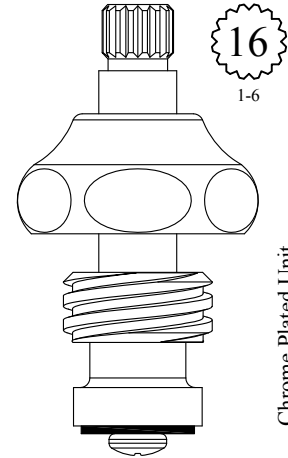

Chrome Plated Unit

LF461041

LF461042

LF261041 Stem Only

LF261042 Stem Only

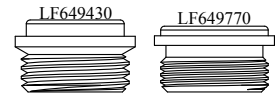

SEAT USED: LF649430 or LF649770

FOR ROHL  
LENGTH: 2.21"

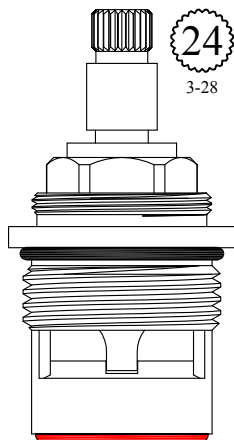

GASKET: 890210 O-RING INCLUDED  
SEAL: 898610-R/B  
DISC SET: 109850-PKG

401031  
401032

FOR HAWS  
LENGTH: 2.21"

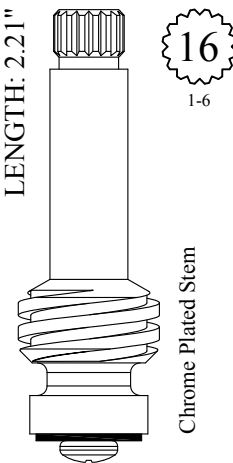

Chrome Plated Stem

LF262161

FOR JADO  
LENGTH 2.22"

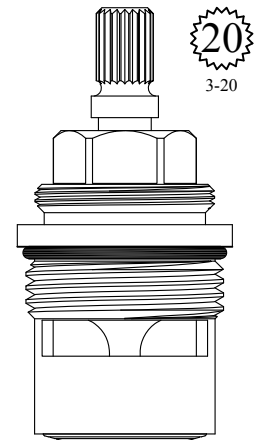

GASKET: 890210 O-RING INCLUDED  
SEAL: 898520  
DISC SET: 109850-PKG

401161  
401162

FOR SEARS  
LENGTH: 2.22"

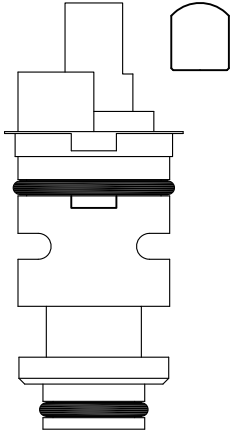

459621 Red  
459622 Blue

FOR SEARS  
LENGTH: 2.22"

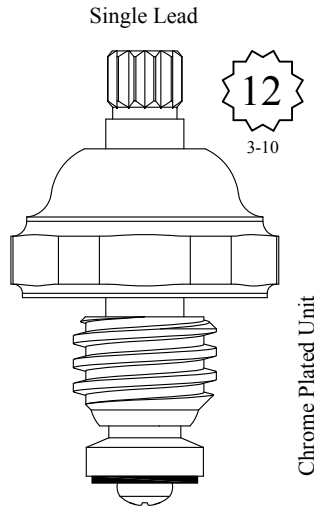

LF463021  
LF263021 Stem Only



SEAT USED: LF648700

FOR SEARS  
LENGTH: 2.22"

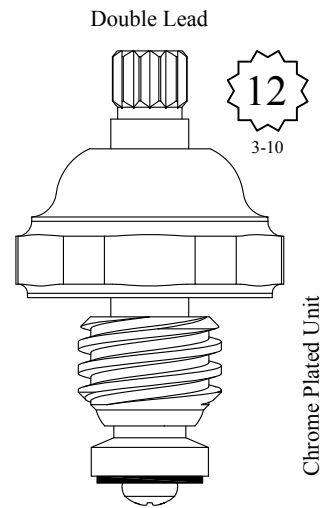

LF463031  
LF463032  
LF263031 Stem Only  
LF263032 Stem Only

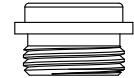

SEAT USED: LF648700

FOR DORNBRACHT  
LENGTH: 2.52"

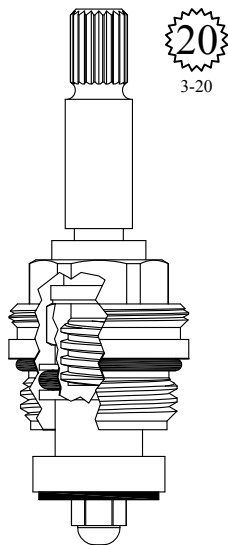

GASKET: 890170 O-RING INCLUDED

LF463872



SEAT USED: LF647110

FOR SIGN OF THE CRAB  
LENGTH: 2.23"

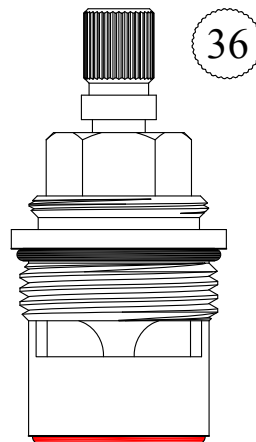

GASKET: 890210 O-RING INCLUDED  
SEAL: 898610-R/B  
DISC SET: 109850-PKG

400981  
400982

Comes with handle screw: # 899230

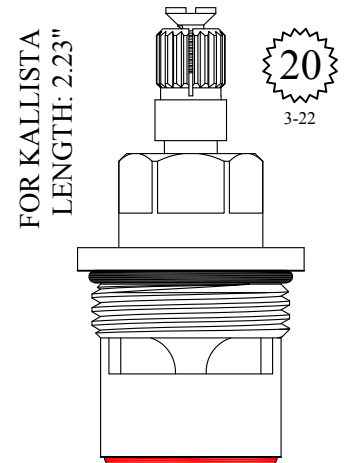

GASKET: 890210 O-RING INCLUDED  
SEAL: 898610-R/B  
DISC SET: 109850-PKG

401091  
401092

FOR STERLING FAUCET  
LENGTH: 2.23"

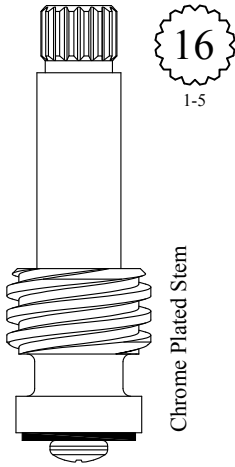

Chrome Plated Stem

LF261051  
LF261052

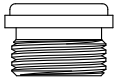

SEAT USED: LF648170

FOR KALLISTA  
LENGTH: 2.23"

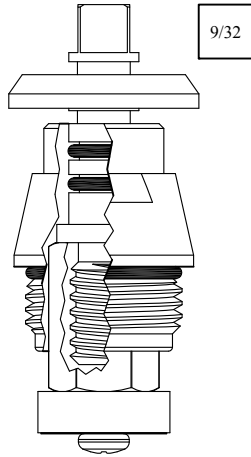

GASKET: 890170 O-RING INCLUDED

LF460652

FOR KALLISTA  
LENGTH: 2.23"

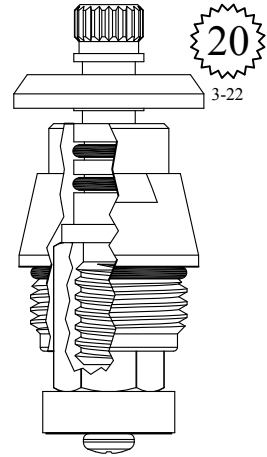

GASKET: 890170 O-RING INCLUDED

LF460672

FOR BRASSCRAFT  
LENGTH: 2.23"

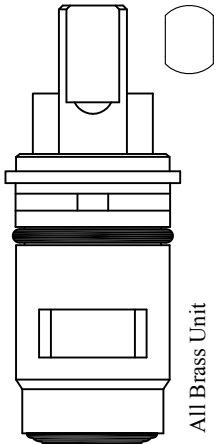

All Brass Unit

SEAL: 898510  
DISC SET: 124290-PKG

LF460721

FOR T & S  
LENGTH: 2.23"

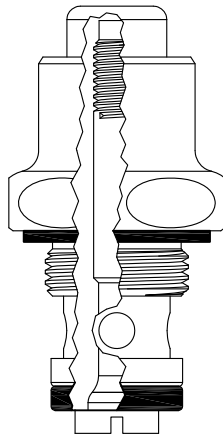

Chrome Plated Unit

GASKET: 895260 INCLUDED

LF462400

UNKNOWN  
LENGTH: 2.24"

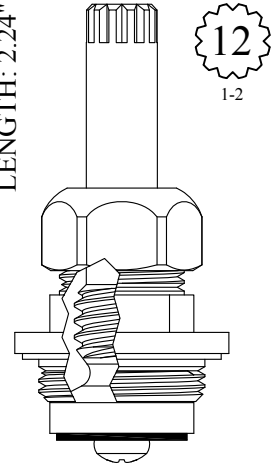

GASKET: 895400

191041

FOR LAWLER  
LENGTH: 2.24"

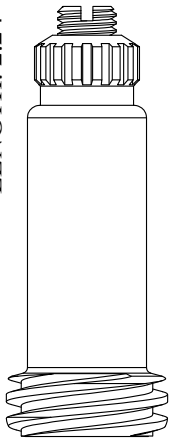

Chrome Plated Stem

201021

FOR STERLING FAUCET  
LENGTH: 2.24"

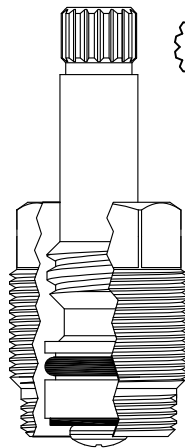

1-5

GASKET: 895160

401111  
401112



SEAT USED: LF648170

FOR SPEAKMAN  
LENGTH: 2.24"

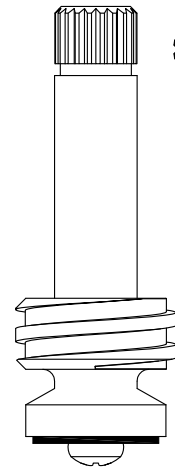

2-4

Chrome Plated Stem

LF263041  
LF263042



SEAT USED: LF648930

UNKNOWN  
LENGTH: 2.24"

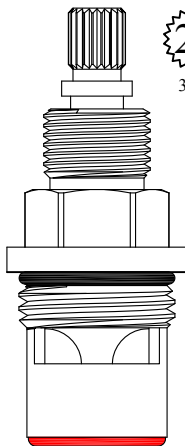

3-20

Chrome Plated Unit

GASKET: 890170 O-RING INCLUDED  
SEAL: 898570-R/B  
DISC SET: 151380-PKG

LF460341  
LF460342

FOR NEWPORT  
LENGTH: 2.24"

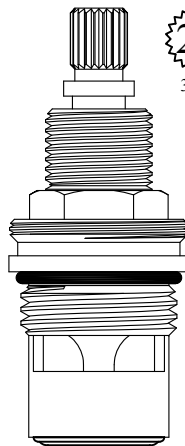

3-20

Chrome Plated Stem

GASKET: 890170 O-RING INCLUDED  
SEAL: 898510-W  
DISC SET: 151380-PKG

LF460361  
LF460362

FOR ARMONIA  
LENGTH: 2.24"

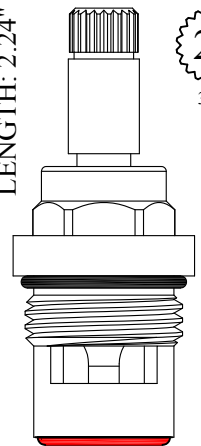

3-14

GASKET: 890170 O-RING INCLUDED  
SEAL: 898570-R/B  
DISC SET: 151380-PKG

LF461861  
LF461862

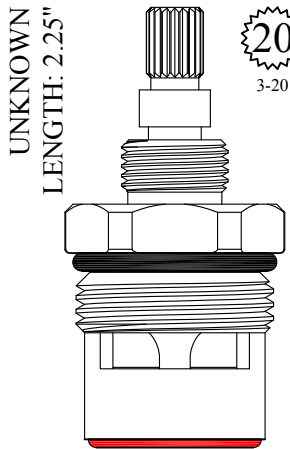

UNKNOWN  
LENGTH: 2.25"

GASKET: 890170 O-RING INCLUDED  
SEAL: 898610-R/B  
DISC SET: 109850-PKG

401441  
401442

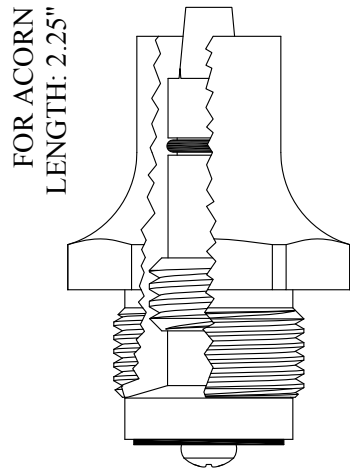

FOR ACORN  
LENGTH: 2.25"

GASKET: 895570

483121

Chrome Plated Bonnet

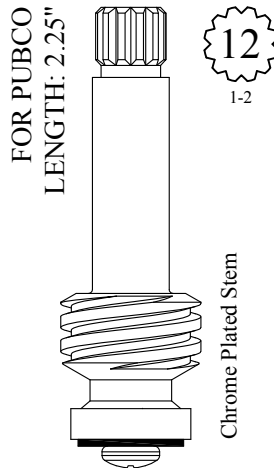

FOR PUBCO  
LENGTH: 2.25"

Chrome Plated Stem

LF262041  
LF262042

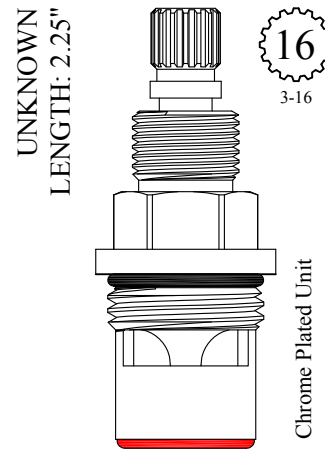

UNKNOWN  
LENGTH: 2.25"

GASKET: 890170 O-RING INCLUDED  
SEAL: 898570-R/B  
DISC SET: 151380-PKG

LF461341  
LF461342

Chrome Plated Unit

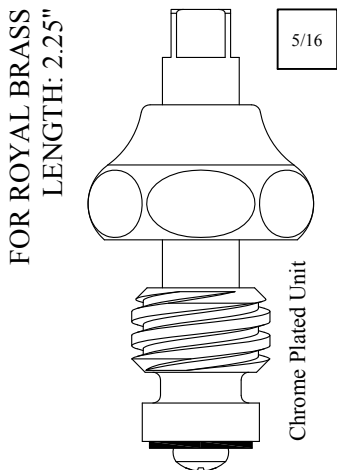

FOR ROYAL BRASS  
LENGTH: 2.25"

Chrome Plated Unit

LF461831  
LF461832  
LF261831 Stem Only  
LF261832 Stem Only



SEAT USED: LF648260

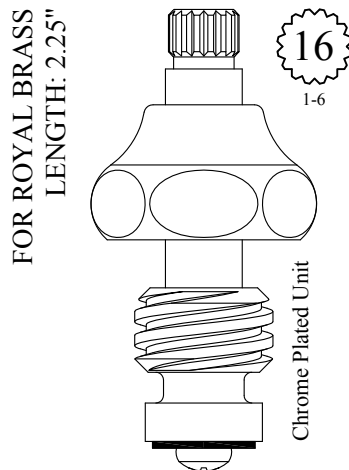

FOR ROYAL BRASS  
LENGTH: 2.25"

Chrome Plated Unit

LF461841  
LF461842  
LF261841 Stem Only  
LF261842 Stem Only

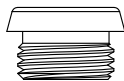

SEAT USED: LF648260

Also available with handle ABRF132601

LF462201-32601  
LF462202-32601

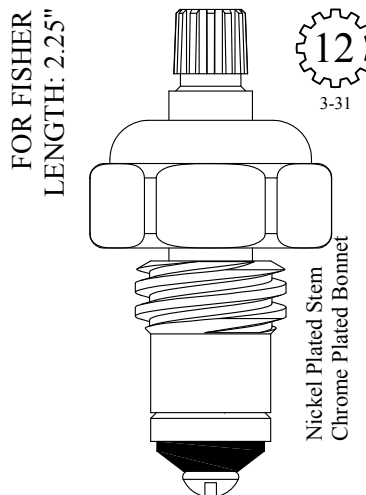

FOR FISHER  
LENGTH: 2.25"

Nickel Plated Stem  
Chrome Plated Bonnet

GASKET: INCLUDED

LF462201  
LF462202  
LF262201 Stem Only  
LF262202 Stem Only



UNKNOWN  
LENGTH: 2.25"

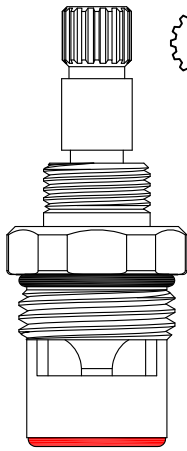

16  
3-16

Chrome Plated Unit

GASKET: 890170 O-RING INCLUDED  
SEAL: 898570-R/B  
DISC SET: 151380-PKG

LF462311  
LF462312

FOR WOLVERINE  
LENGTH: 2.25"

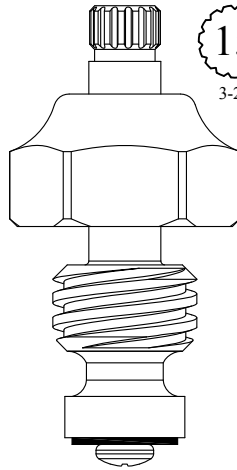

15  
3-27

Chrome Plated Stem  
Nickel Plated Bonnet

LF463081  
LF463082  
LF263081 Stem Only  
LF263082 Stem Only

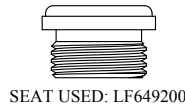

SEAT USED: LF649200

FOR AM STD  
LENGTH: 2.25"

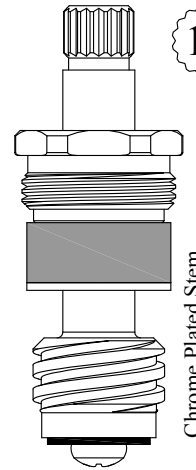

16

Chrome Plated Stem

LF461091  
LF461092  
LF261091 Stem Only  
LF261092 Stem Only



SEAT USED: LF648350

Also available with handle ABRFI32601

LF462211-32601  
LF462212-32601

FOR FISHER  
LENGTH: 2.25"

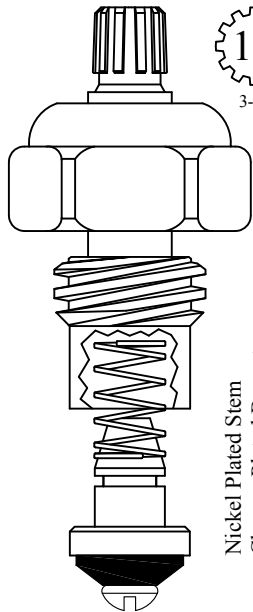

12  
3-31

Nickel Plated Stem  
Chrome Plated Bonnet

LF462211  
LF462212  
LF262211 Stem Only  
LF262212 Stem Only

Also available with handle ABRFI32601

LF462031-32601  
LF462032-32601

FOR FISHER  
LENGTH: 2.26"

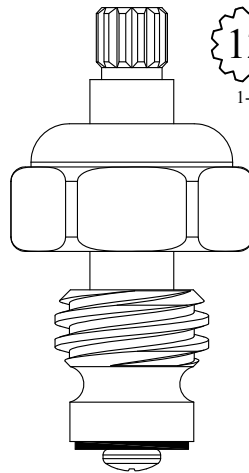

12  
1-2

Nickel Plated Stem  
Chrome Plated Bonnet

LF462031  
LF462032  
LF262031 Stem Only  
LF262032 Stem Only

FOR MIXET  
LENGTH 2.27"

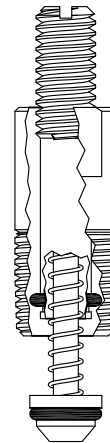

400901

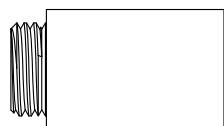

SEAT USED: LF649380

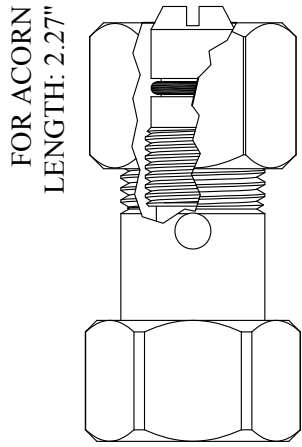

LF138921  
LF136401 Stem Only

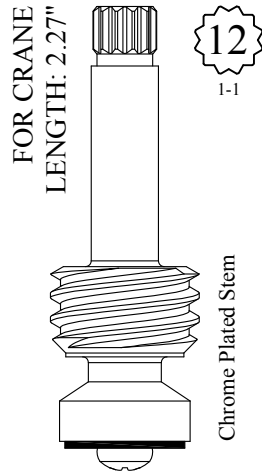

LF261151  
LF261152

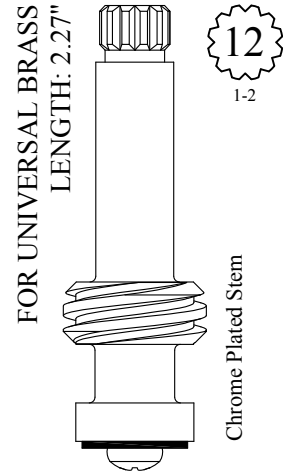

LF263061  
LF263062

Packing Nut pictured for identification purposes only

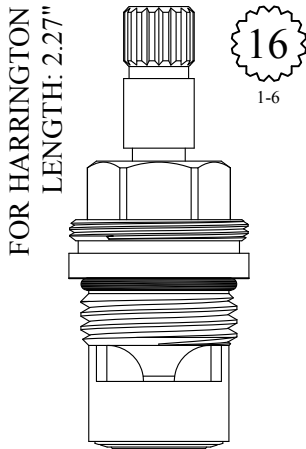

GASKET: 890170 O-RING INCLUDED  
SEAL: 898510-W  
DISC SET: 151380-PKG

LF462541  
LF462542

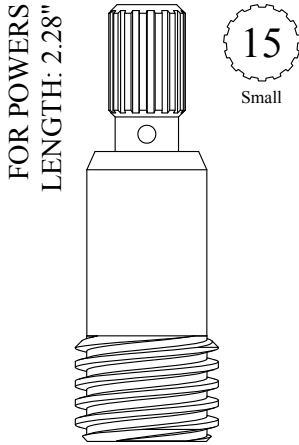

201181

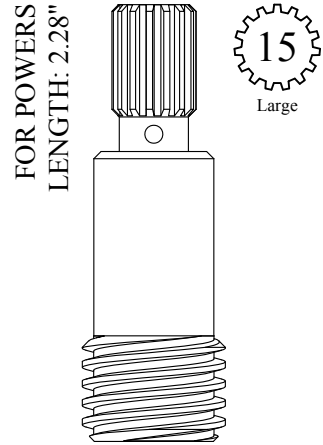

201201

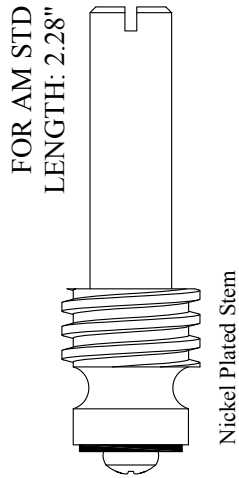

261131

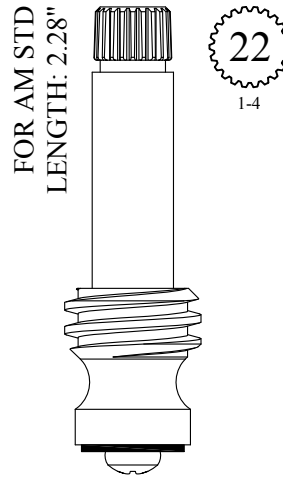

263281

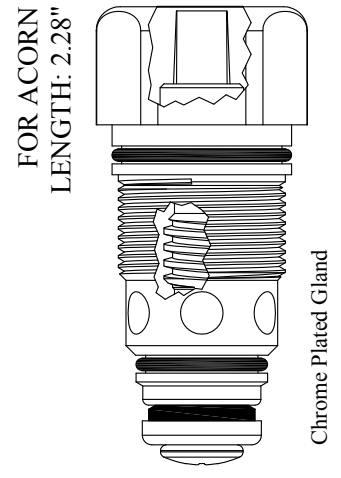

462702

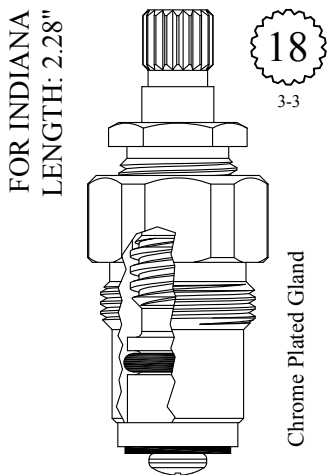

GASKET: 890170 O-RING INCLUDED

LF461951  
LF461952

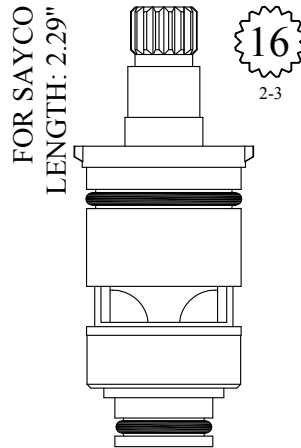

DISC SET: 151380-PKG

LF459611  
LF459612

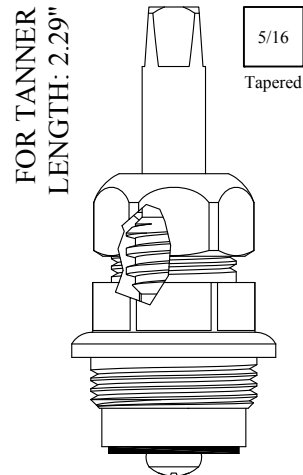

GASKET: 895400

462561

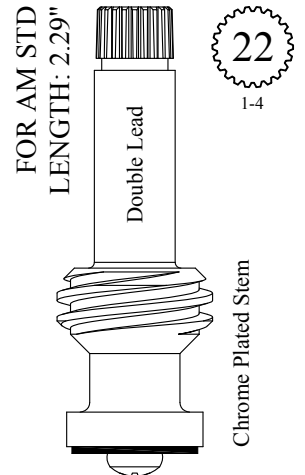

LF263231  
LF263232

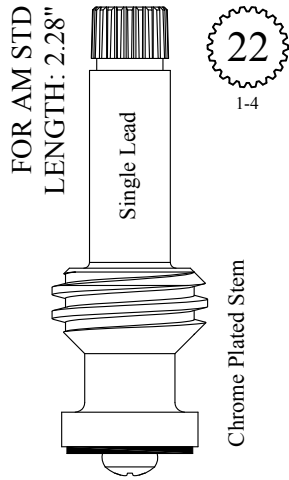

LF263241

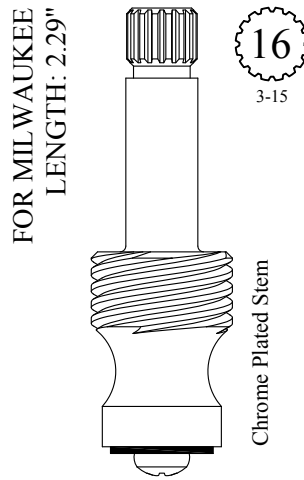

LF264231  
LF264232

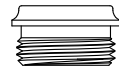

SEAT USED: LF649040

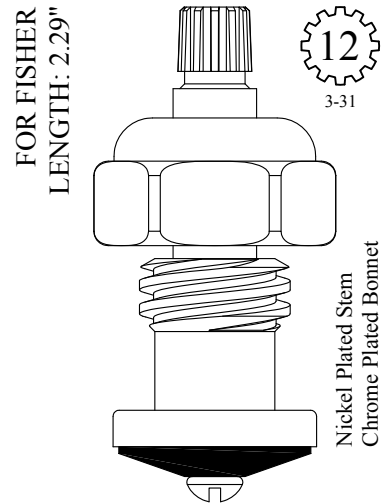

GASKET: INCLUDED

LF462221  
LF462222  
LF262221 Stem Only  
LF262222 Stem Only

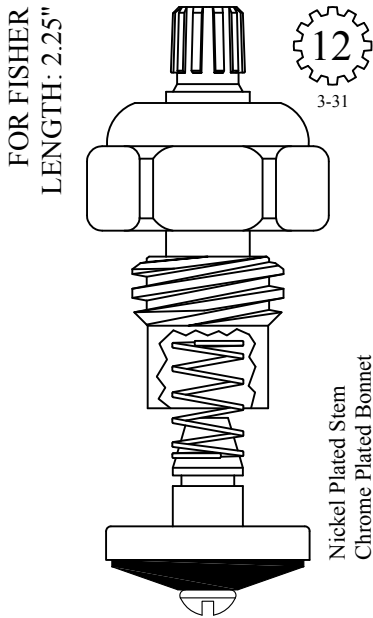

LF462231  
LF462232  
LF262231 Stem Only  
LF262232 Stem Only

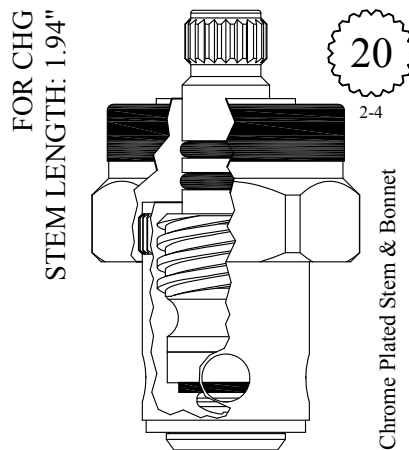

LF462571  
LF462572

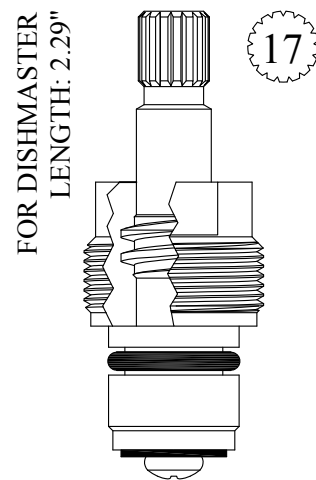

LF463051  
LF463052

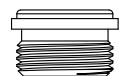

SEAT USED: LF649450

FOR ELJER  
LENGTH: 2.29"

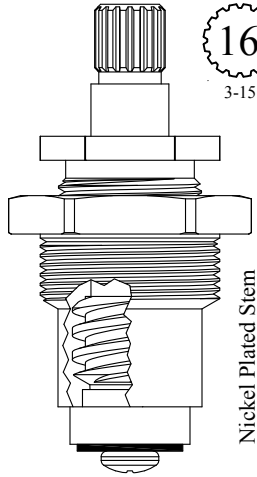

Nickel Plated Stem

GASKET: 895330

LF463071  
LF463072  
LF263071 Stem Only  
LF263072 Stem Only



SEAT USED: LF648160

FOR ELJER  
LENGTH: 2.29"

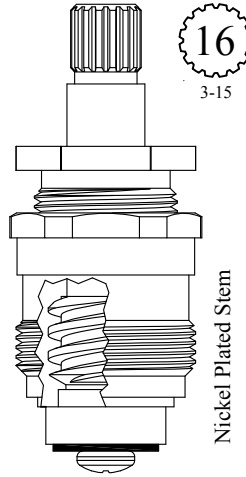

Nickel Plated Stem

GASKET: 895120

LF463171  
LF463172  
LF263071 Stem Only  
LF263072 Stem Only

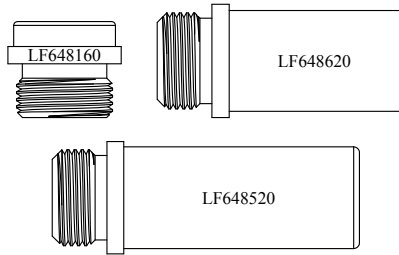

SEATS USED: LF648160, LF648520 & LF648620

FOR ELJER  
LENGTH: 2.30"

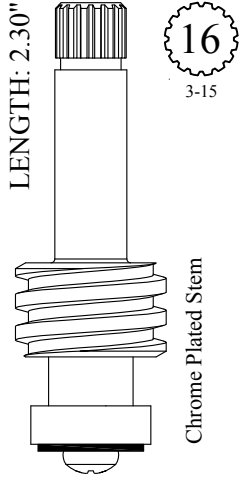

Chrome Plated Stem

LF260201  
LF260202

FOR AM STD  
LENGTH: 2.30"



LF261120

FOR MILWAUKEE  
LENGTH: 2.29"

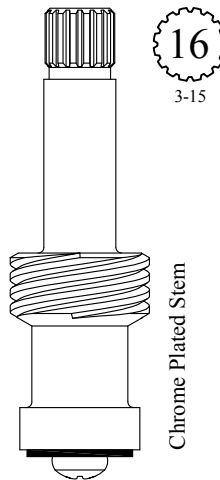

Chrome Plated Stem

LF263181  
LF263182

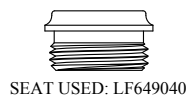

SEAT USED: LF649040

FOR CENTRAL  
LENGTH: 2.30"

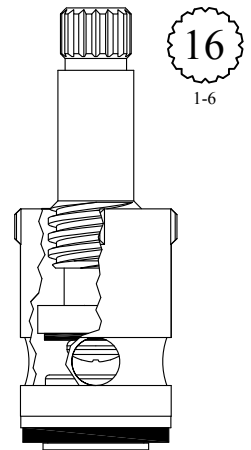

SEAT INCLUDED:  
LF647850

LF462051  
LF462052

FOR CENTRAL  
LENGTH: 2.30"

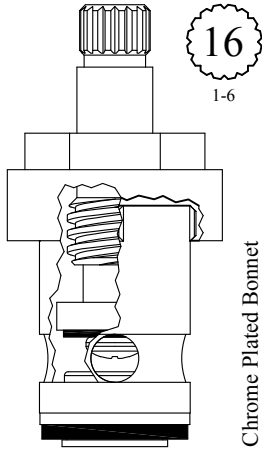

SEAT INCLUDED:  
LF647850

LF462151  
LF462152

UNKNOWN  
LENGTH: 2.30"

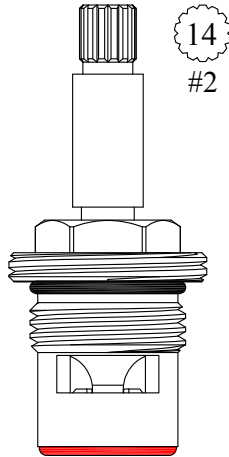

GASKET: 890170 O-RING INCLUDED  
SEAL: 898570-R/B  
DISC SET: 151380-PKG

LF462431  
LF462432

FOR ALTMANS  
LENGTH: 2.30"

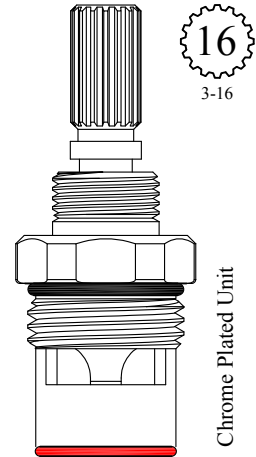

GASKET: 890170 O-RING INCLUDED  
SEAL: 898580-R/B  
DISC SET: 151380-PKG

LF462411  
LF462412

UNKNOWN  
LENGTH: 2.30"

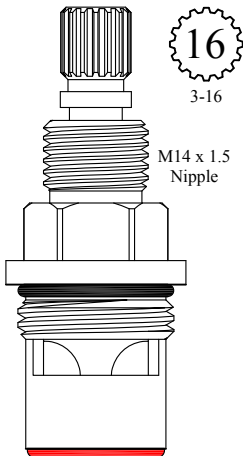

GASKET: 890170 O-RING INCLUDED  
SEAL: 898570-R/B  
DISC SET: 151380-PKG

LF462641  
LF462642

FOR PEGASUS  
LENGTH: 2.30"

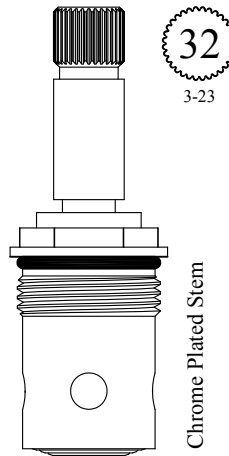

GASKET: 890160 O-RING INCLUDED  
SEAL: 898500  
DISC SET: 112530-PKG

LF462901  
LF462902

FOR TANNER  
LENGTH: 2.31"

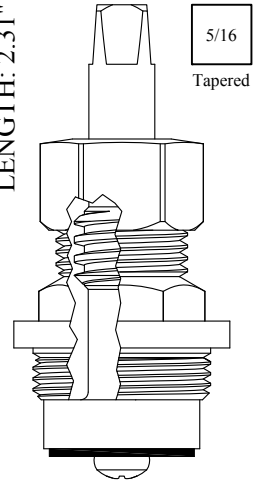

GASKET: 895370

468031

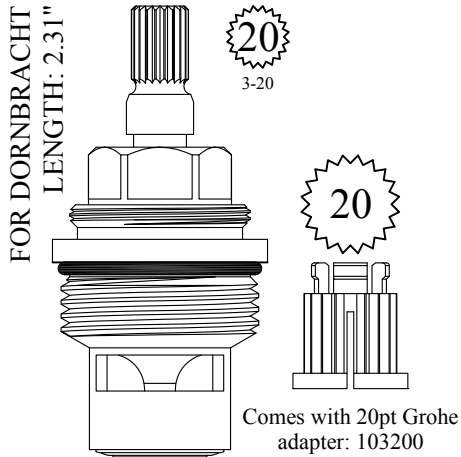

GASKET: 890210 O-RING INCLUDED  
 SEAL: 898510-W  
 DISC SET: 151380-PKG

401171  
 401172

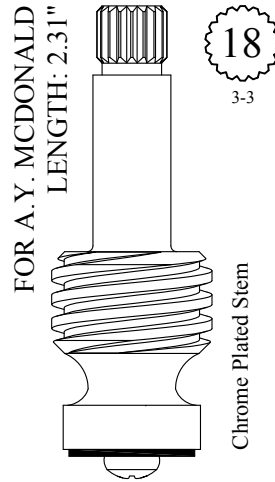

LF262341  
 LF262342

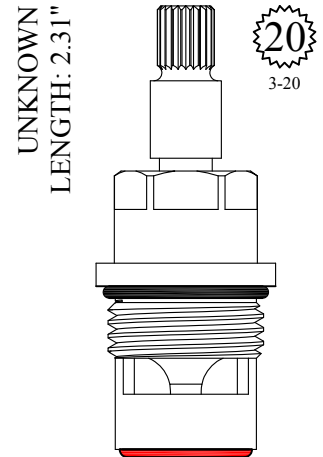

GASKET: 890170 O-RING INCLUDED  
 SEAL: 898570-R/B  
 DISC SET: 151380-PKG

LF461401  
 LF461402

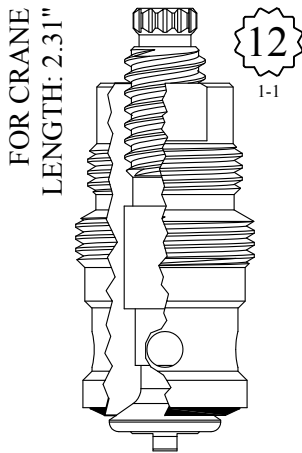

GASKET: 895250

LF462011  
 LF462012  
 LF262011 Stem Only  
 LF262012 Stem Only

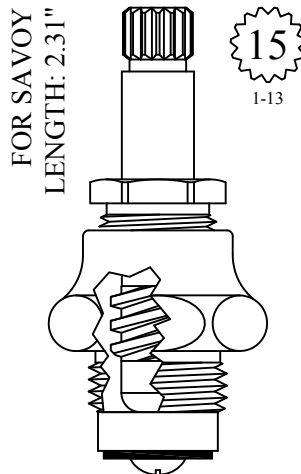

GASKET: 895100

LF462121

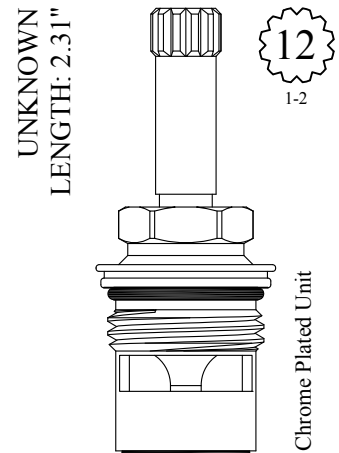

GASKET: 890170 O-RING INCLUDED  
 SEAL: 898510  
 DISC SET: 151380-PKG

LF462551  
 LF462552

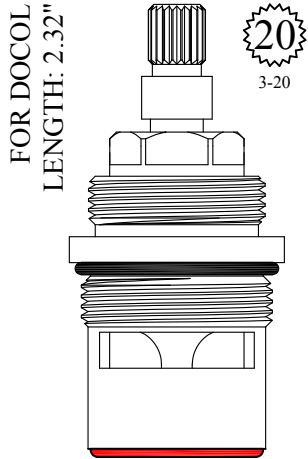

GASKET: 890210 O-RING INCLUDED  
SEAL: 898610  
DISC SET: 109850-PKG

401041  
401042

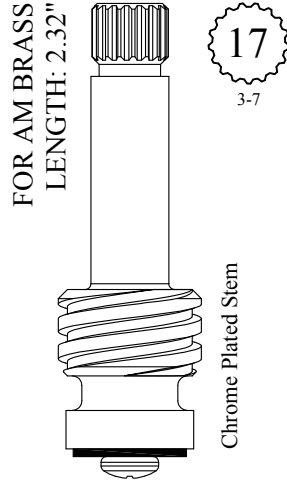

LF262021  
LF262022

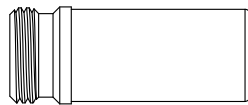

SEAT USED: LF649240

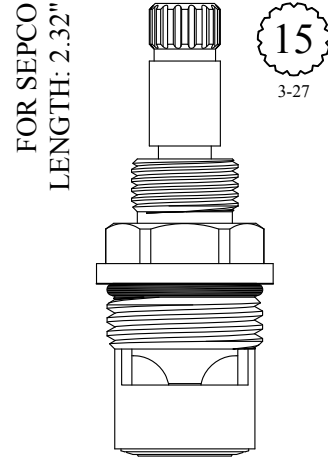

GASKET: 890170 O-RING INCLUDED  
SEAL: 898510-W  
DISC SET: 151380-PKG

LF459721  
LF459722

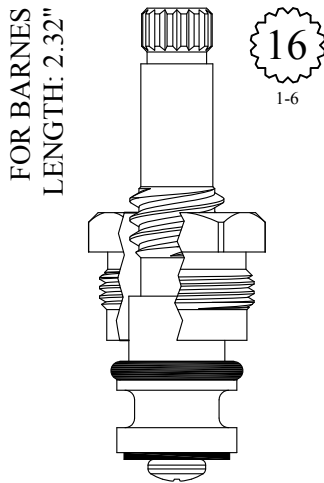

LF462061



SEAT USED: LF648350

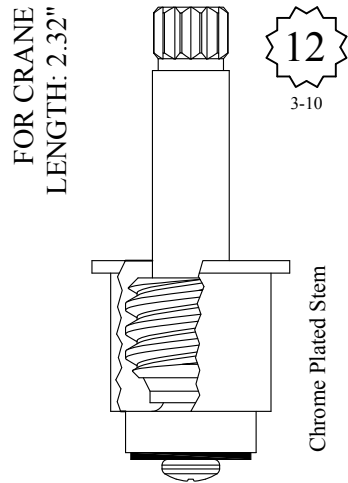

LF462131  
LF262131 Stem Only

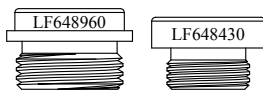

SEAT USED: LF648960 or LF648430

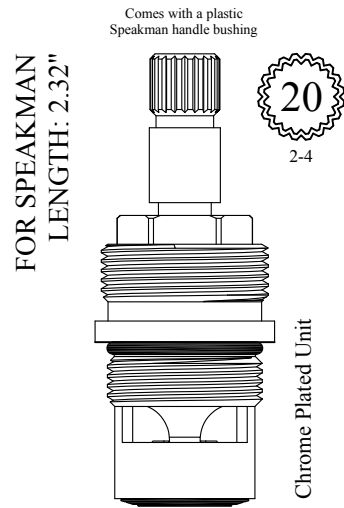

GASKET: 890170 O-RING INCLUDED  
SEAL: 898510  
DISC SET: 151380-PKG

LF462501  
LF462502



FOR SPEAKMAN  
LENGTH: 2.32"

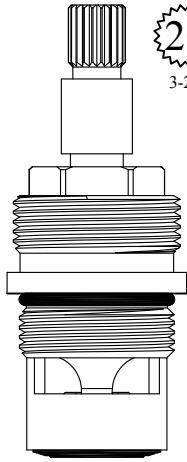

20  
3-20

Chrome Plated Unit

GASKET: 890170 O-RING INCLUDED  
SEAL: 898510  
DISC SET: 151380-PKG

LF462511  
LF462512

UNKNOWN  
LENGTH: 2.33"

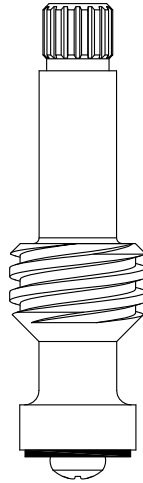

16  
3-15

Chrome Plated Stem

201191  
201192

FOR ADVANCED TABCO  
LENGTH: 2.34"

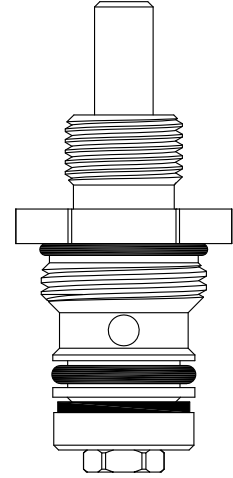

Chrome Plated Unit

GASKET: 890180 O-RING INCLUDED

LF464450  
LF264450 Stem Only

FOR DISHMASTER  
LENGTH: 2.34"

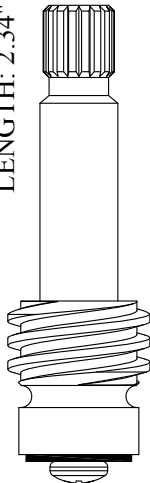

17

Chrome Plated Stem

LF263191  
LF263192

FOR HARCRAFT  
LENGTH: 2.34"

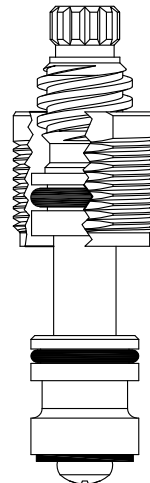

12  
1-2

16  
1-6

Nickel Plated Gland

GASKET: 895040 INCLUDED

LF462091

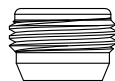

SEAT USED: LF648670

FOR KOHLER  
LENGTH: 2.34"

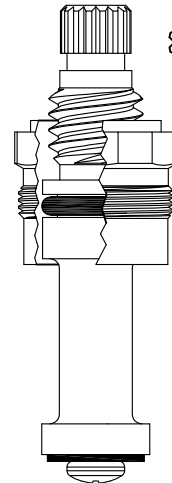

16  
1-6

Nickel Plated Gland

GASKET: 895060

LF462101  
LF462102

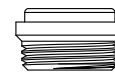

SEAT USED: LF648070

FOR KOHLER  
LENGTH: 2.34"

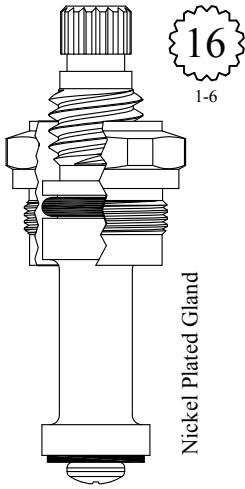

16  
1-6

Nickel Plated Gland

GASKET: 895060

LF462141  
LF462142



SEAT USED: LF648070

FOR DORNBRACHT  
LENGTH: 2.34"

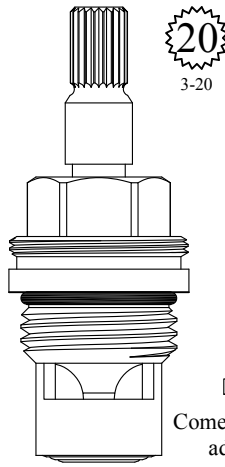

20  
3-20

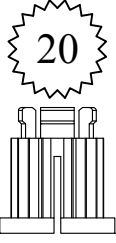

Comes with 20pt Grohe  
adapter: 103200

GASKET: 890170 O-RING INCLUDED  
SEAL: 898500  
DISC SET: 112530-PKG

LF462601  
LF462602

FOR TWYFORD BATHROOM  
LENGTH: 2.35"

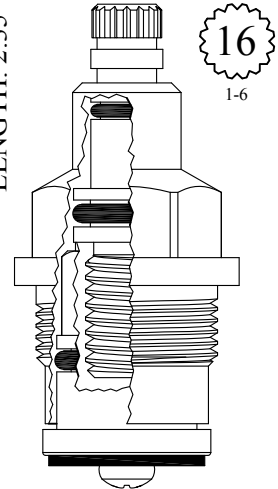

16  
1-6

GASKET: 895370

401372

Supplied with  
12pt. Broach

FOR CALIFORNIA BRASS  
LENGTH: 2.33"

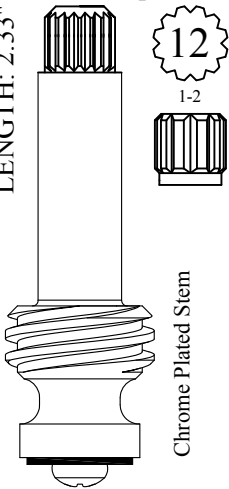

12  
1-2

Chrome Plated Stem

LF263141  
LF263142

UNKNOWN  
LENGTH: 2.35"

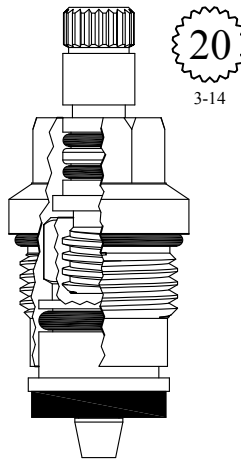

20  
3-14

GASKET: 890180 O-RING INCLUDED

LF459482

FOR CRANE  
LENGTH: 2.35"

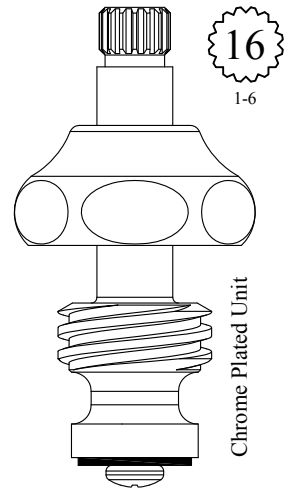

16  
1-6

Chrome Plated Unit

LF461931  
LF261931 Stem Only

FOR BURLINGTON  
LENGTH: 2.35"

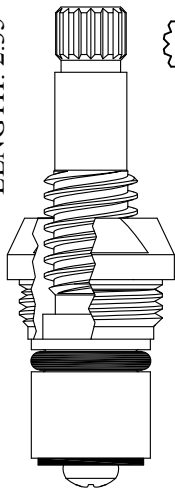

16  
1-6

Nickel Plated Gland

LF462111  
LF462112



SEAT USED: LF648700

FOR AM STD  
STEM LENGTH: 2.36"

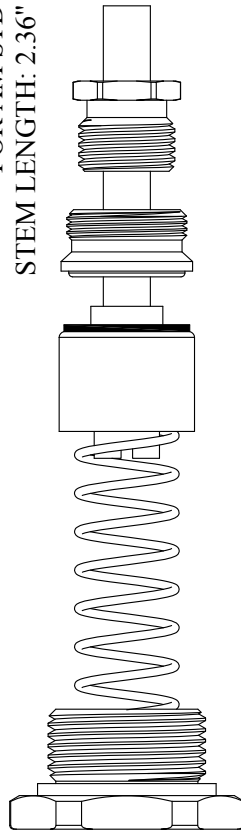

SEAT INCLUDED: LF649870

LF152150 Stem Only  
LF124660 Repair Kit

FOR BARDES  
LENGTH: 2.36"

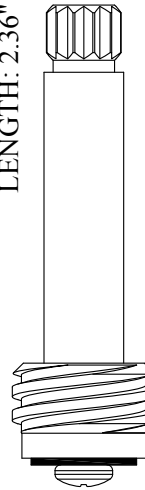

12  
3-10

LF264241  
LF264242

FOR PIEL  
LENGTH 2.36"

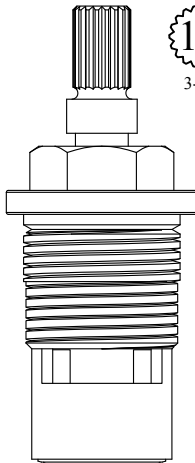

18  
3-30

GASKET: 895150 INCLUDED  
SEAL: 898510-W  
DISC SET: 151380-PKG

LF462661  
LF462662

FOR DELTA (CER-TECK)  
FOR CAMBRIDGE  
LENGTH: 2.36"

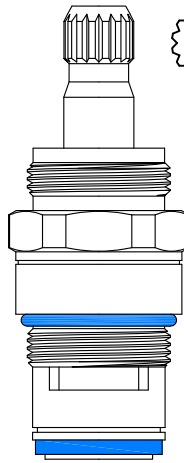

16  
1-6

Chrome Plated Unit

LF462711  
LF462712

FOR PERLICK  
LENGTH: 2.36"

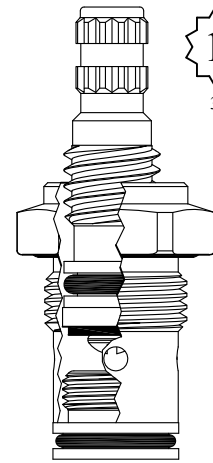

12  
3-10

GASKET: 890180 O-RING INCLUDED

LF463351  
LF463352

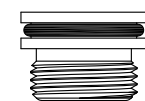

SEAT USED: LF663350

FOR SEARS  
LENGTH: 2.37"

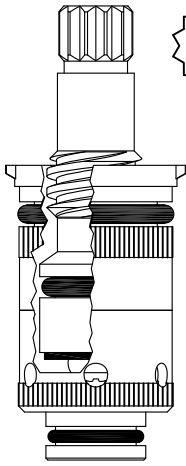

12  
3-10

LF461081  
LF461082

Also available less seat  
LF461081-LS/ LF461082-LS

FOR SEARS  
LENGTH: 2.37"

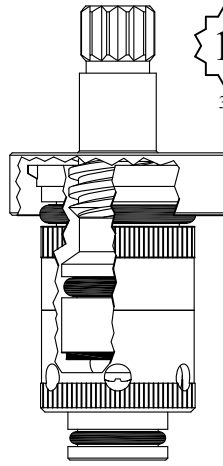

12  
3-10

LF461181  
LF461182

FOR SPRINGHOUSE  
LENGTH: 2.37"

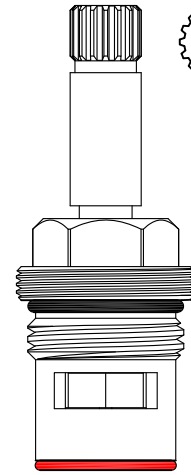

16  
3-16

GASKET: 890170 O-RING INCLUDED  
SEAL: 898580-R  
DISC SET: 115520-PKG

LF462681  
LF462682

FOR BRIGGS  
LENGTH: 2.37"

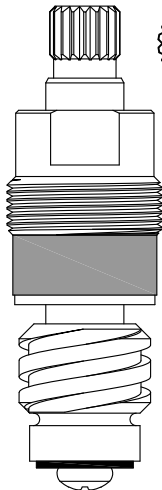

18  
3-3

LF463111  
LF463112

FOR ACORN  
LENGTH: 2.37"

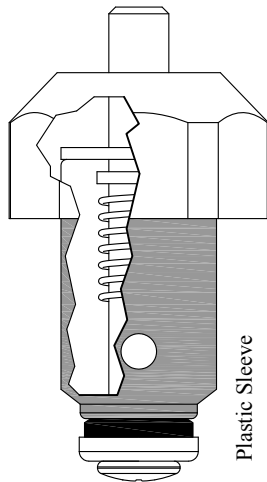

Plastic Sleeve

LF463270

Also available less bonnet  
LF463260

FOR PIAZZA  
LENGTH: 2.37"

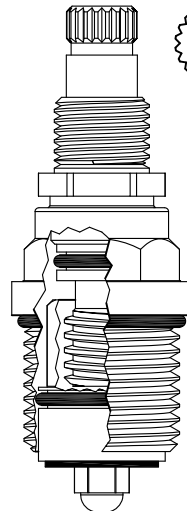

20  
3-14

LF463702

GASKET: 890180 O-RING INCLUDED

UNKNOWN  
LENGTH: 2.38"

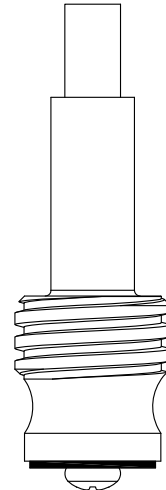

19/64

Chrome Plated Stem

201331

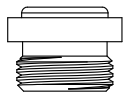

SEAT USED: LF648120

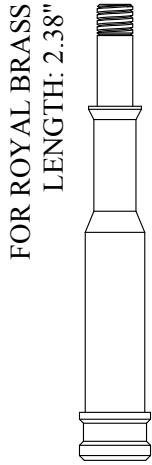

LF115960

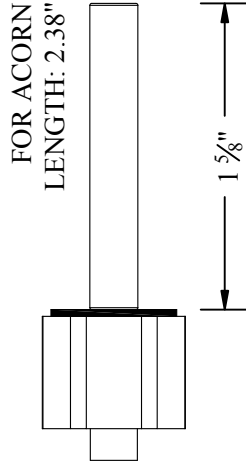

LF158310



SEAT USED: LF647560

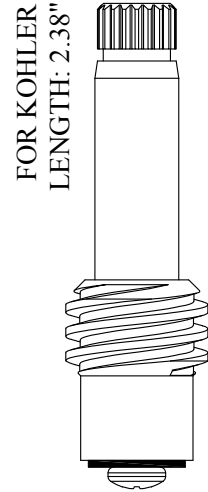

19  
1-7

LF263151  
LF263152

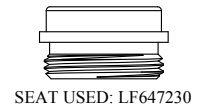

SEAT USED: LF647230

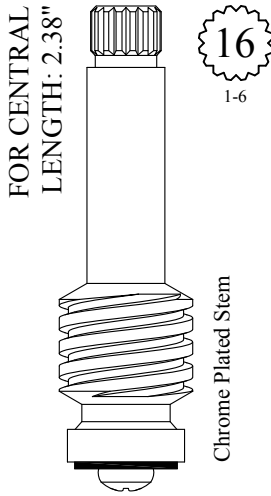

16  
1-6

LF263311  
LF263312



SEAT USED: LF648550

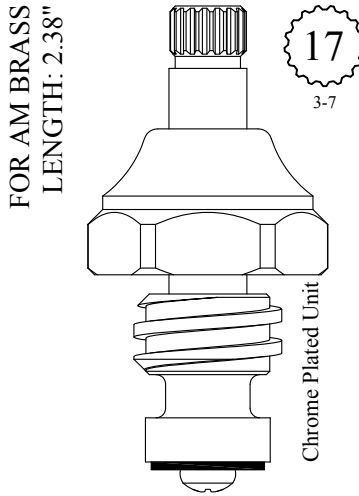

17  
3-7

LF464211  
LF464212  
LF264211 Stem Only  
LF264212 Stem Only

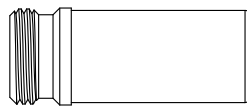

SEAT USED: LF649240

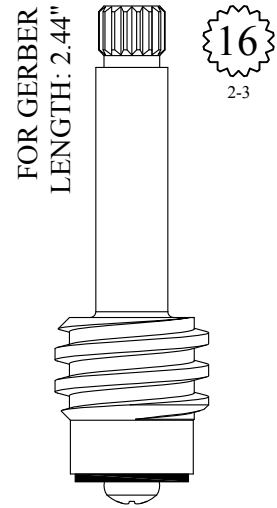

16  
2-3

LF263121  
LF263122



SEAT USED: LF649150

FOR UNION BRASS  
LENGTH: 2.39"

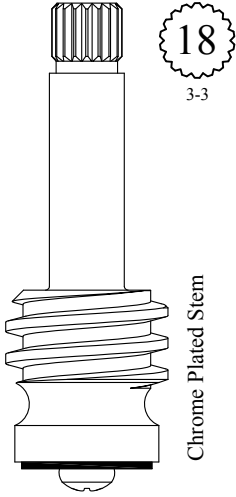

LF264191  
LF264192

UNKNOWN  
LENGTH: 2.39"

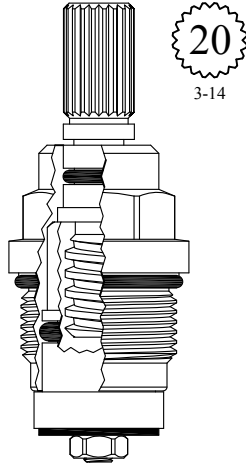

GASKET: 890180 O-RING INCLUDED

LF460272

FOR SAVOY  
LENGTH: 2.39"

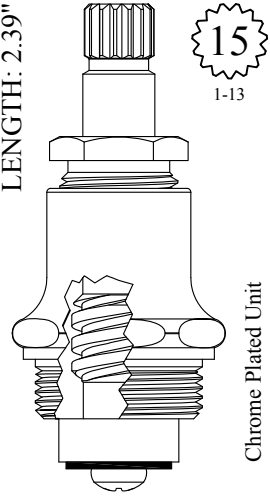

GASKET: 895400

LF462081  
LF462082

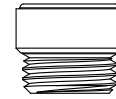

SEAT USED: LF649740

FOR CRANE  
LENGTH: 2.39"

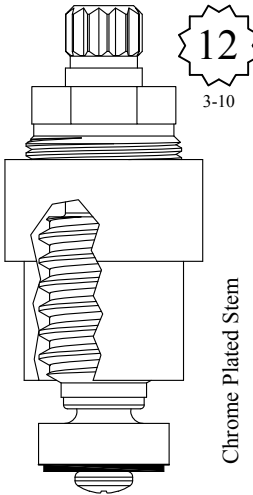

LF462611  
LF462612



SEAT USED: LF649920

FOR DICK BROS.  
LENGTH: 2.39"

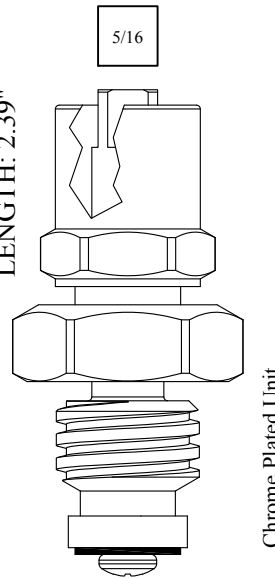

LF463091  
LF263091 Stem Only

FOR MUELLER  
LENGTH: 2.40"

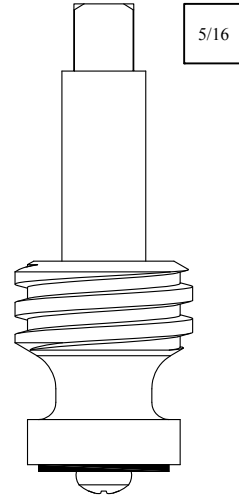

263341

FOR SHERLE WAGNER  
LENGTH: 2.40"

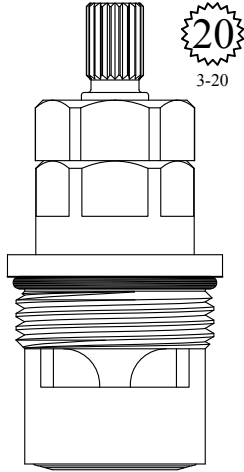

GASKET: 890210 O-RING INCLUDED  
SEAL: 898520  
DISC SET: 109850-PKG

401381  
401382

FOR CENTRAL  
LENGTH: 2.40"

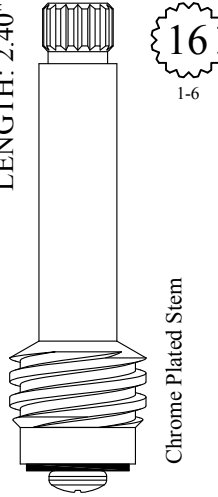

LF263211  
LF263211

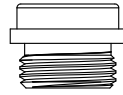

SEAT USED: LF648550

FOR STERLING BRASS  
LENGTH: 2.40"

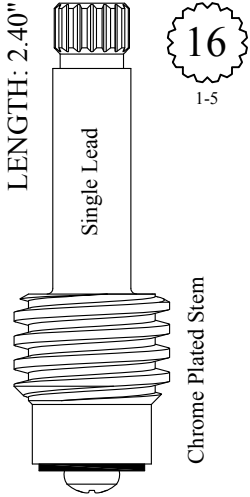

LF263511

FOR STERLING BRASS  
LENGTH: 2.40"

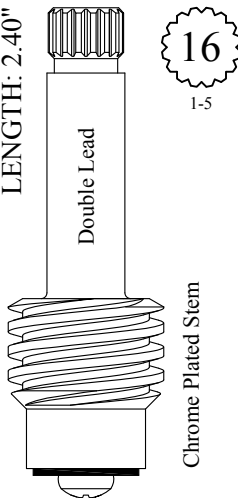

LF263521  
LF263522

FOR CRANE  
LENGTH: 2.40"

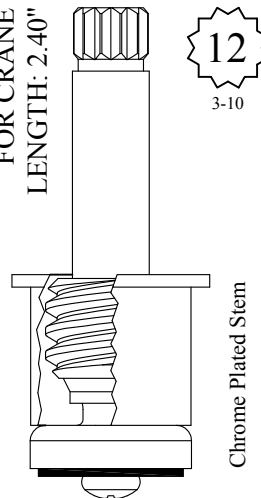

LF462071  
LF462072

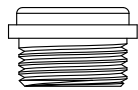

SEAT USED: LF648340

FOR ROYAL BRASS  
LENGTH: 2.40"

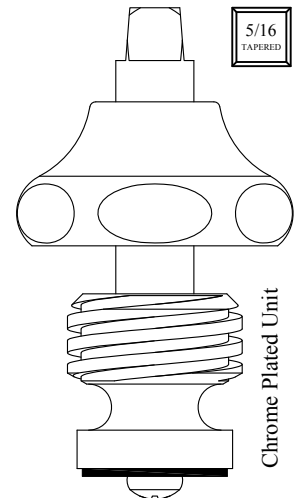

LF463221  
LF463222  
LF263221 Stem Only  
LF263222 Stem Only

Comes with handle screw:  
# 899230

FOR ROYAL BRASS  
LENGTH: 2.40"

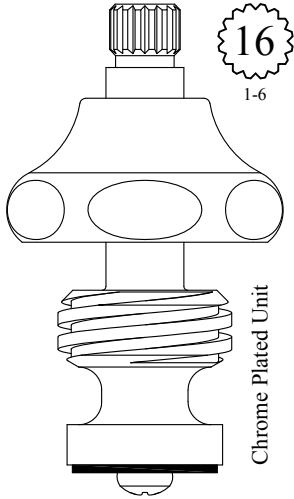

Chrome Plated Unit

LF463251  
LF463252  
LF263251 Stem Only  
LF263252 Stem Only

FOR KALLISTA  
LENGTH: 2.40"

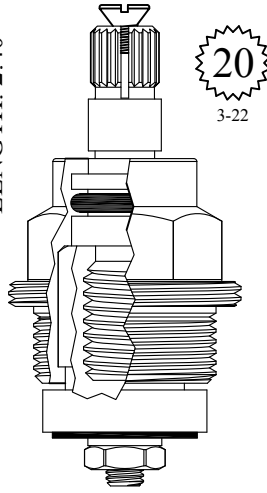

GASKET: 895350

LF463602

FOR HELVEX  
LENGTH: 2.40"

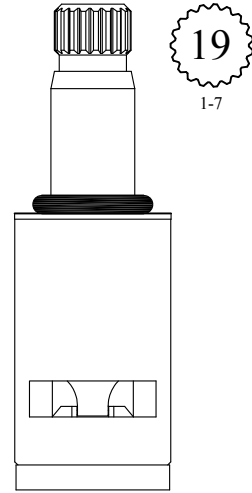

DISC SET: 151380-PKG

LF463801  
LF463802

FOR BRIGGS  
LENGTH: 2.41"

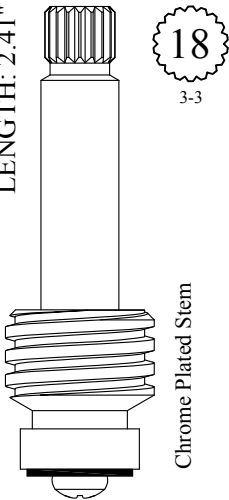

Chrome Plated Stem

201231

UNKNOWN  
LENGTH: 2.41"

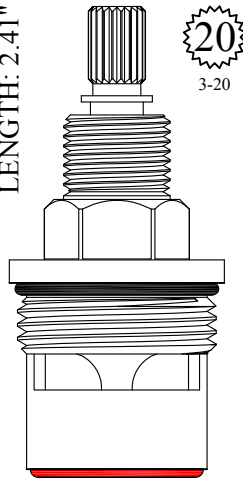

GASKET: 890210 INCLUDED  
SEAL: 898610-R/B  
DISC SET: 109850-PKG

400961  
400962

UNKNOWN  
LENGTH: 2.41"

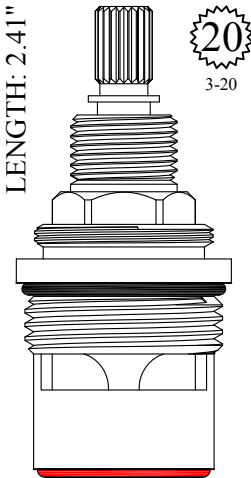

GASKET: 890210 INCLUDED  
SEAL: 898610-R/B  
DISC SET: 109850-PKG

400991  
400992



FOR SHERLE WAGNER  
LENGTH: 2.41"

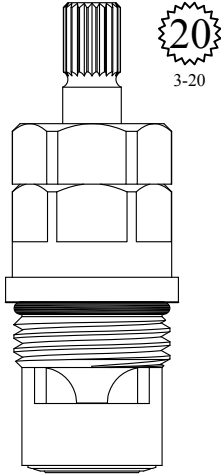

GASKET: 890170 O-RING INCLUDED  
SEAL: 898510-W  
DISC SET: 151380-PKG

LF462521  
LF462522

FOR INDIANA  
LENGTH: 2.41"

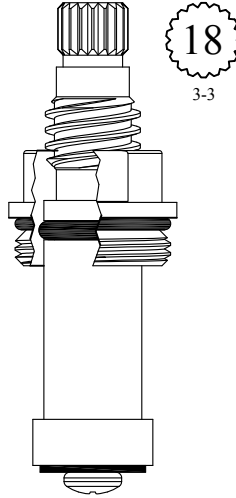

GASKET: 890170 O-RING INCLUDED

LF464131  
LF464132

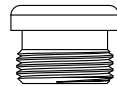

SEAT USED: LF648560

FOR AM STD  
LENGTH: 2.42"

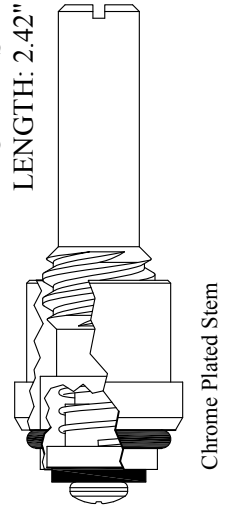

464221  
264221 Stem Only

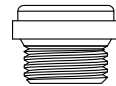

SEAT USED: LF648990

FOR CENTRAL  
LENGTH: 2.42"

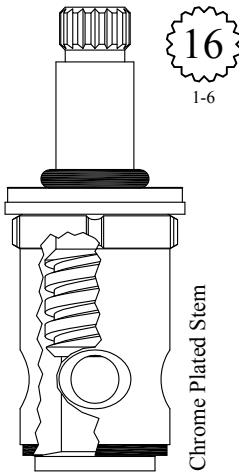

LF463201  
LF463202

FOR CENTRAL  
LENGTH: 2.42"

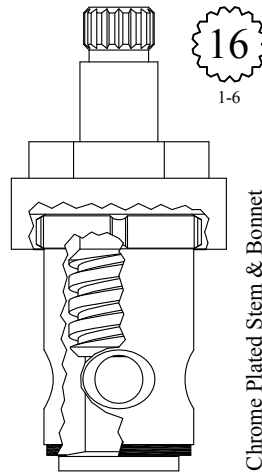

LF463211  
LF463212

FOR AM STD  
LENGTH: 2.42"

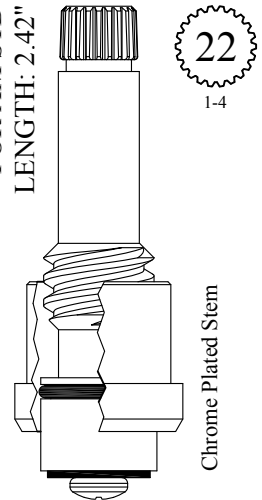

GASKET: 891130

LF464011  
LF464012  
LF264011 Stem Only  
LF264012 Stem Only

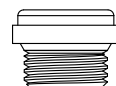

SEAT USED: LF648990

FOR SHERLE WAGNER  
LENGTH: 2.43"

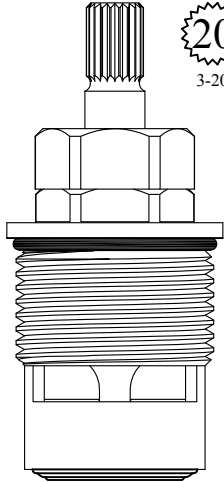

GASKET: 890210 O-RING INCLUDED  
SEAL: 898520  
DISC SET: 109850-PKG

401581  
401582

FOR AM STD  
LENGTH: 2.43"

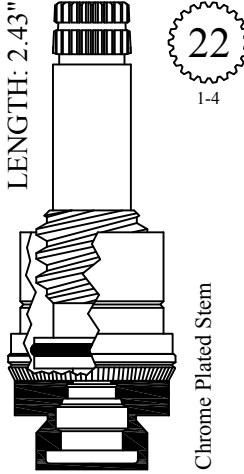

Chrome Plated Stem

LF463131  
LF463132

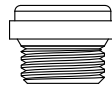

SEAT USED: LF648990

IMPORT  
LENGTH: 2.43"

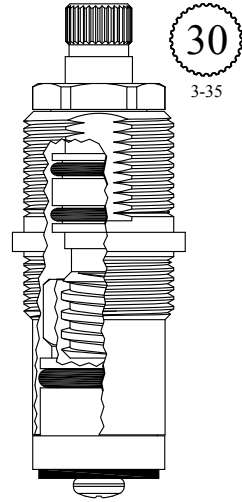

LF463302

UNKNOWN  
LENGTH: 2.44"

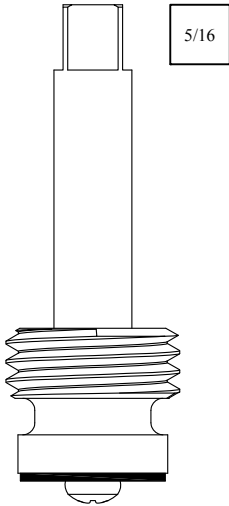

152981

FOR HARCRAFT  
LENGTH: 2.44"

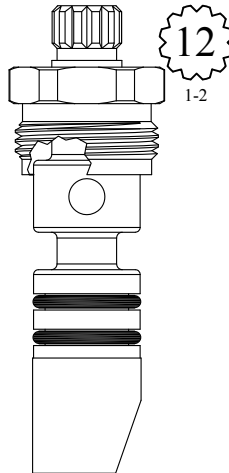

430040  
230040 Stem Only

FOR ACORN  
LENGTH: 2.44"

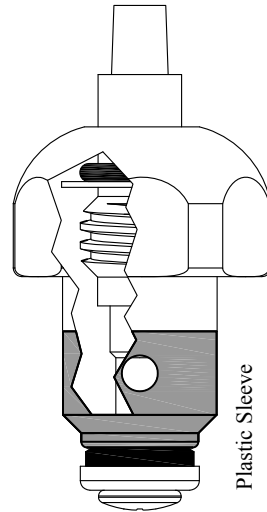

464552

Also available less bonnet

464542

Also available as a RH/LH Kit  
**LF463321-2**  
 Kit includes: (1) 263321, (1) 263322, (1) 604520  
 Available: Stem Only  
**LF263321 / LF263322**

FOR SEPCO  
 LENGTH: 2.44"

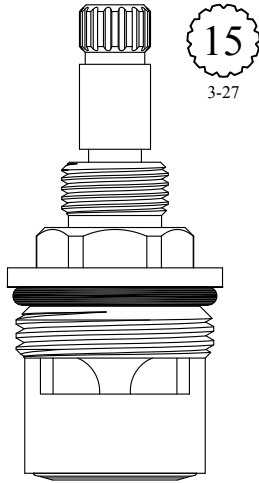

GASKET: 891180 O-RING INCLUDED  
 SEAL: 898520  
 DISC SET: 109850-PKG

**401251**  
**401252**

FOR BRADLEY  
 LENGTH: 2.44"

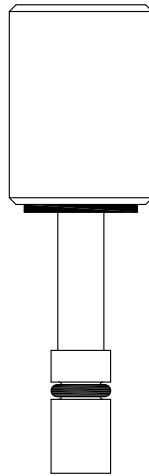

**LF173770**

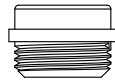

SEAT USED: LF647560

FOR WOLVERINE  
 LENGTH: 2.44"

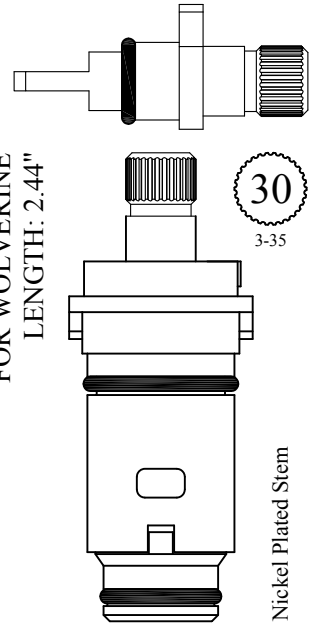

**LF463321**  
**LF463322**

FOR WOLVERINE  
 LENGTH: 2.44"

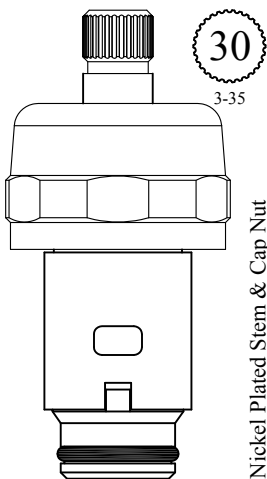

**LF463321-N**  
**LF463322-N**

UNKNOWN  
 LENGTH: 2.44"

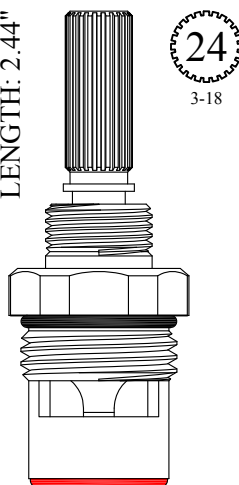

GASKET: 890170 O-RING INCLUDED  
 SEAL: 898570-R/B  
 DISC SET: 151380-PKG

**LF463661**  
**LF463662**

FOR PRICE PFISTER  
 LENGTH: 2.45"

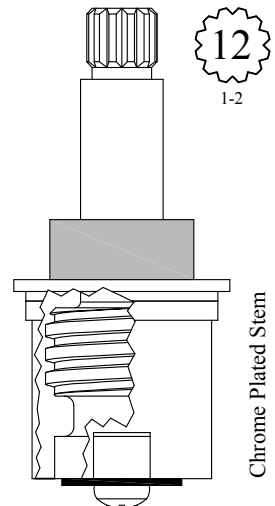

**401321**  
**201351** Stem Only

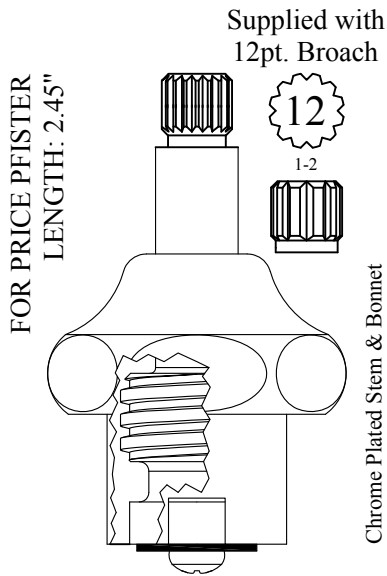

401351  
201351 Stem Only

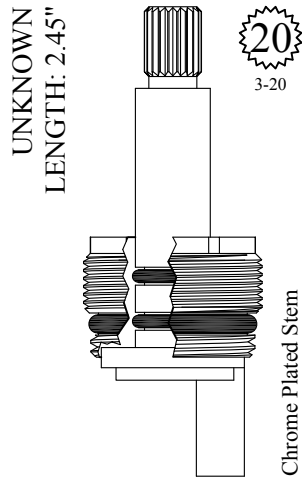

GASKET: 891150 O-RING INCLUDED

431100

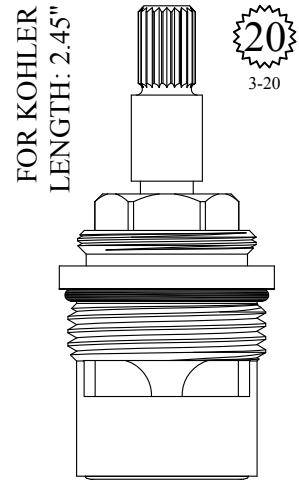

GASKET: 890210 O-RING INCLUDED  
SEAL: 898520  
DISC SET: 109850-PKG

401291  
401292

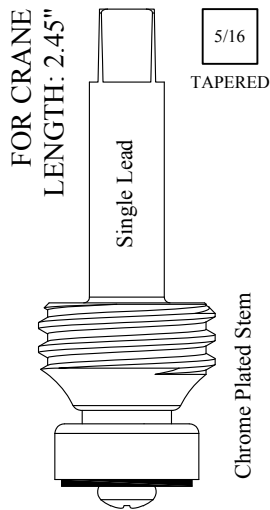

LF263401

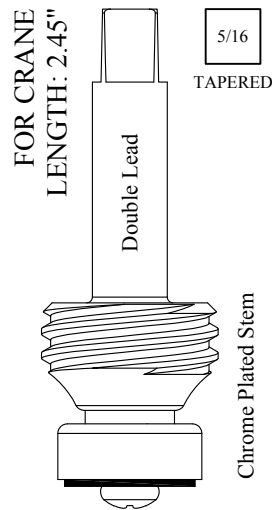
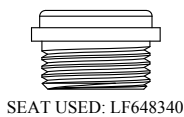

LF263411  
LF263412

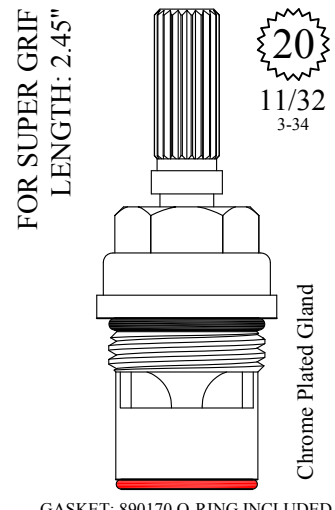
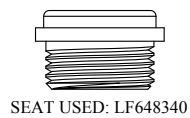

GASKET: 890170 O-RING INCLUDED  
SEAL: 898580-R/B  
DISC SET: 151380-PKG

LF463641  
LF463642

FOR SPEAKMAN  
LENGTH: 2.45"

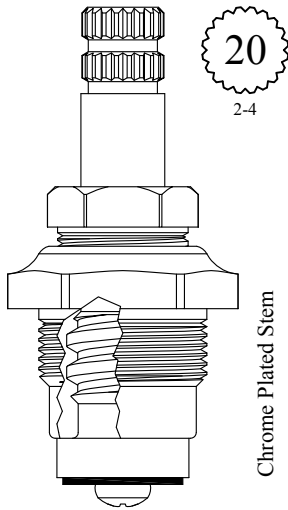

GASKET: 895400

LF463731  
LF263731 Stem Only

FOR BRADLEY  
LENGTH: 2.46"

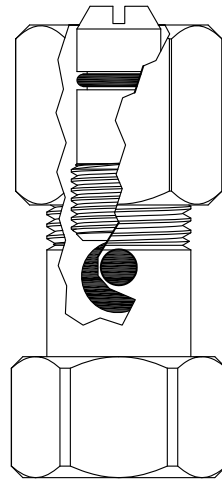

LF126480

FOR AM BRASS  
LENGTH: 2.46"

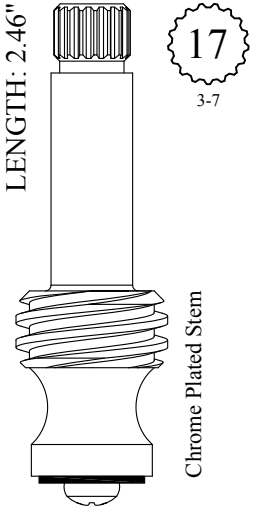

LF264271  
LF264272

Also available as a RH/LH Kit

LF463361-2

Kit includes: (1) 263361, (1) 263362, (1) 604520

Available: Stem Only

LF263361 / LF263362

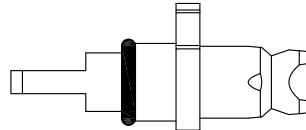

FOR SUPER GRIF  
LENGTH 2.46"

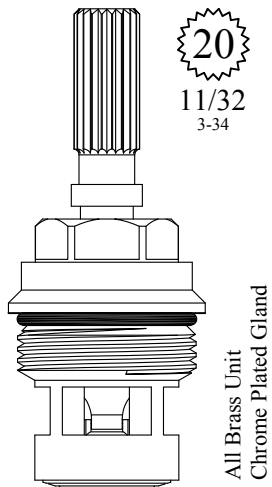

GASKET: 890190 O-RING INCLUDED  
SEAL: 898510-W  
DISC SET: 151380-PKG

LF463621  
LF463622

FOR WOLVERINE  
LENGTH: 2.47"

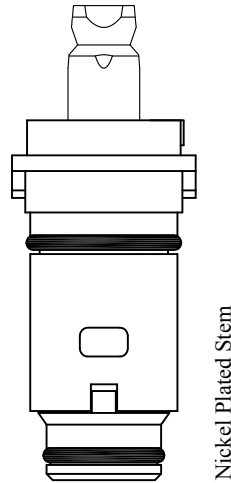

LF463361  
LF463362

FOR SPEAKMAN  
LENGTH: 2.48"

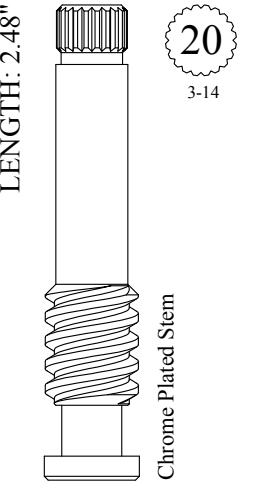

201301



SEAT USED: 648190

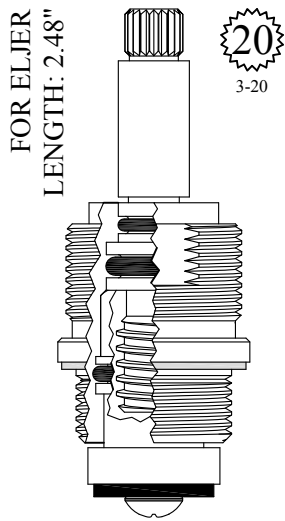

20  
3-20

GASKET: 895160 INCLUDED

401342

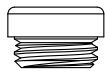

SEAT USED: LF647690

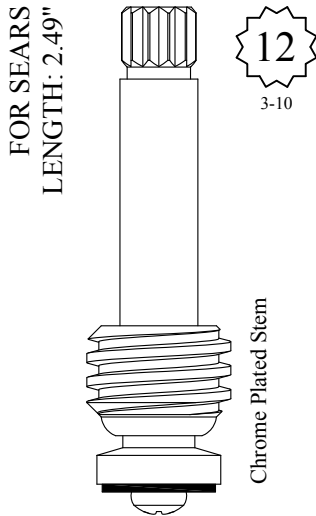

12  
3-10

Chrome Plated Stem

201431



SEAT USED: LF648700

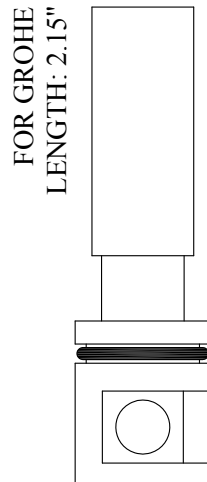

230650

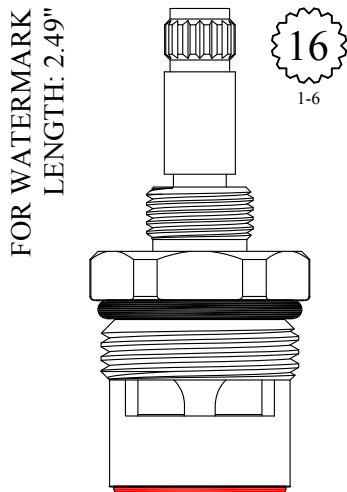

16  
1-6

GASKET: 890170 O-RING INCLUDED  
SEAL: 898610-R/B  
DISC SET: 109850-PKG

401261  
401262

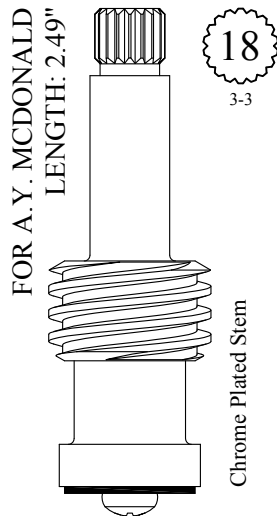

18  
3-3

Chrome Plated Stem

LF264281  
LF264282

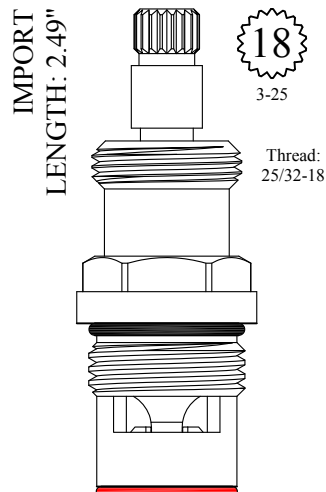

18  
3-25

Thread:  
25/32-18

GASKET: 890170 O-RING INCLUDED  
SEAL: 898580-R/B  
DISC SET: 151380-PKG

LF401361  
LF401362

Individual items available  
 Stem Ext. 29/32": #128350-PB  
 & 128350-CP  
 Ext. Adapt. Screw: #103310

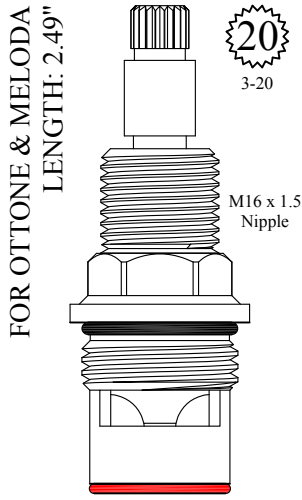

GASKET: 890170 O-RING INCLUDED  
 SEAL: 898580-R/B  
 DISC SET: 151380-PKG

LF462841  
 LF462842

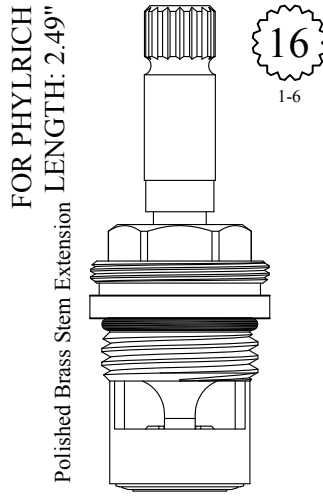

GASKET: 890170 O-RING INCLUDED  
 SEAL: 898510-W  
 DISC SET: 151380-PKG

LF463651  
 LF463652

Also available with chrome plated stem extension  
**LF463651-CP / LF463652-CP**

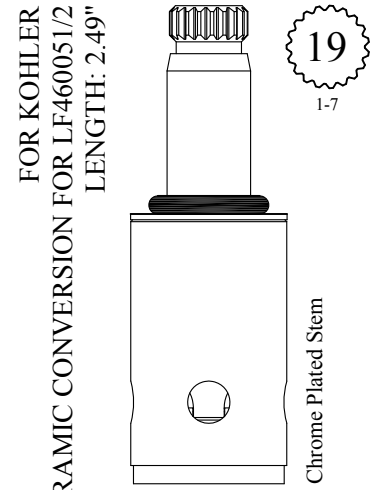

DISC SET: 151380-PKG

LF463811  
 LF463812

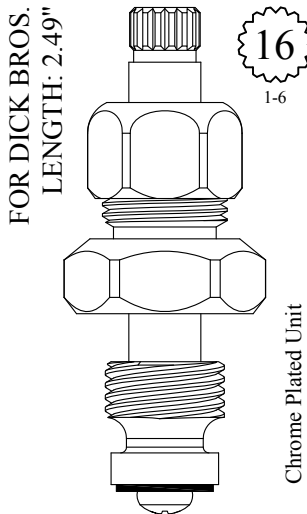

LF463841  
 LF463842  
 LF263841 Stem Only  
 LF263842 Stem Only

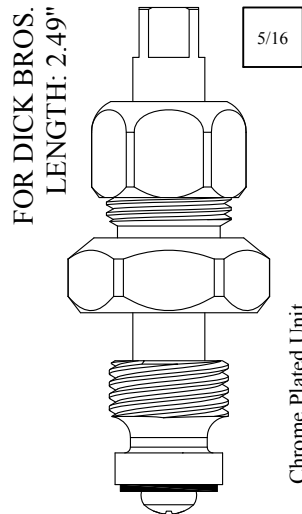

LF463851  
 LF263851 Stem Only

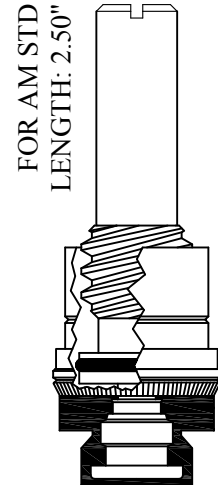

401551  
 SEAT USED: LF648990

FOR SUPER GRIF  
LENGTH: 2.50"

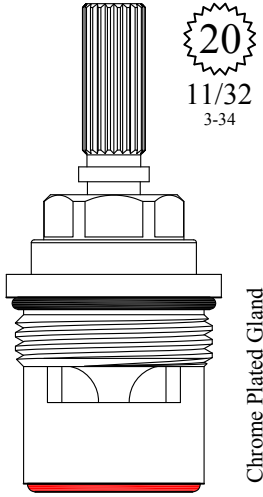

20  
11/32  
3-34

Chrome Plated Gland

GASKET: 890210 O-RING INCLUDED  
SEAL: 898610-R/B  
DISC SET: 109850-PKG

401281  
401282

FOR BRIGGS  
LENGTH: 2.50"

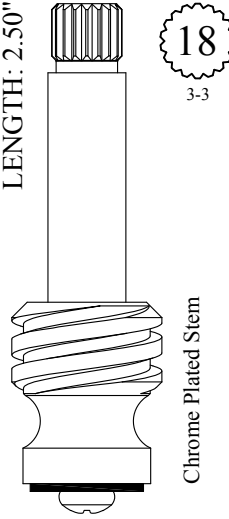

18  
3-3

Chrome Plated Stem

LF263161  
LF263162

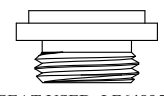

SEAT USED: LF648950

FOR SEARS  
LENGTH: 2.50"

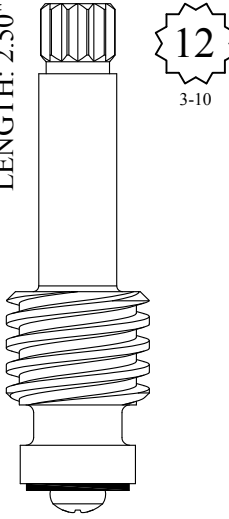

12  
3-10

LF264111  
LF264112

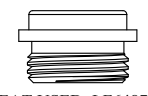

SEAT USED: LF648700

FOR AM BRASS  
LENGTH: 2.50"

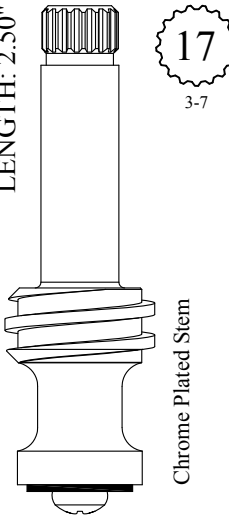

17  
3-7

Chrome Plated Stem

LF264261



SEAT USED: LF648410

FOR AM STD  
LENGTH: 2.50"

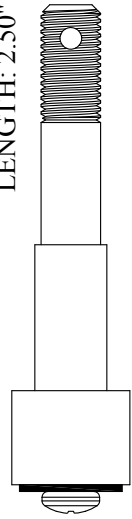

LF264300

FOR KOHLER  
LENGTH: 2.50"

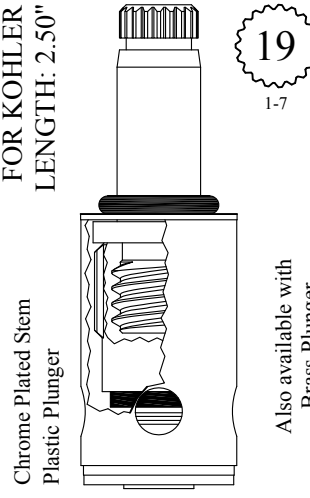

19  
1-7

Chrome Plated Stem  
Plastic Plunger

SEAT INCLUDED:  
LF649460

LF460051  
LF460052  
LF260051 Stem Only  
LF260052 Stem Only

Also available with  
Brass Plunger

LF460051-B / LF460052-B



FOR KOHLER  
LENGTH: 2.50"

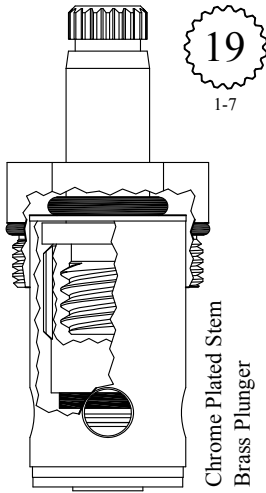

GASKET: 890210 O-RING INCLUDED  
SEAT INCLUDED: LF649460

LF460251-B  
LF460252-B  
LF260051 Stem Only  
LF260052 Stem Only

FOR KOHLER  
LENGTH: 2.50"

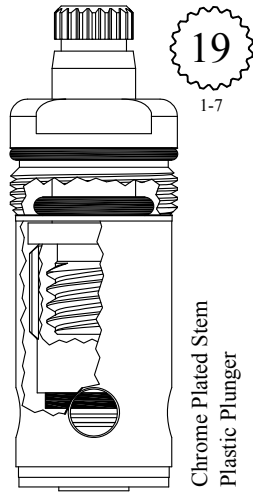

GASKET: 890180 O-RING INCLUDED  
SEAT INCLUDED: LF649460

LF460261  
LF460262  
LF260051 Stem Only  
LF260052 Stem Only

LF460261-B / LF460262-B

FOR BRIGGS  
LENGTH: 2.50"

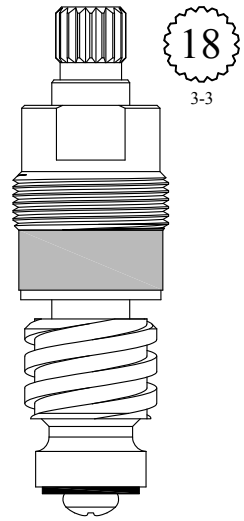

LF464031  
LF464032  
LF264031 Stem Only  
LF264032 Stem Only

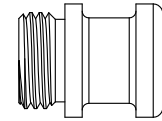

SEAT USED: LF648250

FOR SPEAKMAN  
LENGTH: 2.51"

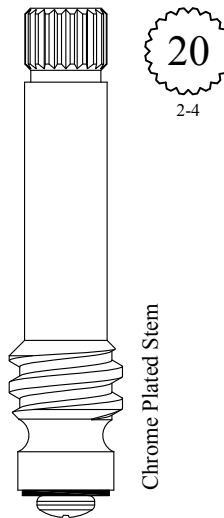

LF264081  
LF264082



SEAT USED: LF648760

FOR AM STD  
STEM LENGTH: 2.25"

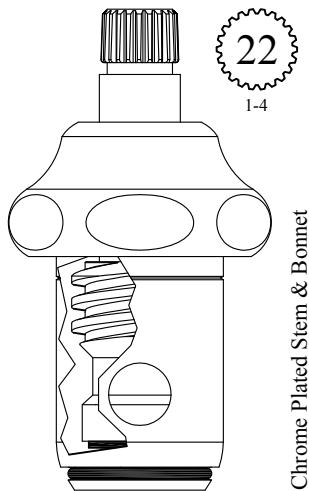

GASKET: 861020 INCLUDED

LF461021  
LF461022  
LF261021 Stem Only  
LF261022 Stem Only

USES BARREL:  
LF647021/LF647022

FOR HARDEN  
LENGTH: 2.51"

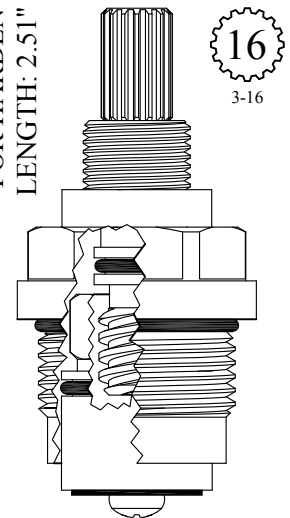

GASKET: 890210 O-RING INCLUDED

LF463901  
LF463902

UNKNOWN  
LENGTH: 2.52"

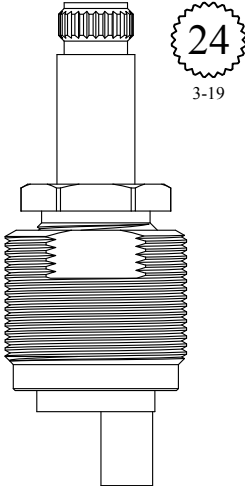

430680  
230680 Stem Only

FOR SPEAKMAN  
LENGTH: 2.52"



LF264430

FOR HARCRAFT  
LENGTH: 2.52"

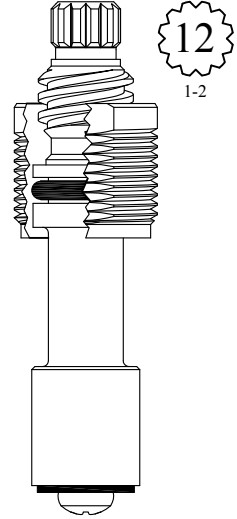

GASKET: 895040 INCLUDED

LF464021  
LF464022

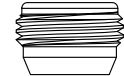

SEAT USED: LF648670

UNKNOWN  
LENGTH: 2.52"

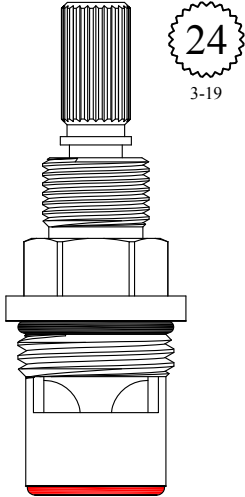

GASKET: 890170 O-RING INCLUDED  
SEAL: 898570-R/B  
DISC SET: 151380-PKG

LF464351  
LF464352

UNKNOWN  
LENGTH: 2.53"

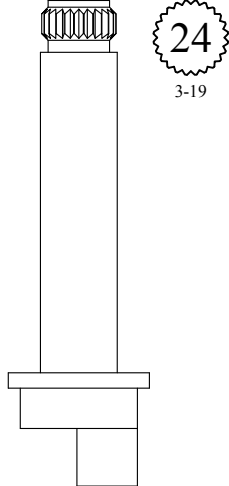

230890

FOR AM STD  
LENGTH: 2.53"

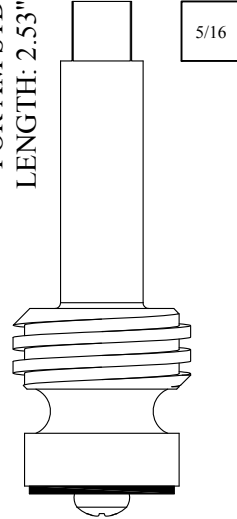

264851

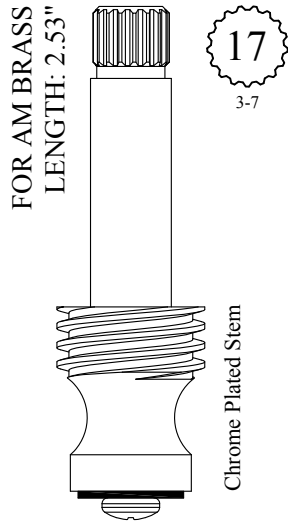

LF264291

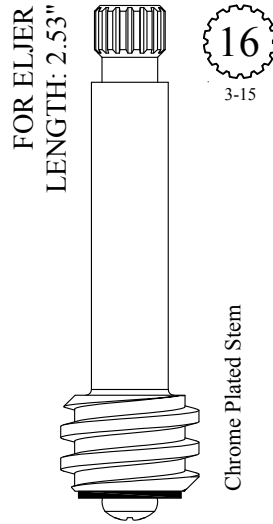

LF265171

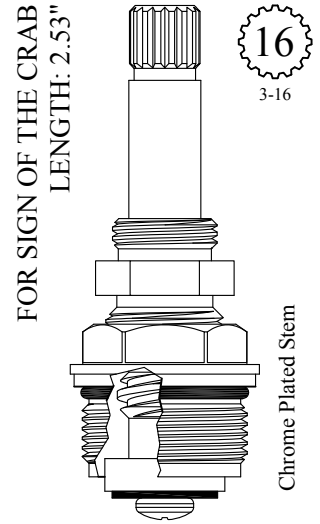

GASKET: 890180 O-RING INCLUDED

LF464151  
LF464152

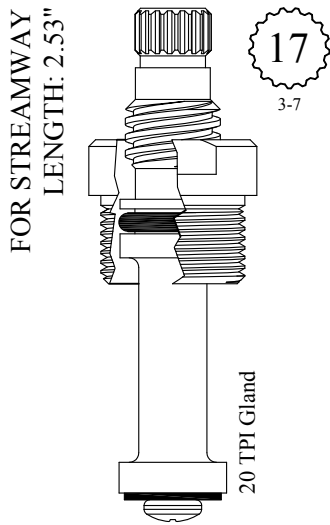

GASKET: 895100

LF464161  
LF464162



SEAT USED: LF648040

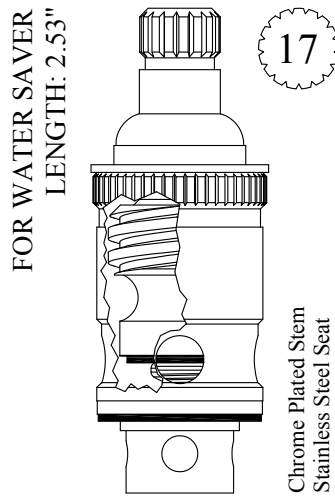

SEAT INCLUDED: LF649880

LF464041  
LF464042

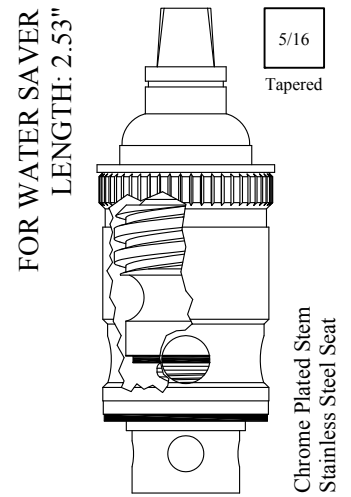

SEAT INCLUDED: LF649880

LF464441  
LF464442

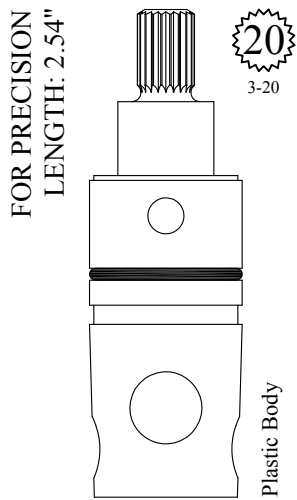

230670

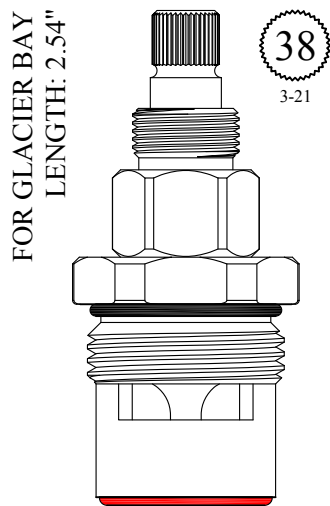

GASKET: 890200 O-RING INCLUDED  
SEAL: 898610-R/B  
DISC SET: 109850-PKG

401421  
401422

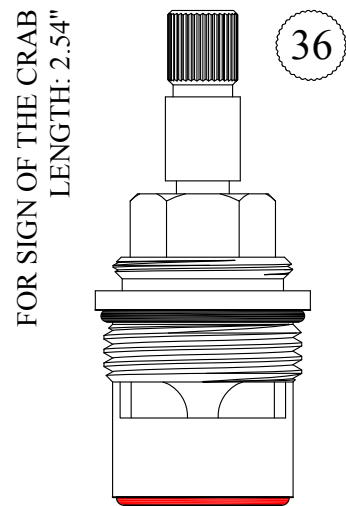

GASKET: 890210 O-RING INCLUDED  
SEAL: 898610-R/B  
DISC SET: 109850-PKG

401481  
401482

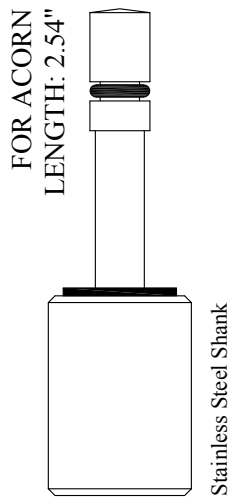

LF138990

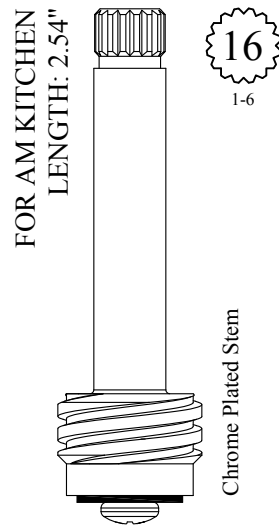

LF264091  
LF264092

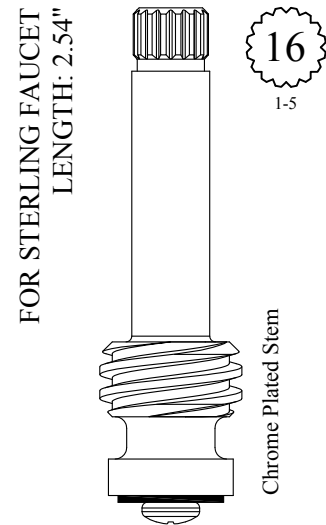
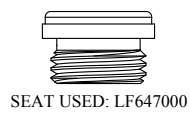

LF265011  
LF265012



FOR SPEAKMAN  
LENGTH: 2.54"

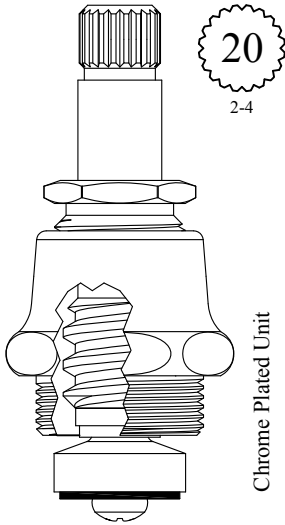

Chrome Plated Unit

GASKET: 895180

LF464051  
LF464052  
LF264051 Stem Only  
LF264052 Stem Only

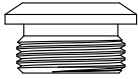

SEAT USED: LF648930

FOR STREAMWAY  
LENGTH: 2.54"

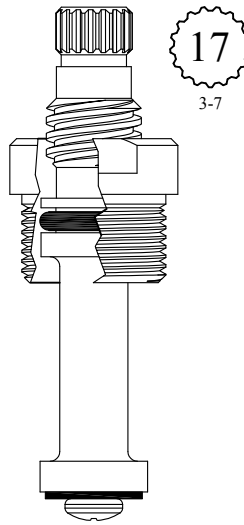

GASKET: 895100

LF464121  
LF464122



SEAT USED: LF648040

FOR DONNER  
LENGTH: 2.54"

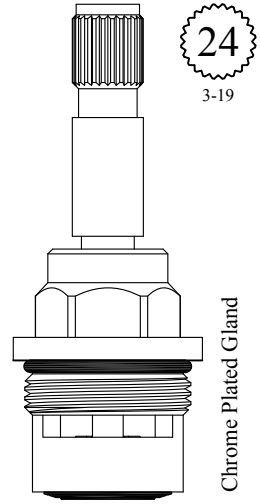

Chrome Plated Gland

GASKET: 890180 O-RING INCLUDED  
SEAL: 898510  
DISC SET: 151380-PKG

LF464371  
LF464372

FOR NIBCO  
LENGTH: 2.55"

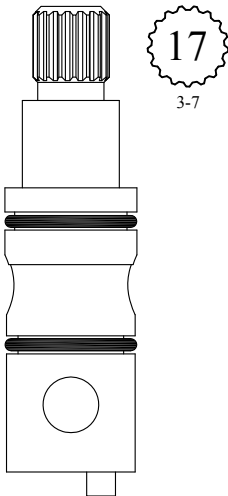

230730

FOR ARMONIA  
LENGTH: 2.55"

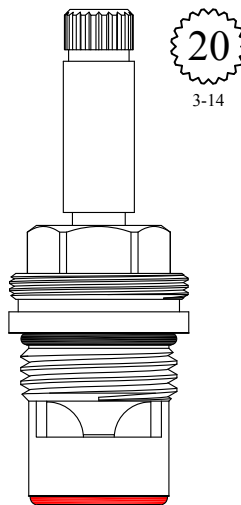

GASKET: 890170 O-RING INCLUDED  
SEAL: 898570-R/B  
DISC SET: 151380-PKG

LF462861  
LF462862

FOR ARMONIA  
LENGTH: 2.55"

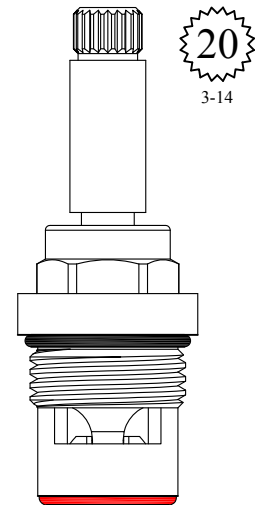

GASKET: 890170 O-RING INCLUDED  
SEAL: 898570-R/B  
DISC SET: 151380-PKG

LF462881  
LF462882

FOR ARMONIA  
LENGTH: 2.55"

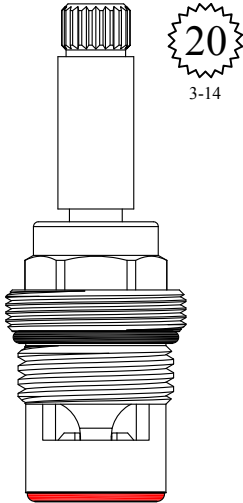

20  
3-14

GASKET: 890170 O-RING INCLUDED  
SEAL: 898570-R/B  
DISC SET: 151380-PKG

LF462891  
LF462892

FOR ROYAL BRASS  
LENGTH: 2.55"

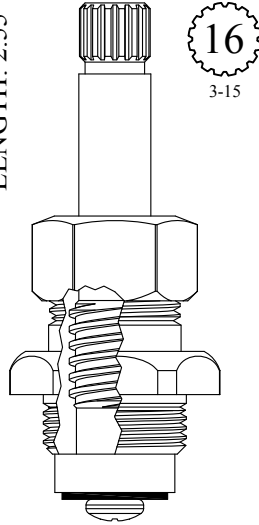

16  
3-15

GASKET: 895100

LF463861

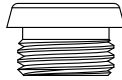

SEAT USED: LF648260

FOR AM BRASS  
LENGTH: 2.55"

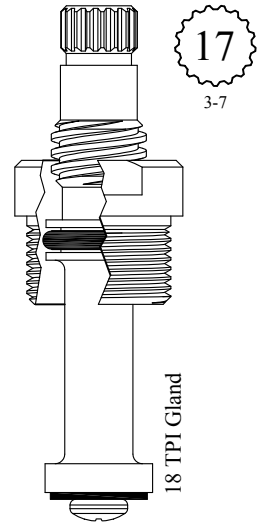

17  
3-7

GASKET: 895100

LF463981  
LF463982



SEAT USED: LF648140

FOR AM BRASS  
LENGTH: 2.55"

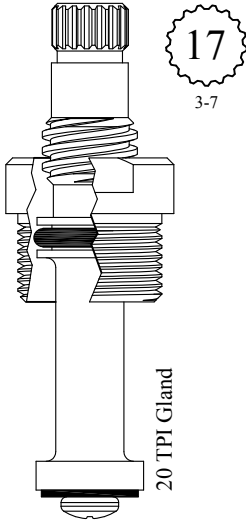

17  
3-7

GASKET: 895100

LF464001  
LF464002

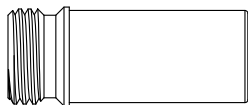

SEAT USED: LF648140

IMPORT  
LENGTH: 2.55"

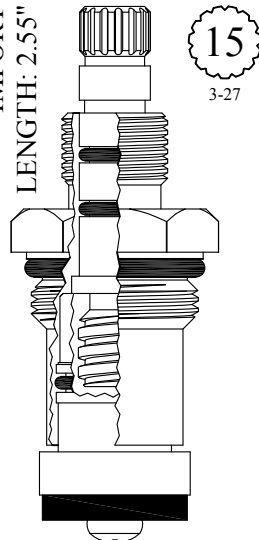

15  
3-27

GASKET: 891160 INCLUDED

LF464391  
LF464392

FOR GERBER  
LENGTH: 2.56"

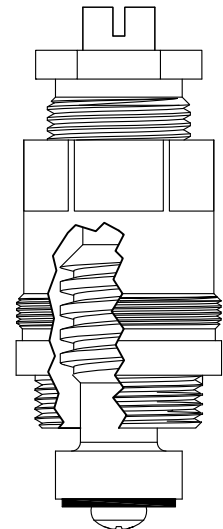

GASKET: 895400

401241  
201241 Stem Only

FOR CENTRAL  
LENGTH: 2.56"

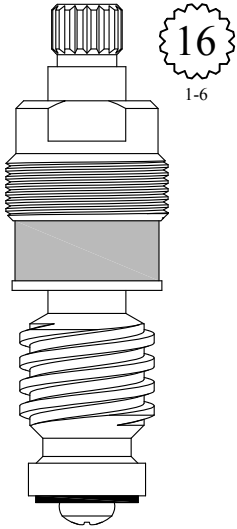

16  
1-6

LF464101  
LF464102  
LF264101 Stem Only  
LF264102 Stem Only



SEAT USED: LF648550

METERING

FOR WILLOUGHBY  
LENGTH: 2.56"

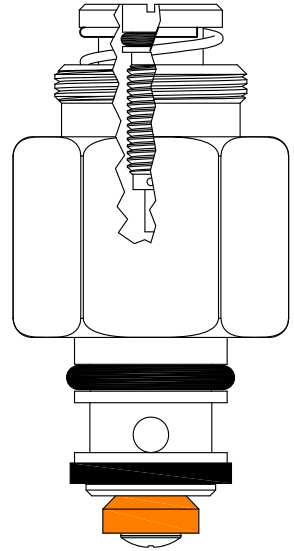

LF465480

FOR ACORN  
LENGTH: 2.57"

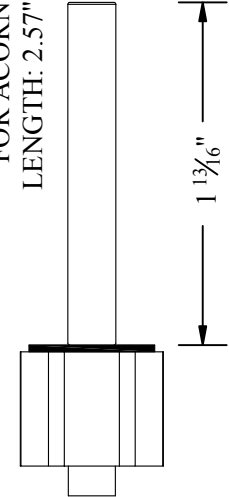

LF130680

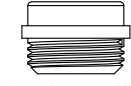

SEAT USED: LF647560

FOR MUELLER  
LENGTH: 2.57"

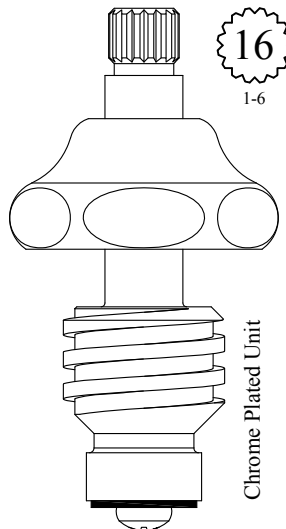

16  
1-6

401401  
201401 Stem Only

FOR MUELLER  
LENGTH: 2.57"

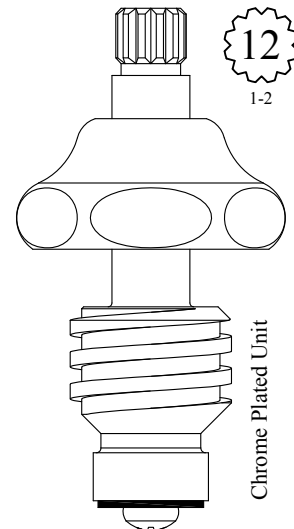

12  
1-2

401451  
201451 Stem Only

FOR AM STD  
LENGTH: 2.57"

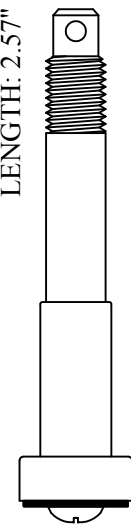

LF264250

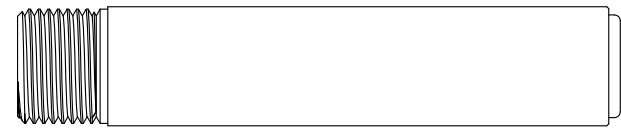

SEAT USED: LF649190

Individual items available  
 Stem Ext.: #118760  
 Esc Cap Nut: #124940

FOR MILWAUKEE  
 LENGTH: 2.57

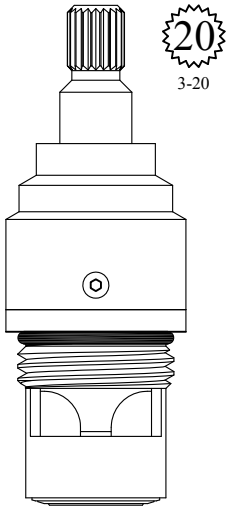

20  
 3-20

GASKET: 890170 O-RING INCLUDED  
 SEAL: 898510-W  
 DISC SET: 151380-PKG

LF463941  
 LF463942

FOR MICHIGAN BRASS  
 LENGTH: 2.57

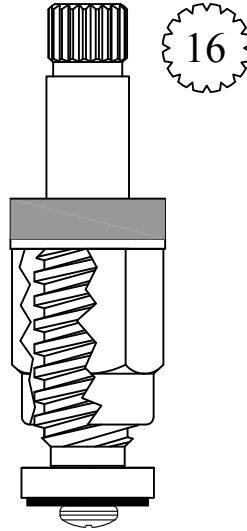

16

LF464141  
 LF464142

FOR PRICE PFISTER  
 LENGTH: 2.59"

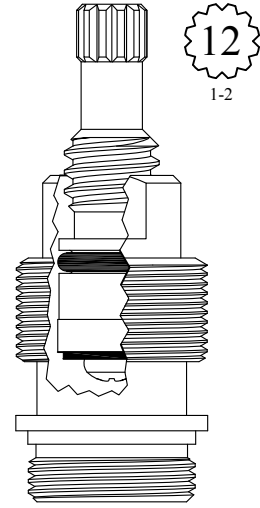

12  
 1-2

GASKET: 895400

401311

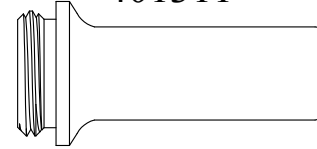

SEAT USED: 648290

FOR MICHIGAN BRASS  
 LENGTH: 2.59

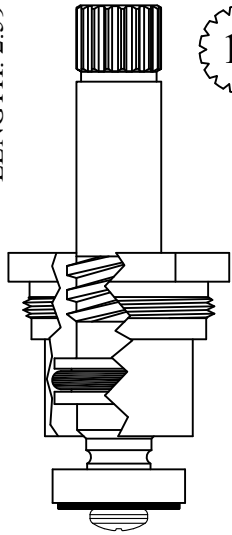

16

Chrome Plated Stem

LF465321  
 LF465322

FOR MOEN  
 LENGTH: 2.60"

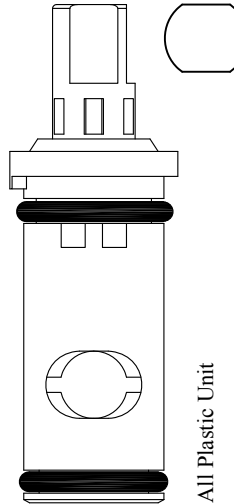

All Plastic Unit

464300

FOR KOHLER  
 LENGTH: 2.60"

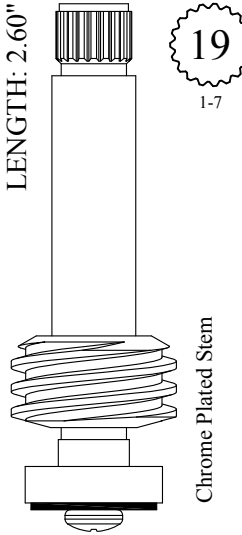

19  
 1-7

Chrome Plated Stem

LF264321



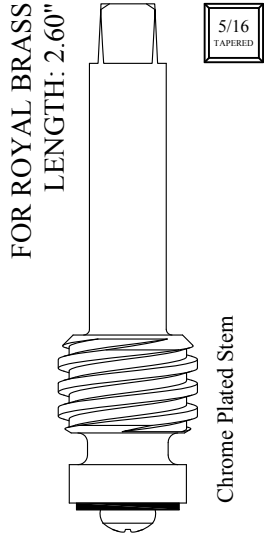

LF264411  
LF264412

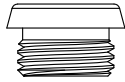

SEAT USED: LF648260

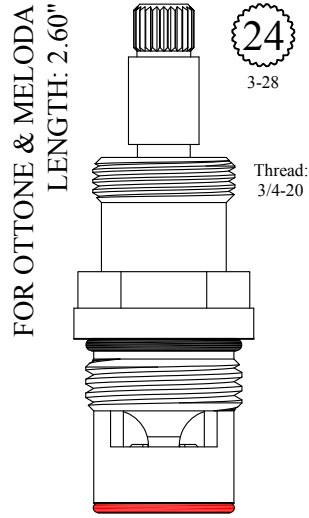

GASKET: 890170 O-RING INCLUDED  
SEAL: 898580-R/B  
DISC SET: 151380-PKG

LF401391  
LF401392

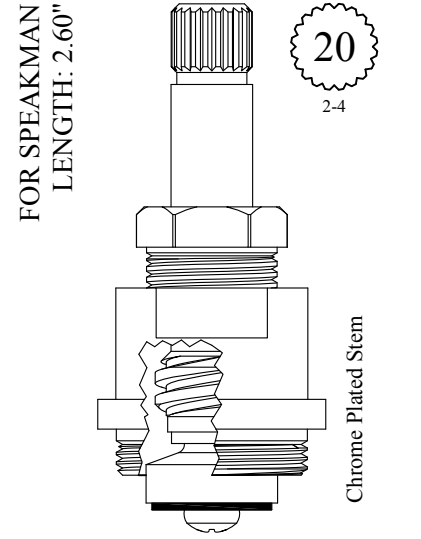

GASKET: 895550

LF464071  
LF264071 Stem Only

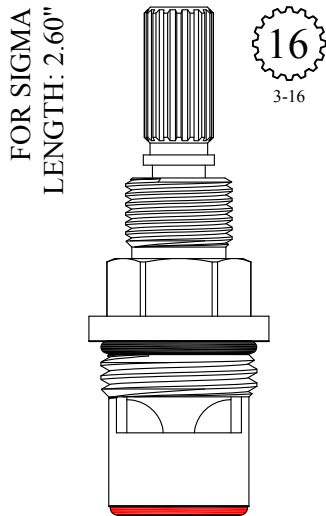

GASKET: 890170 O-RING INCLUDED  
SEAL: 898570-R/B  
DISC SET: 151380-PKG

LF464341  
LF464342

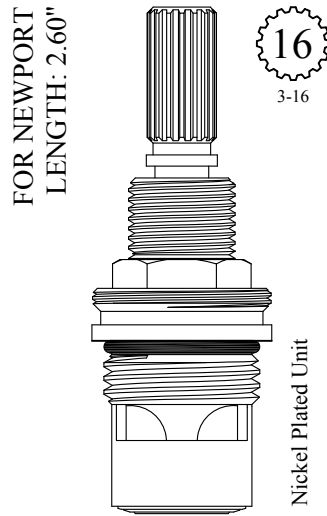

GASKET: 890170 O-RING INCLUDED  
SEAL: 898510-W  
DISC SET: 151380-PKG

LF464361  
LF464362

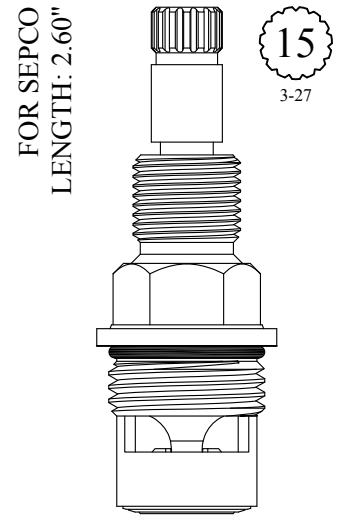

GASKET: 890170 O-RING INCLUDED  
SEAL: 898510-W  
DISC SET: 151380-PKG

LF464381  
LF464382

FOR ROYAL BRASS  
LENGTH: 2.60"

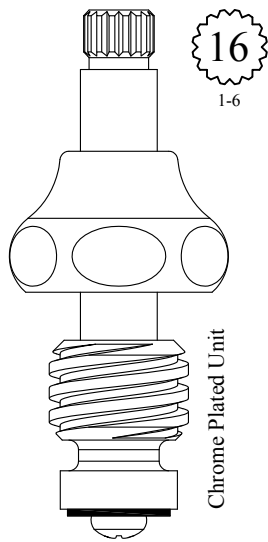

16  
1-6

Chrome Plated Unit

LF464401  
LF464402  
LF264401 Stem Only  
LF264402 Stem Only

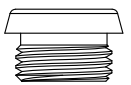

SEAT USED: LF648260

FOR REID WATSON  
LENGTH: 2.60"

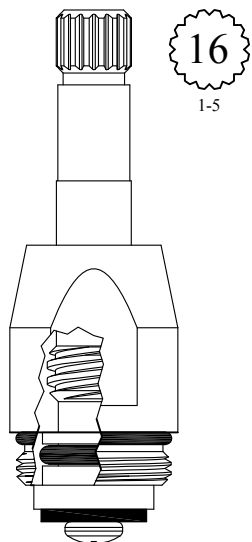

16  
1-5

GASKET: 890170 O-RING INCLUDED

LF464501  
LF464502

FOR SIGN OF THE CRAB  
LENGTH: 2.60"

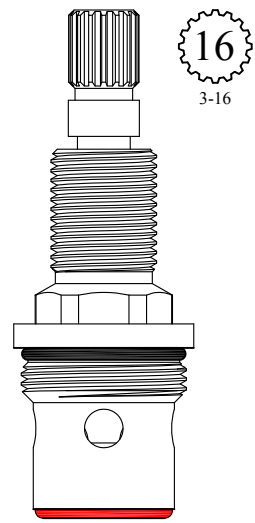

16  
3-16

GASKET: 890170 O-RING INCLUDED  
SEAL: 898570-R/B  
DISC SET: 151380-PKG

LF464511  
LF464512

FOR POWERS  
LENGTH: 2.60"

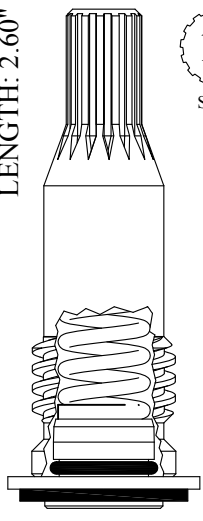

15  
Small

201531

FOR FIAT  
LENGTH: 2.61"

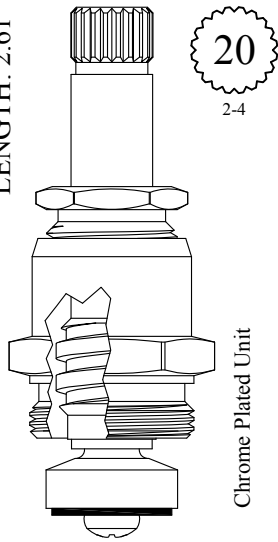

20  
2-4

Chrome Plated Unit

GASKET: 895400

LF464201

FOR AM STD  
LENGTH: 2.62"

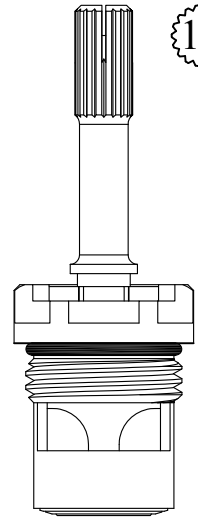

18

All Brass Unit - No Plastic

GASKET: 890170 O-RING INCLUDED  
SEAL: 898510-W  
DISC SET: 151380-PKG

401501  
401502

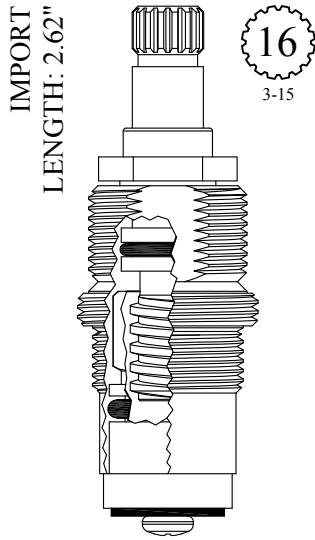

GASKET: 895140

LF464602

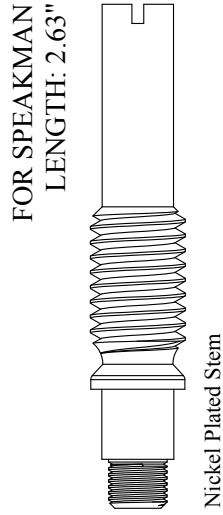

264331

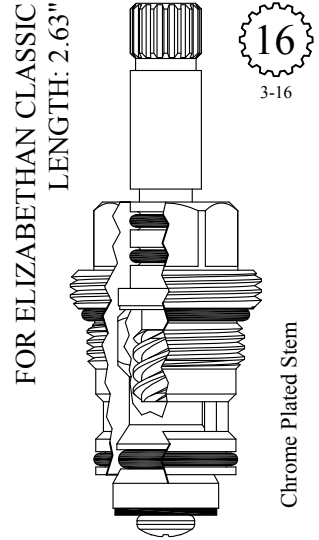

GASKET: 890180 O-RING INCLUDED

430881

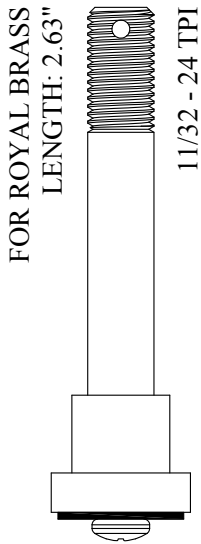

LF264700



SEAT USED: LF648260

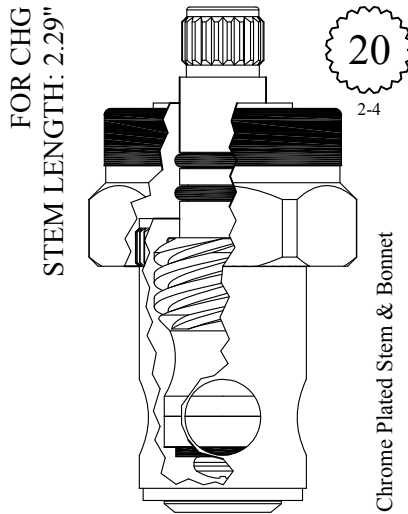

LF463921  
LF463922

Individual items available  
Stem Ext. 1-1/16": #105270-PB  
& #105270-CP  
Ext. Adap. Screw: #103310

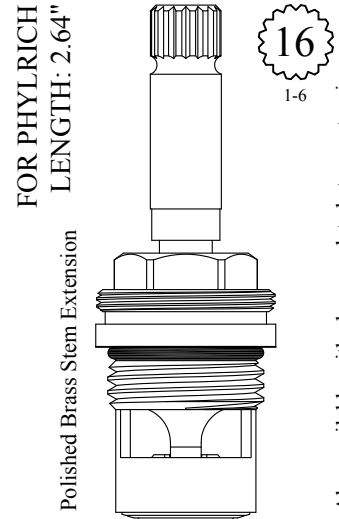

GASKET: 890170 O-RING INCLUDED  
SEAL: 898510-W  
DISC SET: 151380-PKG

LF464661  
LF464662

Also available with chrome plated stem extension  
LF464661-CP / LF464662-CP

SLOW COMPRESSION

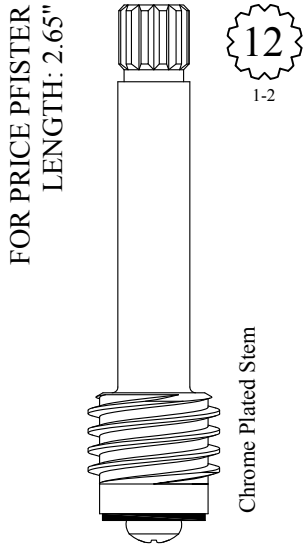

LF265031  
LF265032

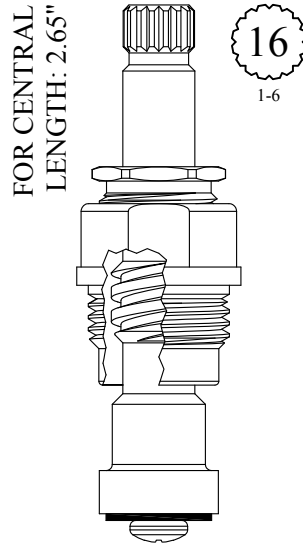

LF464801  
LF464802

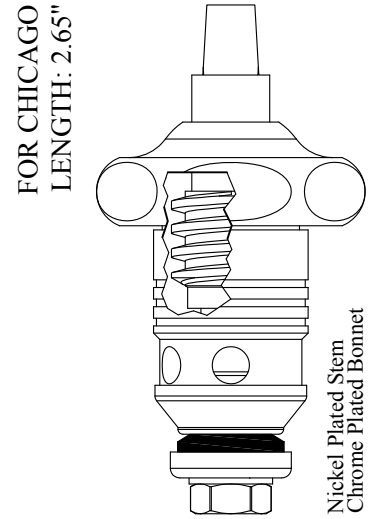

GASKET: 895200  
SEAT INCLUDED: 648750

LF464991  
LF464992

SLOW COMPRESSION

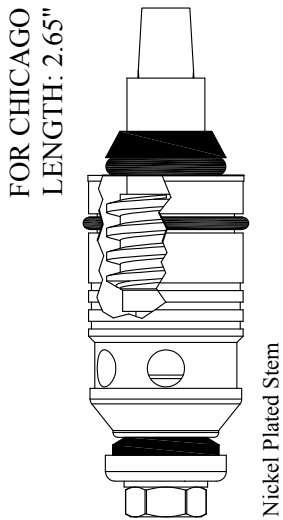

GASKET: 895200  
SEAT INCLUDED: 648750

LF465001  
LF465002

QUATURN

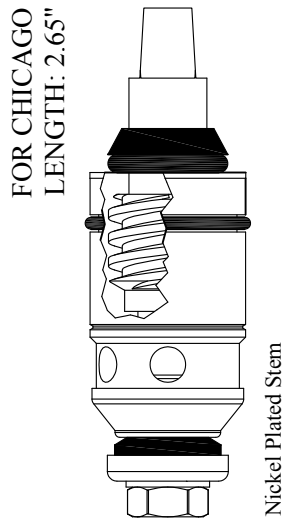

GASKET INCLUDED: 895200  
SEAT INCLUDED: 648750

LF465041  
LF465042

QUATURN

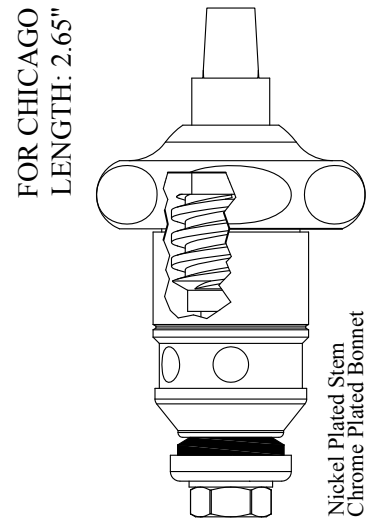

GASKET: 895200  
SEAT INCLUDED: 648750

LF465051  
LF465052

FOR PRICE PFISTER  
LENGTH: 2.65"

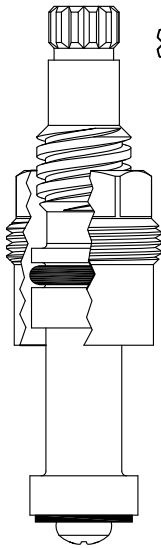

12  
1-2

GASKET: 895060

LF465091  
LF465092



SEAT USED: LF648270

NEW STYLE  
QUARTURN

FOR CHICAGO  
LENGTH: 2.65"

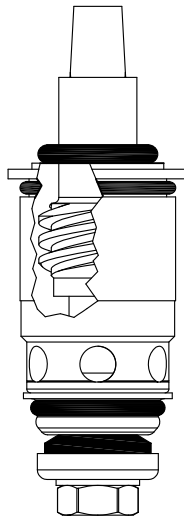

Nickel Plated Stem

GASKET: 895200  
SEAT INCLUDED: 648750

LF465221  
LF465222

SLOW COMPRESSION  
CONTROL-A-FLOW

FOR CHICAGO  
LENGTH: 2.65"

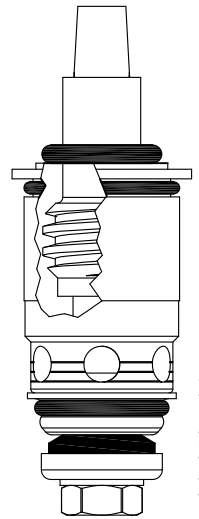

Nickel Plated Stem

GASKET: 895200  
SEAT INCLUDED: 648750

LF465231  
LF465232

QUARTURN  
CONTROL-A-FLOW

FOR CHICAGO  
LENGTH: 2.65"

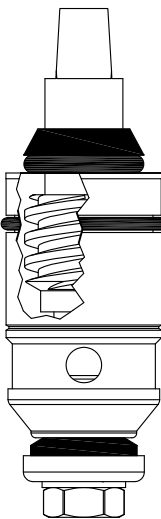

Nickel Plated Stem

GASKET: 895200  
SEAT INCLUDED: 648750

LF465241  
LF465242

NEW STYLE  
SLOW COMPRESSION

FOR CHICAGO  
LENGTH: 2.65"

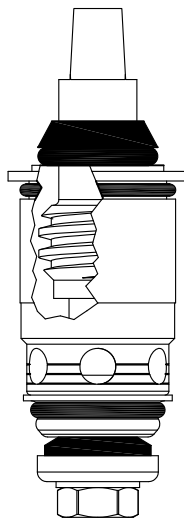

Nickel Plated Stem

GASKET: 895200  
SEAT INCLUDED: 648750

LF465281  
LF465282

NON-METERING

FOR WILLOUGHBY  
LENGTH: 2.65"

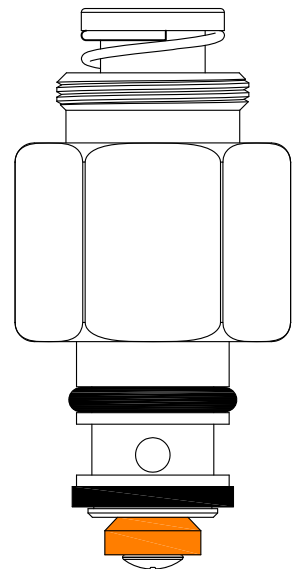

LF465470

FOR CENTRAL  
LENGTH: 2.66"

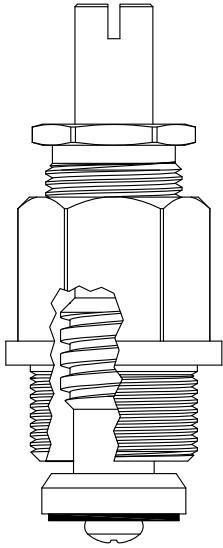

GASKET: 895400

401611  
201611 Stem Only

FOR CENTRAL  
LENGTH: 2.66"

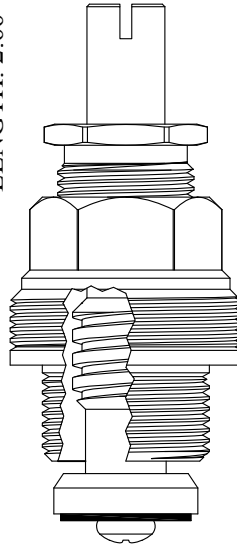

GASKET: 895400

401621  
201611 Stem Only

FOR BROADWAY  
LENGTH: 2.66"

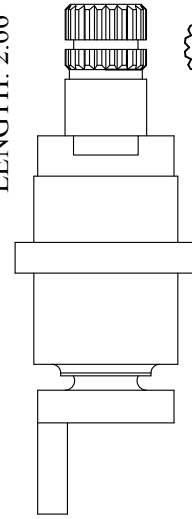

20  
2-4

430540

FOR SIGN OF THE CRAB  
LENGTH: 2.66"

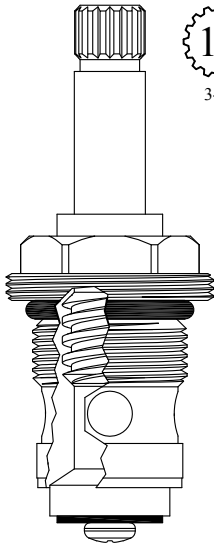

16  
3-16

Chrome Plated Stem

GASKET: 891150 O-RING INCLUDED

430761

FOR CRANE  
LENGTH: 2.66"

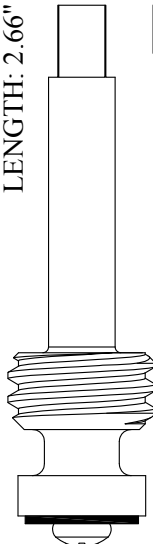

1/4

Chrome Plated Stem

LF264461

FOR CENTRAL  
LENGTH: 2.66"

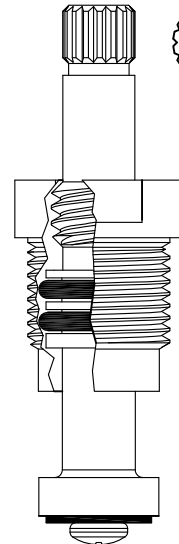

16  
1-6

GASKET: 895100

LF464811  
LF464812

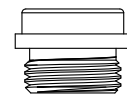

SEAT USED: LF648550

FOR RICHARD RHEEM  
LENGTH: 2.66"

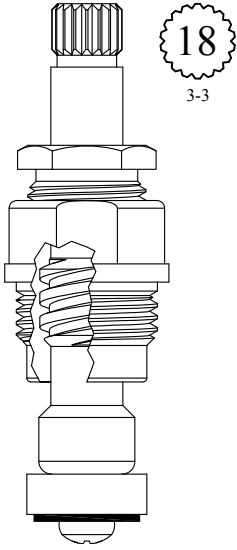

GASKET: 895100

LF465081  
LF465082



FOR STERLING FAUCET  
LENGTH: 2.67"

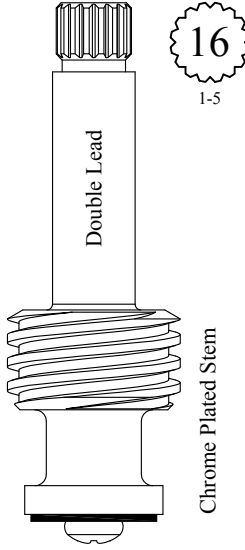

LF264861  
LF264862

FOR CRANE  
CERAMIC CONVERSION FOR DIAL-EZE  
LENGTH: 2.67"

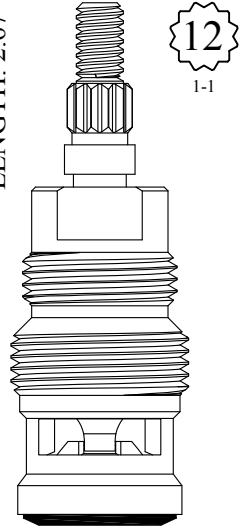

GASKET: 895250 INCLUDED  
DISC SET: 151380-PKG

LF464311  
LF464312

FOR T & S  
LENGTH: 2.67"

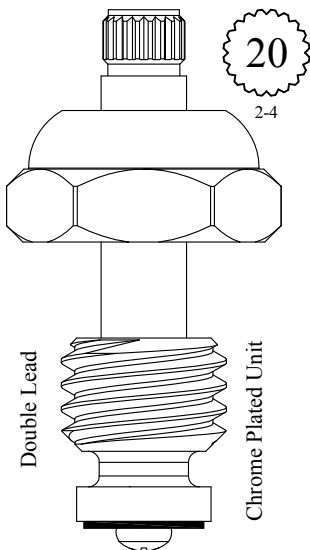

LF465021  
LF465022  
LF265021 Stem Only  
LF265022 Stem Only

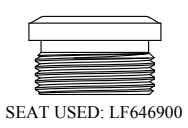

FOR RICHARD RHEEM  
LENGTH: 2.67"

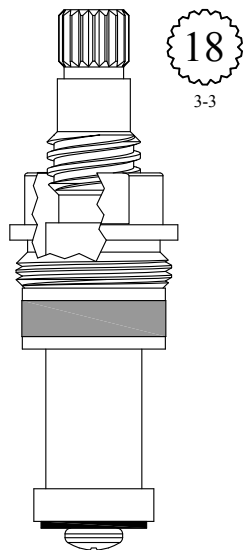

LF465111  
LF465112



FOR T & S  
LENGTH: 2.67"

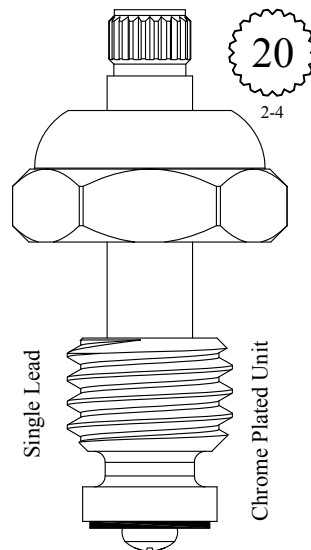

LF465181  
LF265181 Stem Only

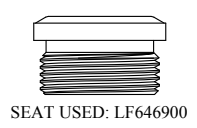

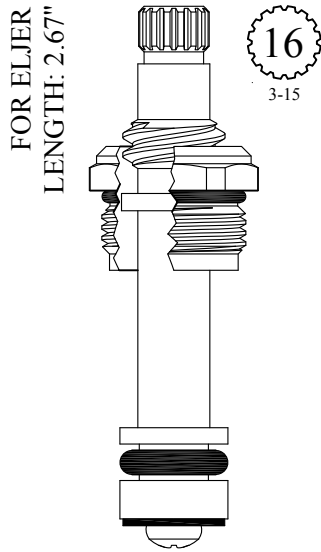

16  
3-15

GASKET: 890160 O-RING INCLUDED

LF465381



SEAT USED: LF648320

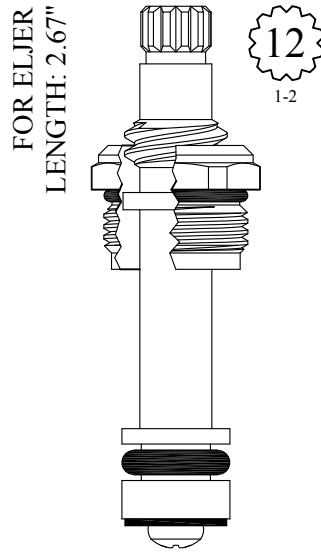

12  
1-2

GASKET: 890160 O-RING INCLUDED

LF465391  
LF465392



SEAT USED: LF648320

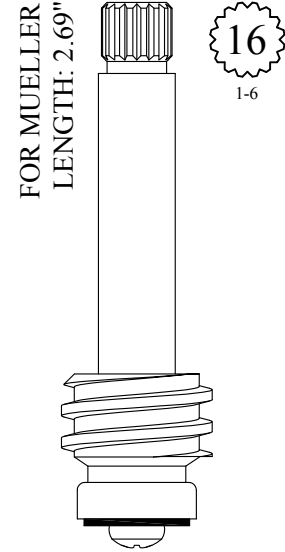

16  
1-6

201411

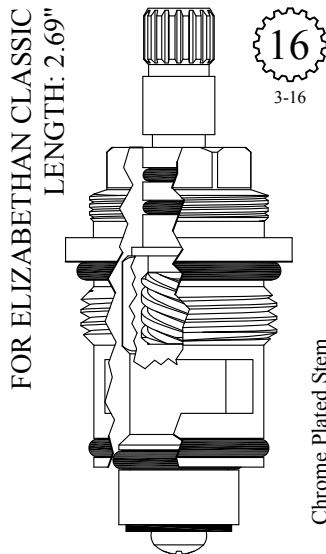

16  
3-16

Chrome Plated Stem

GASKET: 890180 O-RING INCLUDED

431052

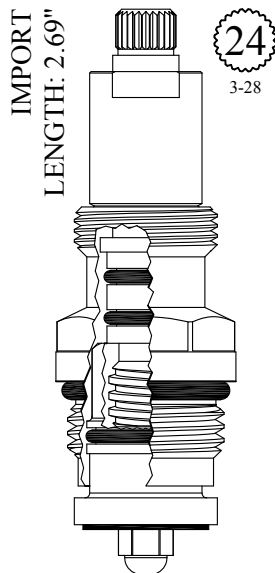

24  
3-28

GASKET: 891150 INCLUDED

LF464712

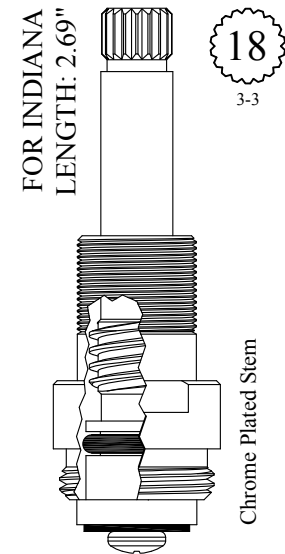

18  
3-3

Chrome Plated Stem

GASKET: 895150

LF465061  
LF465062

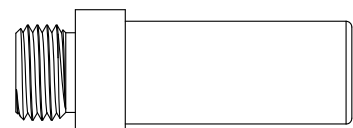

SEAT USED: LF649160



FOR WATTS  
LENGTH: 2.70"

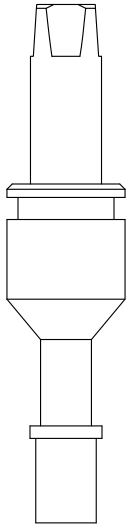

130990

FOR CHASE  
LENGTH: 2.70"

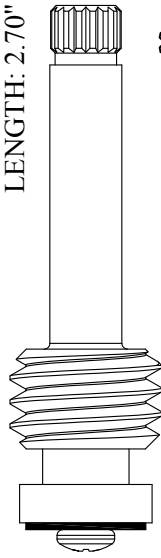

16  
1-6

Chrome Plated Stem

LF264171

FOR BARBER WILSON  
LENGTH: 2.70"

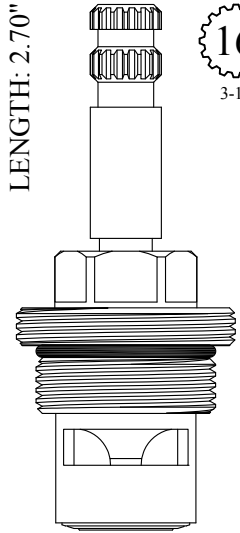

16  
3-16

GASKET: 890190 O-RING INCLUDED  
SEAL: 898510-W  
DISC SET: 151380-PKG

LF464571  
LF464572

FOR STERLING FAUCET  
LENGTH: 2.71"

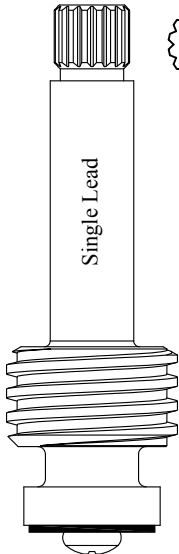

16  
1-5

Chrome Plated Stem

LF264871  
LF264872

FOR CRANE  
LENGTH: 2.69"

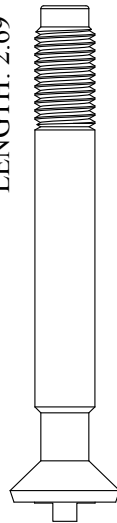

\*\*\*NO LONGER AVAILABLE, USE LF465150\*\*\*

LF265140

FOR AM STD  
LENGTH: 2.71"

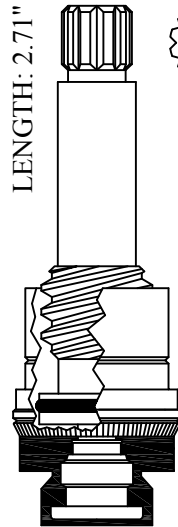

12  
1-2

LF464901  
LF464902

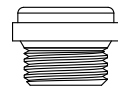

SEAT USED: LF648990

FOR DORNBRACHT  
LENGTH: 2.72"

20  
3-20

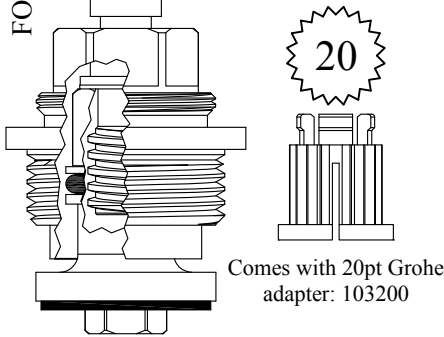

Comes with 20pt Grohe  
adapter: 103200

GASKET: 895560

401762



SEAT USED: LF647120

UNKNOWN  
LENGTH: 2.72"

16  
3-16

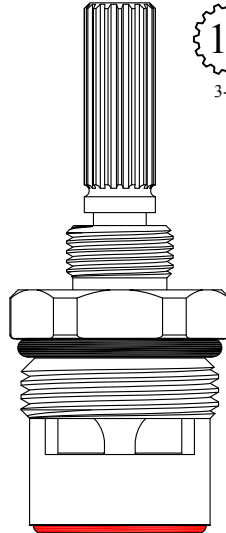

GASKET: 891180 O-RING INCLUDED  
SEAL: 898610-R/B  
DISC SET: 109850-PKG

401561  
401562

IMPORT  
LENGTH: 2.72"

24  
3-18

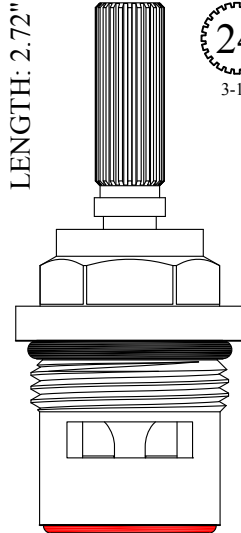

GASKET: 891180 O-RING INCLUDED  
SEAL: 898610-R/B  
DISC SET: 109850-PKG

401591  
401592

Also available less gland  
LF117621

FOR ACORN  
LENGTH: 2.72"

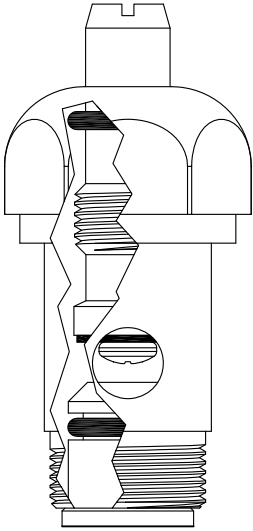

GASKET: 895400  
SEAT INCLUDED: LF601780

LF401781  
LF254071 Stem Only

FOR ELJER  
LENGTH: 2.72"

16  
3-15

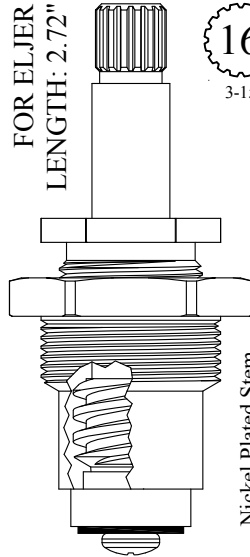

Nickel Plated Stem

GASKET: 895330

LF465071  
LF465072  
LF265071 Stem Only  
LF265072 Stem Only



SEAT USED: LF648160

FOR ELJER  
LENGTH: 2.72"

16  
3-15

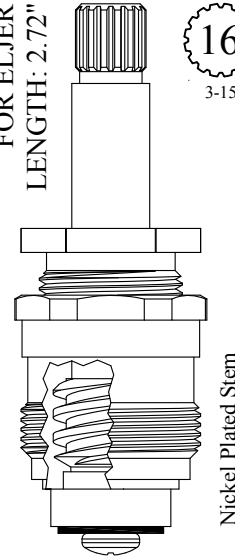

Nickel Plated Stem

GASKET: 895120

LF465571  
LF465572  
LF265071 Stem Only  
LF265072 Stem Only



SEAT USED: LF648160

FOR ELJER  
LENGTH: 2.73"

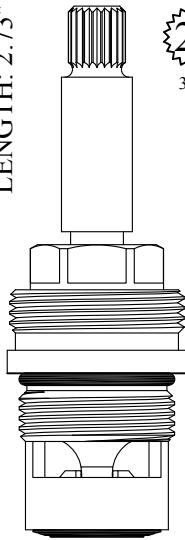

20  
3-20

GASKET: 890170 O-RING INCLUDED  
SEAL: 898510  
DISC SET: 151380-PKG

LF464921  
LF464922

FOR AM STD  
LENGTH: 2.74"

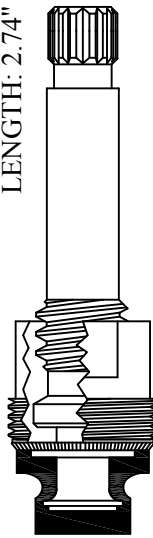

16

401631  
401632



SEAT USED: LF647910 or LF649650

FOR SIGNATURE HARDWARE  
LENGTH: 2.74"

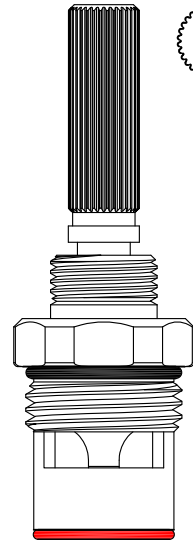

32  
3-23

GASKET: 890170 O-RING INCLUDED  
SEAL: 898570-R/B  
DISC SET: 151380-PKG

LF464421  
LF464422

FOR SEACREST  
LENGTH: 2.68"

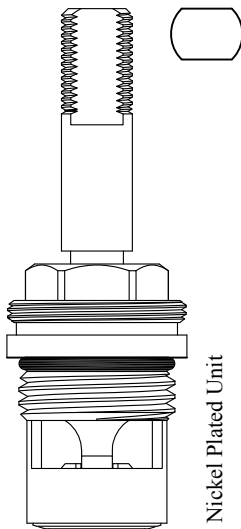

Nickel Plated Unit

GASKET: 890170 O-RING INCLUDED  
SEAL: 898510-W  
DISC SET: 151380-PKG

LF464611  
LF464612

FOR ALTMANS  
LENGTH 2.74"

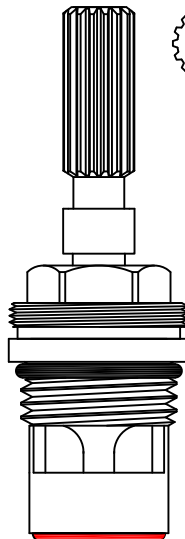

16  
3-16

GASKET: 890170 O-RING INCLUDED  
SEAL: 898570-R/B  
DISC SET: 151380-PKG

LF464911  
LF464912

FOR PRICE PFISTER  
LENGTH: 2.74"

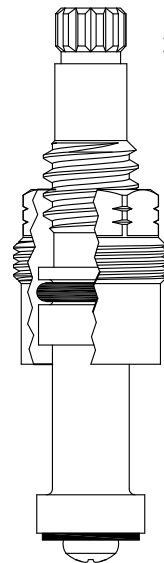

12  
1-2

GASKET: 895060

LF465291

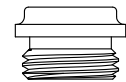

SEAT USED: LF648270

FOR DONNER  
LENGTH: 2.75"

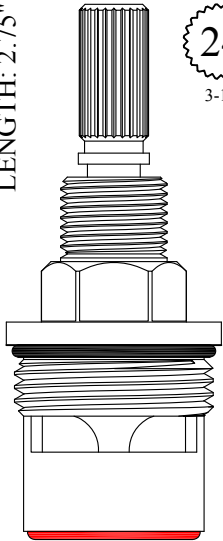

24  
3-19

GASKET: 890210 O-RING INCLUDED  
SEAL: 898610-R/B  
DISC SET: 109850-PKG

401491  
401492

FOR ALTMANS  
LENGTH: 2.75"

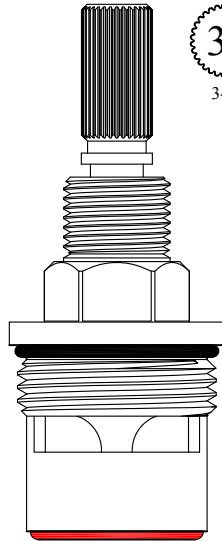

32  
3-23

GASKET: 890210 O-RING INCLUDED  
SEAL: 898610-R/B  
DISC SET: 109850-PKG

401571  
401572

FOR ALTMANS  
LENGTH 2.75"

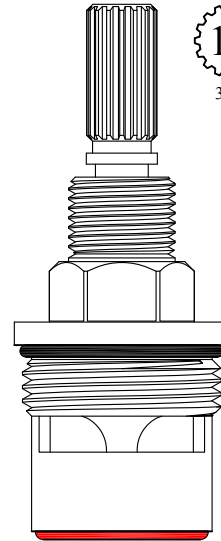

16  
3-16

GASKET: 890210 O-RING INCLUDED  
SEAL: 898610-R/B  
DISC SET: 109850-PKG

401641  
401642

FOR NEWPORT  
LENGTH: 2.75"

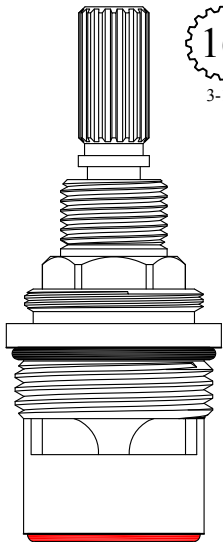

16  
3-16

GASKET: 890210 O-RING INCLUDED  
SEAL: 898610-R/B  
DISC SET: 109850-PKG

401651  
401652

Also available in a Chrome Plated Unit  
401651-CP / 401652-CP

FOR BRIGGS  
LENGTH: 2.75"

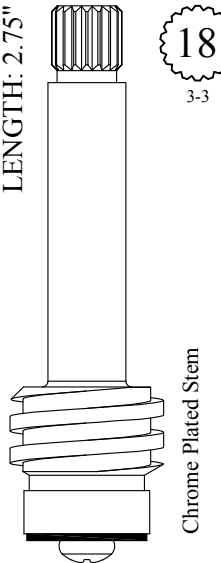

18  
3-3

Chrome Plated Stem

LF265201

FOR ELJER  
LENGTH: 2.75"

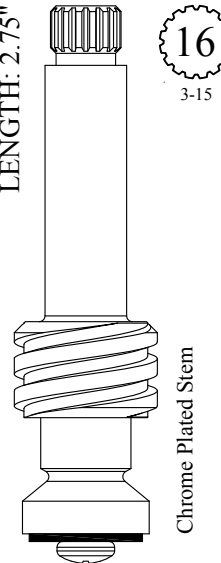

16  
3-15

Chrome Plated Stem

LF265601  
LF265602

FOR TANNER  
LENGTH: 2.77"

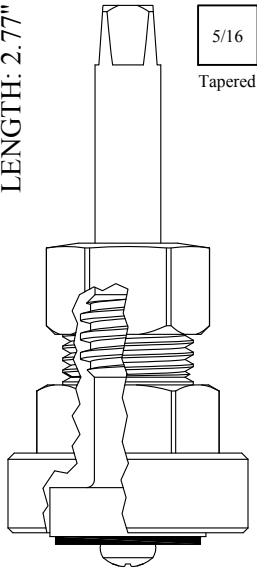

5/16  
Tapered

GASKET: 894860 INCLUDED

465251

Extension Available  
#135000

FOR KOHLER  
LENGTH 2.77"

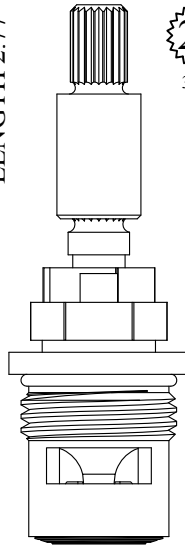

20  
3-20

Nickel Plated Gland

GASKET: 890170 O-RING INCLUDED  
SEAL: 898510  
DISC SET: 151380-PKG

LF464941

CERAMIC 1/4 TURN

FOR CHICAGO  
LENGTH: 2.77"

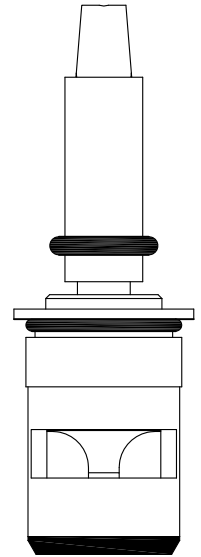

Nickel Plated Stem

GASKET: 890170 O-RING INCLUDED  
SEAL: 898590  
DISC SET: 151380-PKG

LF465461  
LF465462

FOR AM STD  
LENGTH: 2.78"

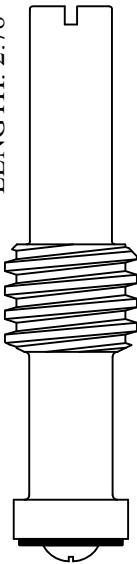

Chrome Plated Stem

201711

UNKNOWN  
LENGTH: 2.78"

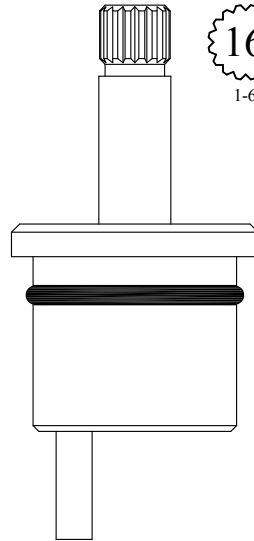

16  
1-6

230860

FOR AM STD  
LENGTH: 2.78"

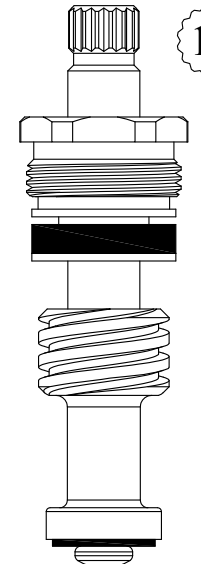

16

LF465101  
LF465102  
LF265101  
LF265102



SEAT USED: LF648350

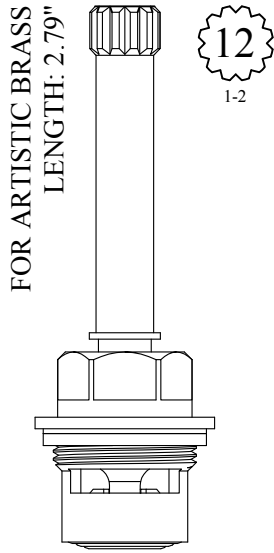

GASKET: 895100 INCLUDED  
SEAL: 898500  
DISC SET: 112530-PKG

401661  
401662

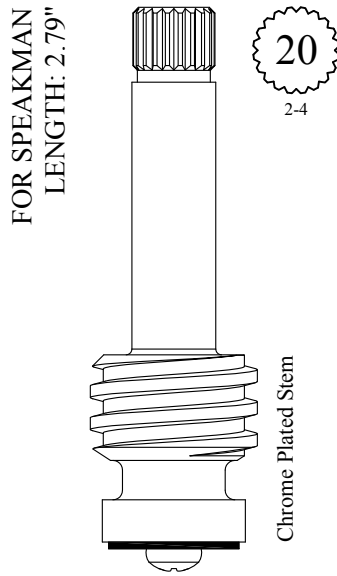

LF265421

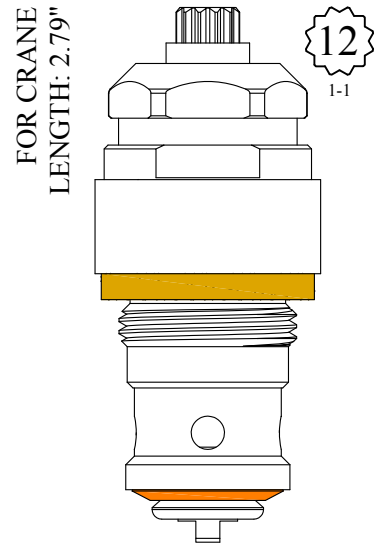

LF456090  
LF256090 Stem Only

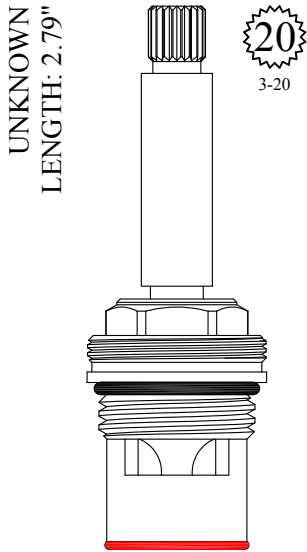

GASKET: 890170 O-RING INCLUDED  
SEAL: 898580-R/B  
DISC SET: 151380-PKG

LF465331  
LF465332

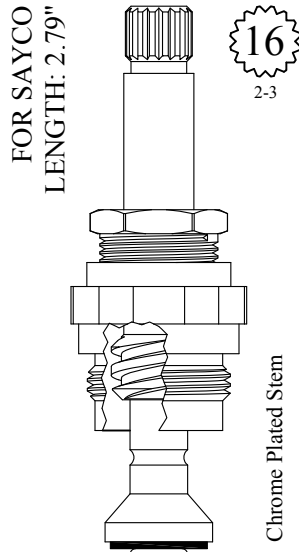

GASKET: 895100

LF466091  
LF466092  
LF266091 Stem Only  
LF266092 Stem Only



SEAT USED: LF647450

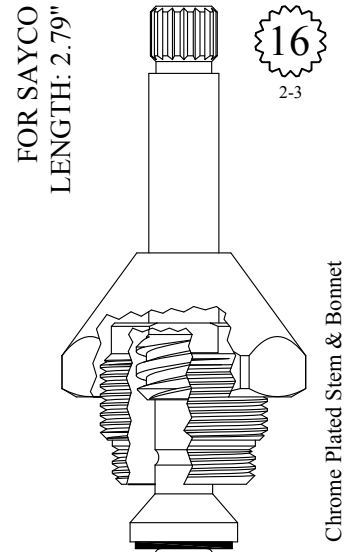

GASKET: 895100

LF466191  
LF466192  
LF266091 Stem Only  
LF266092 Stem Only



SEAT USED: LF647450

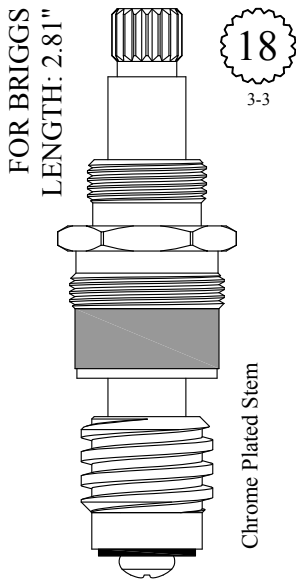

FOR BRIGGS  
LENGTH: 2.81"

Chrome Plated Stem

LF465271  
LF265271 Stem Only

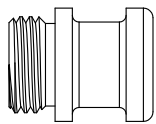

SEAT USED: LF648250

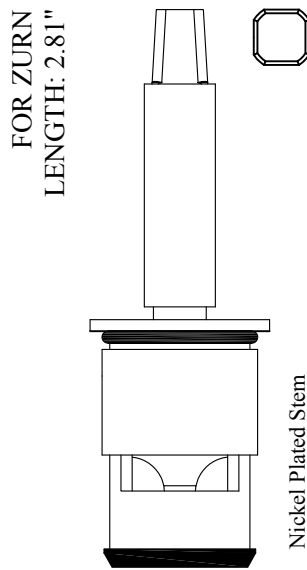

FOR ZURN  
LENGTH: 2.81"

Nickel Plated Stem

SEAL: 898590  
DISC SET: 151380-PKG

LF465441  
LF465442

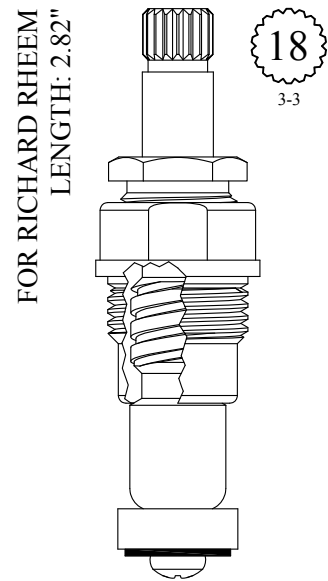

FOR RICHARD RHEEM  
LENGTH: 2.82"

GASKET: 895100

LF465191  
LF465192

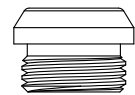

SEAT USED: LF648130

FOR T & S  
LENGTH: 2.83"

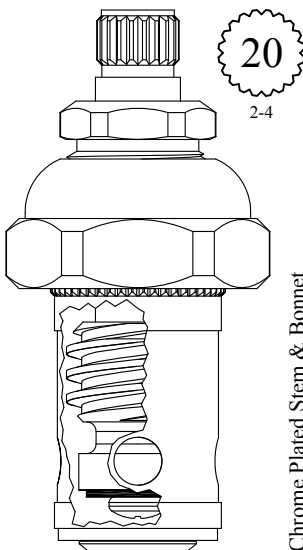

Chrome Plated Stem & Bonnet  
Also available with handle ABRIS33410  
LF453131-3341 / LF453132-3341

LF464061  
LF464062  
LF264061 Stem Only  
LF264062 Stem Only

USES BARREL:  
LF664061/LF664062

FOR T & S  
LENGTH: 2.83"

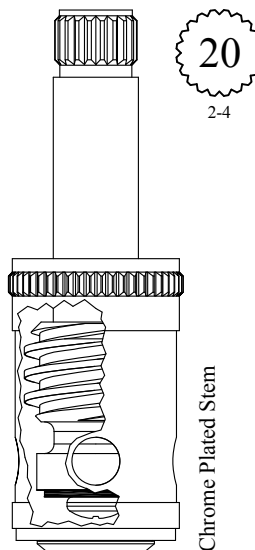

Chrome Plated Stem

LF464061-LB  
LF464062-LB  
LF264061 Stem Only  
LF264062 Stem Only

USES BARREL:  
LF664061/LF664062

IMPORT  
LENGTH: 2.83"

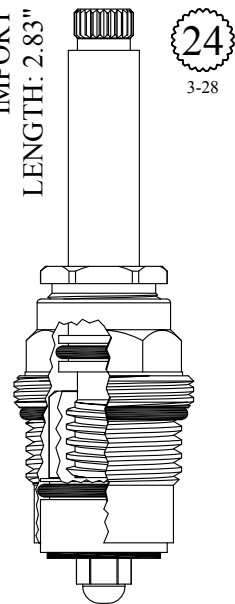

GASKET: 890180 INCLUDED

LF464962

Individual items available  
 Stem Ext. 1-1/4": #105340-PB  
 & 105340-CP  
 Ext. Adap. Screw: #103310

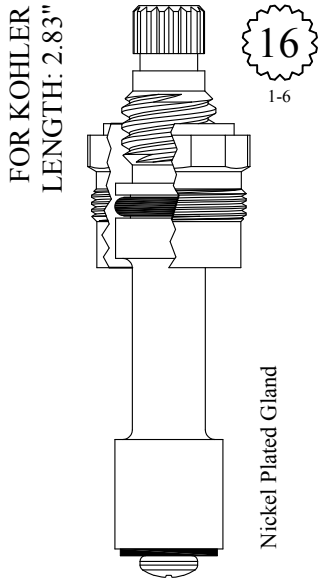

GASKET: 895060

LF465131  
 LF465132

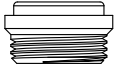

SEAT USED: LF648070

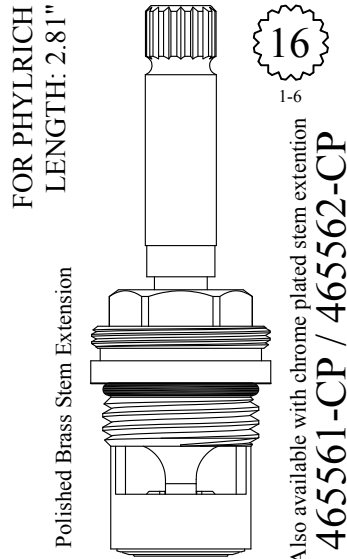

GASKET: 890170 O-RING INCLUDED  
 SEAL: 898510-W  
 DISC SET: 151380-PKG

LF465561  
 LF465562

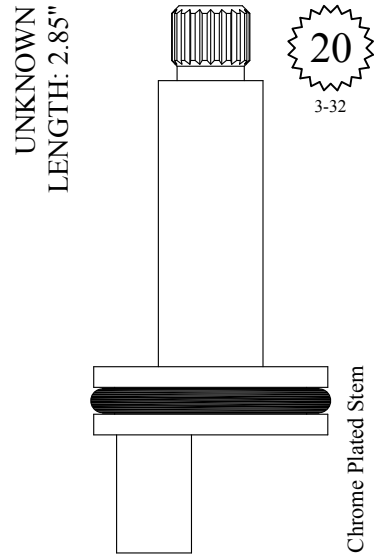

231090

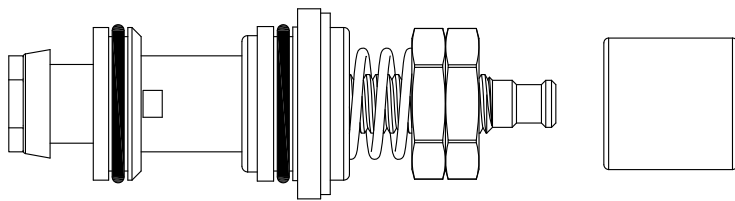

LF128000

FOR METCRAFT  
 LENGTH: 2.85"

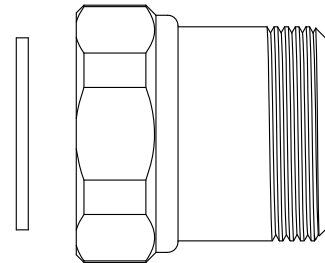



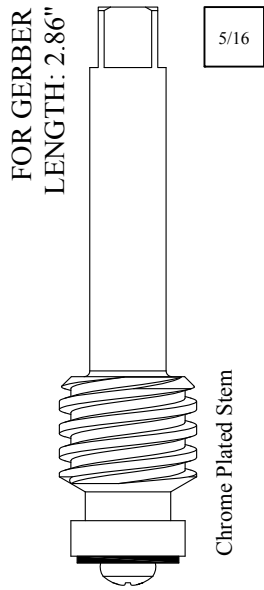

LF266211  
LF266212

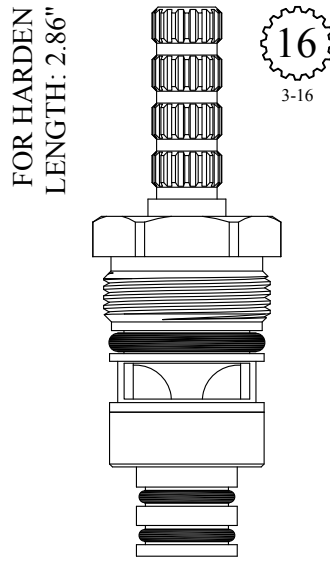

GASKET: 891140 O-RING INCLUDED  
DISC SET: 151380-PKG

LF465401  
LF465402

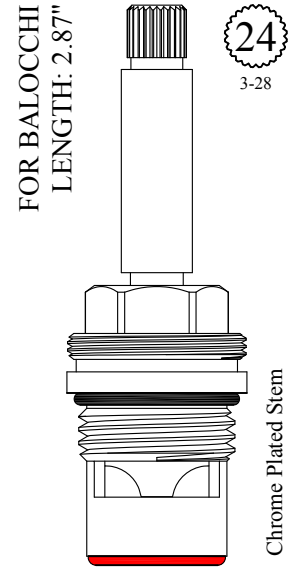

GASKET: 890170 O-RING INCLUDED  
SEAL: 898570-R/B  
DISC SET: 151380-PKG

LF465341  
LF465342

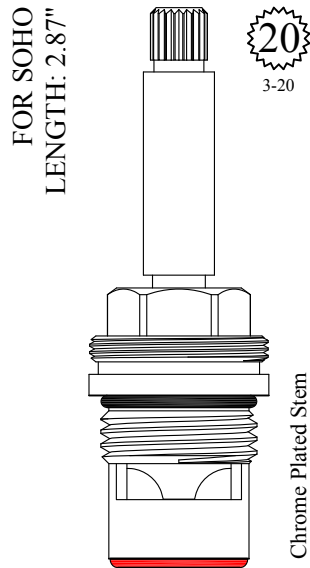

GASKET: 890170 O-RING INCLUDED  
SEAL: 898570-R/B  
DISC SET: 151380-PKG

LF465371  
LF465372

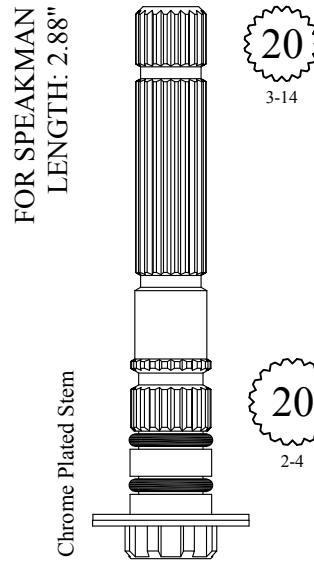

201510

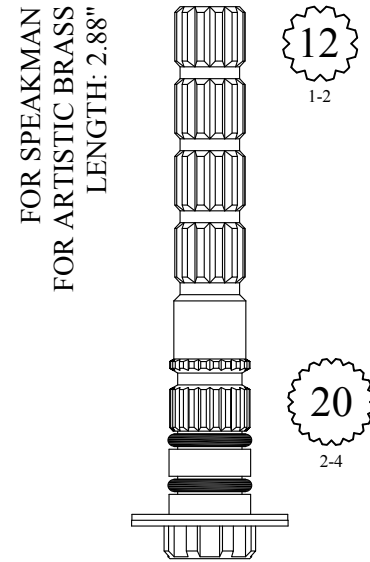

201540

FOR SPEAKMAN  
LENGTH: 2.88"

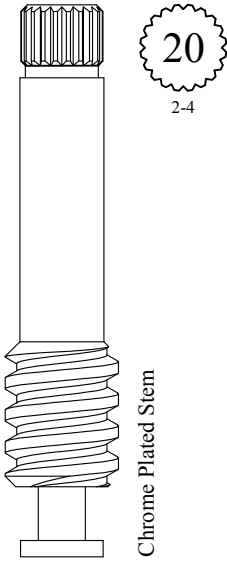

Chrome Plated Stem

201681

FOR AM STD  
LENGTH: 2.88"

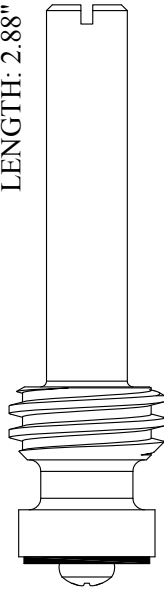

Chrome Plated Stem

265611

FOR DORNBRACHT  
LENGTH: 2.88"

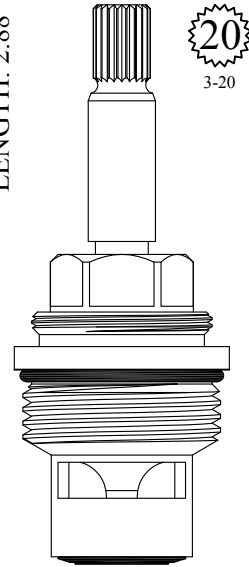

GASKET: 890210 O-RING INCLUDED  
SEAL: 898510  
DISC SET: 151380-PKG

401691  
401692

FOR ACME  
LENGTH: 2.88"

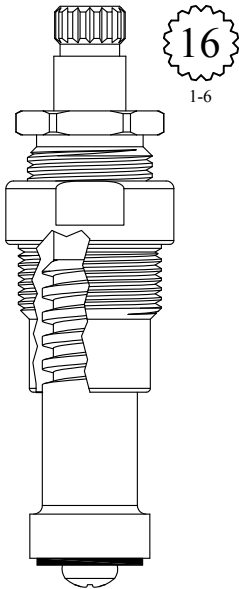

GASKET: 895100

LF465301  
LF465302

FOR SOHO  
LENGTH: 2.88"

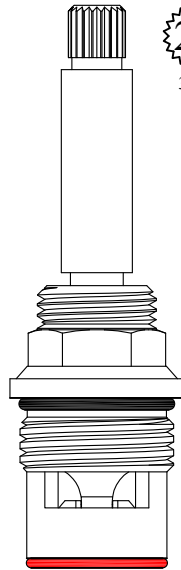

Chrome Plated Stem

GASKET: 890170 O-RING INCLUDED  
SEAL: 898580-R/B  
DISC SET: 151380-PKG

LF465351  
LF465352

Also available with polished brass stem

**LF465351-PB / LF465352-PB**

Also available with polished nickel stem

**LF465351-PN / LF465352-PN**

FOR LIBERTY  
LENGTH: 2.89"

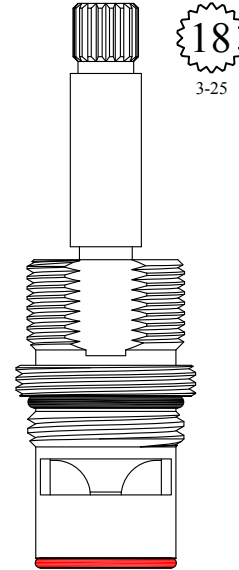

GASKET: 890170 O-RING INCLUDED  
SEAL: 898570-R/B  
DISC SET: 151380-PKG

LF465431  
LF465432

FOR STERLING FAUCET  
LENGTH: 2.89"

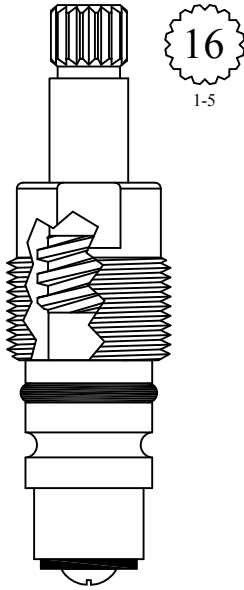

16  
1-5

LF465621  
LF465622

FOR LIBERTY  
LENGTH: 2.89"

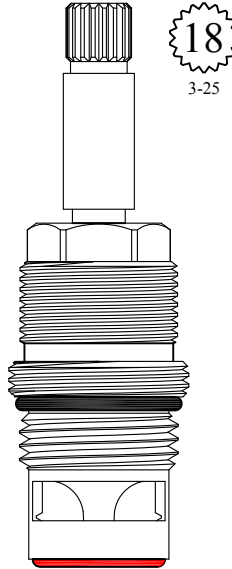

18  
3-25

GASKET: 890170 O-RING INCLUDED  
SEAL: 898570-R/B  
DISC SET: 151380-PKG

LF465711  
LF465712

FOR CRANE  
LENGTH: 2.90"

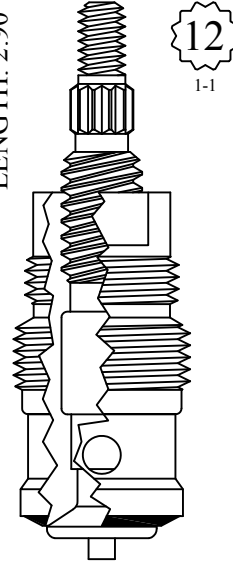

12  
1-1

GASKET: 895250

LF465121  
LF465122  
LF265121 Stem Only  
LF265122 Stem Only

FOR THG  
LENGTH 2.90"

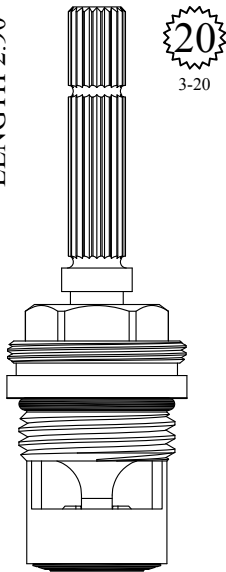

20  
3-20

GASKET: 890170 O-RING INCLUDED  
SEAL: 898510-W  
DISC SET: 151380-PKG

LF465581  
LF465582

FOR CHG  
STEM LENGTH: 2.56"

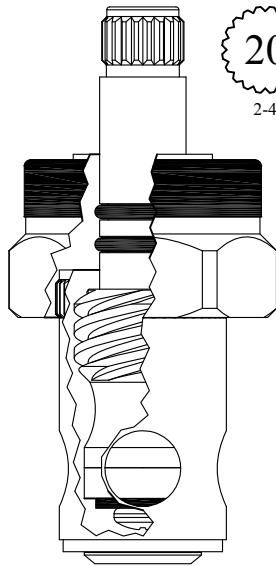

20  
2-4

Chrome Plated Stem & Bonnet

LF466481  
LF466482

UNKNOWN  
LENGTH: 2.91"

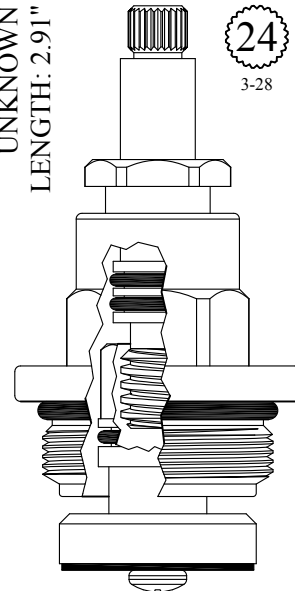

24  
3-28

GASKET: 891210 O-RING INCLUDED

401922

Chrome Plated Unit

FOR HELVIX  
LENGTH: 2.48"

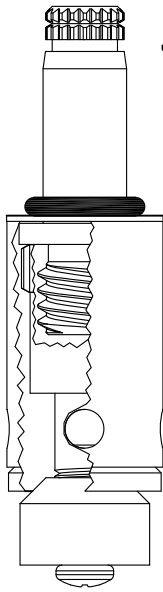

19  
1-7

Chrome Plated Stem

430992

FOR ROHL  
LENGTH: 2.91"

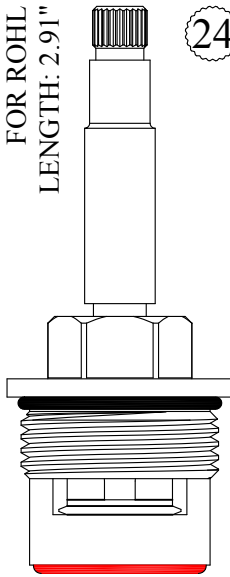

24

GASKET: 890210 O-RING INCLUDED  
SEAL: 898610-R/B  
DISC SET: 109850-PKG

401601  
401602

Extension Available  
#135000

FOR KOHLER  
LENGTH: 2.91"

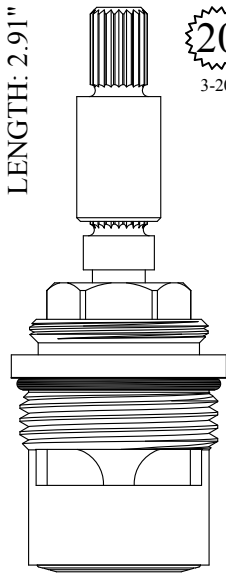

20  
3-20

GASKET: 890210 O-RING INCLUDED  
SEAL: 898520  
DISC SET: 109850-PKG

401671  
401672

FOR FEDERAL HUBER  
LENGTH: 2.91"

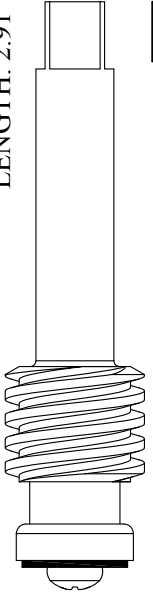

5/16

Chrome Plated Stem

LF266021  
LF266022

FOR AM STD  
LENGTH: 2.92"

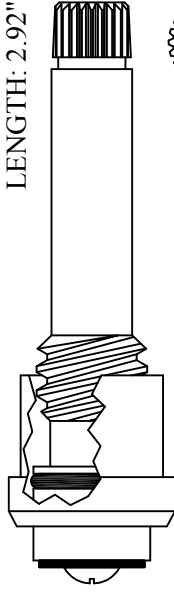

22  
1-4

Chrome Plated Stem

GASKET: 891130

LF466041  
LF466042

FOR CRANE  
LENGTH: 2.92"

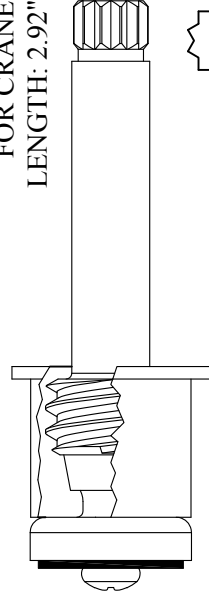

12  
3-10

Chrome Plated Stem

LF466051  
LF466052

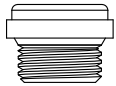

SEAT USED: LF648990

FOR AM STD  
LENGTH: 2.92"

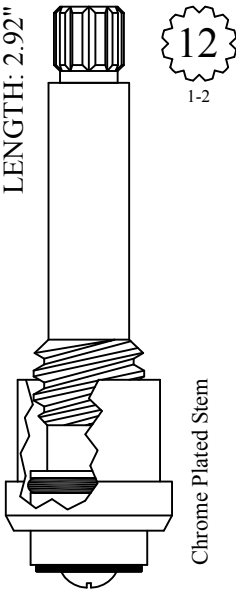

GASKET: 891130

LF466141  
LF466142

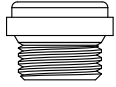

SEAT USED: LF648990

FOR ELJER  
LENGTH: 2.93"

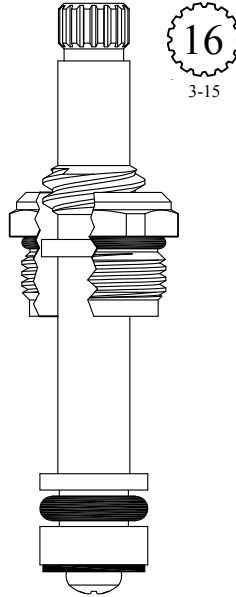

GASKET: 890160 O-RING INCLUDED

LF465801  
LF465802



SEAT USED: LF648320

FOR SPEAKMAN  
LENGTH: 2.94"

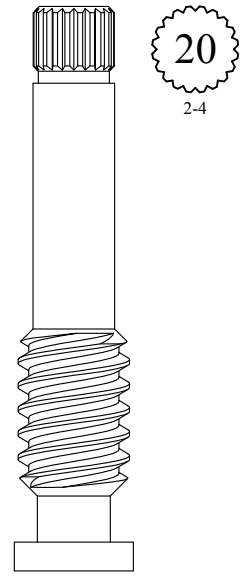

201701

IMPORT  
LENGTH: 2.94"

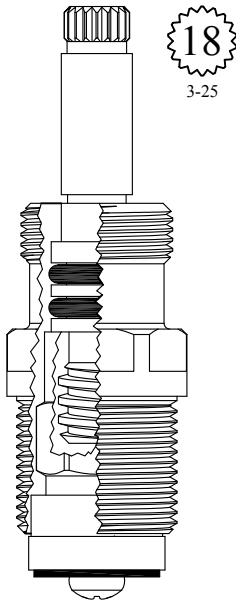

401722

IMPORT  
LENGTH: 2.94"

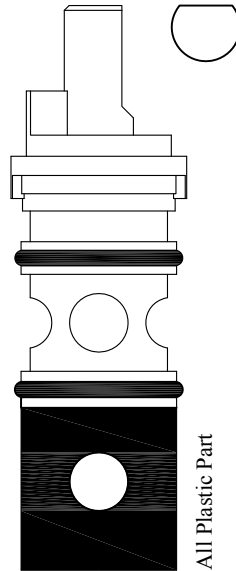

430160

FOR AM STD  
LENGTH: 2.94"

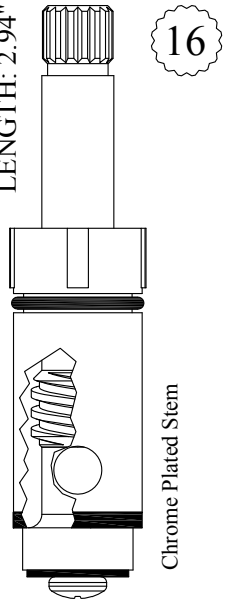

430442

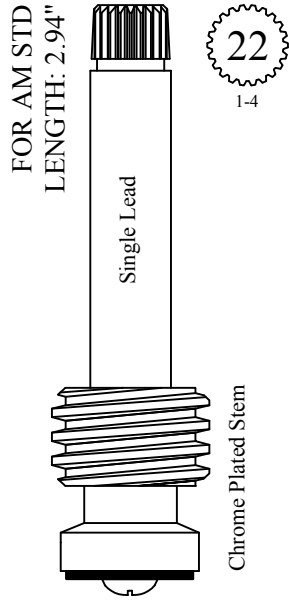

**LF266031**  
 USES BARREL:  
 LF647031

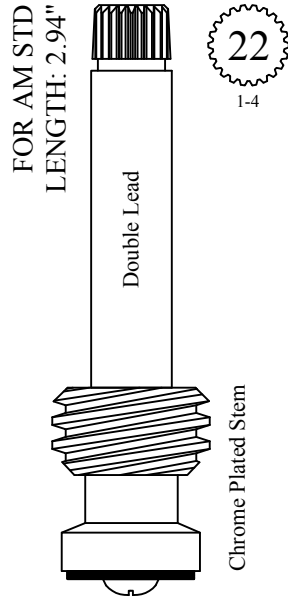

**LF266151**  
**LF266152**  
 USES BARREL:  
 LF647041/LF647042

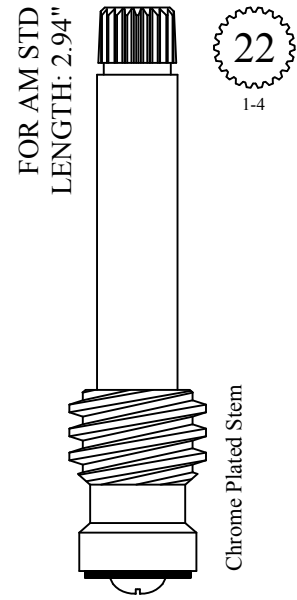

**LF266171**  
**LF266172**

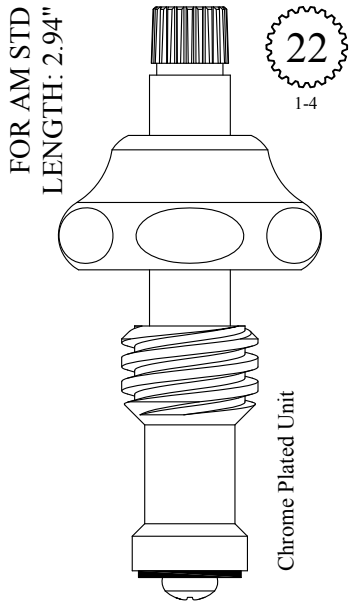

**LF466081**  
**LF266081** Stem Only

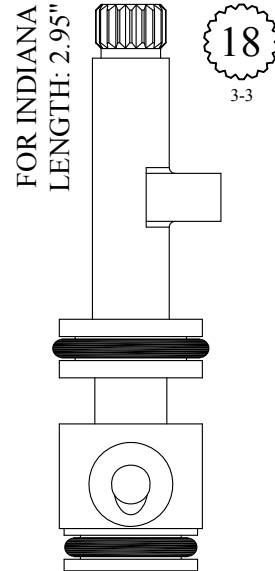

**230030**

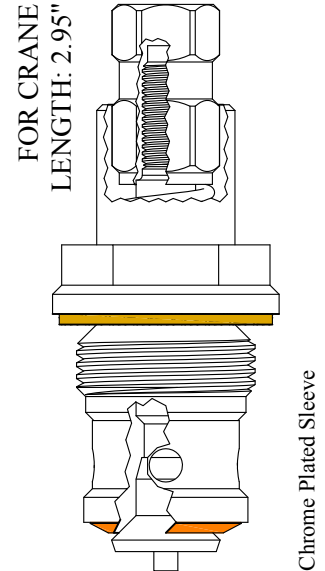

GASKET: 895250 INCLUDED

**LF465150**  
**LF265150** Stem Only

FOR CRANE  
LENGTH: 2.95"

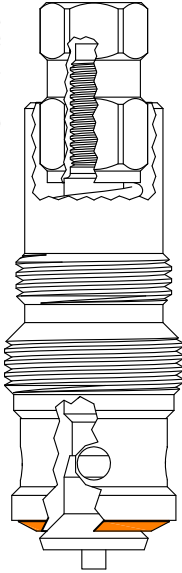

GASKET: 895250 INCLUDED

LF465160  
LF265150 Stem Only

FOR KRONIN BY VIOLA  
LENGTH: 2.94"

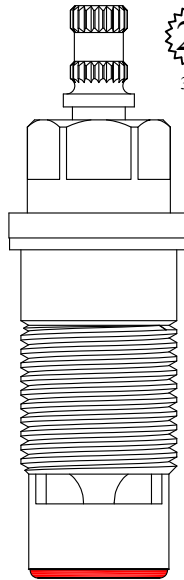

20  
3-20

GASKET: 895150 INCLUDED  
SEAL: 898570-R/B  
DISC SET: 151380-PKG

LF466251  
LF466252

FOR PHYLRICH  
LENGTH: 2.96"

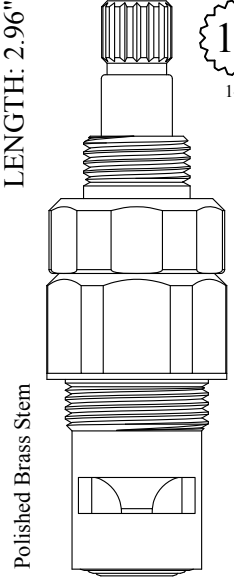

16  
1-6

GASKET: 895270 INCLUDED  
SEAL: 898500  
DISC SET: 112530-PKG

LF466201  
LF466202

Also available with Polished Chrome Stem

LF466201-CP / LF466202-CP

FOR DORF  
LENGTH: 2.97"

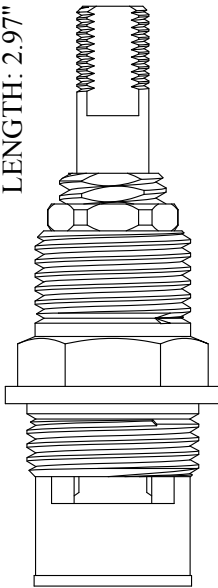

GASKET: 895370 INCLUDED  
DISC SET: 124290-PKG

LF465941  
LF465942

Also available with Chrome Plated Stem  
LF465941-CP / LF465942-CP

FOR AM STD  
LENGTH: 2.97"

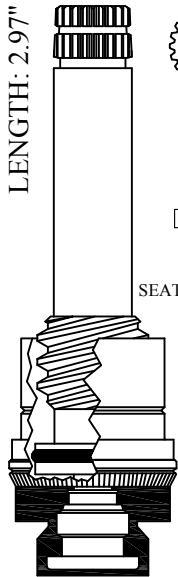

22  
1-4

SEAT USED: LF648990

Chrome Plated Stem

LF466011  
LF466012

Also available with locknut:  
LF466011-N / LF466012-N

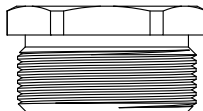

FOR STERLING FAUCET  
LENGTH: 2.97"

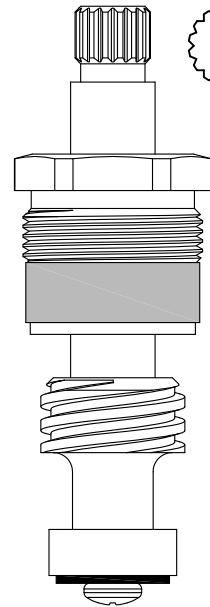

16  
1-5

LF466061  
LF466062

LF266061 Stem Only

LF266062 Stem Only



SEAT USED: LF648170

FOR SPEAKMAN  
LENGTH: 2.97"

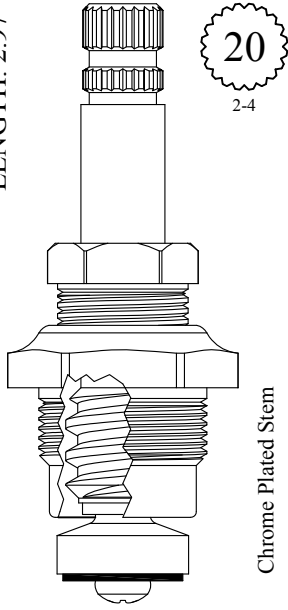

Chrome Plated Stem

GASKET: 895400

LF467171  
LF467172  
LF267171 Stem Only  
LF267172 Stem Only

FOR BRADLEY  
LENGTH: 2.98"

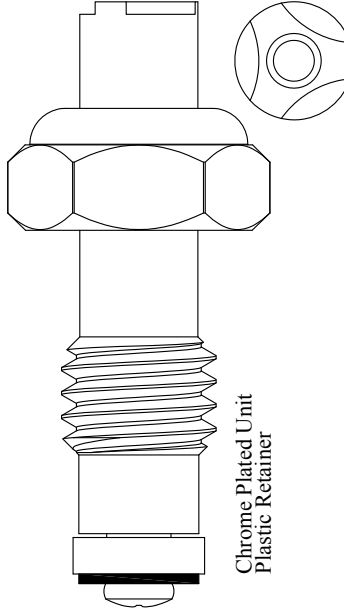

Chrome Plated Unit  
Plastic Retainer

401731  
201731 Stem Only

FOR HARCRAFT  
LENGTH: 2.98"

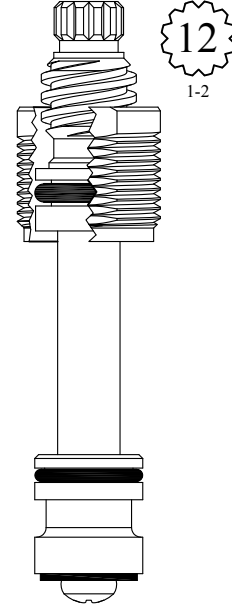

GASKET: 895040 INCLUDED

LF465411

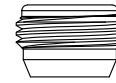

SEAT USED: LF648670

FOR AUBURN BRASS  
LENGTH: 2.98"

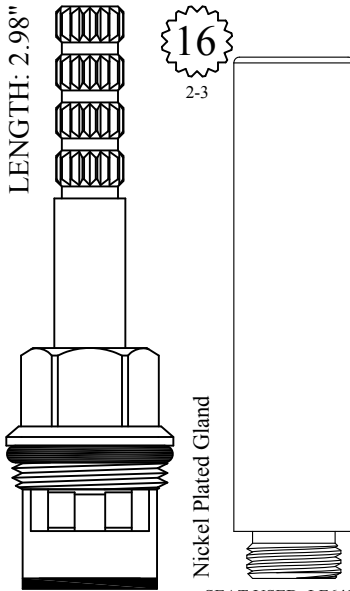

Nickel Plated Gland

SEAT USED: LF649120

GASKET: 890160 O-RING INCLUDED  
DISC SET: 151380-PKG

LF465451  
LF465452

FOR STERLING FAUCET  
LENGTH: 2.98"

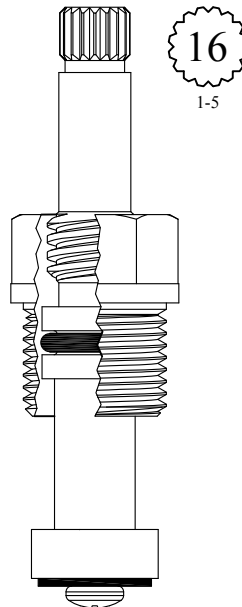

GASKET: 895100

LF465631  
LF465632

UNKNOWN  
LENGTH: 2.98"

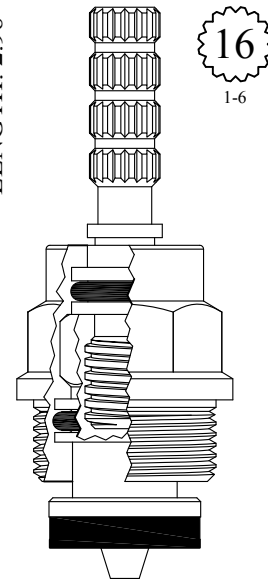

GASKET: 895330

LF465702



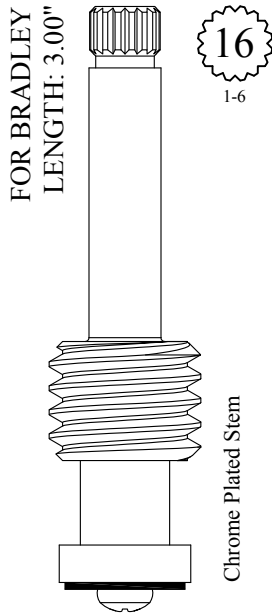

201841

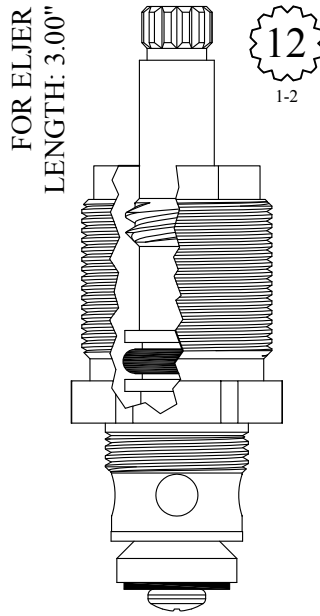

GASKET: 895100

430271

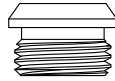

SEAT USED: LF648320

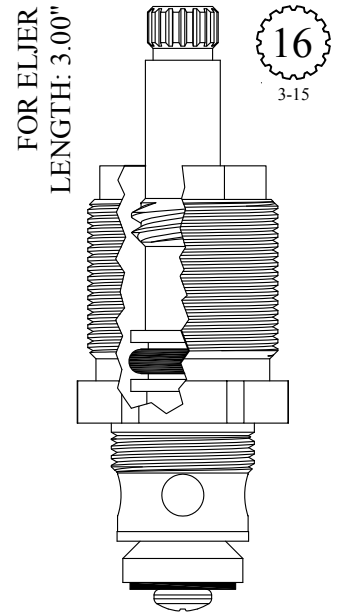

GASKET: 895100

430281

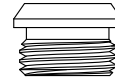

SEAT USED: LF648320

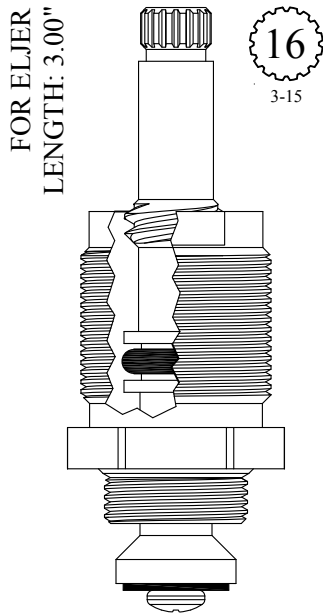

GASKET: 895100

401741

401742

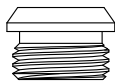

SEAT USED: LF648320

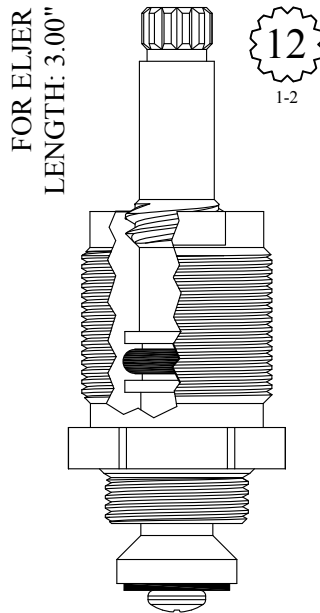

GASKET: 895100

401791

401792

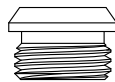

SEAT USED: LF648320

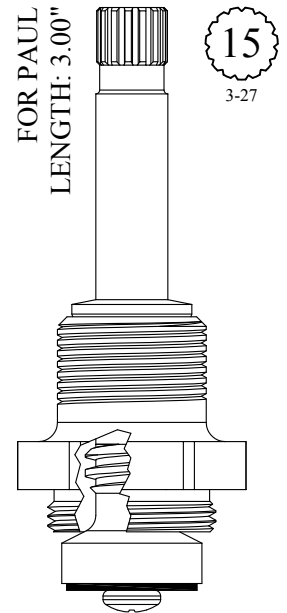

GASKET: 895400

401861

401862

201861 Stem Only

201862 Stem Only

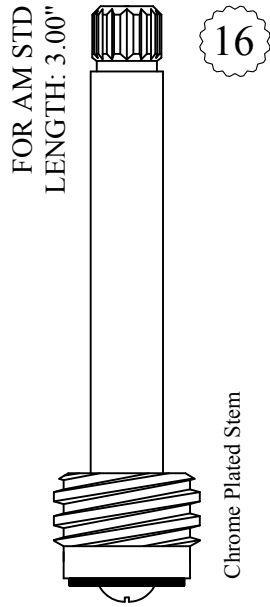

LF266071  
LF266072

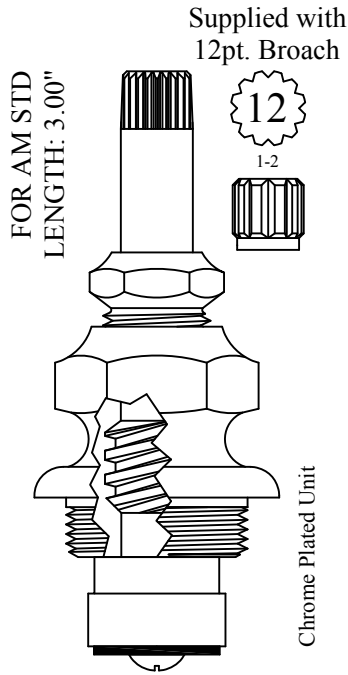

LF466301

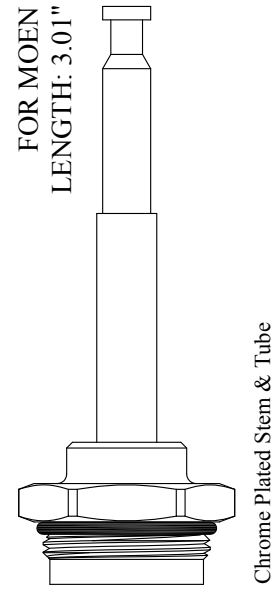

GASKET: 890190 O-RING INCLUDED  
430450

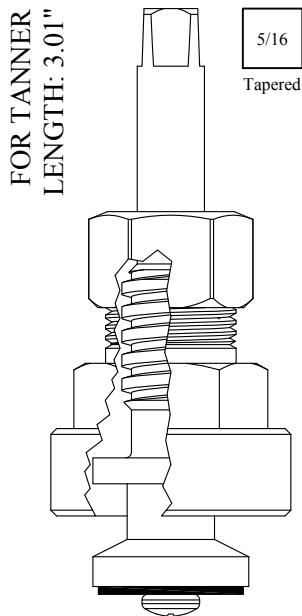

GASKET: 894860 INCLUDED  
466341

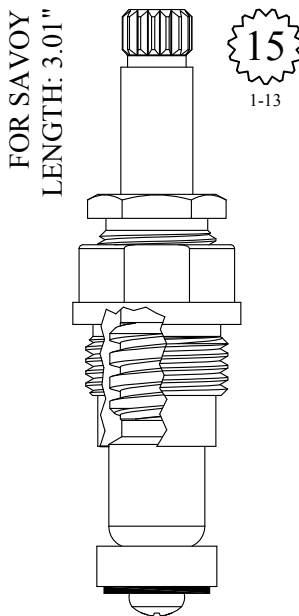

GASKET: 895100  
LF465211  
LF465212

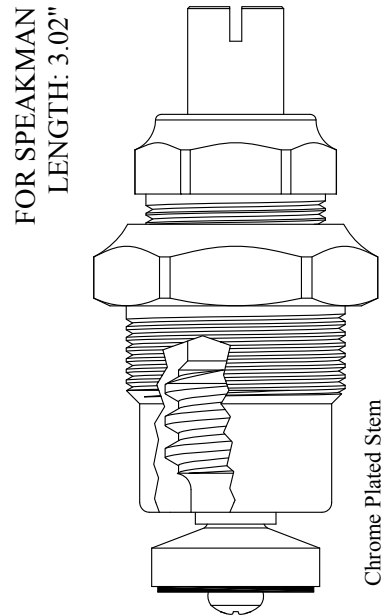

GASKET: 895450  
402071  
202071 Stem Only

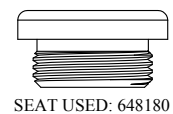

FOR PRICE PFISTER  
LENGTH: 3.00"

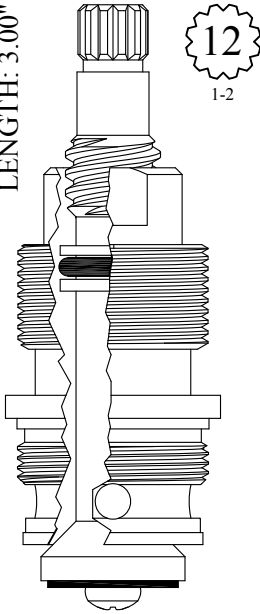

12  
1-2

GASKET: 895550

430071-NS



SEAT USED: 648370

FOR PRICE PFISTER  
LENGTH: 3.02"

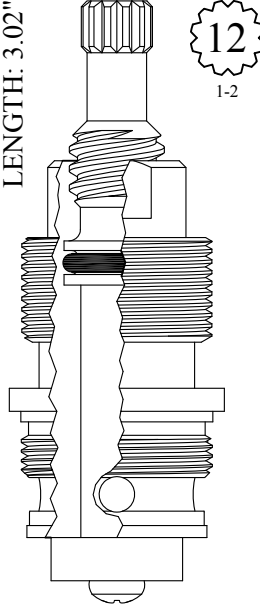

12  
1-2

GASKET: 895550

430071



SEAT USED: 648370

FOR MICHIGAN BRASS  
LENGTH: 3.03"

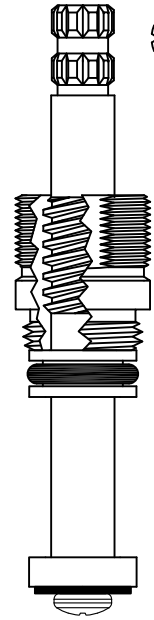

12  
3-5

LF466101  
LF466102



SEAT USED: LF648210

FOR STERLING FAUCET  
LENGTH: 3.03"

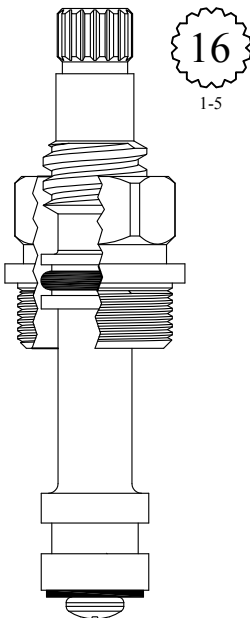

16  
1-5

GASKET: 895160

LF466111  
LF466112



SEAT USED: LF648170

FOR REID WATSON  
LENGTH: 3.04"

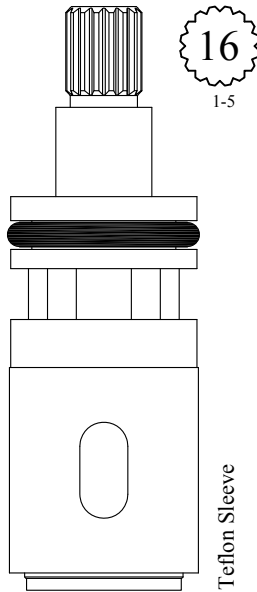

16  
1-5

Teflon Sleeve

230470

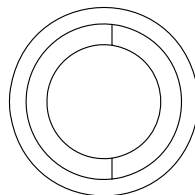

FOR T & S  
LENGTH: 3.04"

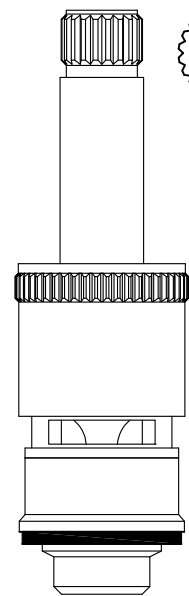

20  
2-4

Nickel Plated Stem

SEAL: 898510  
DISC SET: 151380-PKG

LF466401  
LF466402

FOR PRICE PFISTER  
LENGTH: 3.04"

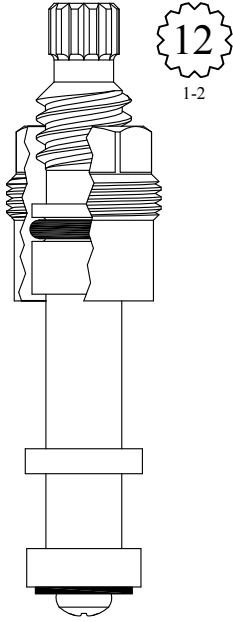

GASKET: 895060

LF467051  
LF467052

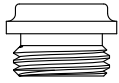

SEAT USED: LF648270

FOR POWERS  
LENGTH: 3.05"

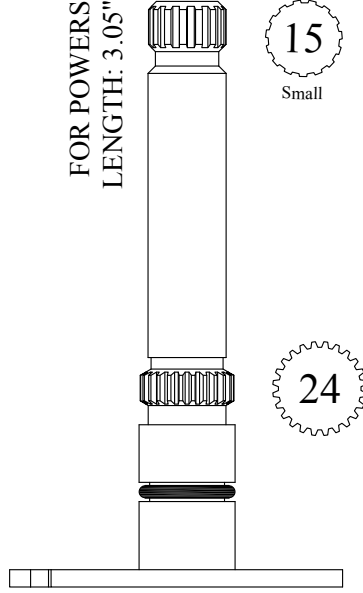

Chrome Plated Stem

201870

FOR KOHLER  
LENGTH: 3.05"

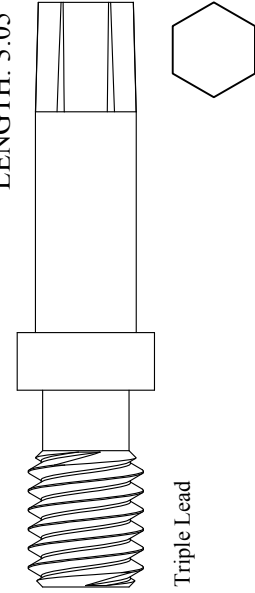

Triple Lead

202171

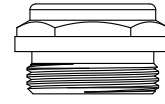

SEAT USED: 647220

FOR ARMONIA  
LENGTH: 3.23"

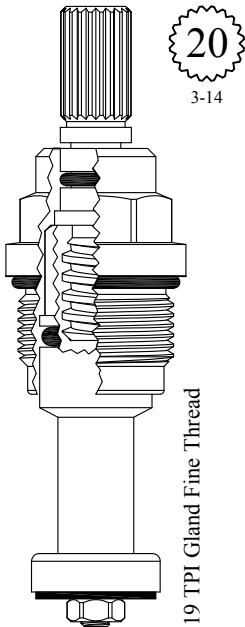

19 TPI Gland Fine Thread

GASKET: 890180 O-RING INCLUDED

401822

FOR PRICE PFISTER  
LENGTH: 3.05"

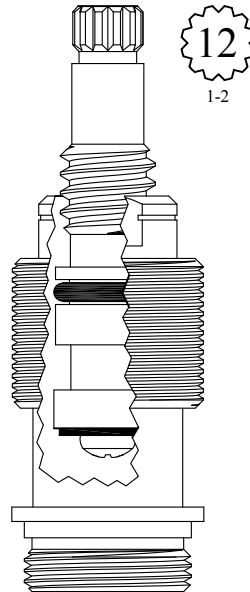

GASKET: 895400

402311

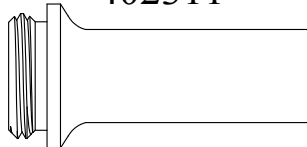

SEAT USED: 648290

FOR BARNES  
LENGTH: 3.05"

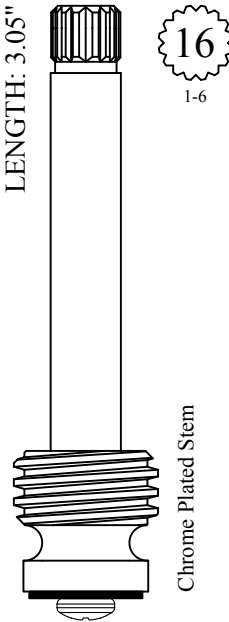

Chrome Plated Stem

LF266121  
LF266122

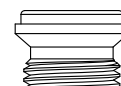

SEAT USED: LF648350

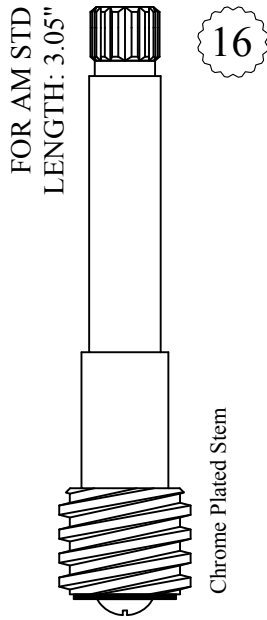

LF267021  
LF267022

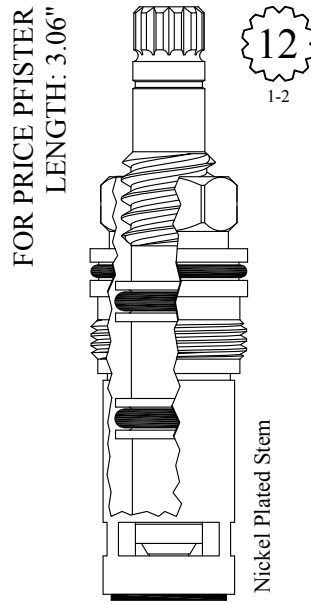

LF467301  
LF467302

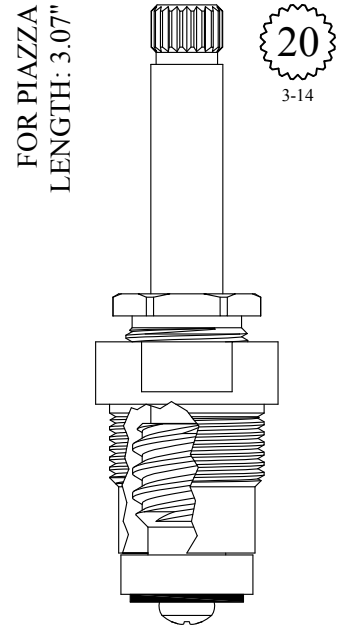

401811

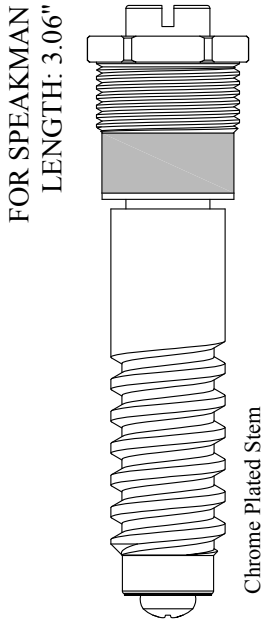

401901  
201901 Stem Only

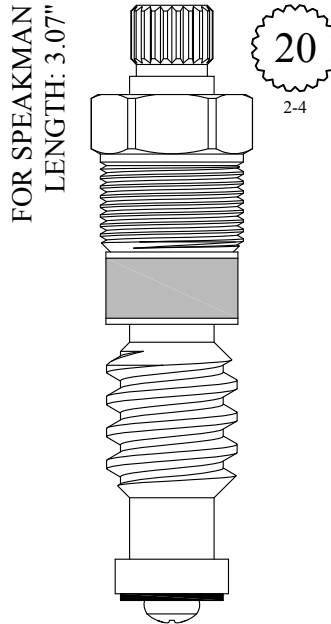

402201  
202201 Stem Only

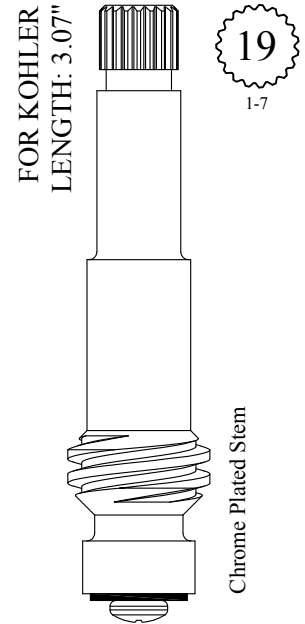

LF265651  
LF265652



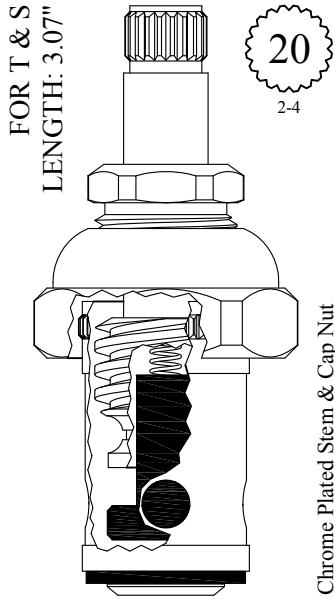

LF464181  
LF464182  
LF264181 Stem W/ Spring  
LF264182 & Retainer  
LF118481 Stem Only  
LF118482

USES BARREL:  
LF664061/LF664062

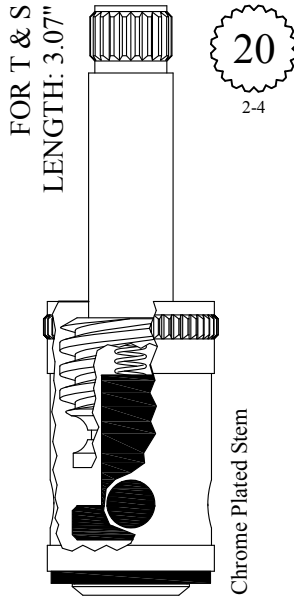

LF464181-LB  
LF464182-LB  
LF264181 Stem W/ Spring  
LF264182 & Retainer

USES BARREL:  
LF664061/LF664062

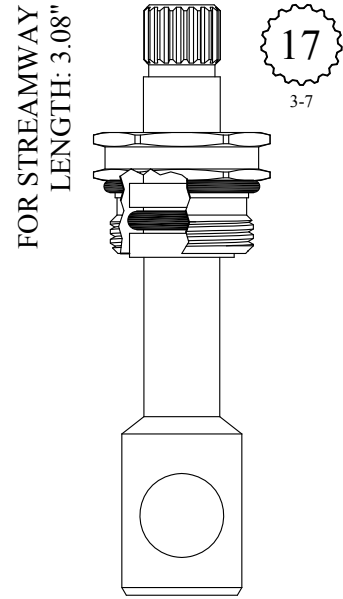

GASKET: 890170 O-RING INCLUDED

430050  
230050 Stem Only

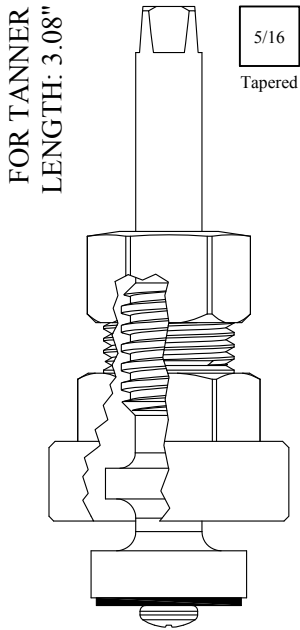

GASKET: 894860 INCLUDED

466371

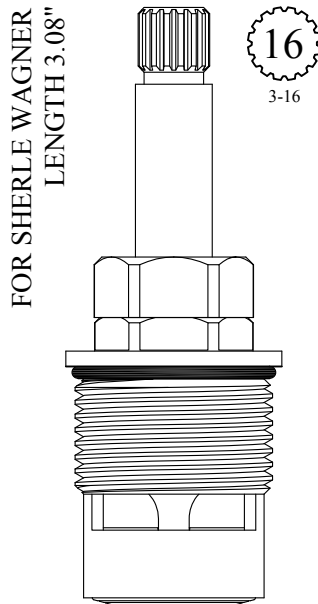

GASKET: 890210 O-RING INCLUDED  
SEAL: 898520  
DISC SET: 109850-PKG

401881  
401882

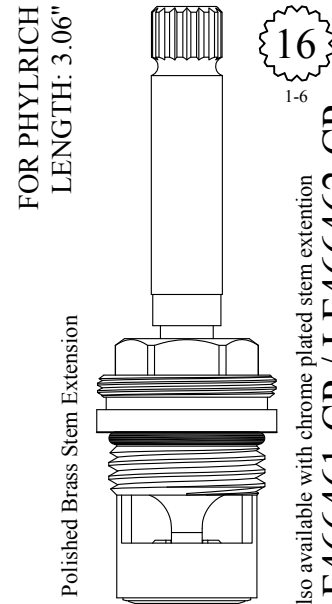

GASKET: 890170 O-RING INCLUDED  
SEAL: 898510-W  
DISC SET: 151380-PKG

LF466461  
LF466462

Individual items available  
Stem Ext. 1-1/2": #121860-PB  
& 121860-CP  
Ext. Adap. Screw: #103310

Also available with chrome plated stem extension  
LF466461-CP / LF466462-CP

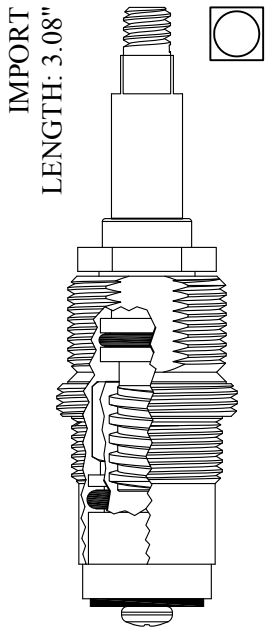

IMPORT  
LENGTH: 3.08"

GASKET: 895160

LF466532

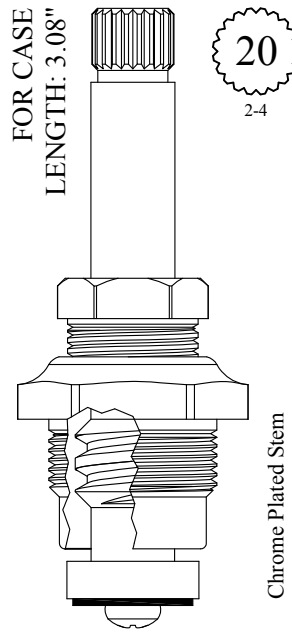

FOR CASE  
LENGTH: 3.08"

2-4

Chrome Plated Stem

GASKET: 895290

LF467401

LF467402

LF267401 Stem Only

LF267402 Stem Only

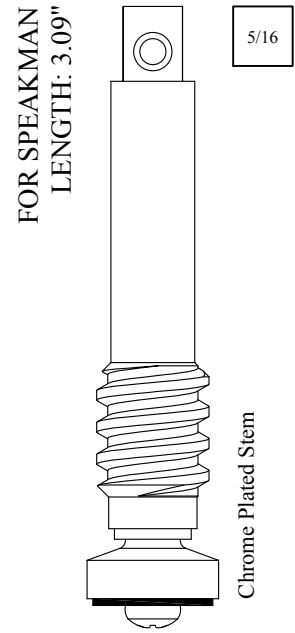

FOR SPEAKMAN  
LENGTH: 3.09"

5/16

Chrome Plated Stem

LF267521

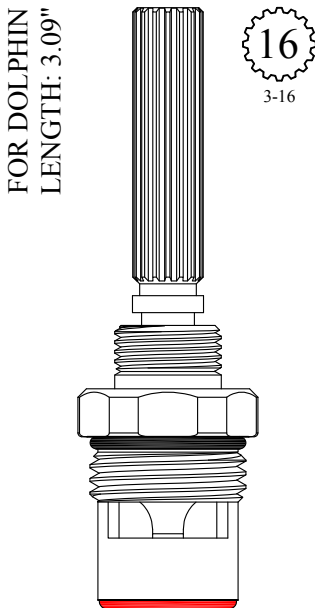

FOR DOLPHIN  
LENGTH: 3.09"

3-16

GASKET: 890170 O-RING INCLUDED  
SEAL: 898570-R/B  
DISC SET: 151380-PKG

LF466421

LF466422

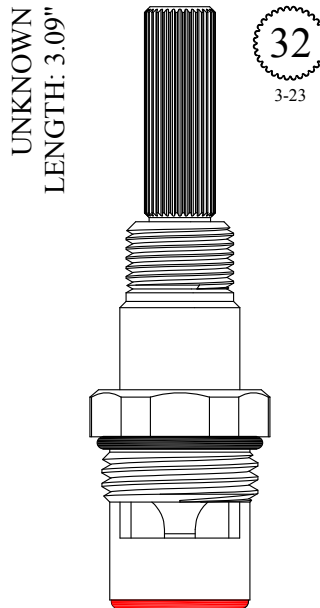

UNKNOWN  
LENGTH: 3.09"

3-23

GASKET: 890170 O-RING INCLUDED  
SEAL: 898570-R/B  
DISC SET: 151380-PKG

LF466441

LF466442

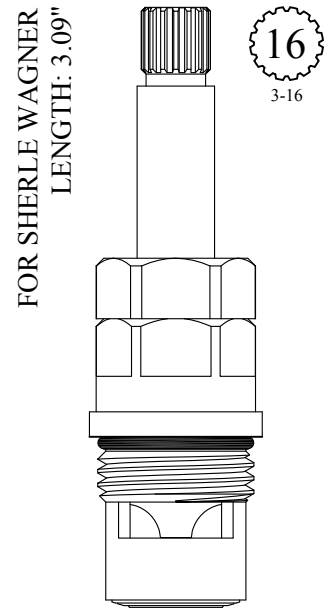

FOR SHERLE WAGNER  
LENGTH: 3.09"

3-16

GASKET: 890170 O-RING INCLUDED  
SEAL: 898510-W  
DISC SET: 151380-PKG

LF466521

LF466522

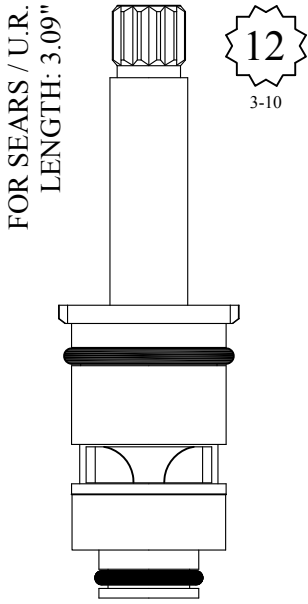

DISC SET: 151380-PKG

LF467031  
LF467032

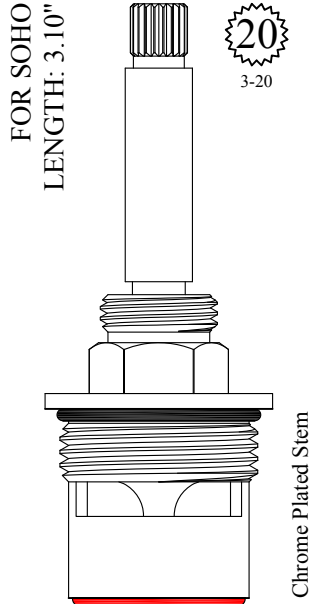

GASKET: 890170 O-RING INCLUDED  
SEAL: 898610-R/B  
DISC SET: 109850-PKG

402351  
402352

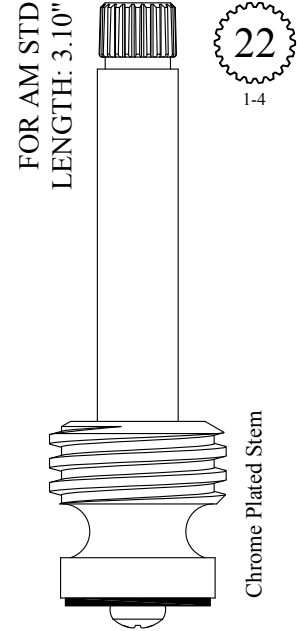

LF266381  
LF266382

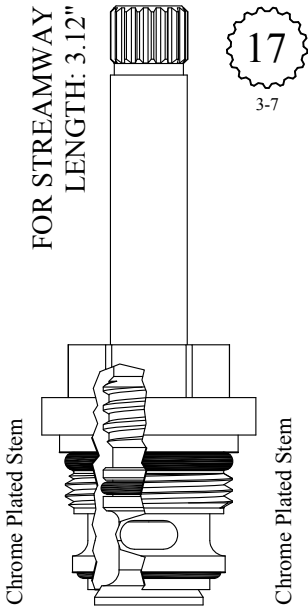

GASKET: 891150 O-RING INCLUDED

401832

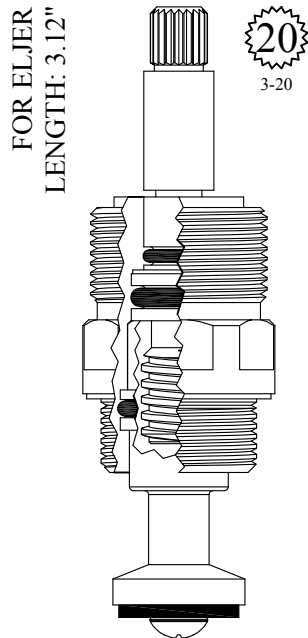

GASKET: 895160 INCLUDED

402012

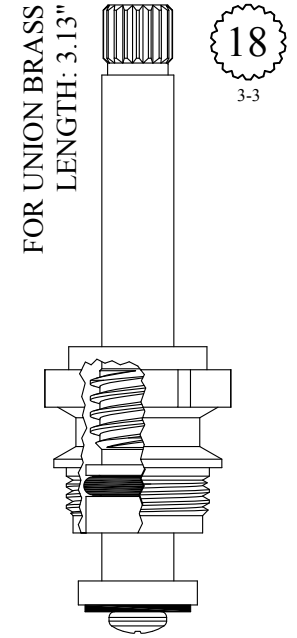

GASKET: 895100

402001  
402002

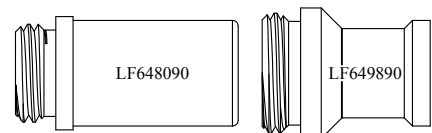

SEATS USED: LF648090 or LF649890



Also available less bonnet  
**LF466490**

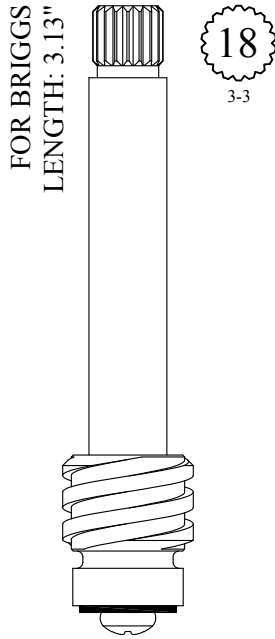

**LF267061**  
**LF267062**

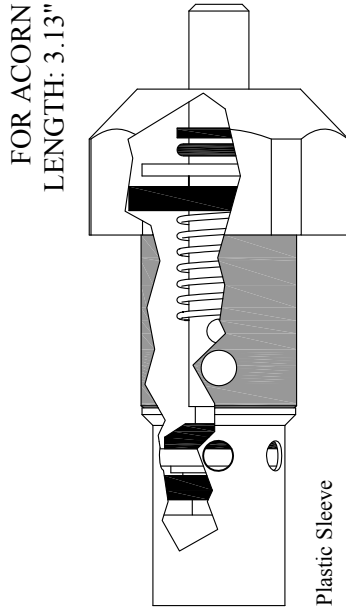

**LF466500**

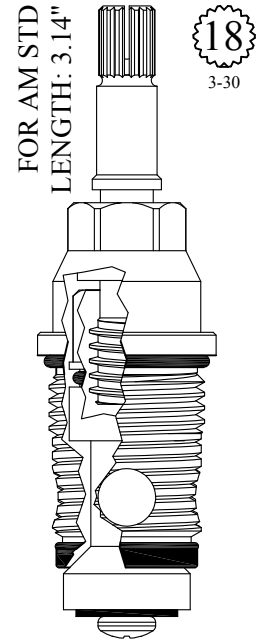

GASKET: 890170 O-RING INCLUDED

**430022**

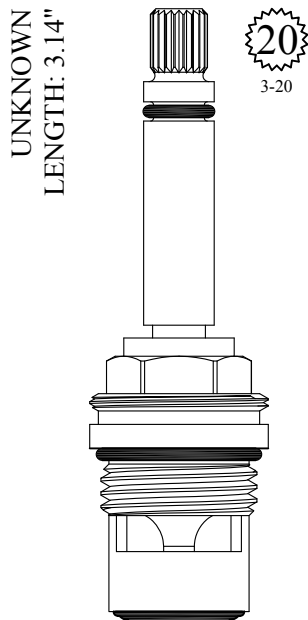

GASKET: 890170 O-RING INCLUDED  
 SEAL: 898510  
 DISC SET: 151380-PKG

**LF466921**  
**LF466922**

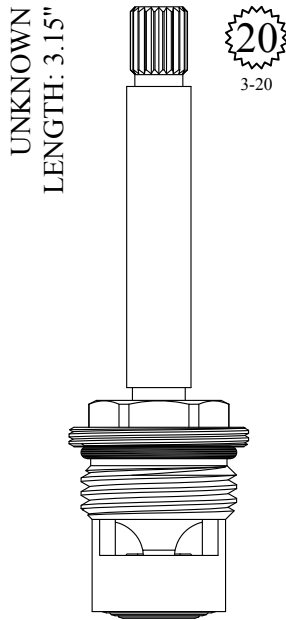

GASKET: 890170 O-RING INCLUDED  
 SEAL: 898500  
 DISC SET: 151380-PKG

**LF467381**  
**LF467382**

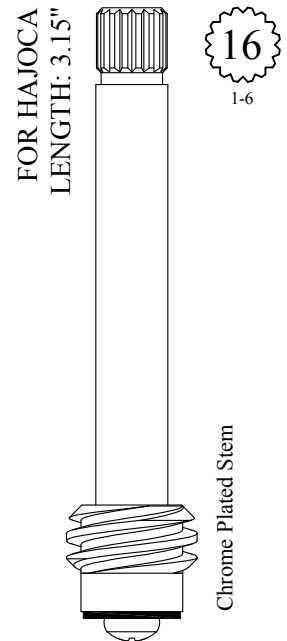

**LF266511**

FOR PRICE PFISTER  
LENGTH: 3.15"

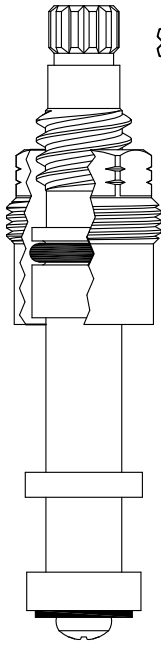

12  
1-2

GASKET: 895060

LF467251

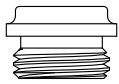

SEAT USED: LF648270

FOR TANNER  
LENGTH: 3.16"

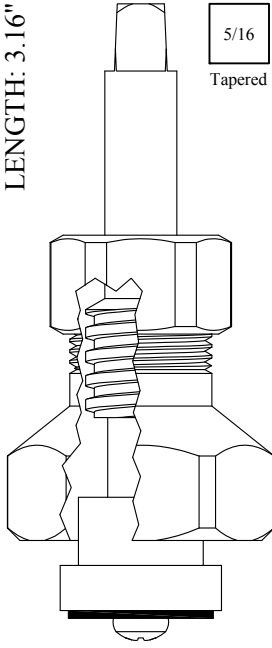

5/16  
Tapered

GASKET: 895540

466601

FOR CENTRAL  
LENGTH: 3.17"

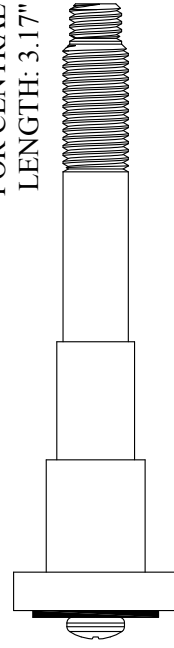

LF267150



SEAT USED: LF648790

FOR T & S  
LENGTH: 3.17"

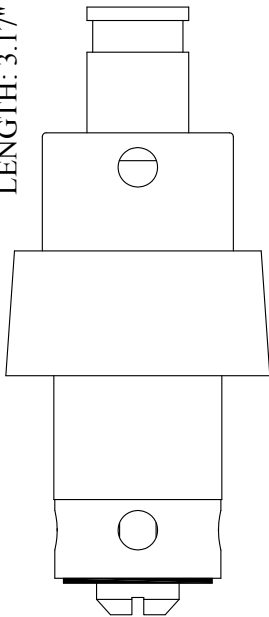

Chrome Plated Unit w/ Button

LF467210

FOR T & S  
LENGTH: 3.18"

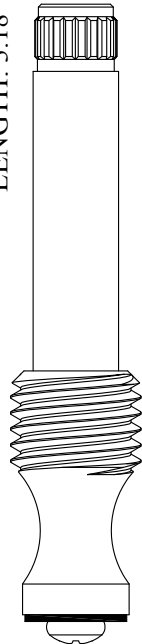

20  
2-4

Chrome Plated Stem

LF268401

FOR REID WATSON  
LENGTH: 3.19"

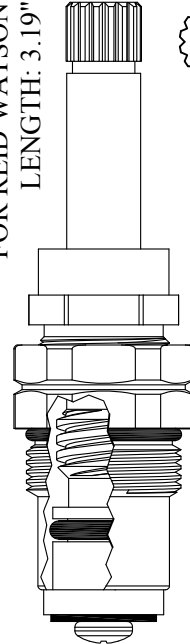

16  
1-5

GASKET: 890170 O-RING INCLUDED

LF466701  
LF466702

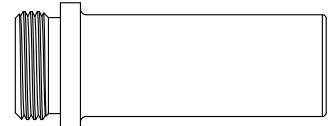

SEAT USED: LF649410

FOR JAMECO  
LENGTH: 3.20"

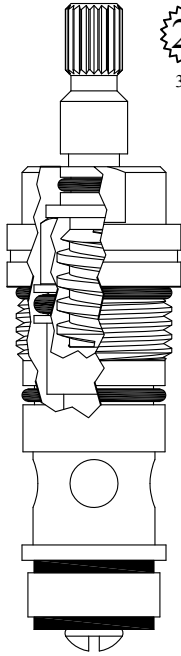

20  
3-20

GASKET: 890170 O-RING INCLUDED

430392

FOR PRICE PFISTER  
LENGTH: 3.22"

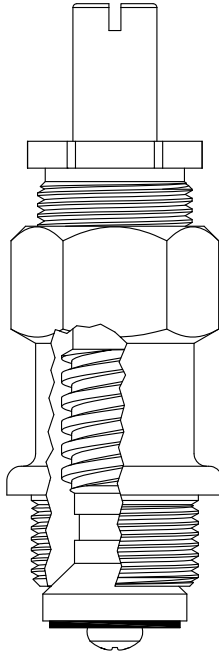

GASKET: 895400

402621

202621 Stem Only

FOR PRICE PFISTER  
LENGTH: 3.22"

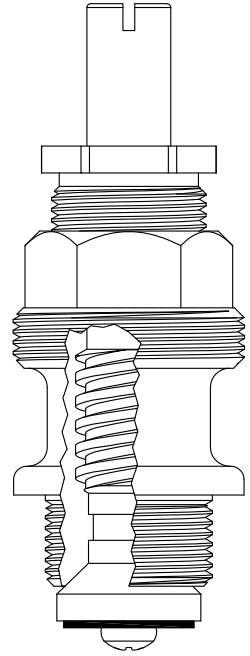

GASKET: 895400

402671

202621 Stem Only

FOR SPEAKMAN  
LENGTH: 3.22"

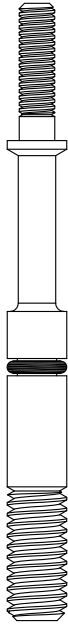

LF267140

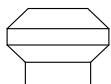

SEAT USED: 649110

FOR SPEAKMAN  
LENGTH: 3.23"

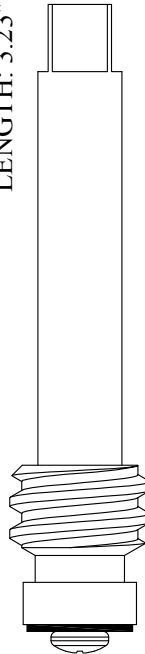

11/32

Chrome Plated Stem

LF267201

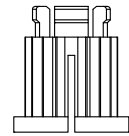

20

Comes with 20pt Grohe  
adapter: 103200

FOR DORNBRACHT  
LENGTH: 3.24"

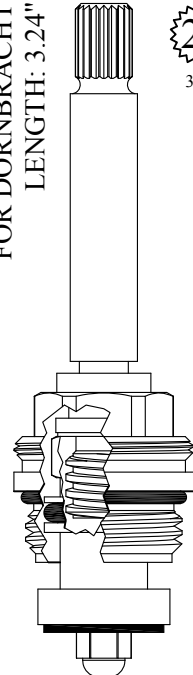

20  
3-20

GASKET: 890170 O-RING INCLUDED

402242



SEAT USED: LF647110

FOR ACORN  
LENGTH: 3.24"

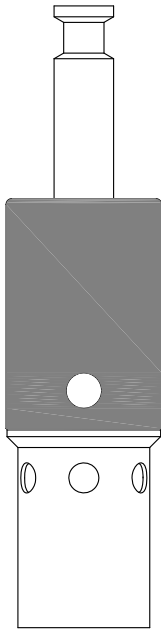

Plastic Sleeve

468490

FOR ILLINOIS  
LENGTH: 3.24"

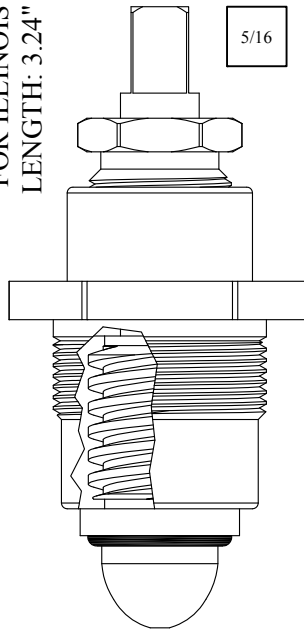

483421

UNKNOWN  
LENGTH: 3.25"

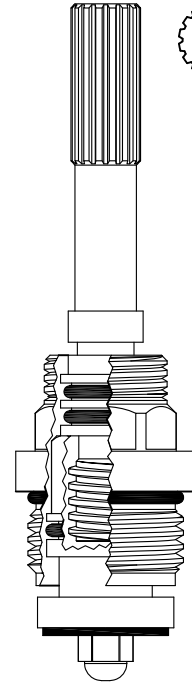

GASKET: 890170 O-RING INCLUDED

402472

FOR BRIGGS  
LENGTH: 3.25"

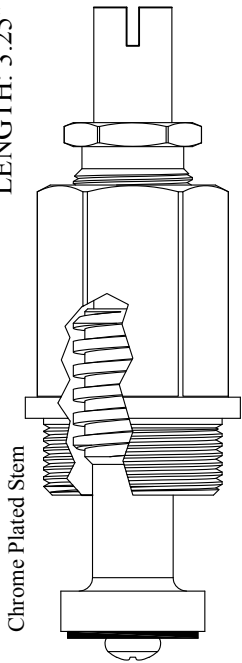

Chrome Plated Stem

GASKET: 895370

402611

202611 Stem Only

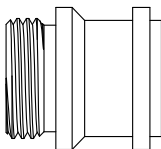

SEAT USED: 648630

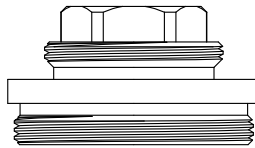

FOR I. W. INDUSTRIES  
LENGTH: 3.26"

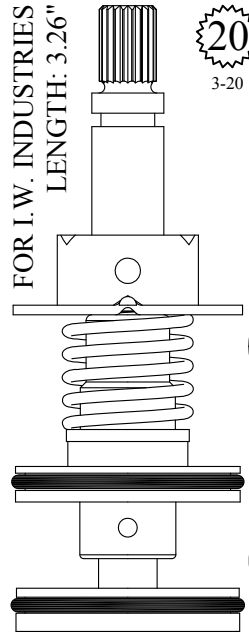

5-Port

4-Port

430560 4-Port

230560 Stem Only

430570 5-Port

230570 Stem Only

FOR AM STD  
LENGTH: 3.26"

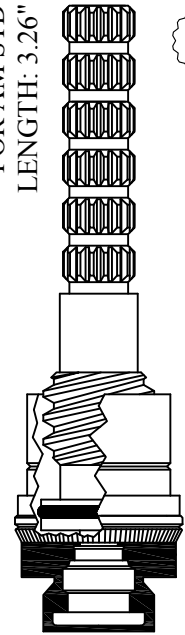

402321

402322

202321 Stem Only

202322 Stem Only

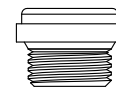

SEAT USED: LF648990

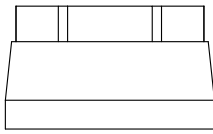

Cap Nut  
# 702510  
available

FOR UNION BRASS  
LENGTH: 3.26"

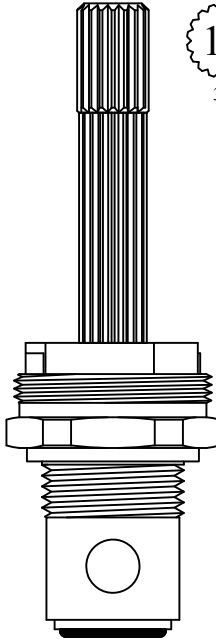

18  
3-3

GASKET: 895100  
SEAL: 898510  
DISC SET: 151380-PKG

402511  
402512

FOR ELIZABETHAN CLASSIC  
LENGTH: 3.27"

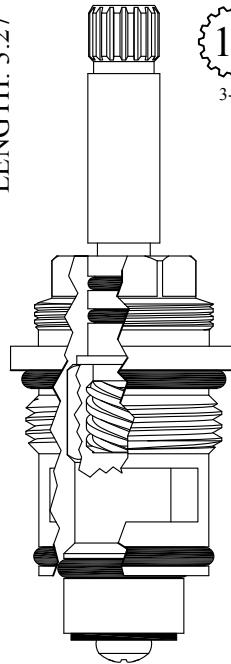

16  
3-16

Polished Brass Stem

GASKET: 890180 O-RING INCLUDED

431552

FOR HARDEN  
LENGTH: 3.27"

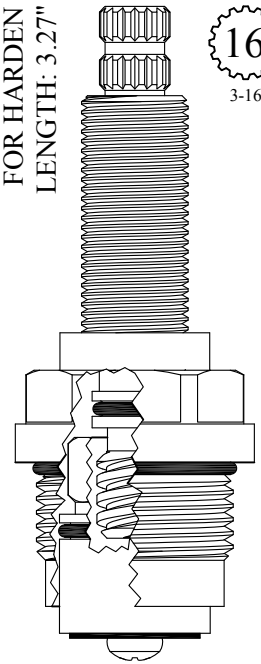

16  
3-16

GASKET: 890210 O-RING INCLUDED

402421  
402422

FOR BRIGGS  
LENGTH: 3.27"

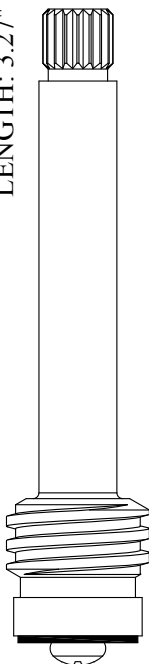

18  
3-3

Chrome Plated Stem

LF267121

FOR SPEAKMAN  
LENGTH: 3.27"

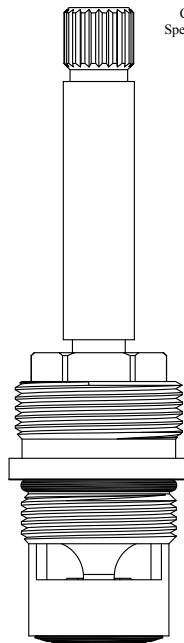

Comes with a plastic  
Speakman handle bushing  
20  
2-4

Chrome Plated Unit

GASKET: 890170 O-RING INCLUDED  
SEAL: 898510  
DISC SET: 151380-PKG

LF466901  
LF466902

FOR SPEAKMAN  
LENGTH: 3.27"

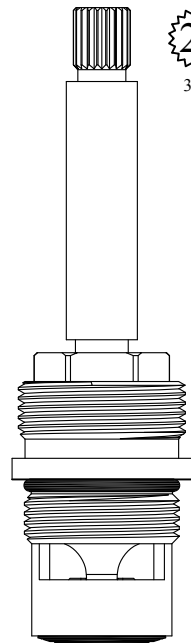

20  
3-20

Chrome Plated Unit

GASKET: 890170 O-RING INCLUDED  
SEAL: 898510  
DISC SET: 151380-PKG

LF466911  
LF466912

FOR BURLINGTON  
LENGTH: 3.27"

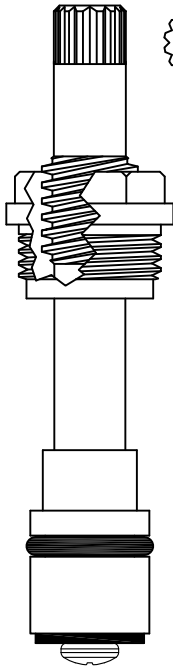

16  
1-6

GASKET: 895100

LF467071  
LF467072



SEAT USED: LF648700

FOR AM STD  
CERAMIC CONVERSION FOR  
COLONY S/V UNIT (SHORT)  
LENGTH: 3.28"

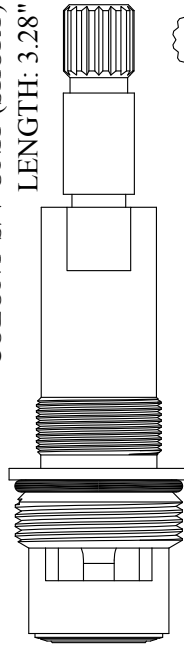

16

GASKET: 890180 O-RING INCLUDED  
SEAL: 898510  
DISC SET: 151380-PKG

402441

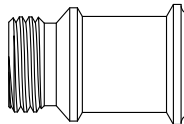

SEAT USED: 646960

FOR STERLING FAUCET  
LENGTH: 3.29"

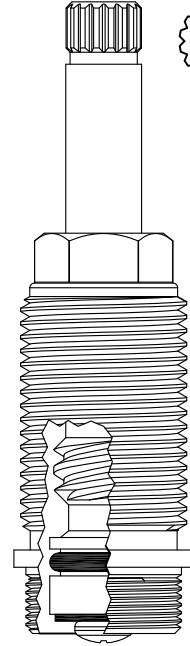

16  
1-5

GASKET: 895150

402411

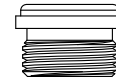

SEAT USED: LF648170

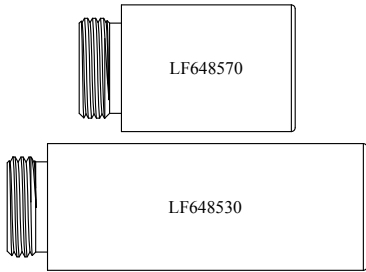

SEAT USED: LF648530 or LF648570

FOR SEARS  
LENGTH: 3.29"

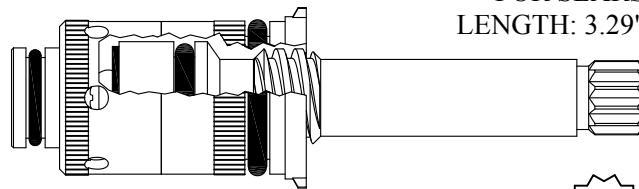

LF467041/ LF467042

12  
3-10

IMPORT  
LENGTH: 3.31"

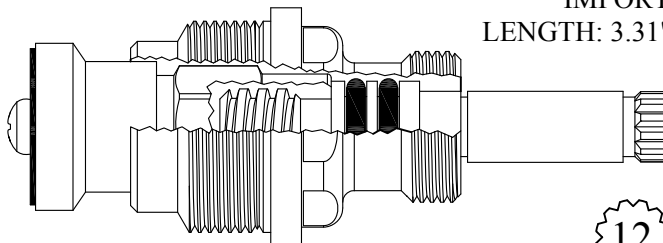

402522  
GASKET: 895450

12  
1-2

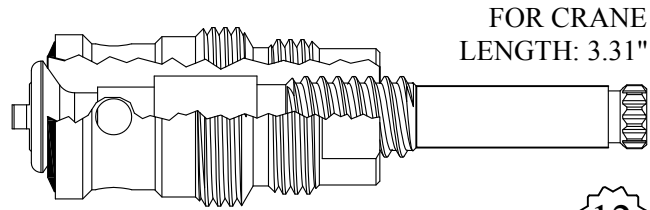

FOR CRANE  
LENGTH: 3.31"

402431/ 402432  
GASKET: 895250

12  
1-1

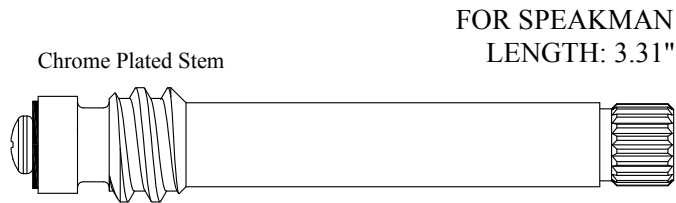

FOR SPEAKMAN  
LENGTH: 3.31"

LF267661

20  
2-4

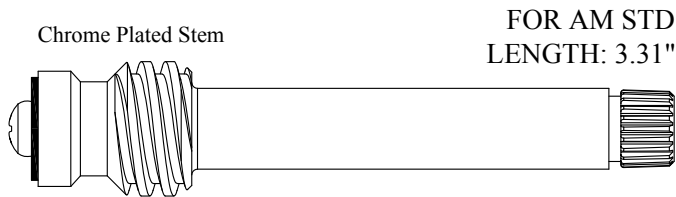

FOR AM STD  
LENGTH: 3.31"

LF268041/ LF268042

22  
1-4

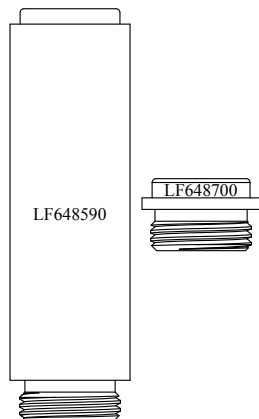

SEAT USED: LF648700 or LF648590

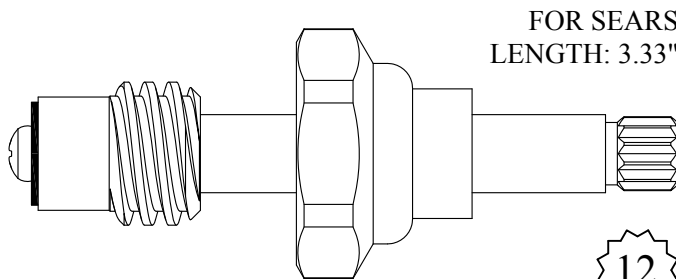

FOR SEARS  
LENGTH: 3.33"

402701/ 402702  
202701/ 202702 Stem Only

12  
3-10



Chrome Plated Stem

FOR SEARS  
LENGTH: 3.33"

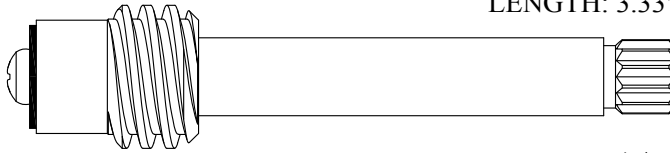

LF268011/ LF268012



Chrome Plated Unit

FOR KOHLER  
LENGTH: 3.33"

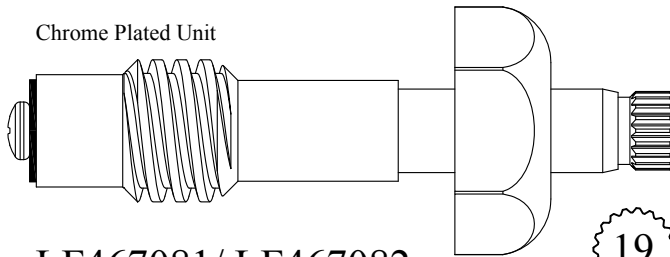

LF467081/ LF467082  
LF267081/ LF267082

Stem Only



FOR SHERLE WAGNER  
LENGTH: 3.33"

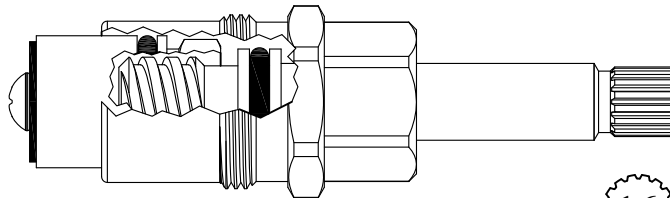

LF467501/ LF467502

GASKET: 895100



Polished Brass Stem

FOR PHYLRICH  
LENGTH: 3.33"

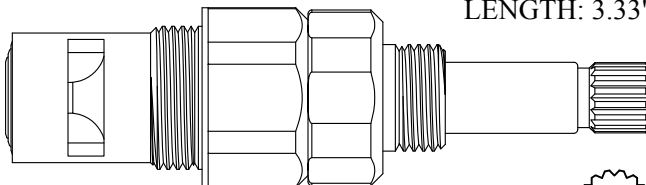

LF468101/ LF468102

GASKET: 895270 INCLUDED  
SEAL: 898500  
DISC SET: 112530-PKG



Also available with chrome plated stem  
LF468101-CP/ LF468102-CP



Plastic Retainer  
Chrome Plated Stem

FOR BRADLEY  
LENGTH: 3.34"

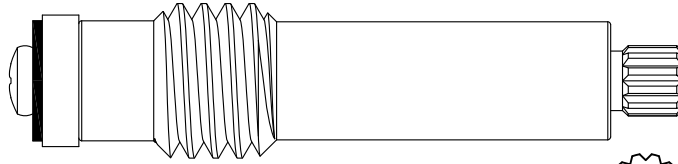

201771

12  
1-2

IMPORT  
LENGTH: 3.34"

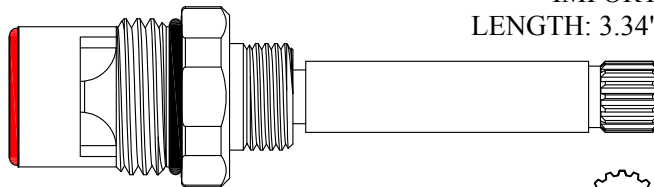

LF402681/ LF402682

GASKET: 890170 O-RING INCLUDED  
SEAL: 898570-R/B  
DISC SET: 151380-PKG

16  
3-16

Chrome Plated Stem

UNKNOWN  
LENGTH: 3.34"

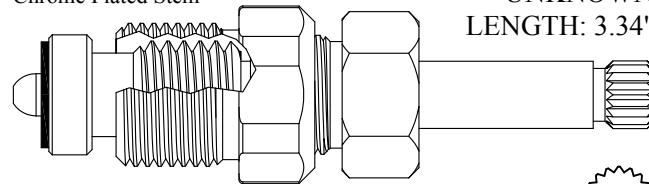

LF466811

GASKET: 895100

18  
3-25

FOR AM STD  
LENGTH: 3.34"

Chrome Plated Stem

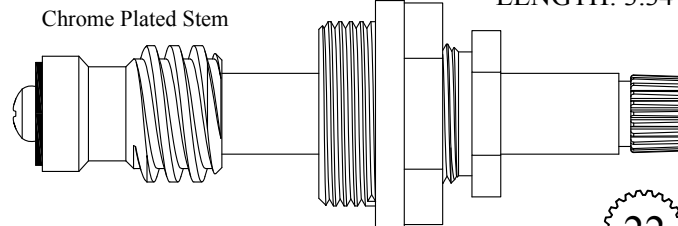

LF468261/ LF468262

LF268061/ LF268062 Stem Only

GASKET: 818010

22  
1-4

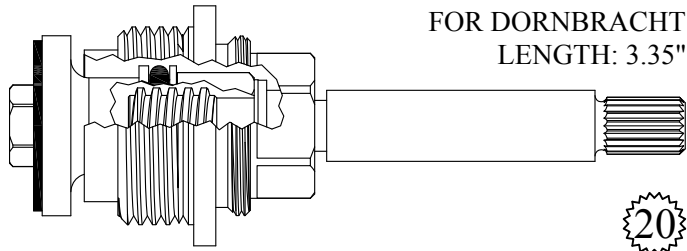
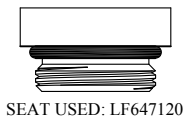

402752

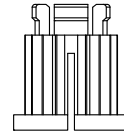

Comes with 20pt Grohe  
adapter: 103200

IMPORT  
LENGTH: 3.35"

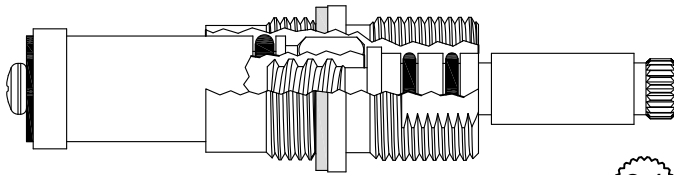

LF466822

GASKET: 895100



FOR CRANE  
LENGTH: 3.36"

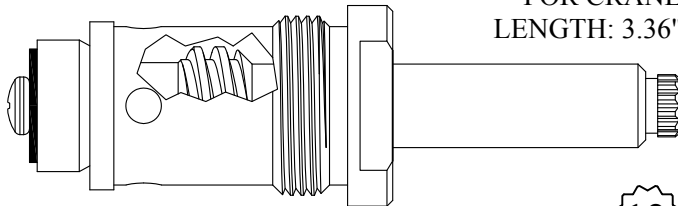

430631



Chrome Plated Stem

FOR BARNES  
LENGTH: 3.36"

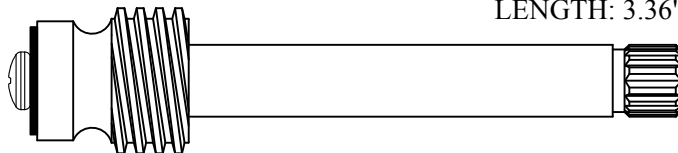

LF269121/ LF269122



Nickel Plated Stem

FOR CHICAGO  
LENGTH: 3.36"

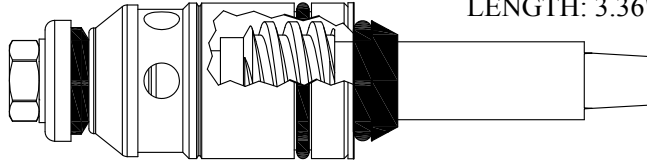

**LF467091/ LF467092** QUATURN

GASKET: 895200  
SEAT INCLUDED: 648750

Nickel Plated Stem

FOR CHICAGO  
LENGTH: 3.36"

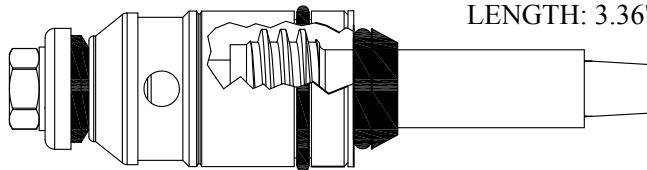

**LF467101/ LF467102** SLOW COMPRESSION

GASKET: 895200  
SEAT INCLUDED: 648750

Chrome Plated Stem

FOR ELJER  
LENGTH: 3.36"

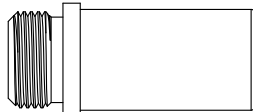

SEAT USED: LF648620

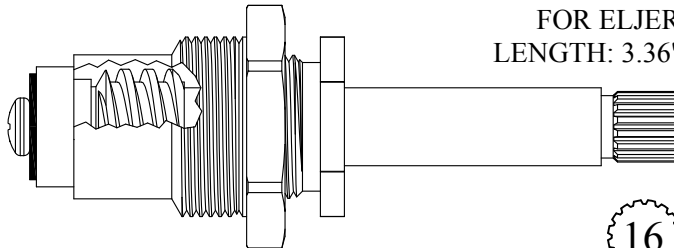

Also available with polished brass stem

**LF467111-PB**  
**LF467111-PB**  
**LF267111-PB** Stem Only  
**LF267111-PB** Stem Only



**LF467111/ LF467112**  
**LF267111/ LF267112** Stem Only

GASKET: 895330

Chrome Plated Stem

FOR SHERLE WAGNER  
LENGTH: 3.36"

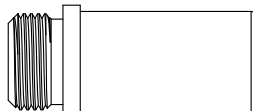

SEAT USED: LF648620

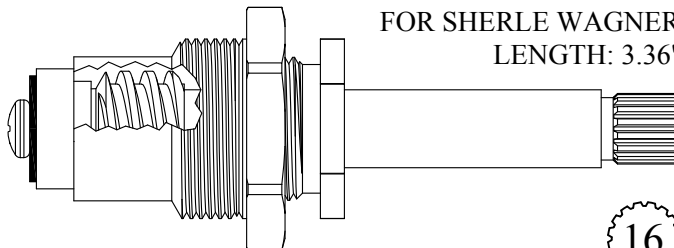

**LF467111-PB/ LF467112-PB**

GASKET: 895330

Nickel Plated Stem  
Chrome Plated Bonnet

FOR CHICAGO  
LENGTH: 3.36"

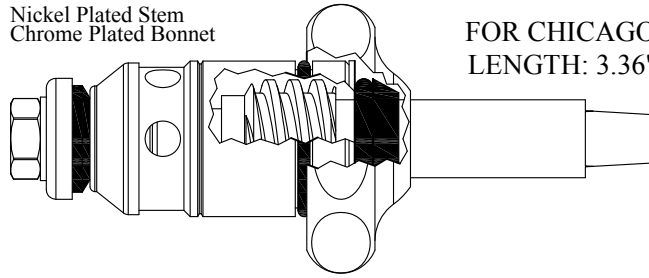

**LF467191/ LF467192** QUATURN

GASKET: 895200  
SEAT INCLUDED: 648750

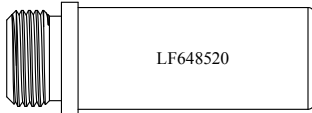

LF648520

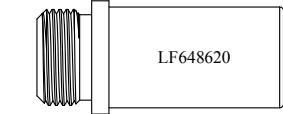

LF648620

SEAT USED: LF648520 or LF648620

Chrome Plated Stem

FOR ELJER  
LENGTH: 3.36"

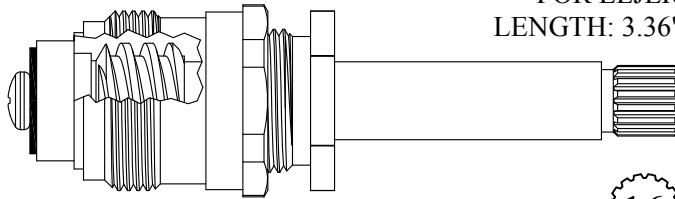

**LF467611/ LF467612**  
**LF267111/ LF267112** Stem Only

GASKET: 895120



Also available with polished brass stem

**LF467611-PB**  
**LF467611-PB**  
**LF267611-PB** Stem Only  
**LF267611-PB** Stem Only

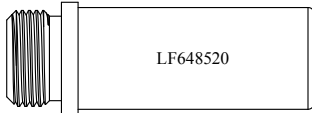

LF648520

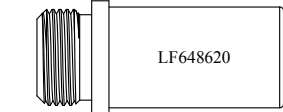

LF648620

SEAT USED: LF648520 or LF648620

Chrome Plated Stem

FOR SHERLE WAGNER  
LENGTH: 3.36"

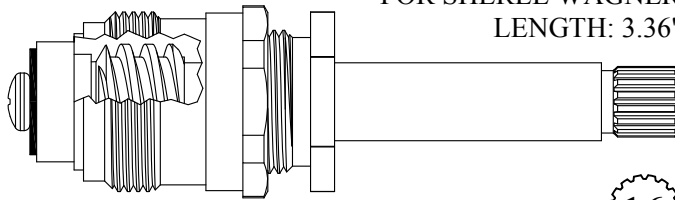

**LF467611-PB/ LF467612-PB**

GASKET: 895120



FOR POWERS  
LENGTH: 3.37"

Chrome Plated Stem



**117520**



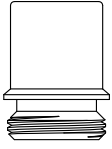

SEAT USED: LF649500

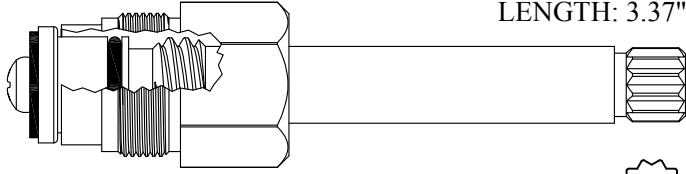

FOR MILWAUKEE  
LENGTH: 3.37"

**402591**

GASKET: 199930

12

1-1

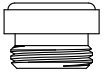

SEAT USED: LF648760

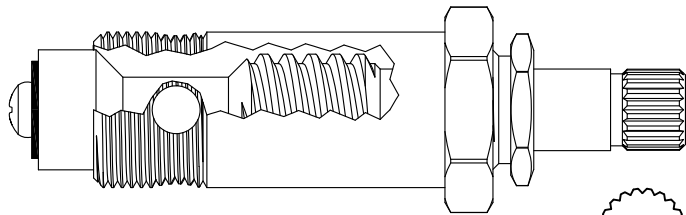

FOR SPEAKMAN  
LENGTH: 3.37"

**430111**

**230111** Stem Only

GASKET: 895160

20

2-4

Polished Brass Stem

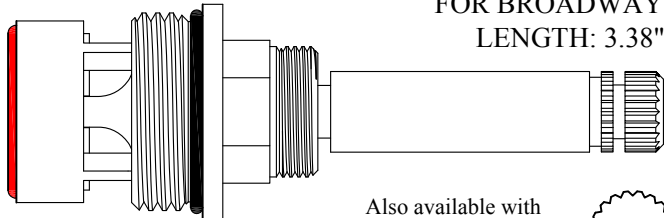

FOR BROADWAY  
LENGTH: 3.38"

**402651/ 402652**

GASKET: 890210 O-RING INCLUDED

SEAL: 898610-R/B

DISC SET: 109850-PKG

Also available with  
polished chrome stem

**402651-CP**

**402652-CP**

20

2-4

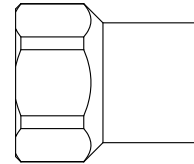

Escutcheon Nut  
# 302740  
available

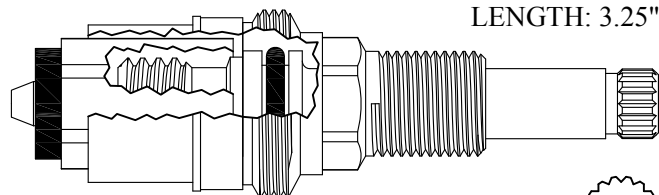

FOR LABONGE  
LENGTH: 3.25"

**LF466712**

16

1-6

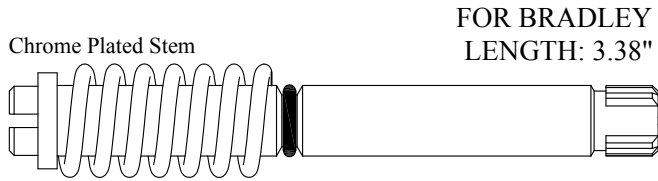

202690

Special 12pt Broach w/  
2 splines missing on each  
side to make an 8pt Broach

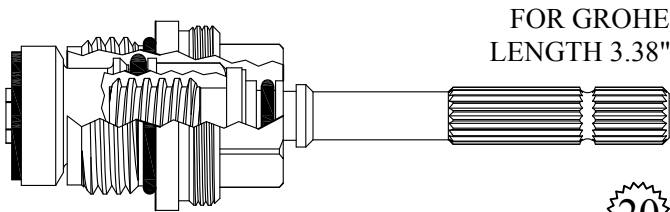

402642

GASKET: 890170 O-RING INCLUDED

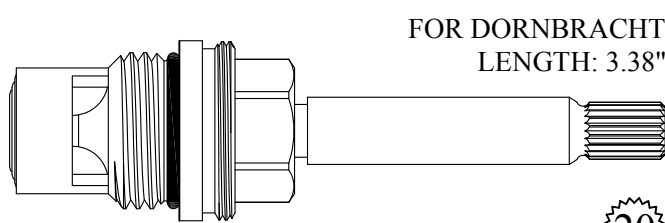

402601/ 402602

GASKET: 890170 O-RING INCLUDED  
SEAL: 898500  
DISC SET: 112530-PKG

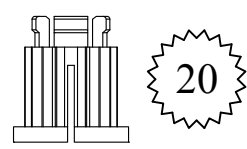

Comes with 20pt Grohe  
adapter: 103200

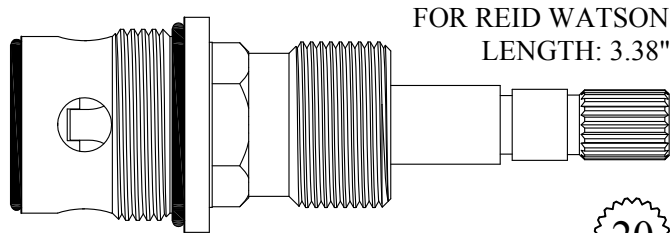

402661/ 402662

GASKET: 890210 O-RING INCLUDED  
SEAL: 898530  
DISC SET: 109850-PKG



19TPI Gland Fine Thread

FOR ARMONIA  
LENGTH: 3.52"

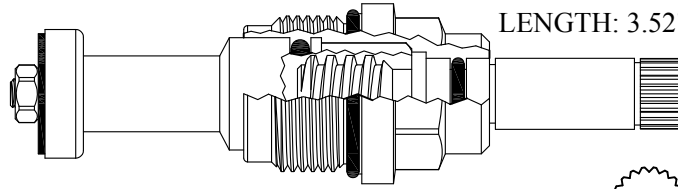

402532

GASKET: 890180 O-RING INCLUDED



3-14

14 TPI Gland Coarse Thread

FOR ARMONIA  
LENGTH: 3.52"

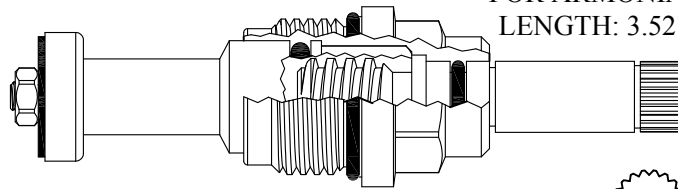

402542

GASKET: 890180 O-RING INCLUDED



3-14

FOR AM STD  
LENGTH: 3.39"

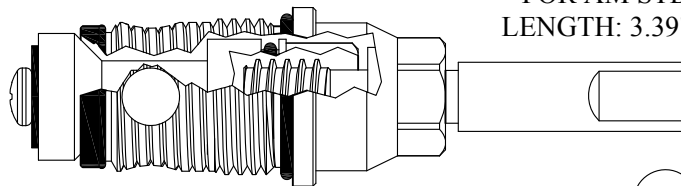

430662



Chrome Plated Stem

FOR CRANE  
LENGTH: 3.39"

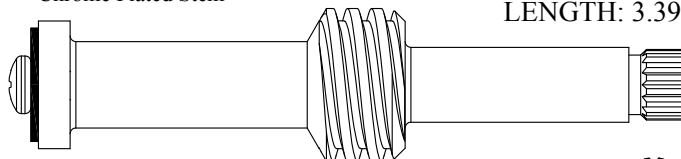

LF268091/ LF268092



1-6

Nickel Plated Stem

FOR CHICAGO  
LENGTH: 3.39"

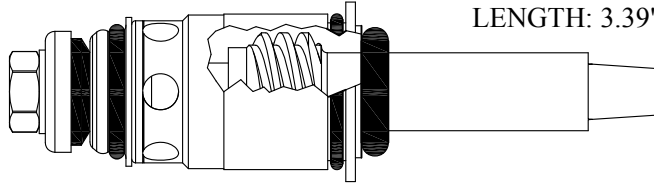

**LF467131/ LF467132**

NEW STYLE  
QUATURN

GASKET: 895200  
SEAT INCLUDED: 648750

Nickel Plated Stem

FOR CHICAGO  
LENGTH: 3.39"

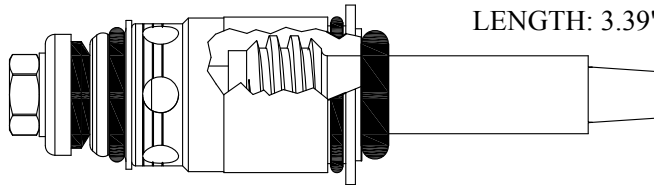

**LF467221/ LF467222**

NEW STYLE  
SLOW COMPRESSION

GASKET: 895200  
SEAT INCLUDED: 648750

FOR SPEAKMAN  
LENGTH: 3.40"

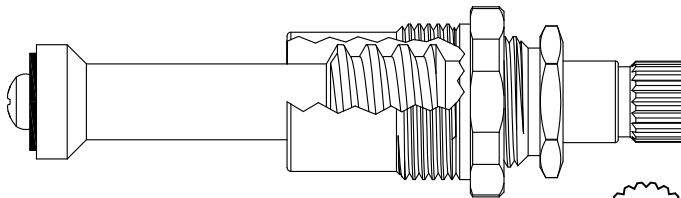

**LF468501**  
**LF268501** Stem Only

20  
2-4



SEAT USED: LF648760

UNKNOWN  
LENGTH: 3.41"

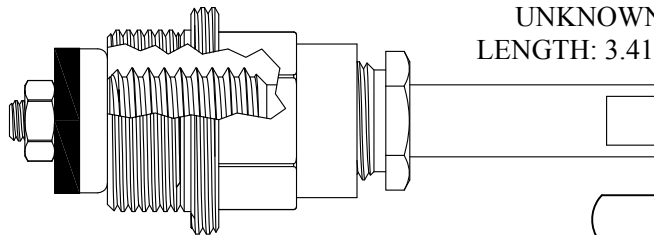

**401751**  
GASKET: 895330





SEAT USED: 648800

Chrome Plated Stem

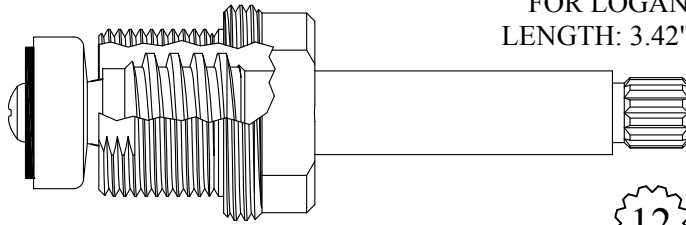

FOR LOGAN  
LENGTH: 3.42"

**402811**  
**202811** Stem Only  
GASKET: 895400

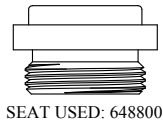

SEAT USED: 648800

Chrome Plated Unit

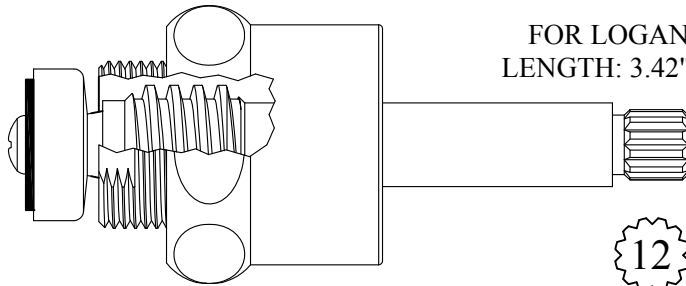

FOR LOGAN  
LENGTH: 3.42"

**402811-N**  
**202811** Stem Only  
GASKET: 895400 INCLUDED



FOR AM STD  
LENGTH: 3.42"

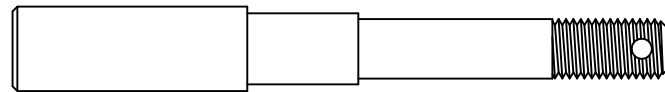

**LF268300**



SEAT USED: LF648040

20 TPI Gland

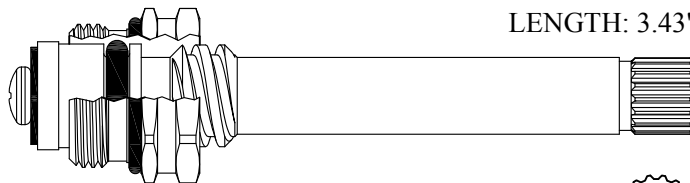

FOR STREAMWAY  
LENGTH: 3.43"

**402721**  
GASKET: 895100



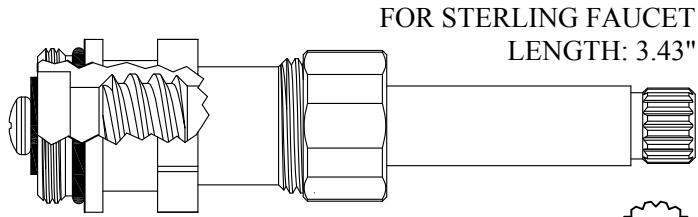

**402821**  
GASKET: 890170 O-RING INCLUDED

16  
1-5

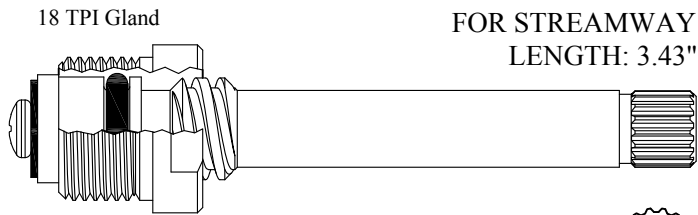
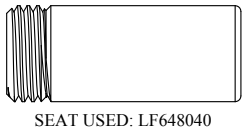

**402711/ 402712**  
GASKET: 895100

17  
3-7

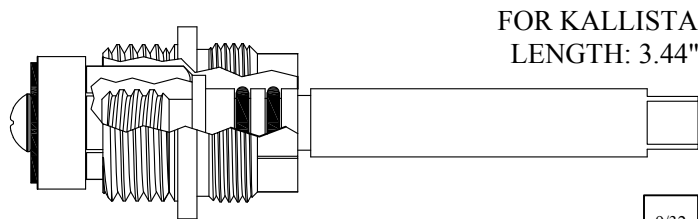

**402762**  
GASKET: 895160

9/32

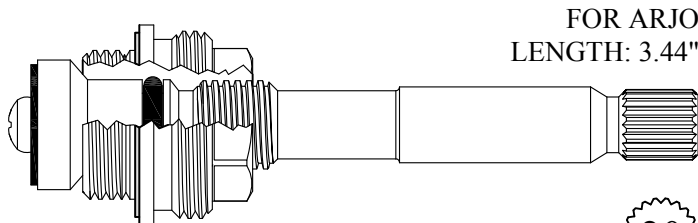

**403071**

20  
3-14

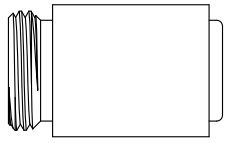

SEAT USED: LF649140

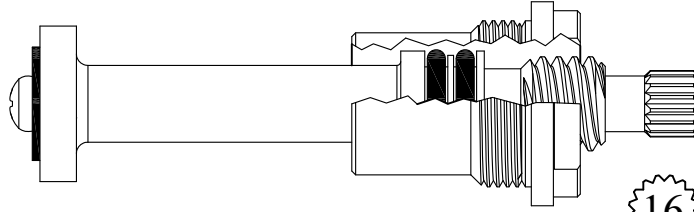

FOR GERBER  
LENGTH: 3.44"

402771/ 402772

GASKET: 895180

16  
2-3

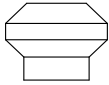

SEAT USED: 649110

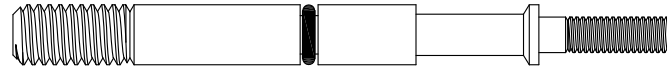

FOR SPEAKMAN  
LENGTH: 3.44"

LF267900

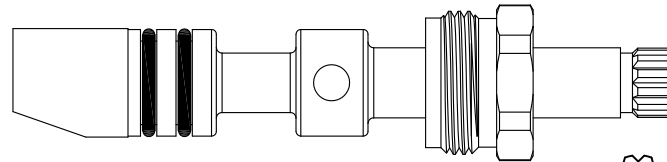

FOR HARCRAFT  
LENGTH: 3.45"

430140  
230140 Stem Only

12  
1-2

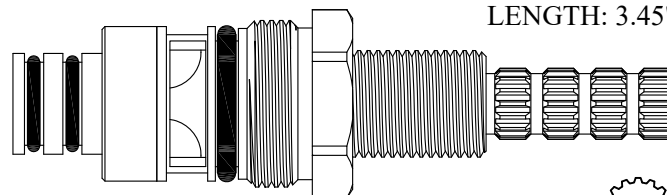

FOR HARDEN  
LENGTH: 3.45"

LF468201/ LF468202

GASKET: 891140 O-RING INCLUDED  
DISC SET: 151380-PKG

16  
3-16

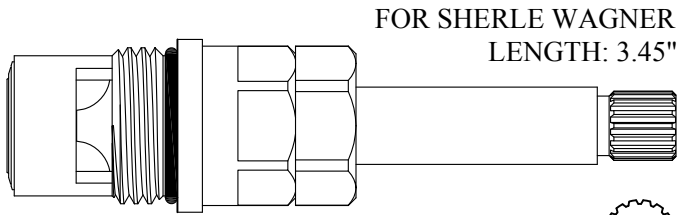

FOR SHERLE WAGNER  
LENGTH: 3.45"

16  
3-16

**LF468521/ LF468522**

GASKET: 890170 O-RING INCLUDED  
SEAL: 898510-W  
DISC SET: 151380-PKG

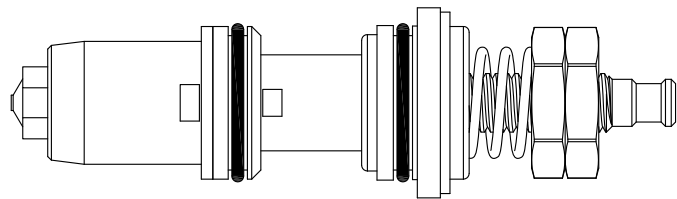

FOR METCRAFT  
LENGTH: 3.46"

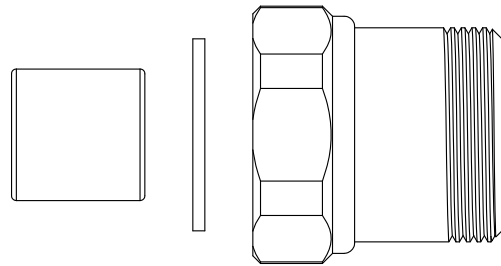

**LF114090**  
**LF114020** Cartridge Only

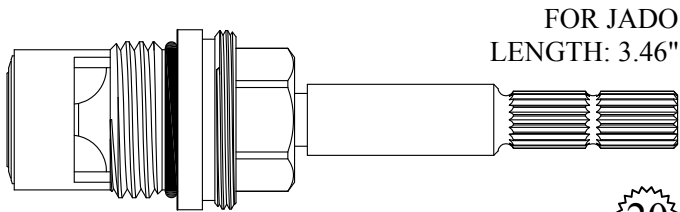

FOR JADO  
LENGTH: 3.46"

20  
3-20

**402841/ 402842**

GASKET: 890170 O-RING INCLUDED  
SEAL: 898510-W  
DISC SET: 151380-PKG

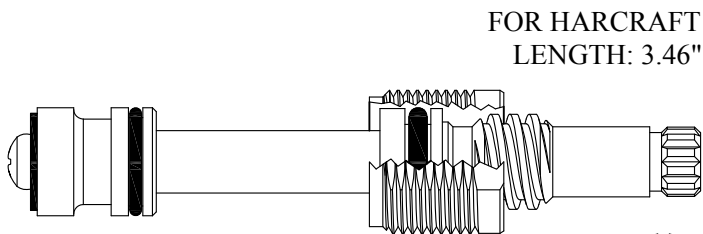

FOR HARCRAFT  
LENGTH: 3.46"

12  
1-2

**LF466131**  
**LF266131** Stem Only

GASKET: 895040 INCLUDED

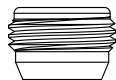

SEAT USED: LF648670

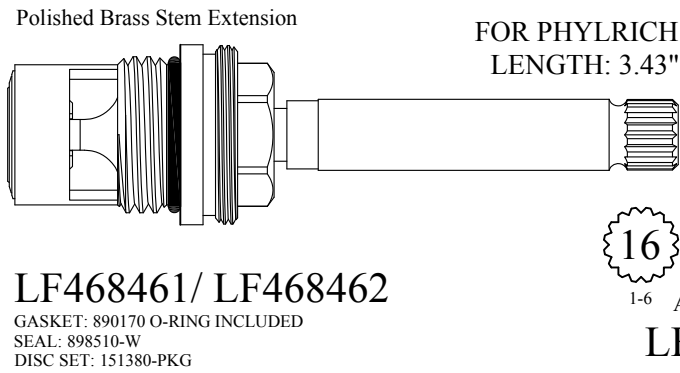
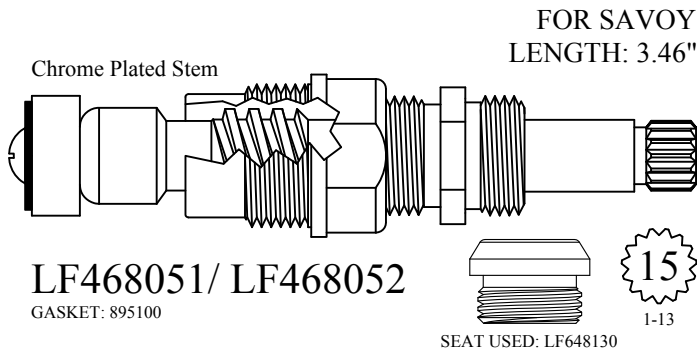

Individual items available  
Stem Ext. 1 7/8": #102890-PB  
& 102890-CP  
Ext. Adap. Screw: #103310

1-6 Also available with chrome plated stem extension

LF468461-CP/ LF468462-CP

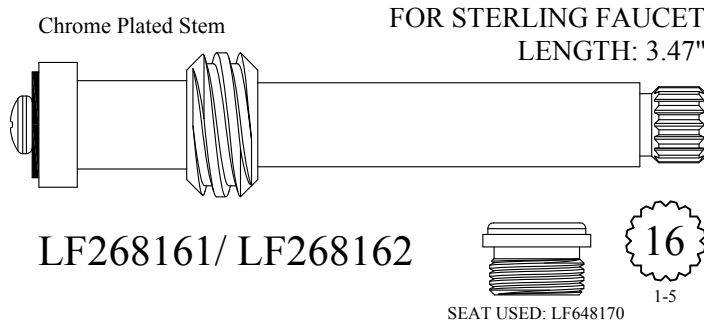
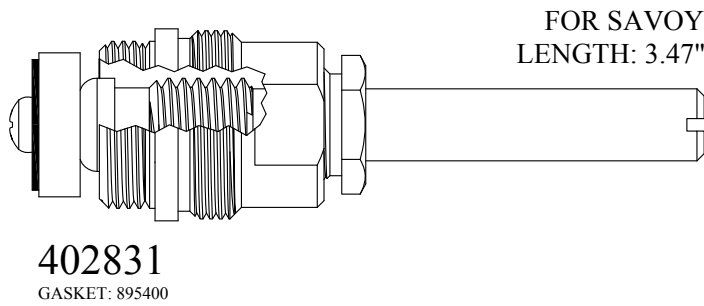

Polished Brass Stem

FOR BROADWAY  
LENGTH: 3.47"

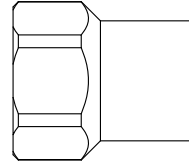
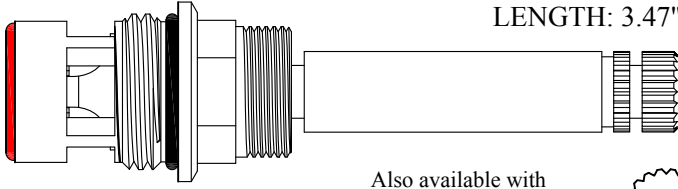

Escutcheon Nut  
# 302740  
available

LF402741

LF402742

GASKET: 890170 O-RING INCLUDED  
SEAL: 898570-R/B  
DISC SET: 151380-PKG

Also available with  
polished chrome stem  
LF402741-CP  
LF402742-CP

20  
2-4

FOR BARBER WILSON  
LENGTH: 3.47"

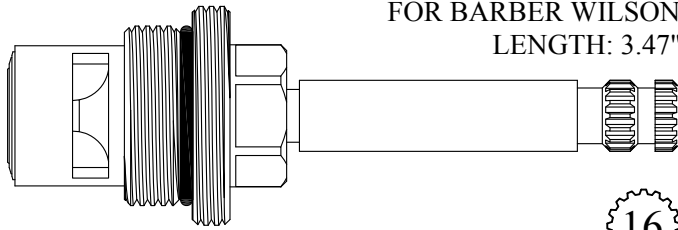

LF468571/ LF468572

GASKET: 890190 O-RING INCLUDED  
SEAL: 898510-W  
DISC SET: 151380-PKG

16  
3-16

FOR BARBER WILSON  
LENGTH: 3.47"

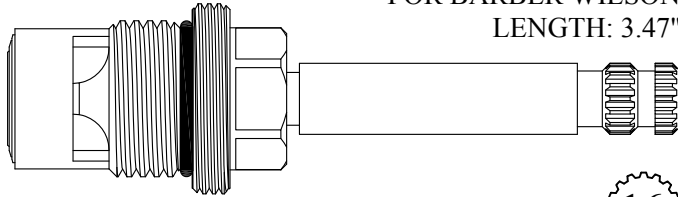

LF468581/ LF468582

GASKET: 890170 O-RING INCLUDED  
SEAL: 898510-W  
DISC SET: 151380-PKG

16  
3-16

FOR STREAMWAY  
LENGTH: 3.48"

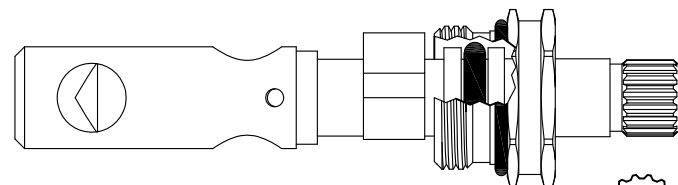

430060

230060 Stem Only

GASKET: 890170 O-RING INCLUDED

17  
3-7

FOR STREAMWAY  
LENGTH: 3.48"

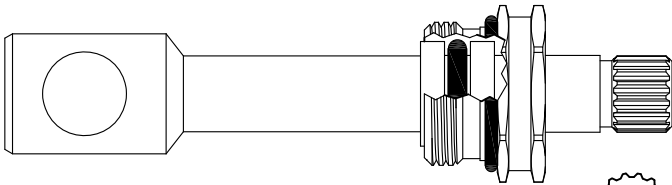

**430080**  
**230080** Stem Only  
GASKET: 890170 O-RING INCLUDED

17  
3-7

FOR FEDERAL HUBER  
LENGTH: 3.50"

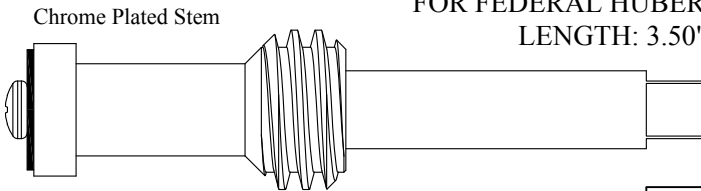

**202801**

5/16

FOR FEDERAL HUBER  
LENGTH: 3.50"

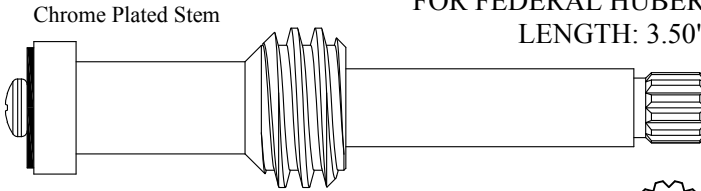

**202851**

12  
1-2

FOR FEDERAL HUBER  
LENGTH: 3.50"

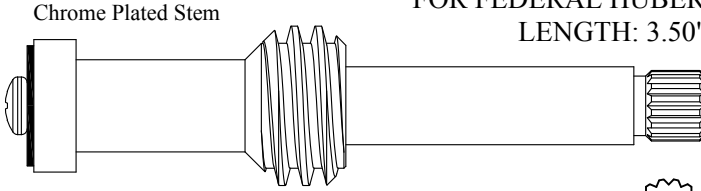

**202871**

16  
1-6

Chrome Plated Stem

FOR CRANE  
LENGTH: 3.48"

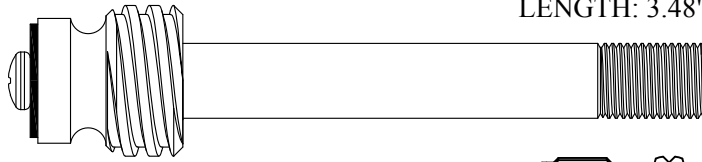

LF267161

Supplied with  
12pt. Broach

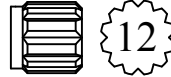

12

1-2

Chrome Plated Stem

FOR SAVOY  
LENGTH: 3.49"

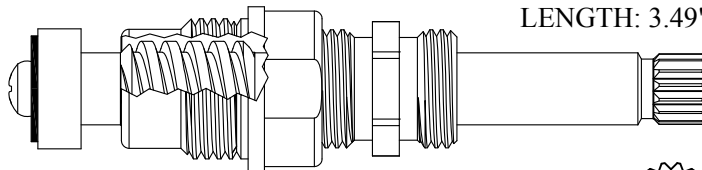

LF468021/ LF468022

GASKET: 895100

15

1-13

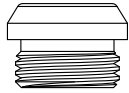

SEAT USED: LF648130

FOR KOHLER  
LENGTH: 3.50"

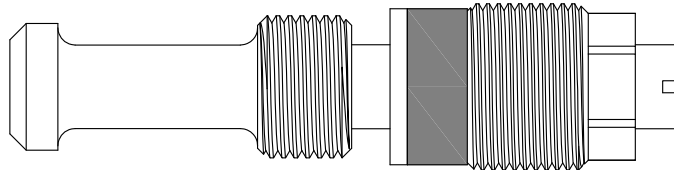

402991

202991 Stem Only

FOR AUBURN BRASS  
LENGTH: 3.51"

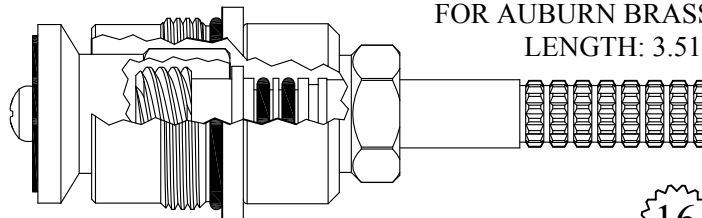

403021/ 403022

GASKET: 890200 O-RING INCLUDED

16

2-3

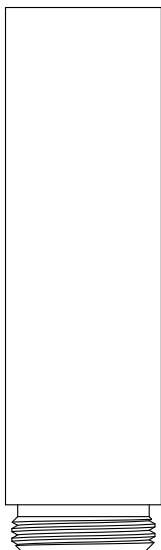

SEAT USED: 647740



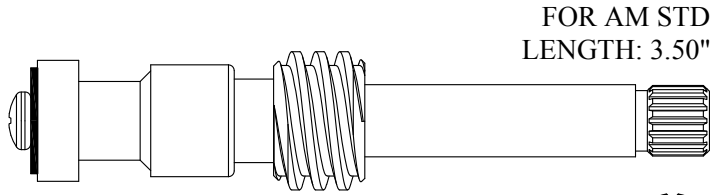

FOR AM STD  
LENGTH: 3.50"

LF268121

12  
1-2

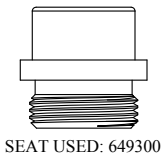

SEAT USED: 649300

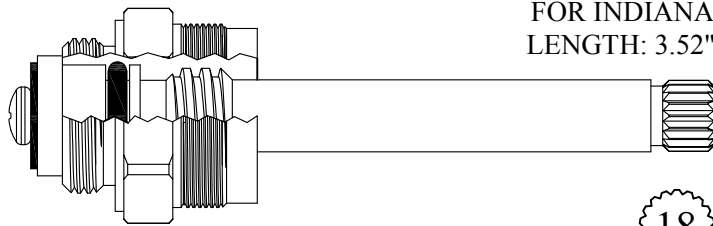

FOR INDIANA  
LENGTH: 3.52"

402901/ 402902

GASKET: 895150

18  
3-3

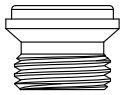

SEAT USED: LF648350

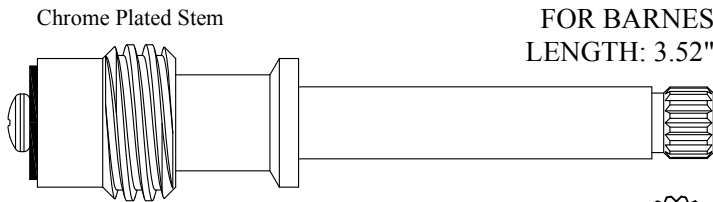

Chrome Plated Stem

FOR BARNES  
LENGTH: 3.52"

LF268001/ LF268002

16  
1-6

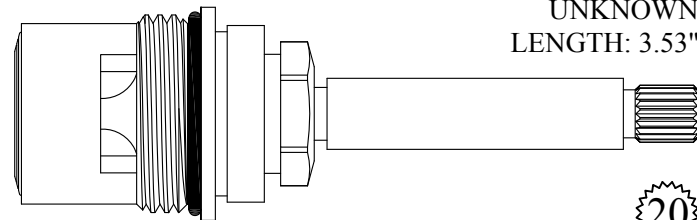

UNKNOWN  
LENGTH: 3.53"

402571/ 402572

GASKET: 890210 O-RING INCLUDED  
SEAL: 898520  
DISC SET: 109850-PKG

20  
3-20

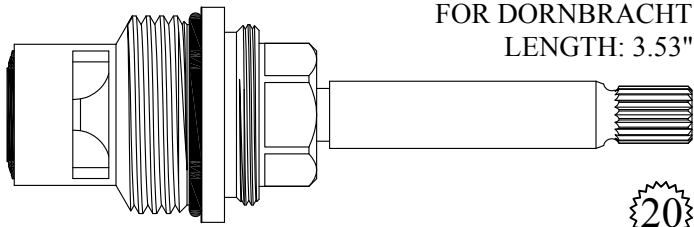

FOR DORNBRACHT  
LENGTH: 3.53"

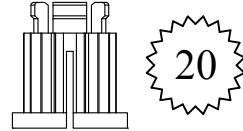

20

Comes with 20pt Grohe  
adapter: 103200

20  
3-20

402861/ 402862

GASKET: 890210 O-RING INCLUDED  
SEAL: 898510  
DISC SET: 151380-PKG

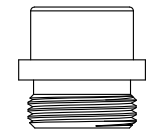

SEAT USED: 649300

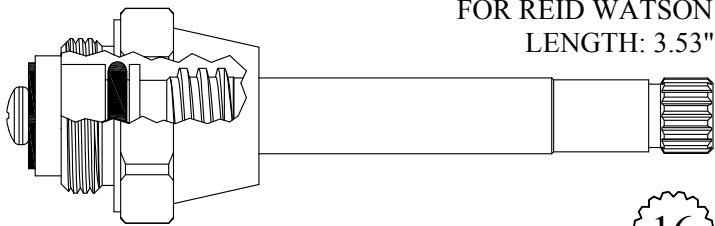

FOR REID WATSON  
LENGTH: 3.53"

16  
1-5

402921/ 402922

GASKET: 895150

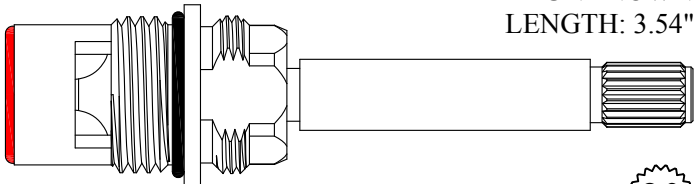

UNKNOWN  
LENGTH: 3.54"

20  
11/32  
(Not European)  
3-34

LF468221/ LF468222

GASKET: 890170 O-RING INCLUDED  
SEAL: 898570-R/B  
DISC SET: 151380-PKG

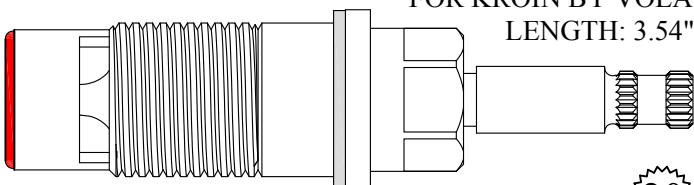

FOR KROIN BY VOLA  
LENGTH: 3.54"

20  
3-20

LF468251/ LF468252

GASKET: 895150 INCLUDED  
SEAL: 898570-R/B  
DISC SET: 151380-PKG

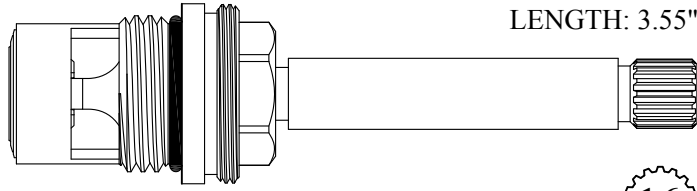

FOR PAUL  
LENGTH: 3.55"

16  
3-16

402931/ 402932

GASKET: 890170 O-RING INCLUDED  
SEAL: 898510-W  
DISC SET: 151380-PKG

Chrome Plated Cap Nut

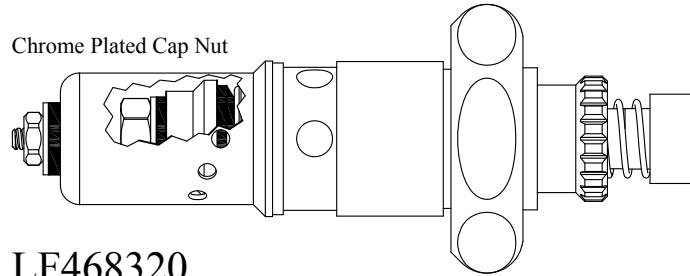

FOR CHICAGO  
LENGTH: 3.55"

LF468320

Chrome Plated Stem

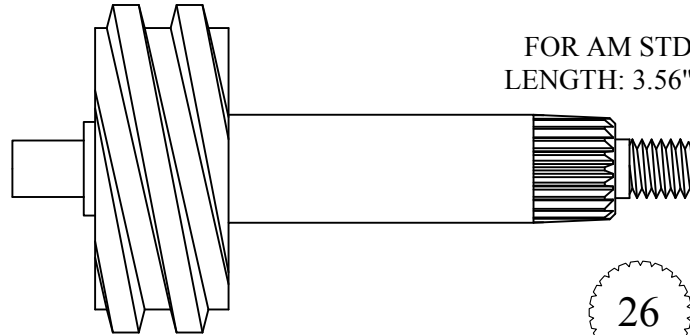

FOR AM STD  
LENGTH: 3.56"

26

203131

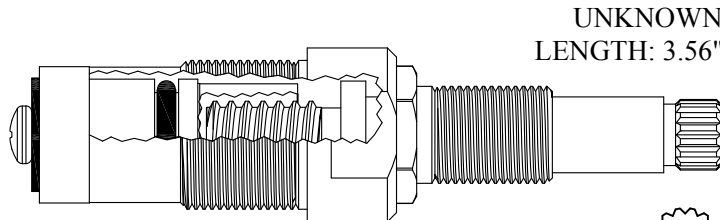

UNKNOWN  
LENGTH: 3.56"

16  
1-6

402782

GASKET: 895140



SEAT USED: LF649040

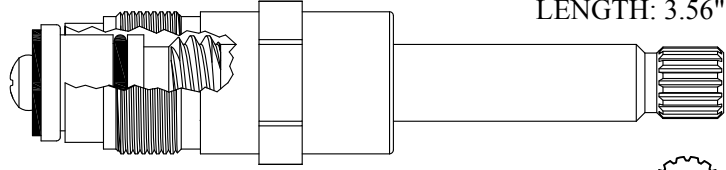

FOR MILWAUKEE  
LENGTH: 3.56"

403001  
203001 Stem Only  
GASKET: 199930

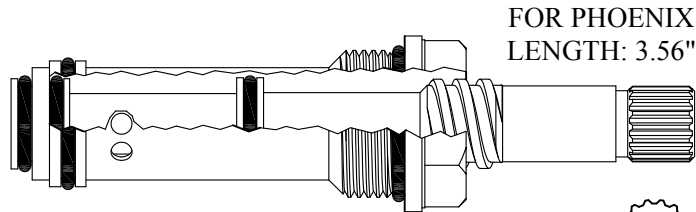

FOR PHOENIX  
LENGTH: 3.56"

430771  
GASKET: 890170 O-RING INCLUDED



SEAT USED: LF649760

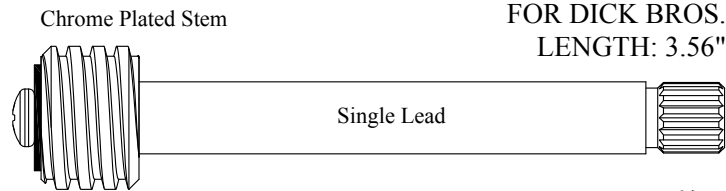

Chrome Plated Stem  
FOR DICK BROS.  
LENGTH: 3.56"

Single Lead

LF268211/ LF268212



SEAT USED: LF649760

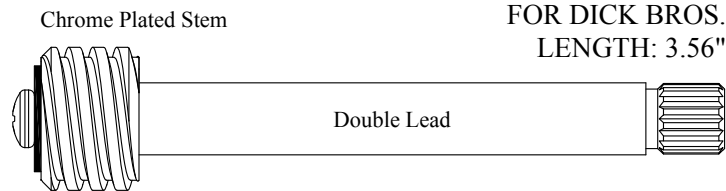

Chrome Plated Stem  
FOR DICK BROS.  
LENGTH: 3.56"

Double Lead

LF269031/ LF269032



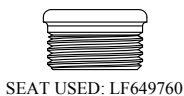

SEAT USED: LF649760

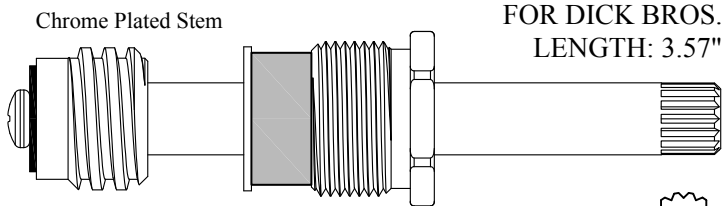

403011/ 403012  
203011/ 203012 Stem Only

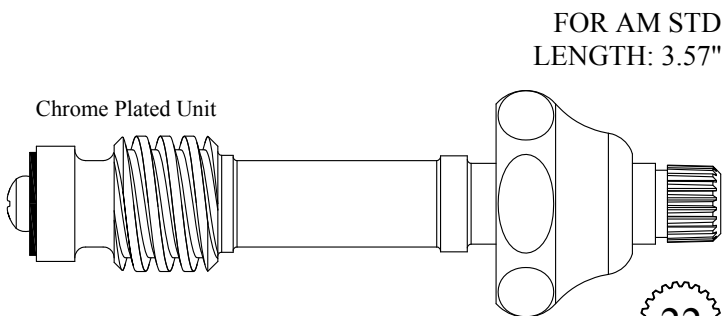

LF468071/ LF468072  
LF268071/ LF268072 Stem Only

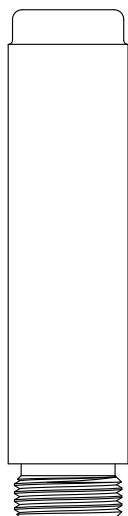

SEAT USED: 647440

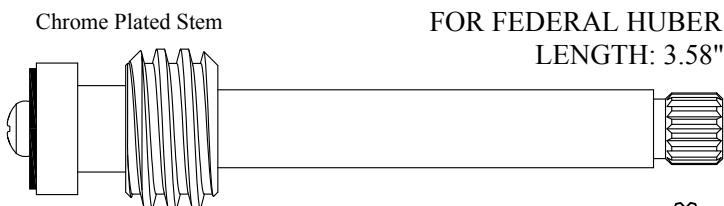

203101

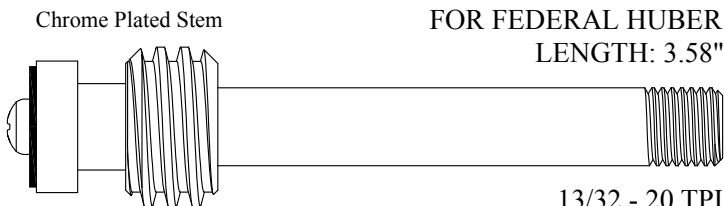

203111

13/32 - 20 TPI

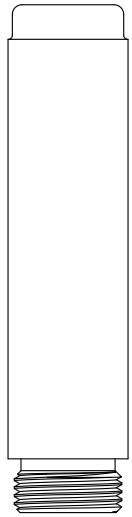

SEAT USED: 647440

Chrome Plated Stem

FOR FEDERAL HUBER  
LENGTH: 3.58"

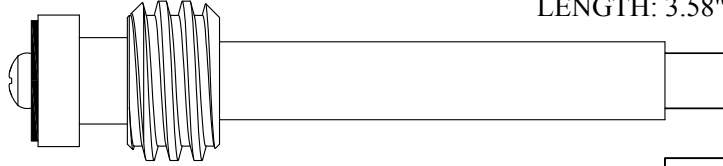

203141

5/16

Chrome Plated Stem

FOR FEDERAL HUBER  
LENGTH: 3.58"

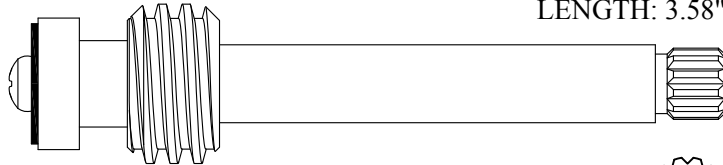

203151

12  
1-2

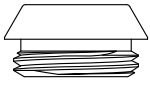

SEAT USED: 648370

FOR PRICE PFISTER  
LENGTH: 3.58"

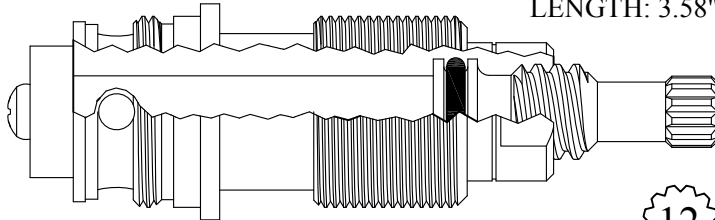

430091

GASKET: 895550

12  
1-2

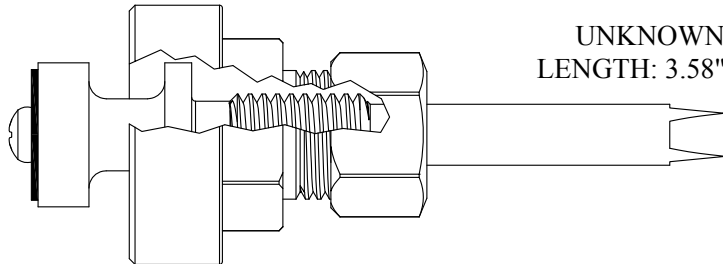

UNKNOWN  
LENGTH: 3.58"

468231

GASKET: 894970 INCLUDED

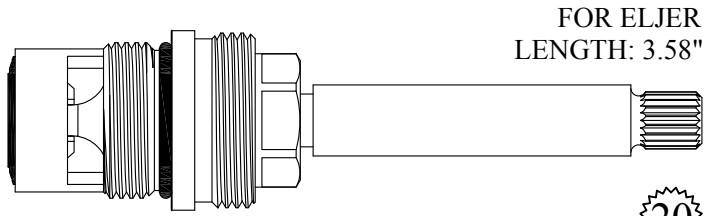

FOR ELJER  
LENGTH: 3.58"

**402911/ 402912**

GASKET: 890170 O-RING INCLUDED  
SEAL: 898510  
DISC SET: 151380-PKG

**20**  
3-20

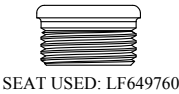

SEAT USED: LF649760

Chrome Plated Stem

FOR DICK BROS.  
LENGTH: 3.58"

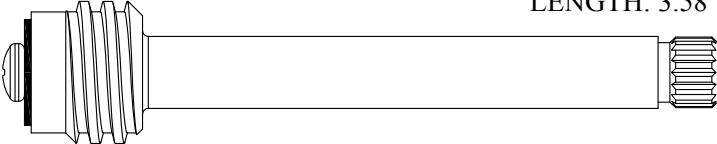

**LF269091/ LF269092**

**16**  
1-6

Plastic Stem

FOR STERLING FAUCET  
LENGTH: 3.59"

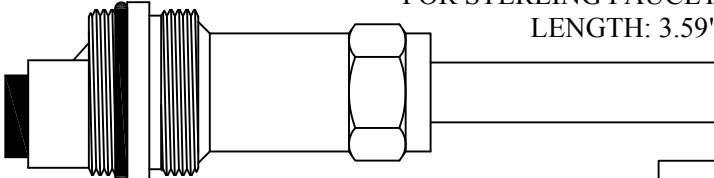

5/16

**403220**  
**203220** Stem Only

GASKET: 890190 O-RING INCLUDED

FOR GERBER  
FOR DANFOSS  
FOR TEMPRESS  
FOR DORNBRACHT  
LENGTH: 3.59"

Old Style - Automatic

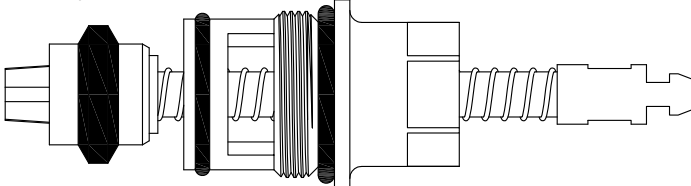

**430790**

GASKET: 894120 O-RING INCLUDED

Chrome Plated Unit

FOR SPEAKMAN  
LENGTH: 3.59"

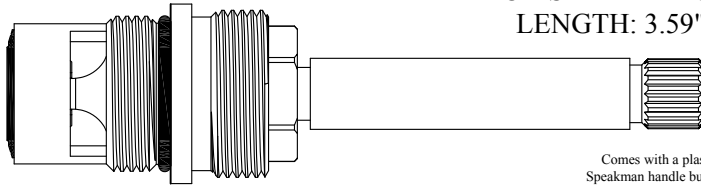

Comes with a plastic  
Speakman handle bushing

**402951/ 402952**

GASKET: 890170 O-RING INCLUDED  
SEAL: 898510  
DISC SET: 151380-PKG



Chrome Plated Unit

FOR SPEAKMAN  
LENGTH: 3.59"

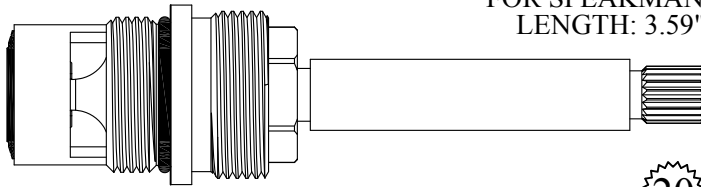

**402961/ 402962**

GASKET: 890170 O-RING INCLUDED  
SEAL: 898510  
DISC SET: 151380-PKG

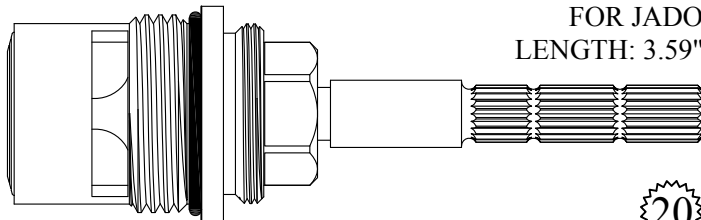

FOR JADO  
LENGTH: 3.59"



**402971/ 402972**

GASKET: 890210 O-RING INCLUDED  
SEAL: 898520  
DISC SET: 109850-PKG

FOR AM STD  
LENGTH: 3.59"



**LF268310**



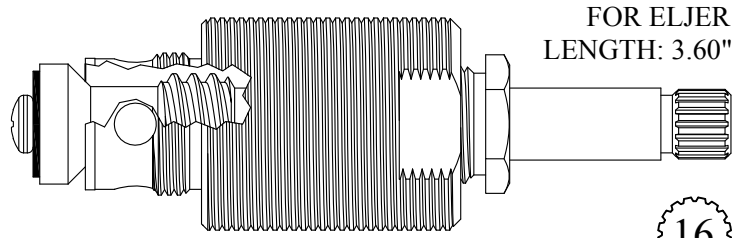

**430131**  
GASKET: 895100

16  
3-15

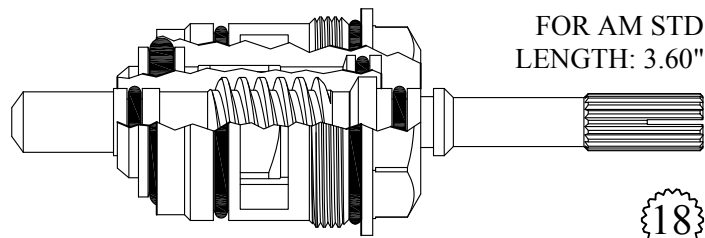

**431681**  
GASKET: 890210 O-RING INCLUDED

18  
3-30

USES BARREL:  
LF647021/LF647022

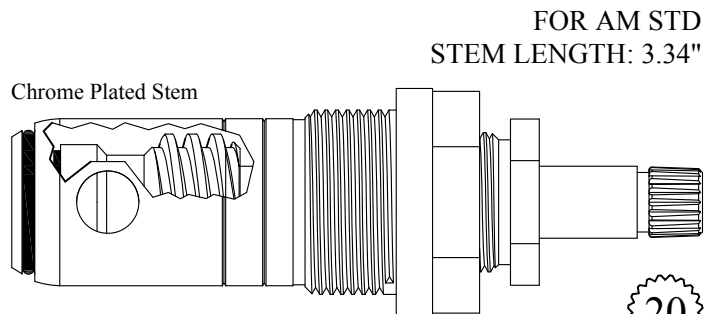

**LF468701/ LF468702**  
**LF268701/ LF268702** Stem Only  
GASKET: 818010

20  
3-14

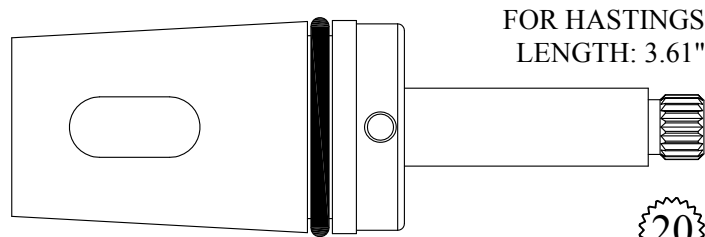

**230580**

20  
11/32  
3-34

USES BARREL:  
LF647021/LF647022

FOR AM STD  
STEM LENGTH: 3.34"

Chrome Plated Stem

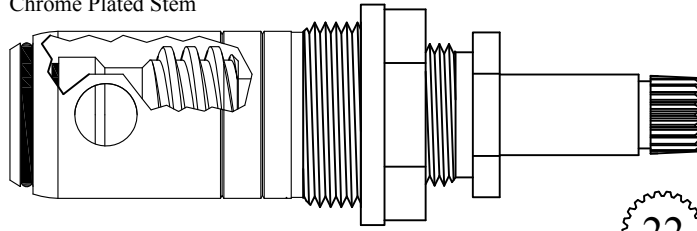

LF468061/ LF468062  
LF268061/ LF268062 Stem Only  
GASKET: 818010



FOR AM STD  
LENGTH: 3.34"

Chrome Plated Stem

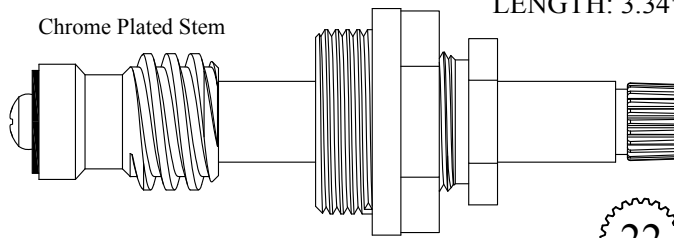

LF468261/ LF468262  
LF268061/ LF268062 Stem Only

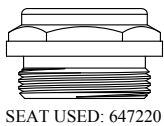

SEAT USED: 647220

FOR KOHLER  
LENGTH: 3.62"

Triple Lead

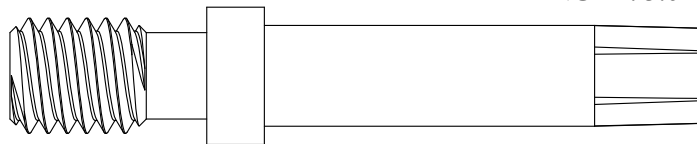

202941

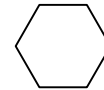

FOR CRANE  
LENGTH: 3.66"

Chrome Plated Bonnet

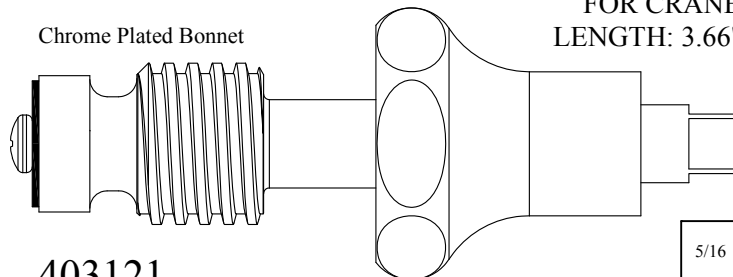

403121  
203121 Stem Only





SEAT USED: LF649930

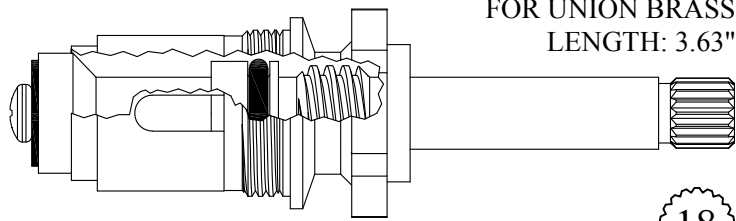

FOR UNION BRASS  
LENGTH: 3.63"

**430151**  
GASKET: 895400



SEAT USED: LF648550

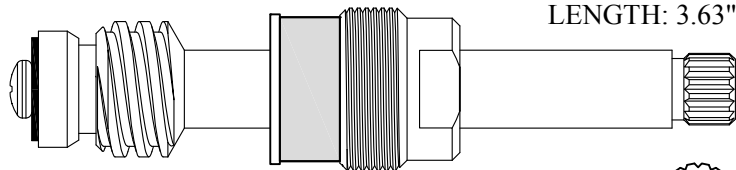

FOR CENTRAL  
LENGTH: 3.63"

**LF469021/ LF469022**  
**LF269021/ LF269022** Stem Only

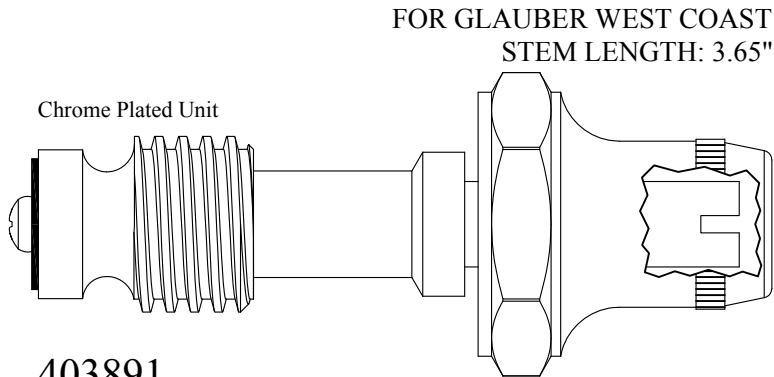

FOR GLAUBER WEST COAST  
STEM LENGTH: 3.65"

**403891**  
**203891** Stem Only

Chrome Plated Unit



SEAT USED: LF647690

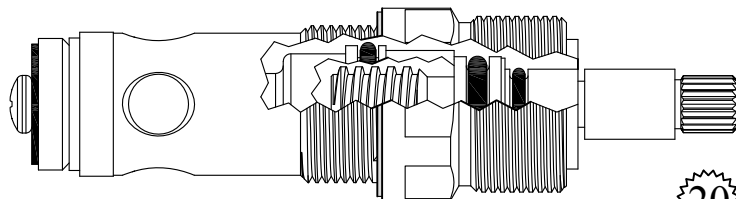

FOR ELJER  
LENGTH: 3.65"

**430192**  
GASKET: 895160 INCLUDED



FOR ACORN  
LENGTH: 3.65"

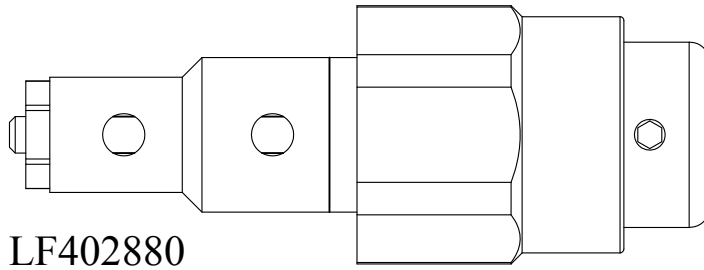

LF402880

Chrome Plated Stem

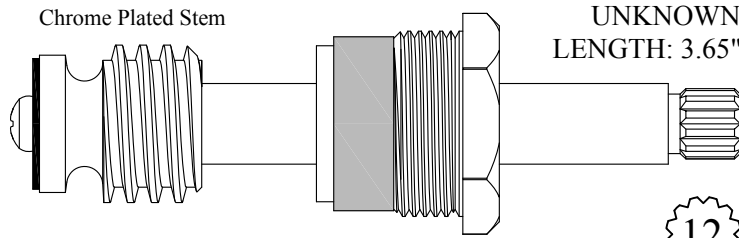

UNKNOWN  
LENGTH: 3.65"

LF469221

LF269221 Stem Only

12  
1-2

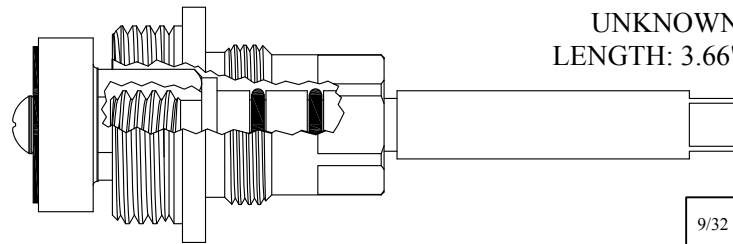

UNKNOWN  
LENGTH: 3.66"

403062

GASKET: 895560

9/32

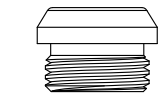

SEAT USED: LF648130

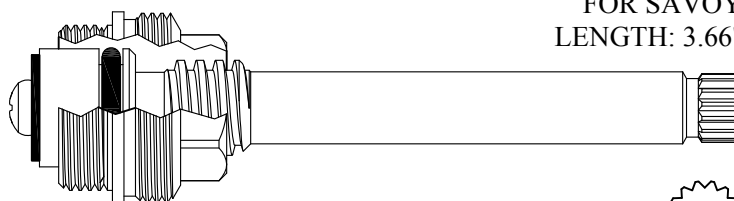

FOR SAVOY  
LENGTH: 3.66"

403321

GASKET: 895400

15  
1-13

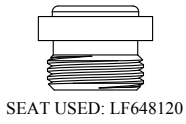

Chrome Plated Stem

FOR BRIGGS  
LENGTH: 3.66"

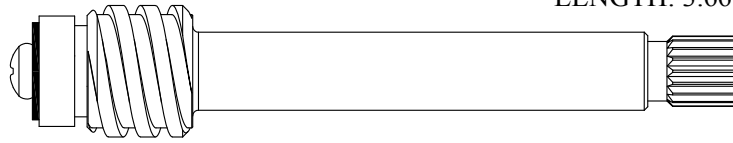

LF269151/ LF269152

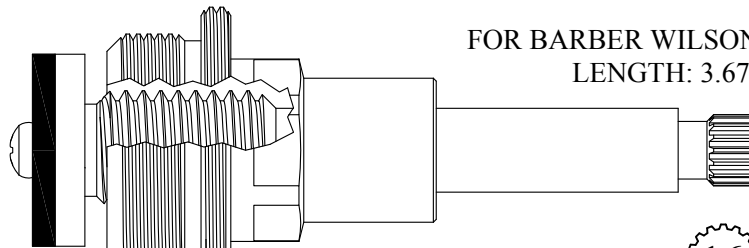

FOR BARBER WILSON  
LENGTH: 3.67"

404541



Chrome Plated Stem

FOR SPEAKMAN  
LENGTH: 3.69"

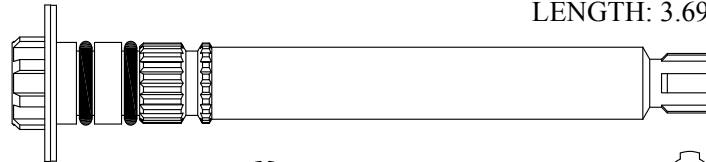

202980

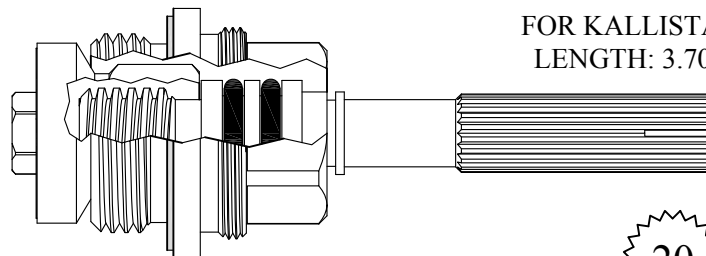

FOR KALLISTA  
LENGTH: 3.70"

402792

GASKET: 895440



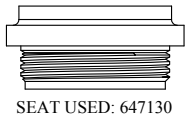

SEAT USED: 647130

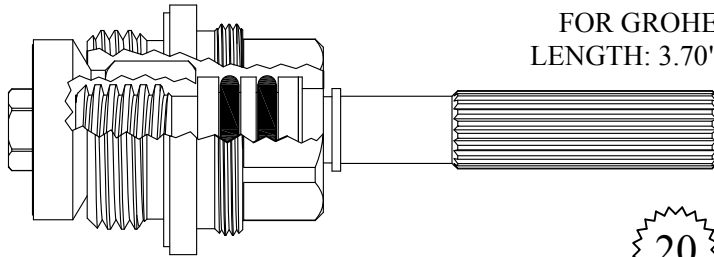

FOR GROHE  
LENGTH: 3.70"

**402892**

GASKET: 895440 INCLUDED

20  
3-32

FOR CRANE  
LENGTH: 3.71"



SEAT USED: LF648340

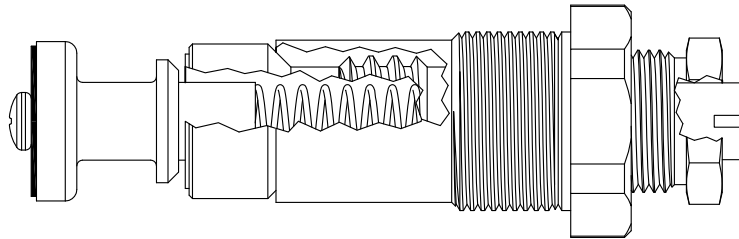

**402731**

**202731** Stem Only

GASKET: 895370

FOR ARTISTIC BRASS  
LENGTH: 3.73"

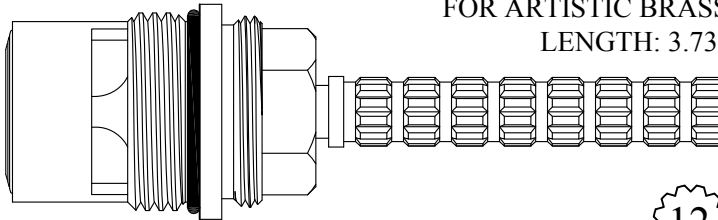

**403041/ 403042**

GASKET: 890210 O-RING INCLUDED

SEAL: 898520

DISC SET: 109850-PKG

12  
1-2

FOR CIFIAL  
LENGTH: 3.74"

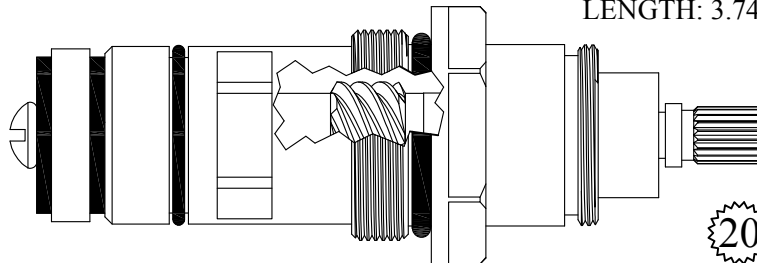

**430871**

GASKET: 891180 O-RING INCLUDED

20  
3-20

Chrome Plated Stem

FOR BRIGGS  
LENGTH: 3.74"

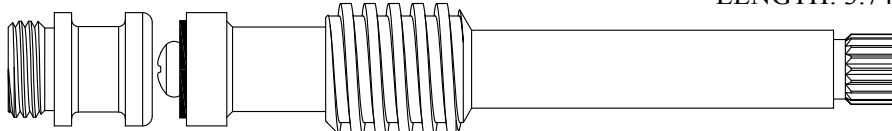

SEAT USED: LF648250

**LF269141**

18  
3-3

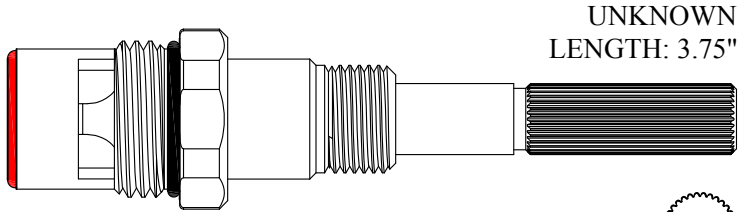

UNKNOWN  
LENGTH: 3.75"

**LF468441/ LF468442**

GASKET: 890170 O-RING INCLUDED  
SEAL: 898570-R/B  
DISC SET: 151380-PKG

32  
3-23

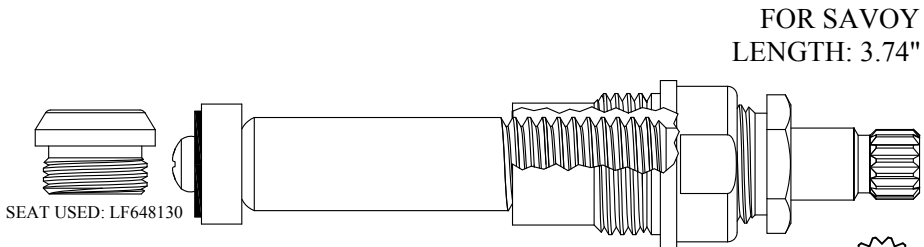

FOR SAVOY  
LENGTH: 3.74"

SEAT USED: LF648130

**LF468801/ LF468802**

GASKET: 895100

15  
1-13

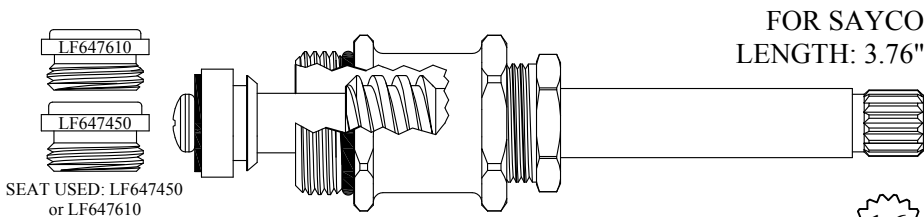

FOR SAYCO  
LENGTH: 3.76"

SEAT USED: LF647450  
or LF647610

**403031**

**203031** Stem Only

GASKET: 890160 O-RING INCLUDED

16  
2-3

New Style - Manual

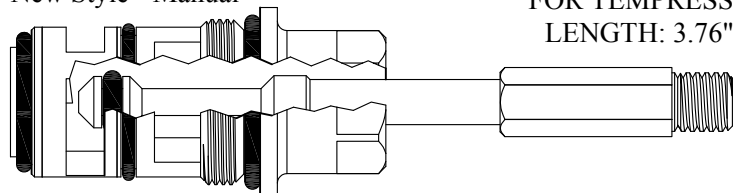

FOR ROHL  
FOR GERBER  
FOR DANFOSS  
FOR TEMPRESS  
LENGTH: 3.76"

**430850**

GASKET: 894120 O-RING INCLUDED

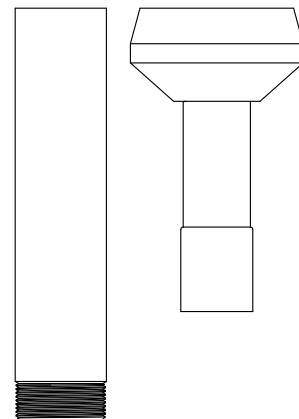

Chrome plated handle  
& sleeve available  
**128540**

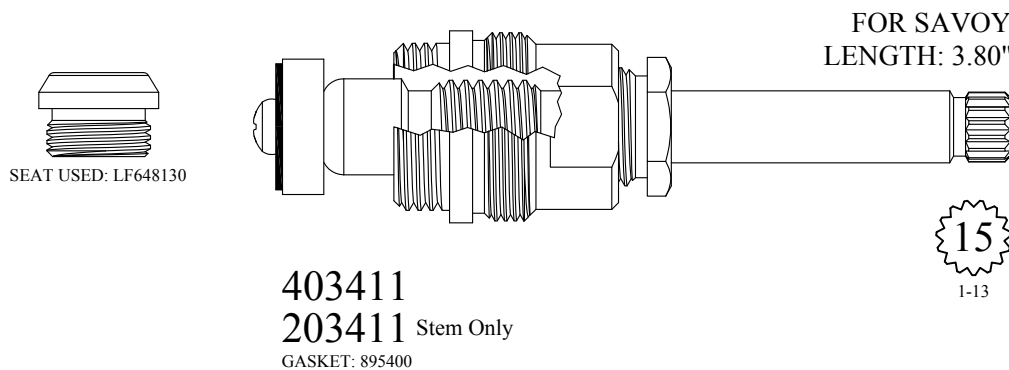
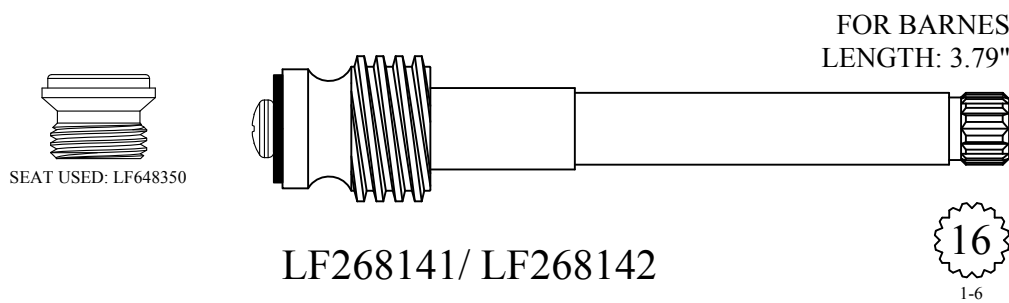
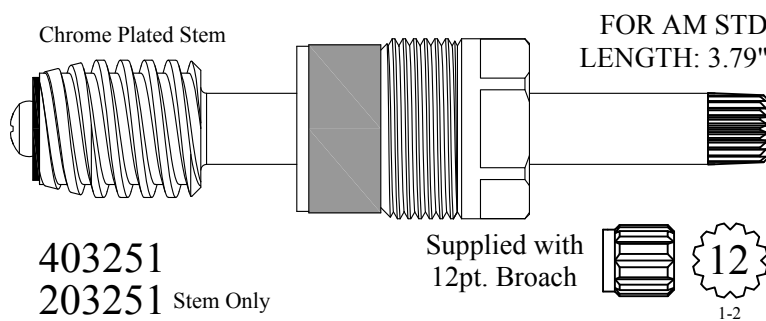
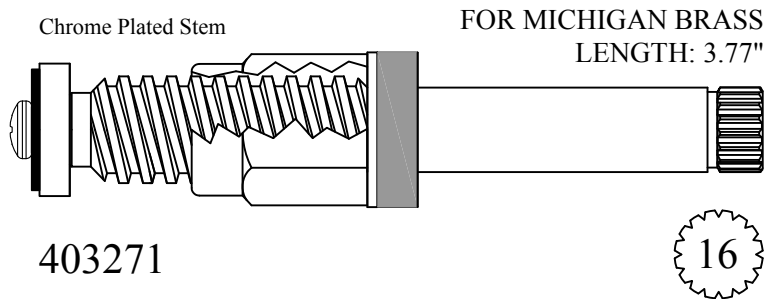





SEAT USED: LF648130

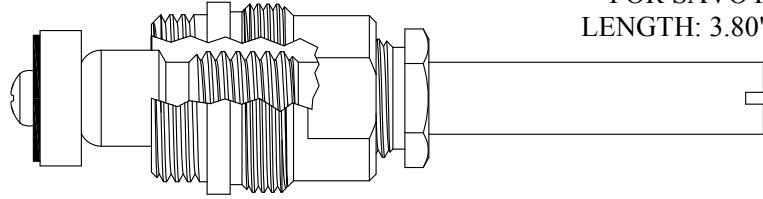

FOR SAVOY  
LENGTH: 3.80"

**403561**

GASKET: 895400



SEAT USED: LF648760

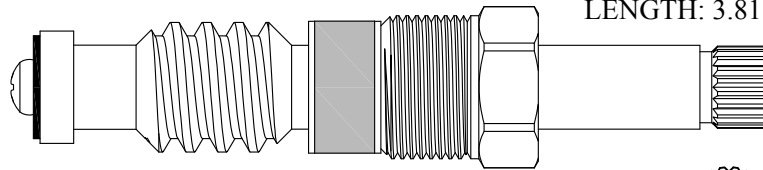

FOR SPEAKMAN  
LENGTH: 3.81"

**403301**

**203301** Stem Only



SEAT USED: LF648760

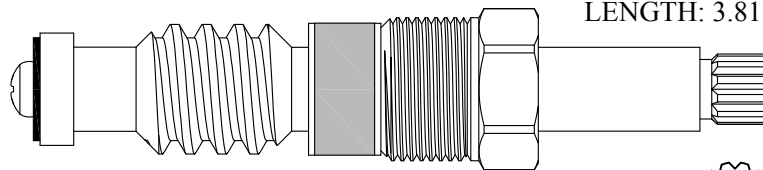

FOR SPEAKMAN  
LENGTH: 3.81"

**403351**

**203351** Stem Only

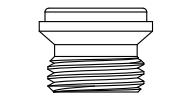

SEAT USED: LF648350

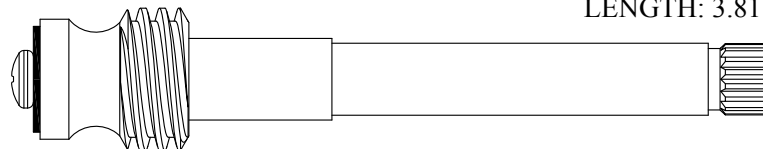

FOR BARNES  
LENGTH: 3.81"

**LF269061/ LF269062**



UNKNOWN  
LENGTH: 3.81"



14  
5/16

**LF403461/ LF403462**

GASKET: 890170 O-RING INCLUDED  
SEAL: 898580-R/B  
DISC SET: 151380-PKG

FOR AM STD  
STEM LENGTH: 3.56"

Chrome Plated Stem

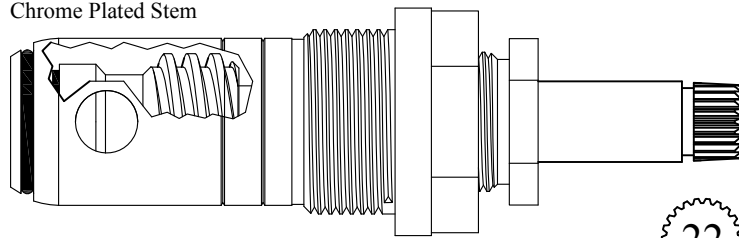

22  
1-4

**LF468081/ LF468082**  
**LF268081/ LF268082** Stem Only  
GASKET: 818010

USES BARREL:  
LF647021/LF647022

FOR ELJER  
LENGTH: 3.82"

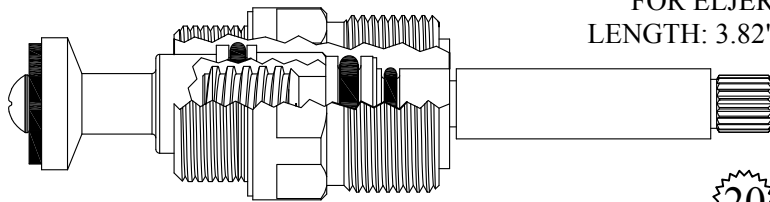

20  
3-20

**403232**  
GASKET: 895160 INCLUDED

SEAT USED: LF647690

FOR SPEAKMAN  
LENGTH: 3.82"

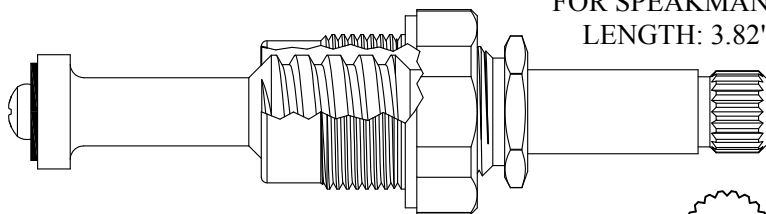

20  
2-4

**403241**  
**203241** Stem Only  
GASKET: 895160

SEAT USED: LF648760

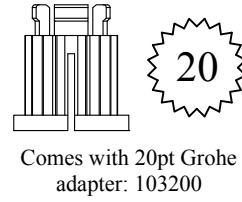
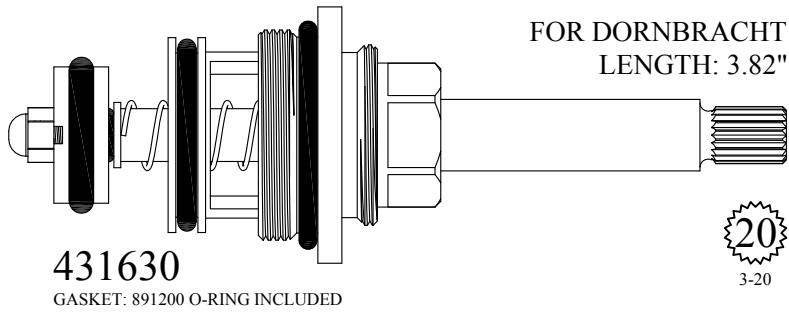

Comes with 20pt Grohe adapter: 103200

20  
3-20

**431630**  
GASKET: 891200 O-RING INCLUDED

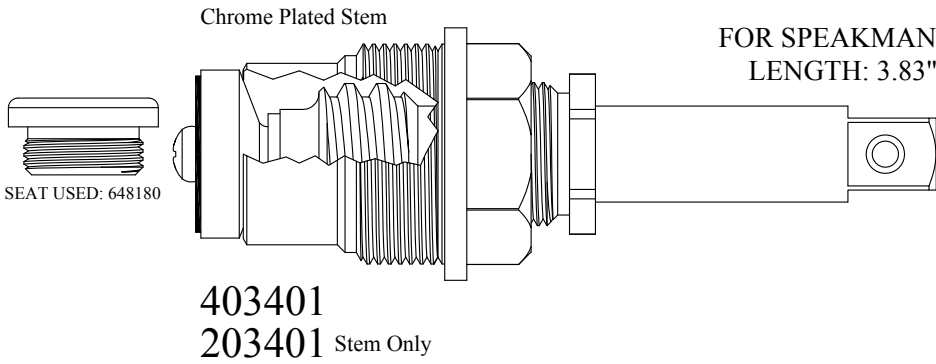

**403401**  
**203401** Stem Only

SEAT USED: 648180

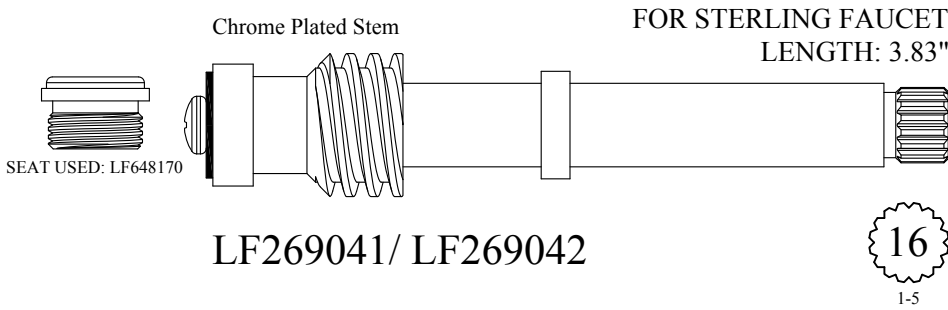

**LF269041/ LF269042**

16  
1-5

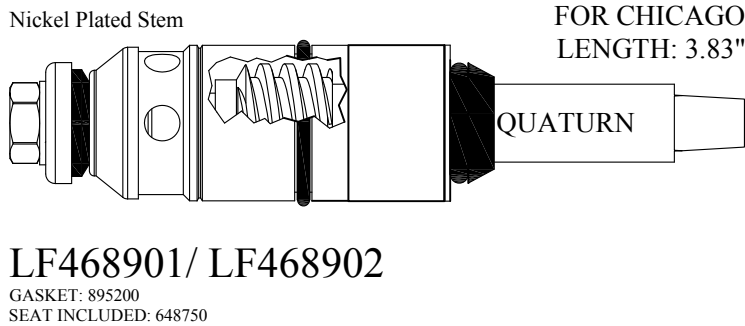

**LF468901/ LF468902**  
GASKET: 895200  
SEAT INCLUDED: 648750

FOR AM STD  
LENGTH: 3.83"

Chrome Plated Stem

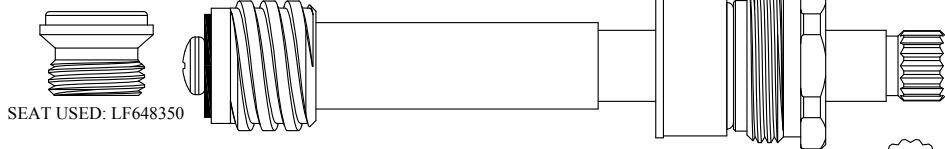

SEAT USED: LF648350

LF469071/ LF469072  
LF269071/ LF269072 Stem Only

16

FOR MICHIGAN BRASS  
LENGTH: 3.86"

24 TPI Gland  
Chrome Plated Gland

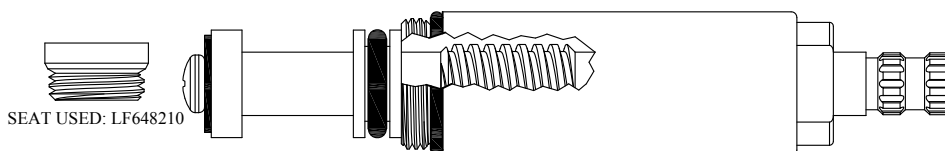

SEAT USED: LF648210

403421/ 403422  
GASKET: 890160 O-RING INCLUDED

12  
3-5

FOR WOLVERINE  
LENGTH: 3.86"

20 TPI Gland  
Chrome Plated Gland

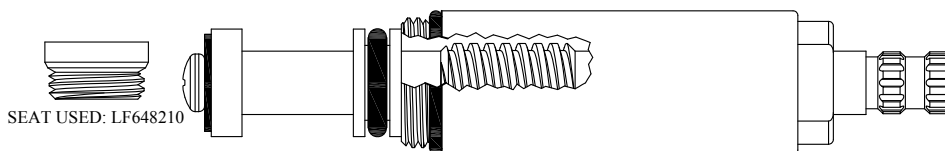

SEAT USED: LF648210

403541/ 403542  
GASKET: 890160 O-RING INCLUDED

12  
3-5

FOR AM STD  
LENGTH: 3.87"

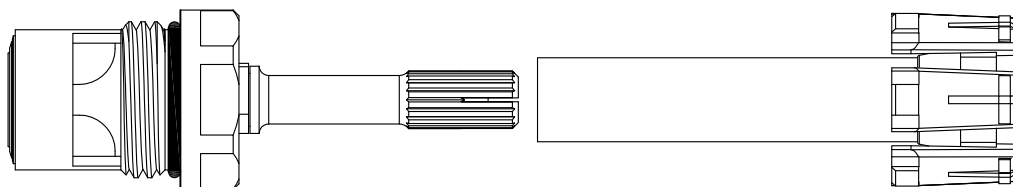

406101  
GASKET: 890170 O-RING INCLUDED  
SEAL: 898510-W  
DISC SET: 151380-PKG

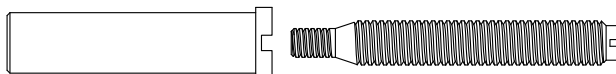



Chrome Plated Stem

FOR KOHLER  
LENGTH: 3.87"

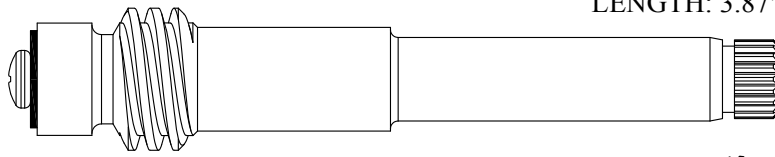

LF269081/ LF269082



Chrome Plated Stem

FOR SPEAKMAN  
LENGTH: 3.88"

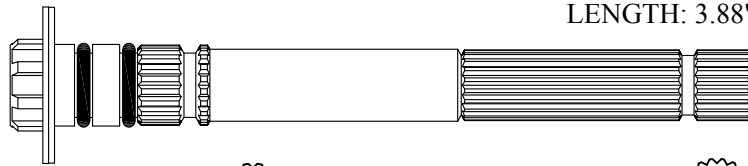

203470



FOR PHOENIX  
LENGTH: 3.88"

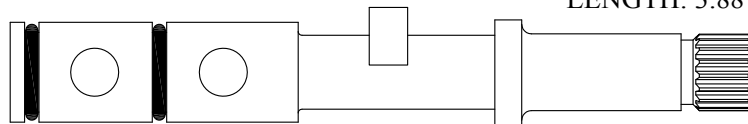

230370



Chrome Plated Stem

FOR MILWAUKEE  
LENGTH: 3.88"

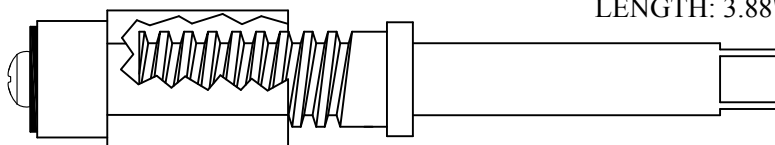

402632  
202632 Stem Only



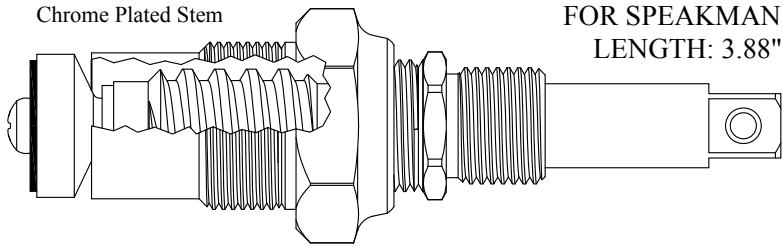

**403531**  
**203531** Stem Only  
 GASKET: 895400

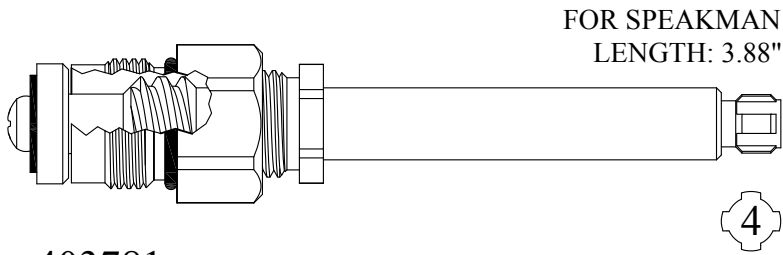

**403781**  
 GASKET: 890150 O-RING INCLUDED

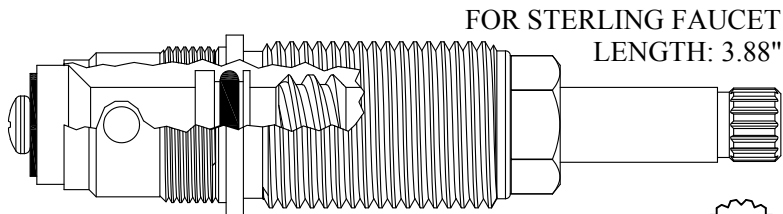

**430181**  
 GASKET: 895150

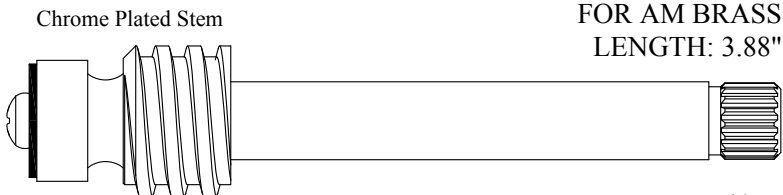

**LF269161/ LF269162**



Chrome Plated Stem

FOR HARCRAFT  
LENGTH: 3.88"

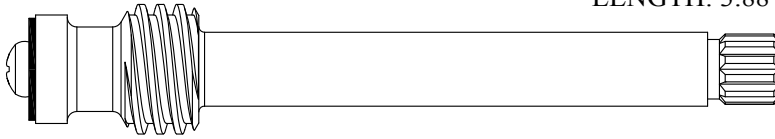

LF270011/ LF270012

12  
1-2

CERAMIC CONVERSION FOR AM STD COLONY (LONG)  
LENGTH: 3.90"

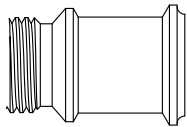

SEAT INCLUDED: 646960

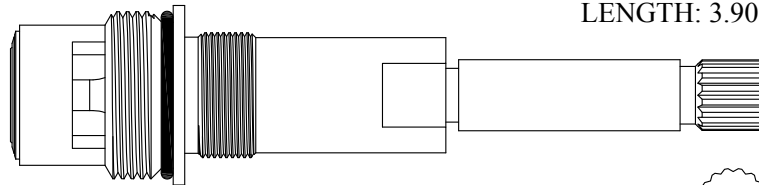

403481

GASKET: 890180 O-RING INCLUDED  
SEAL: 898510-W  
DISC SET: 151380-PKG

16

Chrome Plated Stem

FOR SPHINX  
LENGTH: 3.90"

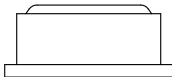

SEAT USED: LF649520

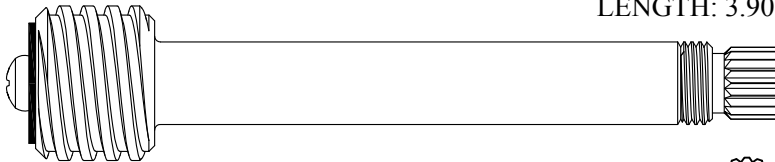

202221/ 202222

18  
3-3

Chrome Plated Stem

FOR SPHINX  
LENGTH: 3.90"

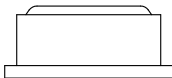

SEAT USED: LF649520

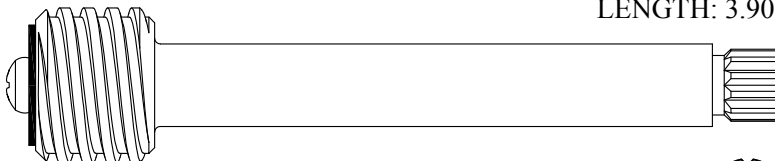

202271/ 202272

12  
1-2

FOR KOHLER  
LENGTH: 3.91"

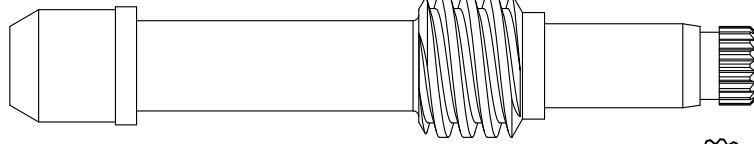

231151

19

1-7

FOR STERLING FAUCET  
LENGTH: 3.91"



SEAT USED: LF648170

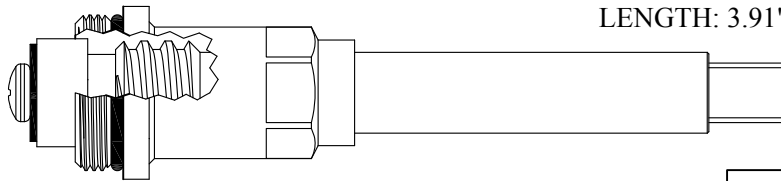

403931/ 403932

GASKET: 890170 O-RING INCLUDED

5/16

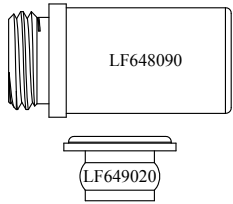

SEATS USED: LF648090 or LF649020

Chrome Plated Stem

FOR UNION BRASS  
LENGTH: 3.91"

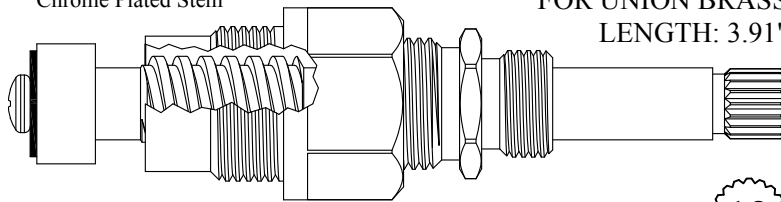

LF469051/ LF469052

LF269051/ LF269052 Stem Only

GASKET: 895150

18

3-3

FOR STERLING FAUCET  
LENGTH: 3.92"



SEAT USED: LF648170

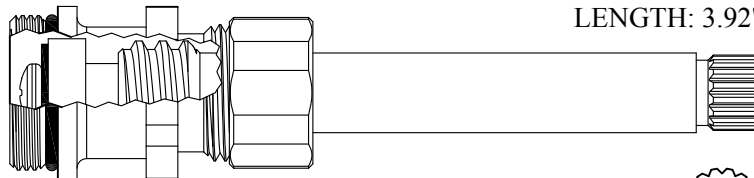

403331

GASKET: 890170 O-RING INCLUDED

16

1-5



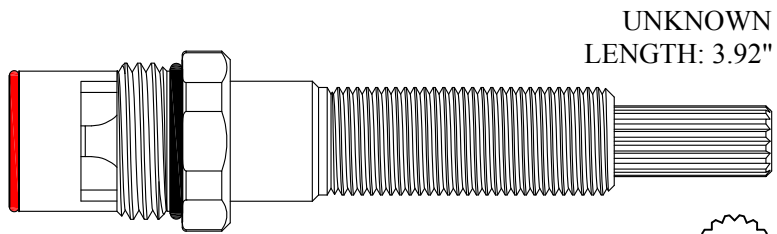

UNKNOWN  
LENGTH: 3.92"

**403631/ 403632**  
GASKET: 890170 O-RING INCLUDED  
SEAL: 898580-R/B  
DISC SET: 151380-PKG

16  
1-6

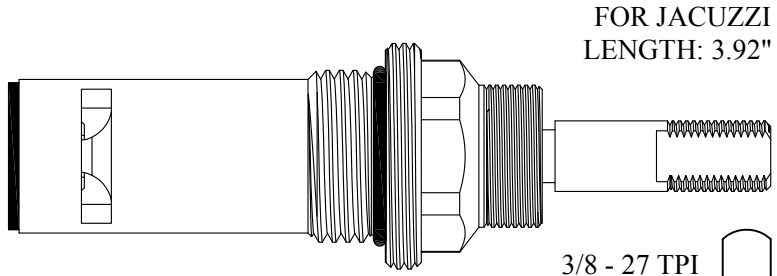

FOR JACUZZI  
LENGTH: 3.92"

**403821/ 403822**  
GASKET: 890190 O-RING INCLUDED  
SEAL: 898550  
DISC SET: 151380-PKG

3/8 - 27 TPI

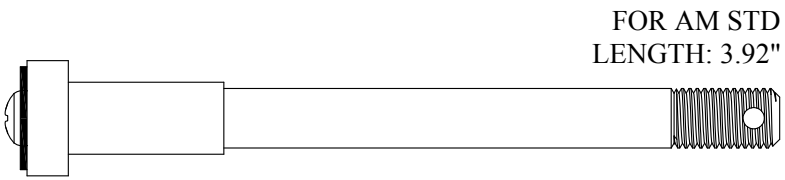

FOR AM STD  
LENGTH: 3.92"

**LF270030**

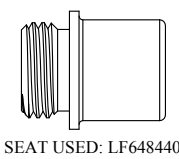

SEAT USED: LF648440



FOR ROYAL BRASS  
LENGTH: 3.93"

**403441**  
GASKET: 895100

16  
1-6

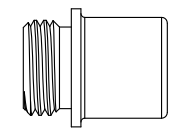

SEAT USED: LF648440

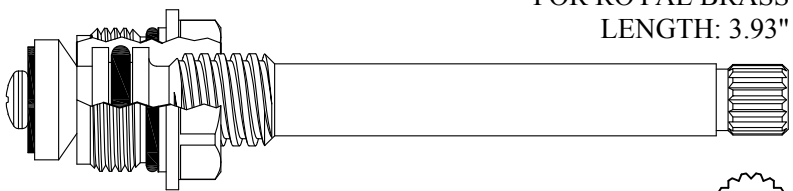

FOR ROYAL BRASS  
LENGTH: 3.93"

**403521**

GASKET: 890160 O-RING INCLUDED

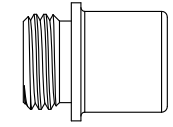

SEAT USED: LF648440

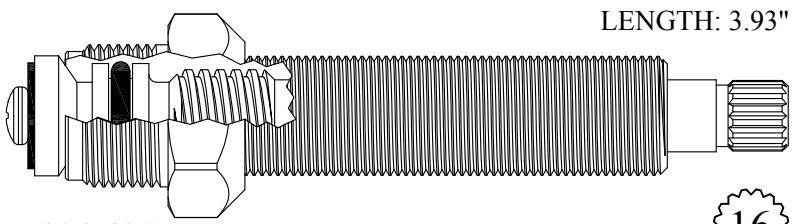

FOR ROYAL BRASS  
LENGTH: 3.93"

**403621**

GASKET: 895100

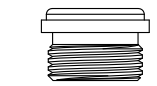

SEAT USED: LF648170

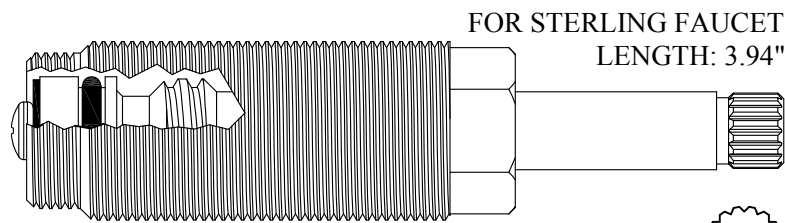

FOR STERLING FAUCET  
LENGTH: 3.94"

**403511/ 403512**

GASKET: 895150



SEAT USED: 647190

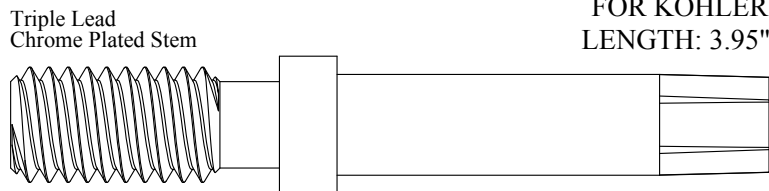

Triple Lead  
Chrome Plated Stem

FOR KOHLER  
LENGTH: 3.95"

**203211**

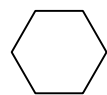

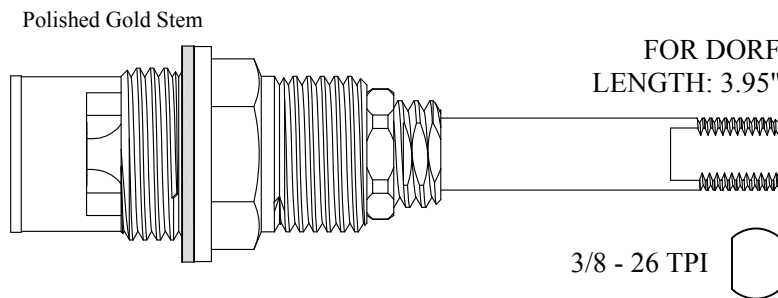
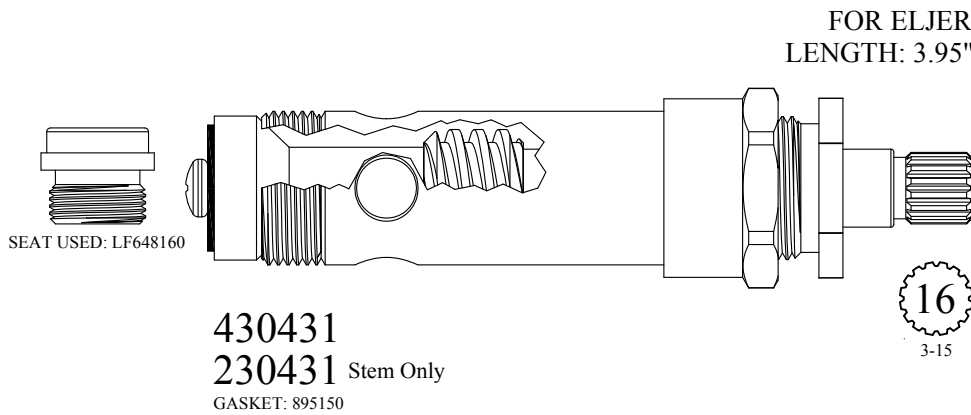
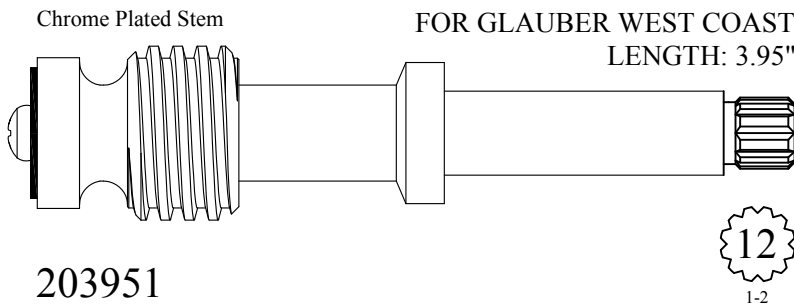
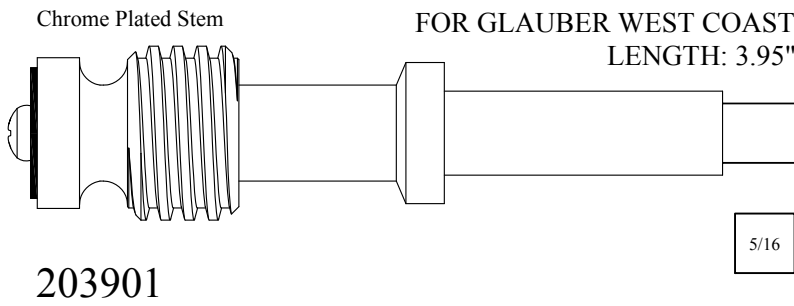

DISC SET: 151380-PKG  
GASKET: 895370 INCLUDED

Also available with a Polished Chrome Plated Stem  
LF469301-CP / LF469302-CP

Polished Gold Stem

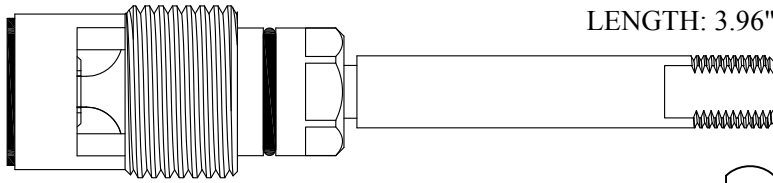

FOR DORF  
LENGTH: 3.96"

3/8 - 26 TPI

Nut Also available

369500

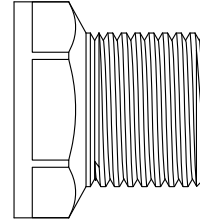

**LF469501/ LF469502**

DISC SET: 151380-PKG  
GASKET: 895370

Also available with a Polished Chrome Plated Stem  
**LF469501-CP / LF469502-CP**

FOR PRICE PFISTER  
LENGTH: 3.97"

Chrome Plated Unit

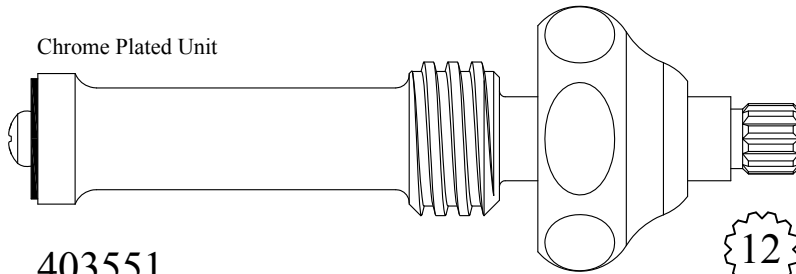

**403551**

**203551** Stem Only



1-2

FOR STERLING FAUCET  
LENGTH: 3.98"



SEAT USED: LF648170

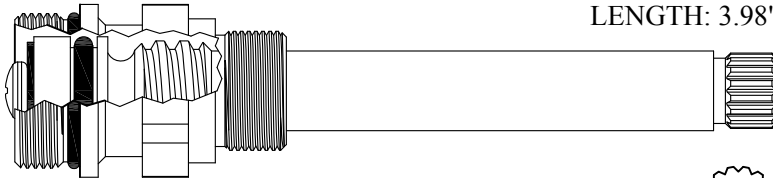

**403921**

GASKET: 890170 O-RING INCLUDED



1-5

Chrome Plated Stem

FOR ELJER  
LENGTH: 3.98"

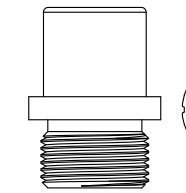

SEAT USED: LF649640

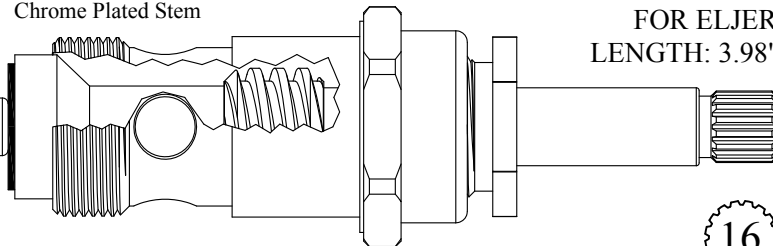

**430251**

**230251** Stem Only

GASKET: 895320



3-15



SEAT USED: LF648410

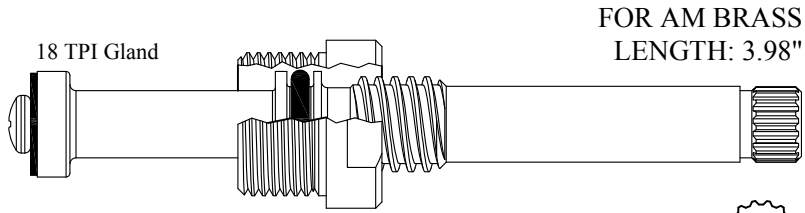

18 TPI Gland

FOR AM BRASS  
LENGTH: 3.98"

**403601 / 403602**

GASKET: 895100



SEAT USED: LF648410

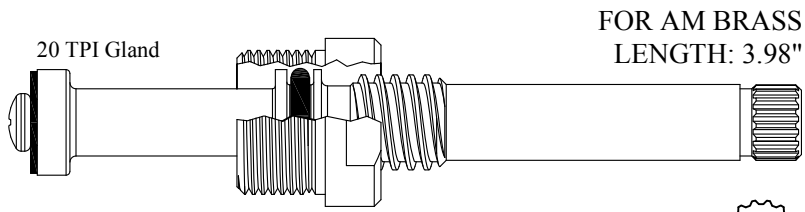

20 TPI Gland

FOR AM BRASS  
LENGTH: 3.98"

**403611/ 403612**

GASKET: 895100

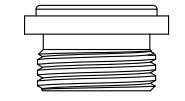

SEAT USED: LF649010

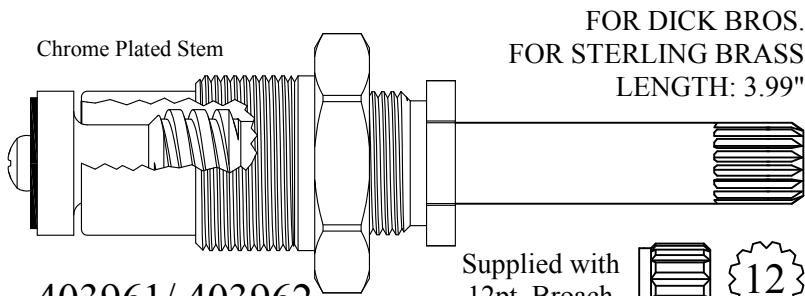

Chrome Plated Stem

FOR DICK BROS.  
FOR STERLING BRASS  
LENGTH: 3.99"

**403961/ 403962**  
**203961/ 203962** Stem Only

GASKET: 895370

Supplied with  
12pt. Broach

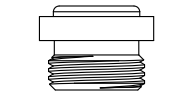

SEAT USED: LF648120

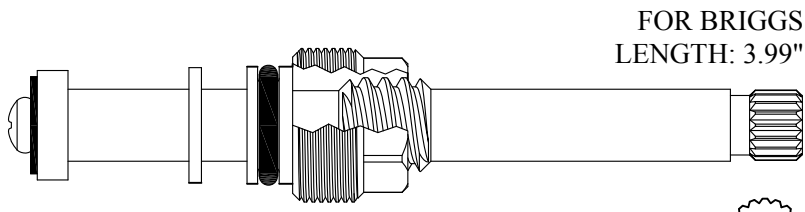

FOR BRIGGS  
LENGTH: 3.99"

**404111/ 404112**



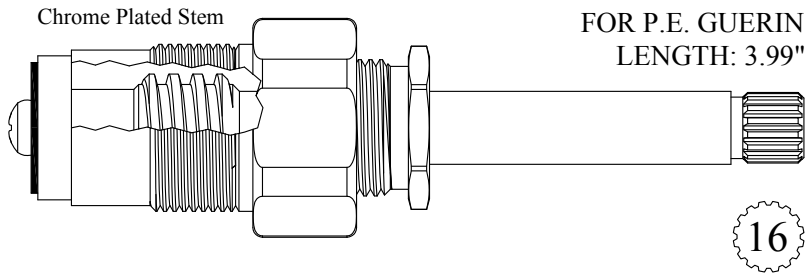

404421/ 404422  
GASKET: 895400

FOR P.E. GUERIN  
LENGTH: 3.99"

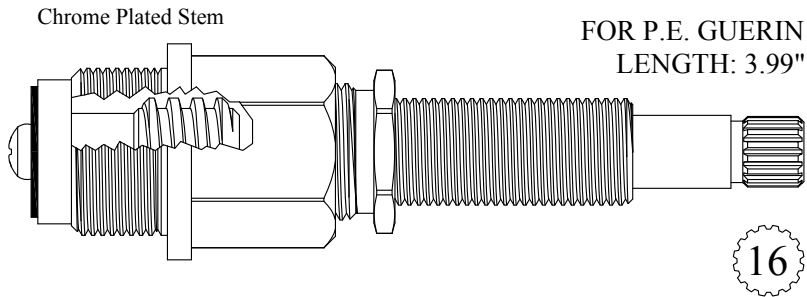

404431/ 404432  
GASKET: 895400

FOR P.E. GUERIN  
LENGTH: 3.99"

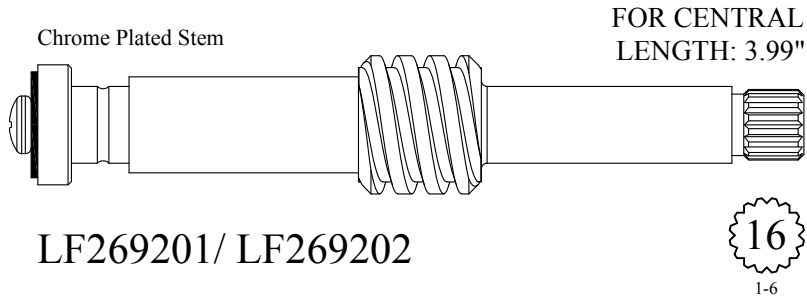

LF269201/ LF269202

FOR CENTRAL  
LENGTH: 3.99"

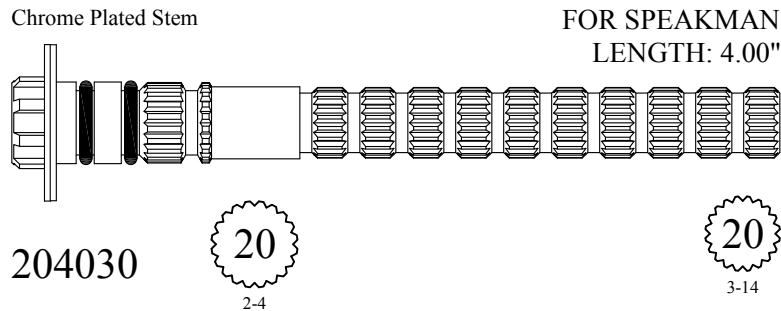

204030

FOR SPEAKMAN  
LENGTH: 4.00"

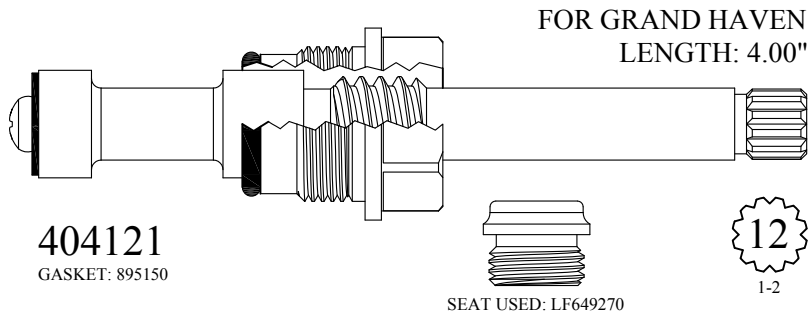

404121  
GASKET: 895150

SEAT USED: LF649270

12  
1-2

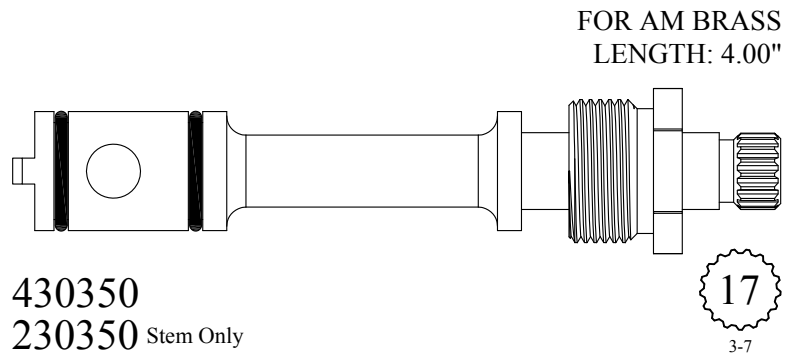

430350  
230350 Stem Only

17  
3-7

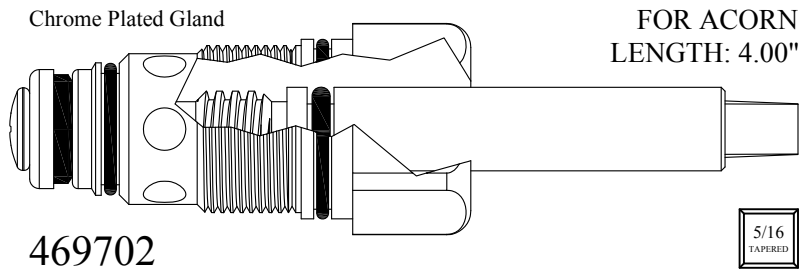

469702

5/16  
TAPERED

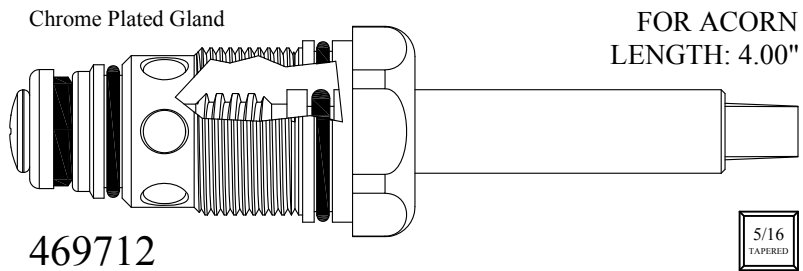

469712

5/16  
TAPERED

Chrome Plated Stem

FOR DWYER  
LENGTH: 4.00"

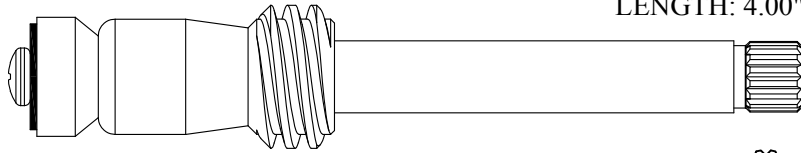

LF270041/ LF270042

16  
1-6

Chrome Plated Stem

FOR AM BRASS  
LENGTH: 4.00"



SEAT USED: LF649240

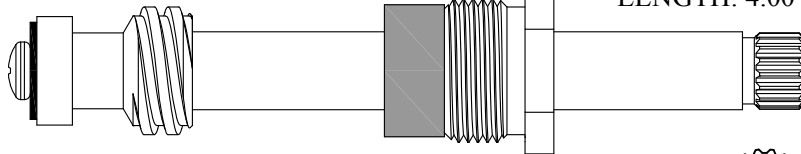

LF470021/ LF470022  
LF270021/ LF270022

Stem Only

17  
3-7

UNKNOWN  
LENGTH: 4.01"

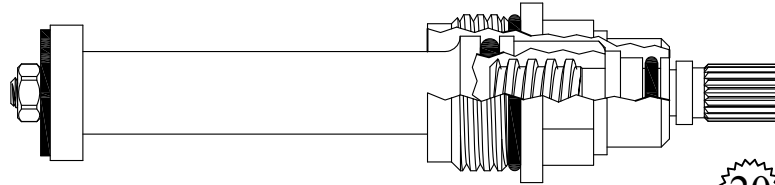

426812

GASKET: 890170 O-RING INCLUDED

20  
3-20

Chrome Plated Stem & Tube

FOR MOEN  
LENGTH: 4.01"

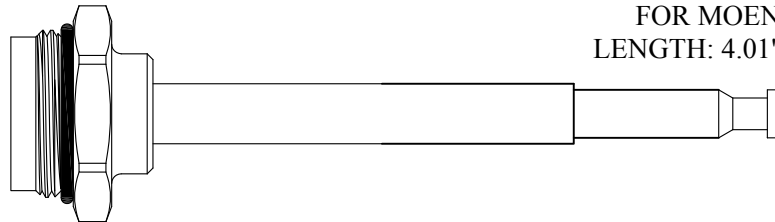

430460

GASKET: 890190 O-RING INCLUDED



SEAT USED: LF649640

Chrome Plated Stem

FOR ELJER  
LENGTH: 4.01"

16  
3-15

Also available with polished brass stem

404001/ 404002  
204001/ 204002 Stem Only

404001-PB/ 404002-PB  
204001-PB/ 204002-PB Stem Only

GASKET: 895330

SEAT USED: LF648620

Chrome Plated Stem

FOR ELJER  
LENGTH: 4.01"

16  
3-15

Also available with polished brass stem

404021/ 404022  
204001/ 204002 Stem Only

404021-PB/ 404022-PB  
204001-PB/ 204002-PB Stem Only

GASKET: 895120

SEAT USED: 648510  
or LF648120

LF648120

648510

FOR BRIGGS  
LENGTH: 4.02"

18  
3-3

404101/ 404102

GASKET: 895150

SEAT USED: LF648760

FOR SPEAKMAN  
LENGTH: 4.035"

20  
2-4

430121  
230121 Stem Only

GASKET: 895160

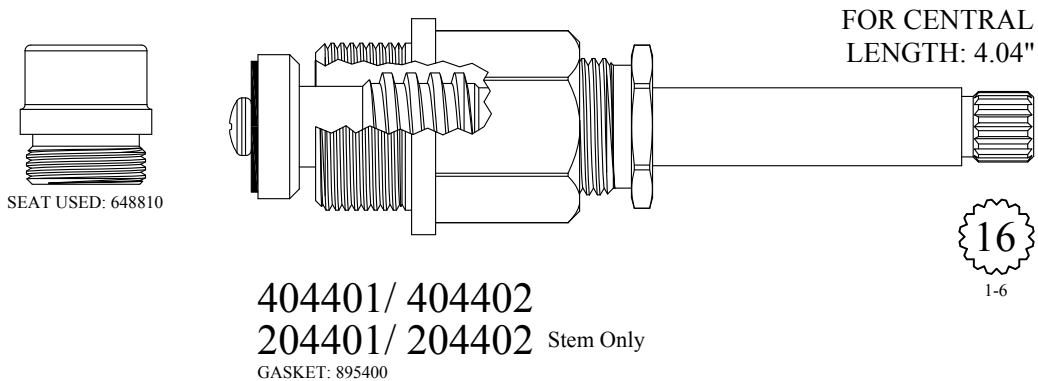
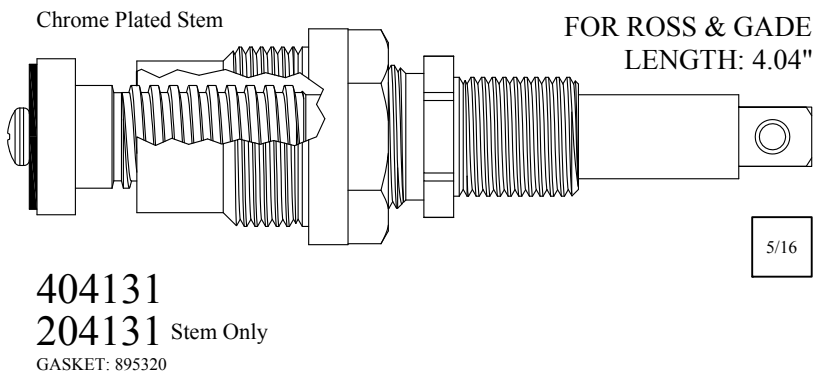
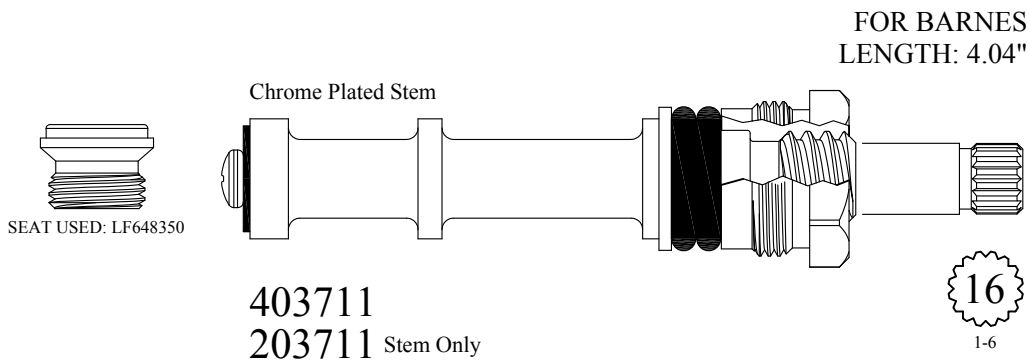
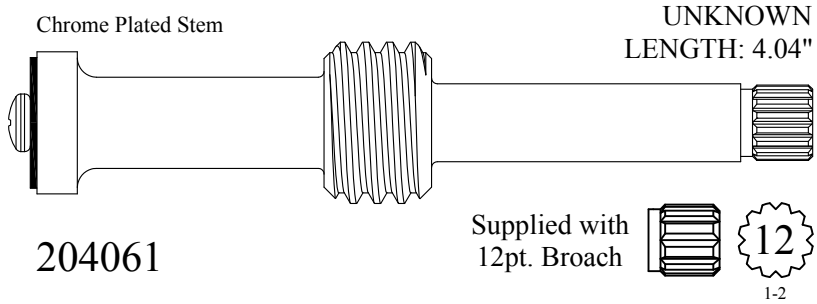

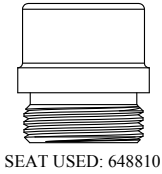

SEAT USED: 648810

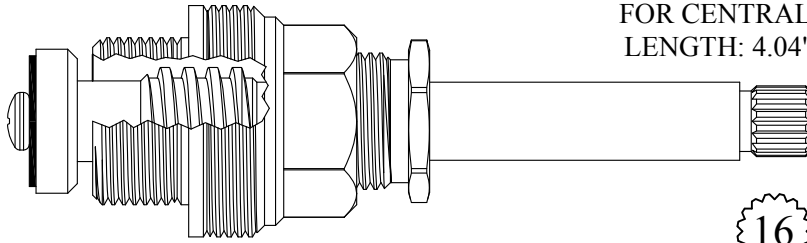

FOR CENTRAL  
LENGTH: 4.04"

16  
1-6

404411/ 404412  
204401/ 204402 Stem Only  
GASKET: 895400

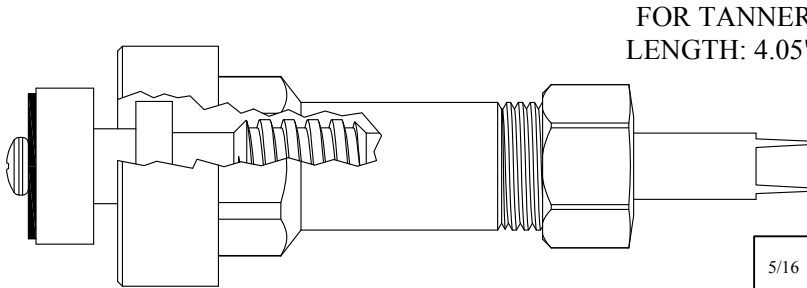

FOR TANNER  
LENGTH: 4.05"

5/16  
Tapered

470811  
GASKET: 894860 INCLUDED



SEAT USED: LF648930

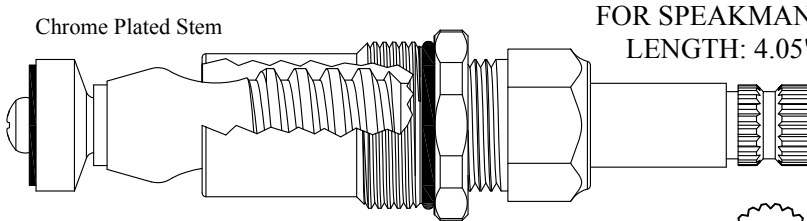

FOR SPEAKMAN  
LENGTH: 4.05"

20  
2-4

LF470101/ LF470102  
LF270101/ LF270102 Stem Only  
GASKET: 890180 O-RING INCLUDED



SEAT USED: LF648960

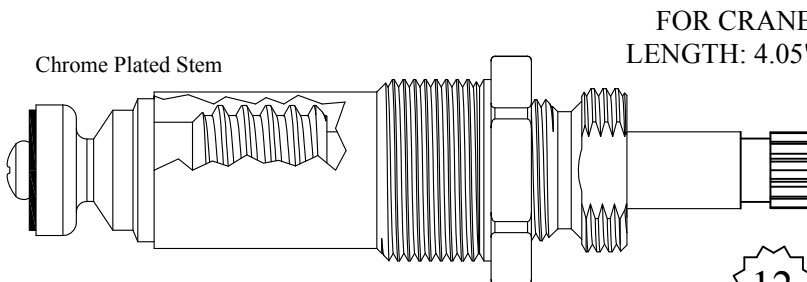

FOR CRANE  
LENGTH: 4.05"

12  
3-10

LF470211  
GASKET: 895320



SEAT USED: LF648960

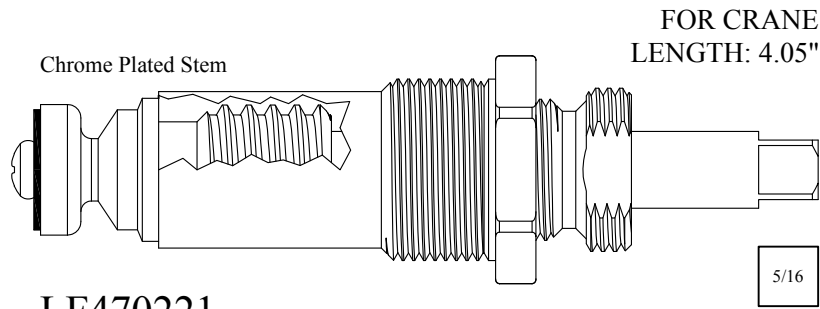

**LF470221**

GASKET: 895320

FOR CRANE  
LENGTH: 4.05"



SEAT USED: LF648320

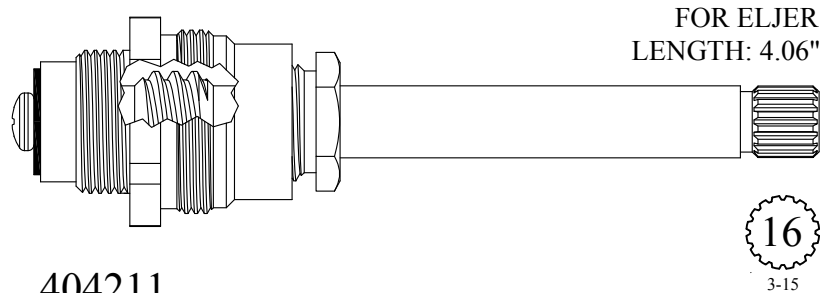

**404211**

**204221** Stem Only

GASKET: 895100

FOR ELJER  
LENGTH: 4.06"

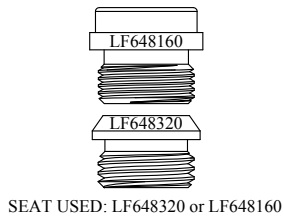

SEAT USED: LF648320 or LF648160

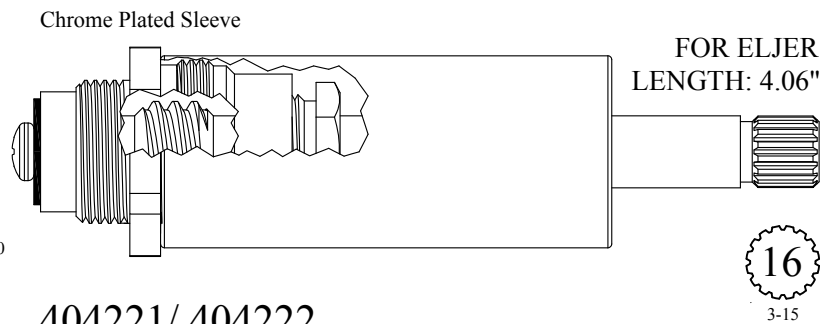

**404221/ 404222**

**204221/ 204222** Stem Only

GASKET: 895100

FOR ELJER  
LENGTH: 4.06"

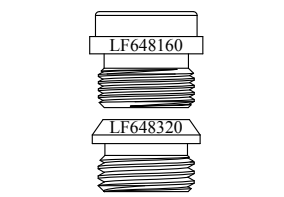

SEAT USED: LF648320 or LF648160

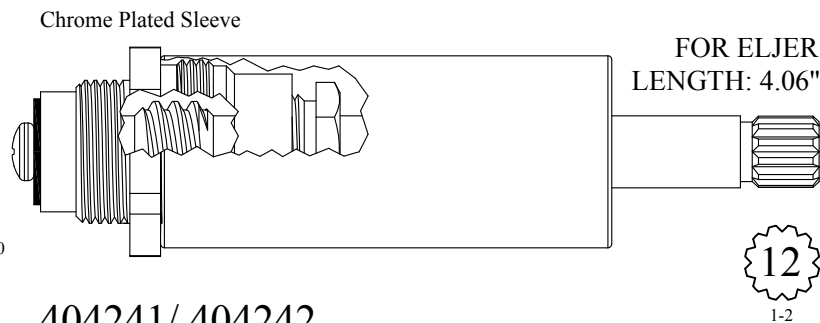

**404241/ 404242**

**204241/ 204242** Stem Only

GASKET: 895100

FOR ELJER  
LENGTH: 4.06"

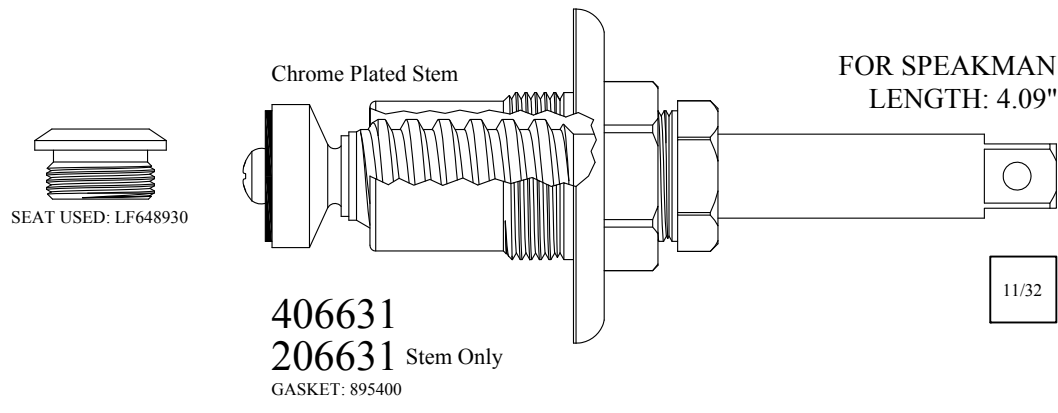
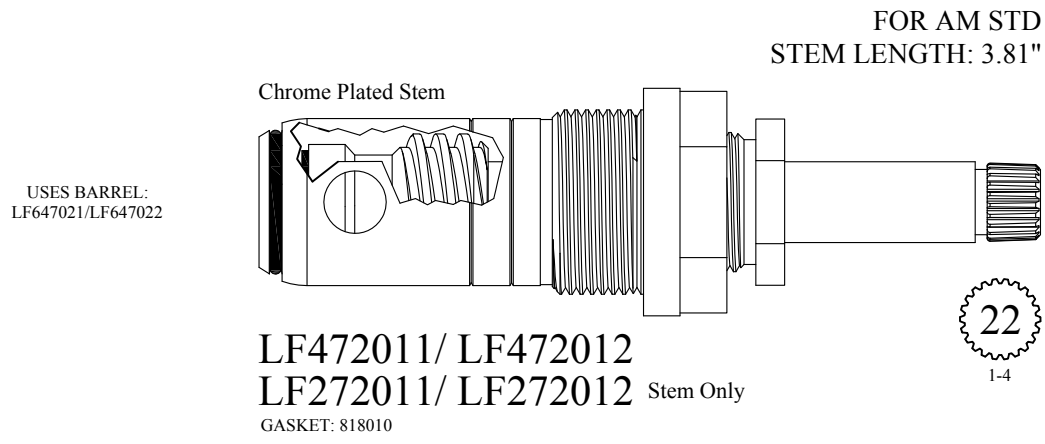
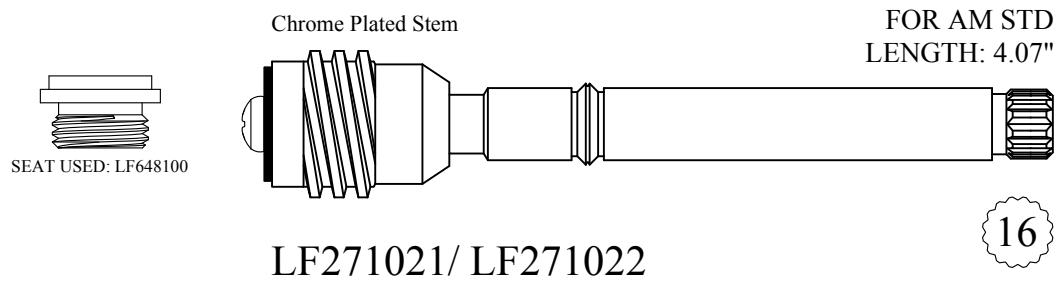
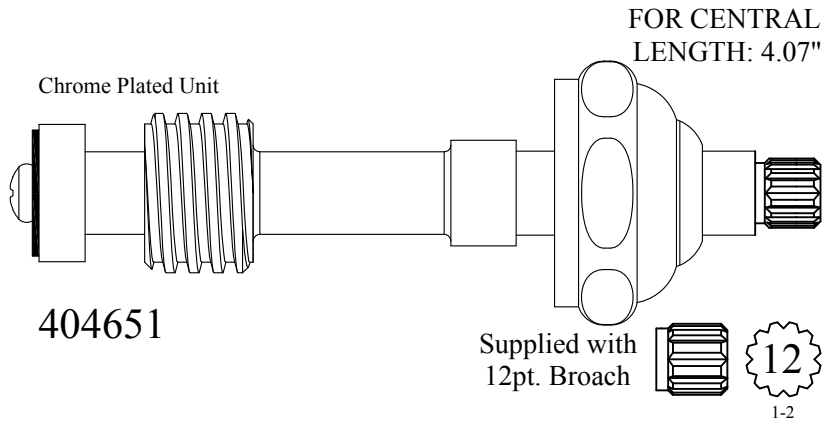

Old Style - Automatic with Brass Link

FOR ROHL  
FOR GERBER  
FOR DANFOSS  
FOR TEMPRESS  
LENGTH: 4.09"

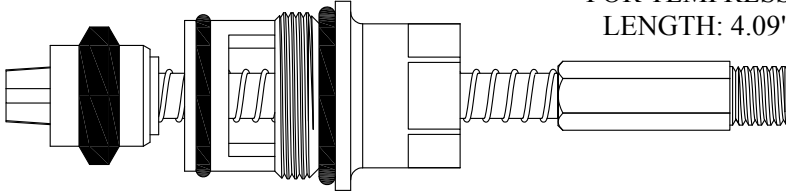

431130

GASKET: 894120 O-RING INCLUDED

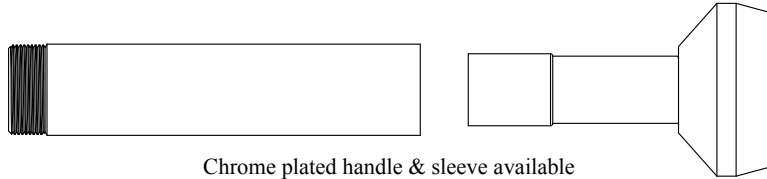

Chrome plated handle & sleeve available

128540

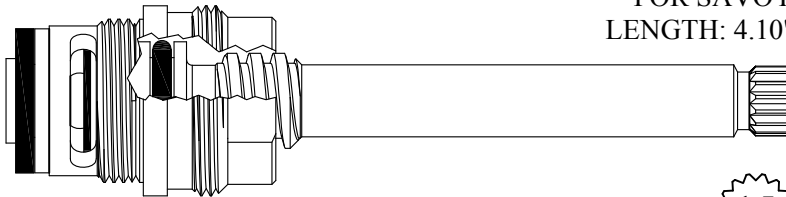

FOR SAVOY  
LENGTH: 4.10"

403341

GASKET: 895400  
SEAT INCLUDED: LF648850

Also available with monel seat 648850-M

403341-M

15  
1-13

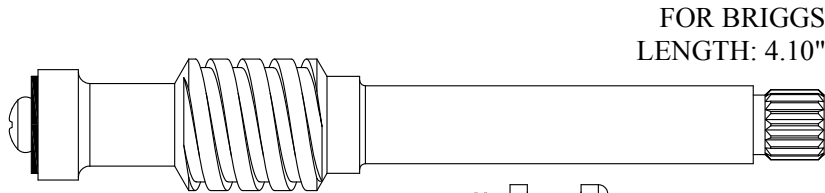

FOR BRIGGS  
LENGTH: 4.10"

LF271011/ LF271012

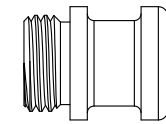

SEAT USED: LF648250

18  
3-3

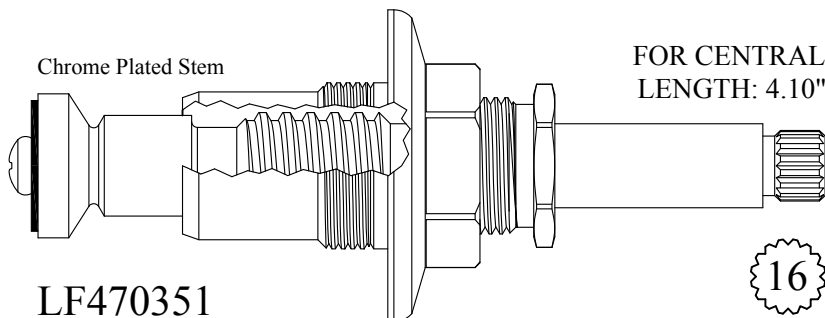

Chrome Plated Stem

FOR CENTRAL  
LENGTH: 4.10"

LF470351

GASKET: 895410

16  
1-6

Chrome Plated Push Button

FOR SYMMONS  
LENGTH: 4.11"

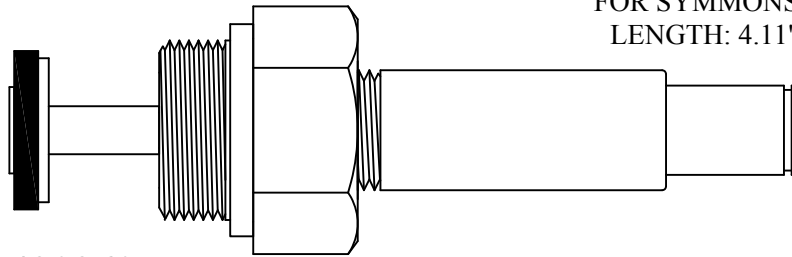

**430360**

GASKET: 895350 INCLUDED

FOR MUELLER  
LENGTH: 4.12"

Chrome Plated Unit

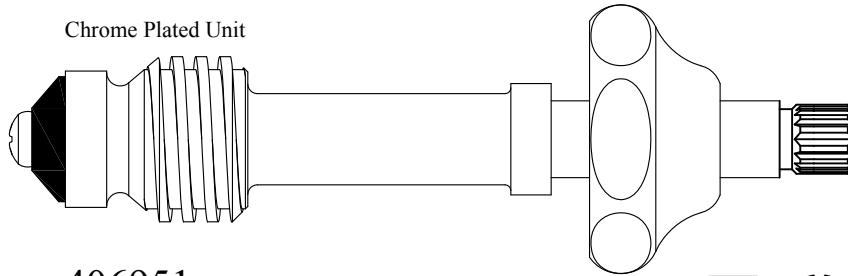

**406951**

**206951** Stem Only

Supplied with  
12pt. Broach



1-2

Chrome Plated Stem

FOR ART F  
LENGTH: 4.12"



SEAT USED: LF649430

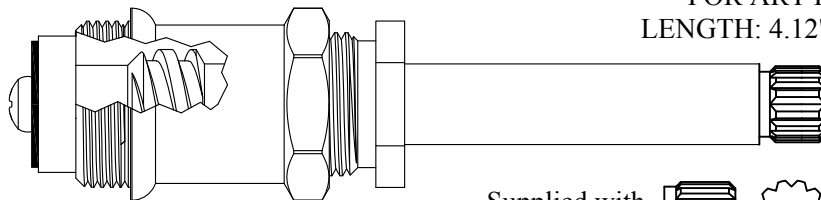

Supplied with  
12pt. Broach



1-2

**404661/ 404662**

**204661/ 204662** Stem Only

GASKET: 895400

Chrome Plated Stem

FOR BLOCK BRASS  
LENGTH: 4.14"

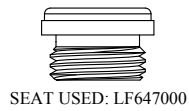

SEAT USED: LF647000

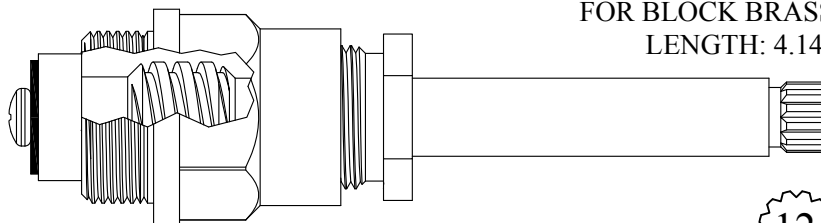

1-2

**404751/ 404752**

**204751/ 204752** Stem Only

GASKET: 895290

Chrome Plated Stem

FOR SPEAKMAN  
LENGTH: 4.14"

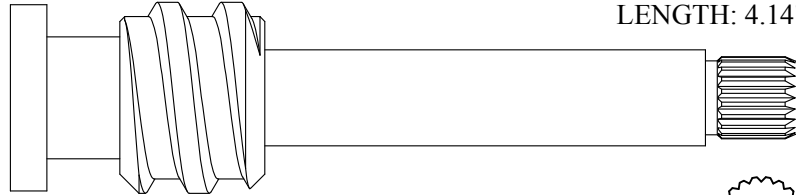

204511

20  
2-4

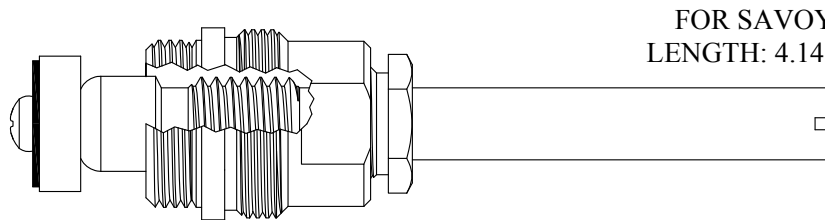

FOR SAVOY  
LENGTH: 4.14"

405521

GASKET: 895400

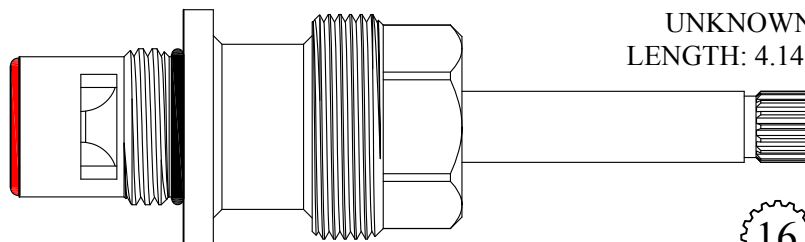

UNKNOWN  
LENGTH: 4.14"

404301/ 404302

GASKET: 890170 O-RING INCLUDED  
SEAL: 898580-R/B  
DISC SET: 151380-PKG

16  
3-16

Chrome Plated Stem

FOR BLOCK BRASS  
LENGTH: 4.14"

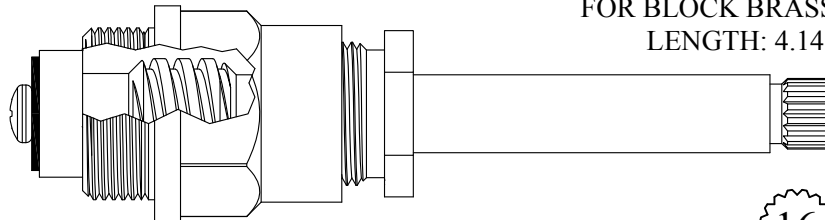

404701/ 404702

204701/ 204702 Stem Only

GASKET: 895290

16  
1-6

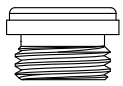

SEAT USED: LF647000



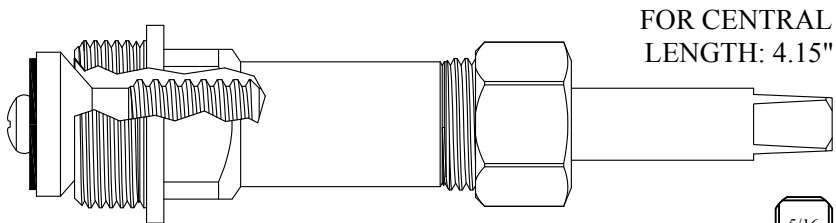

FOR CENTRAL  
LENGTH: 4.15"

5/16

TAPERED

**470771**

GASKET: 895400



SEAT USED: LF648260

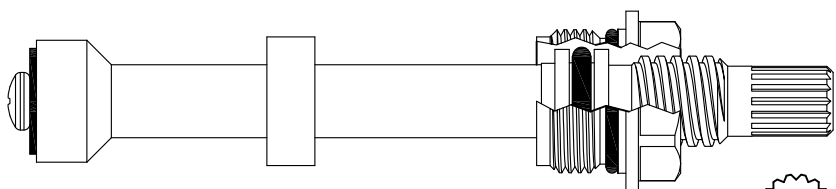

FOR ROYAL BRASS  
LENGTH: 4.15"

16

1-6

**LF470301/ LF470302**

GASKET: 890160 O-RING INCLUDED

CERAMIN CONVERSION FOR BROADWAY COMPRESSION  
LENGTH: 4.16"

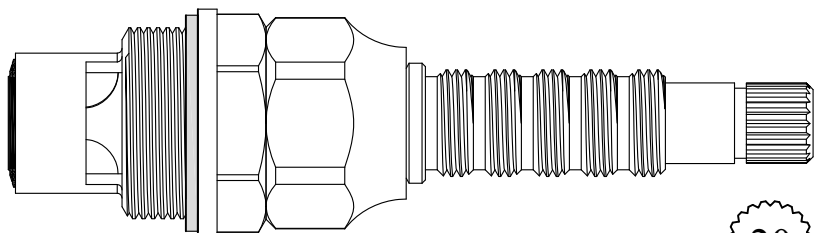

20

2-4

**404621**

GASKET INCLUDED: 895550

SEAL: 898510

DISC SET: 151380-PKG



SEAT USED: LF648130

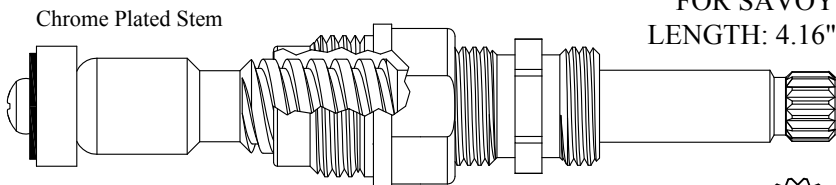

Chrome Plated Stem

FOR SAVOY  
LENGTH: 4.16"

15

1-13

**LF469011/ LF469012**

**LF269011/ LF269012** Stem Only

GASKET: 895100

FOR BRIGGS  
LENGTH: 4.17"

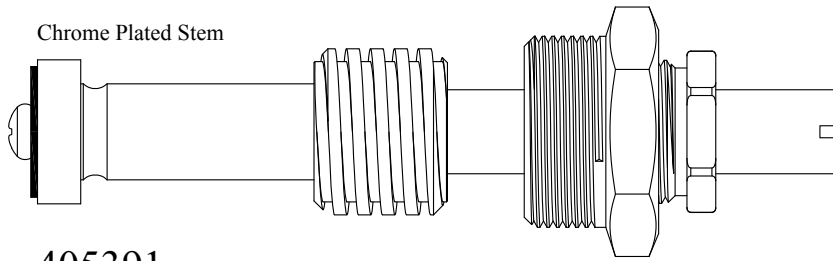

405391  
205391 Stem Only  
GASKET: 895340

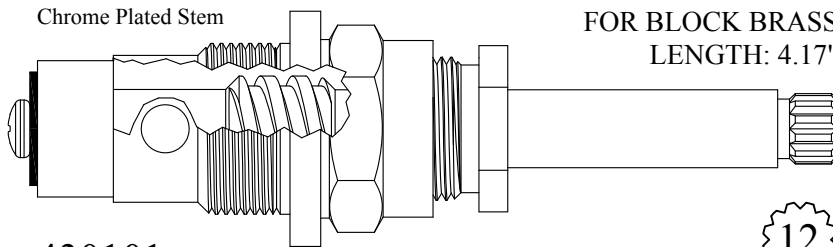

FOR BLOCK BRASS  
LENGTH: 4.17"

430101  
230101 Stem Only  
GASKET: 895290

12  
1-2

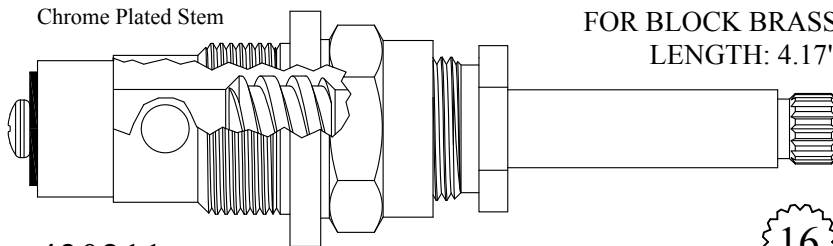

FOR BLOCK BRASS  
LENGTH: 4.17"

430211  
230211 Stem Only  
GASKET: 895290

16  
1-6

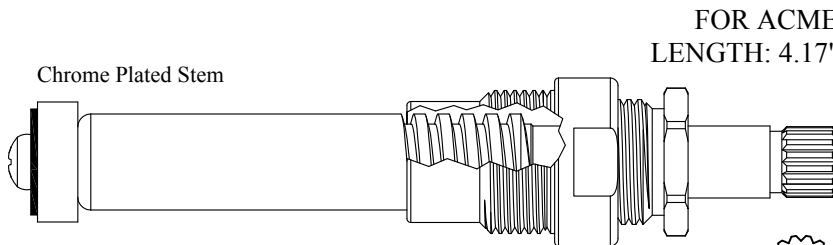

FOR ACME  
LENGTH: 4.17"

LF469801  
LF269801 Stem Only  
GASKET: 895100

16  
1-6

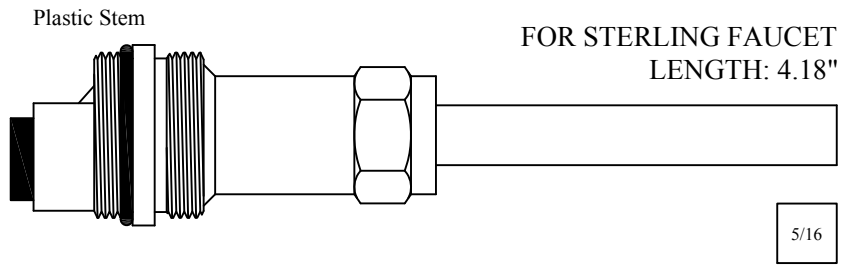

**404810**  
**204810** Stem Only  
 GASKET: 890190 O-RING INCLUDED

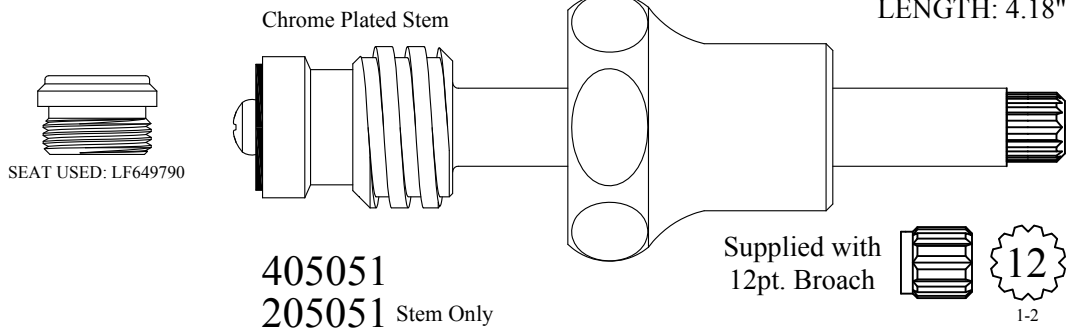

**405051**  
**205051** Stem Only

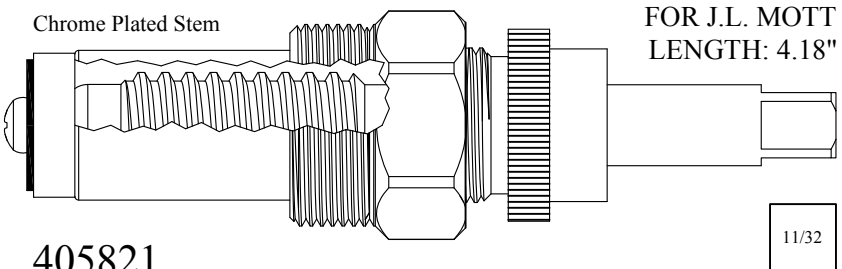

**405821**  
**205821** Stem Only  
 GASKET: 895160

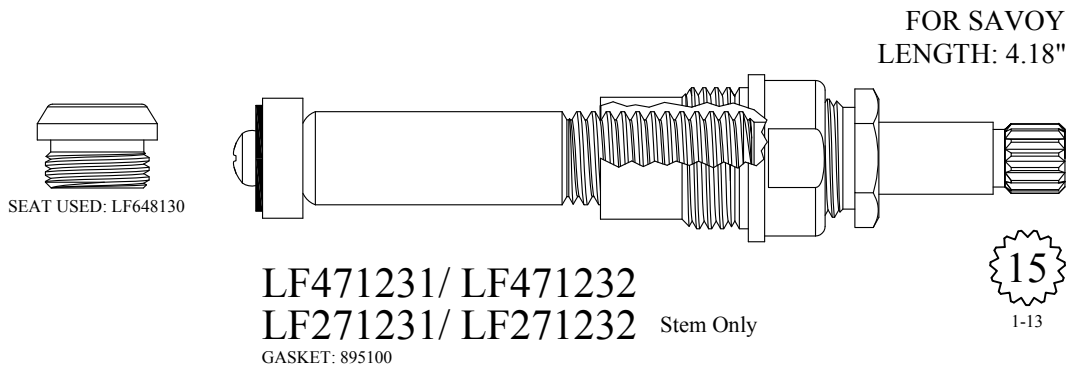

**LF471231/ LF471232**  
**LF271231/ LF271232** Stem Only  
 GASKET: 895100

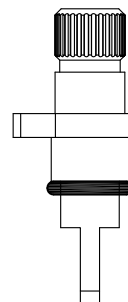
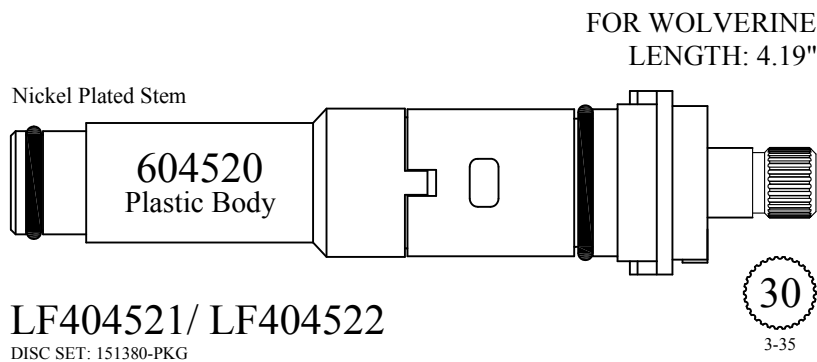
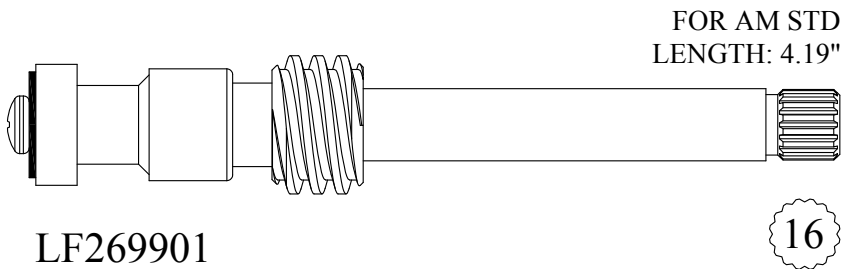
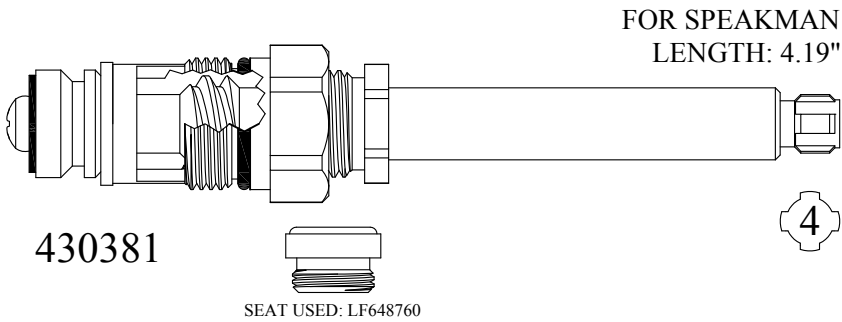
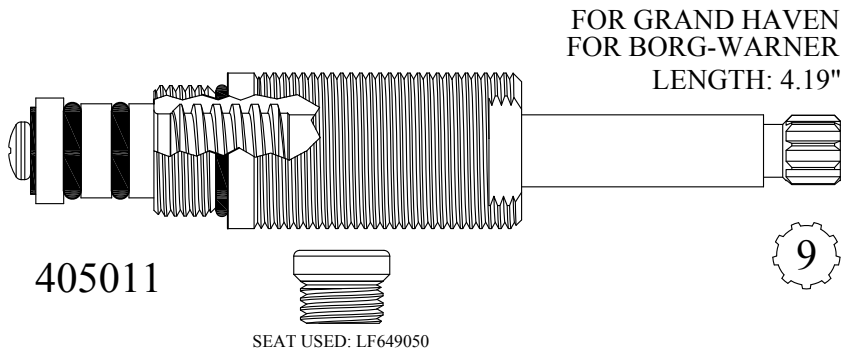

Available: Stem Only  
**LF263321**  
**LF263322**  
 Also available as  
 a RH/LH Kit  
**LF404521-2**  
 Kit includes:  
 (1) 263321  
 (1) 263322  
 (1) 604520

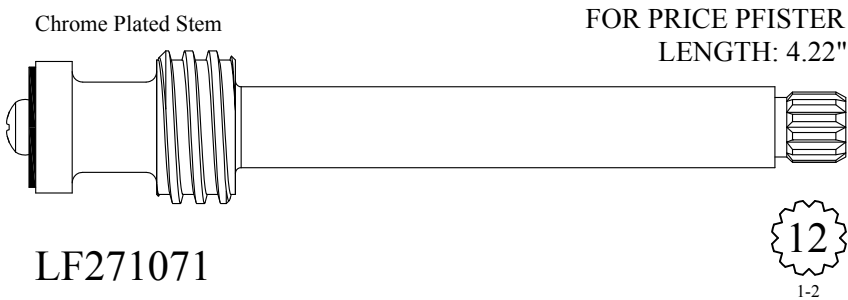
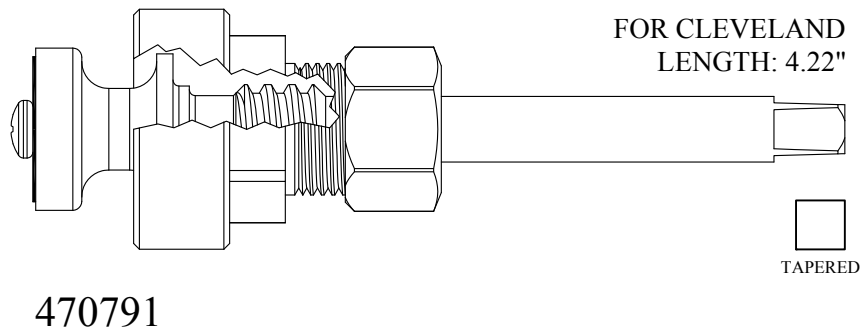
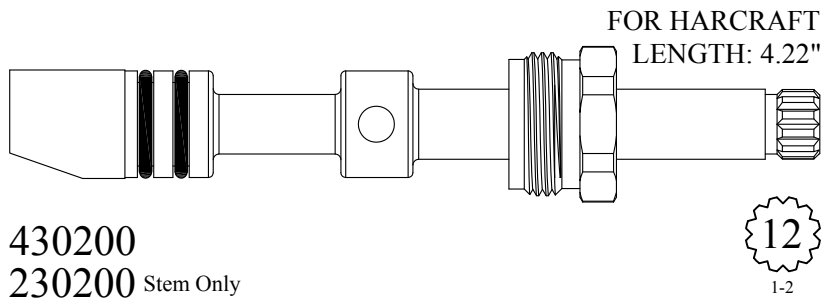
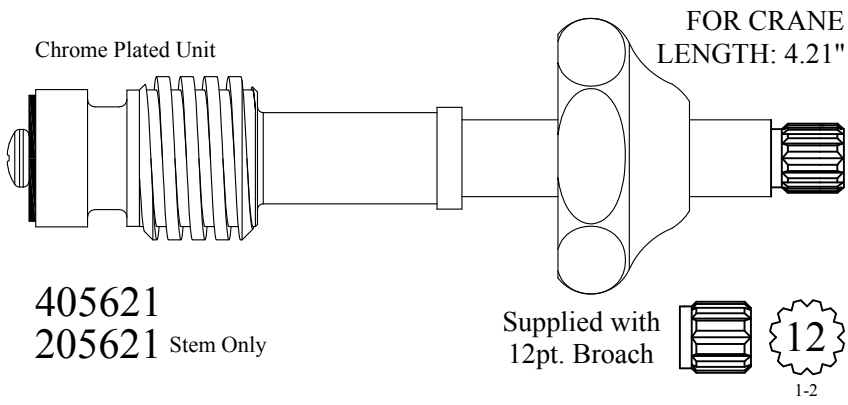

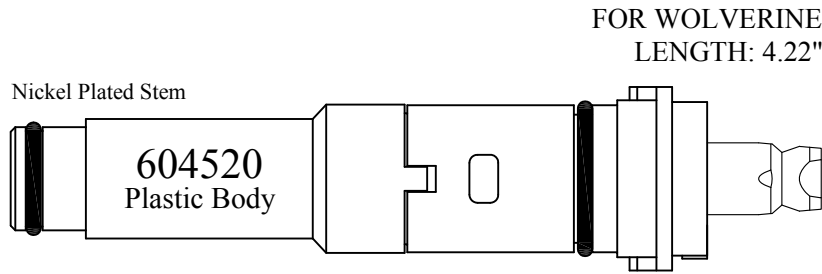

Available: Stem Only  
**LF263361**  
**LF263362**

Also available as  
 a RH/LH Kit  
**LF404531-2**

Kit includes:  
 (1) 263361  
 (1) 263362  
 (1) 604520

**LF404531/ LF404532**  
 DISC SET: 151380-PKG

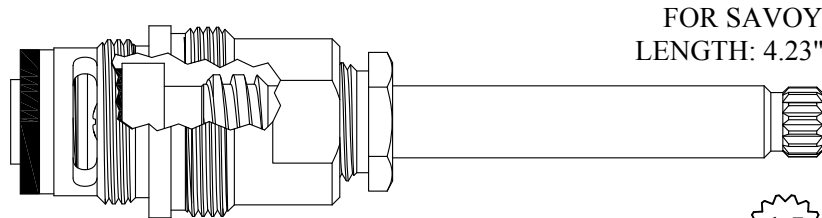

**15**  
 1-13

**403311** Also available with monel seat LF648850-M  
 GASKET: 895400SEAT  
 INCLUDED: LF648850

**403311-M**

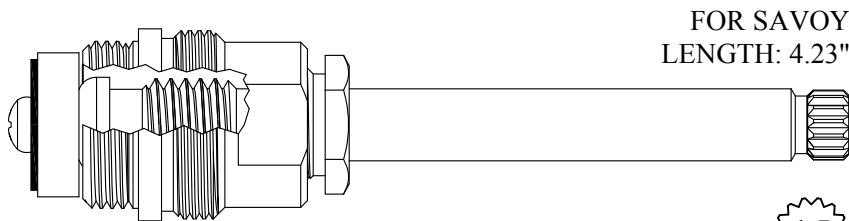

**15**  
 1-13

**405631**  
**205631** Stem Only  
 GASKET: 895400

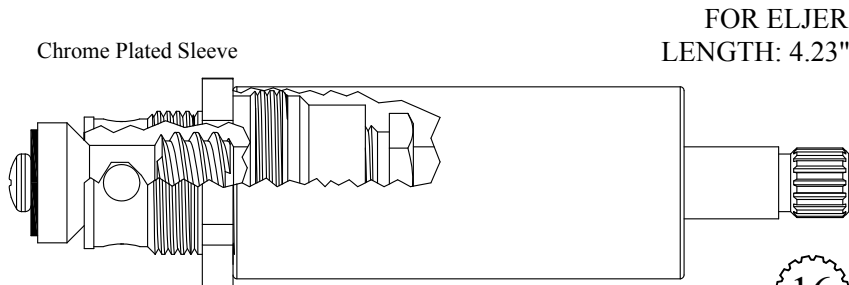

**16**  
 3-15

**430221**  
**230221** Stem Only  
 GASKET: 895100

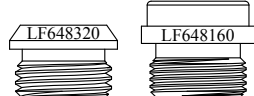

SEAT USED: LF648320 or LF648160

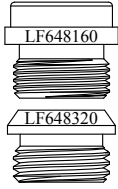

SEAT USED: LF648320 or LF648160

Chrome Plated Sleeve

FOR ELJER  
LENGTH: 4.23"

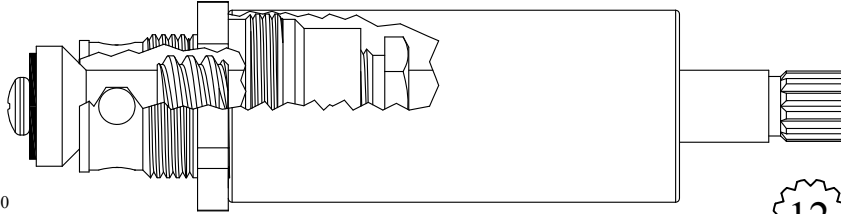

**430341**  
**230341** Stem Only  
GASKET: 895100

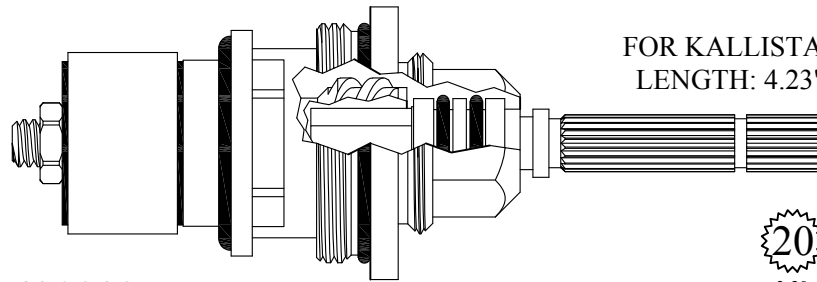

FOR KALLISTA  
LENGTH: 4.23"

**430982**  
GASKET: 890210 O-RING INCLUDED



SEAT USED: LF649050

FOR BORG-WARNER  
LENGTH: 4.23"

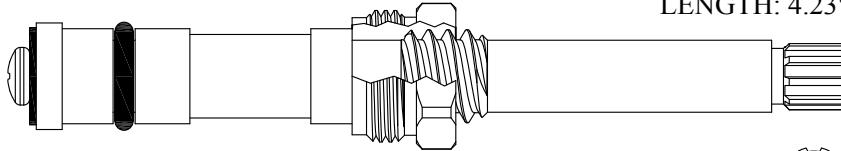

**LF470801**



SEAT USED: 648370

FOR PRICE PFISTER  
LENGTH: 4.24"

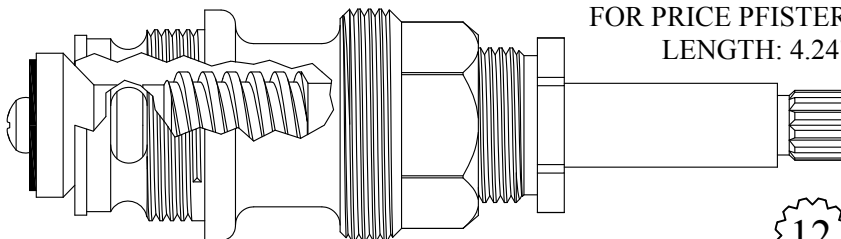

**430301**  
**230301** Stem Only  
GASKET: 895550



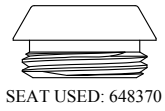

SEAT USED: 648370

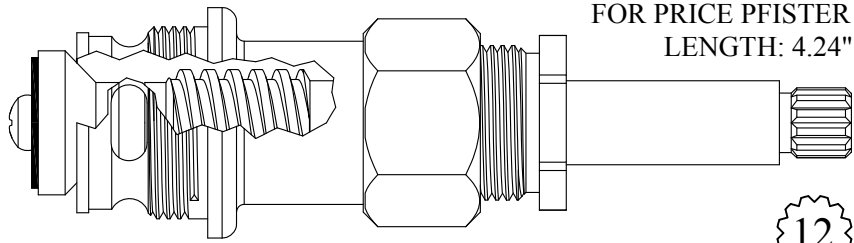

FOR PRICE PFISTER  
LENGTH: 4.24"



1-2

**430311**  
**230301** Stem Only  
GASKET: 895550

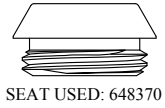

SEAT USED: 648370

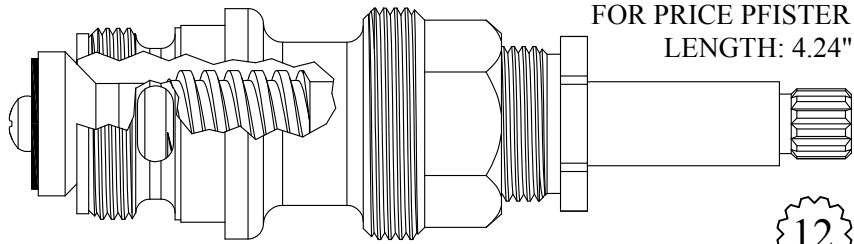

FOR PRICE PFISTER  
LENGTH: 4.24"



1-2

**430331**  
**230301** Stem Only  
GASKET: 895560

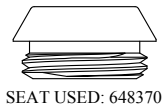

SEAT USED: 648370

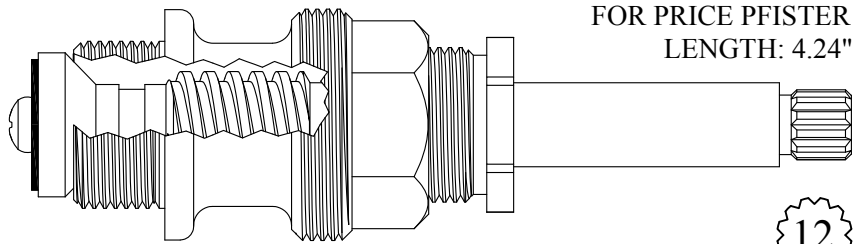

FOR PRICE PFISTER  
LENGTH: 4.24"



1-2

**405101/ 405102**  
**205101/ 205102** Stem Only  
GASKET: 895400

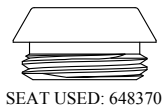

SEAT USED: 648370

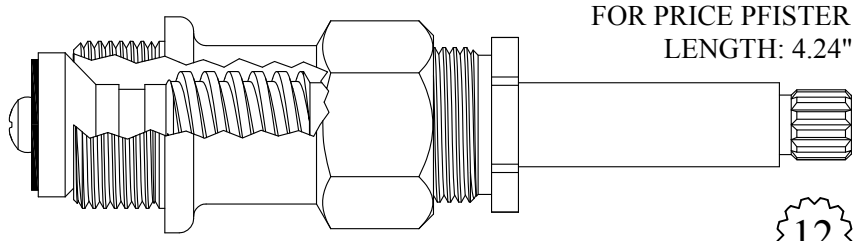

FOR PRICE PFISTER  
LENGTH: 4.24"



1-2

**405111/ 405112**  
**205101/ 205102** Stem Only  
GASKET: 895400



CERAMIC CONVERSION FOR KOHLER TREND  
LENGTH: 4.24"

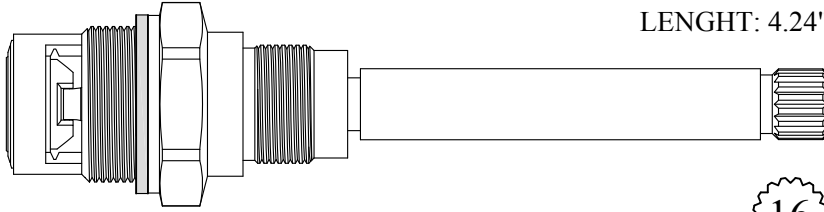

16  
1-6

404821/ 404822

GASKET: 895150 INCLUDED  
SEAL: 898510-W  
DISC SET: 151380-PKG

Chrome Plated Stem / Plastic Plunger

FOR KOHLER  
LENGTH: 4.24"

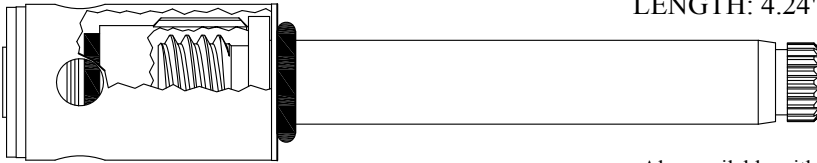

19  
1-7

LF470701/ LF470702  
LF270701/ LF270702 Stem Only  
SEAT INCLUDED: LF649460

Also available with Brass Plunger

LF470701-B / LF470702-B

Also available with Brass Plunger &  
Polished Gold stem

LF470701-PG / LF470702-PG  
LF270701-PG / LF270702-PG Stem Only

Chrome Plated Stem / Plastic Plunger

FOR KOHLER  
LENGTH: 4.24"

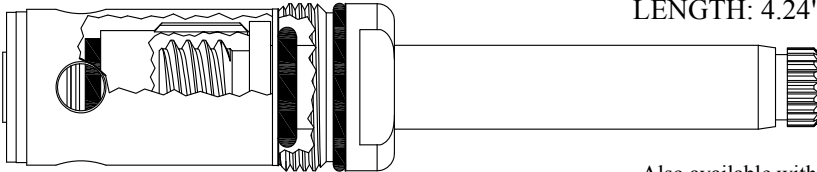

19  
1-7

LF470711/ LF470712  
LF270701/ LF270702 Stem Only  
GASKET: 890180 O-RING INCLUDED  
SEAT INCLUDED: LF649460

Also available with Brass Plunger

LF470711-B / LF470712-B

Also available with Brass Plunger &  
Polished Gold stem

LF470711-PG / LF470712-PG  
LF270701-PG / LF270702-PG Stem Only

Chrome Plated Stem / Plastic Plunger

FOR KOHLER  
LENGTH: 4.24"

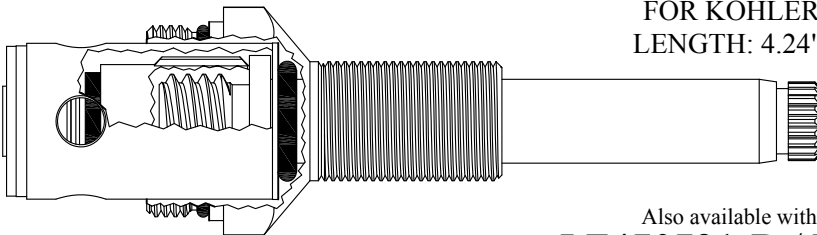

19  
1-7

LF470721/ LF470722  
LF270701/ LF270702 Stem Only  
GASKET: 890200 O-RING INCLUDED  
SEAT INCLUDED: LF649460

Also available with Brass Plunger

LF470721-B / LF470722-B

Also available with Brass Plunger &  
Polished Gold stem

LF470721-PG / LF470722-PG  
LF270701-PG / LF270702-PG Stem Only

Chrome Plated Escutcheon Tube #111460

FOR KOHLER  
LENGTH: 4.25"



SEAT USED: LF648070

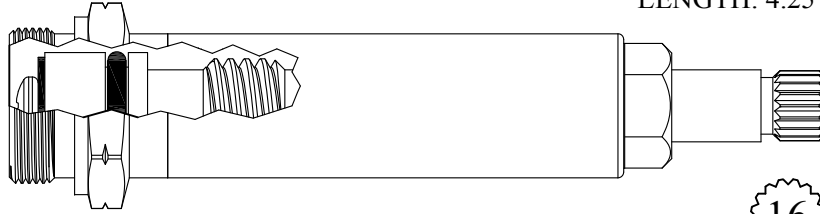

1-6

404201/ 404202  
204201/ 204202 Stem Only  
GASKET: 895150

Plastic Escutcheon Nipple #119040

FOR KOHLER  
LENGTH: 4.25"



SEAT USED: LF648070

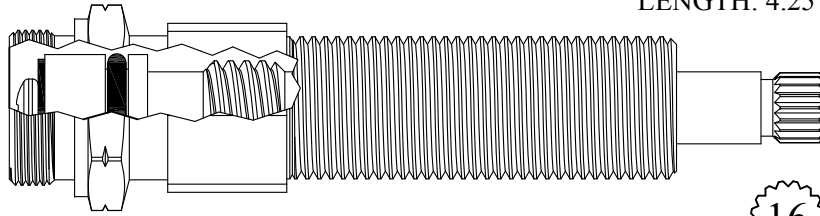

1-6

404231/ 404232  
204201/ 204202 Stem Only  
GASKET: 895150

Chrome Plated Escutcheon Tube #111460

FOR KOHLER  
LENGTH: 4.25"



SEAT USED: LF648070

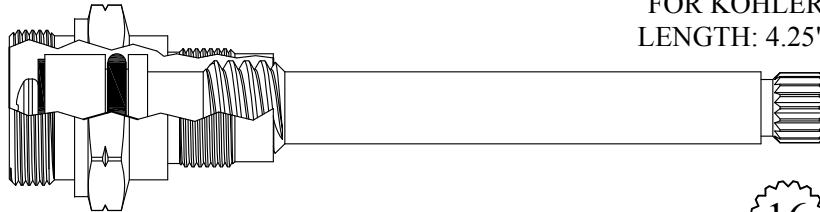

1-6

404331/ 404332  
204201/ 204202 Stem Only  
GASKET: 895150

CERAMIC CONVERSION FOR KOHLER LF470701/2  
Chrome Plated Stem  
LENGTH: 4.25"

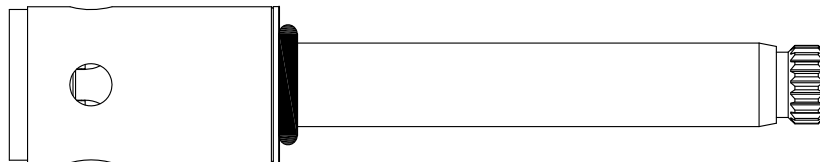

1-7

LF470741/ LF470742  
DISC SET: 151380-PKG

Also available with a Polished Gold Stem  
LF470741-PG / LF470742-PG

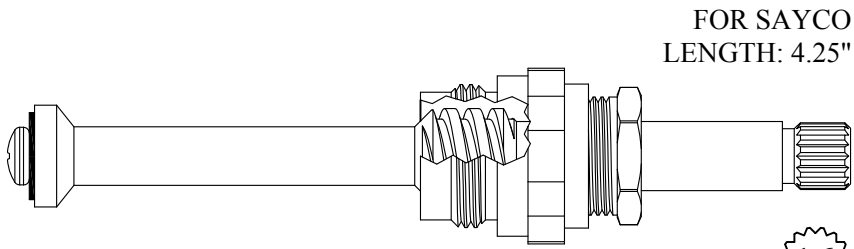

LF470951/ LF470952  
LF270951/ LF270952 Stem Only  
GASKET: 895100

16  
2-3

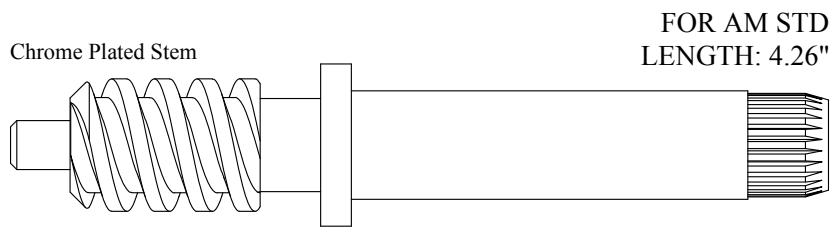

205731

26

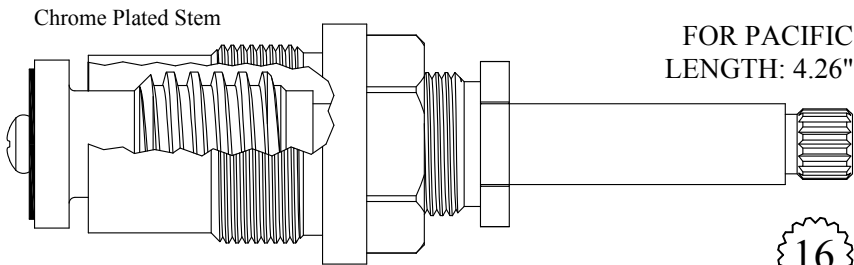

405921  
205921 Stem Only  
GASKET: 895540

16  
1-6

USES BARREL:  
LF647021/LF647022

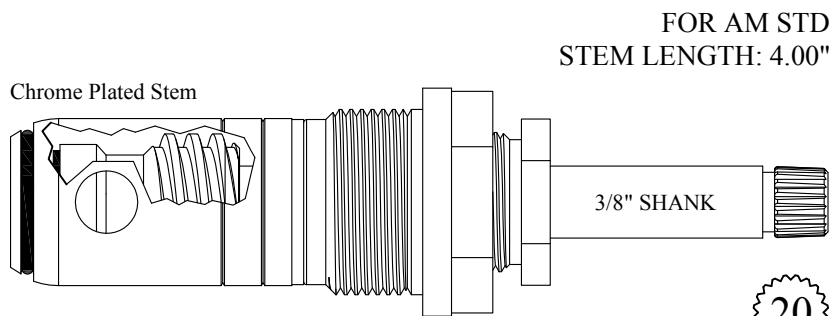

LF470201/ LF470202  
LF270201/ LF270202 Stem Only  
GASKET: 818010

20  
3-14

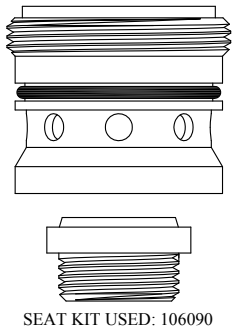

FOR ZURN  
FOR SYMMONS  
LENGTH: 4.27"

**205511** Stem Only  
GASKET: 895500 INCLUDED

12

Symmons Small

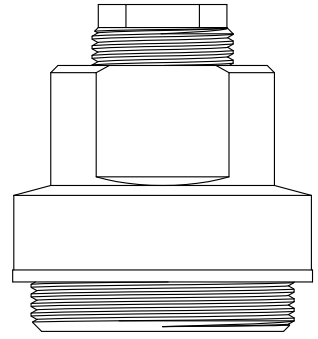

Also available with  
bonnet assembly  
#105671  
**405511**



FOR BURLINGTON  
LENGTH: 4.27"

**405811**  
**205811** Stem Only  
GASKET: 895100

16

1-6

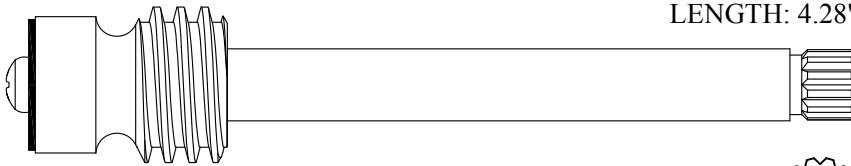

FOR AM STD  
LENGTH: 4.28"

**205661**

12

1-2

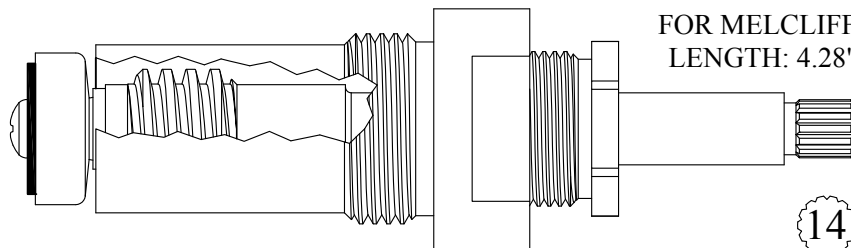

FOR MELCLIFF  
LENGTH: 4.28"

**405311**  
**205311** Stem Only  
GASKET: 895550

14

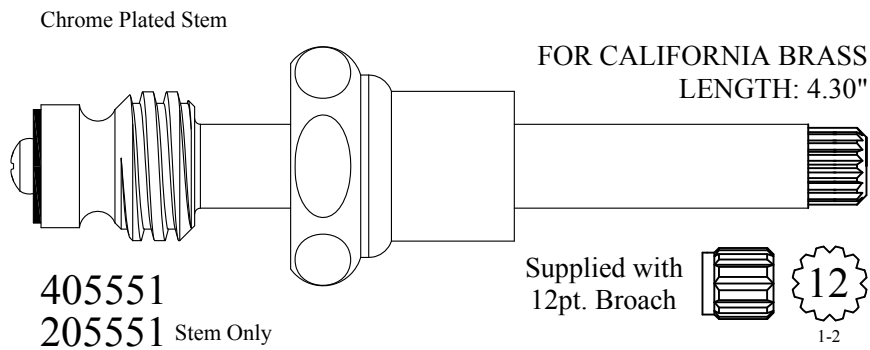
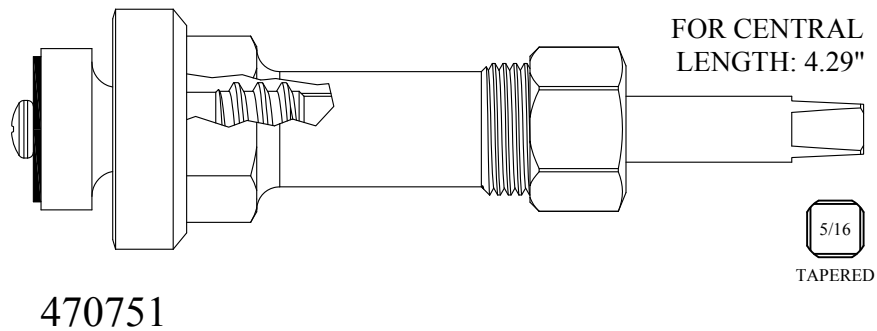
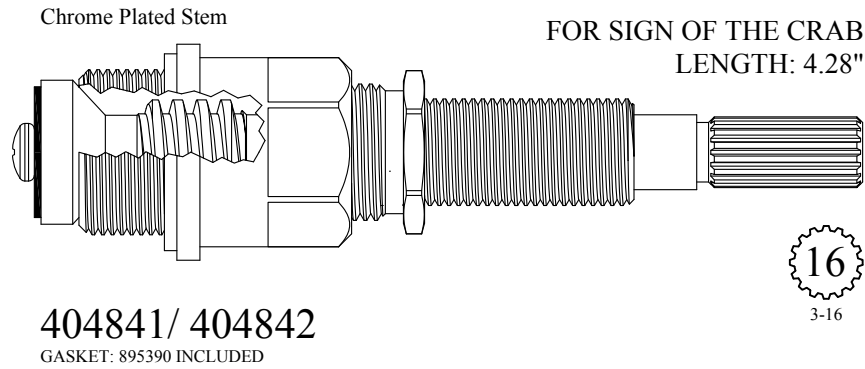
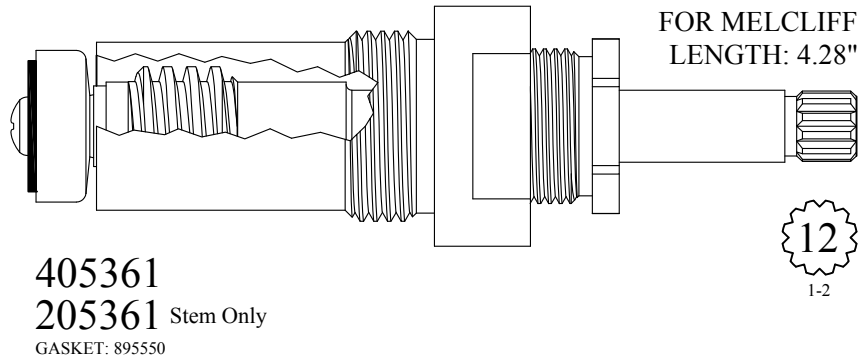

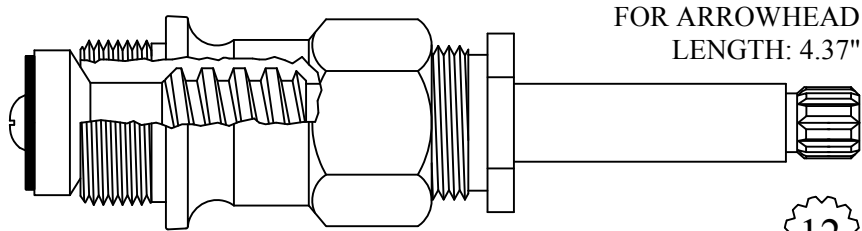

FOR ARROWHEAD  
LENGTH: 4.37"

12  
1-2

406411 Not Available, Use 415501  
LENGTH: 5.15"

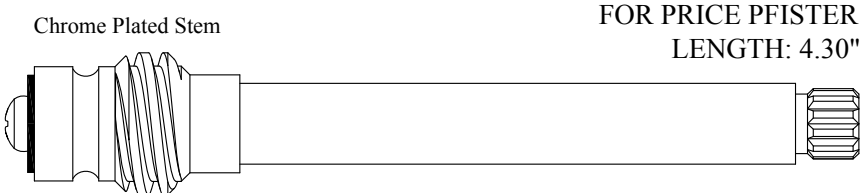

Chrome Plated Stem

FOR PRICE PFISTER  
LENGTH: 4.30"

LF272031/ LF272032



SEAT USED: LF648270

12  
1-2

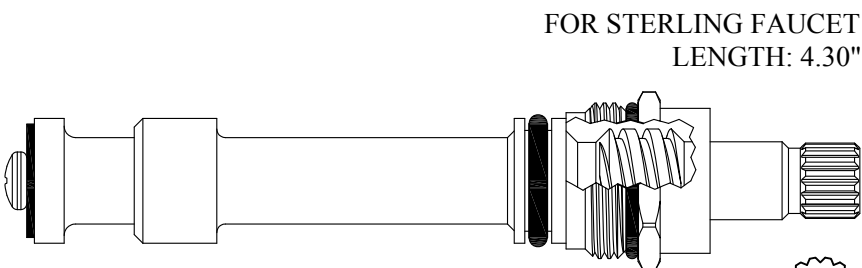

FOR STERLING FAUCET  
LENGTH: 4.30"



SEAT USED: LF648170

LF471001/ LF471002

GASKET: 890170 O-RING INCLUDED

16  
1-5

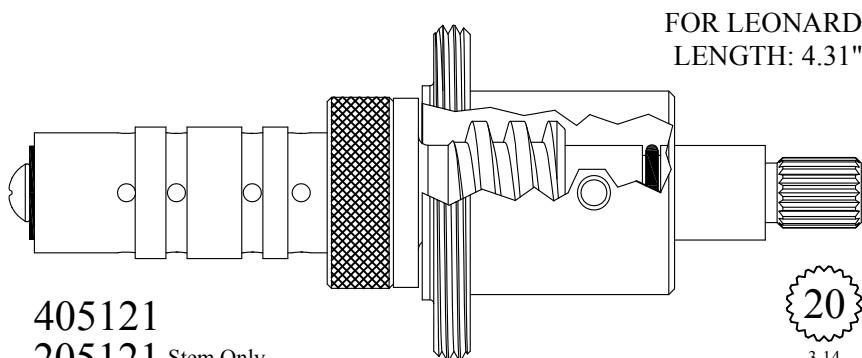

FOR LEONARD  
LENGTH: 4.31"

405121  
205121 Stem Only

20  
3-14

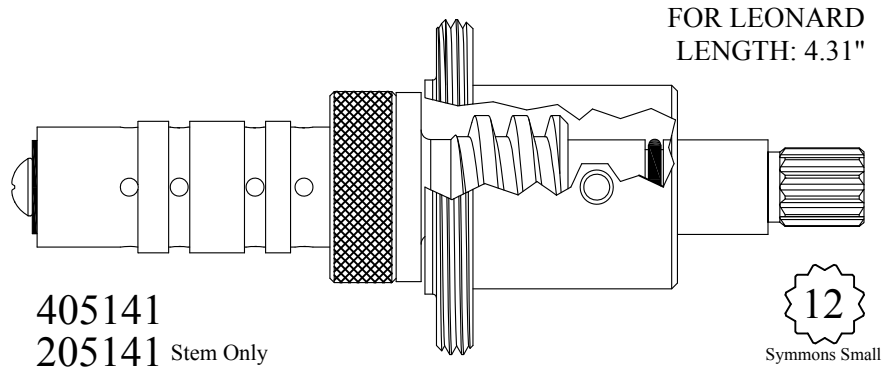

405141  
205141 Stem Only

12  
Symmons Small

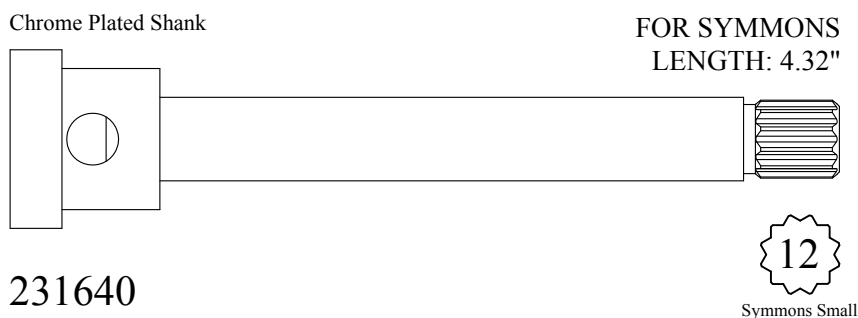

231640

12  
Symmons Small

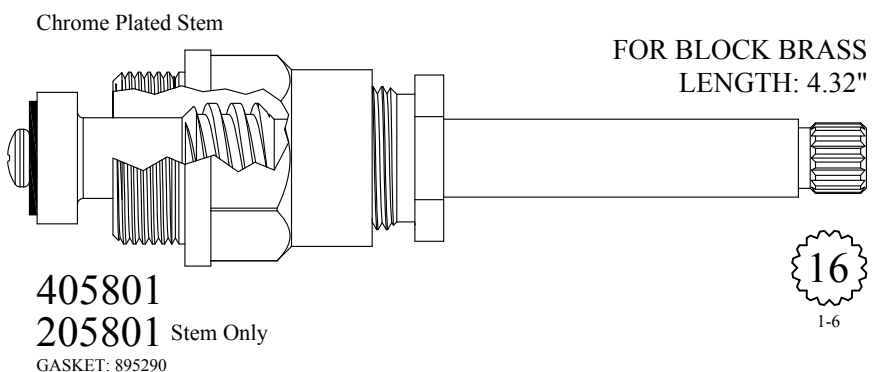
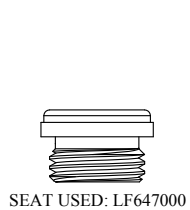

405801  
205801 Stem Only  
GASKET: 895290

16  
1-6

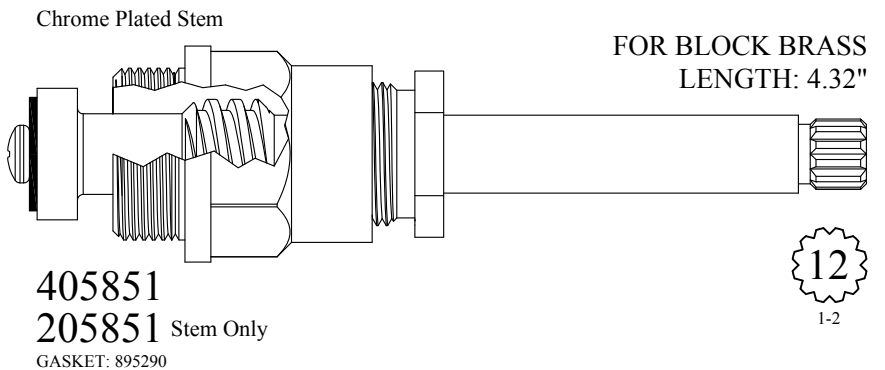
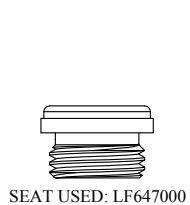

405851  
205851 Stem Only  
GASKET: 895290

12  
1-2



SEAT USED: 648970

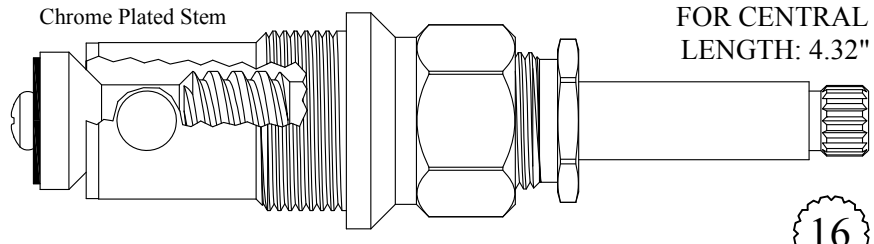

Chrome Plated Stem

FOR CENTRAL LENGTH: 4.32"

**430401**  
**230401** Stem Only  
GASKET: 895370

16  
1-6



SEAT USED: 648970

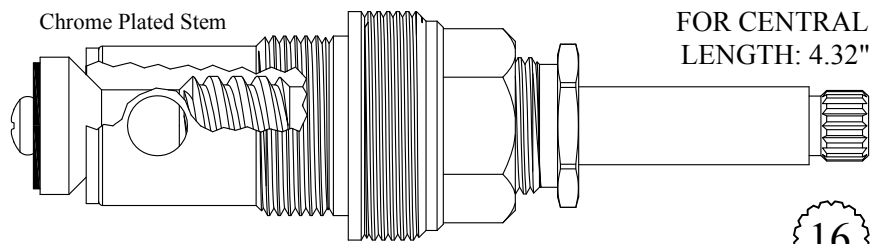

Chrome Plated Stem

FOR CENTRAL LENGTH: 4.32"

**430411**  
**230401** Stem Only  
GASKET: 895370

16  
1-6

Chrome Plated Shank & Pkg Nut

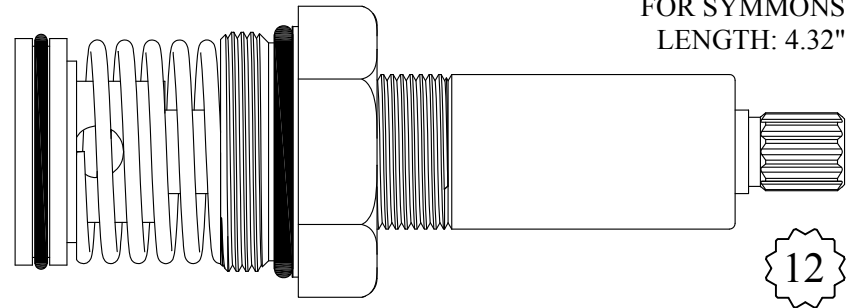

FOR SYMMONS LENGTH: 4.32"

**431160**  
**231160** Stem Only  
GASKET: 891220 O-RING INCLUDED

12  
Symmons Small

Chrome Plated Shank & Pkg Nut

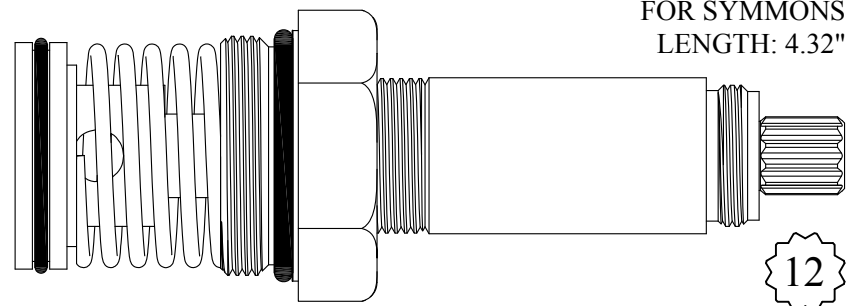

FOR SYMMONS LENGTH: 4.32"

**431170**  
**231160** Stem Only  
GASKET: 891220 O-RING INCLUDED

12  
Symmons Small



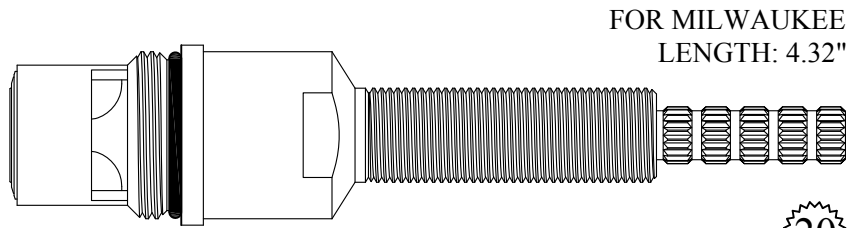

**405191/ 405192**

GASKET: 890170 O-RING INCLUDED  
 SEAL: 898510-W  
 DISC SET: 151380-PKG

20  
 3-20

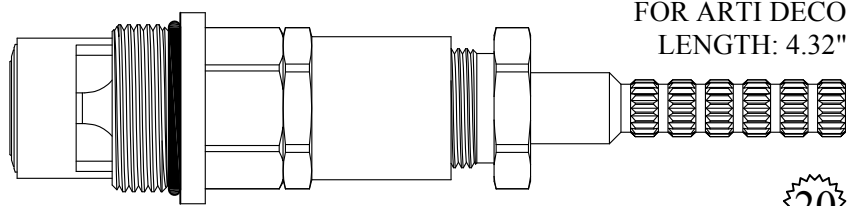

**405221/ 405222**

GASKET: 890170 O-RING INCLUDED  
 SEAL: 898510-W  
 DISC SET: 151380-PKG

20  
 3-20

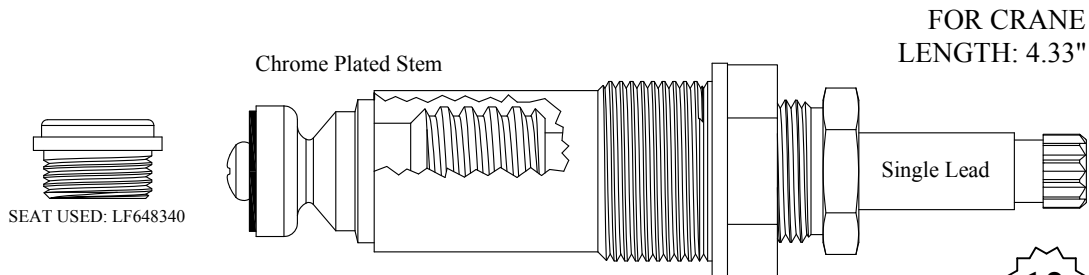

**LF471041**  
**LF271041** Stem Only

GASKET: 895370

12  
 3-10

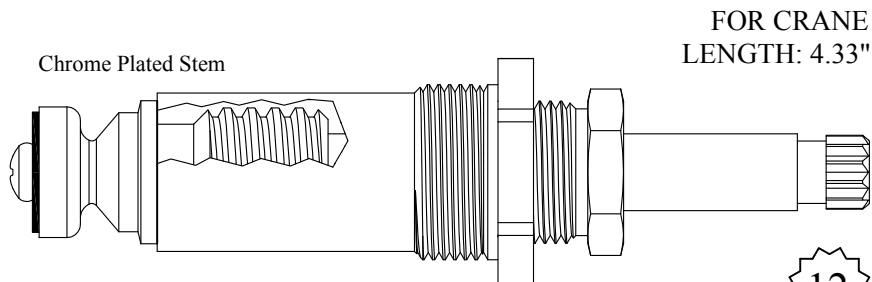

**Not Available, Use LF471041**

12  
 3-10

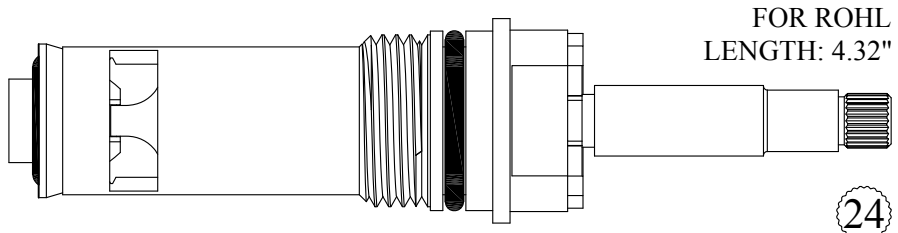

FOR ROHL  
LENGTH: 4.32"

**LF471401**  
SEAL: 898550  
DISC SET: 151380-PKG

24



SEAT USED: LF648960

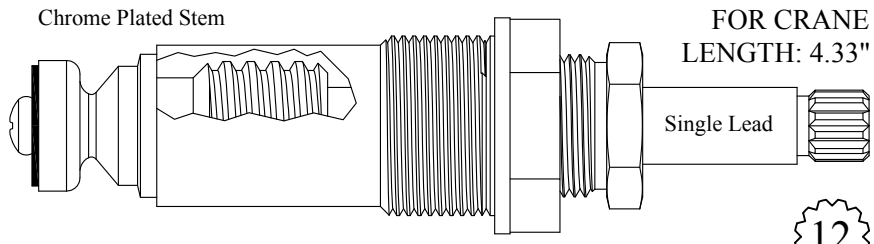

FOR CRANE  
LENGTH: 4.33"

**LF471121**  
**LF271121** Stem Only  
GASKET: 895370

12  
1-2



SEAT USED: LF648960

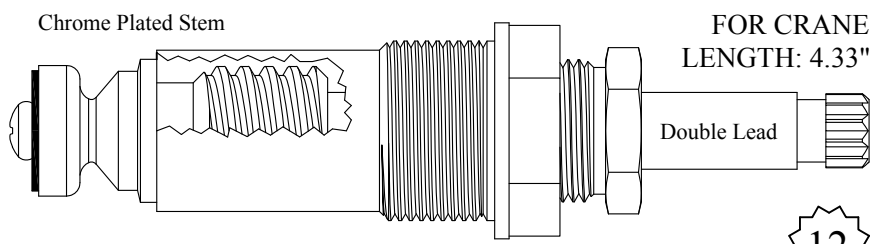

FOR CRANE  
LENGTH: 4.33"

**LF471141/ LF471142**  
**LF271141/ LF271142** Stem Only  
GASKET: 895370

12  
3-10

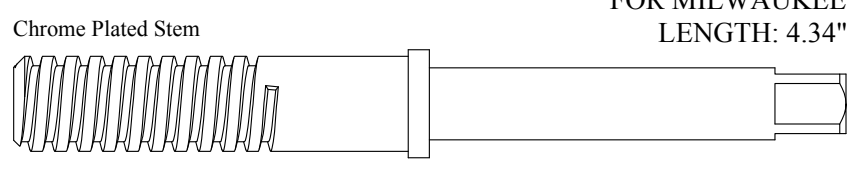

FOR MILWAUKEE  
LENGTH: 4.34"

**205212**

5/16

Quadruple Lead  
Chrome Plated Stem

FOR KOHLER  
LENGTH: 4.34"

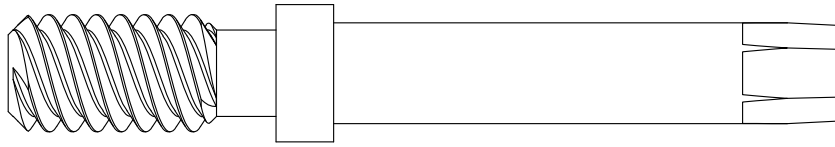

206161

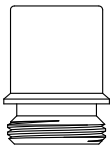
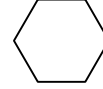

SEAT USED: LF649500

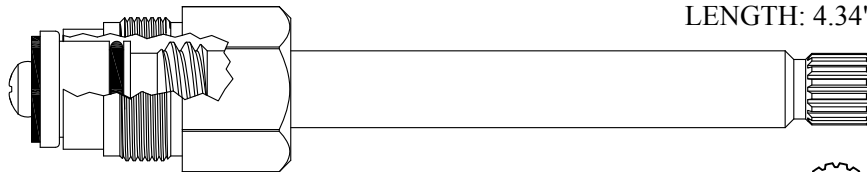

FOR MILWAUKEE  
LENGTH: 4.34"

404901

GASKET: 199930

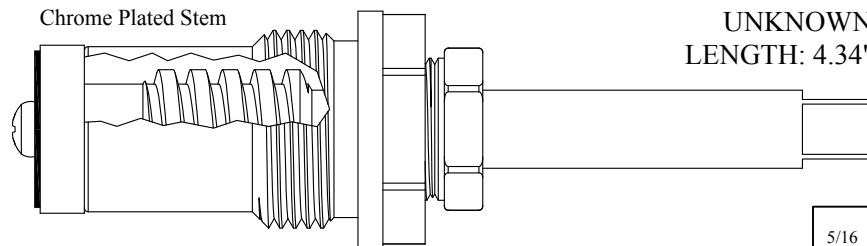

Chrome Plated Stem

UNKNOWN  
LENGTH: 4.34"

405321

205321 Stem Only

GASKET: 895560

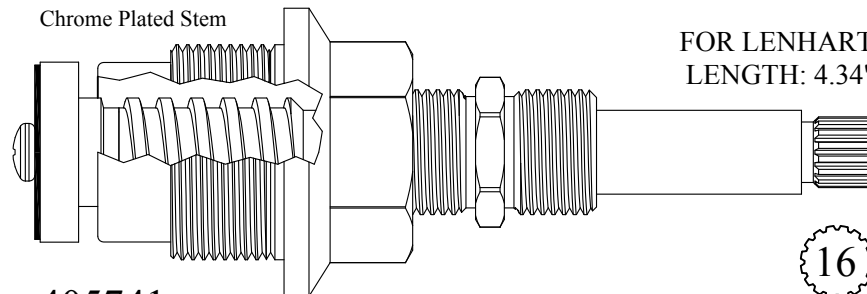

Chrome Plated Stem

FOR LENHART  
LENGTH: 4.34"

405741

GASKET: 895450



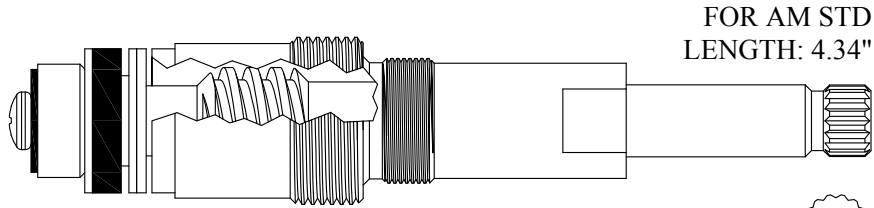

**405701/ 405702**  
WAVE WASHER: 897110

16

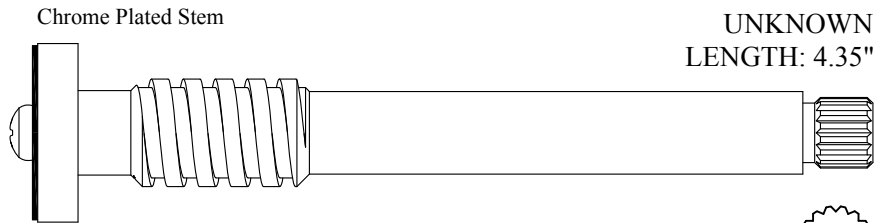

**206211**

16  
1-6

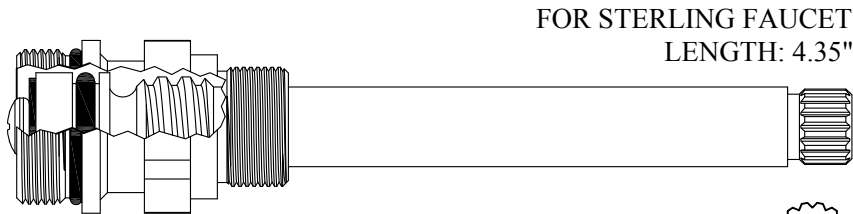

**405181**  
GASKET: 890170 O-RING INCLUDED

16  
1-5

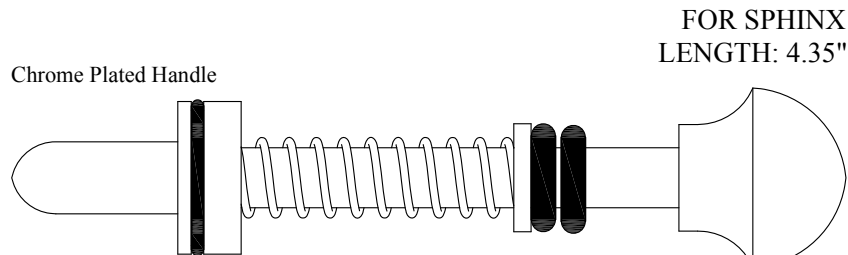

**430240**

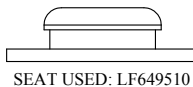

SEAT USED: LF647690

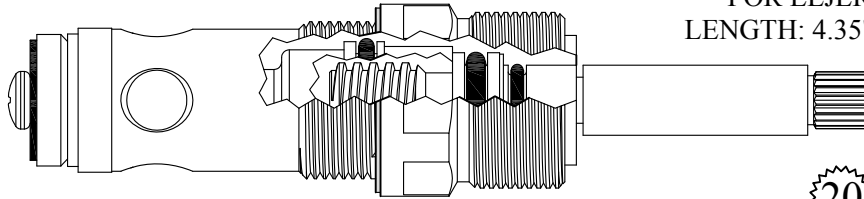

FOR ELJER  
LENGTH: 4.35"

**430552**

GASKET INCLUDED: 895160

20  
3-20

SEAT USED: LF648230

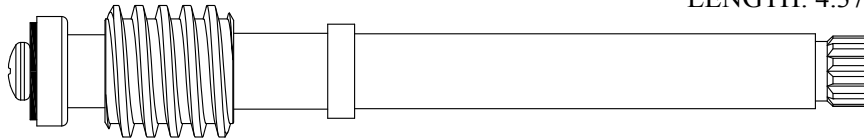

FOR ARROWHEAD  
LENGTH: 4.37"

**LF271101**

12  
1-2

SEAT USED: LF648170

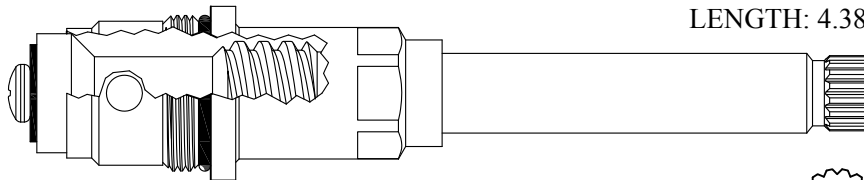

FOR STERLING FAUCET  
LENGTH: 4.38"

**430231**

GASKET: 890170 O-RING INCLUDED

16  
1-5

SEAT USED: LF648170

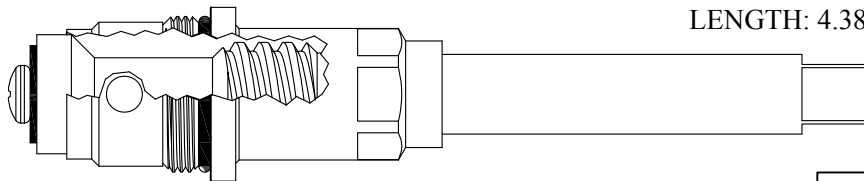

FOR STERLING FAUCET  
LENGTH: 4.38"

**430261**

GASKET: 890170 O-RING INCLUDED

5/16

SEAT USED: LF648170

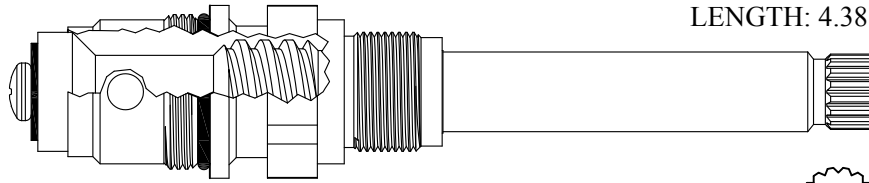
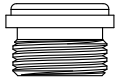

FOR STERLING FAUCET  
LENGTH: 4.38"

**430291**

GASKET: 890170 O-RING INCLUDED



SEAT USED: LF648170

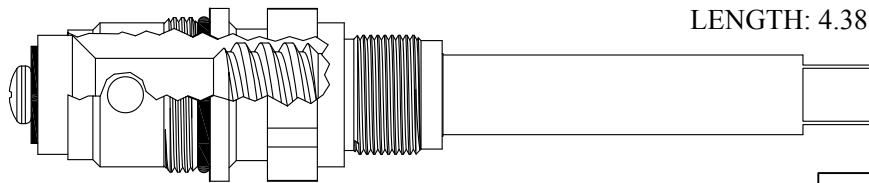

FOR STERLING FAUCET  
LENGTH: 4.38"

**430421**

GASKET: 890170 O-RING INCLUDED



SEAT USED: LF649050

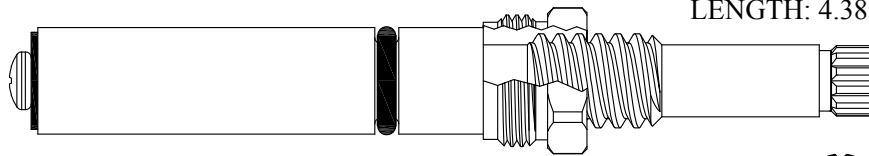
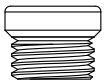

FOR BORG-WARNER  
LENGTH: 4.38"

**406311/ 406312**



Chrome Plated Stem

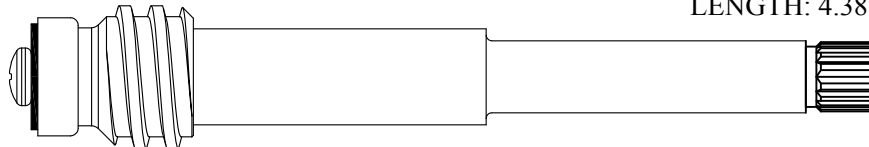

FOR MUELLER  
LENGTH: 4.38"

**LF271061**

Supplied with  
12pt. Broach



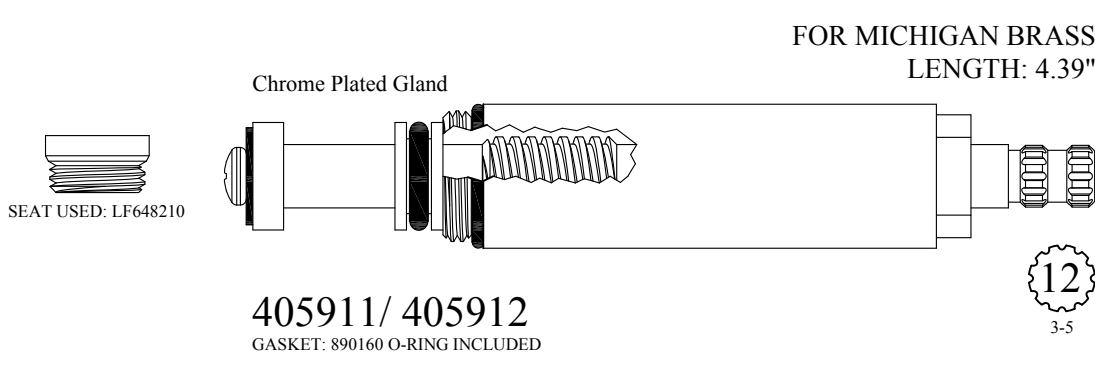
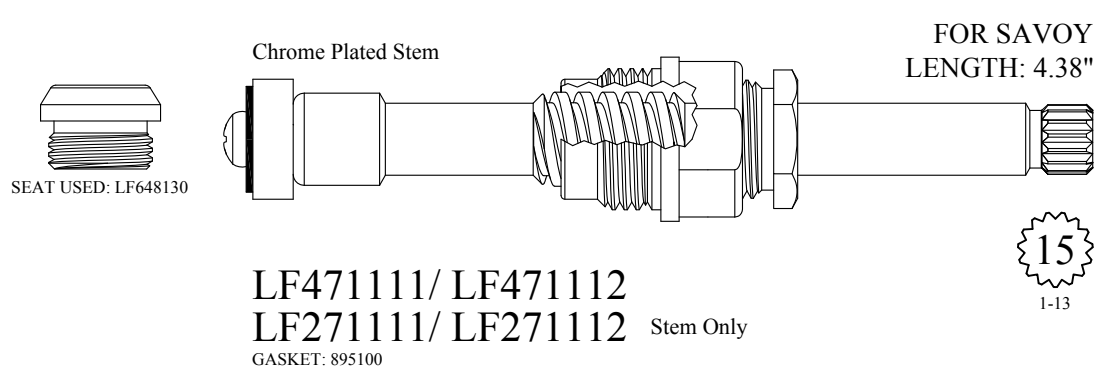
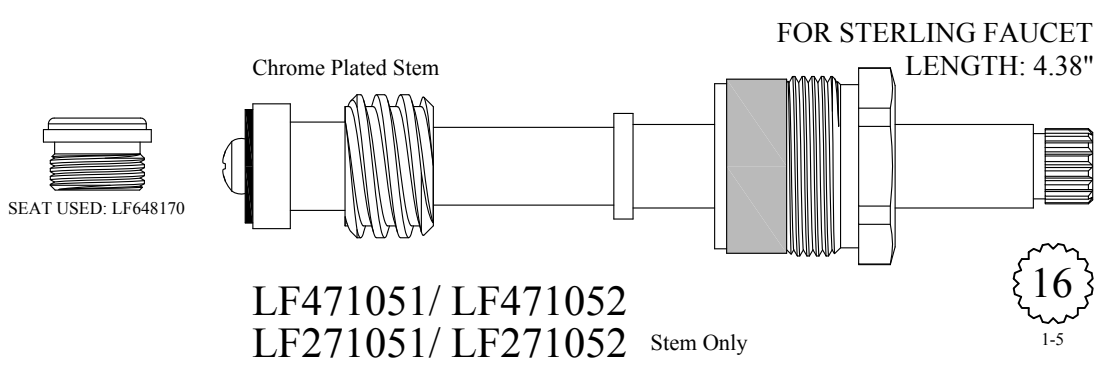

FOR KOHLER  
LENGTH: 4.39"

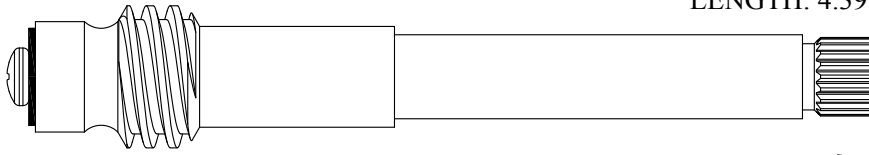

LF273361/ LF273362



19  
1-7

Chrome Plated Stem

UNKNOWN  
LENGTH: 4.40"

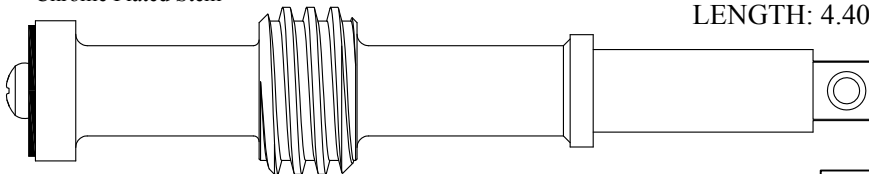

205831

5/16

FOR HARCRAFT  
LENGTH: 4.40"



SEAT USED: LF648670

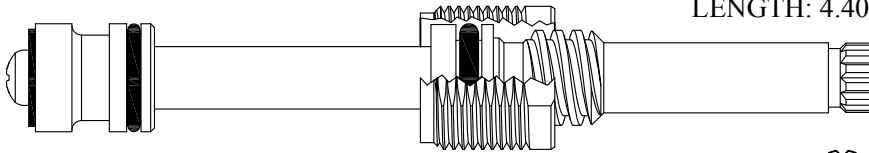

406001

GASKET: 895040 INCLUDED

12  
1-2

FOR FEDERAL HUBER  
LENGTH: 4.40"

Chrome Plated Stem

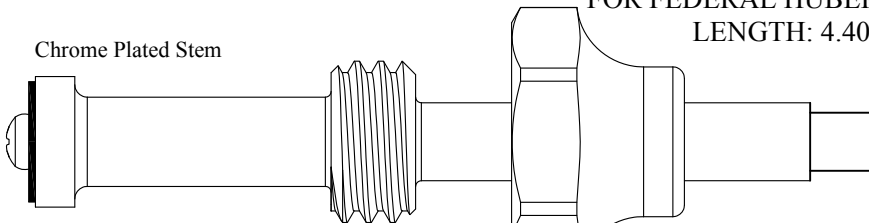

406351

206351 Stem Only

Supplied with  
12pt. Broach



12  
1-2



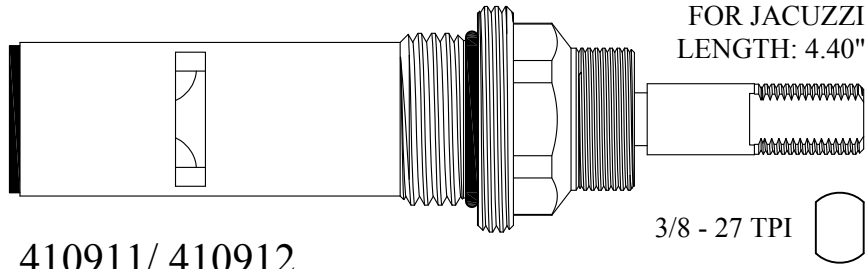

**410911/ 410912**

GASKET: 890190 O-RING INCLUDED  
 SEAL: 898550  
 DISC SET: 151380-PKG

3/8 - 27 TPI



Chrome Plated Stem

FOR WOLVERINE  
 LENGTH: 4.40"



SEAT USED: LF649200

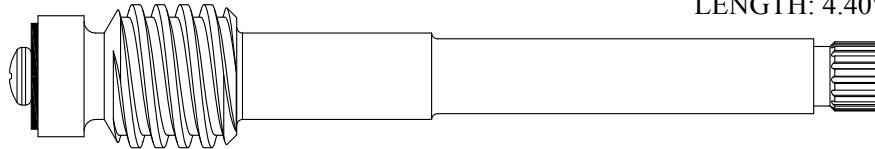

**LF271081/ LF271082**



Chrome Plated Push Button

FOR SYMMONS  
 LENGTH: 4.47"

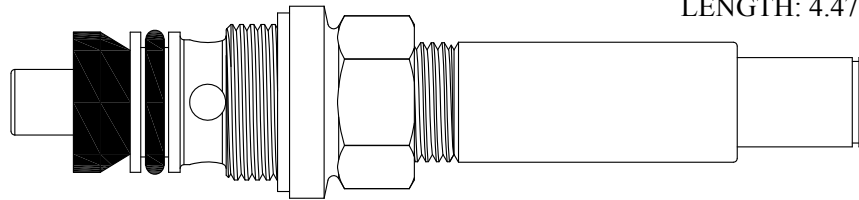

**430720**

GASKET: 895150 INCLUDED

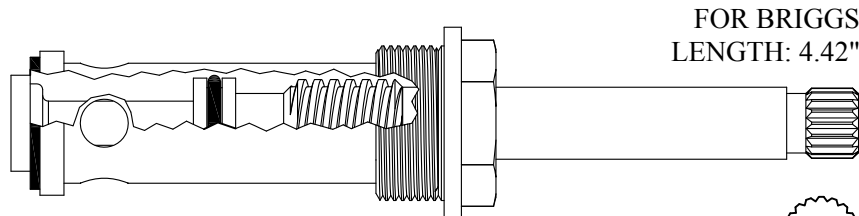

FOR BRIGGS  
 LENGTH: 4.42"

**405902**

GASKET: 895150



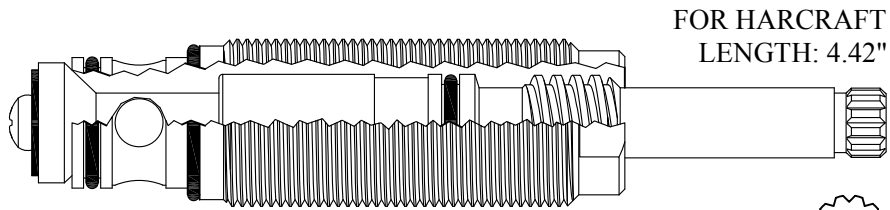

430501  
203501 Stem Only

GASKET: 890170 O-RING INCLUDED

12  
1-2

FOR AM STD  
LENGTH: 4.44"



SEAT USED: LF648220

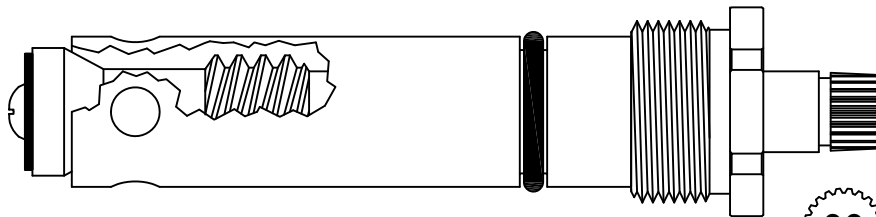

430602  
230602 Stem Only

22  
1-4

Chrome Plated Stem

FOR BARNES  
LENGTH: 4.44"



SEAT USED: LF648350

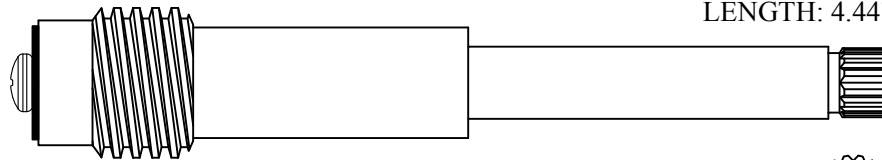

LF271031/ LF271032

16  
1-6

Chrome Plated Stem

FOR AM STD  
LENGTH: 4.44"



SEAT USED: LF648100

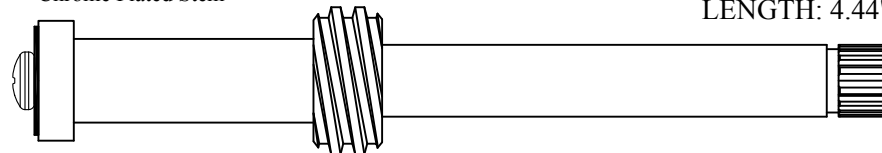

LF274041/ LF274042

16

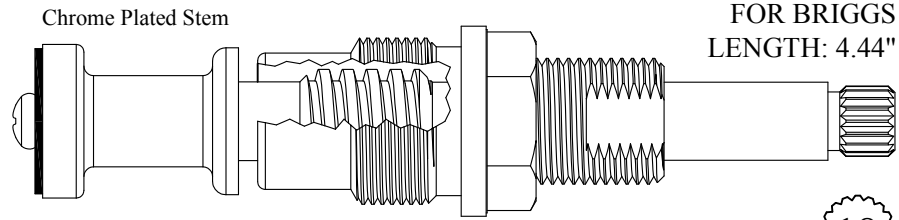

**LF471501**  
**LF271501** Stem Only  
 GASKET: 895180

18  
 3-3

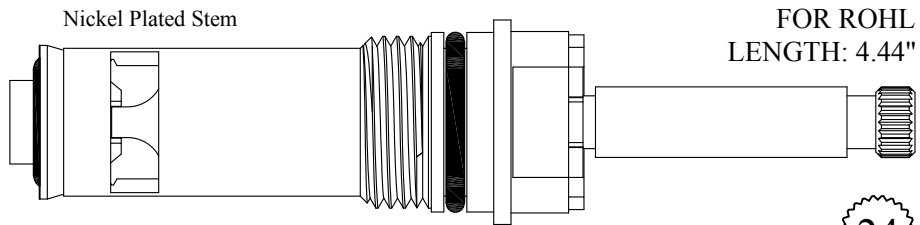

**LF471601/ LF471602**  
 SEAL: 898550  
 DISC SET: 151380-PKG

24  
 3-19

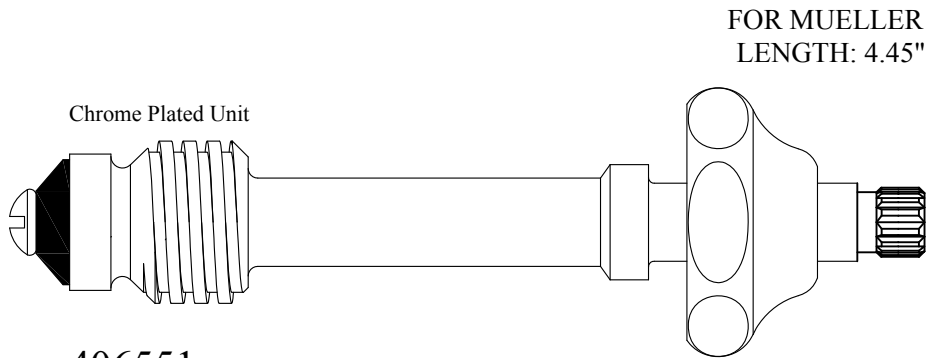

**406551**  
**206551** Stem Only

Supplied with  
 12pt. Broach  12  
 1-2

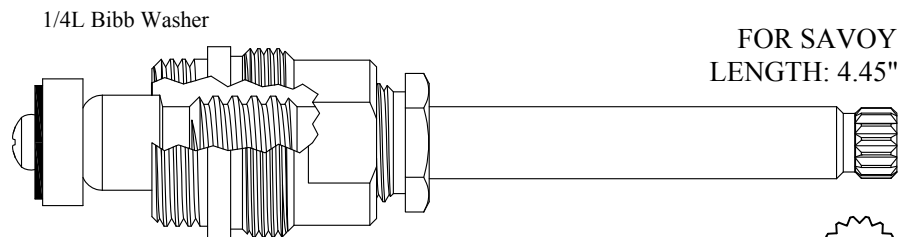
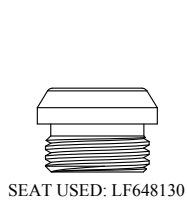

**406711**  
**206711** Stem Only  
 GASKET: 895400

15  
 1-13

Chrome Plated Stem

FOR PAUL  
LENGTH: 4.45"



406731/ 406732

GASKET: 890170 O-RING INCLUDED  
SEAL: 898510-W  
DISC SET: 151380-PKG



Chrome Plated Stem

FOR HARCRAFT  
LENGTH: 4.45"

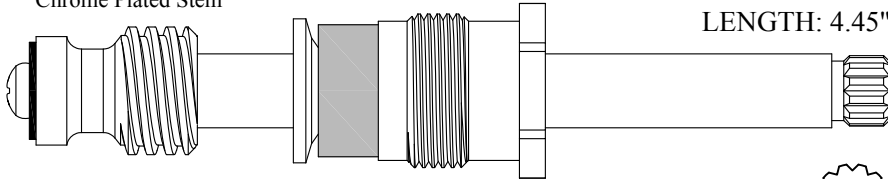

LF473021/ LF473022

LF273021/ LF273022 Stem Only



FOR MILWAUKEE  
LENGTH: 4.46"

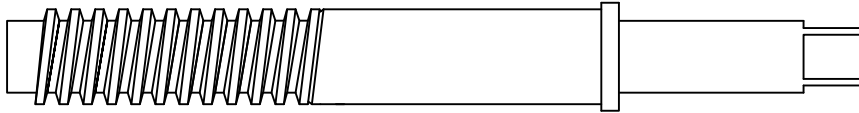

207512



One Piece Brass Stem

FOR PRICE PFISTER  
LENGTH: 4.46"

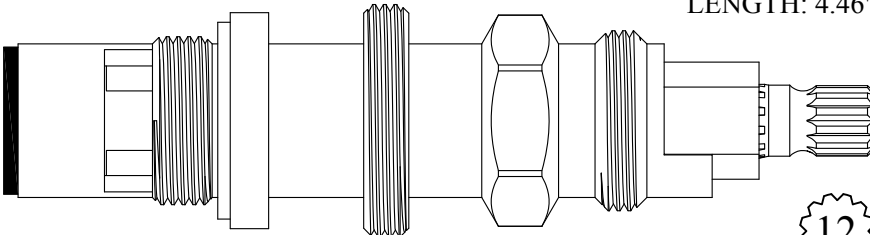

405411

GASKET: 895390 INCLUDED  
SEAL: 898550  
DISC SET: 151380-PKG



You can use the 647390 seat  
to convert the old Beau Art  
body to accept the 405411  
ceramic cartridge

FOR PRICE PFISTER  
LENGTH: 4.46"

One Piece Brass Stem

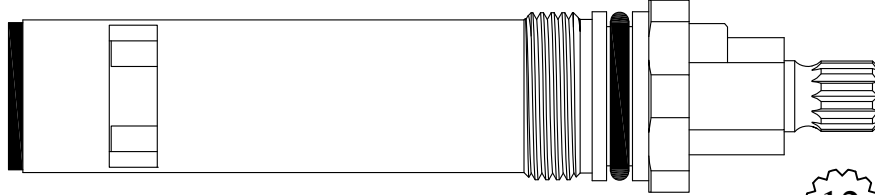

405421

SEAL: 898550  
DISC SET: 124290-PKG

12  
1-2

3/8M Bibb Washer

FOR SAVOY  
LENGTH: 4.45"

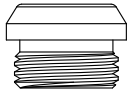

SEAT USED: LF648130

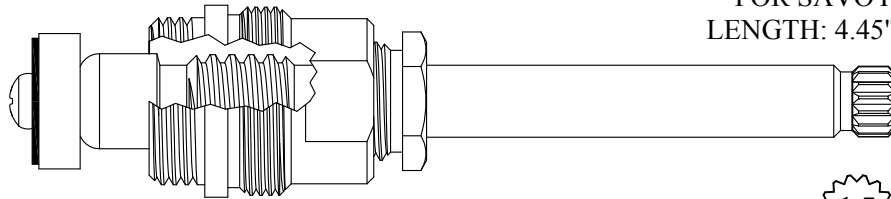

406701

206701 Stem Only  
GASKET: 895400

15  
1-13

Chrome Plated Stem & Tube

FOR MOEN  
LENGTH: 5.01"

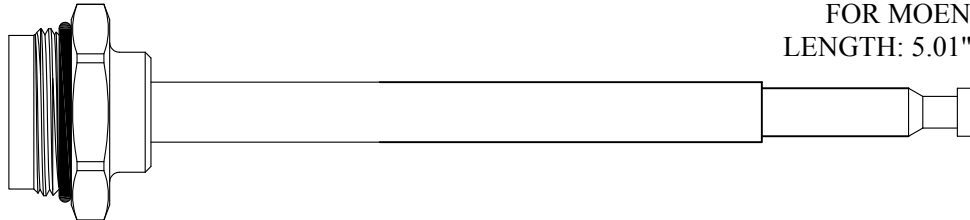

430490

GASKET: 890190 O-RING INCLUDED

FOR REID WATSON  
LENGTH: 4.47"

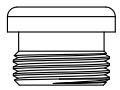

SEAT USED: LF648560

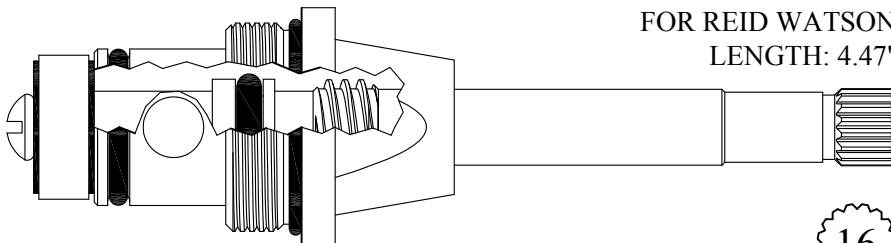

430531

GASKET: 890220 O-RING INCLUDED

16  
1-5

FOR ORION  
LENGTH: 4.47"

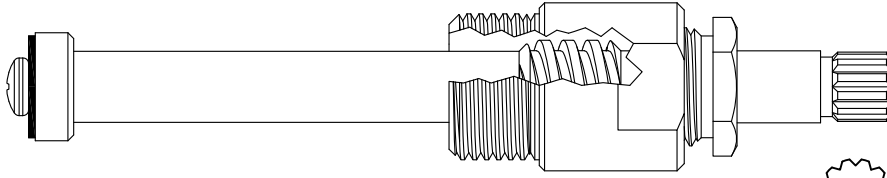

LF473101

12  
1-2

FOR AM STD  
LENGTH: 4.48"

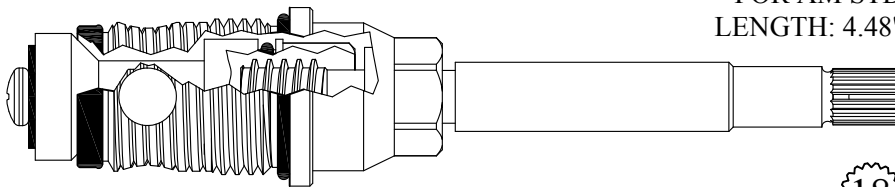

430692  
GASKET: 890170

18  
3-30



SEAT USED: LF648560

FOR INDIANA  
LENGTH: 4.49"

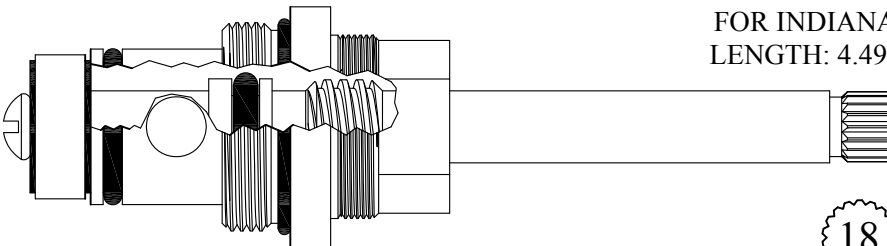

430511

18  
3-3

FOR STREAMWAY  
LENGTH: 4.49"

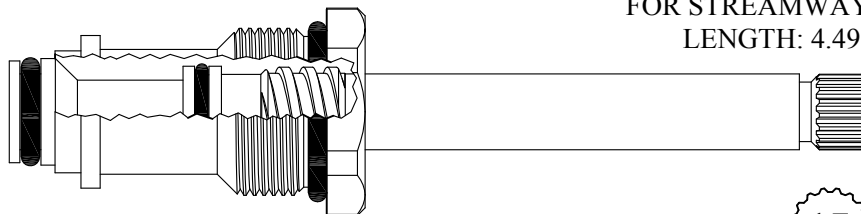

430521  
GASKET: 891160 O-RING INCLUDED

17  
3-7

Plastic Sleeve

FOR ACORN  
LENGTH: 4.49"

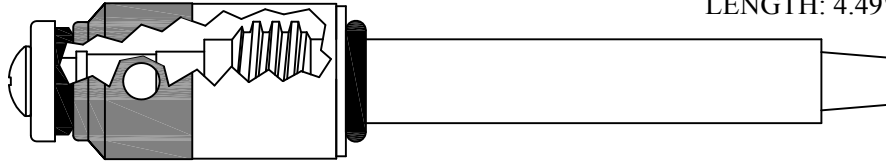

470052  
270052 Stem Only

FOR CENTRAL  
LENGTH: 4.50"

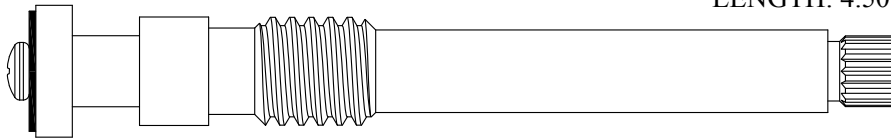

207221

16  
1-6

FOR BRADLEY  
LENGTH: 4.50"

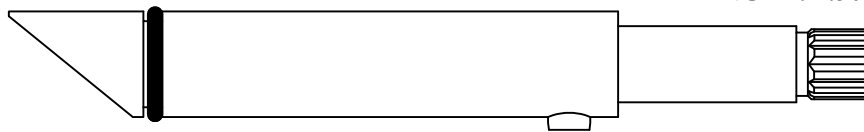

230620

12  
3-10

FOR SAYCO  
LENGTH: 4.50"

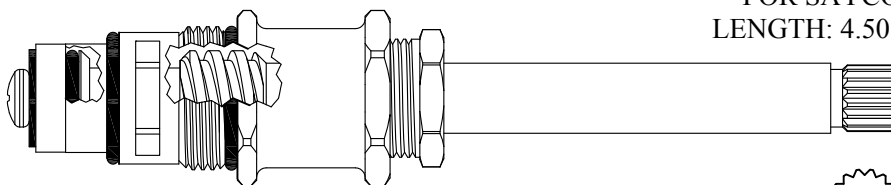

430701  
230701 Stem Only (Includes Cage)  
GASKET: 890160 O-RING INCLUDED

16  
2-3

LF647610  
LF647450  
SEAT USED: LF647450  
or LF647610

LF647610

LF647450

SEAT USED: LF647450  
or LF647610

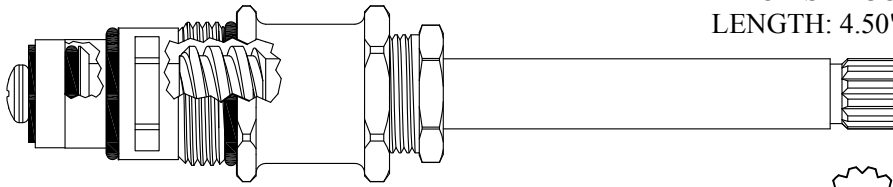

FOR SAYCO  
LENGTH: 4.50"

430751  
207251 Stem Only

GASKET: 890160 O-RING INCLUDED

12  
1-2

LF647610

LF647450

SEAT USED: LF647450  
or LF647610

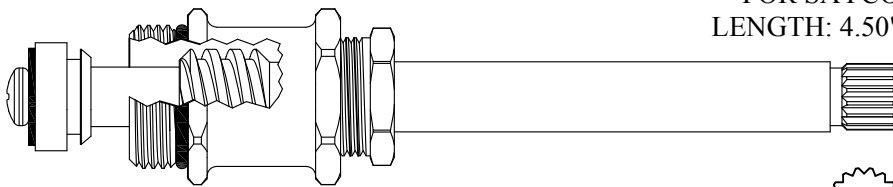

FOR SAYCO  
LENGTH: 4.50"

407201/ 407202  
207201/ 207202 Stem Only

GASKET: 890160 O-RING INCLUDED

16  
2-3

LF647610

LF647450

SEAT USED: LF647450  
or LF647610

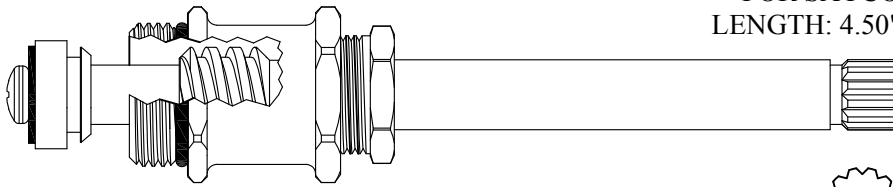

FOR SAYCO  
LENGTH: 4.50"

407251/ 407252  
207251/ 207252 Stem Only

GASKET: 890160 O-RING INCLUDED

12  
1-2

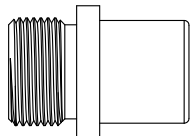

SEAT USED: LF649640

Chrome Plated Stem

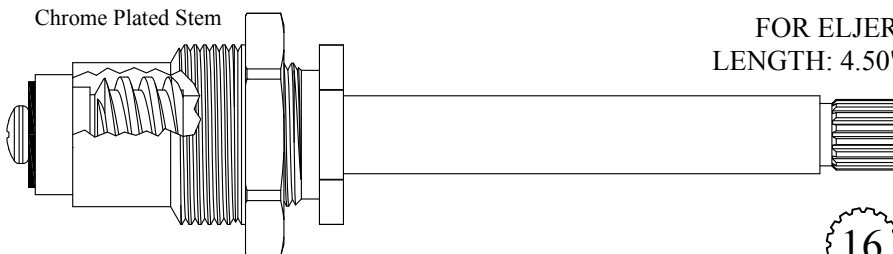

FOR ELJER  
LENGTH: 4.50"

411211/ 411212  
211211/ 211212 Stem Only

GASKET: 895330

16  
3-15



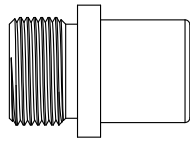

SEAT USED: LF649640

Chrome Plated Stem

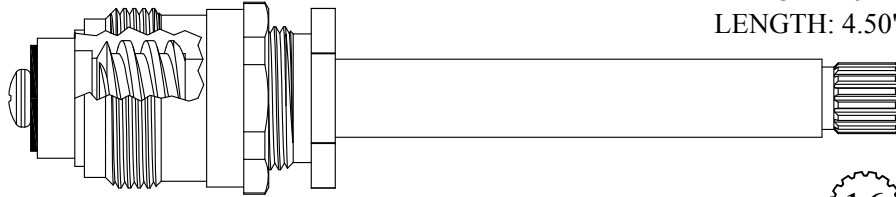

FOR ELJER  
LENGTH: 4.50"

411231/ 411232  
211211/ 211212 Stem Only  
GASKET: 895120

16  
3-15



SEAT USED: LF648200 or LF649770

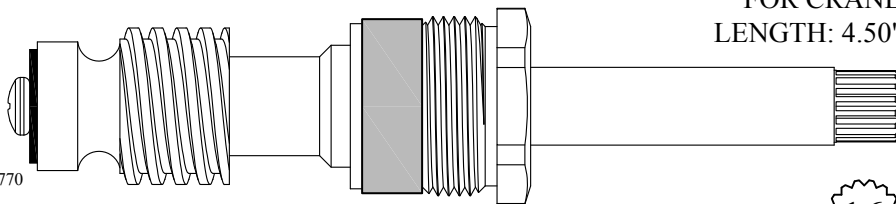

FOR CRANE  
LENGTH: 4.50"

LF473031/ LF473032  
LF273031/ LF273032 Stem Only

16  
1-6

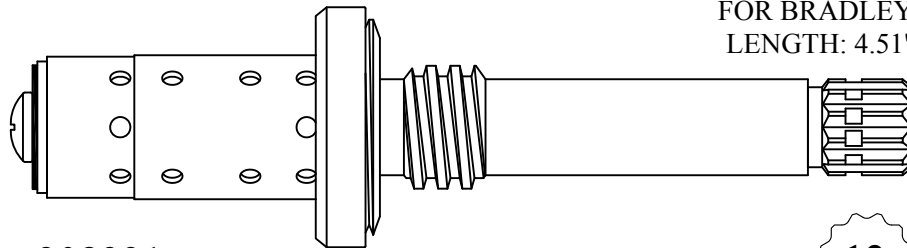

FOR BRADLEY  
LENGTH: 4.51"

208331

12

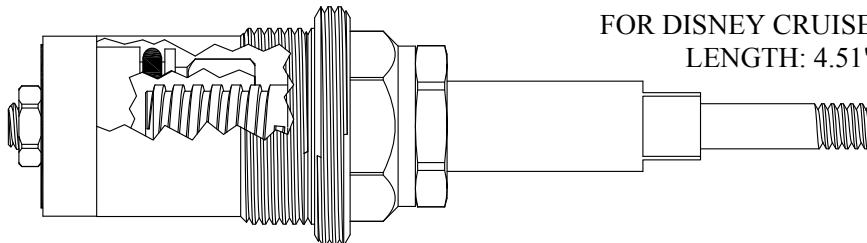

FOR DISNEY CRUISE  
LENGTH: 4.51"

405722  
GASKET: 895560

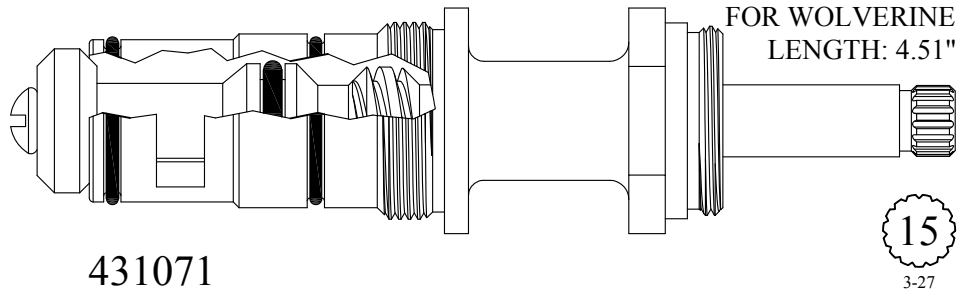

431071

15  
3-27

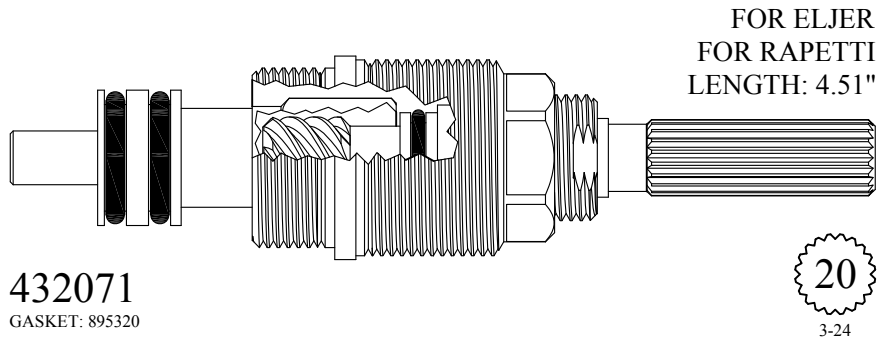

432071  
GASKET: 895320

20  
3-24

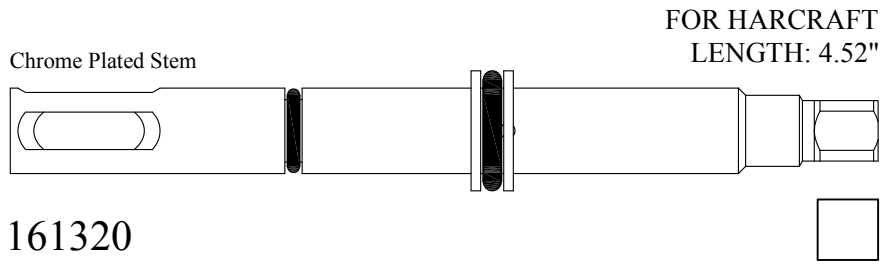

161320

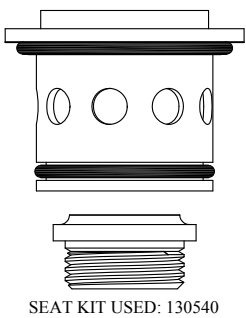

SEAT KIT USED: 130540

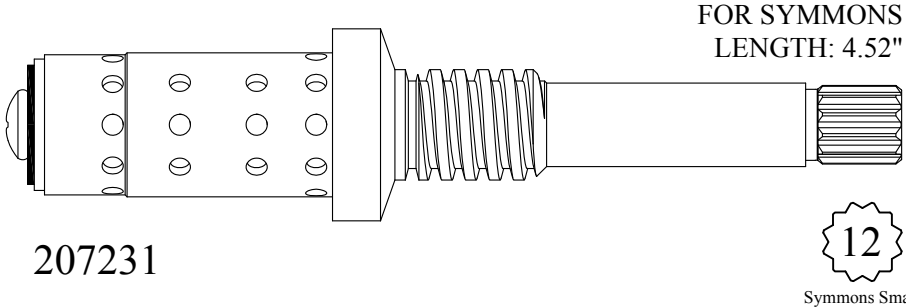

207231

12  
Symmons Small

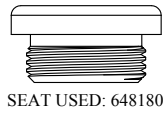

Chrome Plated Stem

FOR SPEAKMAN  
LENGTH: 4.52"

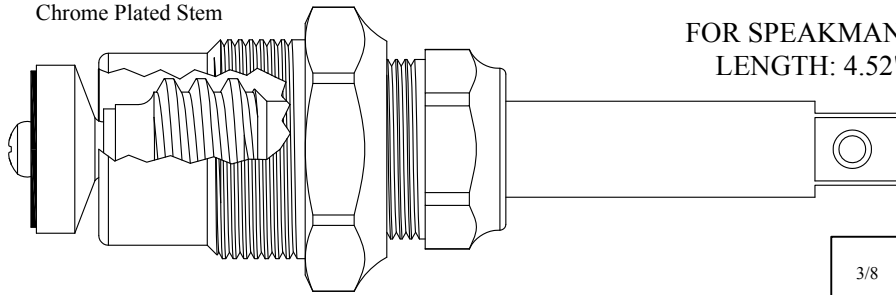

3/8

407011

207011 Stem Only

GASKET: 895450

FOR GLAUBER WEST COAST  
LENGTH: 4.52"

Chrome Plated Unit

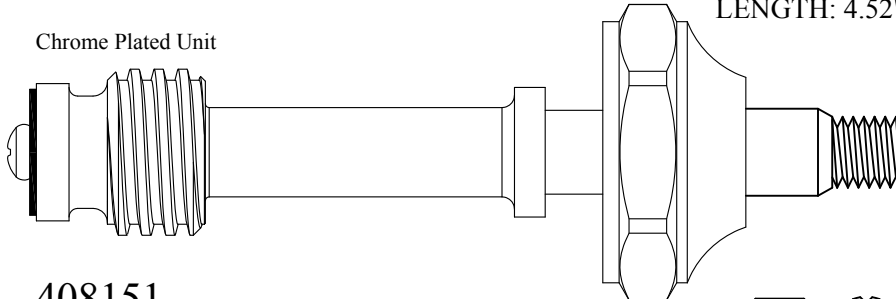

408151

208151 Stem Only

Supplied with  
12pt. Broach

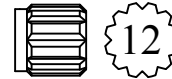

12  
1-2

UNKNOWN  
LENGTH: 4.52"

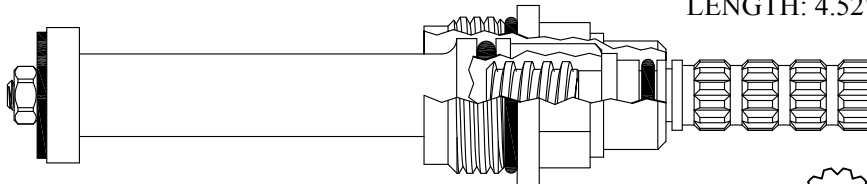

426862

GASKET: 890170 O-RING INCLUDED

12  
1-2

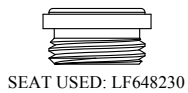

Chrome Plated Stem

FOR ARROWHEAD  
LENGTH: 4.52"

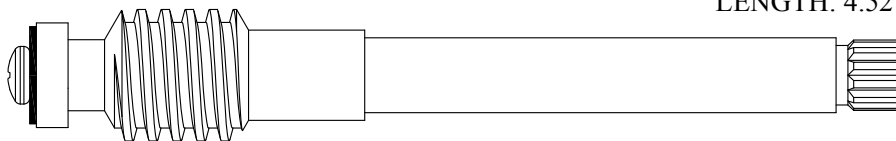

LF274201

12  
1-2

SEAT USED: LF648130

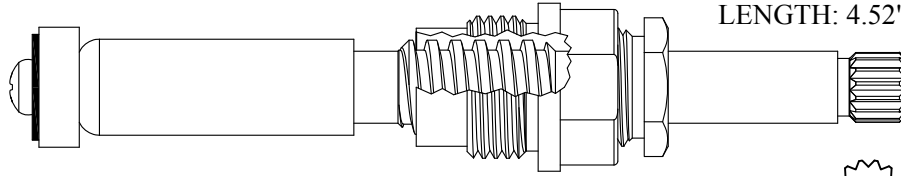
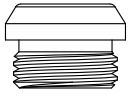

FOR SAVOY  
LENGTH: 4.52"

**LF471301**  
**LF471301** Stem Only  
GASKET: 895100



Chrome Plated Stem

UNKNOWN  
LENGTH: 4.53"

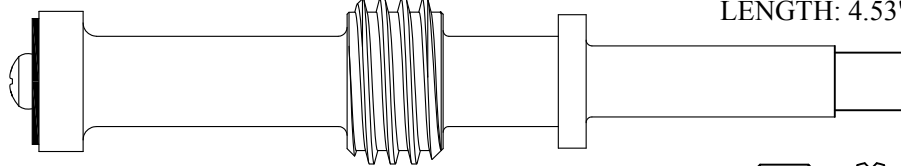

**206851**

Supplied with  
12pt. Broach



Chrome Plated Stem

FOR MILWAUKEE  
LENGTH: 4.53"

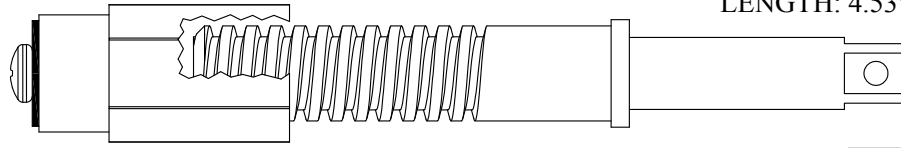

**403432**  
**203432** Stem Only



Chrome Plated Stem

FOR SPEAKMAN  
LENGTH: 4.53"

SEAT USED: LF648930

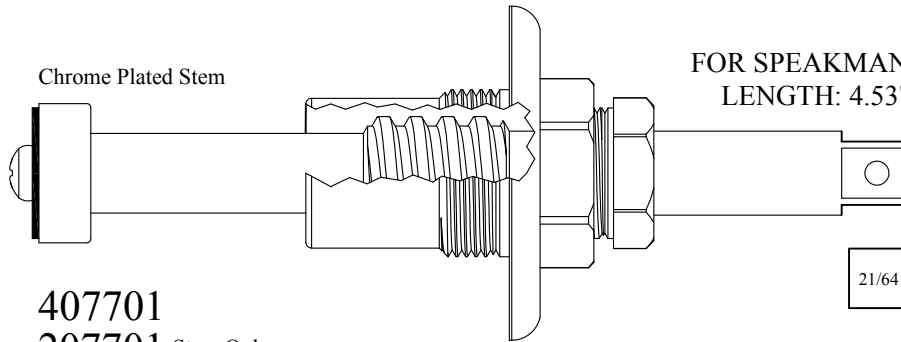
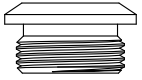

**407701**  
**207701** Stem Only  
GASKET: 895400



Chrome Plated Stem

FOR SPEAKMAN  
LENGTH: 4.53"

SEAT USED: LF648930

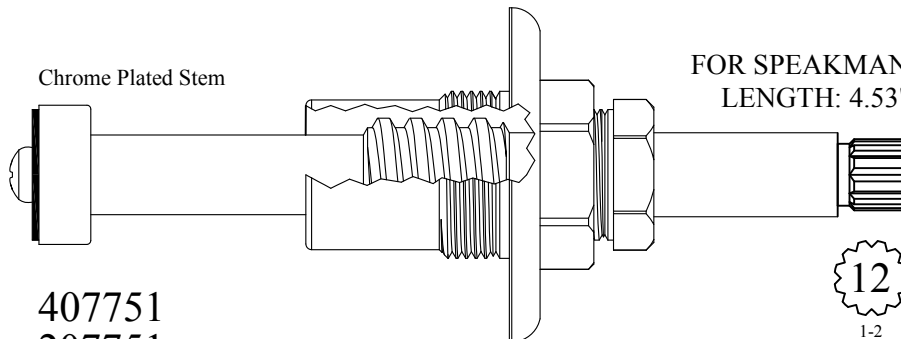

**407751**  
**207751** Stem Only  
GASKET: 895400



SEAT USED: LF648170

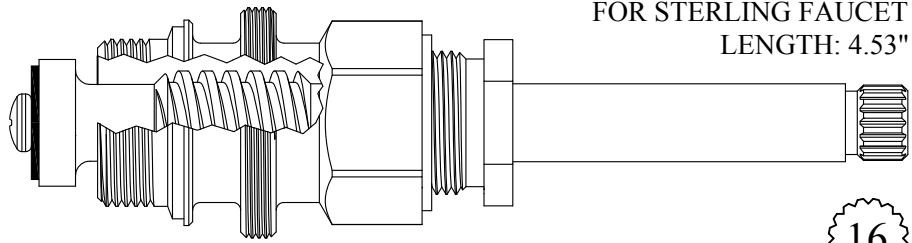

FOR STERLING FAUCET  
LENGTH: 4.53"

16  
1-5

407301/ 407302  
207301/ 207302 Stem Only  
GASKET: 895400

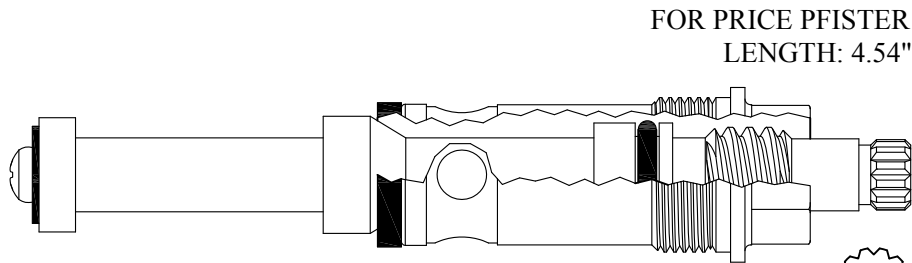

FOR PRICE PFISTER  
LENGTH: 4.54"

12  
1-2

430821  
GASKET: 895150

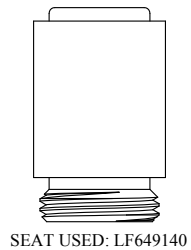

SEAT USED: LF649140

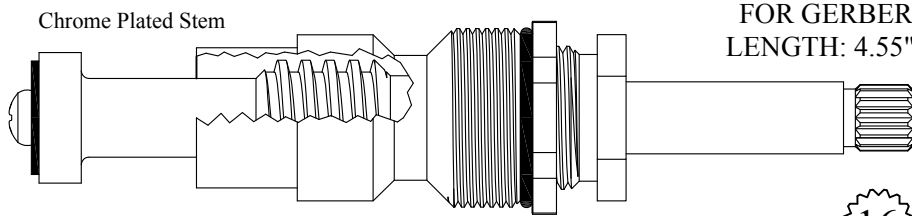

Chrome Plated Stem

FOR GERBER  
LENGTH: 4.55"

16  
2-3

LF477021/ LF477022  
LF277021/ LF277022 Stem Only  
GASKET: 890190 O-RING INCLUDED

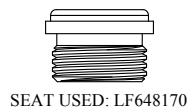

SEAT USED: LF648170

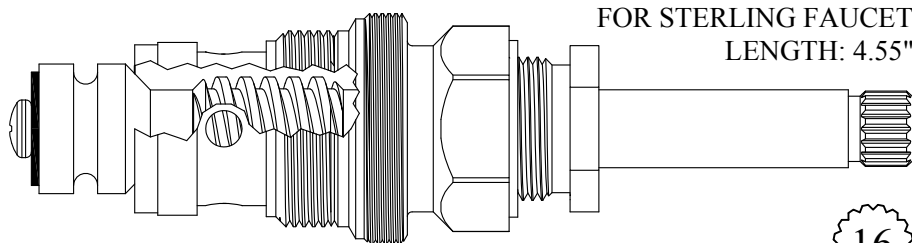

FOR STERLING FAUCET  
LENGTH: 4.55"

16  
1-5

430801  
230801 Stem Only  
GASKET: 895560

FOR ELJER  
LENGTH: 4.55"

Chrome Plated Sleeve



SEAT USED: LF648320  
or LF648160

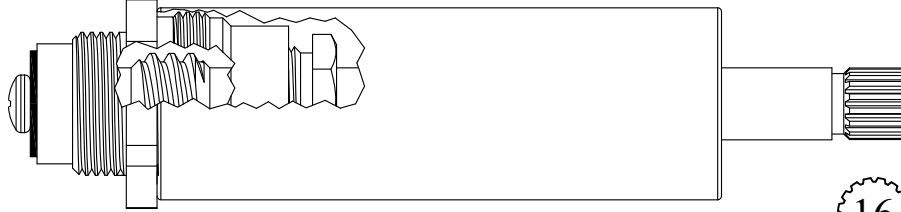

407801/ 407802  
207801/ 207802 Stem Only  
GASKET: 895100

FOR ELJER  
LENGTH: 4.55"

Chrome Plated Gland

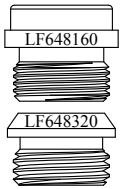

SEAT USED: LF648320  
or LF648160

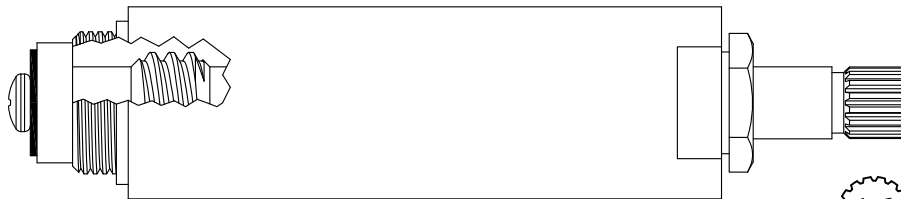

407821/ 407822  
207801/ 207802 Stem Only  
GASKET: 895100

FOR ELJER  
LENGTH: 4.55"

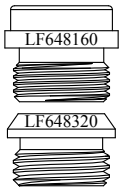

SEAT USED: LF648320  
or LF648160

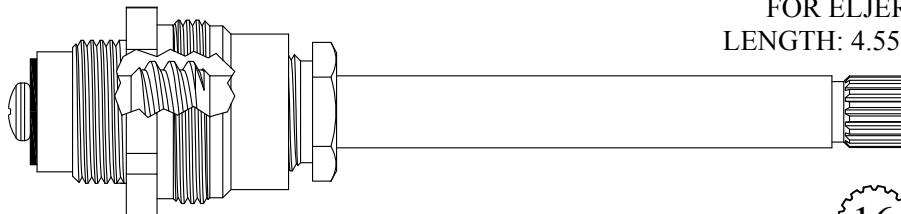

407831/ 407832  
207801/ 207802 Stem Only  
GASKET: 895100

FOR ELJER  
LENGTH: 4.55"

Chrome Plated Sleeve

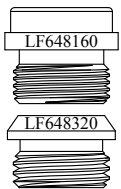

SEAT USED: LF648320  
or LF648160

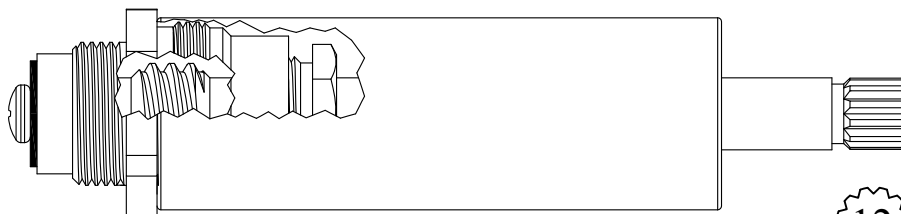

407851/ 407852  
207851/ 207852 Stem Only  
GASKET: 895100

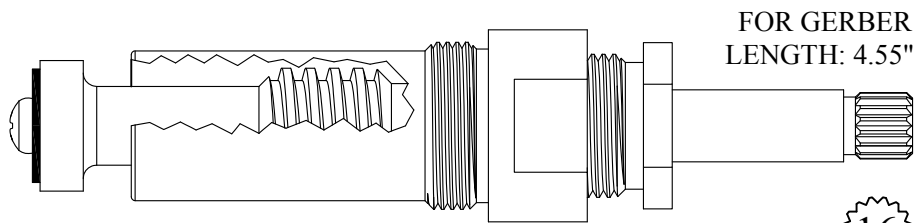
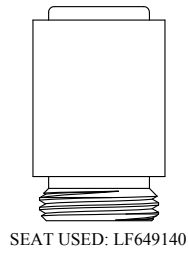

16  
2-3

LF473041/ LF473042  
LF273041/ LF273042 Stem Only  
GASKET: 895180

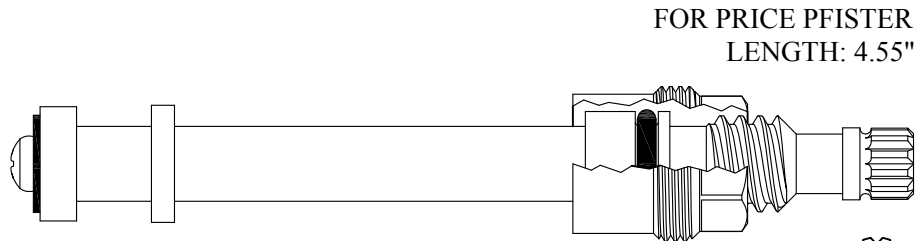

12  
1-2

LF474011/ LF474012  
GASKET: 895060

All Brass Stem - No Plastic

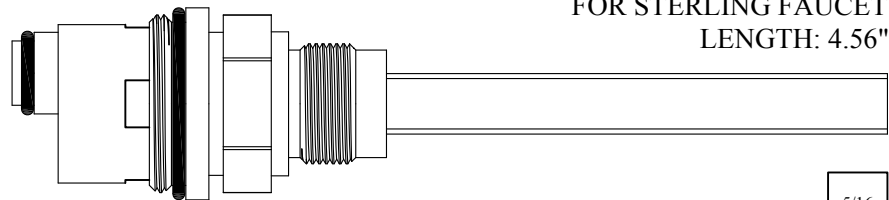

5/16

406741/ 406742  
GASKET: 890190 O-RING INCLUDED

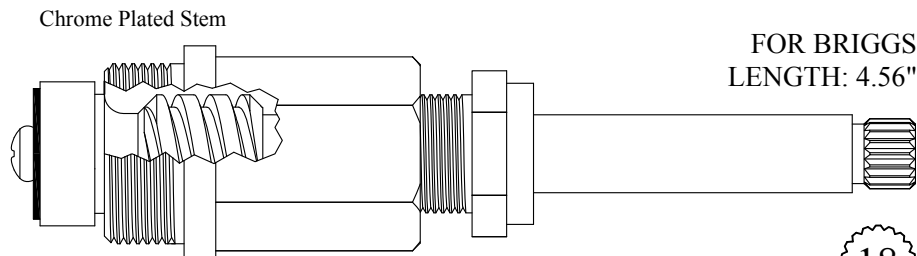
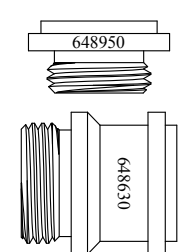

18  
3-3

407501/ 407502  
207501/ 207502 Stem Only  
GASKET: 895370

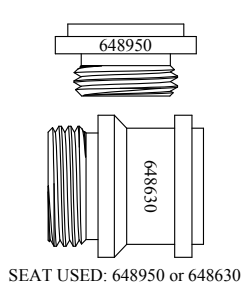

Chrome Plated Unit

FOR BRIGGS  
LENGTH: 4.56"

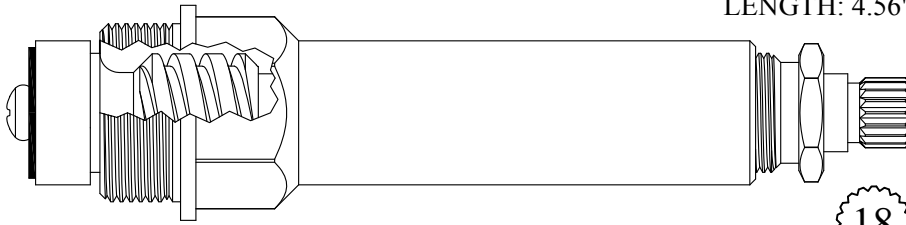

407521/ 407522  
207501/ 207502 Stem Only  
GASKET: 895370

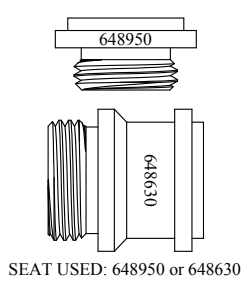

Chrome Plated Stem

FOR BRIGGS  
LENGTH: 4.56"

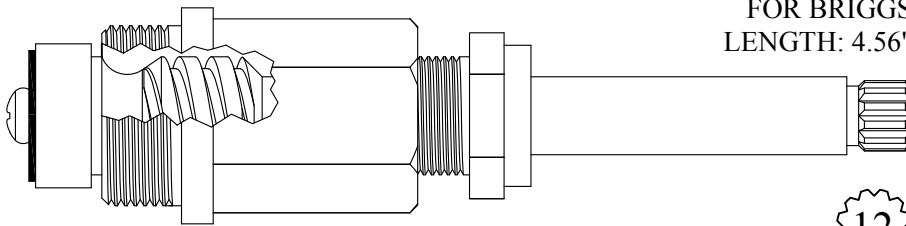

407551/ 407552  
207551/ 207552 Stem Only  
GASKET: 895370

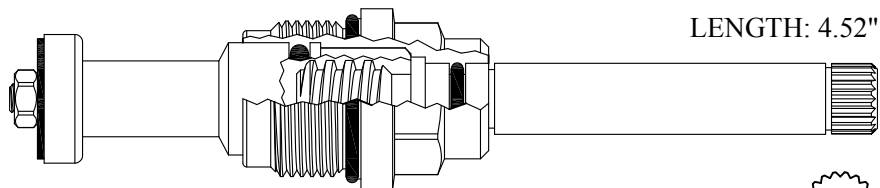

405942  
GASKET: 890180 O-RING INCLUDED

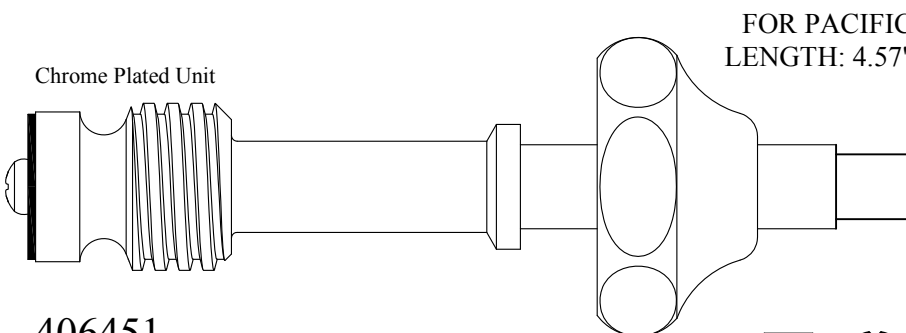

406451  
206451 Stem Only

Supplied with  
12pt. Broach

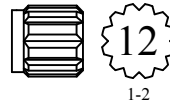





SEAT USED: LF648170

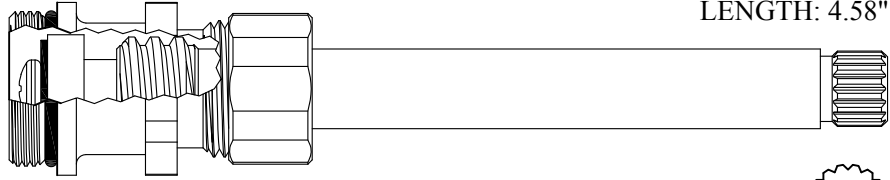

FOR STERLING FAUCET  
LENGTH: 4.58"

**405841**  
GASKET: 890170 O-RING INCLUDED

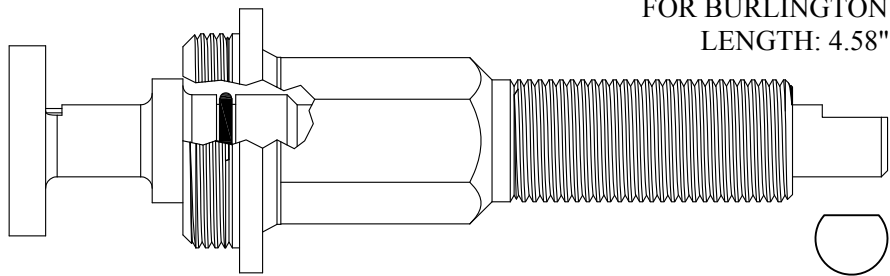

FOR BURLINGTON  
LENGTH: 4.58"

**430710**  
**230710** Stem Only  
GASKET: 894620



SEAT USED: LF649430

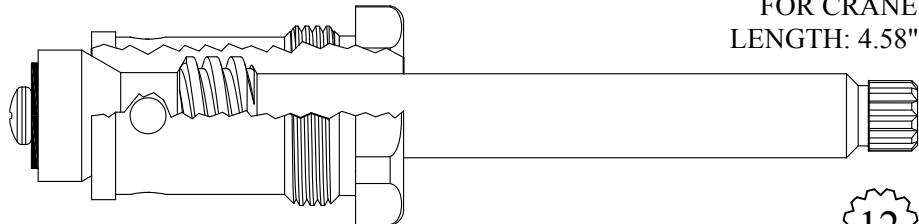

FOR CRANE  
LENGTH: 4.58"

**430901**  
**230901** Stem Only  
GASKET: 895320

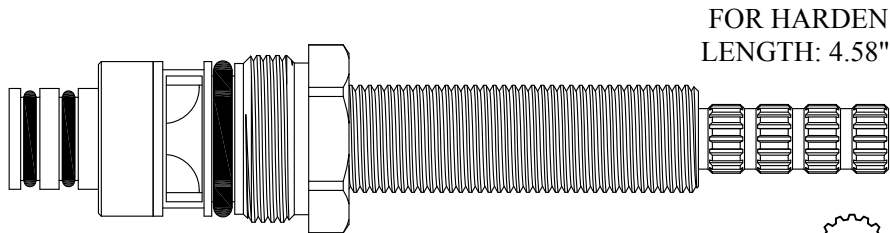

FOR HARDEN  
LENGTH: 4.58"

**408011/ 408012**  
GASKET: 891140 O-RING INCLUDED  
DISC SET: 151380-PKG



Chrome Plated Stem

FOR HARCRAFT  
LENGTH: 4.58"

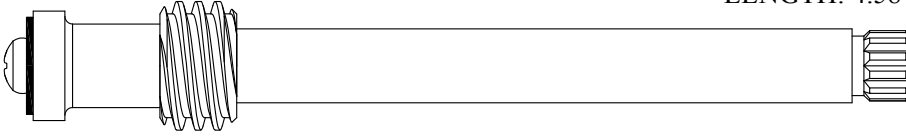

LF274031/ LF274032



FOR PRICE PFISTER  
LENGTH: 4.59"

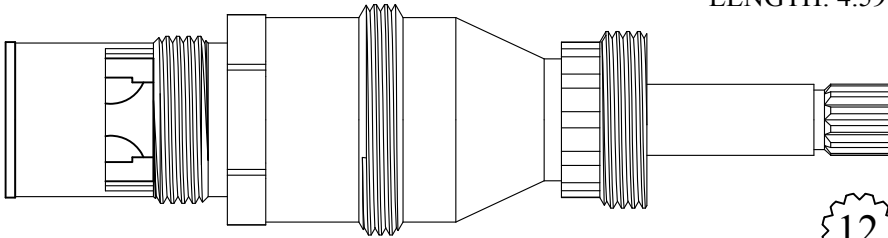

405441

GASKET: 895390 INCLUDED  
DISC SET: 124290-PKG



FOR EAST RIVER  
LENGTH: 4.59"

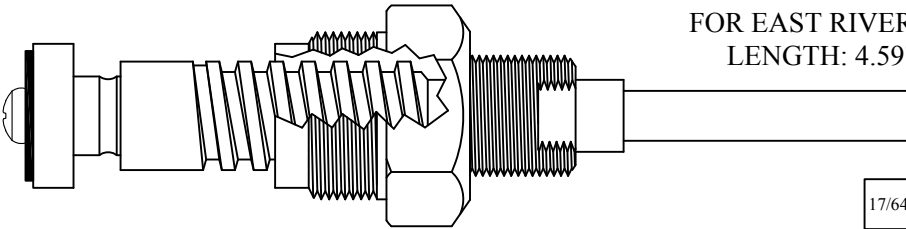

408711

208711 Stem Only

GASKET: 895150



Chrome Plated Stem

FOR LOGAN  
LENGTH: 4.59"

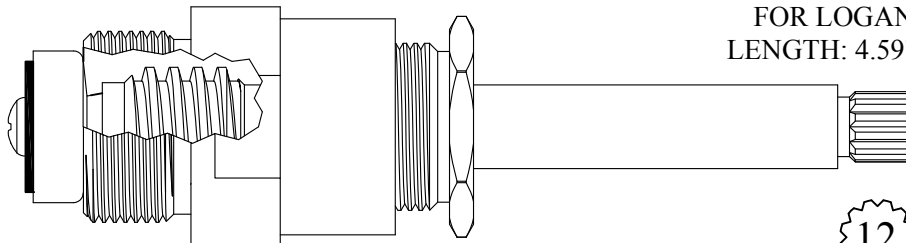

410011

210011 Stem Only

GASKET: 895430



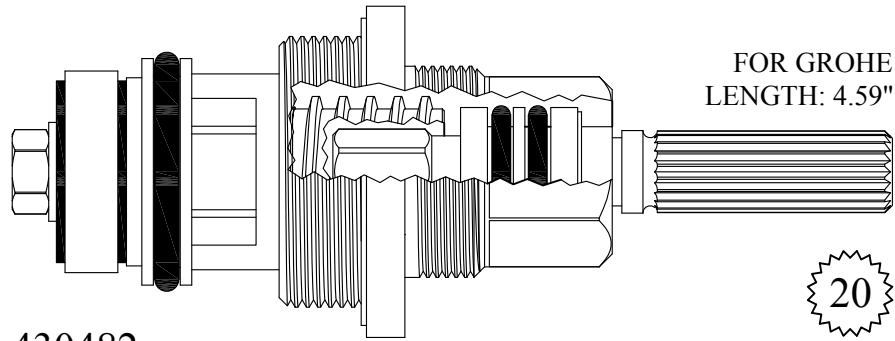

**430482**  
GASKET: 895520 INCLUDED

20  
3-32

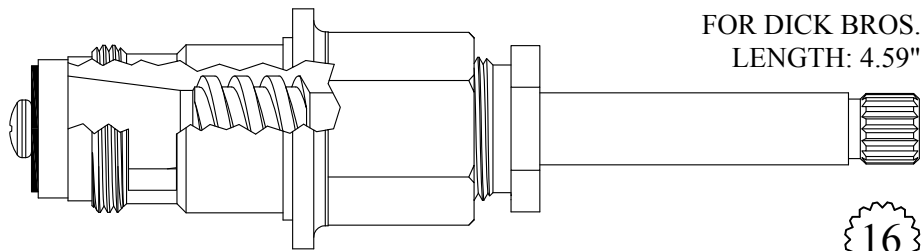

**430611**  
**230611** Stem Only  
GASKET: 895350

16  
1-6

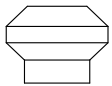

SEAT USED: 649110

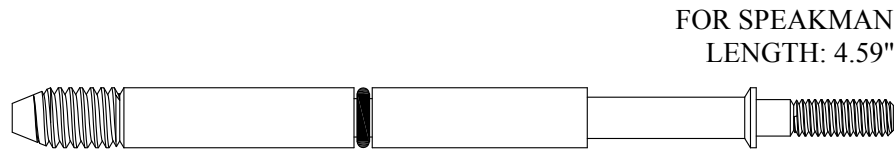

**LF274070**



SEAT USED: LF648550

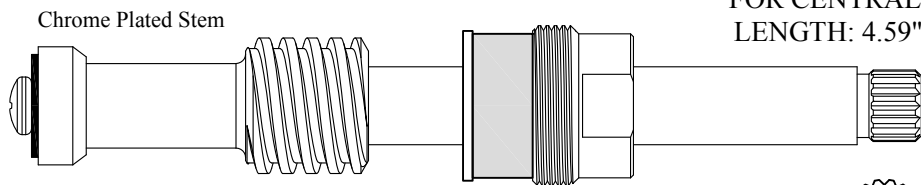

**LF474021/ LF474022**  
**LF274021/ LF274022** Stem Only

16  
1-6

SEAT USED: LF648930

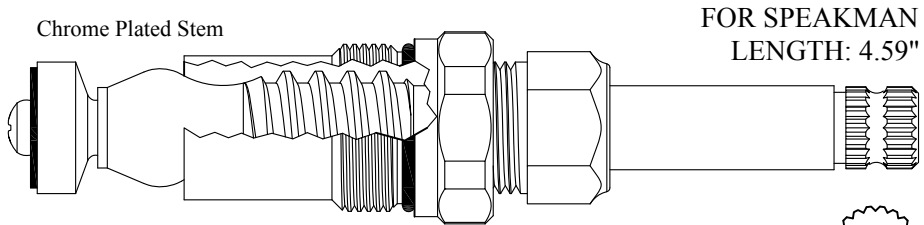

**LF475011/ LF475012**  
**LF275011/ LF275012** Stem Only  
 GASKET: 890180 O-RING INCLUDED

**20**  
 2-4

SEAT USED: LF649430

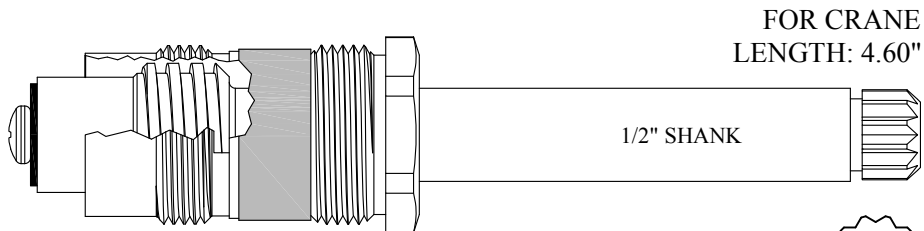

**408001**  
**208001** Stem Only

**12**

SEAT USED: LF649430

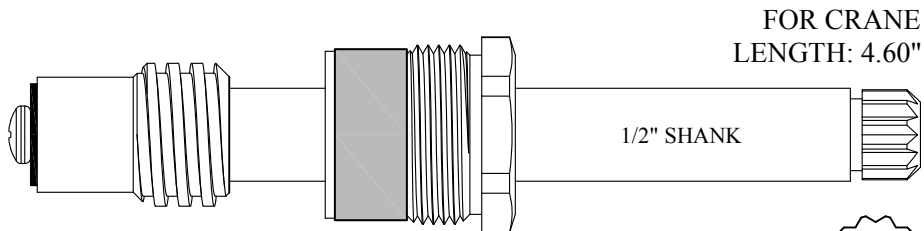

**408021**  
**208001** Stem Only

**12**

Chrome Plated Stem

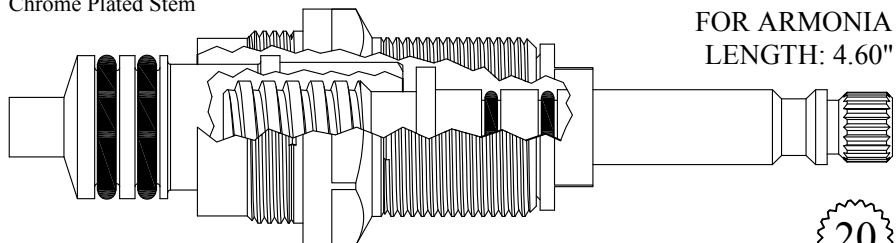

**431441**  
 GASKET: 895570 INCLUDED

**20**  
 3-14

SEAT USED: LF649430

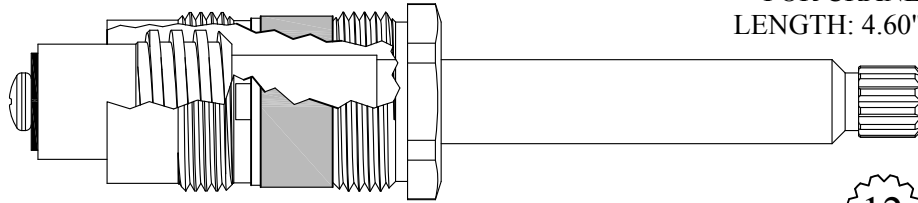

FOR CRANE  
LENGTH: 4.60"

408301/ 408302  
208301/ 208302 Stem Only

12  
1-2

SEAT USED: LF649430

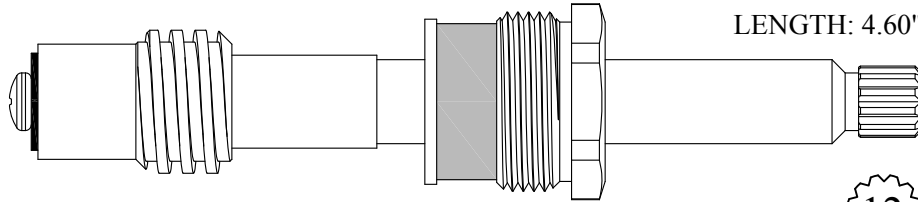

LENGTH: 4.60"

LF408321/ LF408322  
LF208301/ LF208302 Stem Only } For Lavatory

12  
1-2

SEAT USED: LF649430

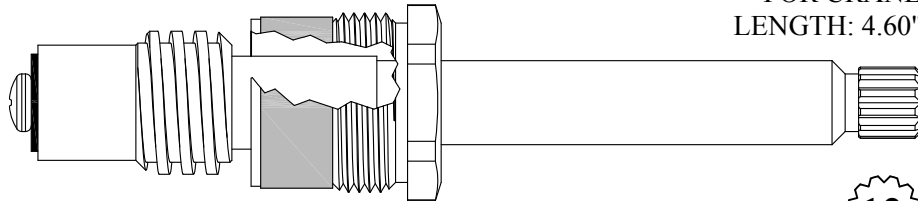

FOR CRANE  
LENGTH: 4.60"

408321/ 408322  
208301/ 208302 Stem Only } For Shower

12  
1-2

SEAT USED: LF647450

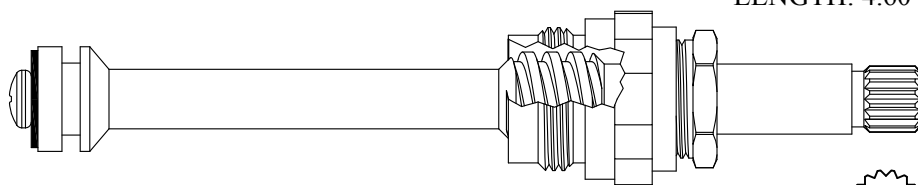

FOR SAYCO  
LENGTH: 4.60"

LF474051/ LF474052  
LF274051/ LF274052 Stem Only  
GASKET: 895100

16  
2-3

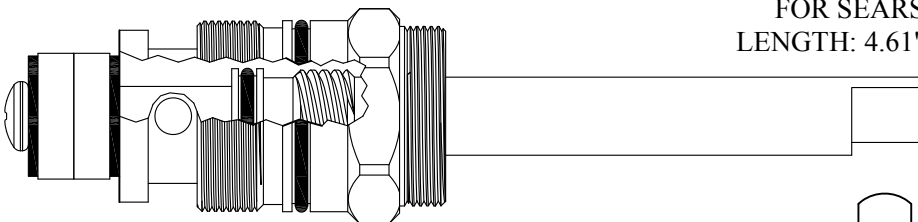

FOR SEARS  
LENGTH: 4.61"

430911  
230961 Stem Only



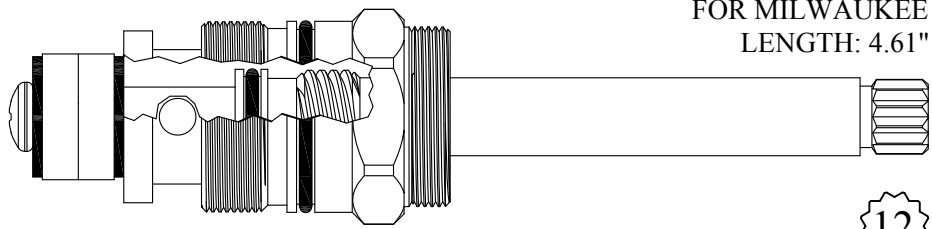

**430951**

GASKET: 890200 O-RING INCLUDED

12  
1-1

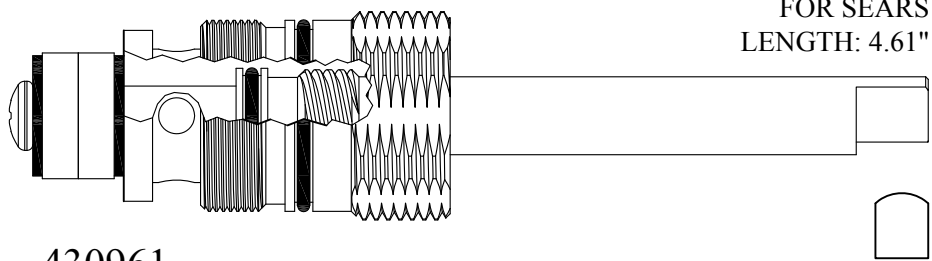

**430961**

**230961** Stem Only

FOR SEARS  
LENGTH: 4.61"

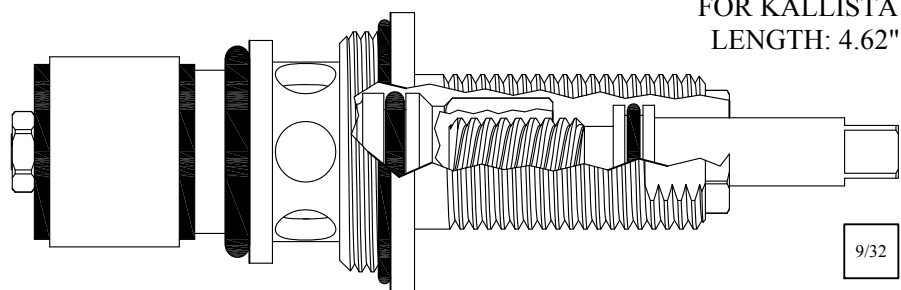

**430642**

GASKET: 890240 O-RING INCLUDED

FOR KALLISTA  
LENGTH: 4.62"

9/32

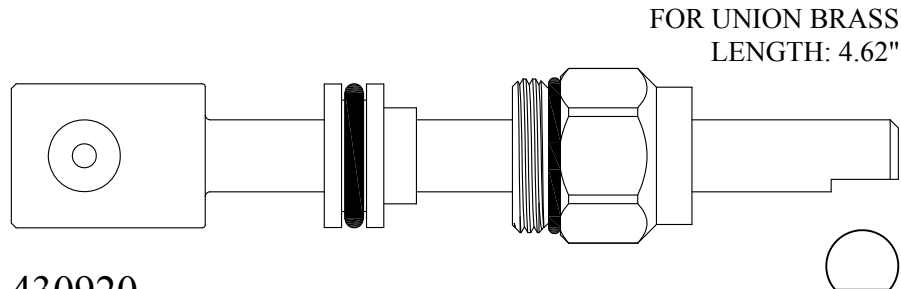

**430920**

**230920** Stem Only

GASKET: 890170 O-RING INCLUDED

FOR UNION BRASS  
LENGTH: 4.62"

Chrome Plated Push Button

FOR SYMMONS  
LENGTH: 4.63"

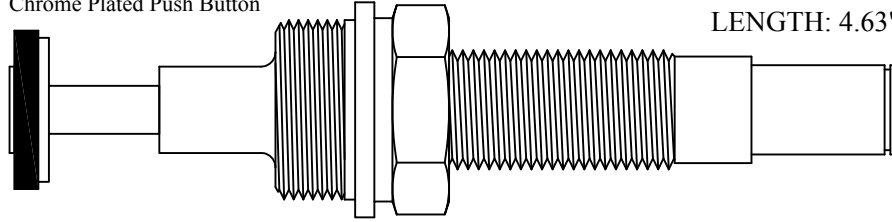

430830

GASKET: 895350 INCLUDED

SEAT USED: LF649200

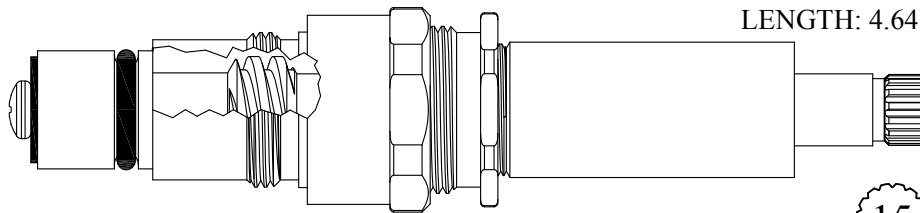
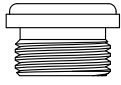

LENGTH: 4.64"

407901

GASKET: 895150

15  
3-27

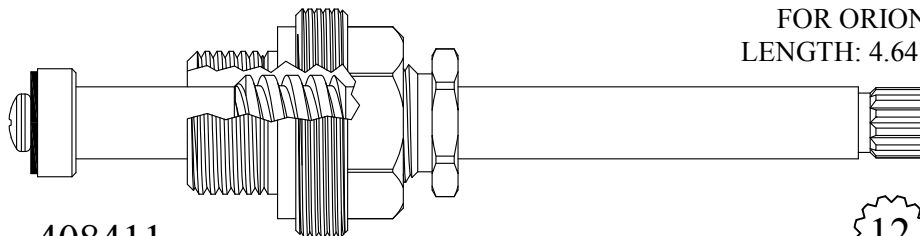

FOR ORION  
LENGTH: 4.64"

408411

GASKET: 895100

12  
1-2

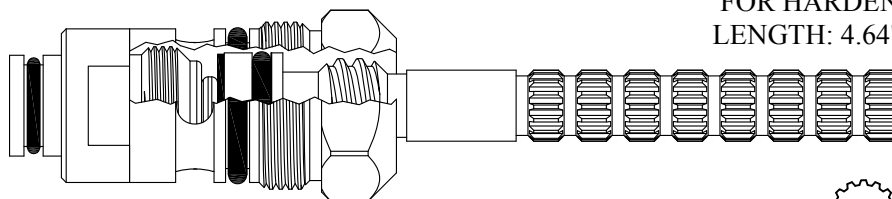

FOR HARDEN  
LENGTH: 4.64"

408031/ 408032

GASKET: 891140 O-RING INCLUDED

16  
3-16

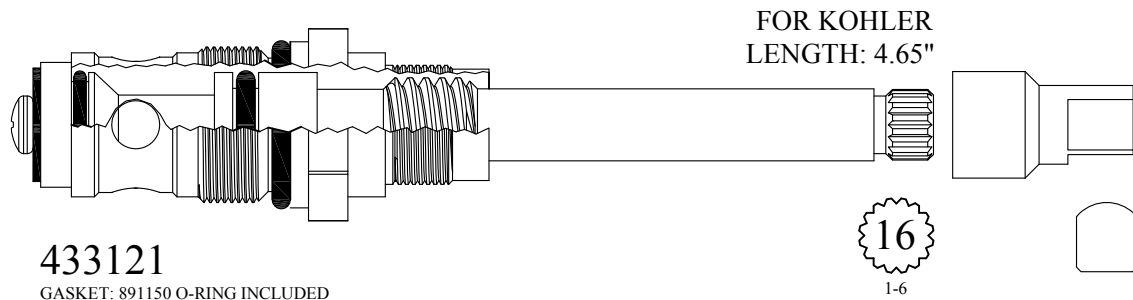
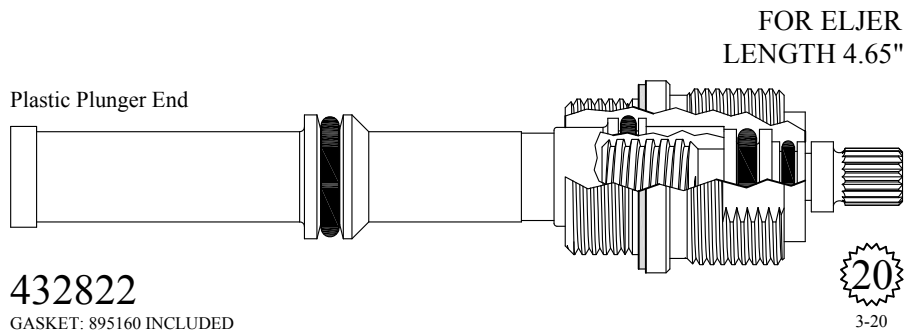
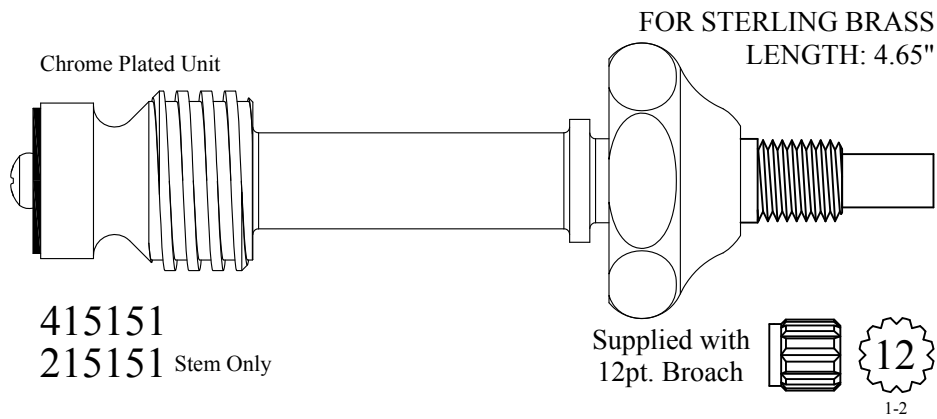
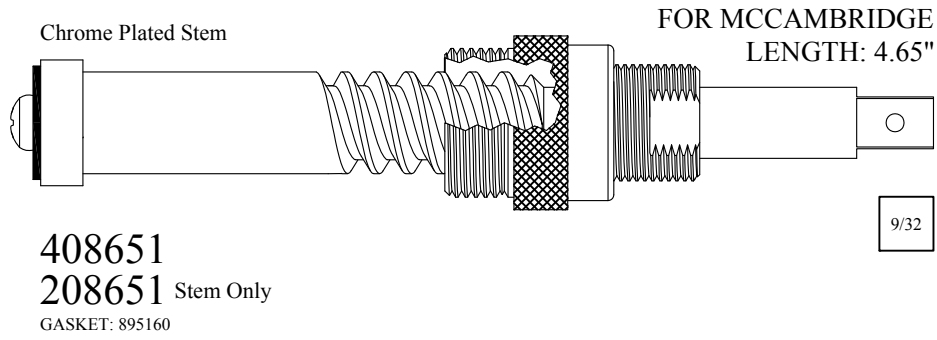

Also available with seat LF648070  
LF433121-S





1/2 Turn Ceramic  
Polished Gold Stem

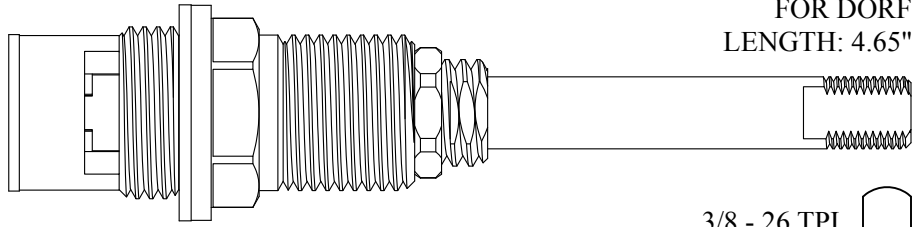

FOR DORF  
LENGTH: 4.65"

3/8 - 26 TPI



**407941/ 407942**

DISC SET: 124290-PKG  
GASKET: 895370 INCLUDED

Also available with a Polished Chrome Plated Stem

**407941-CP / 407942-CP**

FOR CRANE  
LENGTH: 4.67"

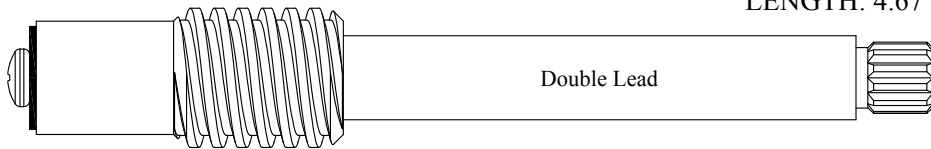

**231031**



FOR CRANE  
LENGTH: 4.67"



SEAT USED: LF649430

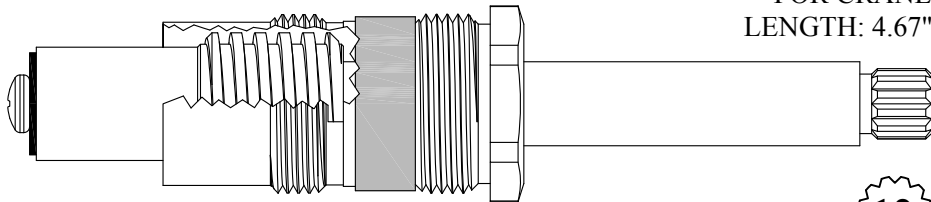

**408201**

**208201** Stem Only



FOR CRANE  
LENGTH: 4.67"



SEAT USED: LF649430

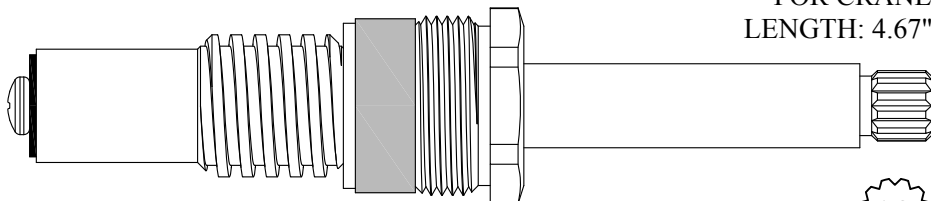

**408211**

**208201** Stem Only

GASKET: INCLUDED



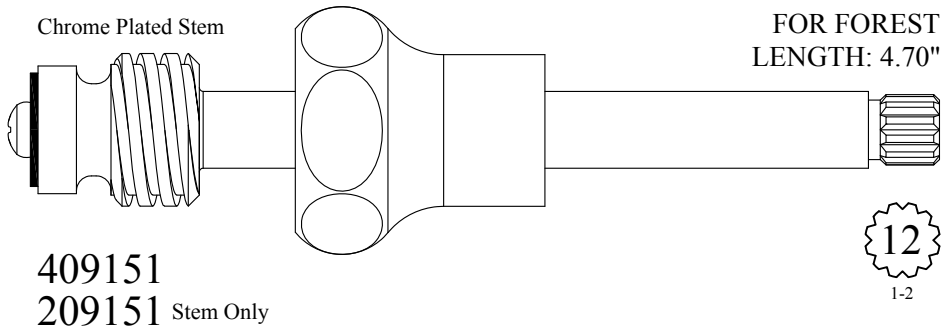

409151  
209151 Stem Only

12  
1-2

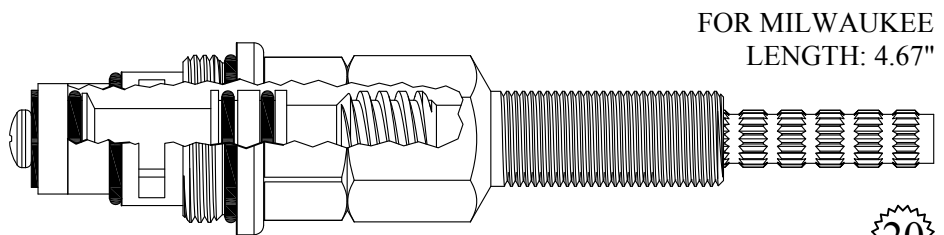

430931  
GASKET: 890180 O-RING INCLUDED

20  
3-20

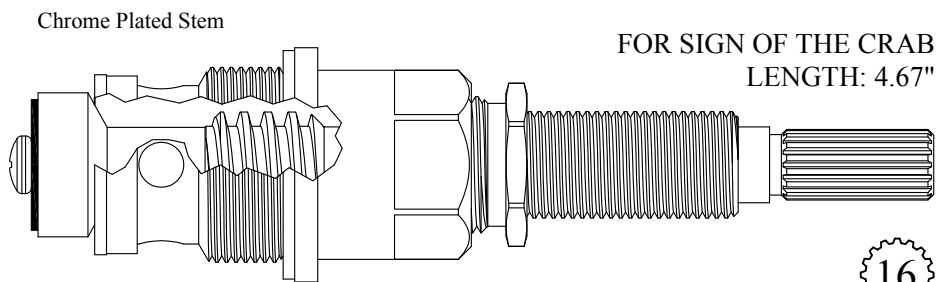

430971  
GASKET: 895570 INCLUDED

16  
3-16

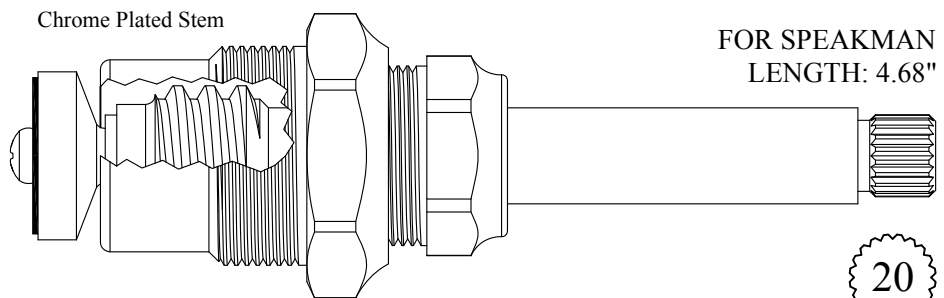
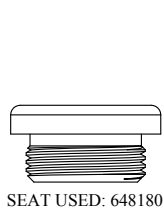

408801  
208801 Stem Only  
GASKET: 895450

20  
2-4

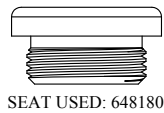

Chrome Plated Stem

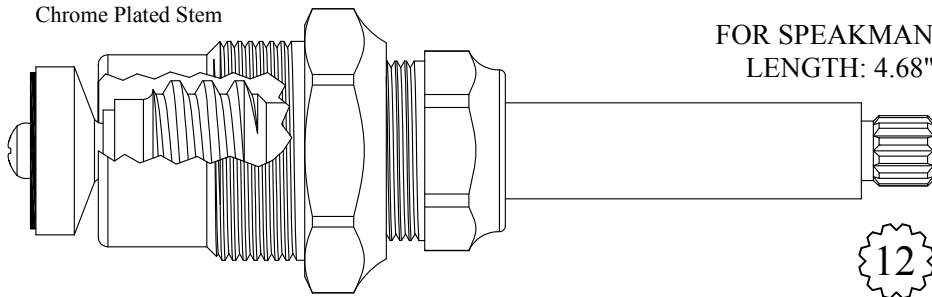

FOR SPEAKMAN  
LENGTH: 4.68"



408851

208851 Stem Only

GASKET: 895450

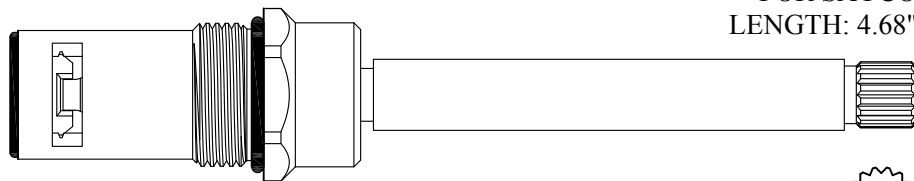

FOR SAYCO  
LENGTH: 4.68"



408611/ 408612

GASKET: 890170 O-RING INCLUDED

SEAL: 898510

DISC SET: 151380-PKG



Chrome Plated Stem

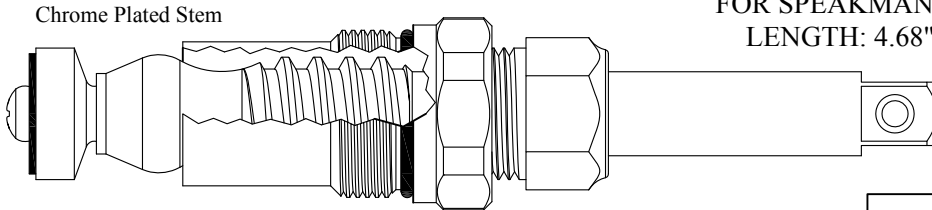

FOR SPEAKMAN  
LENGTH: 4.68"



LF475111/ LF475112

LF275111/ LF275112 Stem Only

GASKET: 890180 O-RING INCLUDED

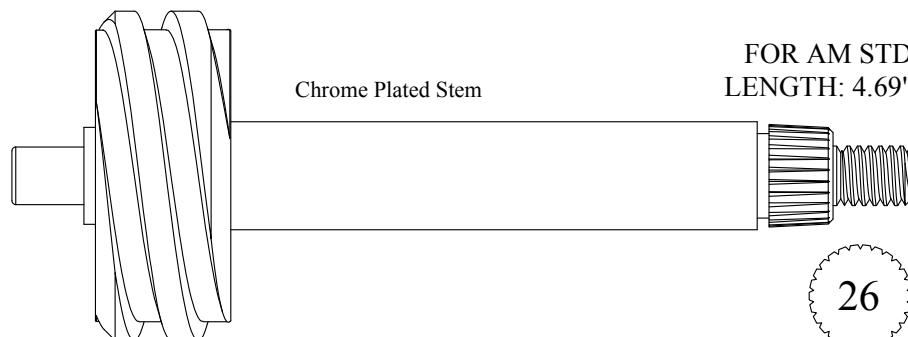

Chrome Plated Stem

FOR AM STD  
LENGTH: 4.69"



208811

FOR PRICE PFISTER  
LENGTH: 4.69"

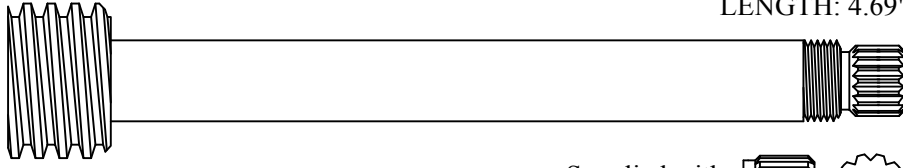

208971

Supplied with  
12pt. Broach



FOR BRIGGS  
LENGTH: 4.69"

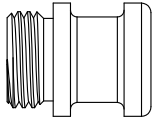

SEAT USED: LF648250

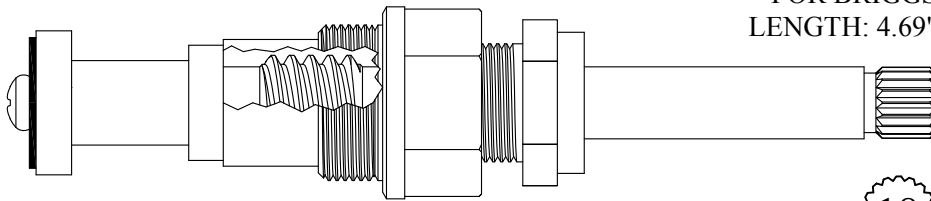

408701

GASKET: 895150



FOR BRIGGS  
LENGTH: 4.69"

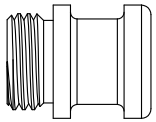

SEAT USED: LF648250

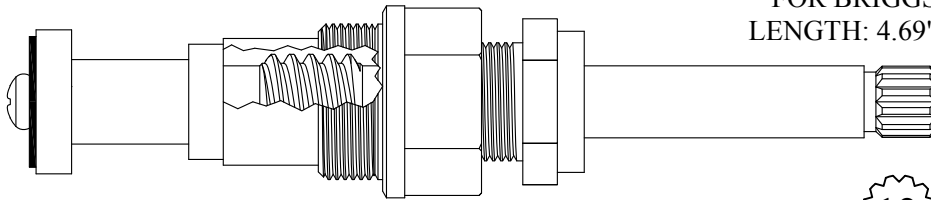

408751

GASKET: 895150



FOR AM STD  
LENGTH: 4.69"

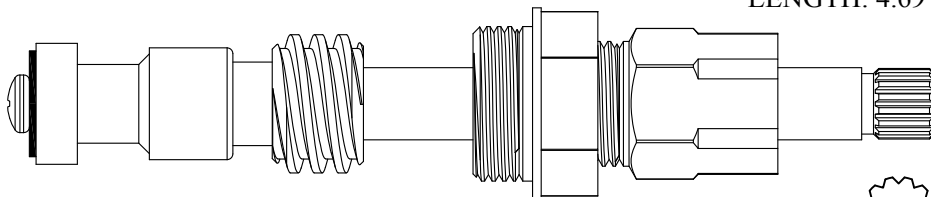

LF475201  
LF275201 Stem Only



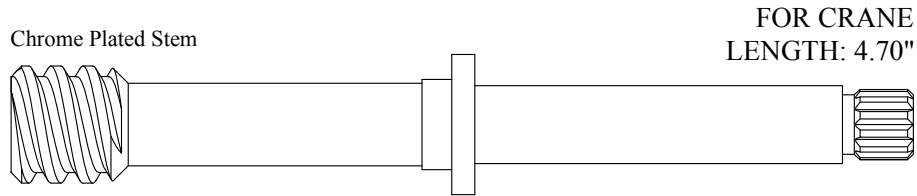

208961

12  
1-2

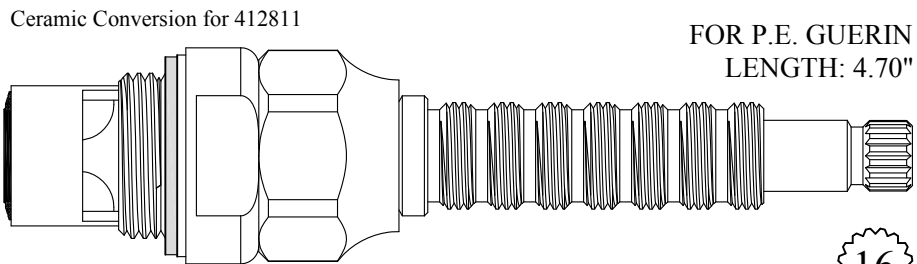

407991

GASKET: 895400 INCLUDED  
SEAL: 898510  
DISC SET: 151380-PKG

16  
1-6

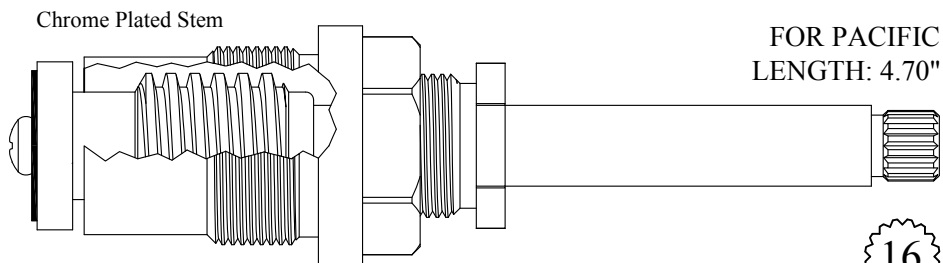

413321

213321 Stem Only

GASKET: 895540

16  
1-6

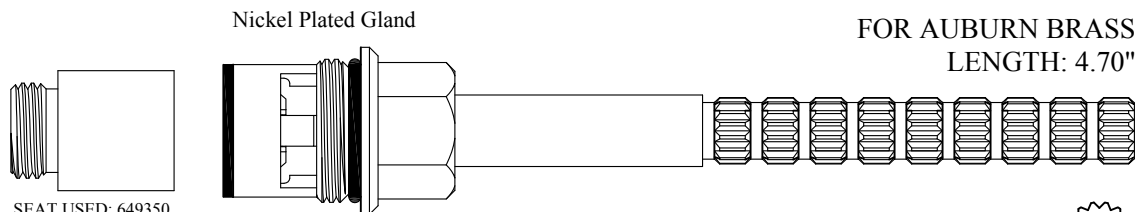

404831/ 404832

GASKET: 890160 O-RING INCLUDED  
DISC SET: 151380-PKG

16  
2-3

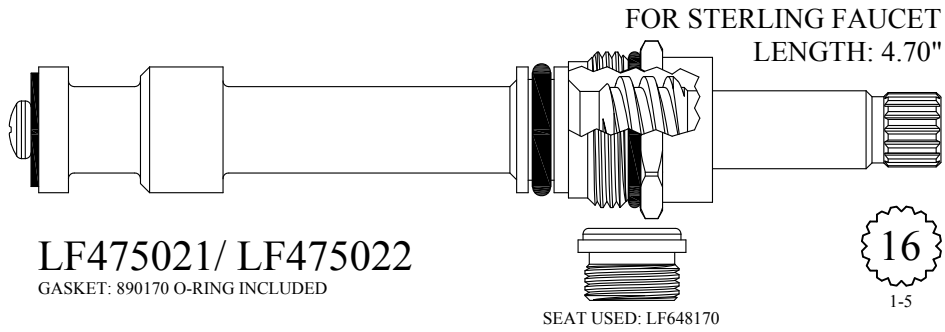

**LF475021/ LF475022**  
 GASKET: 890170 O-RING INCLUDED

SEAT USED: LF648170

**16**  
 1-5

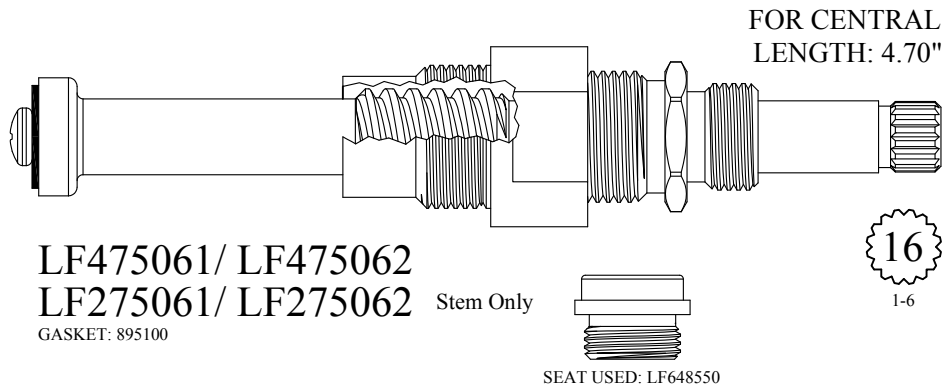

**LF475061/ LF475062**  
**LF275061/ LF275062** Stem Only  
 GASKET: 895100

SEAT USED: LF648550

**16**  
 1-6

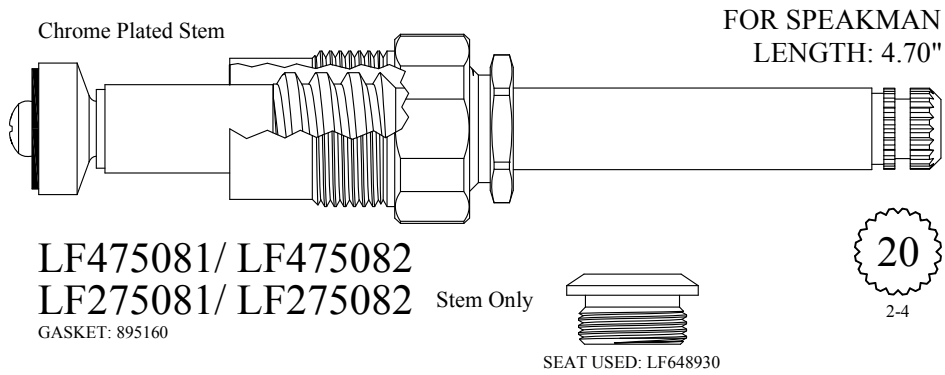

Chrome Plated Stem  
**LF475081/ LF475082**  
**LF275081/ LF275082** Stem Only  
 GASKET: 895160

SEAT USED: LF648930

**20**  
 2-4

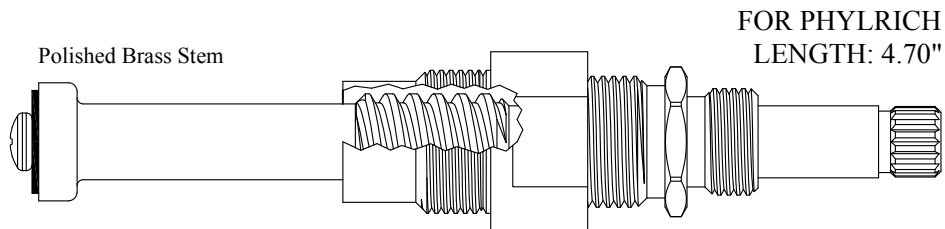

Polished Brass Stem  
**LF475091/ LF475092**  
**LF275091/ LF275092** Stem Only  
 GASKET: 895100

Also available with chrome plated stem  
**LF475091-CP/ LF475092-CP**  
**LF275091-CP/ LF275092-CP** Stem Only

**16**  
 1-6

SEAT USED: LF648550



SEAT USED: LF648930

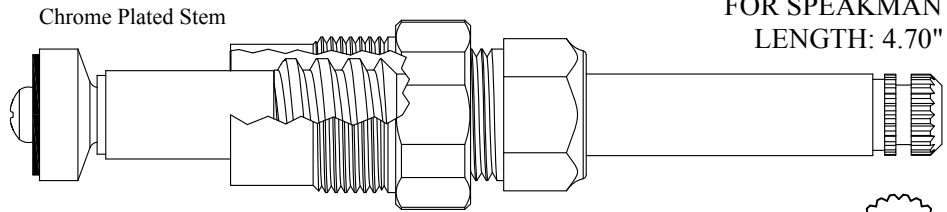

LF475121/ LF475122  
 LF275081/ LF275082 Stem Only  
 GASKET: 895160

20  
 2-4



SEAT USED: LF648930

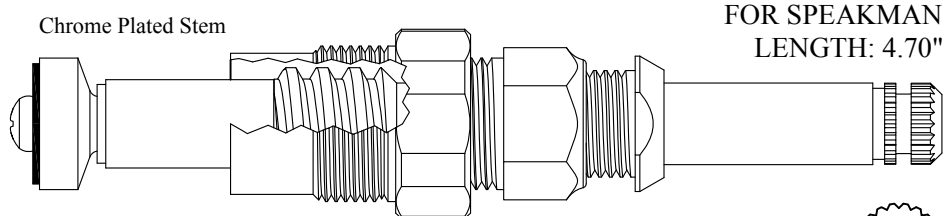

LF475131/ LF475132  
 LF275081/ LF275082 Stem Only  
 GASKET: 895160

20  
 2-4

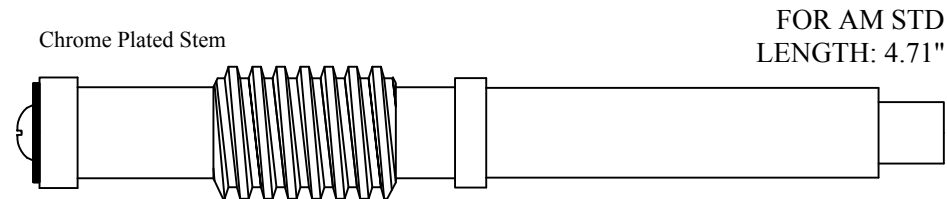

208951

Supplied with  
 12pt. Broach

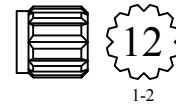

12  
 1-2

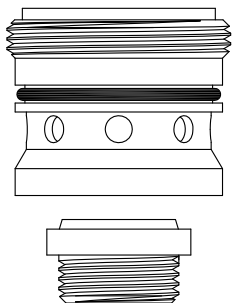

SEAT KIT USED: 106090

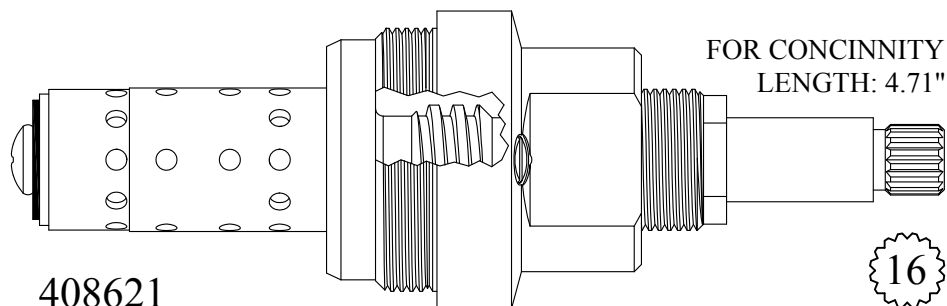

408621  
 208621 Stem Only  
 GASKET INCLUDED: 895500

16  
 1-6

FOR AM STD  
LENGTH: 4.71"

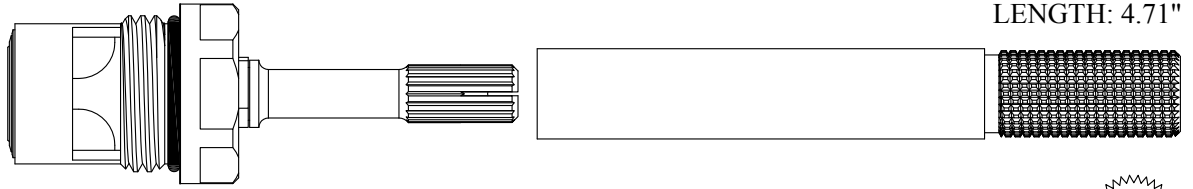

**419211**  
SEAL: 898510-W  
DISC SET: 151380-PKG

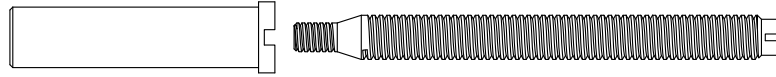

34

FOR ELJER  
LENGTH: 4.72"

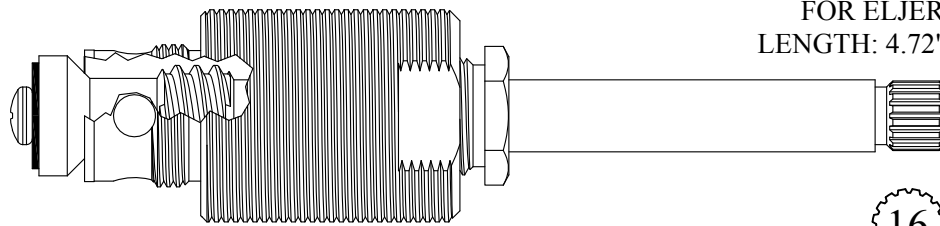

**430321**  
**231001** Stem Only  
GASKET: 895100

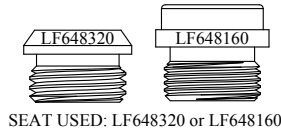

16  
3-15

SEAT USED: LF648320 or LF648160

FOR ELJER  
LENGTH: 4.72"

Chrome Plated Sleeve

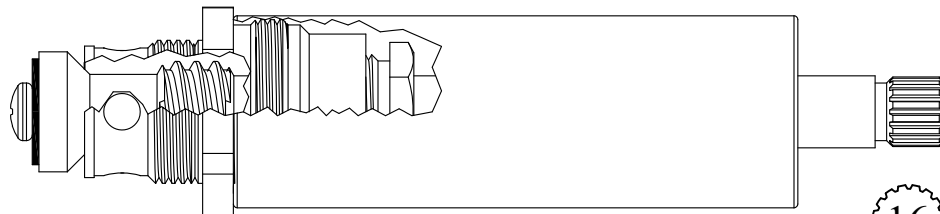

**431001**  
**231001** Stem Only  
GASKET: 895100

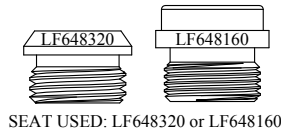

16  
3-15

SEAT USED: LF648320 or LF648160

FOR ELJER  
LENGTH: 4.72"

Chrome Plated Gland



**431021**  
**231001** Stem Only  
GASKET: 895100

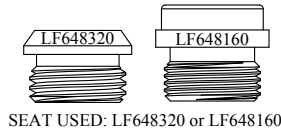

16  
3-15

SEAT USED: LF648320 or LF648160



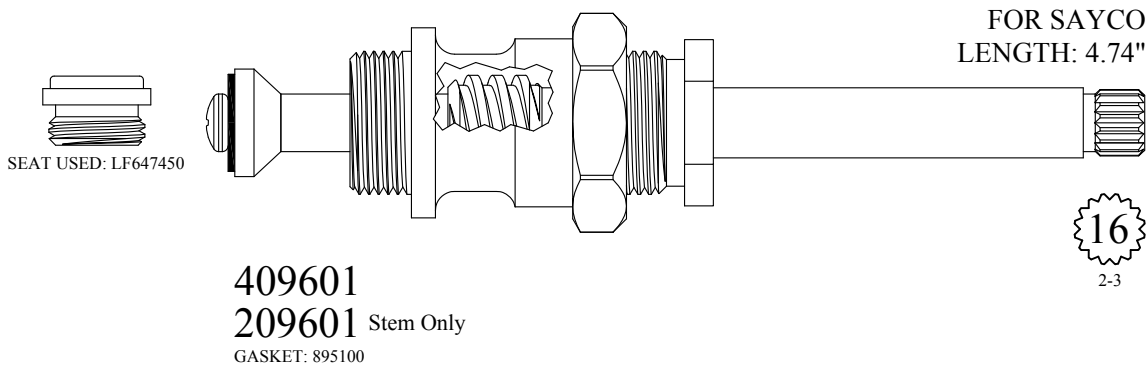
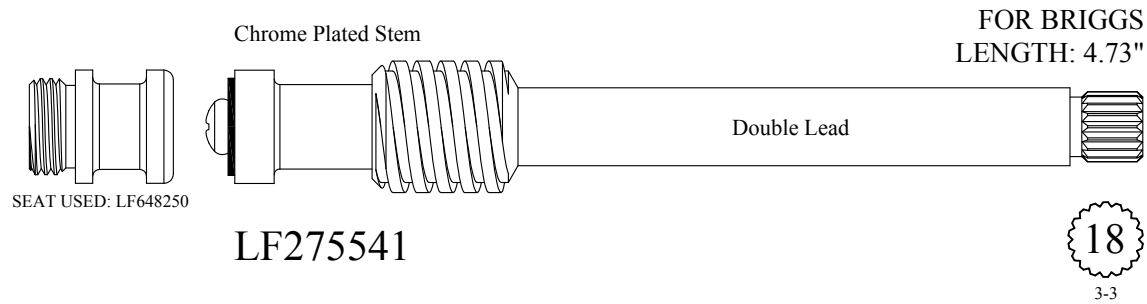
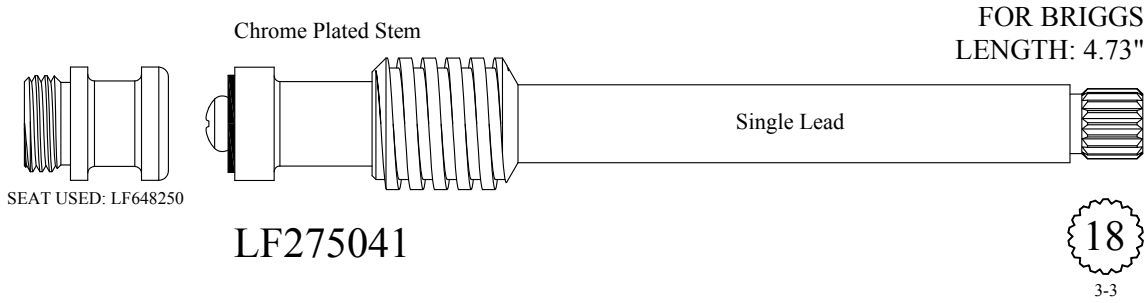
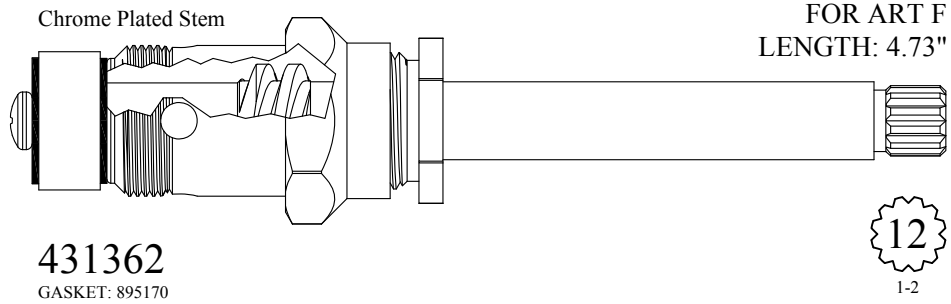

SEAT USED: LF647450

Chrome Plated Stem

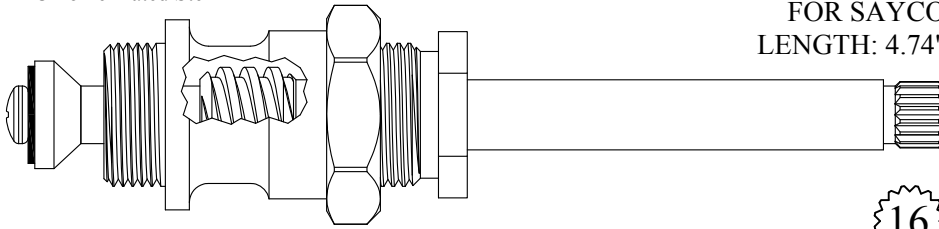

FOR SAYCO  
LENGTH: 4.74"

16  
2-3

409611  
209611 Stem Only  
GASKET: 895100

Plastic Escutcheon Nipple

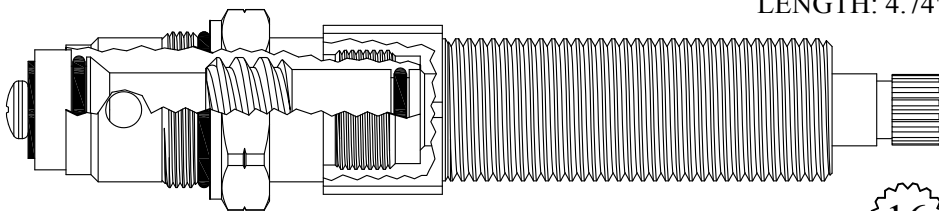

FOR KOHLER  
LENGTH: 4.74"

16  
1-6

430941  
GASKET: 890170 O-RING INCLUDED

FOR UNION BRASS  
LENGTH: 4.74"

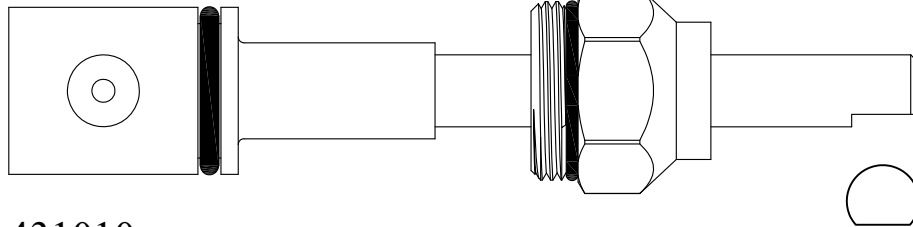

431010  
231010 Stem Only  
GASKET: 890190 O-RING INCLUDED

FOR UNION BRASS  
LENGTH: 4.74"

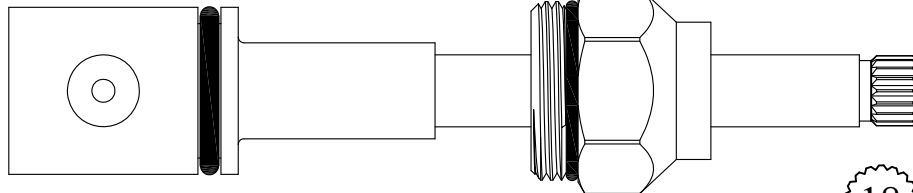

431060  
GASKET: 890190 O-RING INCLUDED

18  
3-3

Chrome Plated Stem

FOR CRANE  
LENGTH: 4.75"

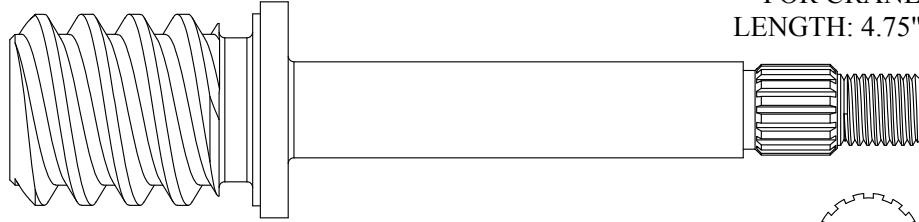

212511



Chrome Plated Stem

FOR SAYCO  
LENGTH: 4.75"

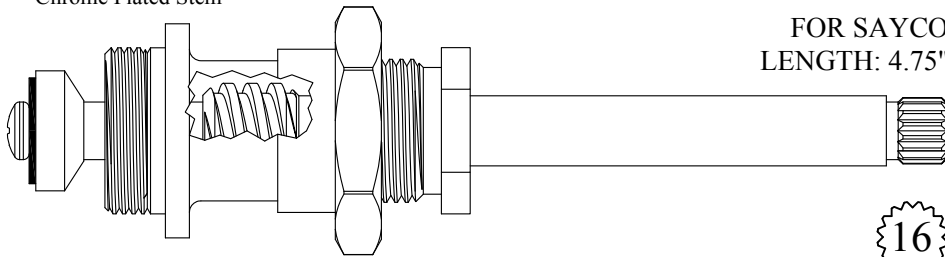
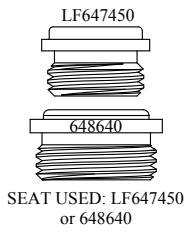

409801  
209801 Stem Only  
GASKET: 895400



FOR KALLISTA  
LENGTH: 4.75"

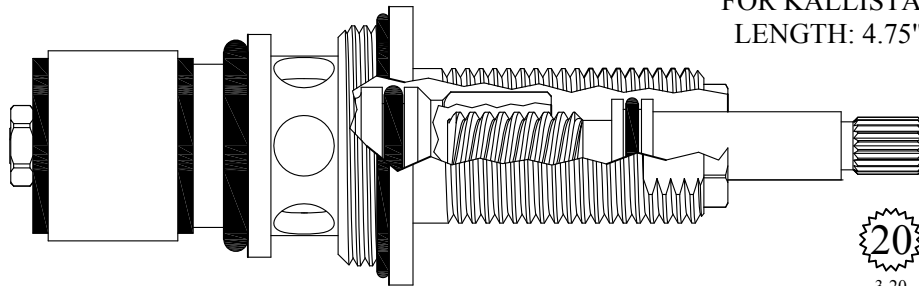

430782  
GASKET: 890240 O-RING INCLUDED



Chrome Plated Stem

FOR KOHLER  
LENGTH: 4.75"

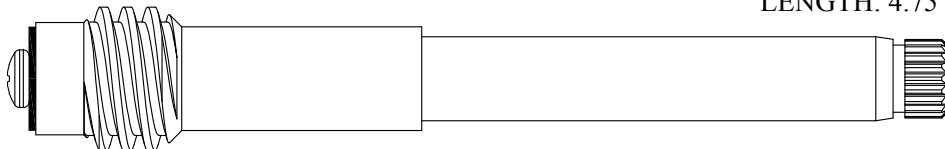
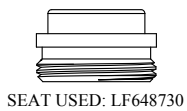

LF276011/ LF276012



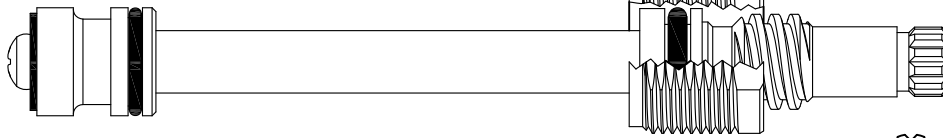

FOR HARCRAFT  
LENGTH: 4.75"

**LF475071**

GASKET: 895040 INCLUDED



Chrome Plated Stem

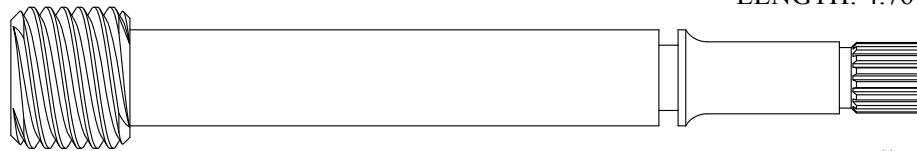

FOR MILWAUKEE  
LENGTH: 4.76"

**231331**

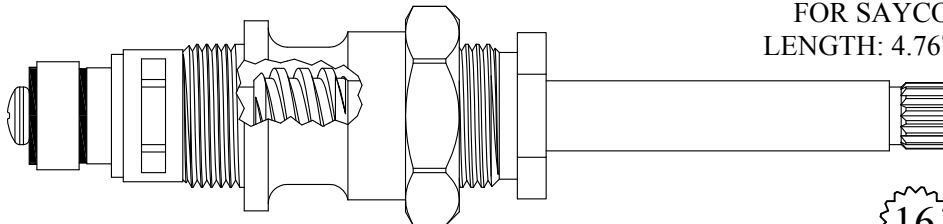

FOR SAYCO  
LENGTH: 4.76"

**431201**

**231201** Stem Only

GASKET: 895100

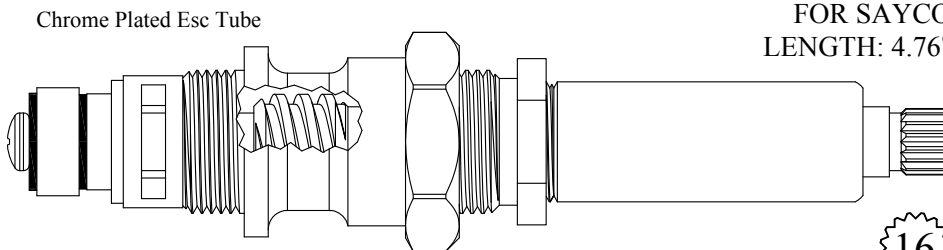

FOR SAYCO  
LENGTH: 4.76"

**431221**

**231201** Stem Only

GASKET: 895100



SEAT USED: LF647450

Chrome Plated Stem

FOR SAYCO  
LENGTH: 4.76"

16  
2-3

431341  
231341 Stem Only  
GASKET: 895100

FOR WATERWORKS  
LENGTH: 4.76"

20  
3-20

409941/ 409942  
GASKET: 890210 O-RING INCLUDED  
SEAL: 898520  
DISC SET: 109850-PKG

FOR WATERWORKS  
LENGTH: 4.76"

20  
3-20

409941-EN/ 409942-EN Escutcheon Nipple available separately  
127350  
GASKET: 890210 O-RING INCLUDED  
SEAL: 898520  
DISC SET: 109850-PKG

SEAT USED: LF647450  
or 648640

LF647650  
648640

Chrome Plated Stem

FOR SAYCO  
LENGTH: 4.77"

16  
2-3

431401  
231401 Stem Only  
GASKET: 895400

Stem also available less cage  
231401-1

FOR SPEAKMAN  
LENGTH: 4.77"

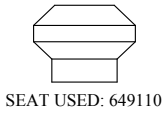

LF275900

FOR BEAR BRAND  
LENGTH: 4.78"

Chrome Plated Unit

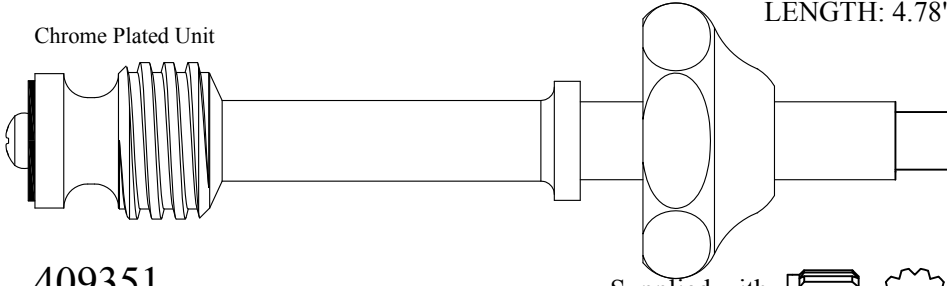

409351  
209351 Stem Only

Supplied with  
12pt. Broach

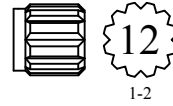

Chrome Plated Stem  
18 TPI Gland

FOR UNION BRASS  
LENGTH: 4.78"

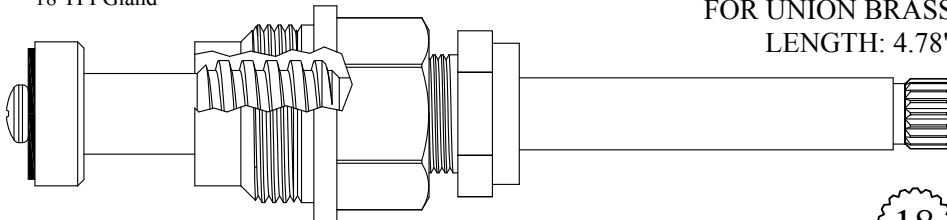

409701  
209701 Stem Only  
GASKET: 895370



Chrome Plated Stem  
20 TPI Gland

FOR UNION BRASS  
LENGTH: 4.78"

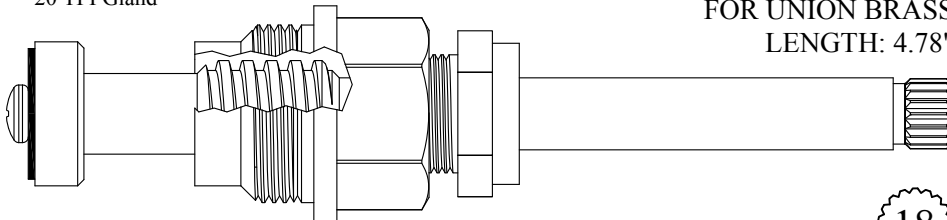

409711  
209701 Stem Only  
GASKET: 895370





SEAT USED: LF648760

Chrome Plated Stem

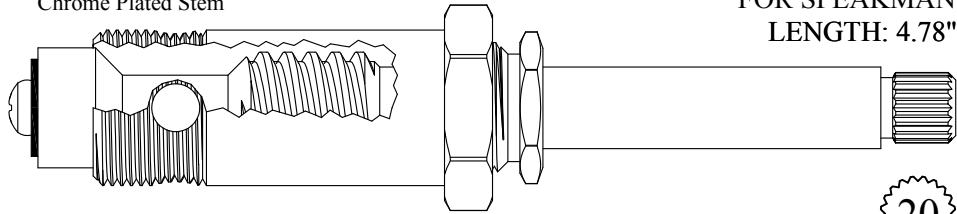

FOR SPEAKMAN  
LENGTH: 4.78"

431141  
231141 Stem Only



SEAT USED: LF648760

Chrome Plated Stem

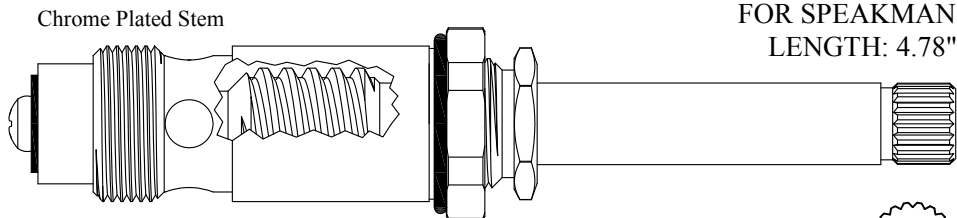

FOR SPEAKMAN  
LENGTH: 4.78"

431191  
231191 Stem Only  
GASKET: 890180 O-RING INCLUDED

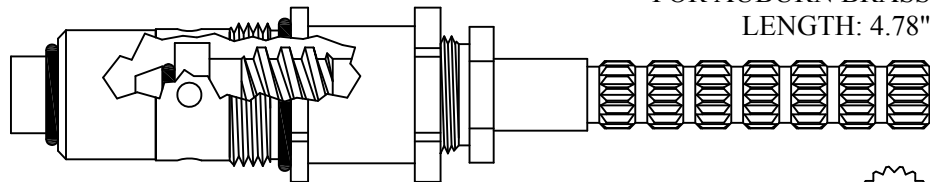

FOR AUBURN BRASS  
LENGTH: 4.78"

409921/ 409922  
GASKET: 890160 O-RING INCLUDED



Chrome Plated Stem

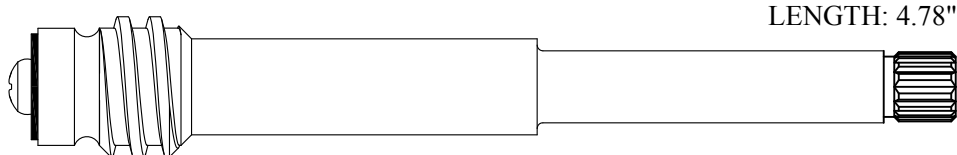

FOR MUELLER  
LENGTH: 4.78"

LF274061

Supplied with  
12pt. Broach



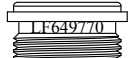
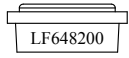

SEAT USED:  
LF648200  
or LF649770

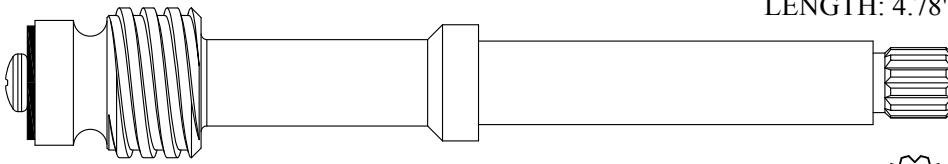

FOR CRANE  
LENGTH: 4.78"

LF275031/ LF275032

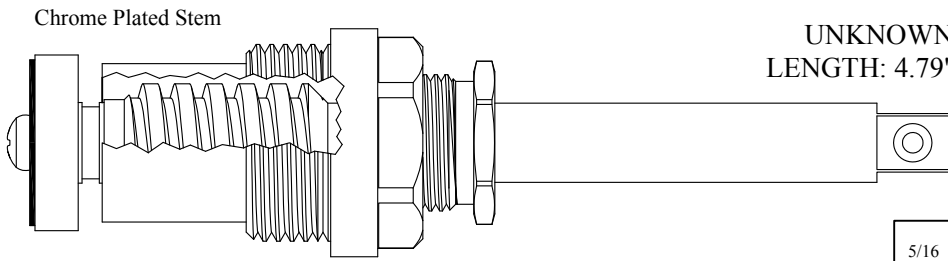

Chrome Plated Stem

UNKNOWN  
LENGTH: 4.79"

406931  
206931 Stem Only  
GASKET: 895560

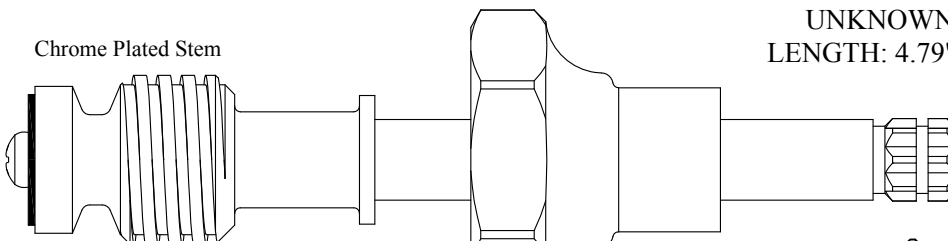

Chrome Plated Stem

UNKNOWN  
LENGTH: 4.79"

414521  
214521 Stem Only

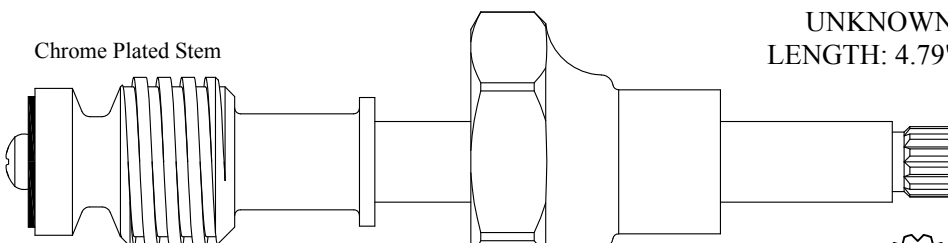

Chrome Plated Stem

UNKNOWN  
LENGTH: 4.79"

414571  
214571 Stem Only





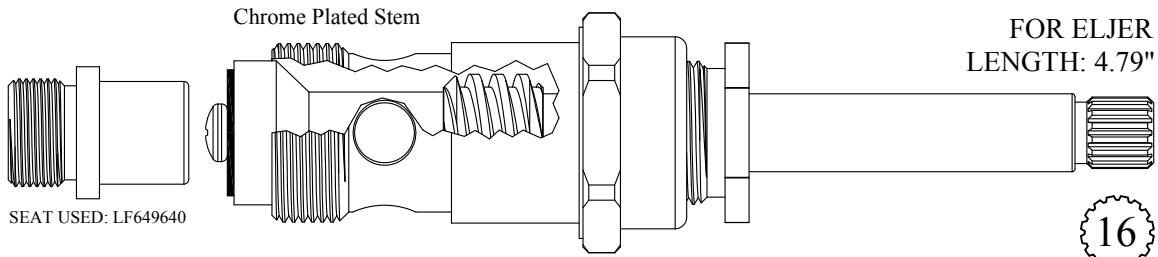

431301  
231301 Stem Only  
GASKET: 895320

Also available with  
Polished Brass stem  
431301-PB  
231301-PB Stem Only

12  
1-2

FOR ELJER  
LENGTH: 4.79"

Also available with 12pt broach  
431351  
231351 Stem Only

16  
3-15

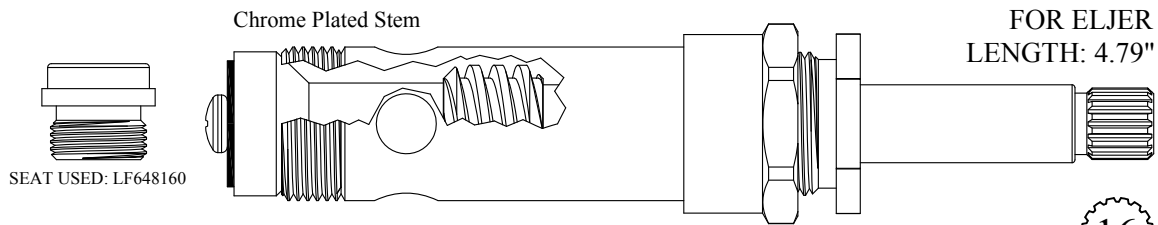

431321  
231301 Stem Only  
GASKET: 895150

FOR ELJER  
LENGTH: 4.79"

16  
3-15

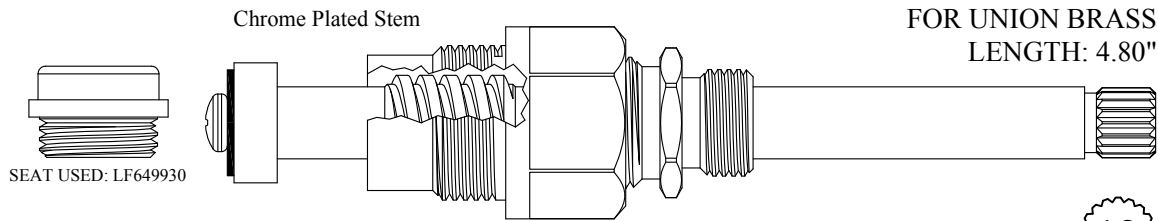

409811/ 409812  
209811/ 209812 Stem Only  
GASKET: 895150

FOR UNION BRASS  
LENGTH: 4.80"

18  
3-3

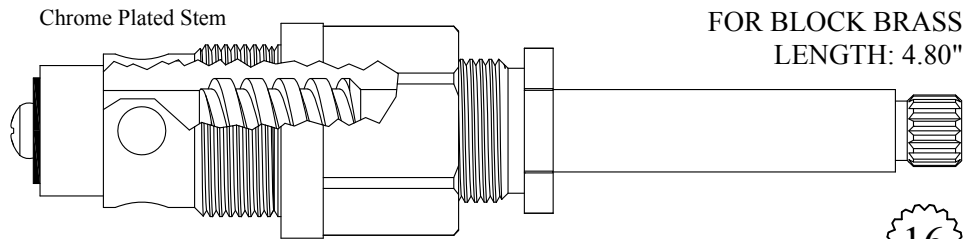

431041  
231041 Stem Only  
GASKET: 895290

FOR BLOCK BRASS  
LENGTH: 4.80"

16  
1-6

FOR STREAMWAY  
LENGTH: 4.80"

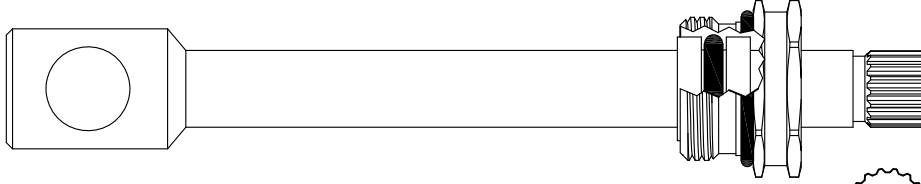

431310

231310 Stem Only

GASKET: 890170 O-RING INCLUDED



FOR WOLVERINE  
LENGTH: 4.80"

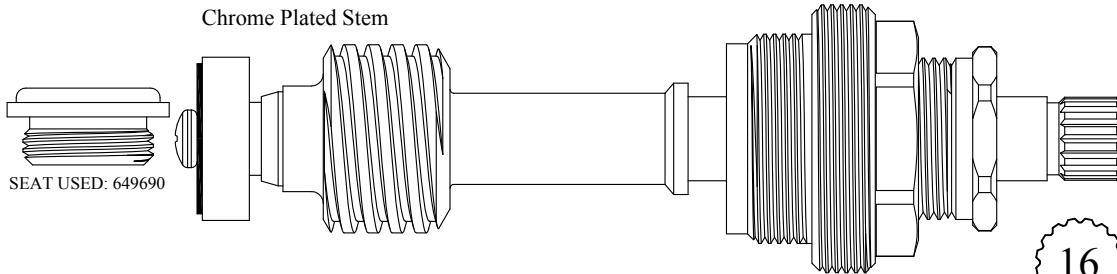

410101/ 410102

210101/ 210102 Stem Only

GASKET: 895450



FOR WOLVERINE  
LENGTH: 4.80"

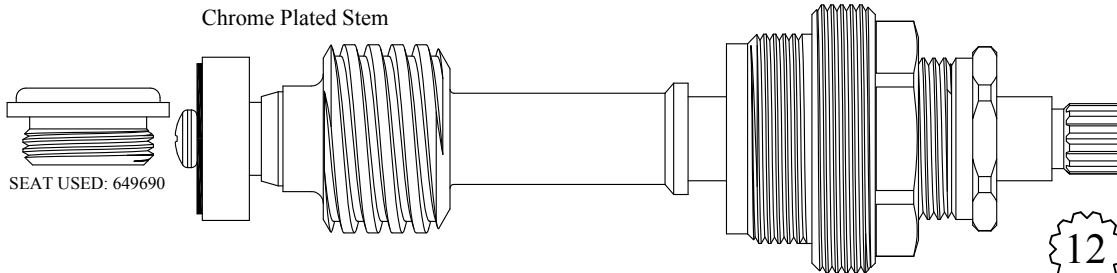

410151/ 410152

210151/ 210152 Stem Only

GASKET: 895450



FOR DICK BROS.  
LENGTH: 4.81"

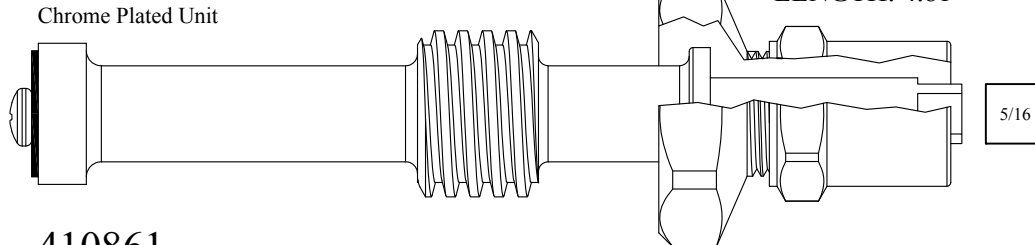

410861

210861 Stem Only

GASKET: 895400 INCLUDED

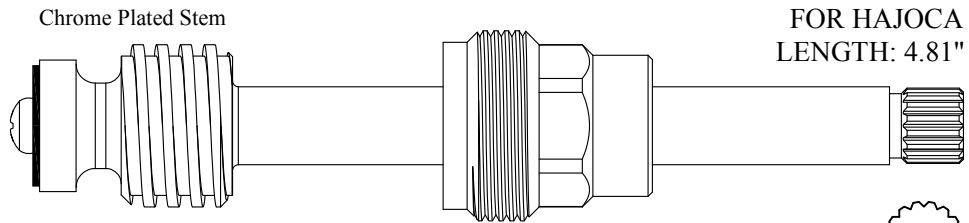

Chrome Plated Stem

FOR HAJOCA  
LENGTH: 4.81"

415321  
215321 Stem Only

16  
1-5

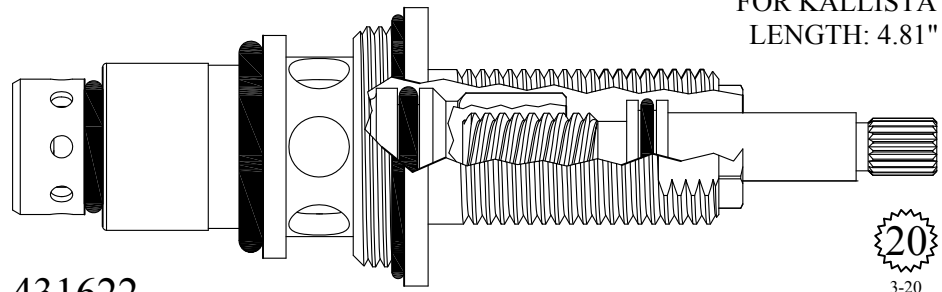

FOR KALLISTA  
LENGTH: 4.81"

431622  
GASKET: 890240 O-RING INCLUDED

20  
3-20

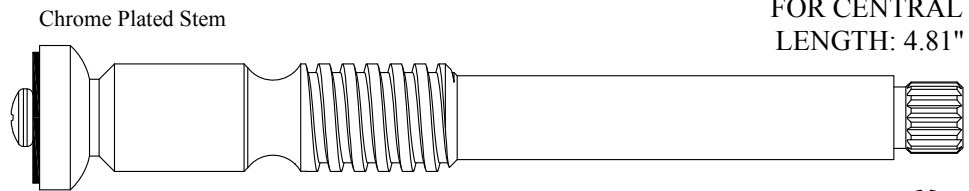

Chrome Plated Stem

FOR CENTRAL  
LENGTH: 4.81"

LF276101

16  
1-6

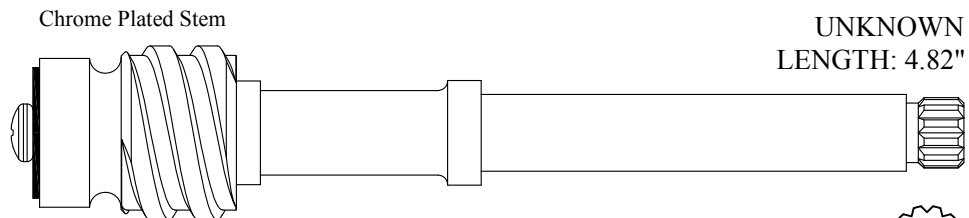

Chrome Plated Stem

UNKNOWN  
LENGTH: 4.82"

209451

12  
1-2

USES BARREL:  
LF647021/LF647022

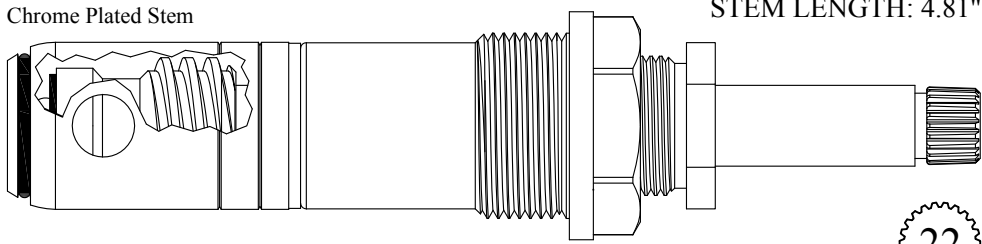

LF476031/ LF476032  
LF276031/ LF276032 Stem Only LF476231/ LF476232  
GASKET: 818010

Also available less barrel

22  
1-4

USES BARREL:  
LF647021/LF647022

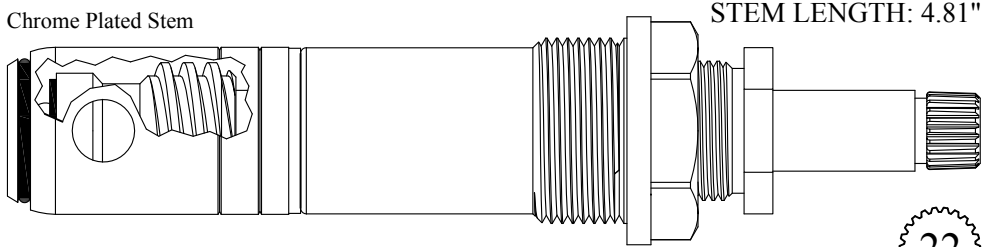

LF476041/ LF476042  
LF276031/ LF276032 Stem Only LF476241/ LF476242  
GASKET: 818010

Also available less barrel

22  
1-4

USES BARREL:  
LF647021/LF647022

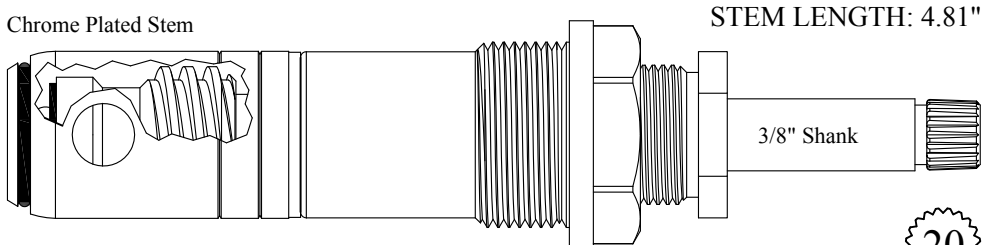

LF476131/ LF476132  
LF276131/ LF276132 Stem Only LF476331/ LF476332  
GASKET: 818010

Also available less barrel

20  
3-14

USES BARREL:  
LF647021/LF647022

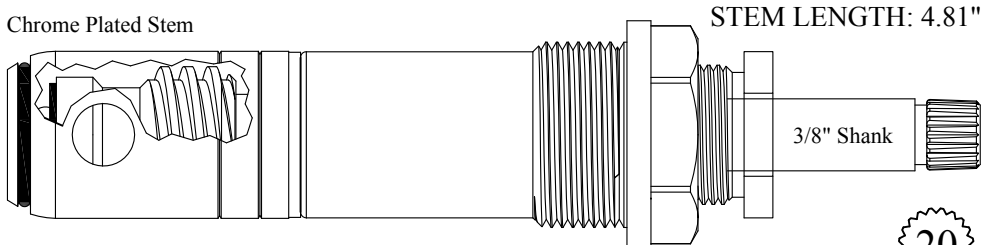

LF476141/ LF476142  
LF276131/ LF276132 Stem Only LF476341/ LF476342  
GASKET: 818010

Also available less barrel

20  
3-14

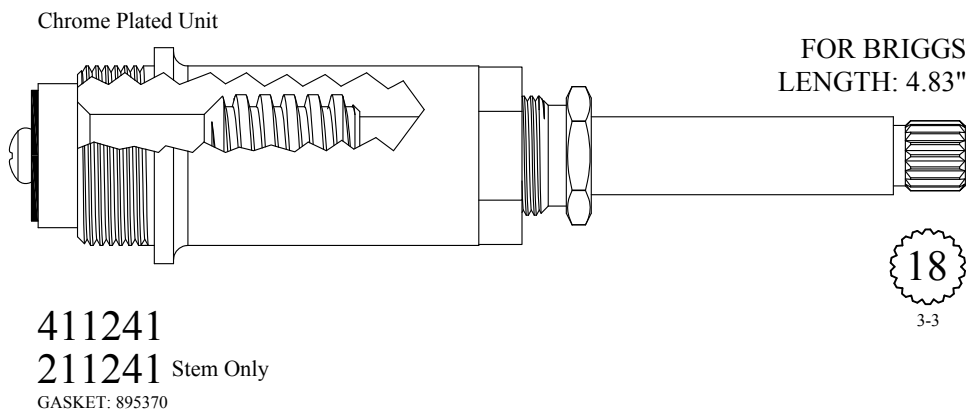
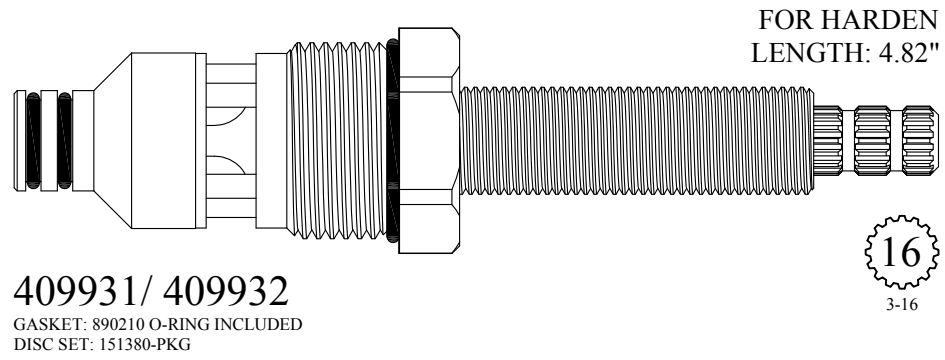
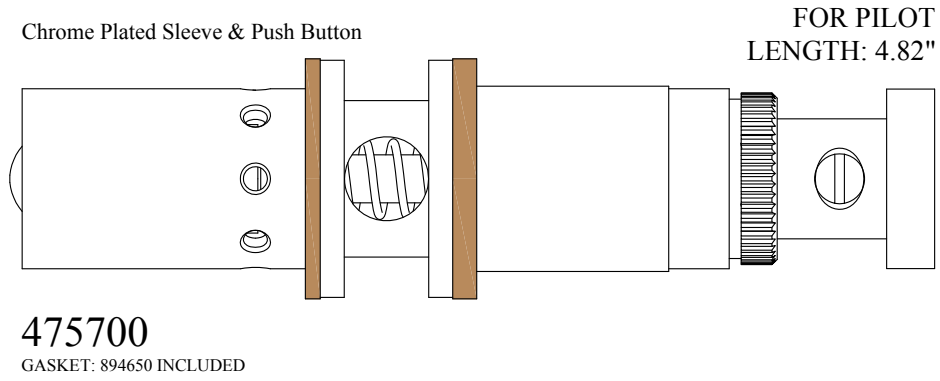
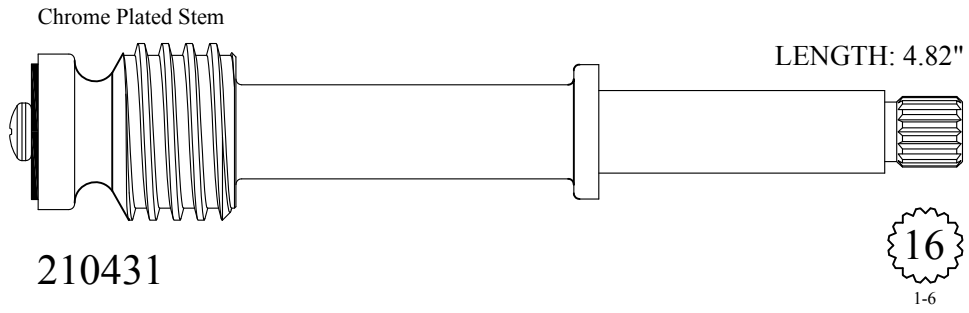

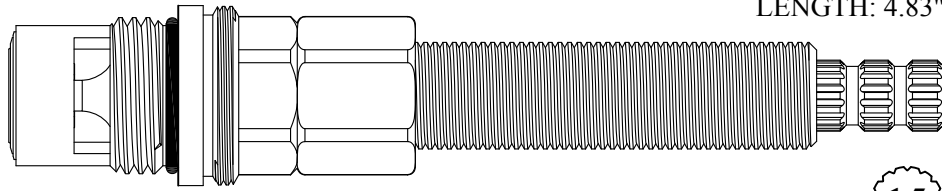

FOR SEPCO  
LENGTH: 4.83"

**410031/ 410032**

GASKET: 890170 O-RING INCLUDED  
SEAL: 898510-W  
DISC SET: 151380-PKG

15  
3-27

Polished Brass Stem Extension

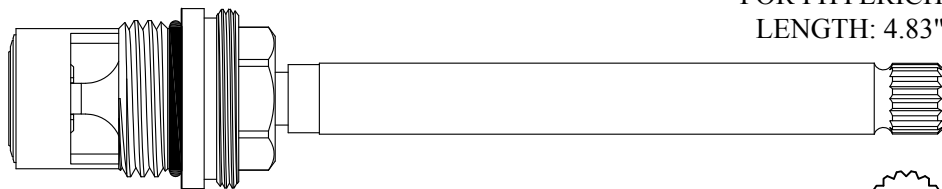

FOR PHYLRICH  
LENGTH: 4.83"

Individual items available  
Stem Ext. 3.25": #132150-PB  
& 132150-CP  
Ext. Adap. Screw: #103310

**410061/ 410062**

GASKET: 890170 O-RING INCLUDED  
SEAL: 898510-W  
DISC SET: 151380-PKG

Also available with chrome plated stem  
**410061-CP/ 410062-CP**

16  
1-6

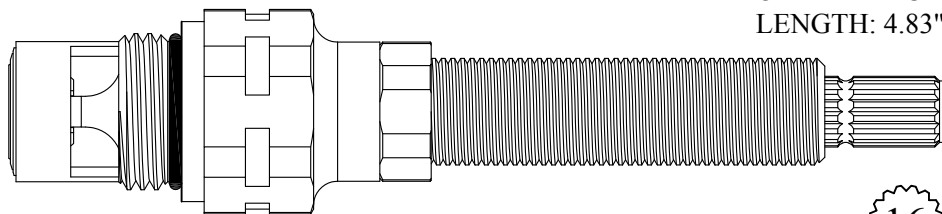

FOR PHYLRICH  
LENGTH: 4.83"

Individual items available  
Stem Ext. 3.25": #102960  
Ext. Adap. Screw: #103310

**410081/ 410082**

GASKET: 890170 O-RING INCLUDED  
SEAL: 898510-W  
DISC SET: 151380-PKG

16  
1-6

Chrome Plated Stem

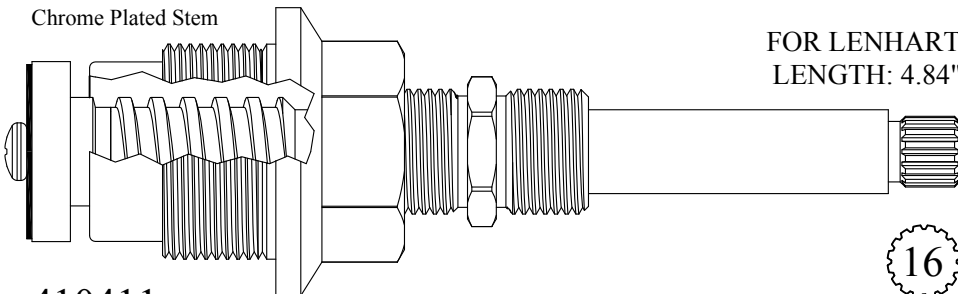

FOR LENHART  
LENGTH: 4.84"

**410411**

**210411** Stem Only

GASKET: 895450

16  
3-15

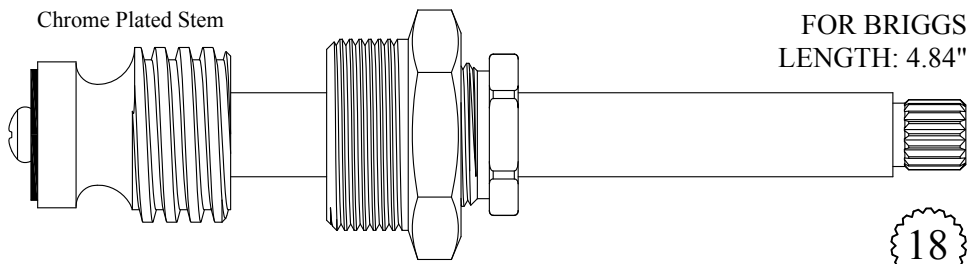

**410901**  
**210901** Stem Only  
 GASKET: 895340

**18**  
 3-3

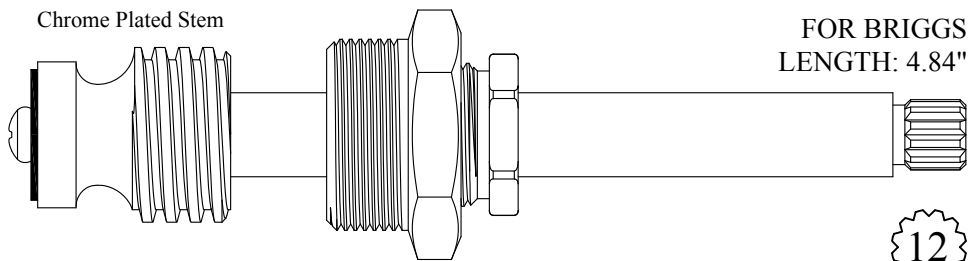

**410951**  
**210951** Stem Only  
 GASKET: 895340

**12**  
 1-2

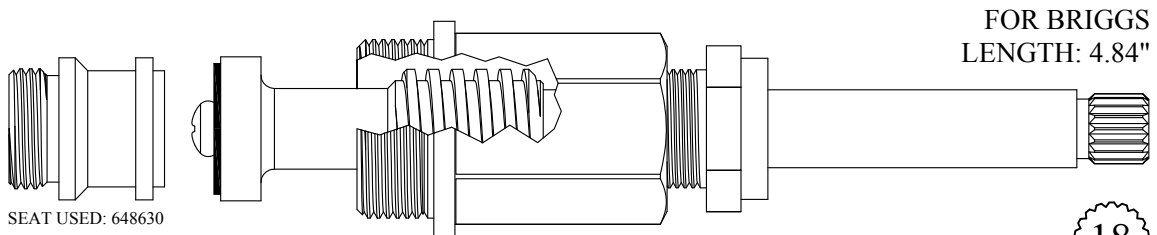

**411201**  
**211201** Stem Only  
 GASKET: 895370

**18**  
 3-3

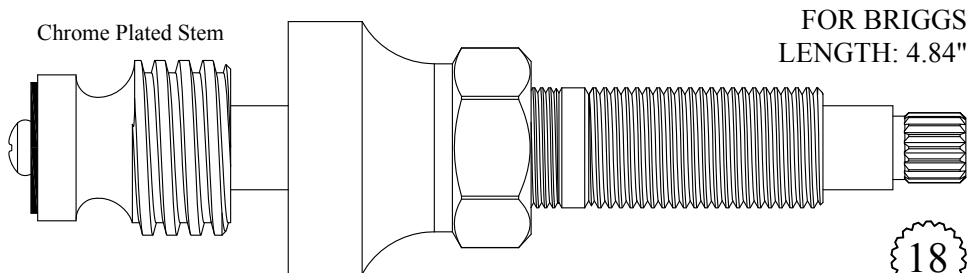

**412101**  
**210901** Stem Only

**18**  
 3-3

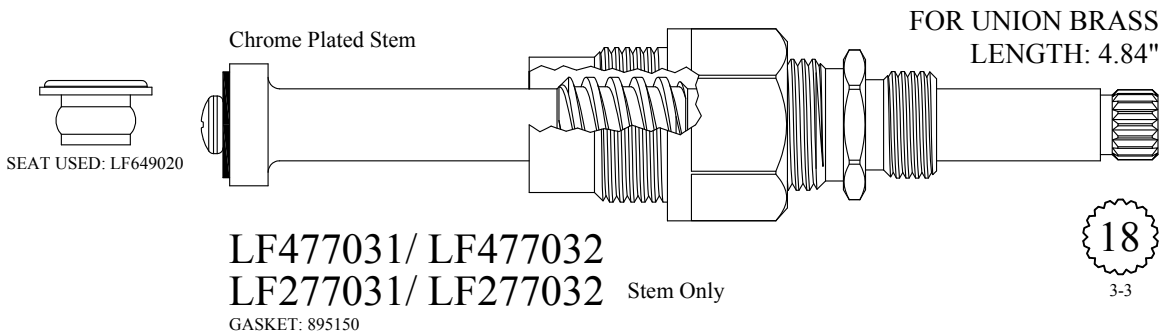
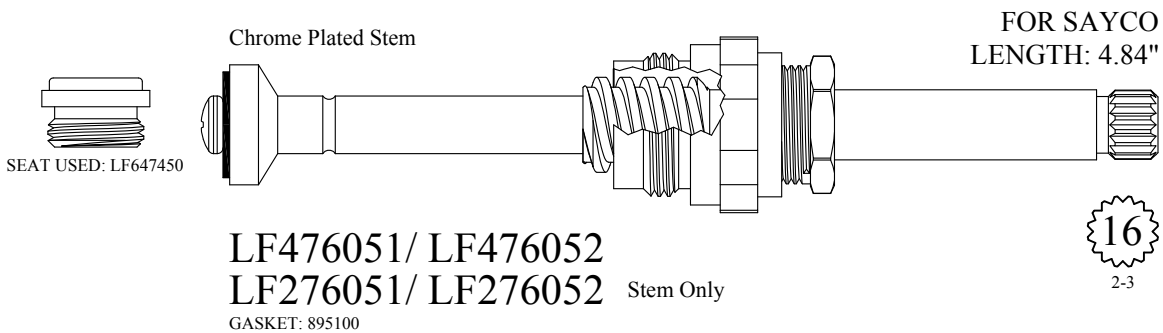
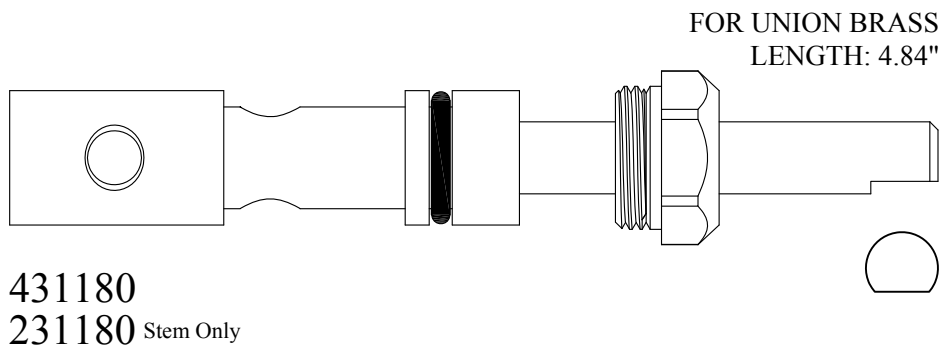
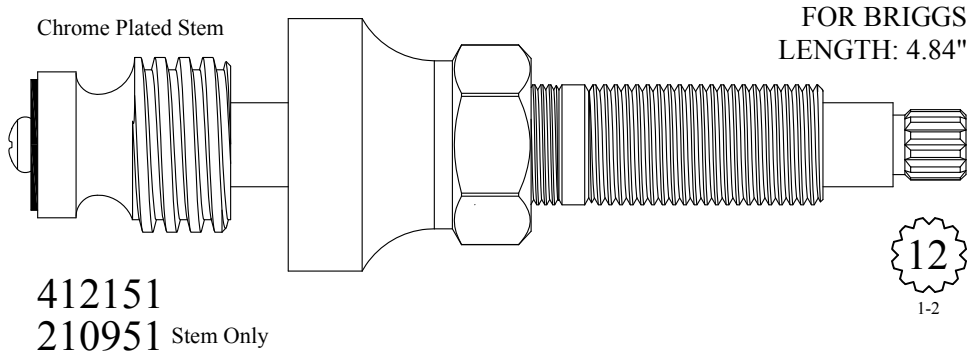



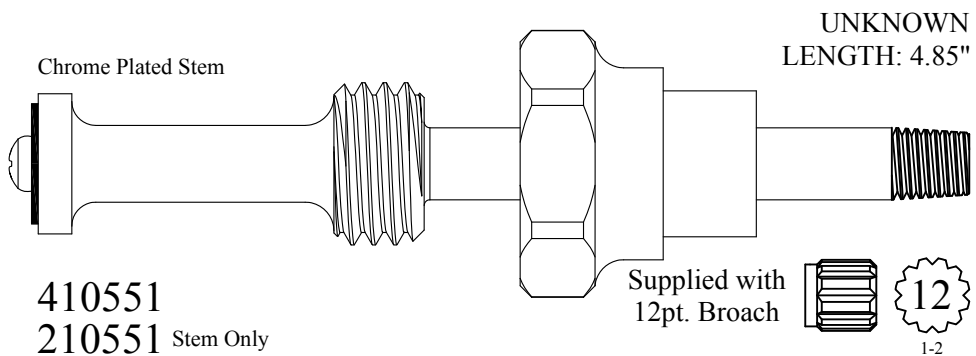
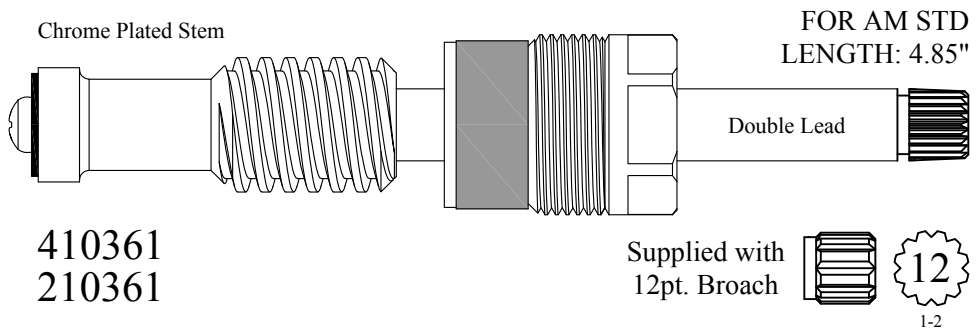
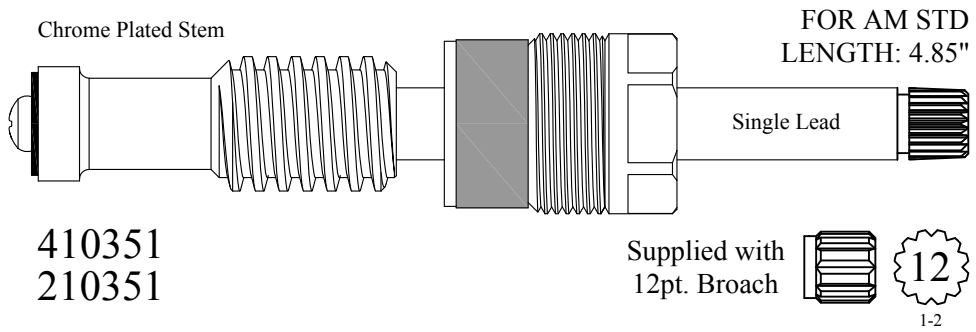
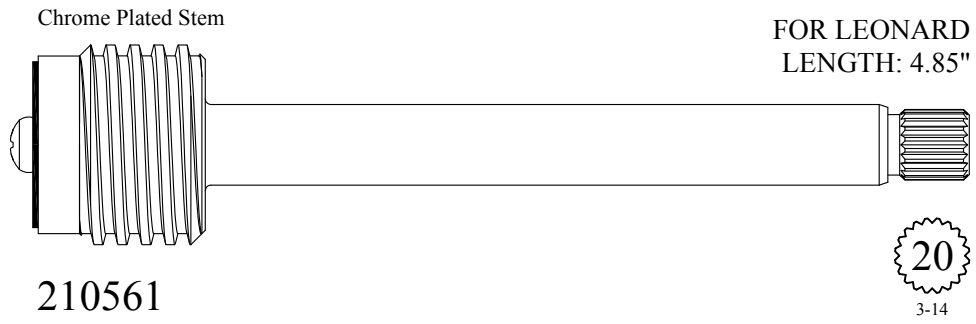

Comes with handle screw:  
# 899230

FOR KALLISTA  
LENGTH: 4.85"

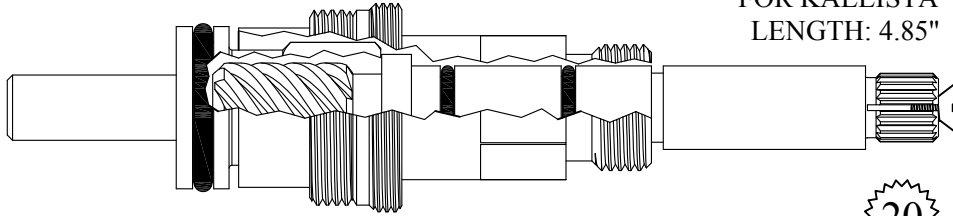

434201



FOR PRICE PFISTER  
LENGTH: 4.85"

Nickel Plated Stem



LF477201/ LF477202



FOR ACORN  
LENGTH: 4.86"

Stainless Steel Shank

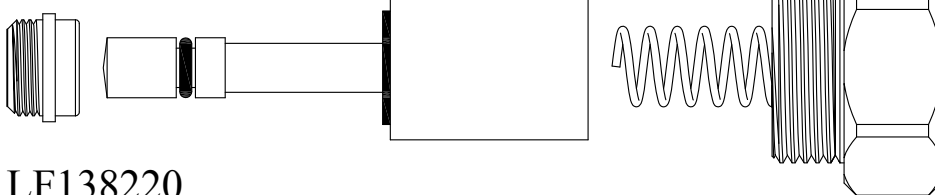

LF138220

GASKET INCLUDED: 895550  
SEAT INCLUDED: LF647560

FOR BRIGGS  
LENGTH: 4.86"

Chrome Plated Unit

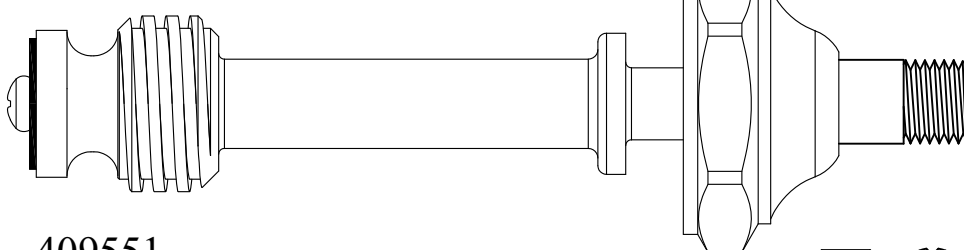

409551  
209551 Stem Only

Supplied with  
12pt. Broach

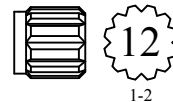

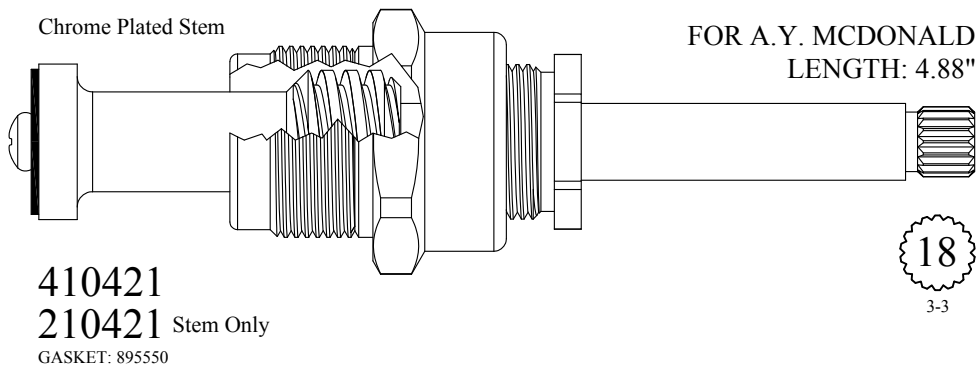
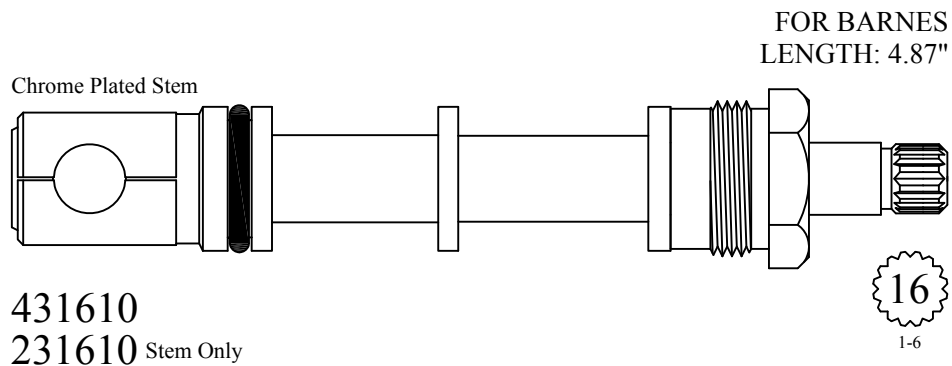
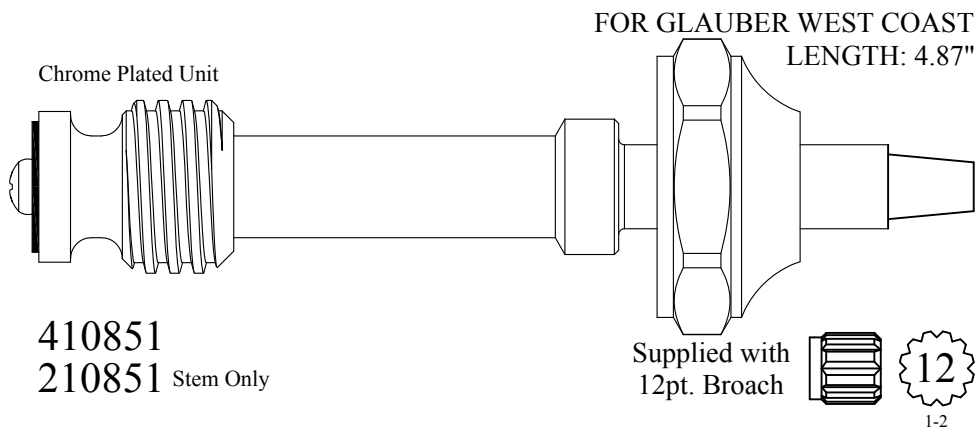
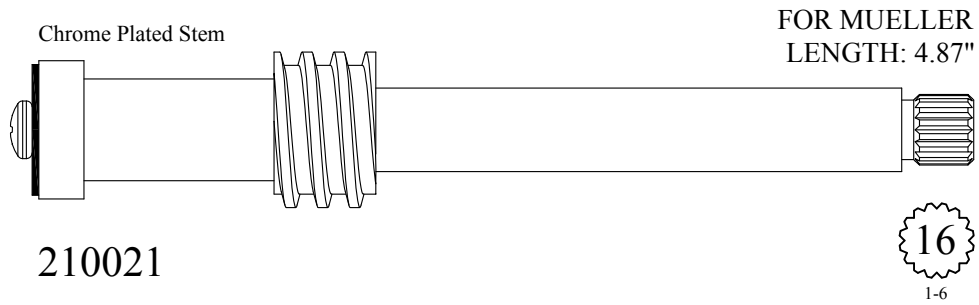

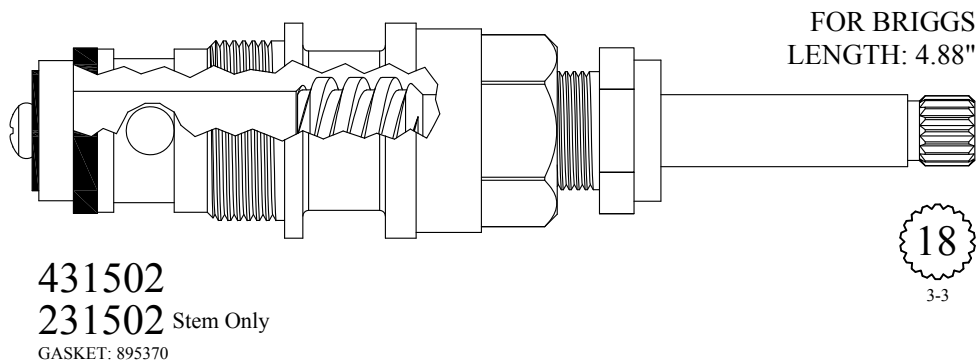
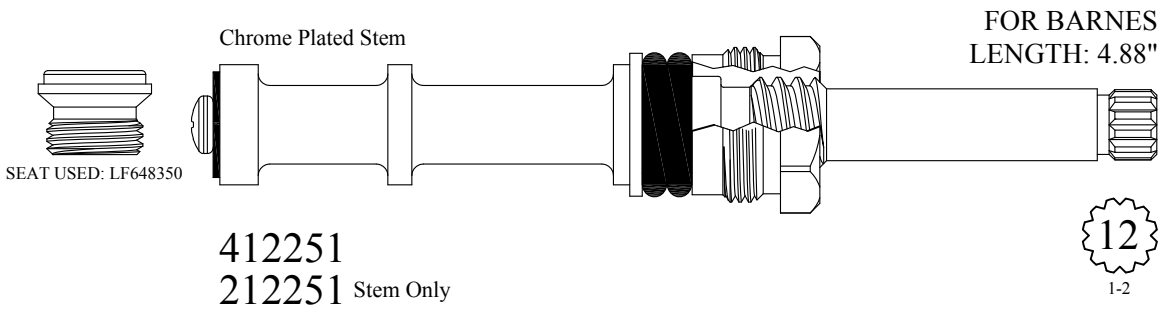
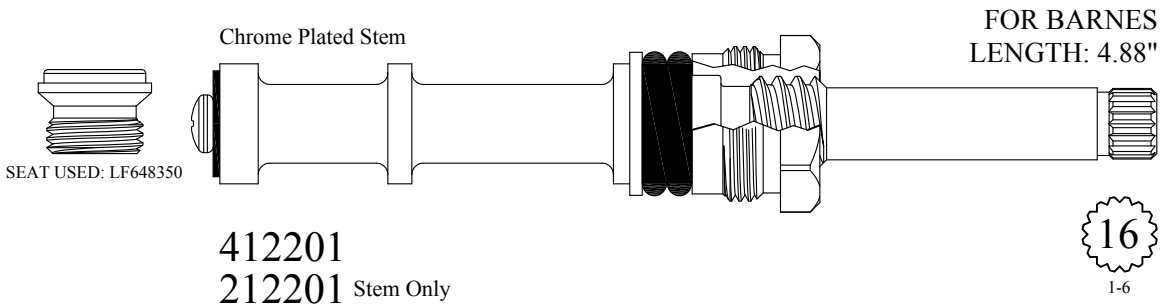
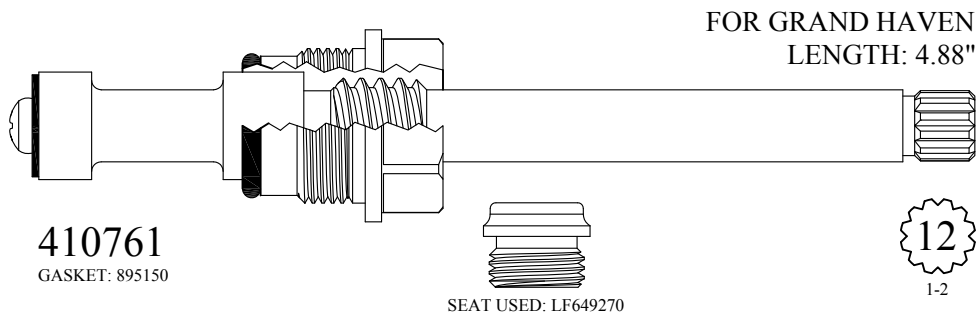

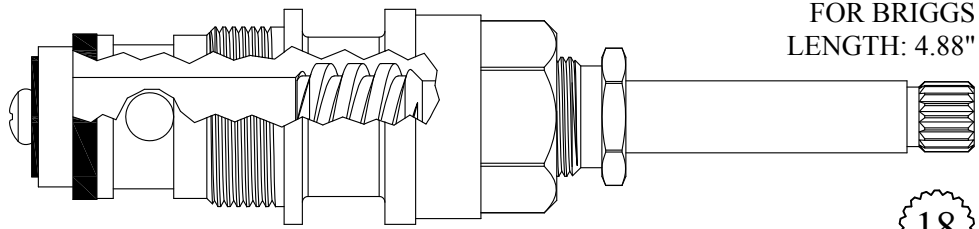

FOR BRIGGS  
LENGTH: 4.88"

18  
3-3

431512  
231502 Stem Only  
GASKET: 895370

FOR HOT & COLD STEM USE PRICE PFISTER 405111/405112

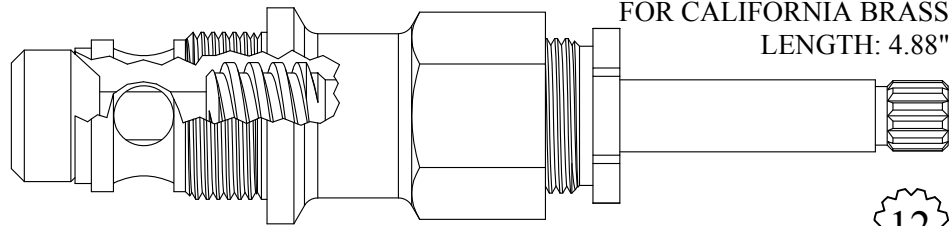

FOR CALIFORNIA BRASS  
LENGTH: 4.88"

12  
1-2

431701  
231701 Stem Only  
GASKET: 895400

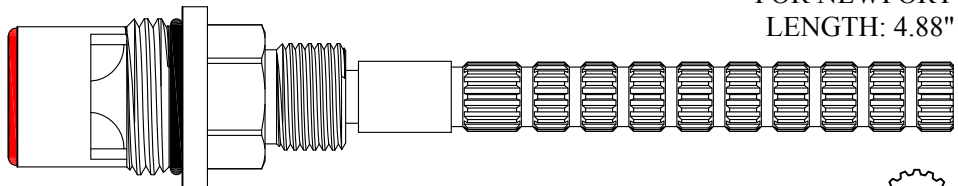

FOR NEWPORT  
LENGTH: 4.88"

16  
3-16

411221/ 411222  
GASKET: 890170 O-RING INCLUDED  
SEAL: 898570-R/B  
DISC SET: 151380-PKG

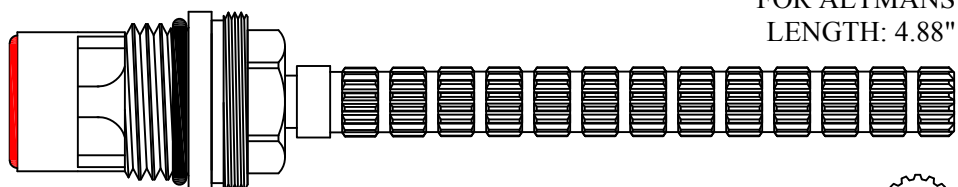

FOR ALTMANS  
LENGTH: 4.88"

16  
3-16

417311/ 417312  
GASKET: 890170 O-RING INCLUDED  
SEAL: 898570-R/B  
DISC SET: 151380-PKG

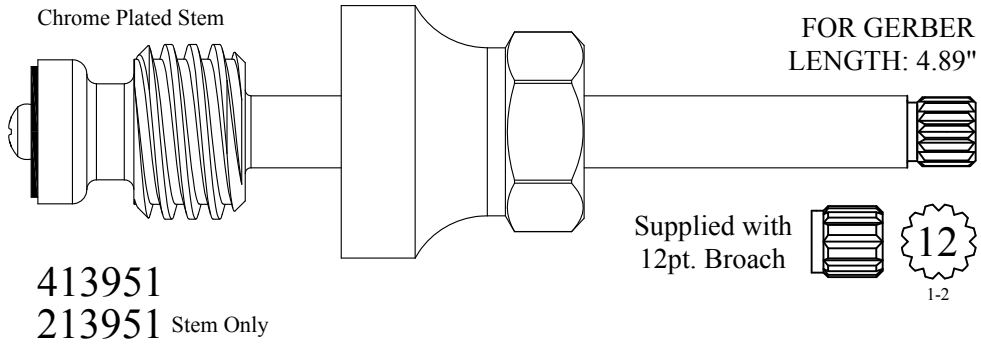

413951  
213951 Stem Only

Supplied with  
12pt. Broach  12  
1-2

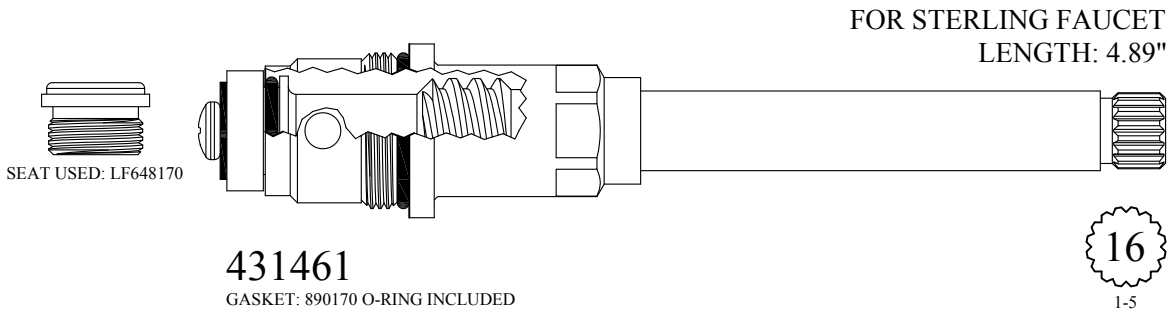

431461  
GASKET: 890170 O-RING INCLUDED

16  
1-5

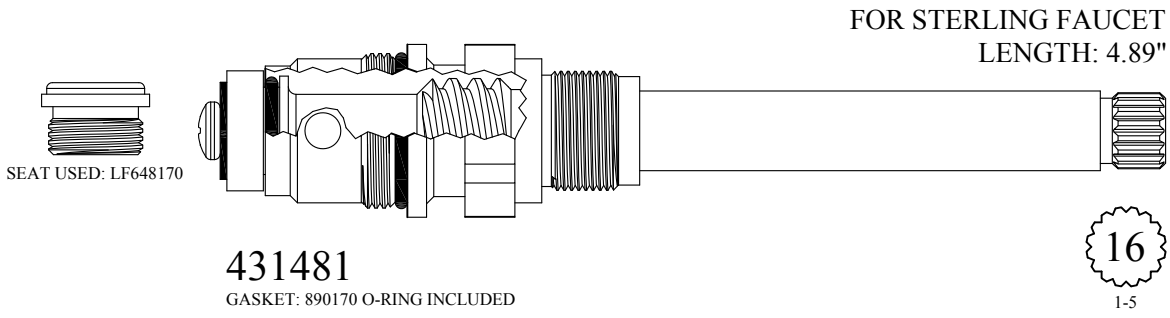

431481  
GASKET: 890170 O-RING INCLUDED

16  
1-5

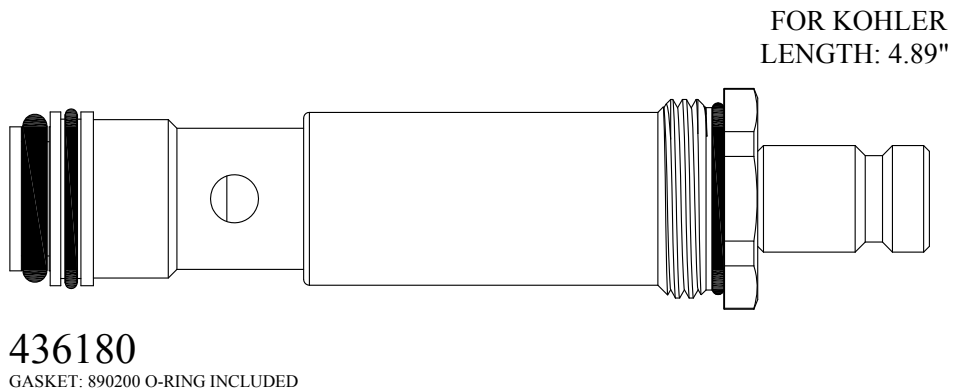

436180  
GASKET: 890200 O-RING INCLUDED



SEAT USED: LF649760

Chrome Plated Stem

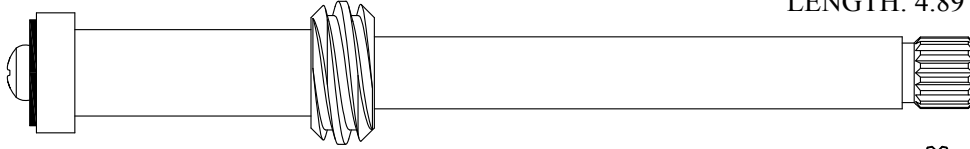

FOR DICK BROS.  
LENGTH: 4.89"

LF276311/ LF276312



231530



FOR BRADLEY  
LENGTH: 4.90"

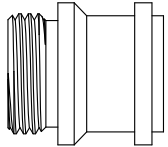

SEAT USED: 648630

Chrome Plated Stem

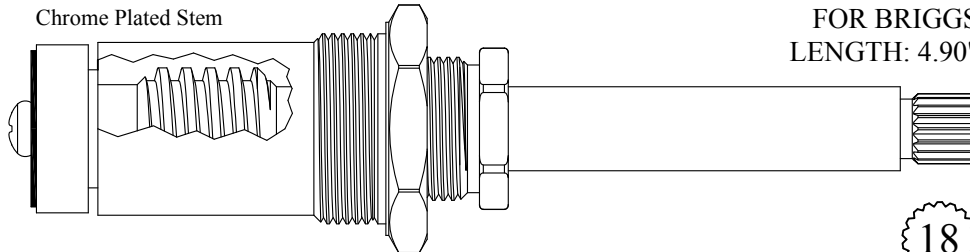

FOR BRIGGS  
LENGTH: 4.90"

411401  
211401 Stem Only  
GASKET: 895340

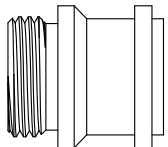

SEAT USED: 648630

Chrome Plated Stem

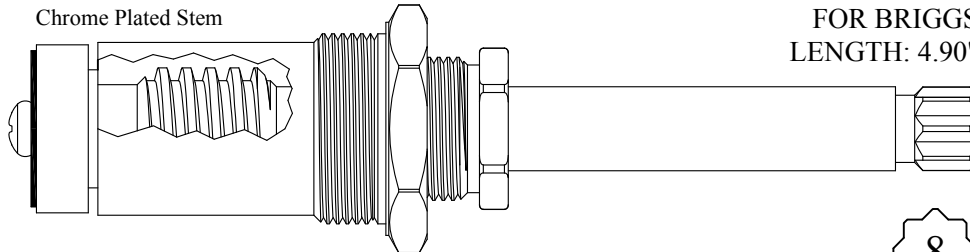

FOR BRIGGS  
LENGTH: 4.90"

411411  
211411 Stem Only  
GASKET: 895340



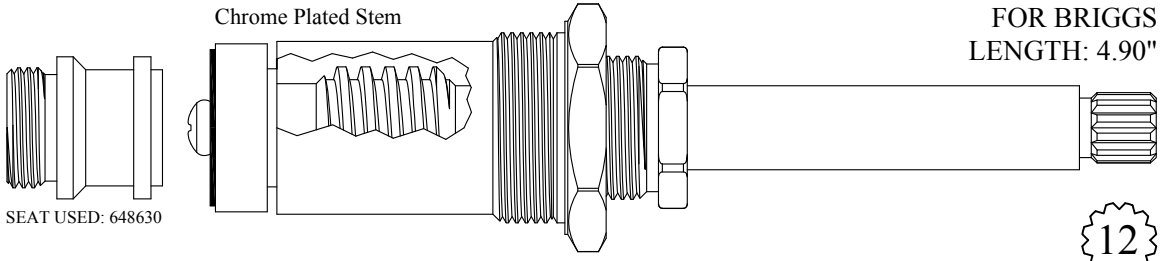

SEAT USED: 648630

Chrome Plated Stem

FOR BRIGGS  
LENGTH: 4.90"

**411451**  
**211451** Stem Only  
GASKET: 895340

12  
1-2

24 TPI Gland  
Chrome Plated Gland

FOR MICHIGAN BRASS  
LENGTH: 4.90"

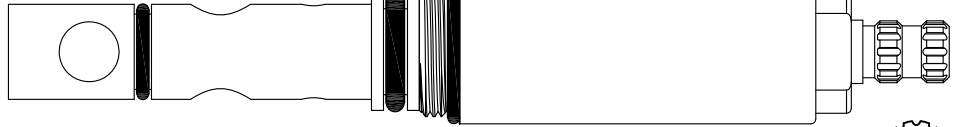

**431210**  
GASKET: 890160 O-RING INCLUDED

12  
3-5

20 TPI Gland  
Chrome Plated Gland

FOR WOLVERINE  
LENGTH: 4.90"

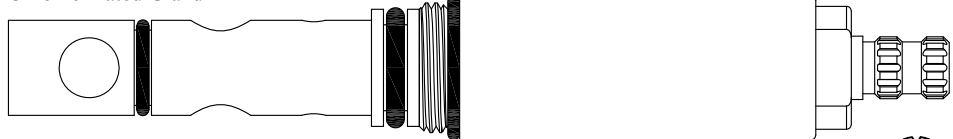

**431240**  
GASKET: 890160 O-RING INCLUDED

12  
3-5



SEAT USED: LF648550

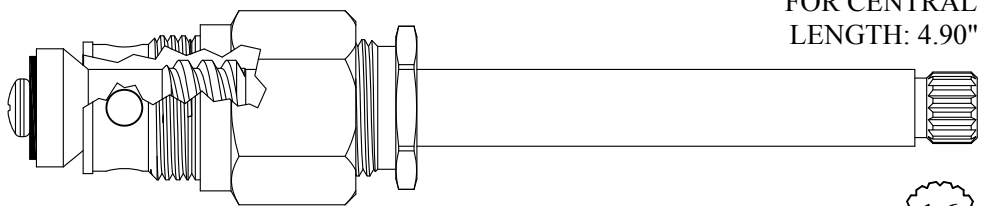

FOR CENTRAL  
LENGTH: 4.90"

**431921**  
**211011** Stem Only  
GASKET: 895100

16  
1-6



SEAT USED: LF648550

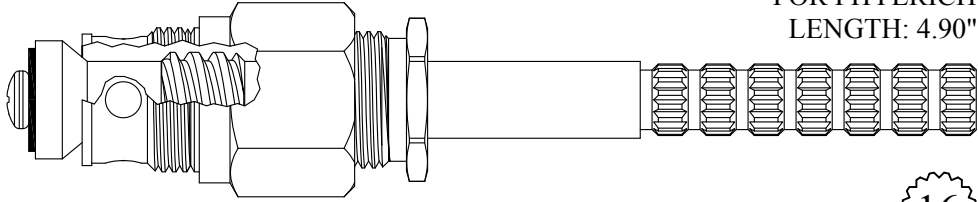

FOR PHYLRIK  
LENGTH: 4.90"

**431941**

GASKET: 895100



Chrome Plated Stem

CERAMIC CONVERSION FOR KOHLER 407001/2  
LENGTH: 4.90"

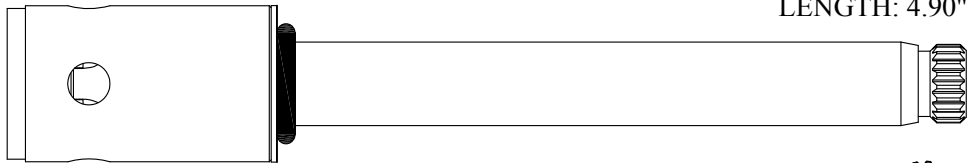

**407041/ 407042**

DISC SET: 151380-PKG

Also available with gold plated stem  
**407041-PG/ 407042-PG**

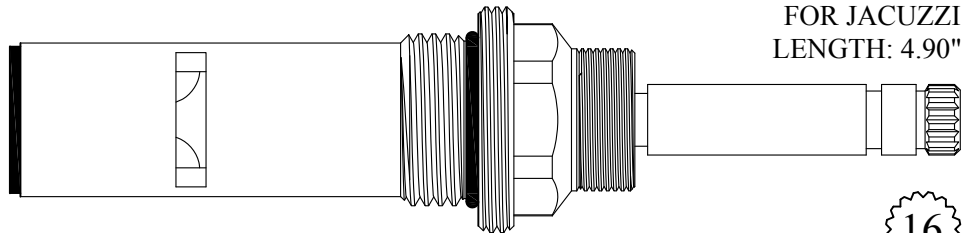

FOR JACUZZI  
LENGTH: 4.90"

**410921/ 410922**

GASKET: 890190 O-RING INCLUDED

SEAL: 898550

DISC SET: 151380-PKG



SEAT USED: LF648550

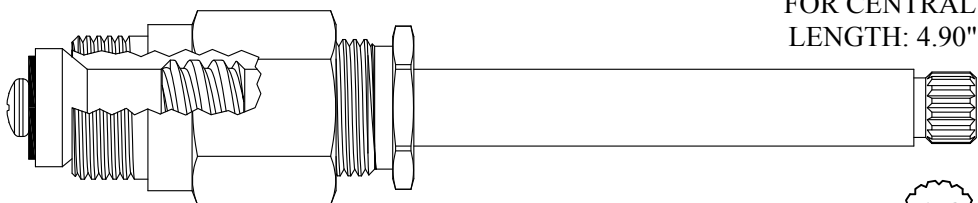

FOR CENTRAL  
LENGTH: 4.90"

**411011/ 411012**

**211011/ 211012** Stem Only

GASKET: 895100



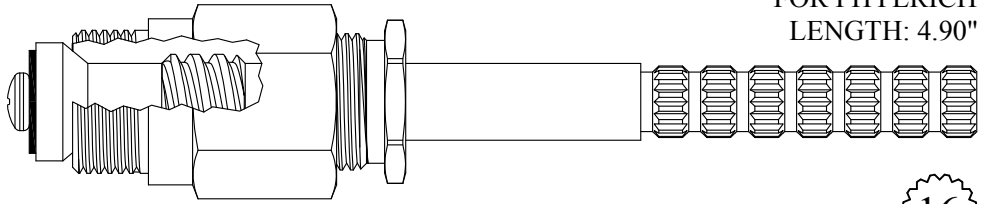

FOR PHYLRICH  
LENGTH: 4.90"

16  
1-6

411031/ 411032  
GASKET: 895100

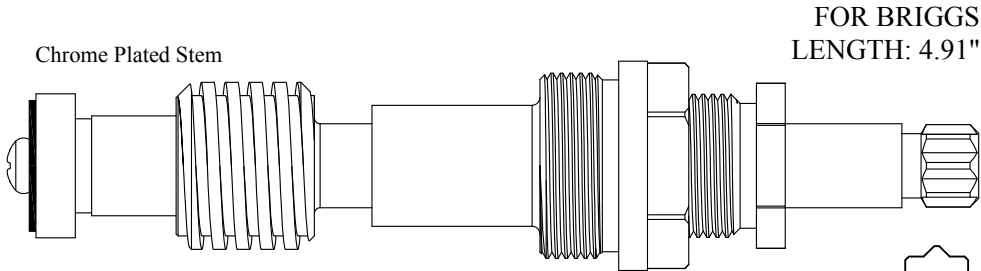

FOR BRIGGS  
LENGTH: 4.91"

8

411901  
211901 Stem Only  
GASKET: 895330

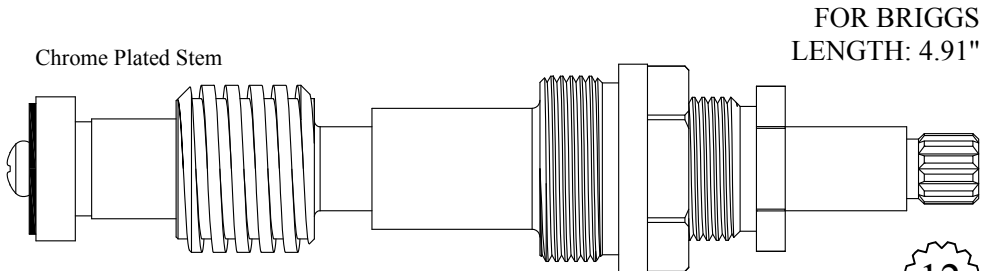

FOR BRIGGS  
LENGTH: 4.91"

12  
1-2

411951  
211951 Stem Only  
GASKET: 895330

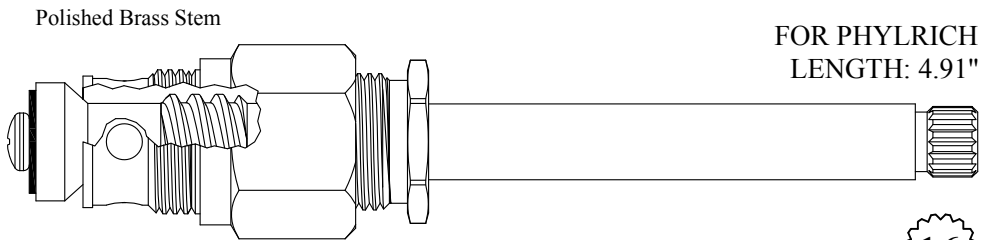

FOR PHYLRICH  
LENGTH: 4.91"

16  
1-6

431951  
GASKET: 895100

Also available with chrome plated stem  
431951-CP

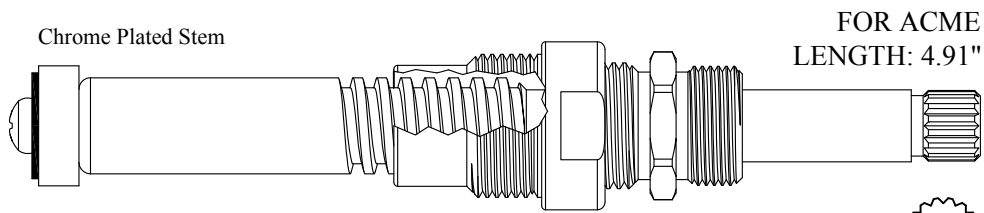

Chrome Plated Stem

FOR ACME  
LENGTH: 4.91"

**LF475001**  
**LF275001** Stem Only  
GASKET: 895100

16  
1-6

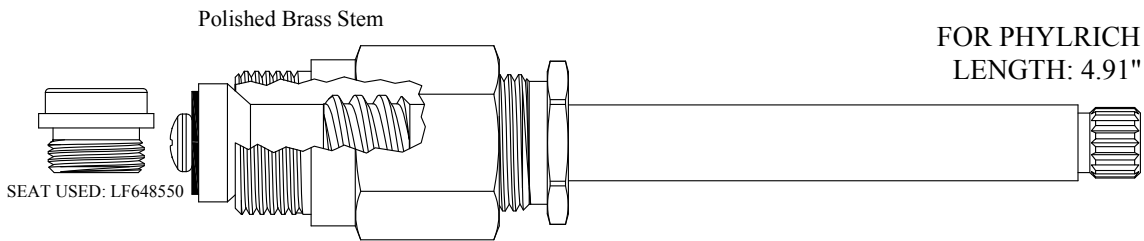

Polished Brass Stem

FOR PHYLRICH  
LENGTH: 4.91"

SEAT USED: LF648550

**411041/ 411042**  
**211041/ 211042** Stem Only  
GASKET: 895100

Also available with chrome plated stem  
**411041-CP/ 411042-CP**  
**211041-CP/ 211042-CP** Stem Only

16  
1-6

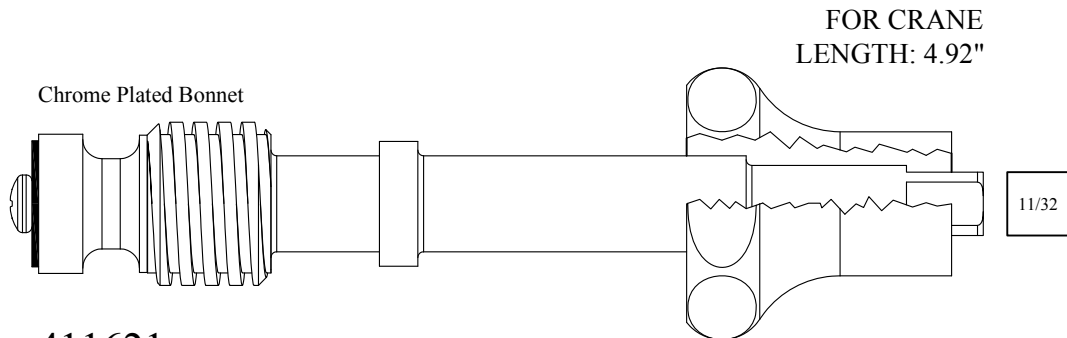

Chrome Plated Bonnet

FOR CRANE  
LENGTH: 4.92"

**411621**  
**211621** Stem Only

11/32

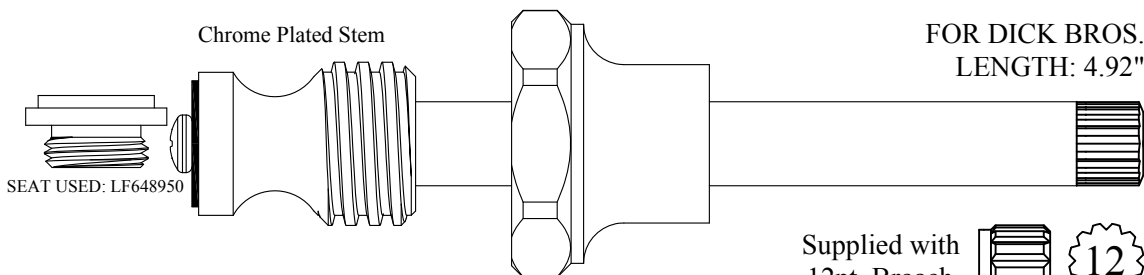

Chrome Plated Stem

FOR DICK BROS.  
LENGTH: 4.92"

SEAT USED: LF648950

**412051**  
**212051** Stem Only

Supplied with  
12pt. Broach

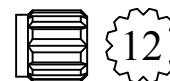

12  
1-2

SEAT USED: 647650

Chrome Plated Stem

FOR BRIGGS  
LENGTH: 4.92"

18

3-3

414201  
214201 Stem Only

SEAT USED: 647650

Chrome Plated Stem

FOR BRIGGS  
LENGTH: 4.92"

12

1-2

414251  
214251 Stem Only

SEAT USED: LF648930

Chrome Plated Stem

FOR SPEAKMAN  
LENGTH: 4.92"

20

2-4

LF475101/ LF475102  
LF275101/ LF275102 Stem Only

GASKET: 890180 O-RING INCLUDED

Chrome Plated Unit

FOR PUBCO  
LENGTH: 4.93"

Supplied with  
12pt. Broach

12

1-2

411151  
211151 Stem Only

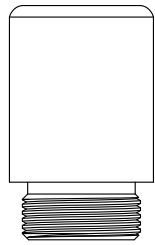

SEAT USED: 648920

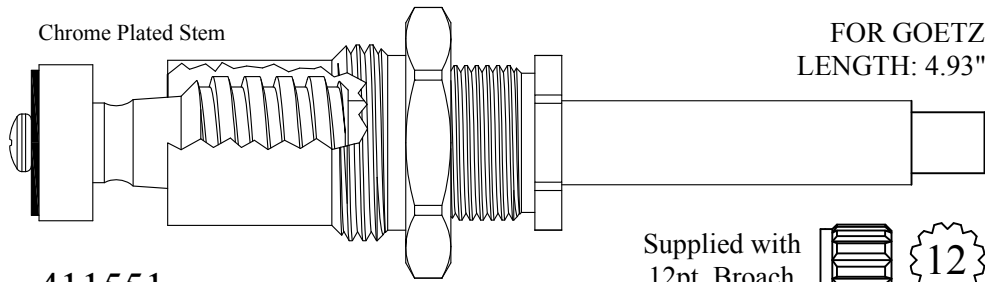

Chrome Plated Stem

FOR GOETZ  
LENGTH: 4.93"

**411551**  
**211551** Stem Only  
GASKET: 895560

Supplied with  
12pt. Broach



1-2

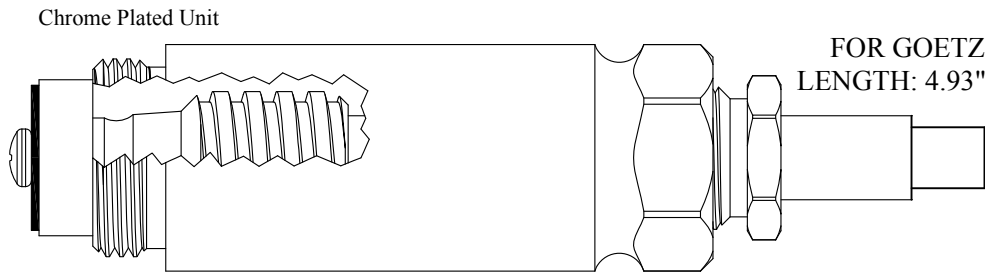

Chrome Plated Unit

FOR GOETZ  
LENGTH: 4.93"

**411561**  
**211551** Stem Only  
GASKET: 895560

Supplied with  
12pt. Broach



1-2

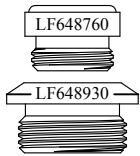

SEAT USED: LF648930  
or LF648760

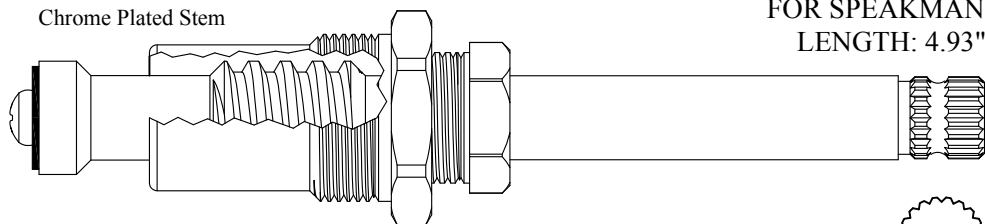

Chrome Plated Stem

FOR SPEAKMAN  
LENGTH: 4.93"

**411701**  
**211701** Stem Only  
GASKET: 895180



2-4

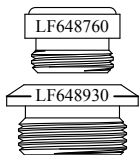

SEAT USED: LF648930  
or LF648760

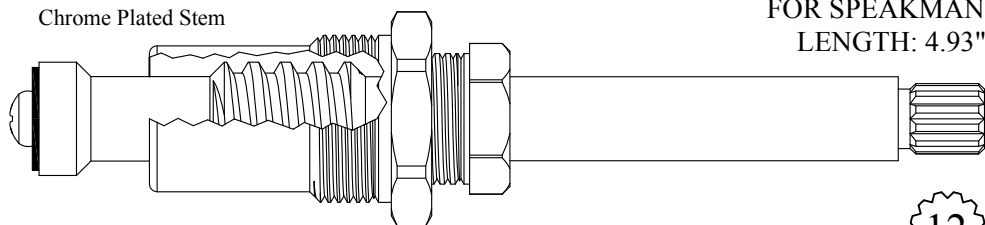

Chrome Plated Stem

FOR SPEAKMAN  
LENGTH: 4.93"

**411751**  
**211751** Stem Only  
GASKET: 895180



1-2

FOR STERLING FAUCET  
LENGTH: 4.93"

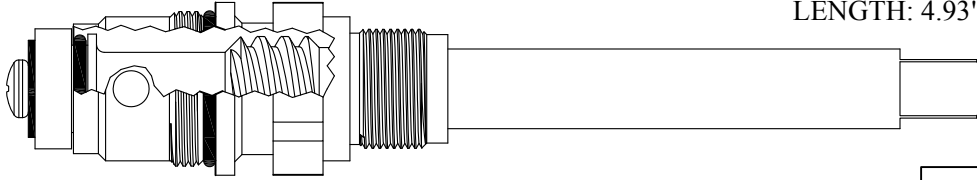

**431471**

GASKET: 890170 O-RING INCLUDED

5/16

FOR AM STD  
LENGTH: 4.93"

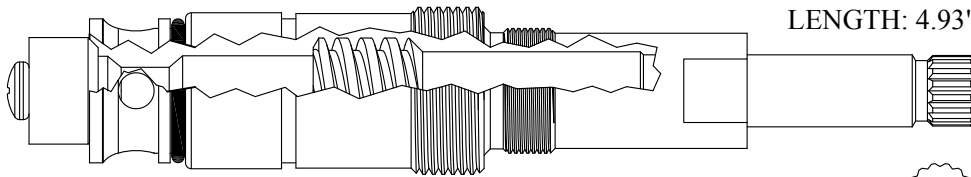

**431601**

INCLUDES WAVE WASHER: 897110

16

Chrome Plated Stem

FOR HARCRAFT  
LENGTH: 4.93"

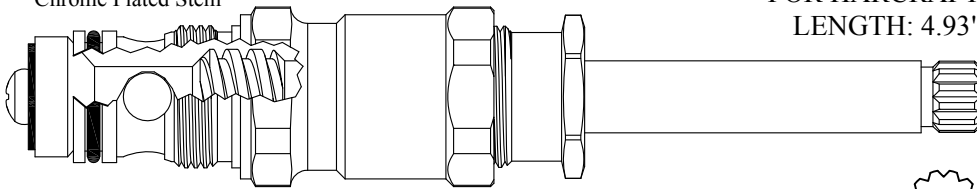

**431801**

**231801** Stem Only

GASKET: 895100

12  
1-2

Chrome Plated Stem

FOR HARCRAFT  
LENGTH: 4.93"

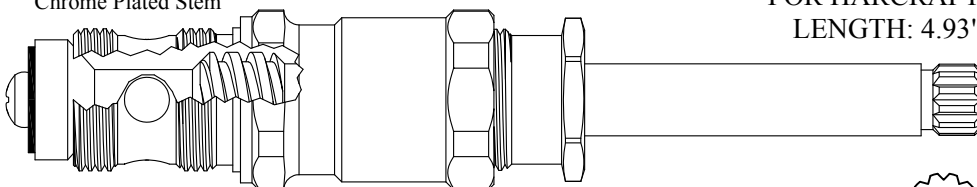

**431811**

**231801** Stem Only

GASKET: 895100

12  
1-2

SEAT USED: LF649430

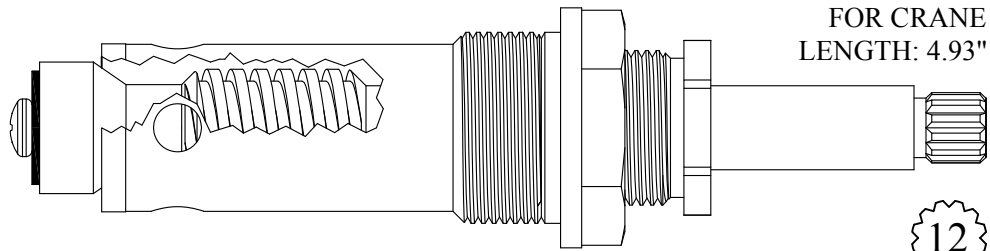

FOR CRANE  
LENGTH: 4.93"

12  
1-2

431901  
231901 Stem Only  
GASKET: 895550

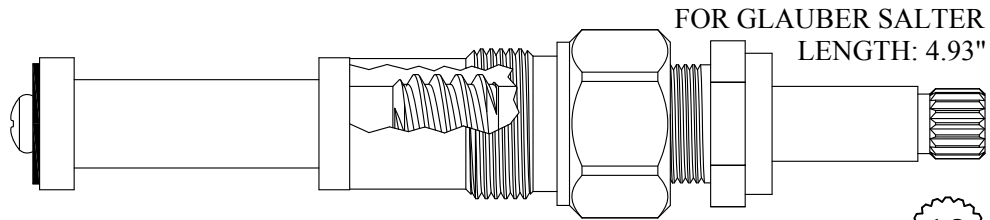

FOR GLAUBER SALTER  
LENGTH: 4.93"

18  
3-3

LF476501  
LF276501 Stem Only

Chrome Plated Unit

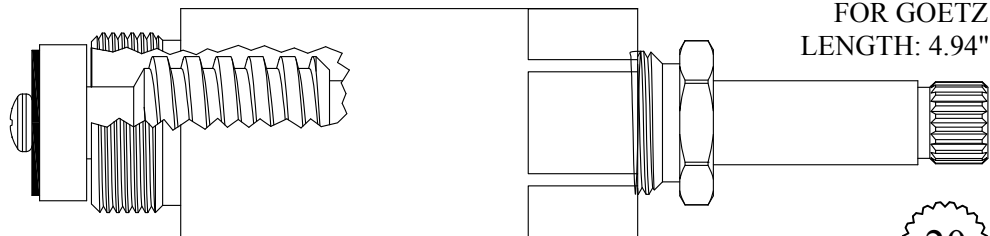

FOR GOETZ  
LENGTH: 4.94"

20  
2-4

412211  
212211 Stem Only  
GASKET: 895370

Chrome Plated Unit

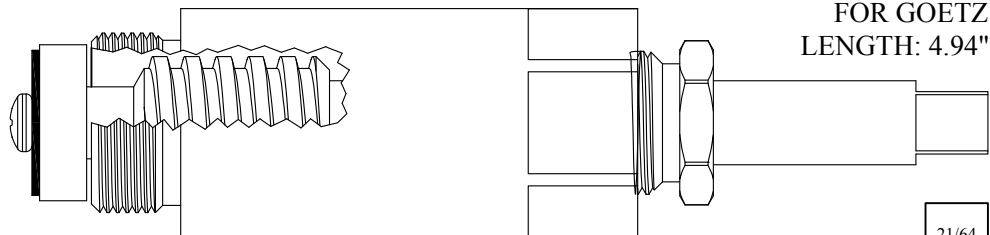

FOR GOETZ  
LENGTH: 4.94"

21/64

412221  
212221 Stem Only  
GASKET: 895370

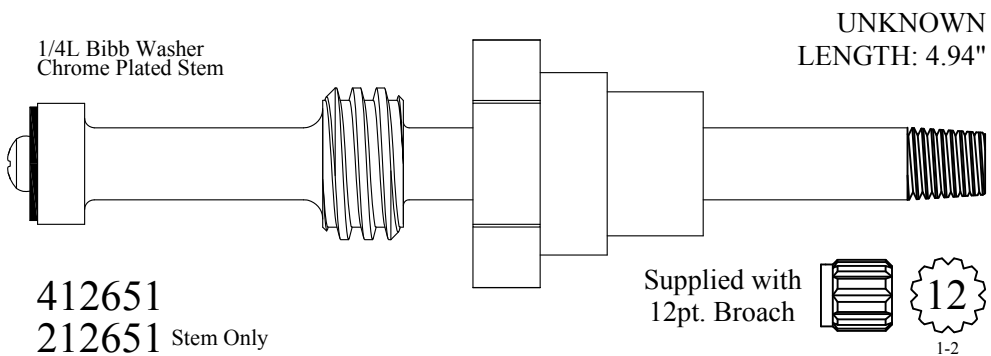
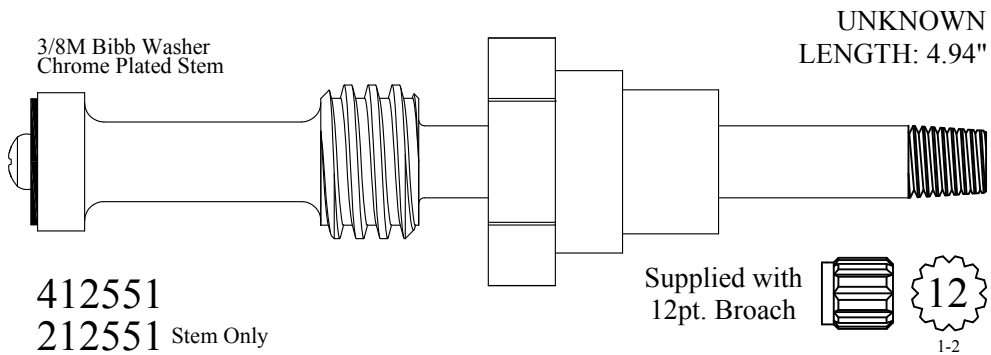
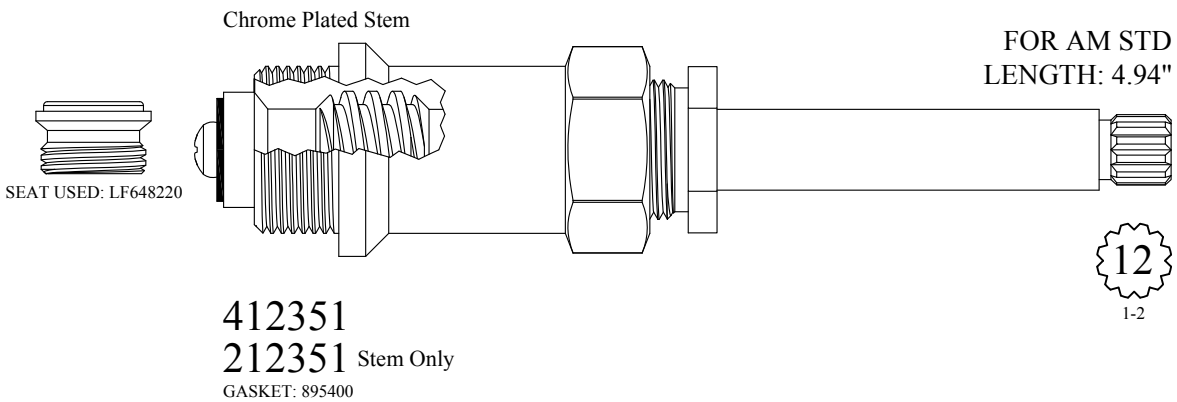
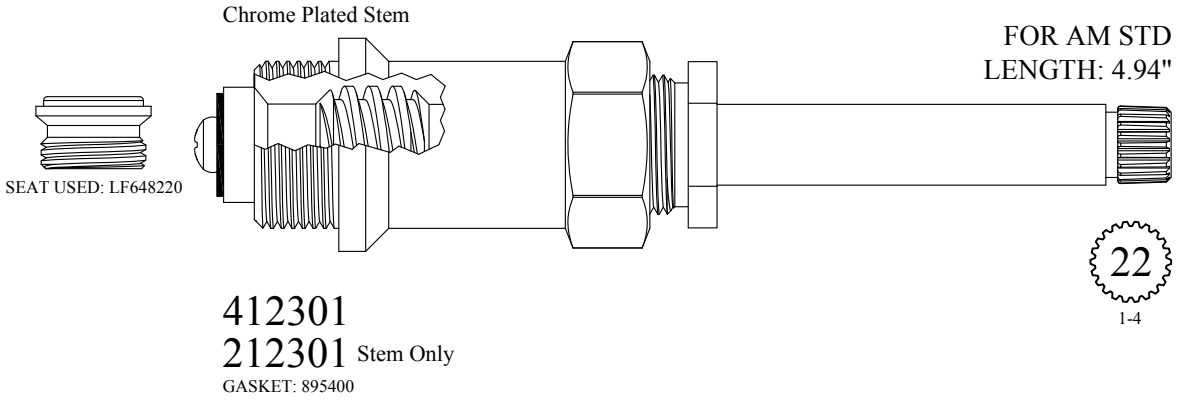





Chrome Plated Stem

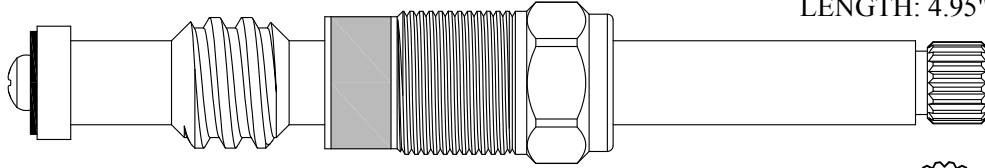

FOR SPEAKMAN  
LENGTH: 4.95"

412701  
212701 Stem Only



Chrome Plated Stem

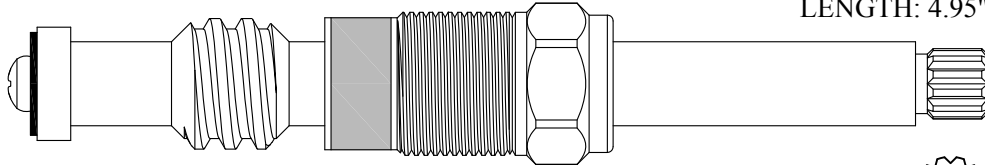

FOR SPEAKMAN  
LENGTH: 4.95"

412751  
212751 Stem Only

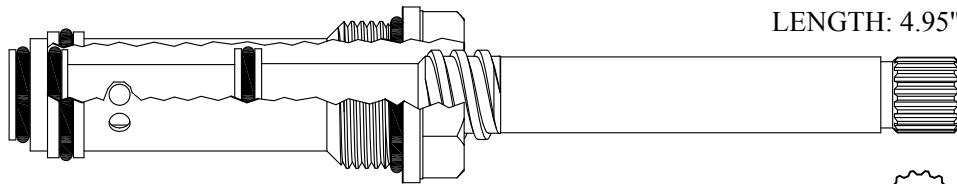

FOR PHOENIX  
FOR STREAMWAY  
LENGTH: 4.95"

431821  
GASKET: 890170 O-RING INCLUDED

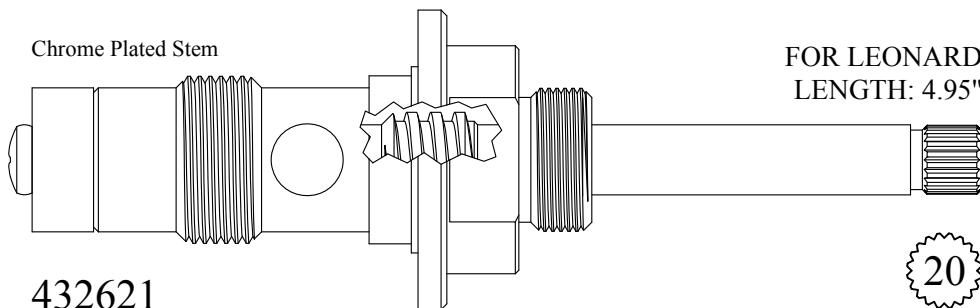

Chrome Plated Stem

FOR LEONARD  
LENGTH: 4.95"

432621  
GASKET: 895550





SEAT USED: 648970

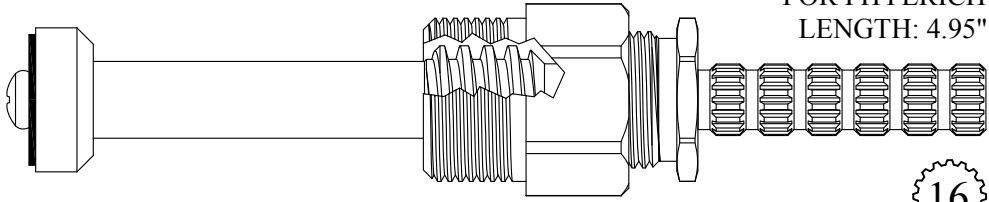

FOR PHYLRICH  
LENGTH: 4.95"

**415641/ 415642**

GASKET: 895400

16

3-16

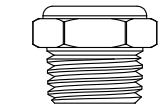

SEAT USED: LF648390

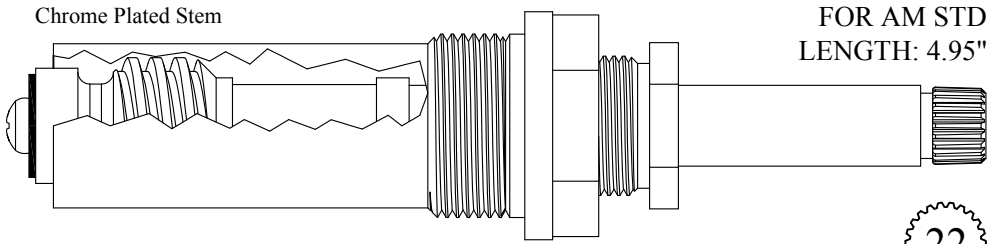

Chrome Plated Stem

FOR AM STD  
LENGTH: 4.95"

**LF478011/ LF478012**

**LF278011/ LF278012** Stem Only

22

1-4



SEAT USED: LF648130

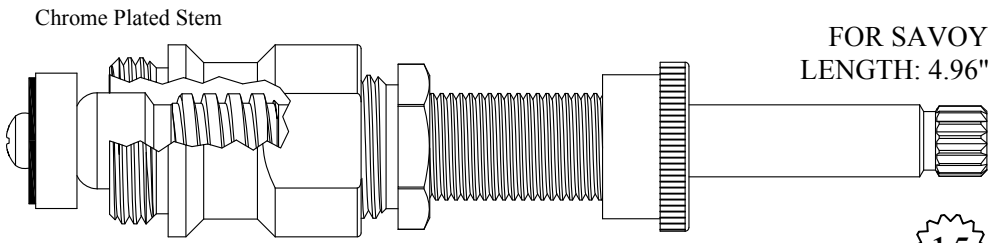

Chrome Plated Stem

FOR SAVOY  
LENGTH: 4.96"

**412711**

**212801** Stem Only

GASKET: 895400

15

1-13



SEAT USED: LF648130

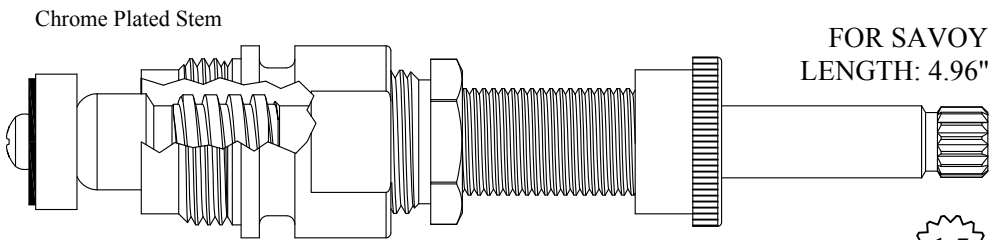

Chrome Plated Stem

FOR SAVOY  
LENGTH: 4.96"

**412721**

**212801** Stem Only

GASKET: 895400

15

1-13

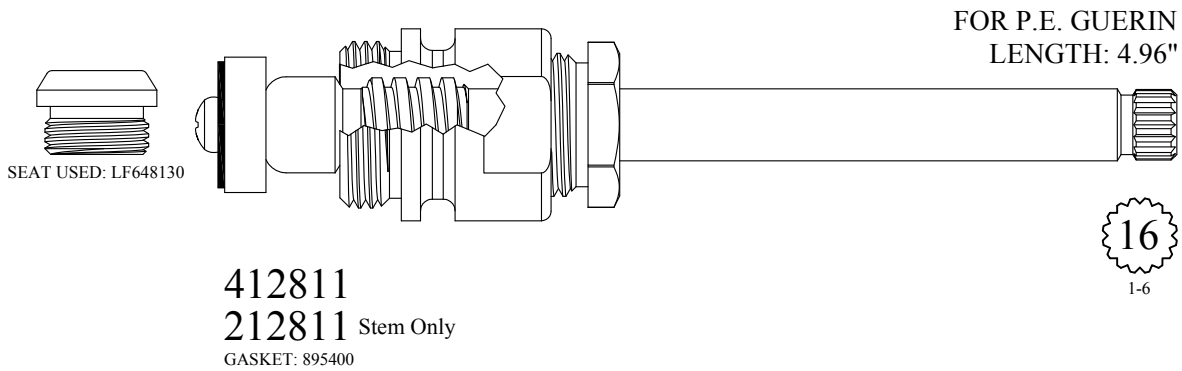
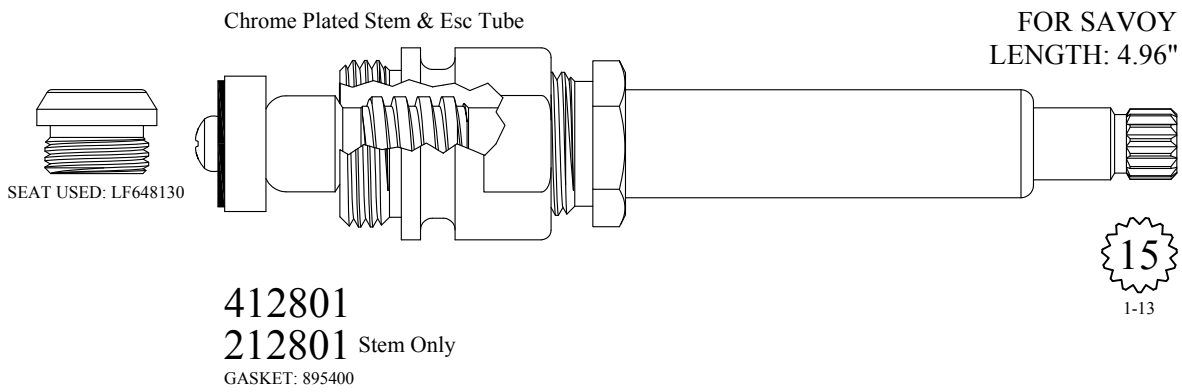
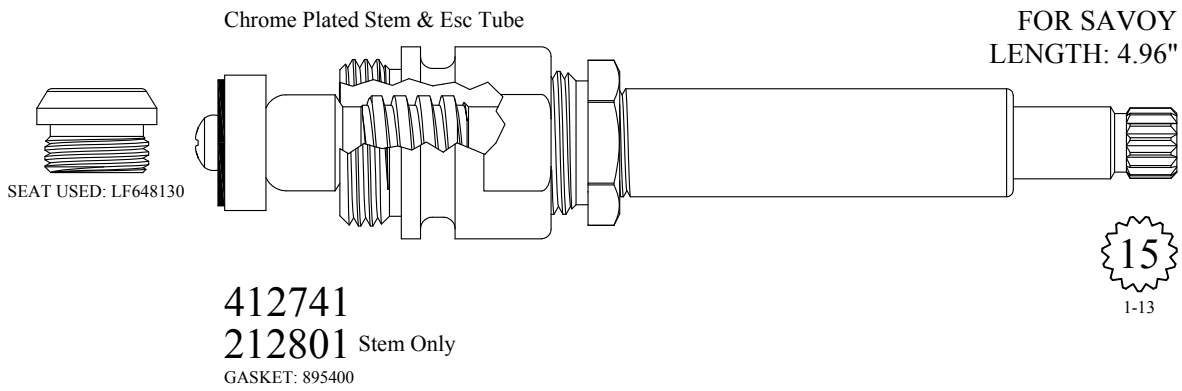
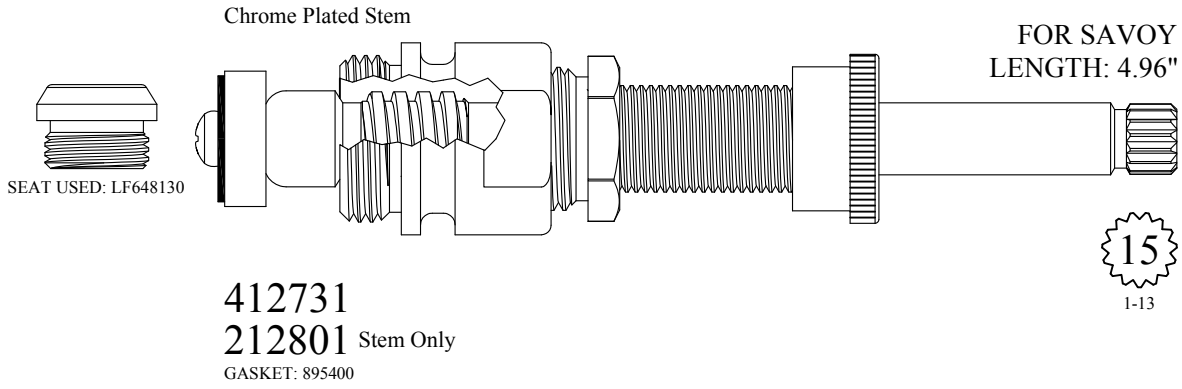

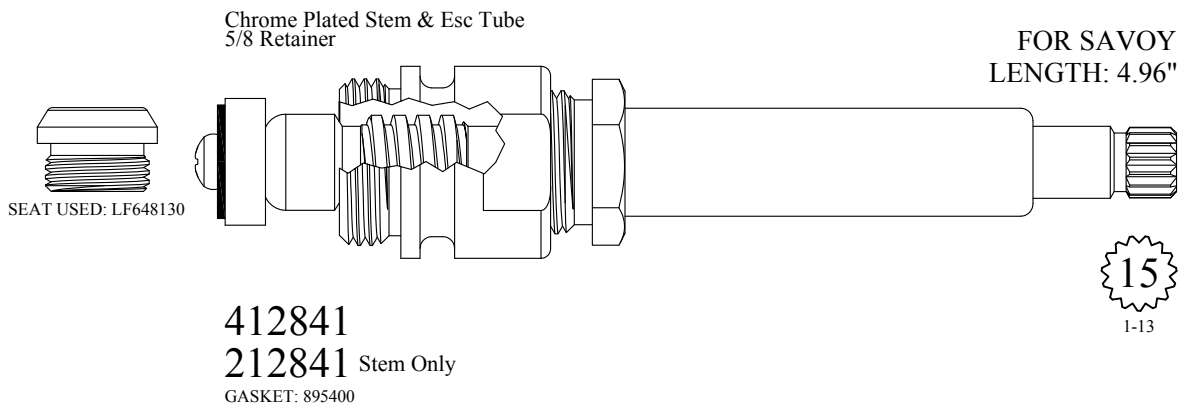
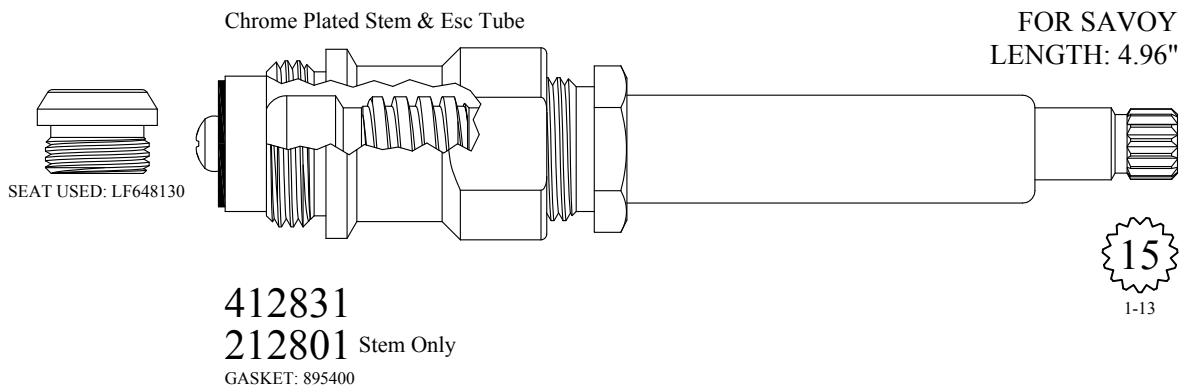
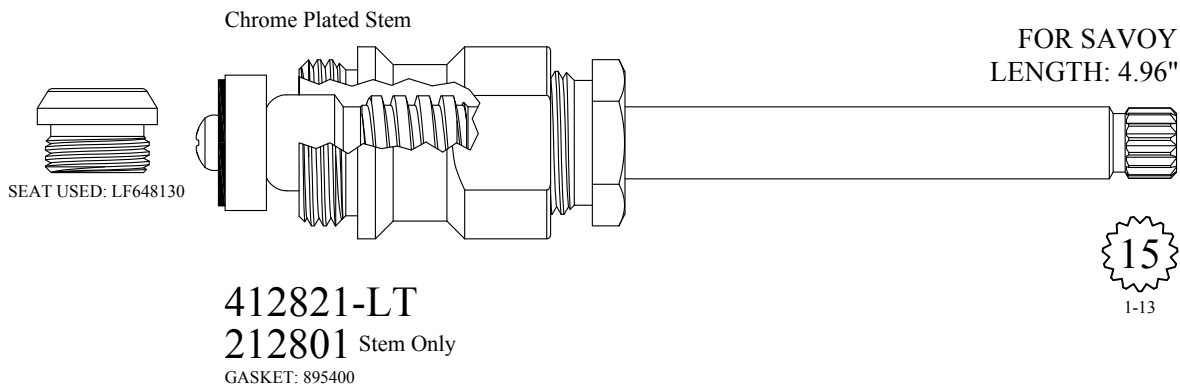
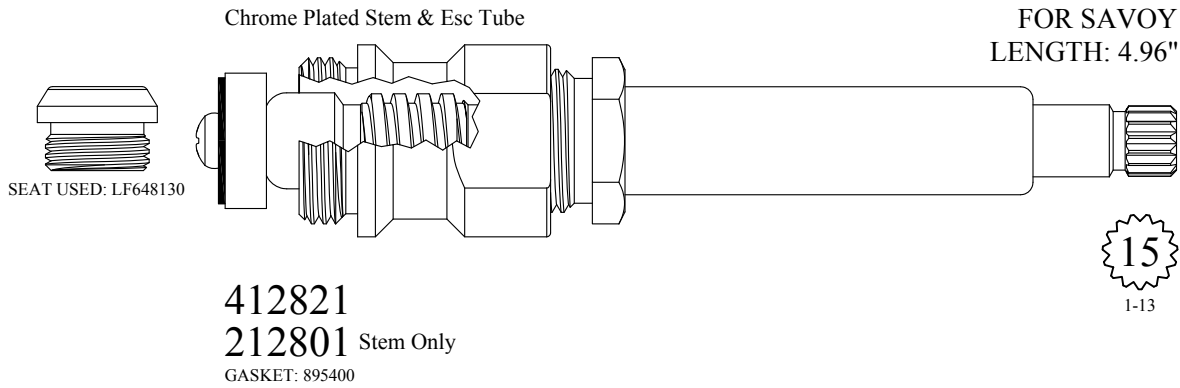

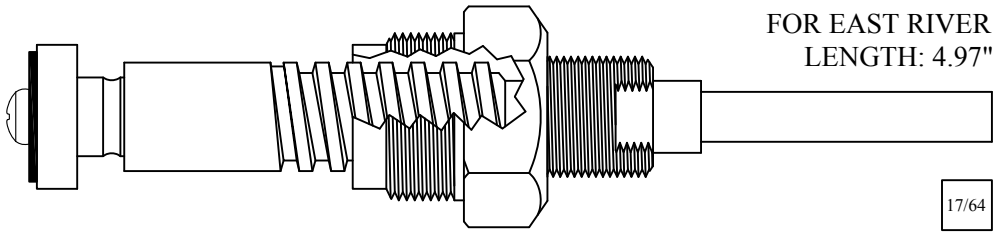

**413111**  
**213111** Stem Only  
 GASKET: 895150

17/64

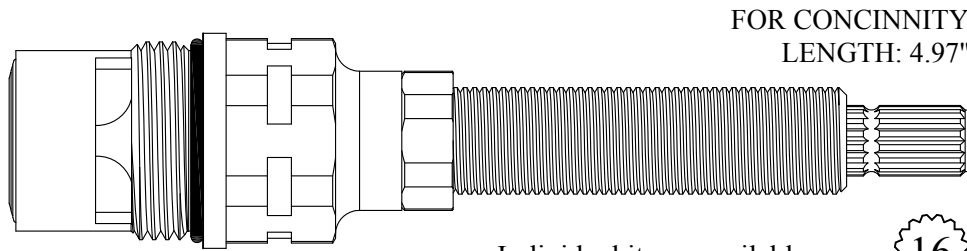

**412031/ 412032**  
 GASKET: 890210 O-RING INCLUDED  
 SEAL: 898520  
 DISC SET: 109850-PKG

Individual items available  
 Stem Ext. 3-1/4": #102960  
 Ext. Adap. Screw: #103310

16  
 1-6

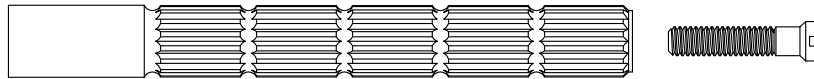

Polished Brass Stem Extension

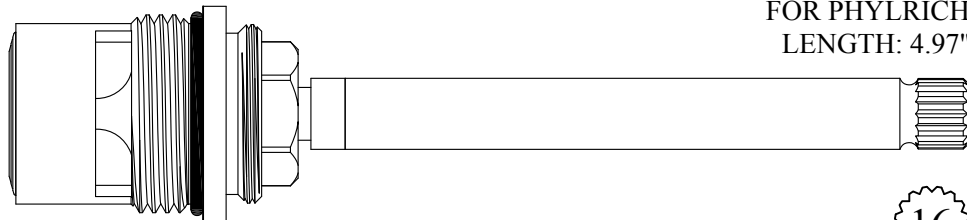

**412041/ 412042**  
 GASKET: 890210 O-RING INCLUDED  
 SEAL: 898520  
 DISC SET: 109850-PKG

Also available with chrome plated stem  
**412041-CP/ 412042-CP**

16  
 1-6

Individual items available  
 Stem Ext. 3.25": #132150  
 & 132150-CP  
 Ext. Adap. Screw: #103310

Chrome Plated Stem & Esc Tube

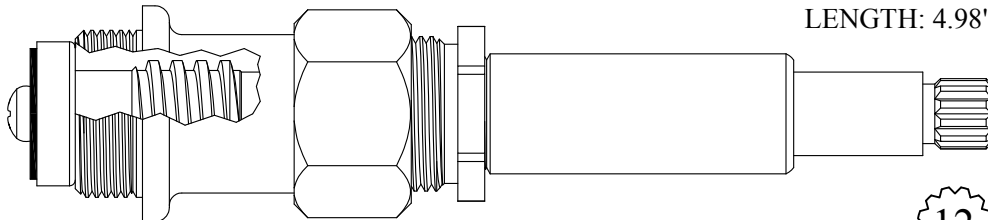

**412901**  
 GASKET: 895400

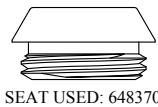

SEAT USED: 648370

12  
 1-2

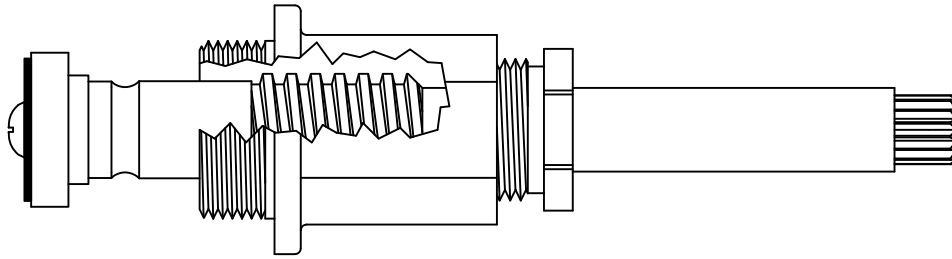

Old Style, Use 413601

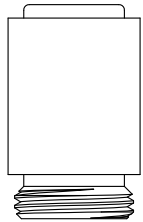

SEAT USED: LF649140

Chrome Plated Stem

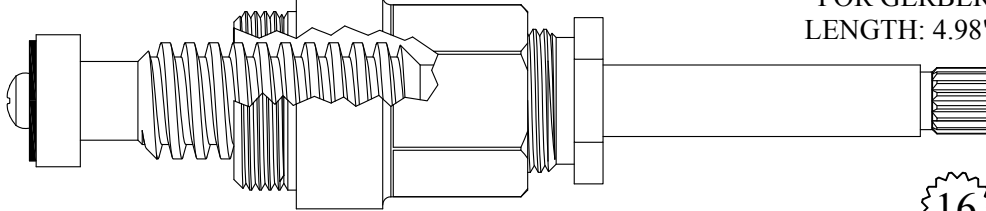

FOR GERBER  
LENGTH: 4.98"

16  
2-3

413601  
213601 Stem Only  
GASKET: 895370

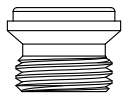

SEAT USED: LF648350

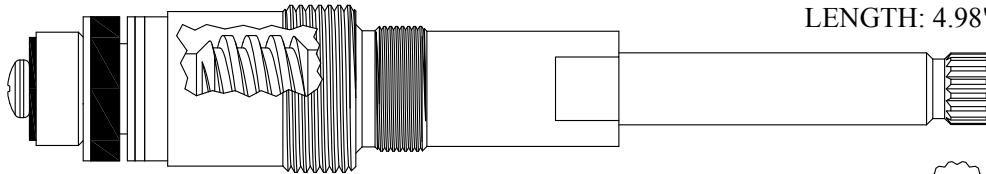

FOR AM STD  
LENGTH: 4.98"

16

414401/ 414402  
214401/ 214402 Stem Only  
WAVE WASHER: 897110

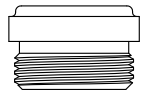

SEAT USED: 648970

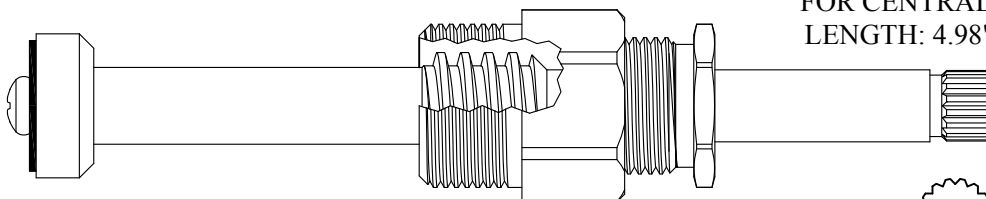

FOR CENTRAL  
LENGTH: 4.98"

16  
1-6

415541/ 415542  
215541/ 215542 Stem Only  
GASKET: 895400

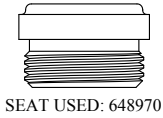

SEAT USED: 648970

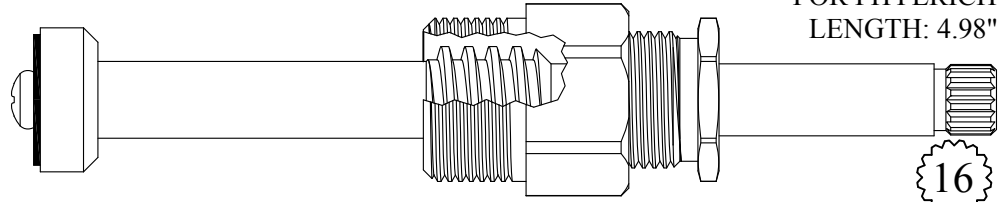

FOR PHYLRICH  
LENGTH: 4.98"

16  
1-6

415541-CP/ 415542-CP  
215541-CP/ 215542-CP Stem Only  
GASKET: 895400

Also available with Polished Brass stem  
415541-PB/ 415542-PB  
215541-PB/ 215542-PB Stem Only

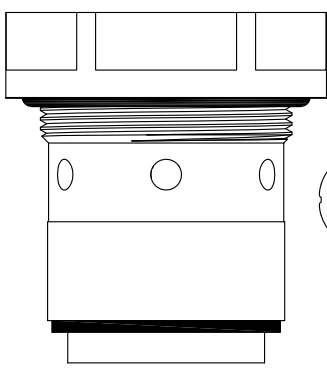

SEAT USED: 647640

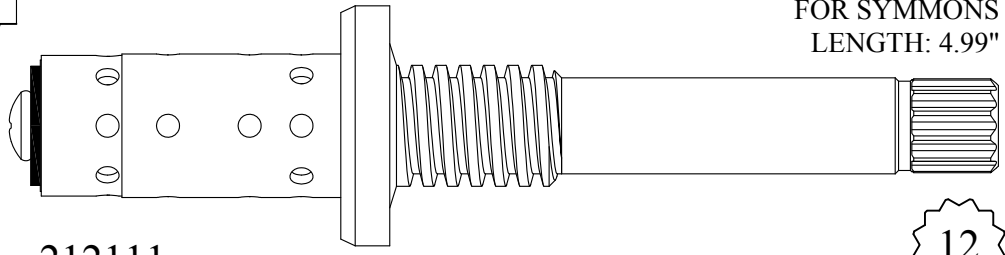

FOR SYMMONS  
LENGTH: 4.99"

12  
Symmons Large

212111  
GASKET: 895490 INCLUDED

Chrome Plated Stem

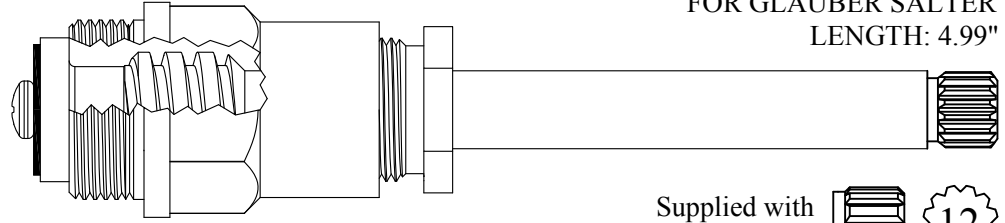

FOR GLAUBER SALTER  
LENGTH: 4.99"

Supplied with  
12pt. Broach  12  
1-2

412451  
212451 Stem Only  
GASKET: 895370

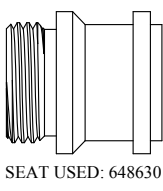

SEAT USED: 648630

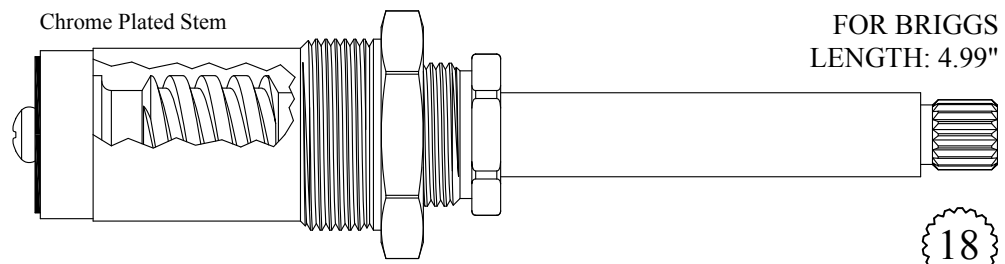

FOR BRIGGS  
LENGTH: 4.99"

18  
3-3

413001/ 413002  
213001/ 213002 Stem Only  
GASKET: 895340

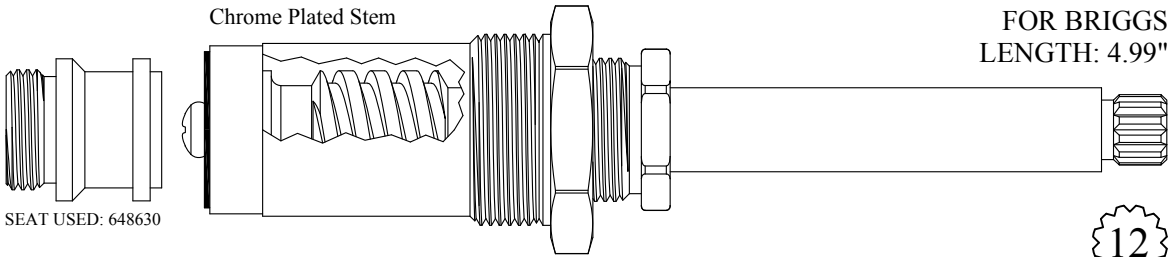

SEAT USED: 648630

Chrome Plated Stem

FOR BRIGGS  
LENGTH: 4.99"

413051/ 413052  
213051/ 213052 Stem Only

12  
1-2

GASKET: 895340

Chrome Plated Stem

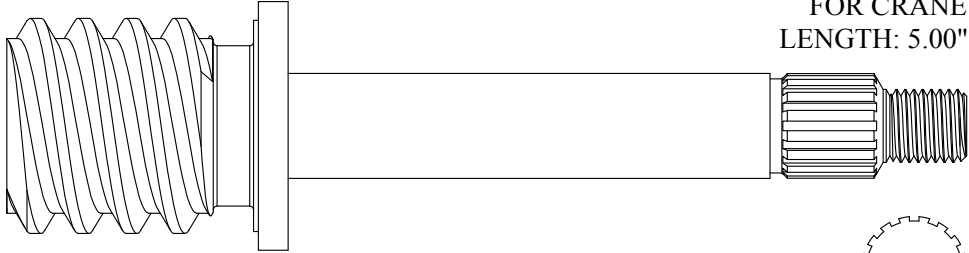

FOR CRANE  
LENGTH: 5.00"

212581

16

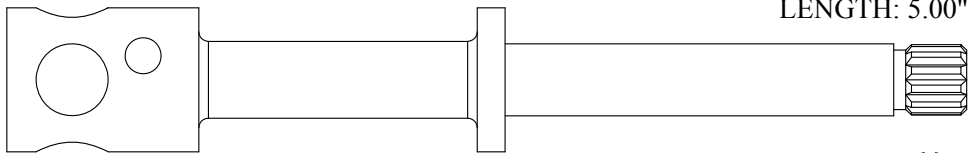

FOR GRAND HAVEN  
LENGTH: 5.00"

232220

12  
1-2

Chrome Plated Stem

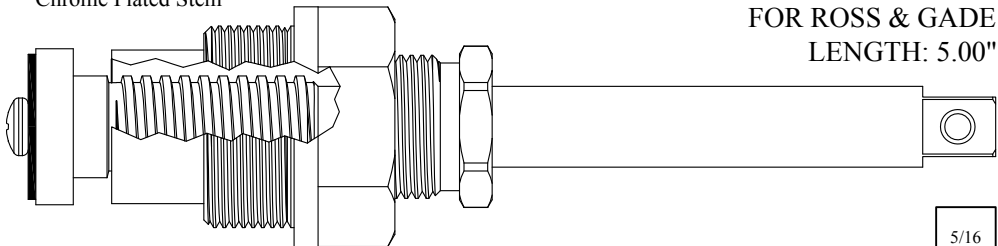

FOR ROSS & GADE  
LENGTH: 5.00"

412241  
212241 Stem Only

GASKET: 895430

5/16

Chrome Plated Unit

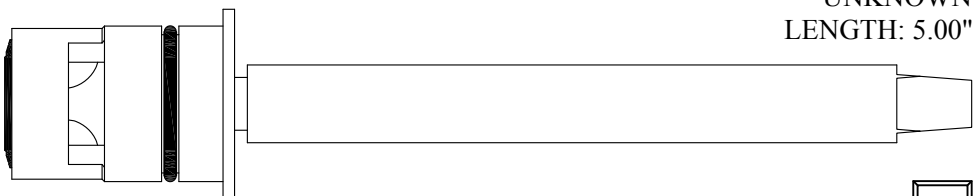

UNKNOWN  
LENGTH: 5.00"

412641/ 412642

SEAL: 898510  
DISC SET: 151380-PKG

5/16  
TAPERED



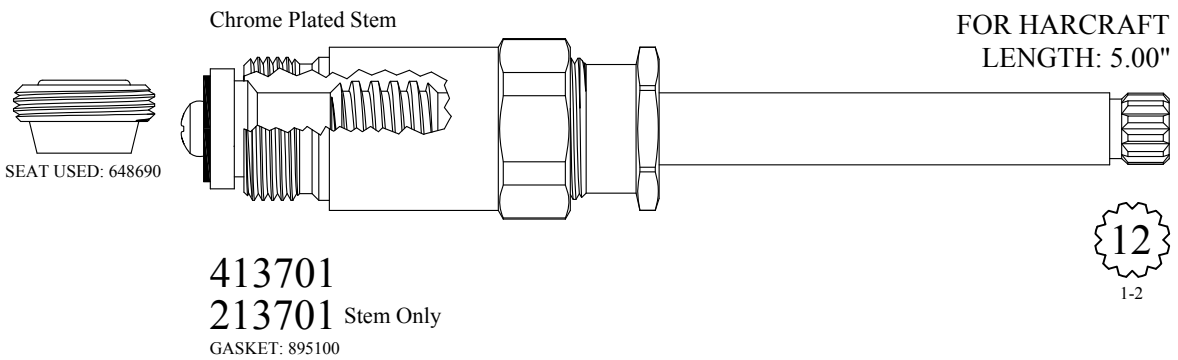
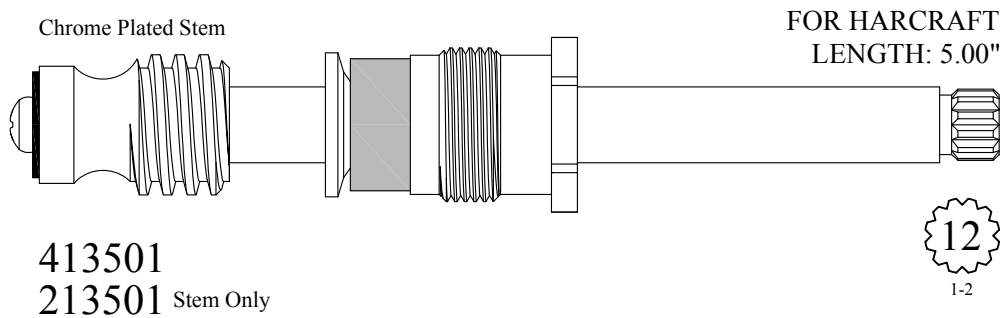
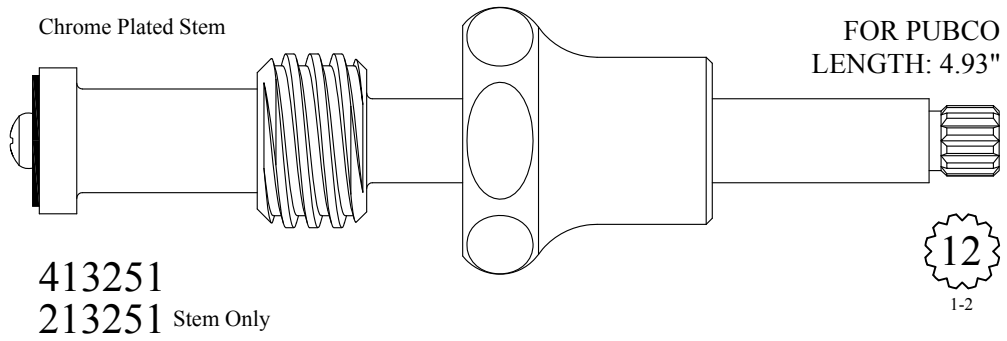
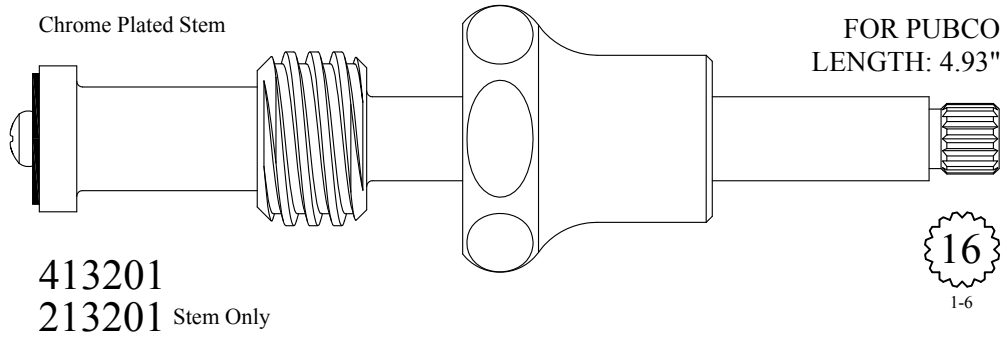

FOR STERLING BRASS  
FOR DICK BROS.  
LENGTH: 5.00"

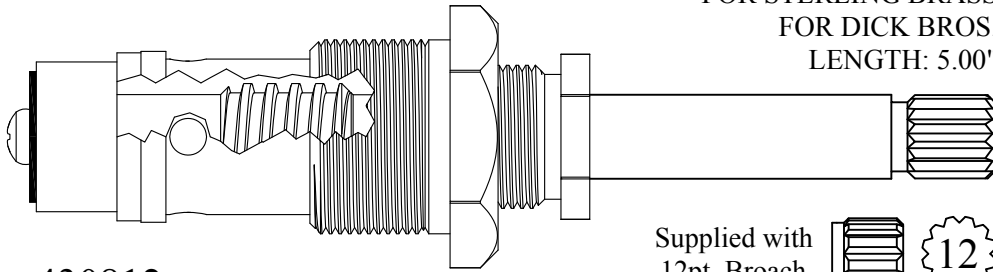

430812  
230812 Stem Only  
GASKET: 895560

Supplied with  
12pt. Broach  12  
1-2

Chrome Plated Stem

FOR SPEAKMAN  
LENGTH: 5.00"



SEAT USED: LF648930

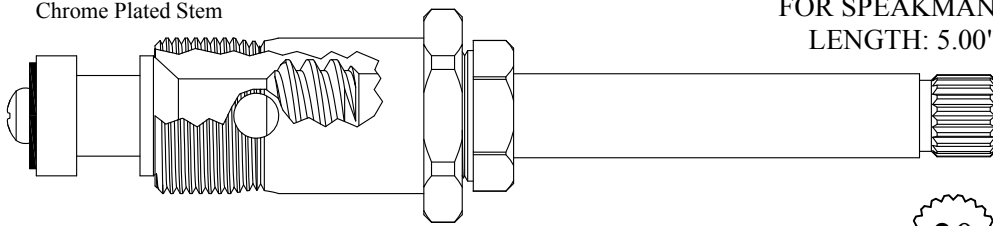

431911  
231911 Stem Only  
GASKET: 895160

20  
2-4

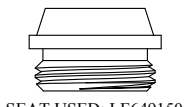

SEAT USED: LF649150

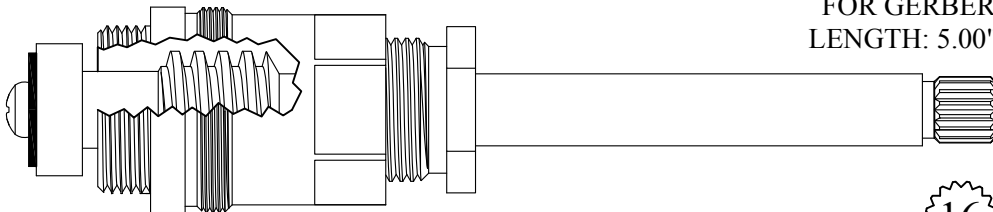

FOR GERBER  
LENGTH: 5.00"

413311/ 413312  
213311/ 213312 Stem Only  
GASKET: 895400

Also available with chrome plated stem  
413311-CP/ 413312-CP  
213311-CP/ 213312-CP Stem Only

16  
2-3

Chrome Plated Stem

FOR ELJER  
LENGTH: 5.00"

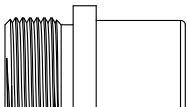

SEAT USED: LF649640

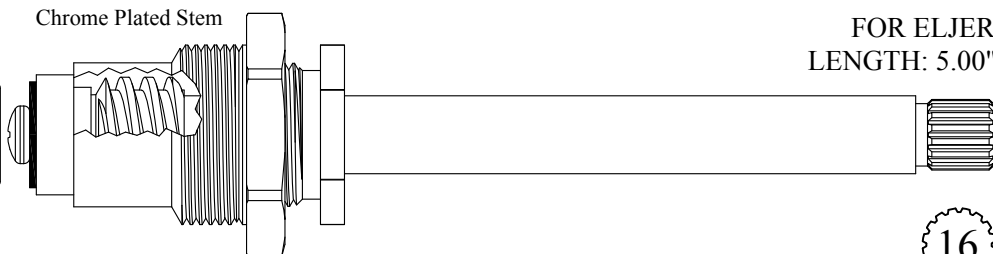

415511/ 415512  
215511/ 215512 Stem Only  
GASKET: 895330

16  
3-15

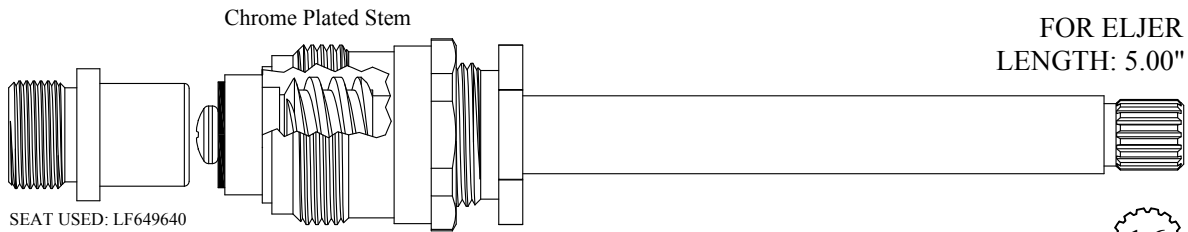

SEAT USED: LF649640

415531/ 415532  
 215511/ 215512 Stem Only  
 GASKET: 895120

16  
 3-15

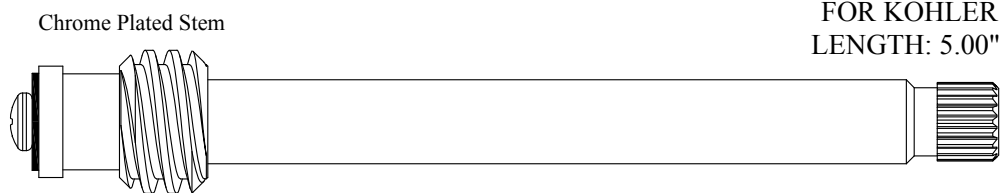

LF277051/ LF277052

19  
 1-7

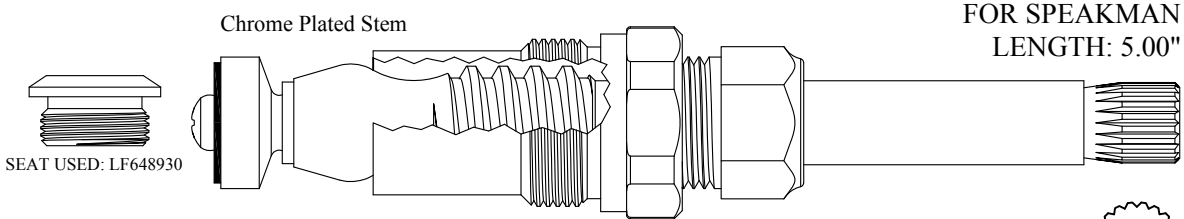

SEAT USED: LF648930

LF476021/ LF476022  
 LF276021/ LF276022 Stem Only

20  
 2-4

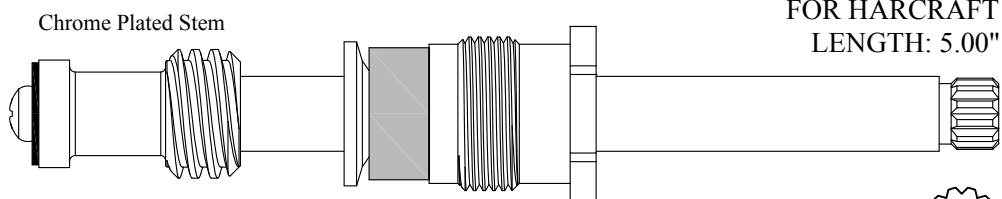

LF480011/ LF480012  
 LF280011/ LF280012 Stem Only

12  
 1-2

Chrome Plated Stem & Tube

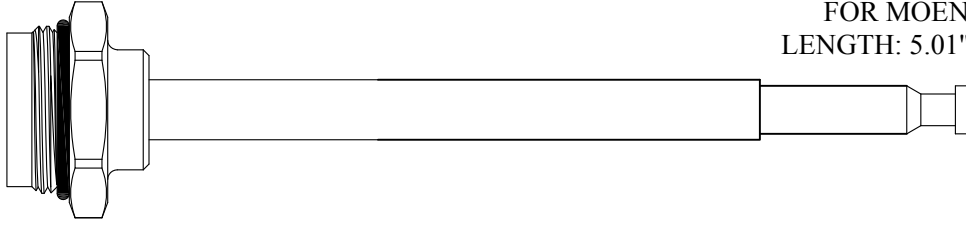

FOR MOEN  
LENGTH: 5.01"

**430590**

GASKET: 890190 O-RING INCLUDED

Chrome Plated Stem

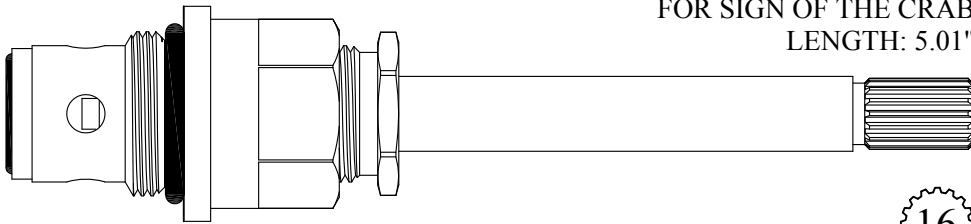

FOR SIGN OF THE CRAB  
LENGTH: 5.01"

**414911/ 414912**

GASKET: 891160 O-RING INCLUDED  
DISC SET: 112530-PKG



3-16

FOR SAVOY  
LENGTH: 5.02"



SEAT USED: LF648130

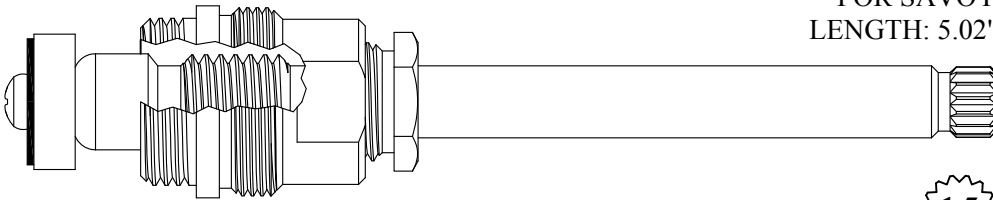

**413211**

**213211** Stem Only

GASKET: 895400



1-13

Chrome Plated Stem

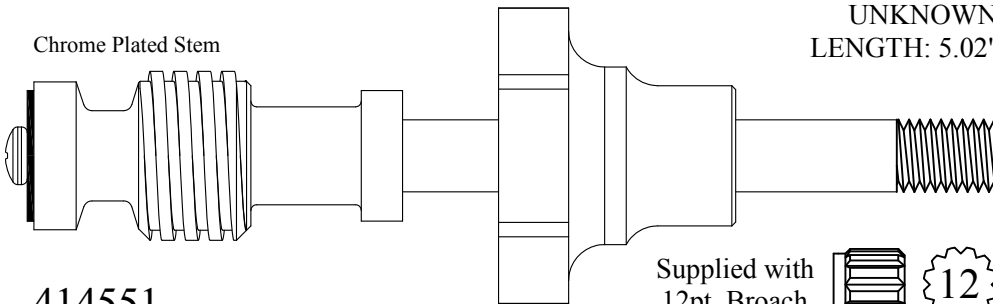

UNKNOWN  
LENGTH: 5.02"

**414551**

**214551** Stem Only

Supplied with  
12pt. Broach



1-2

SEAT USED: 648810

Chrome Plated Stem

FOR CENTRAL  
LENGTH: 5.02"

16  
1-6

415901  
215901 Stem Only  
GASKET: 895570

SEAT USED: 648810

Chrome Plated Stem

FOR CENTRAL  
LENGTH: 5.02"

12  
1-2

415951  
215951 Stem Only  
GASKET: 895570

SEAT USED: LF649790

Chrome Plated Stem

FOR MUELLER  
LENGTH: 5.03"

16  
1-6

414801  
214801 Stem Only

SEAT USED: LF649790

Chrome Plated Stem

FOR MUELLER  
LENGTH: 5.03"

12  
1-2

414851  
214851 Stem Only

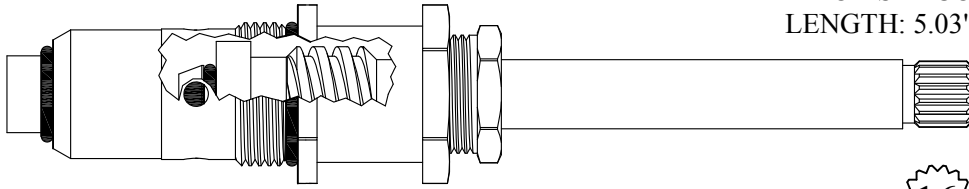

FOR SAYCO  
LENGTH: 5.03"

409911/ 409912

GASKET: 890160 O-RING INCLUDED  
SEAT INCLUDED: 609910

16

2-3

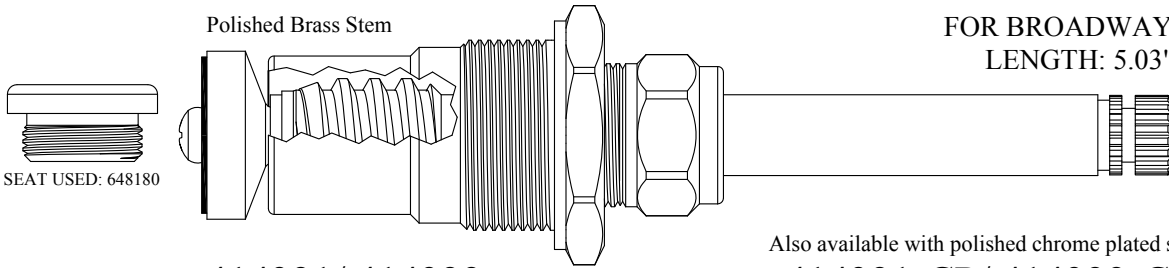

Polished Brass Stem

FOR BROADWAY  
LENGTH: 5.03"

SEAT USED: 648180

20

2-4

414321/ 414322

214321/ 214322 Stem Only

GASKET: 895570

Also available with polished chrome plated stem

414321-CP/ 414322-CP

214321-CP/ 214322-CP Stem Only

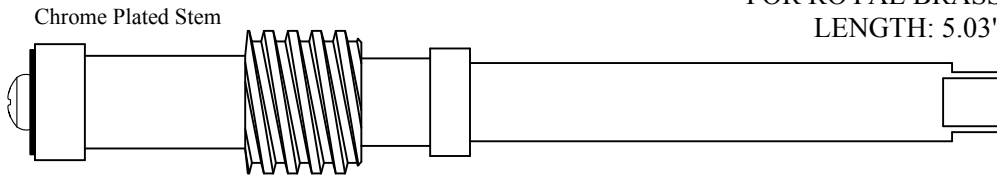

Chrome Plated Stem

FOR ROYAL BRASS  
LENGTH: 5.03"

LF279011

5/16



SEAT USED: LF648130

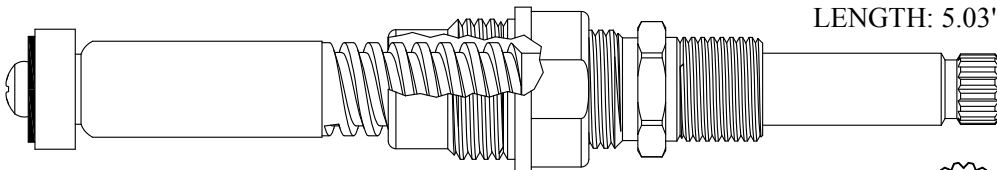

FOR P.E. GUERIN  
LENGTH: 5.03"

LF478701/ LF478702

GASKET: 895100

16

1-6

Chrome Plated Stem / Brass Plunger

FOR KOHLER  
LENGTH: 5.04"

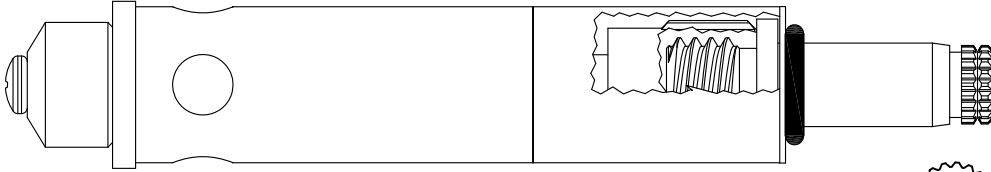

431412



Chrome Plated Stem / Brass Plunger

FOR KOHLER  
LENGTH: 5.04"

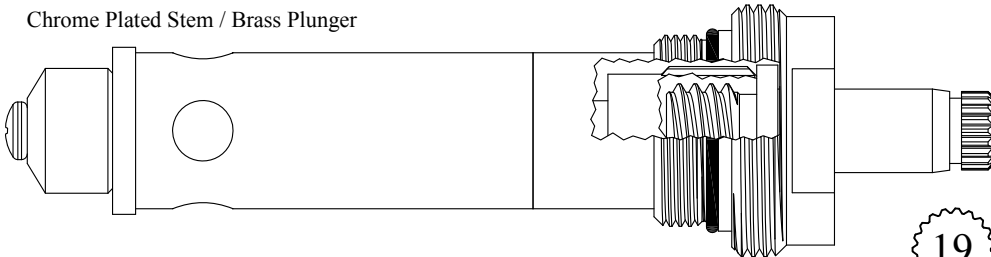

431422

GASKET: 890210 O-RING INCLUDED



Chrome Plated Stem / Plastic Plunger

FOR KOHLER  
LENGTH: 5.04"

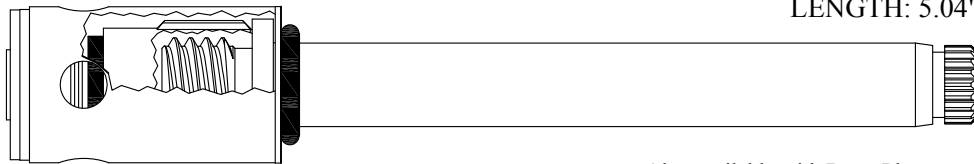

407001/ 407002

207001/ 207002 Stem Only

SEAT: LF649460 INCLUDED



Also available with Brass Plunger  
407001-B / 407002-B

Also available with Brass Plunger &  
Polished Gold stem

407001-PG / 407002-PG

Chrome Plated Stem / Plastic Plunger

FOR KOHLER  
LENGTH: 5.04"

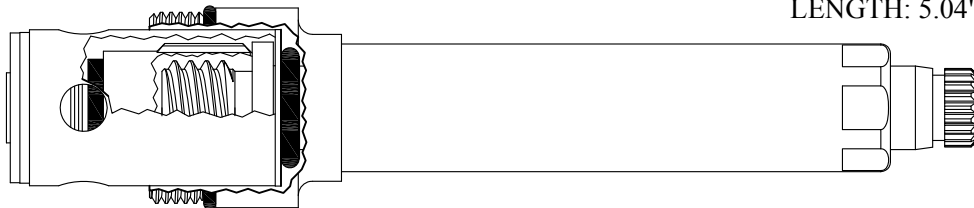

407021/ 407022

207001/ 207002 Stem Only

GASKET: 890210 O-RING INCLUDED  
SEAT: LF649460 INCLUDED



Also available with Brass Plunger  
407021-B / 407022-B

Chrome Plated Stem / Plastic Plunger

FOR KOHLER  
LENGTH: 5.04"

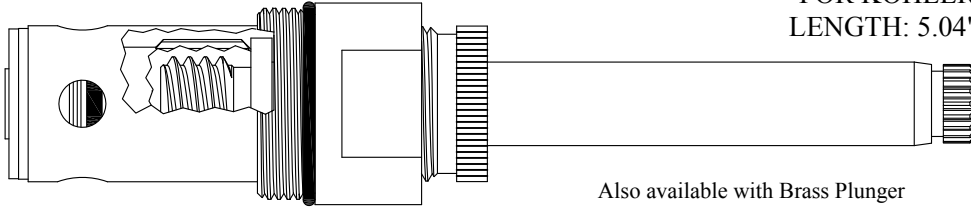

19  
1-7

407031/ 407032  
207001/ 207002 Stem Only

GASKET: 890210 O-RING INCLUDED  
SEAT: LF649460 INCLUDED

Also available with Brass Plunger  
407031-B / 407032-B

Also available with Brass Plunger &  
Polished Gold stem

407031-PG / 407032-PG

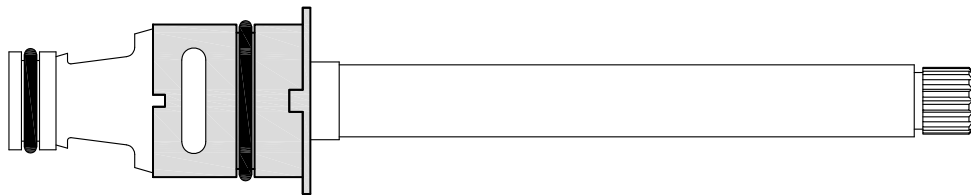

Not Available, Use 414421 / 414422

FOR SAYCO  
LENGTH: 5.04"



16  
2-3

414421/ 414422

DISC SET: 151380-PKG

FOR REID WATSON  
LENGTH: 5.04"



SEAT USED: LF648130

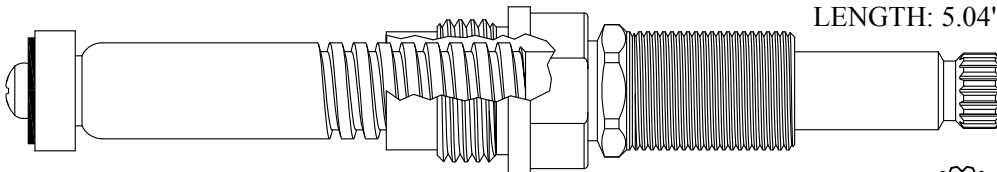

16  
1-5

LF478711/ LF478712

GASKET: 895100



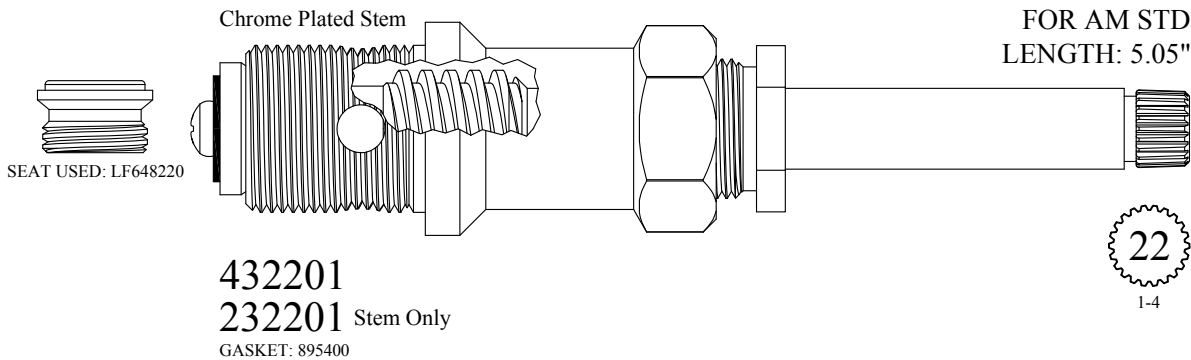
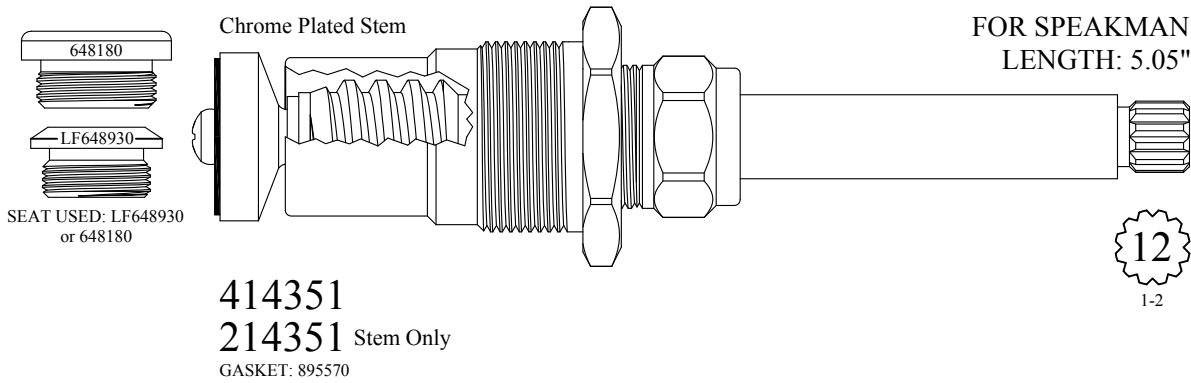
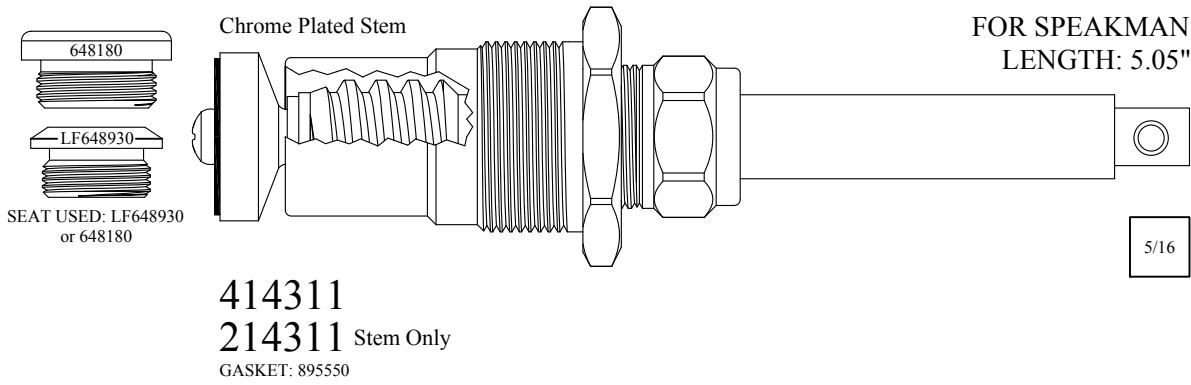
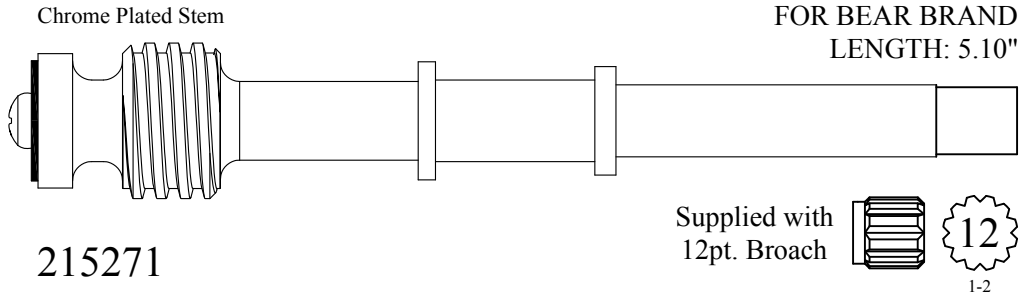

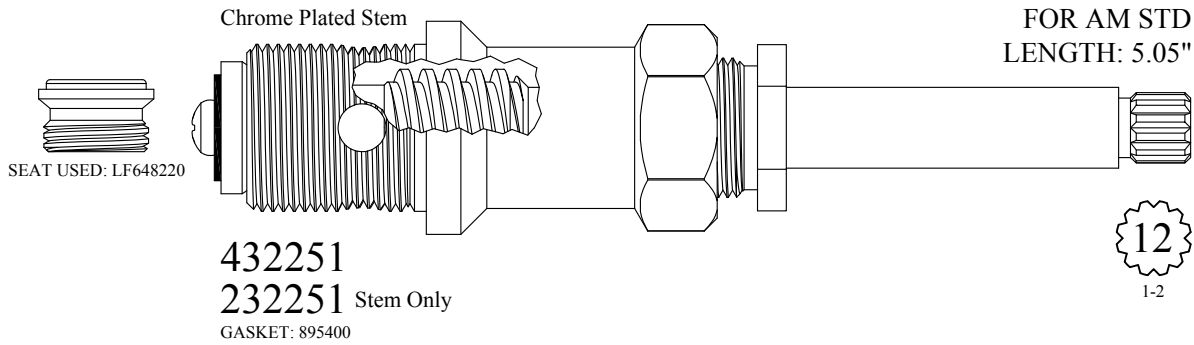

432251  
 232251 Stem Only  
 GASKET: 895400

12  
 1-2

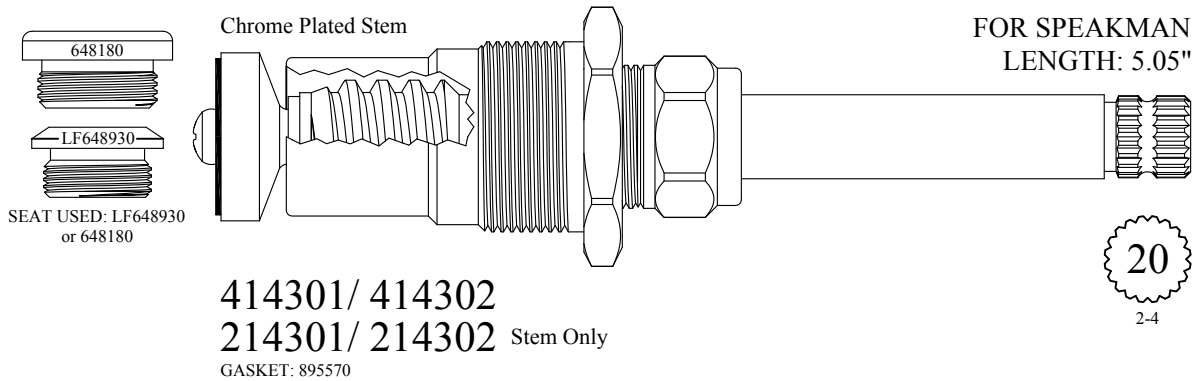

414301/ 414302  
 214301/ 214302 Stem Only  
 GASKET: 895570

20  
 2-4

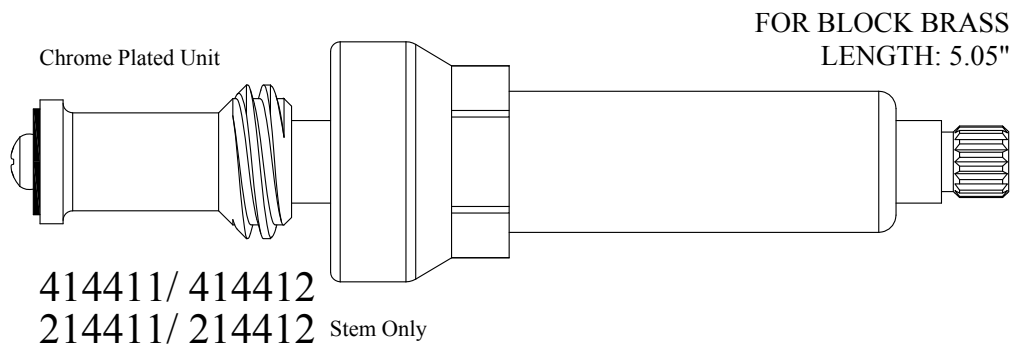

414411/ 414412  
 214411/ 214412 Stem Only

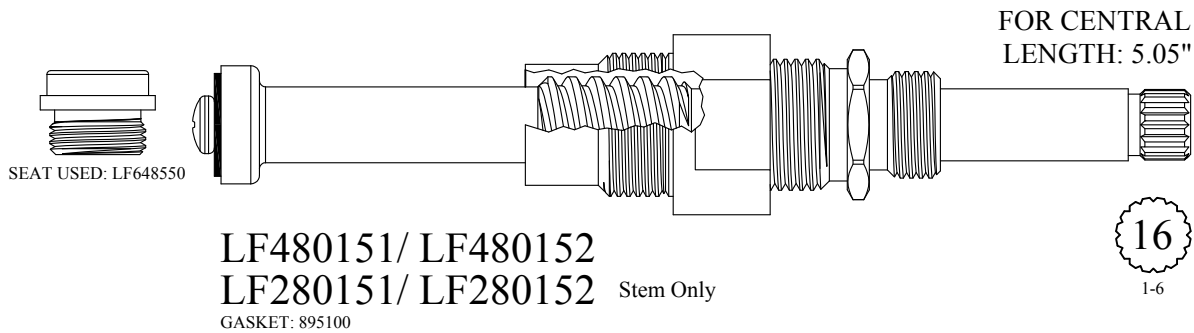

LF480151/ LF480152  
 LF280151/ LF280152 Stem Only  
 GASKET: 895100

16  
 1-6

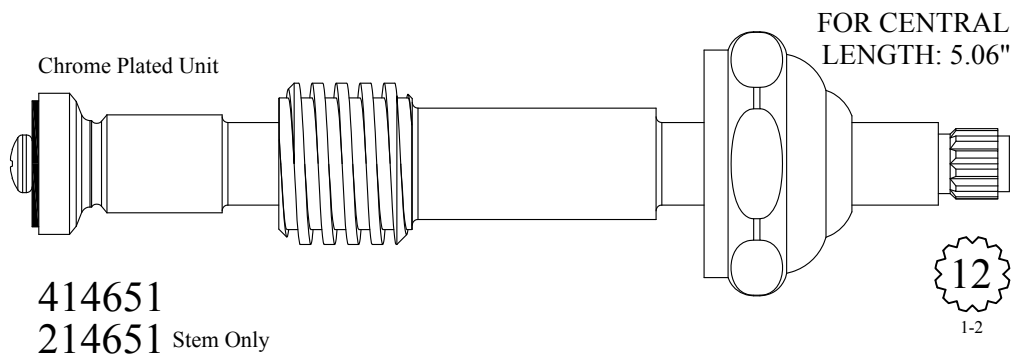
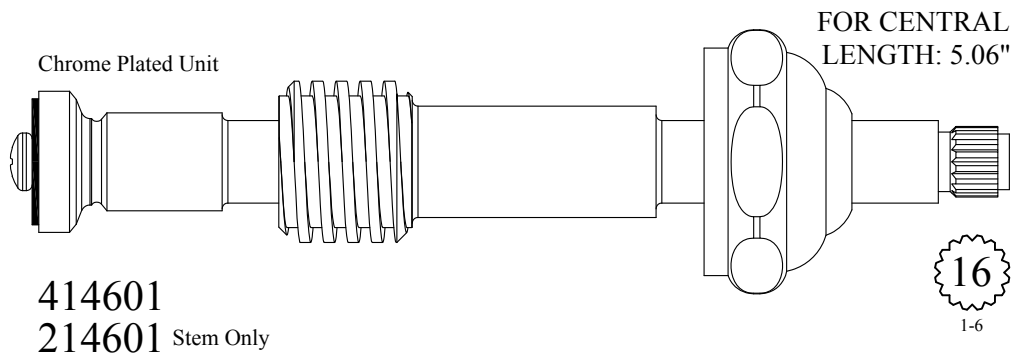
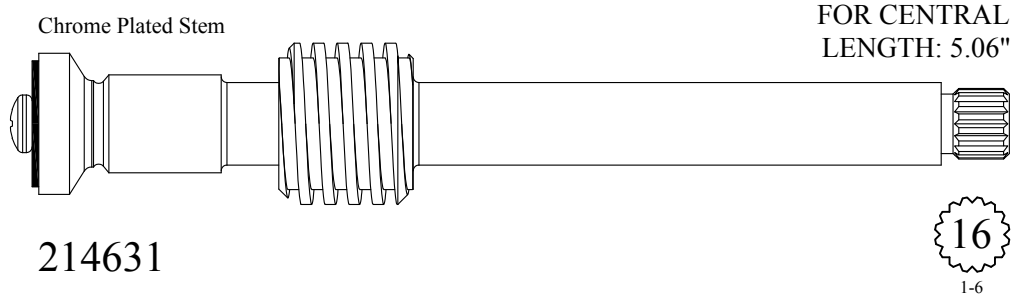
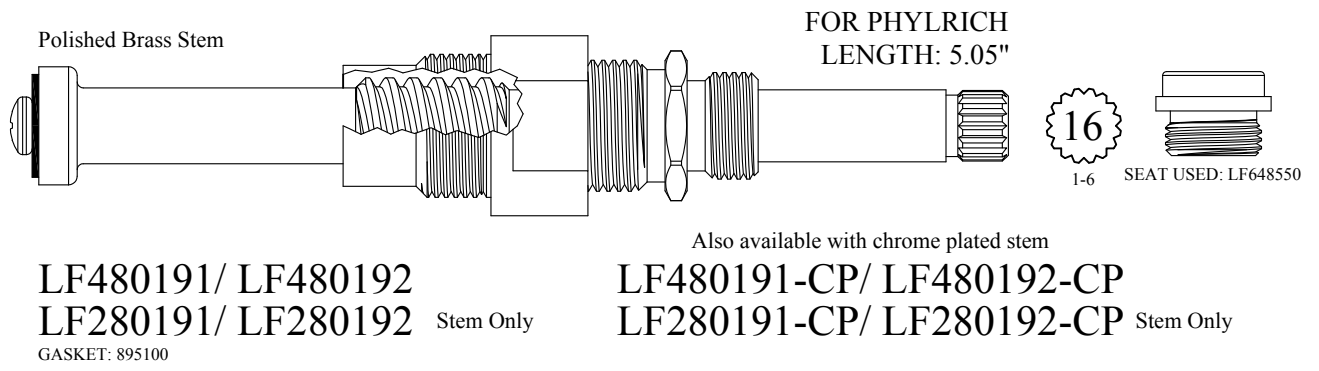

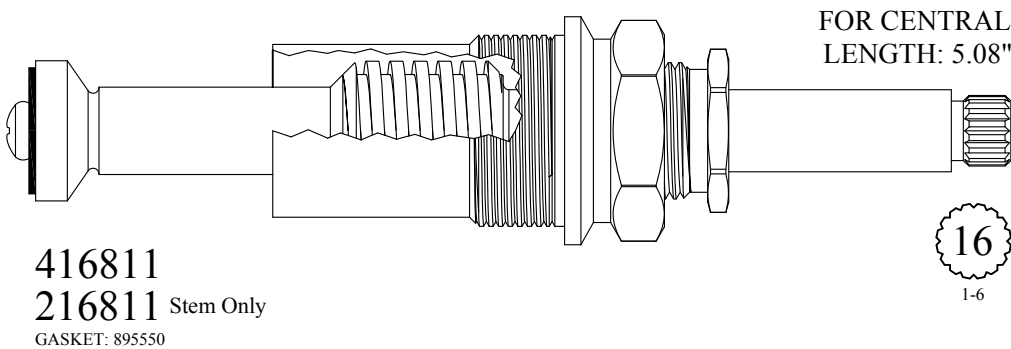
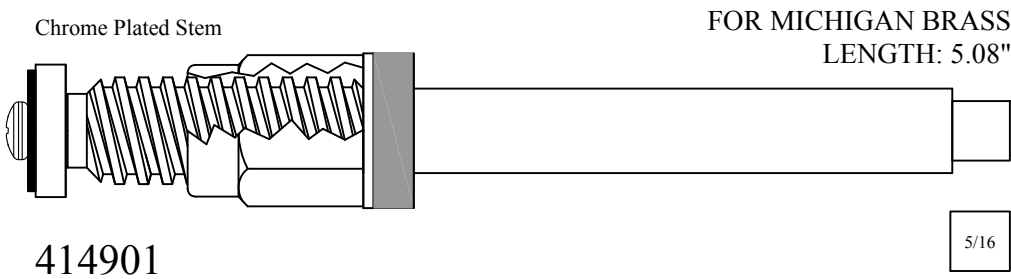
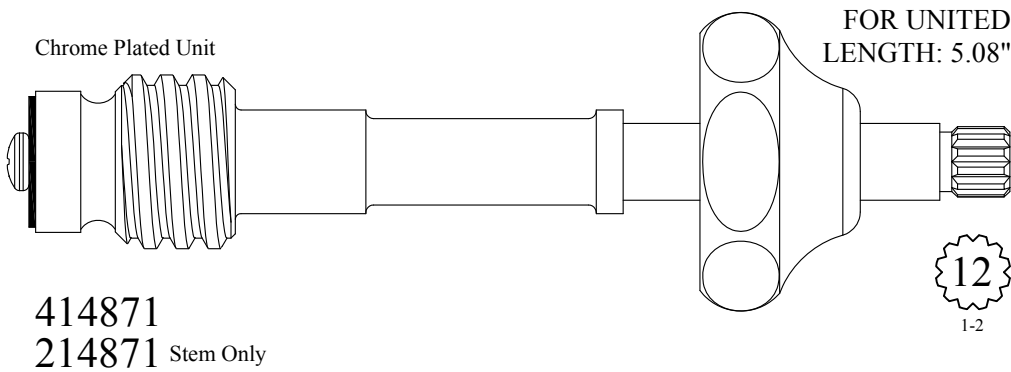
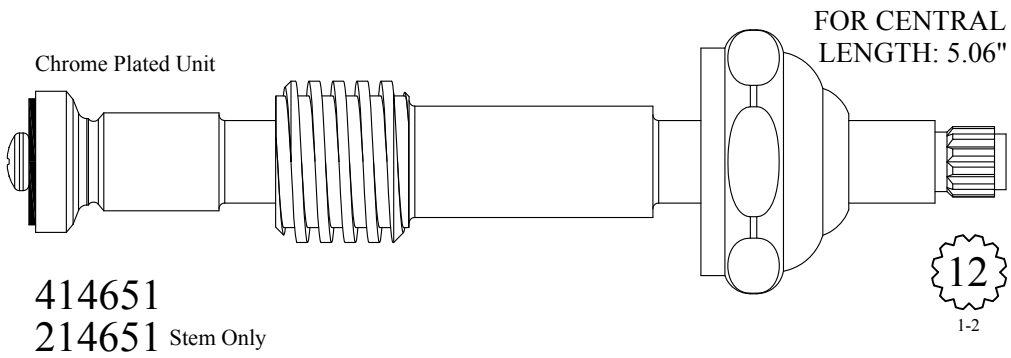

Plastic Escutcheon Nipple

FOR KOHLER  
LENGTH: 5.08"

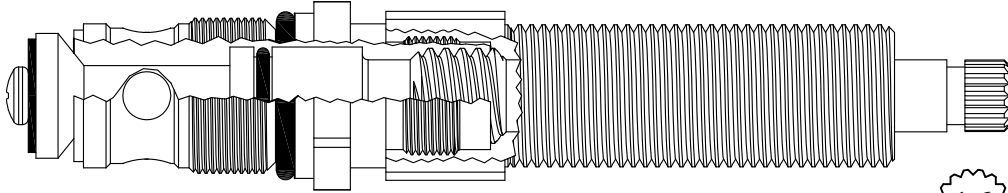

433171

GASKET: 891150 O-RING INCLUDED

16  
1-6

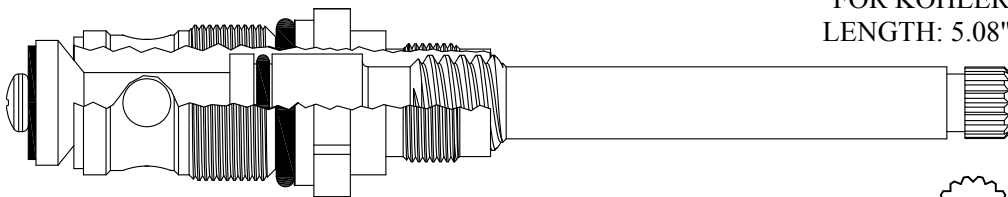

FOR KOHLER  
LENGTH: 5.08"

433181

GASKET: 891150 O-RING INCLUDED

16  
1-6

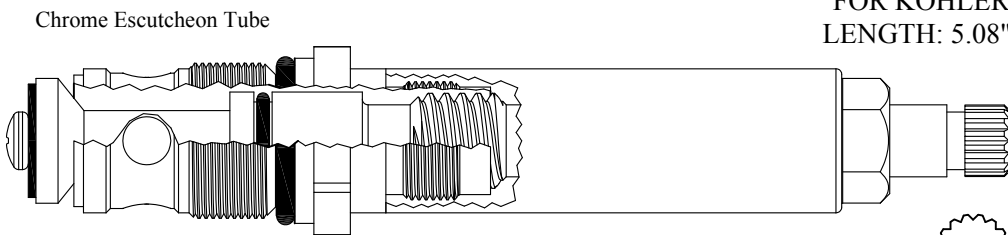

FOR KOHLER  
LENGTH: 5.08"

433191

GASKET: 891150 O-RING INCLUDED

16  
1-6

Chrome Plated Stem

FOR PRICE PFISTER  
LENGTH: 5.09"

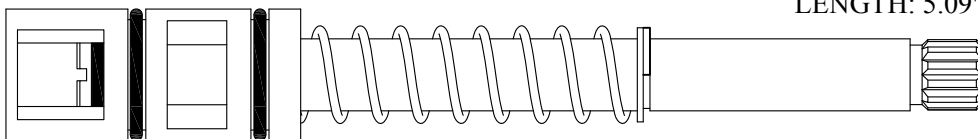

236260

12  
1-2

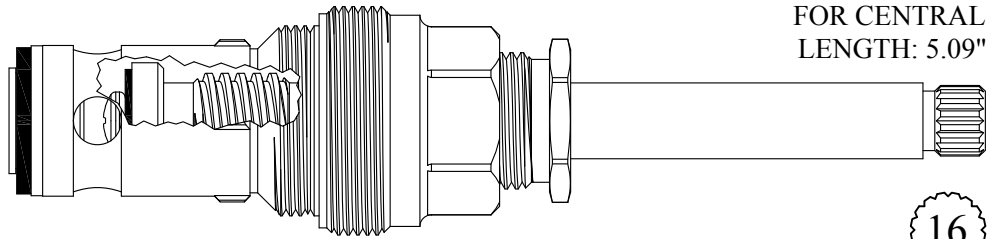

**414821**  
 GASKET: 895340  
 SEAT INCLUDED: 647850

16  
 1-6

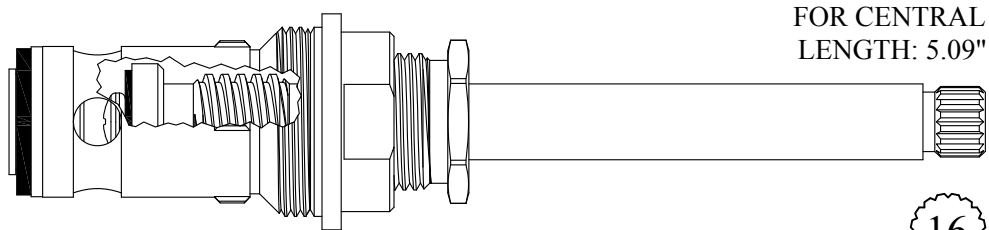

**414811/ 414812**  
 GASKET: 895340  
 SEAT INCLUDED: 647850

16  
 1-6

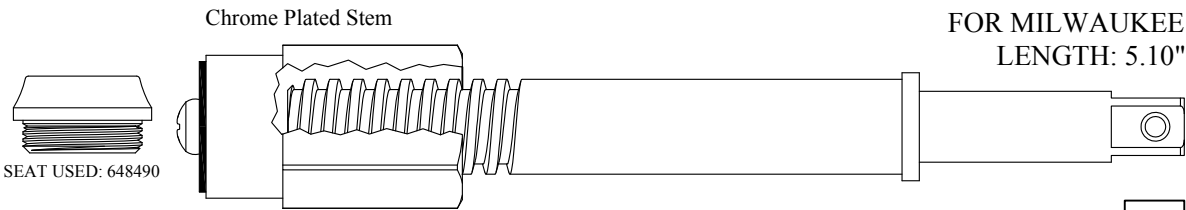

SEAT USED: 648490

**408502**  
**208502** Stem Only  
 GASKET: 894960 INCLUDED

5/16

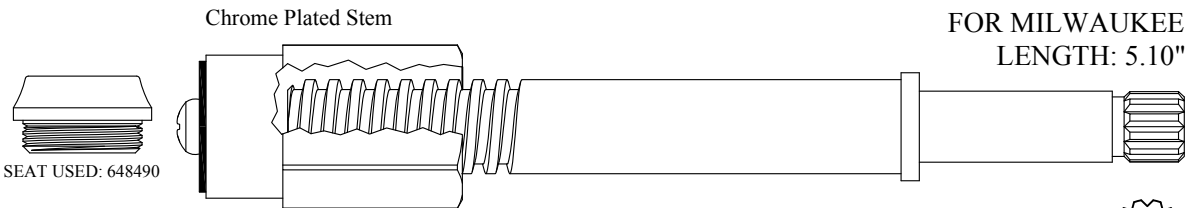

SEAT USED: 648490

**408552**  
**208552** Stem Only  
 GASKET: 894960 INCLUDED

12  
 1-2

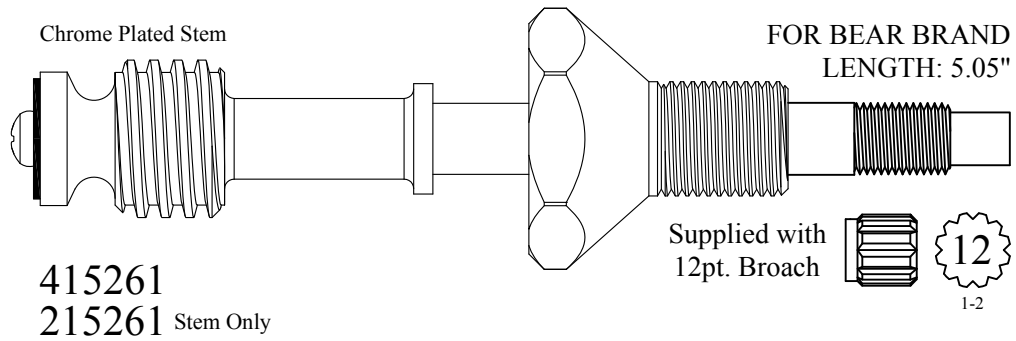

415261  
215261 Stem Only

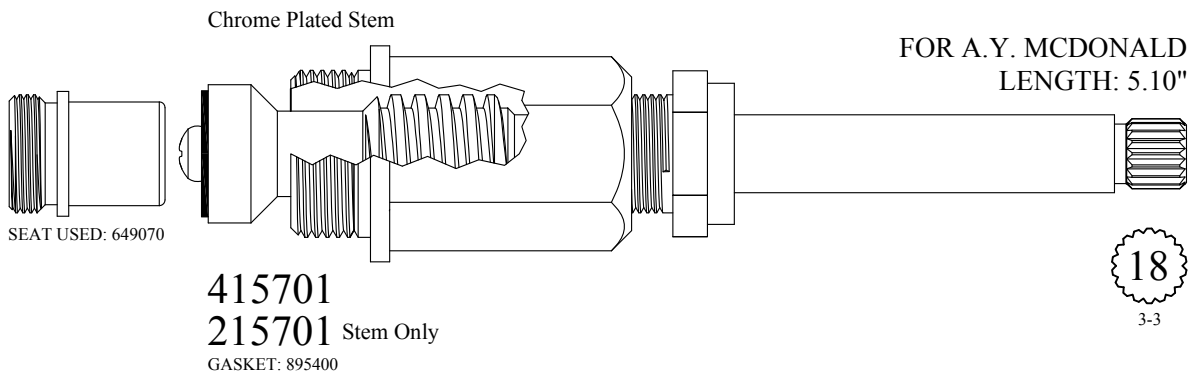

415701  
215701 Stem Only  
GASKET: 895400

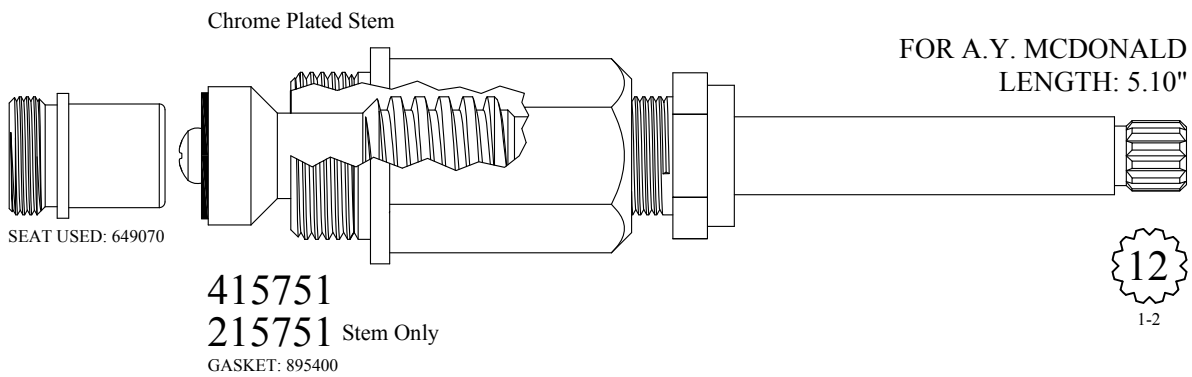

415751  
215751 Stem Only  
GASKET: 895400

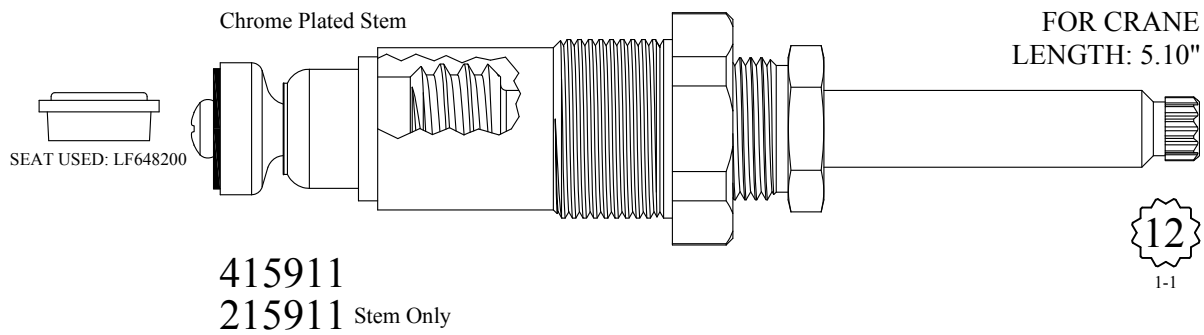

415911  
215911 Stem Only

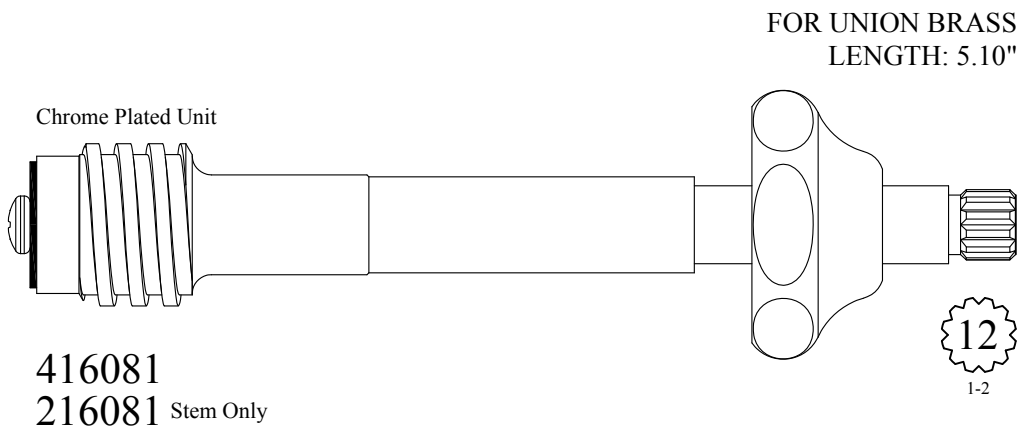
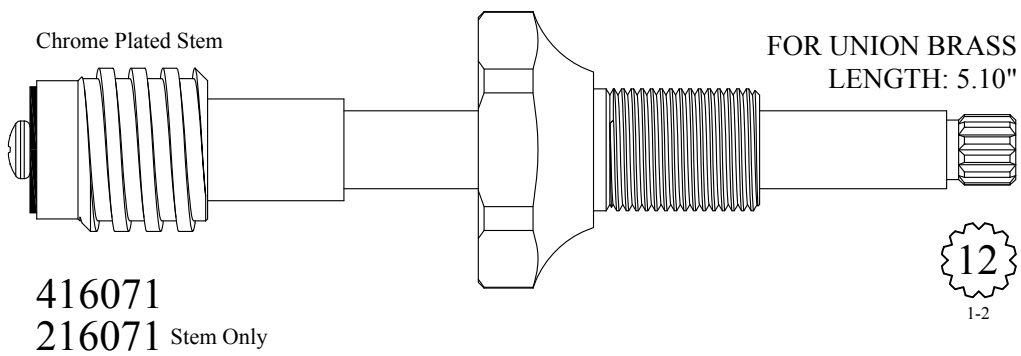
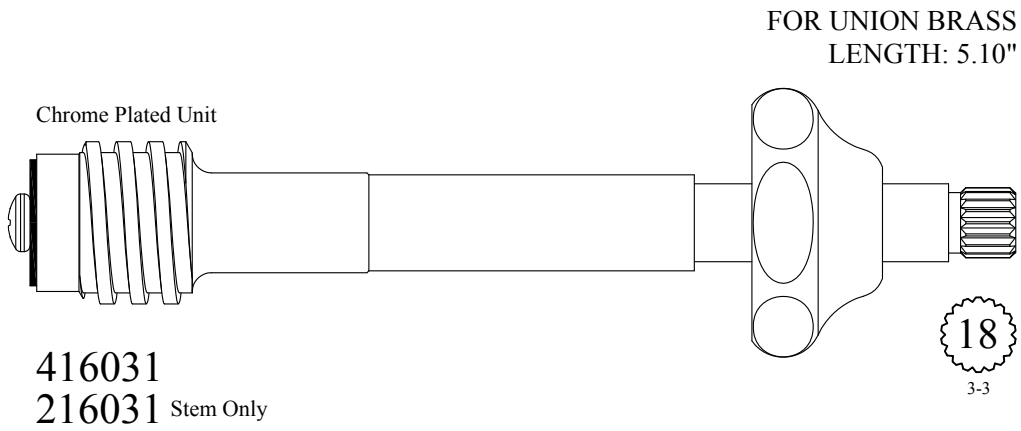
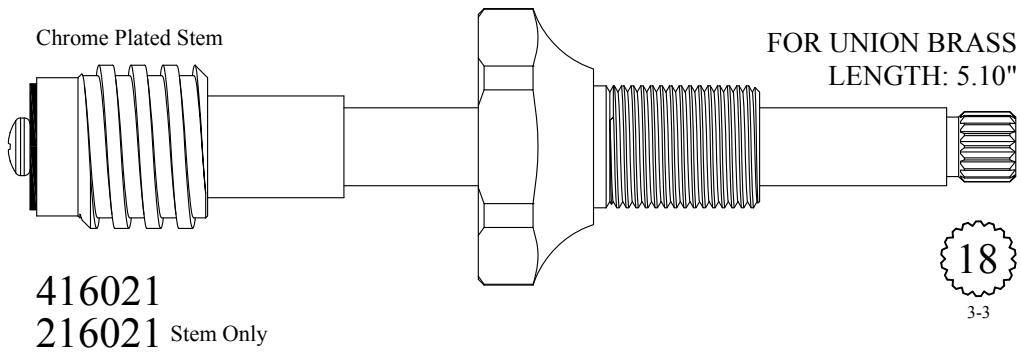



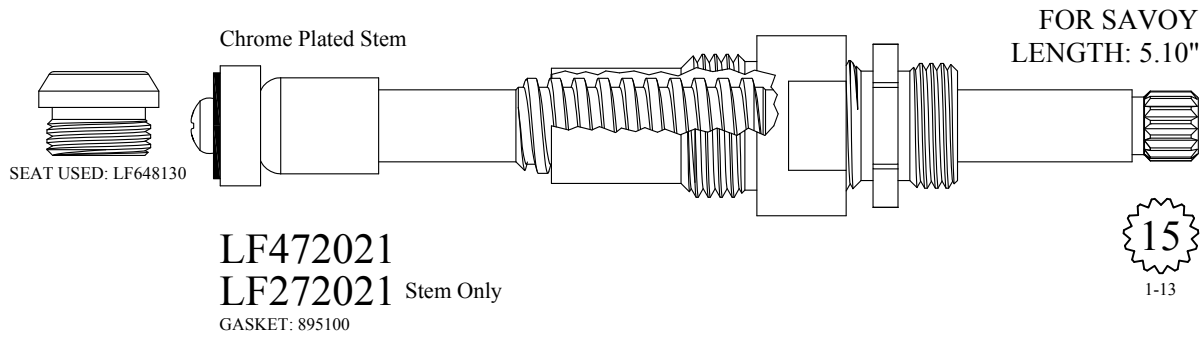

**LF472021**  
**LF272021** Stem Only  
 GASKET: 895100

15  
 1-13

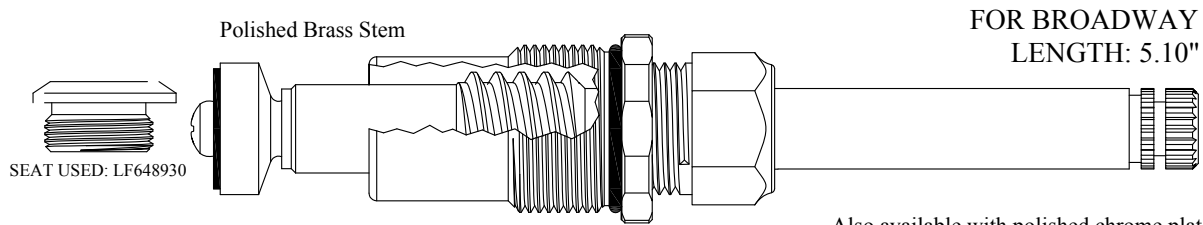

**LF478881/ LF478882**  
**LF278881/ LF278882** Stem Only  
 GASKET INCLUDED: 890180

Also available with polished chrome plated stem  
**LF478881-CP/ LF478882-CP**  
**LF278881-CP/ LF278882-CP** Stem Only

20  
 2-4

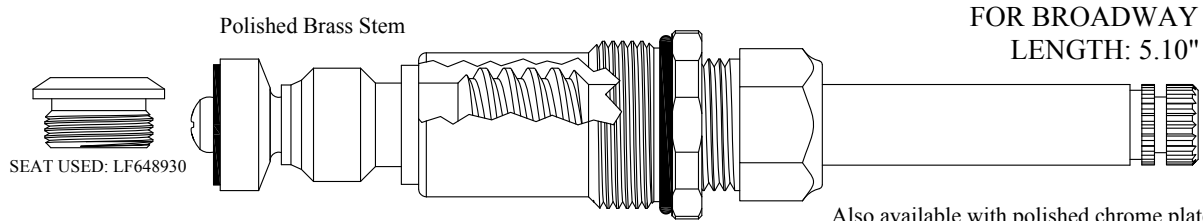

**LF478891/ LF478892**  
**LF278891/ LF278892** Stem Only  
 GASKET INCLUDED: 890180

Also available with polished chrome plated stem  
**LF478891-CP/ LF478892-CP**  
**LF278891-CP/ LF278892-CP** Stem Only

20  
 2-4

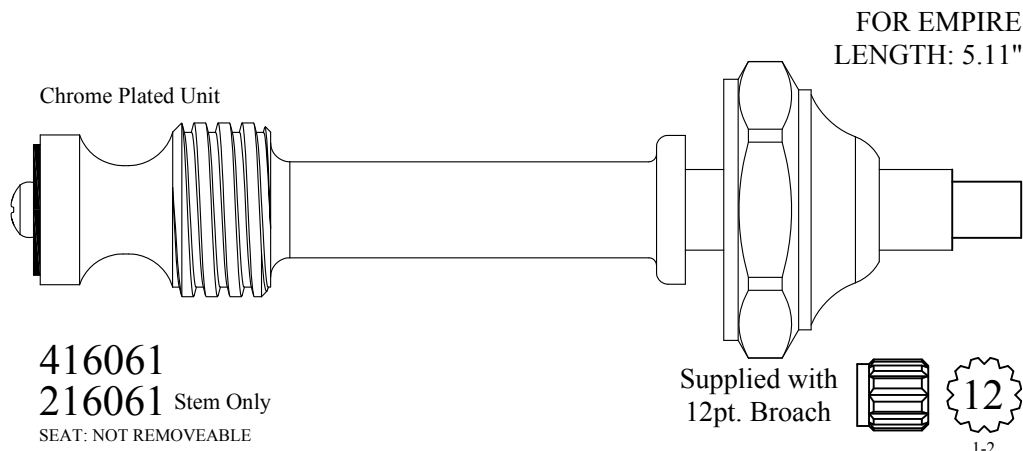

**416061**  
**216061** Stem Only  
 SEAT: NOT REMOVEABLE

Supplied with  
 12pt. Broach  **12**  
 1-2

Chrome Plated Gland & Push Button

FOR SYMMONS  
LENGTH: 5.12"

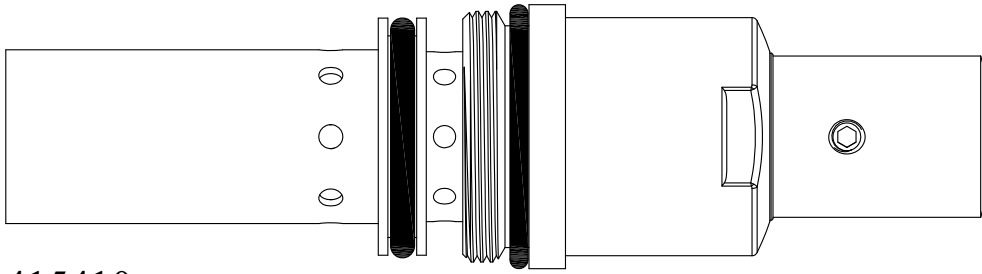

415410

432411  
232411 Stem Only  
GASKET: 895400

FOR SAVOY  
LENGTH: 5.12"

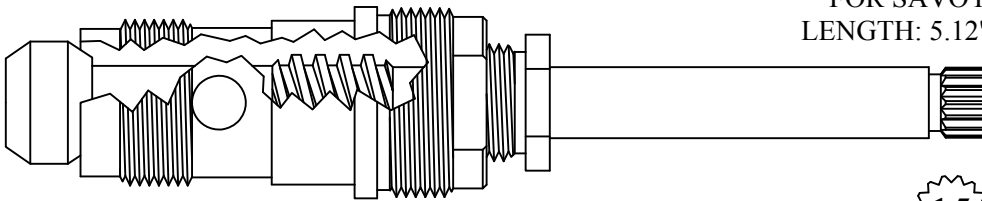

15  
1-13

Chrome Plated Stem

FOR BRIGGS  
LENGTH: 5.12"

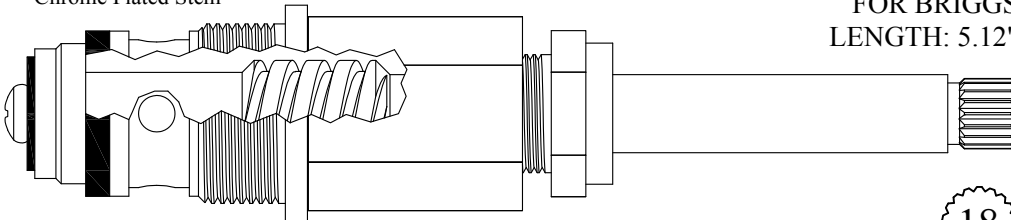

433502  
233502 Stem Only  
GASKET: 895370

18  
3-3

Chrome Plated Unit

FOR BRIGGS  
LENGTH: 5.12"

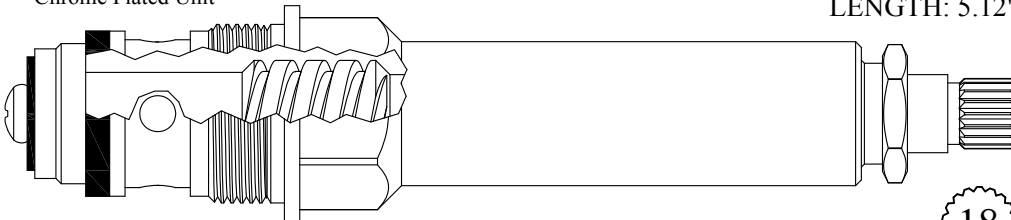

433512  
233502 Stem Only  
GASKET: 895370

18  
3-3

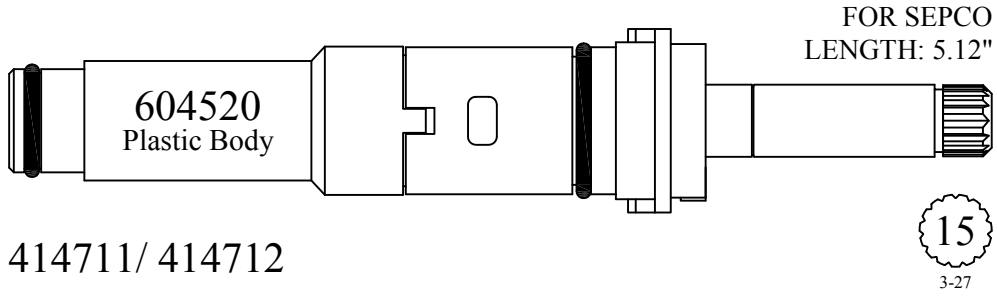

414711 / 414712

15  
3-27

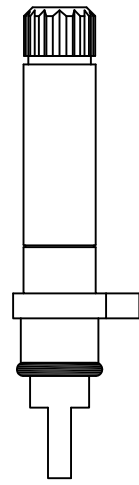

Available: Stem Only  
214711 / 214712

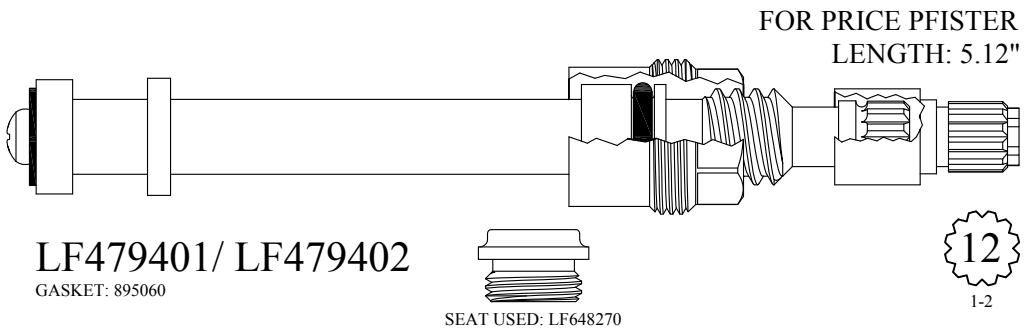

LF479401 / LF479402  
GASKET: 895060

SEAT USED: LF648270

12  
1-2

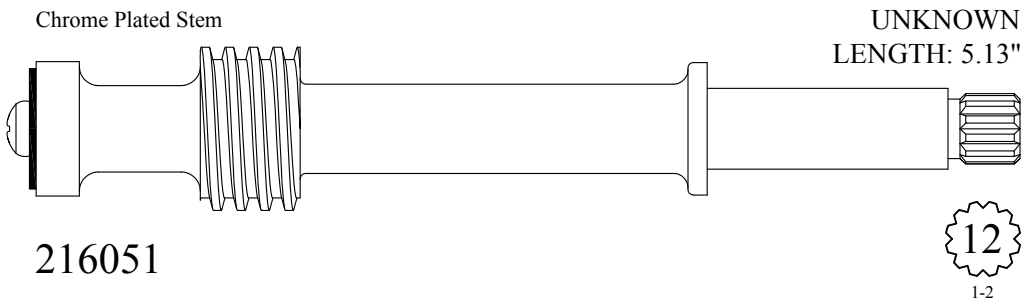

216051

12  
1-2

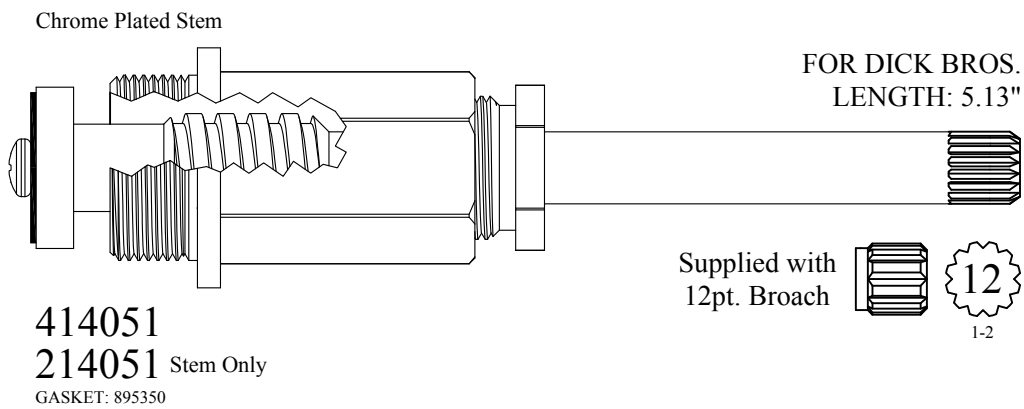

414051  
214051 Stem Only  
GASKET: 895350

Supplied with  
12pt. Broach

12  
1-2

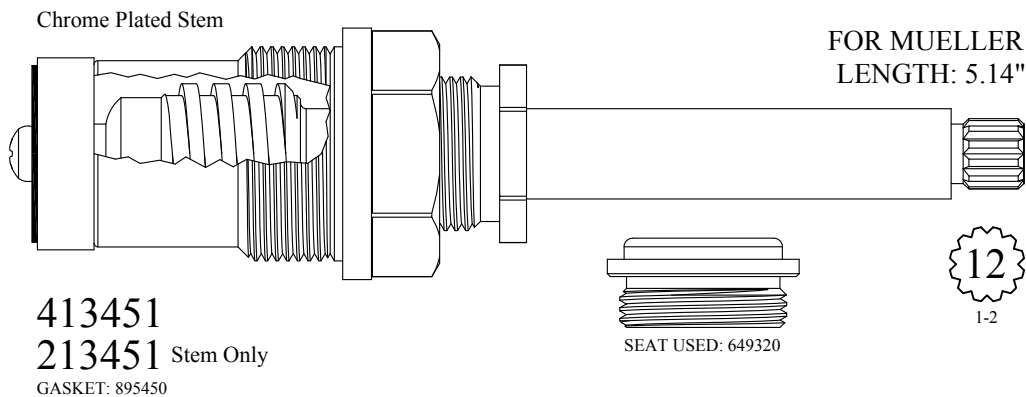
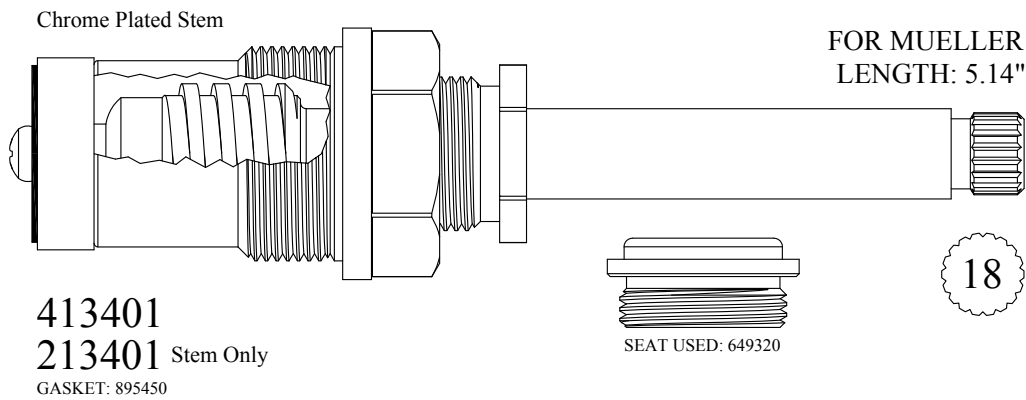
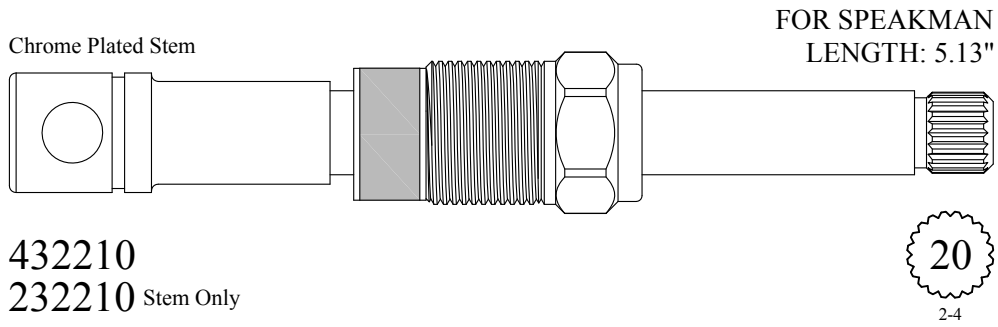
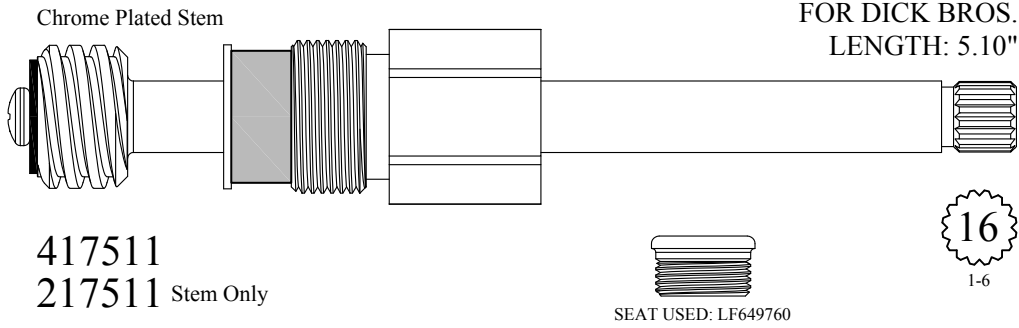

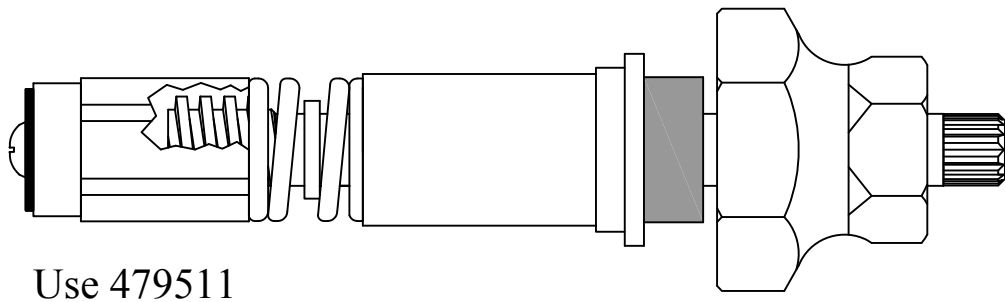
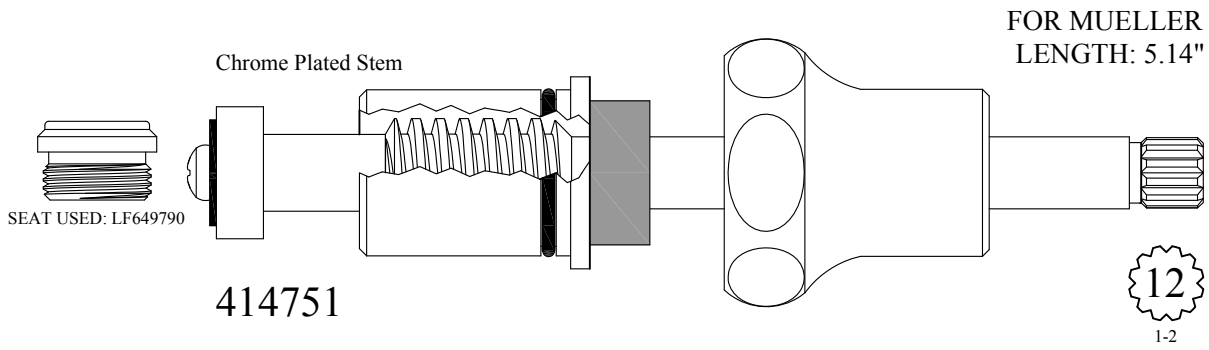
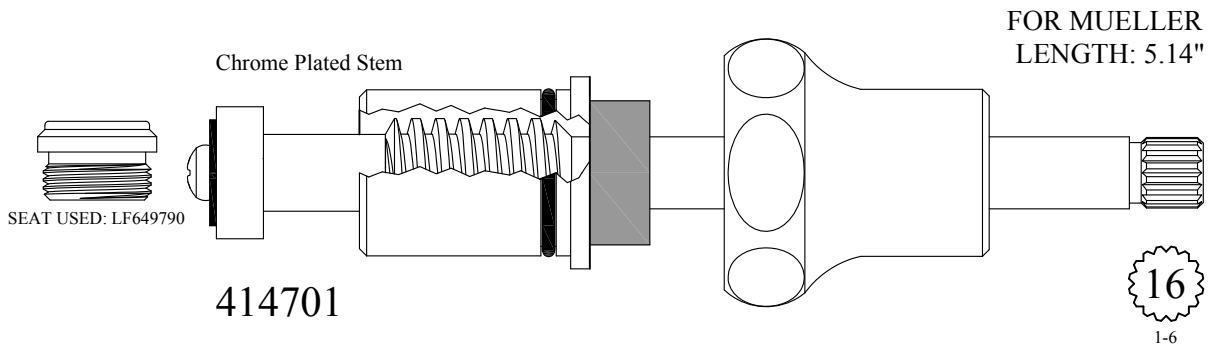
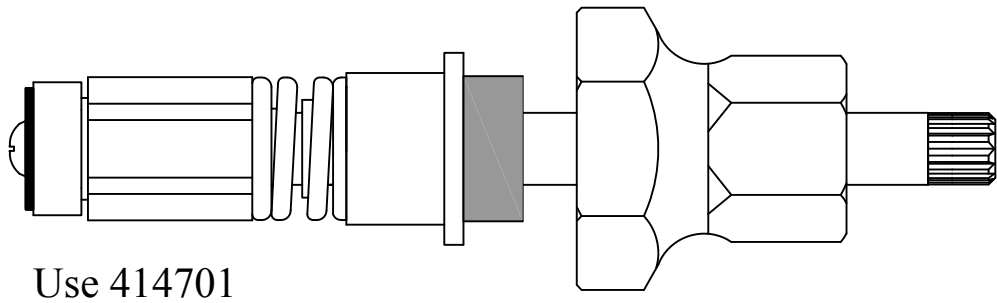

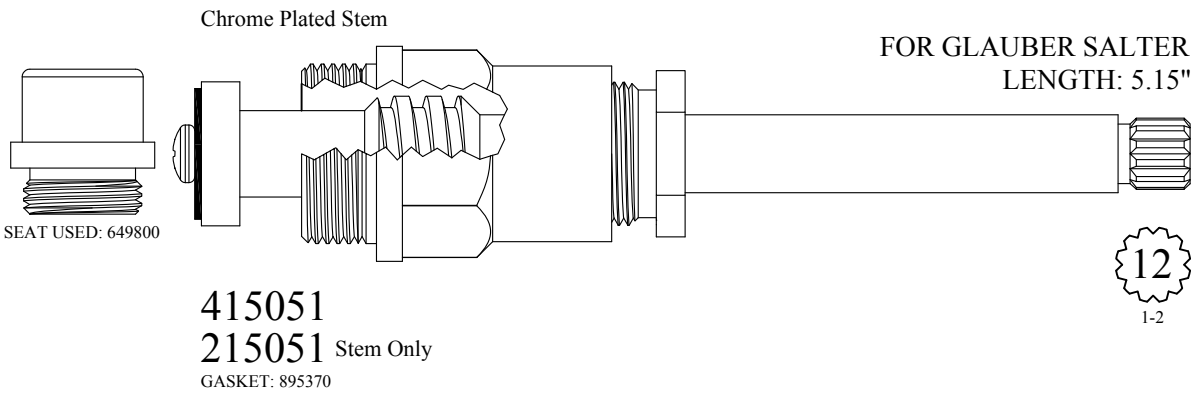
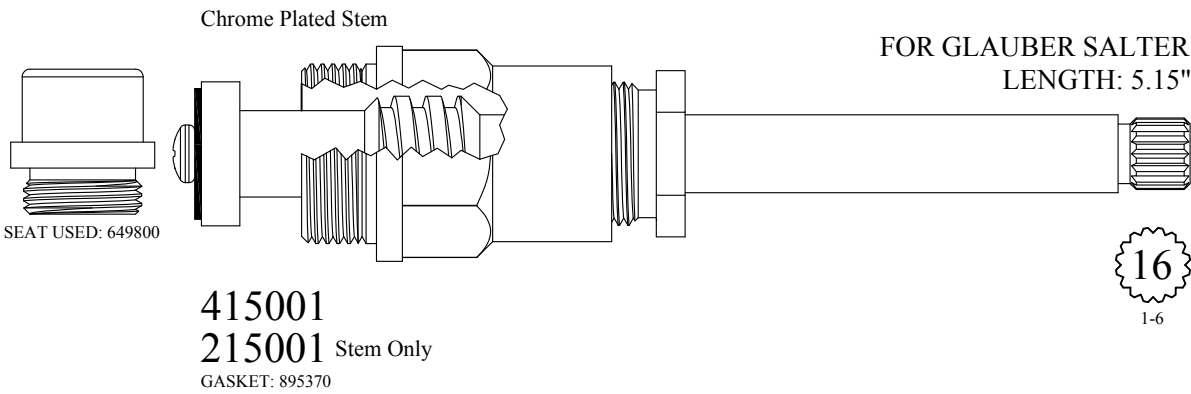
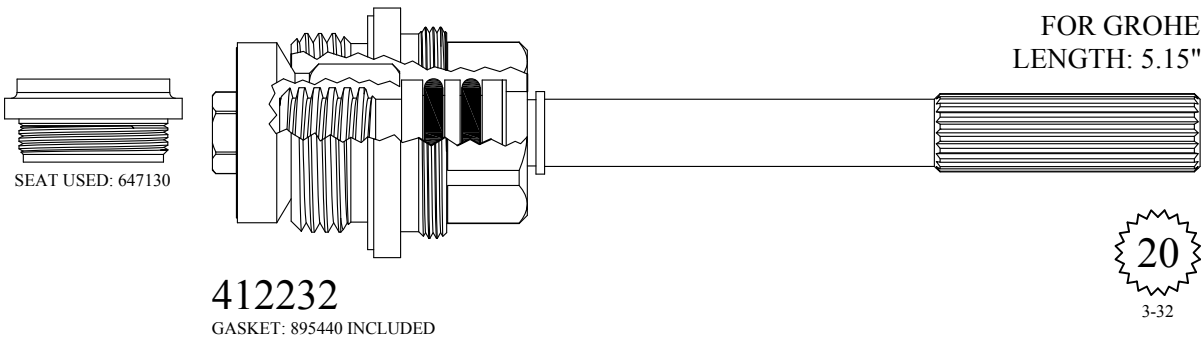
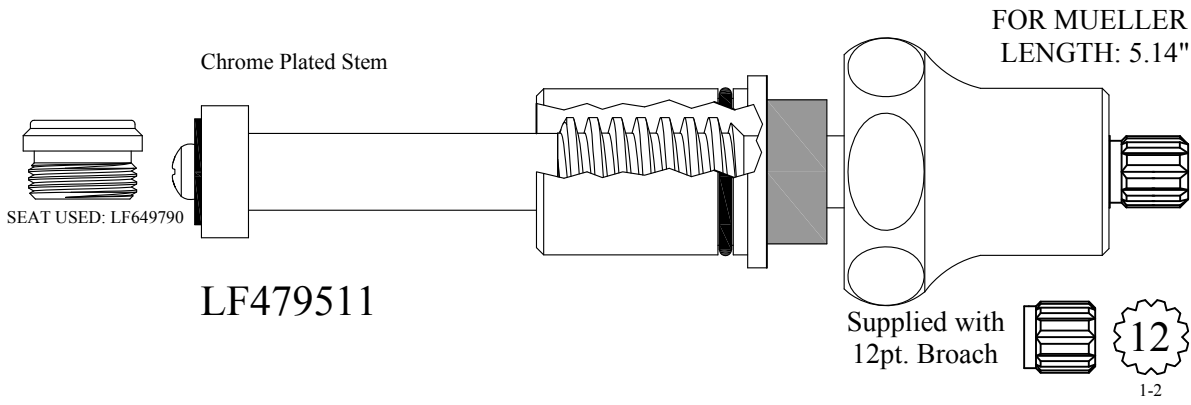

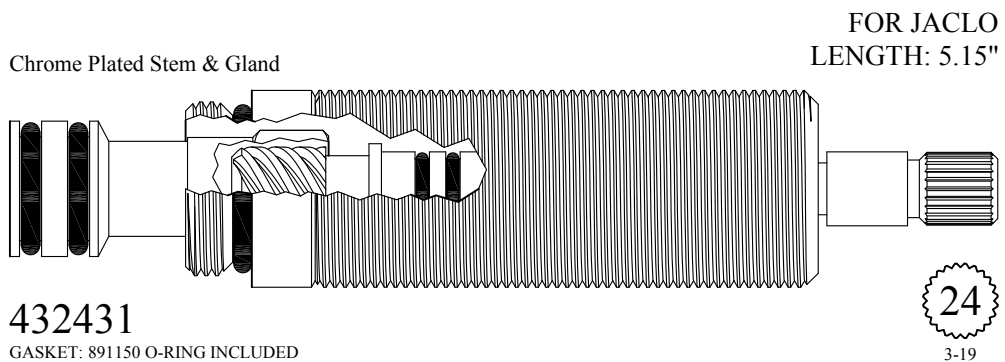
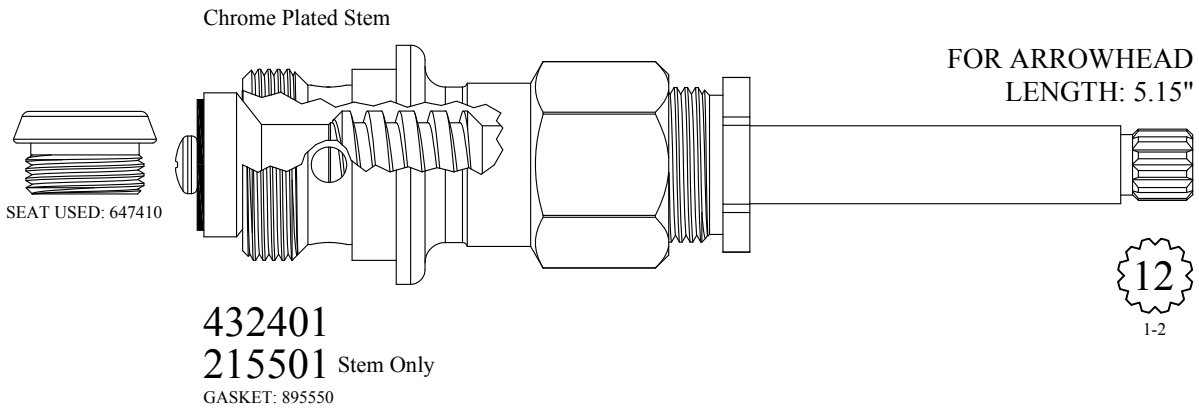
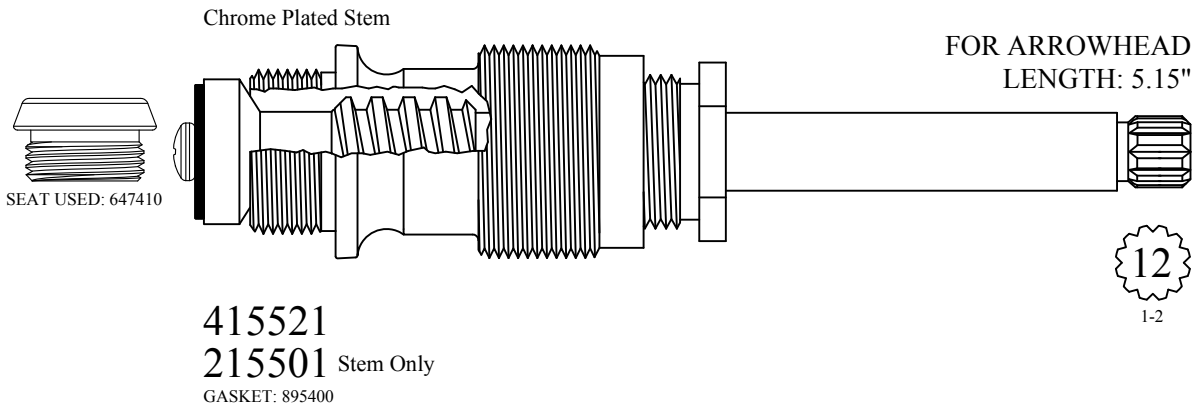
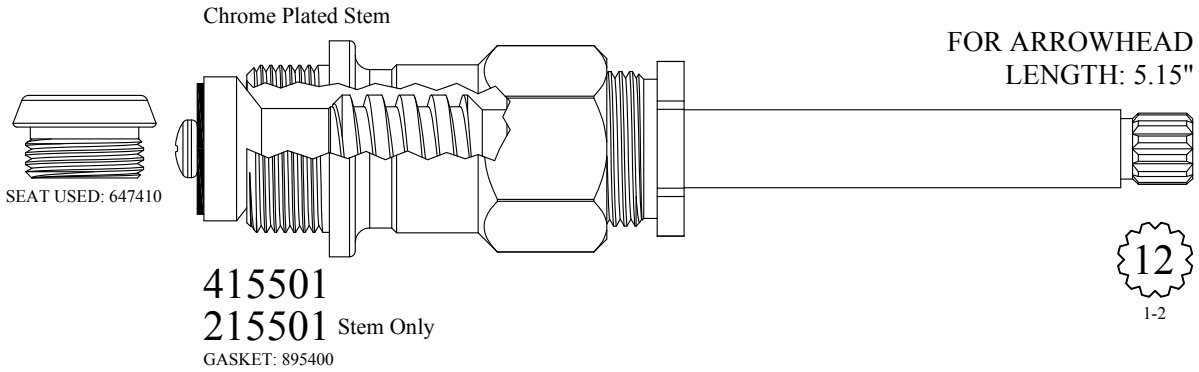

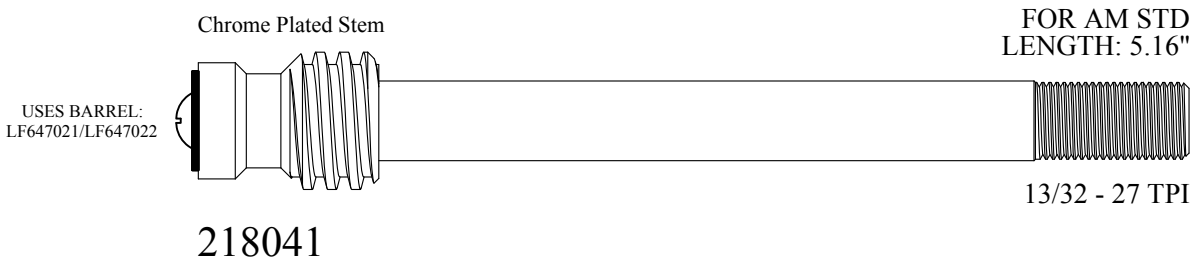
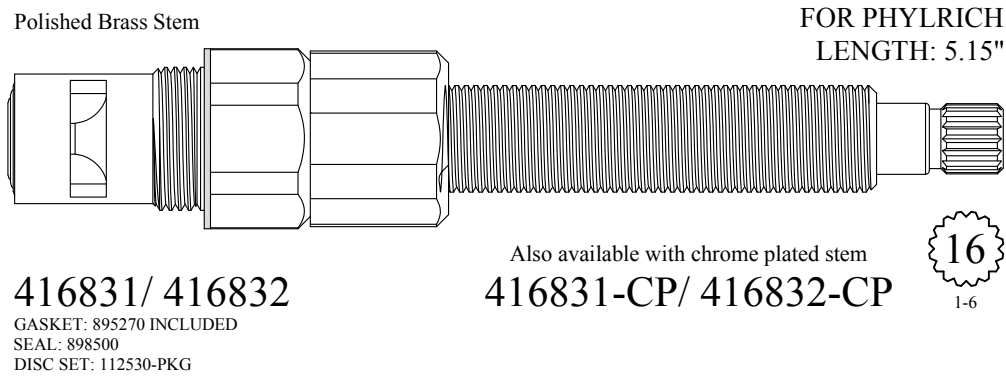
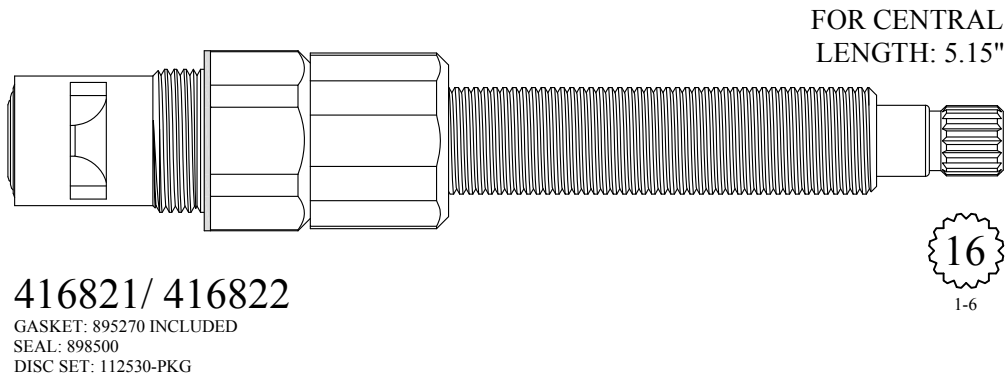
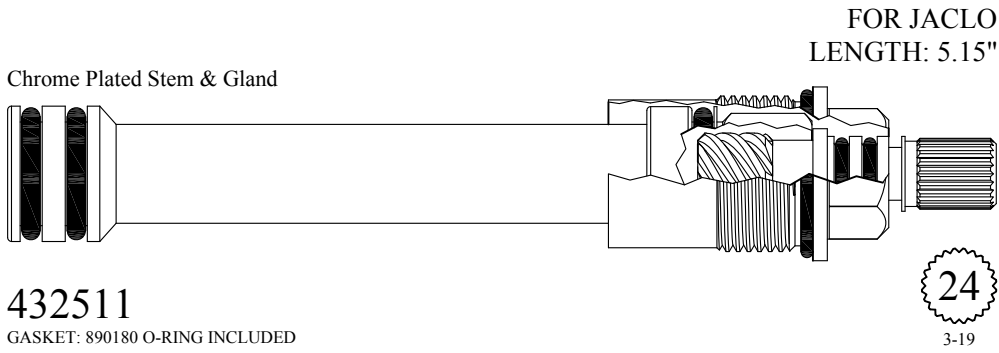



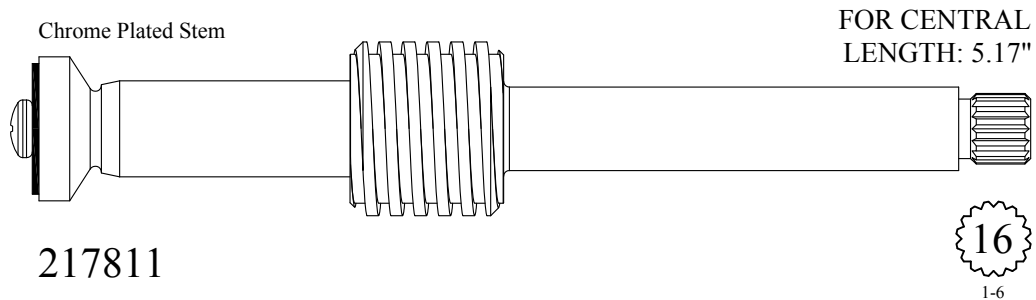
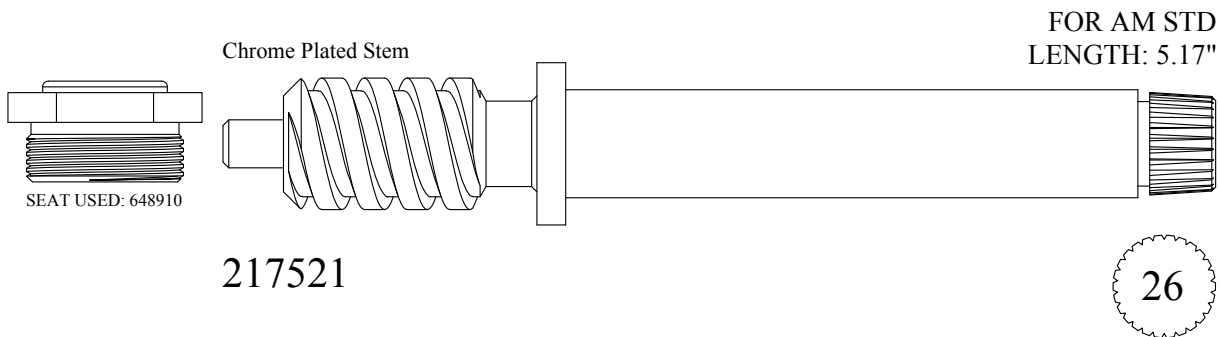
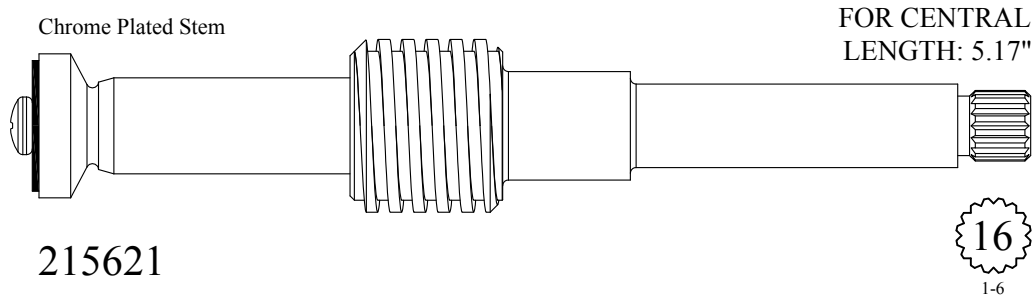
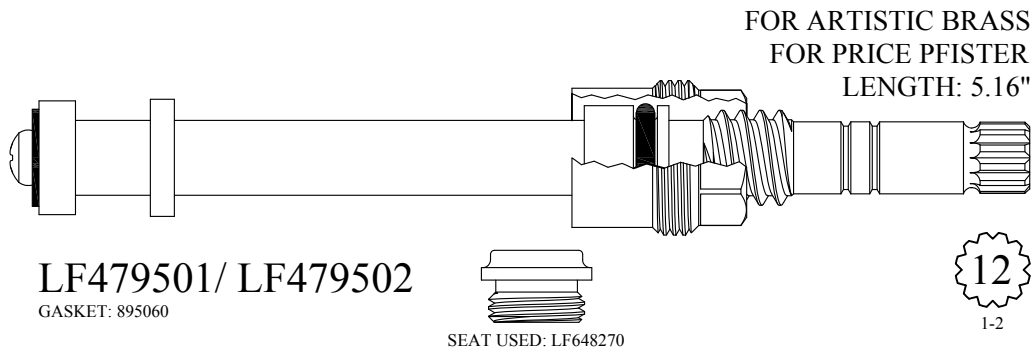

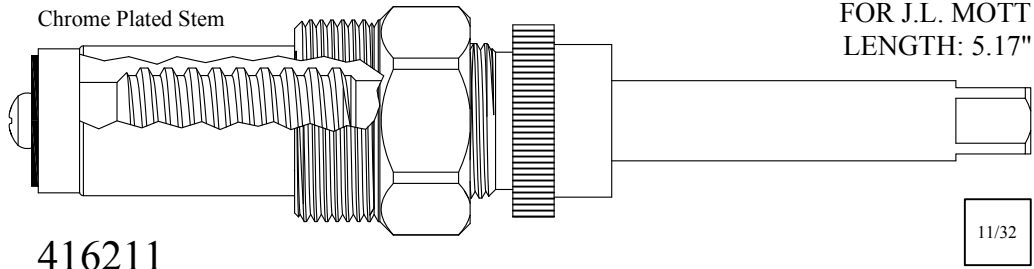

Chrome Plated Stem

FOR J.L. MOTT  
LENGTH: 5.17"

416211  
216211 Stem Only  
GASKET: 895160

11/32

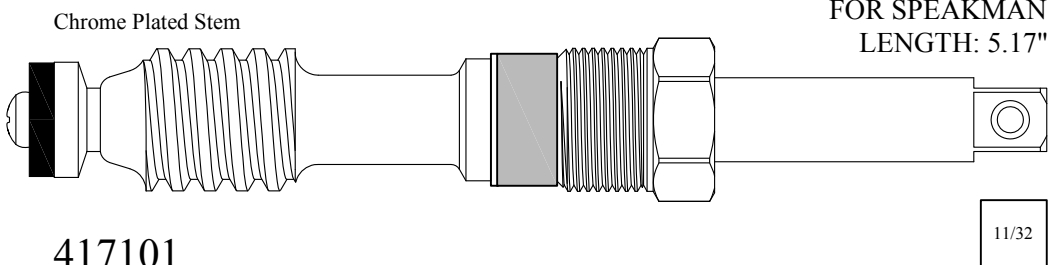

Chrome Plated Stem

FOR SPEAKMAN  
LENGTH: 5.17"

417101  
217101 Stem Only

11/32

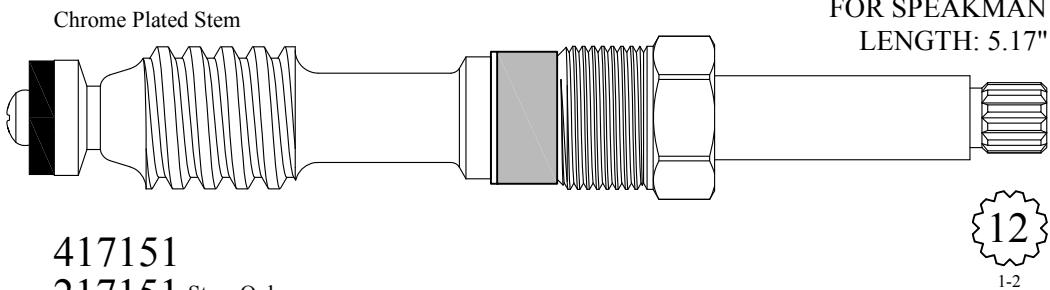

Chrome Plated Stem

FOR SPEAKMAN  
LENGTH: 5.17"

417151  
217151 Stem Only

12  
1-2

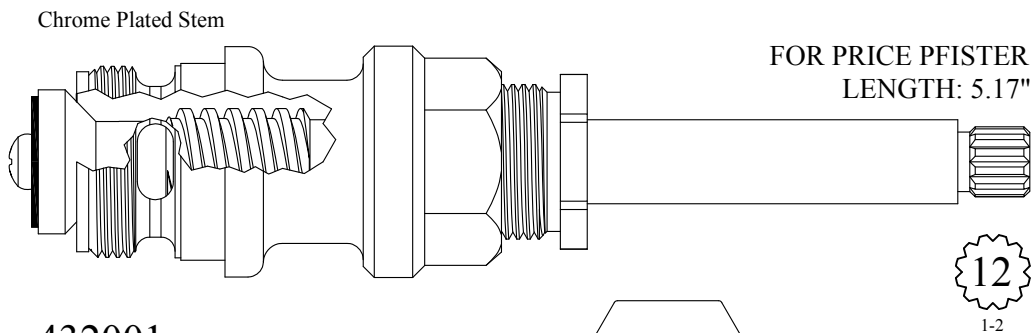

Chrome Plated Stem

FOR PRICE PFISTER  
LENGTH: 5.17"

432001  
232001 Stem Only  
GASKET: 895560

12  
1-2

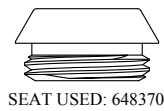

SEAT USED: 648370

Chrome Plated Stem

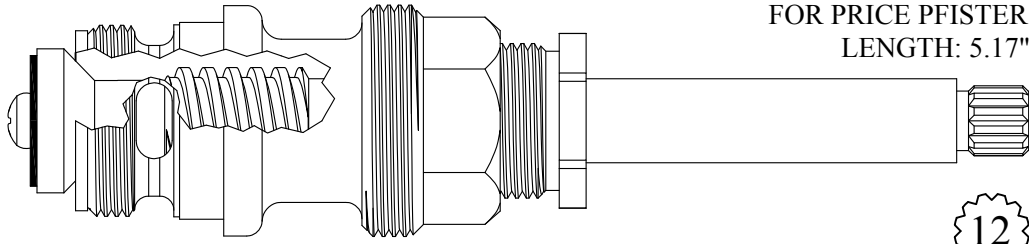

FOR PRICE PFISTER  
LENGTH: 5.17"

432011  
232001 Stem Only  
GASKET: 895560



SEAT USED: 648370



1-2

Chrome Plated Gland

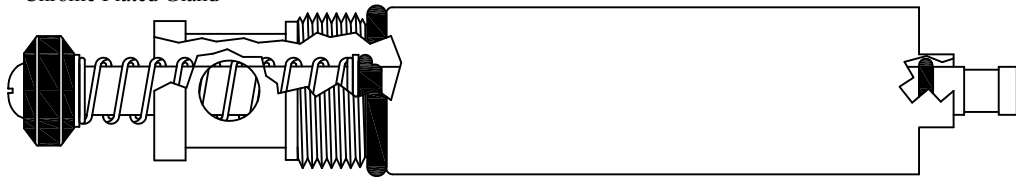

FOR KOHLER  
LENGTH: 5.17"

432810  
GASKET: 891150 O-RING INCLUDED

Chrome Plated Stem

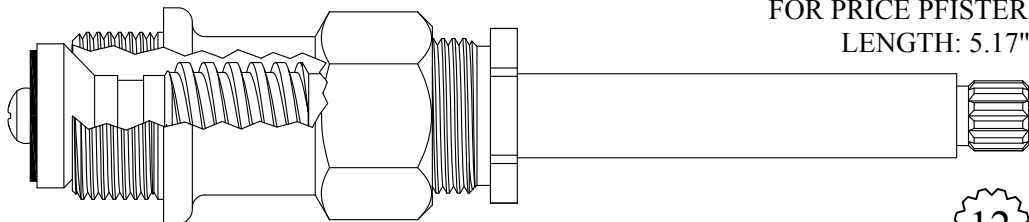

FOR PRICE PFISTER  
LENGTH: 5.17"

415301/ 415302  
215301/ 215302 Stem Only  
GASKET: 895400

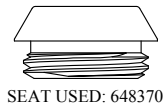

SEAT USED: 648370



1-2

Chrome Plated Stem

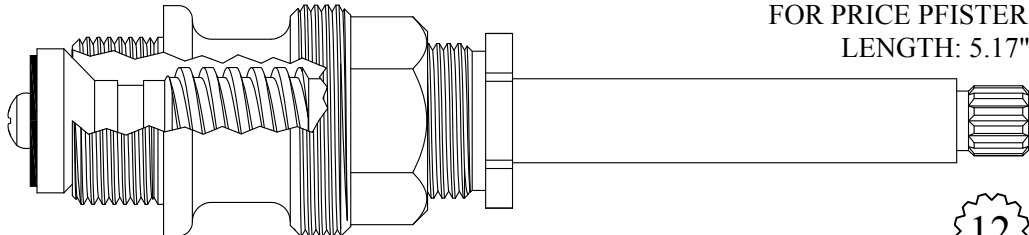

FOR PRICE PFISTER  
LENGTH: 5.17"

415311/ 415312  
215301/ 215302 Stem Only  
GASKET: 895400



SEAT USED: 648370



1-2

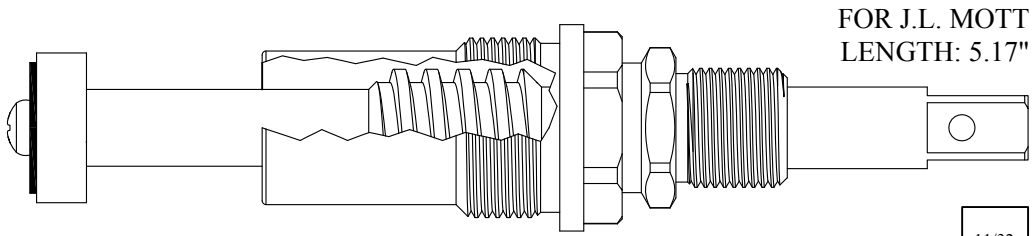

LF479701  
LF279701 Stem Only  
GASKET: 895320

11/32

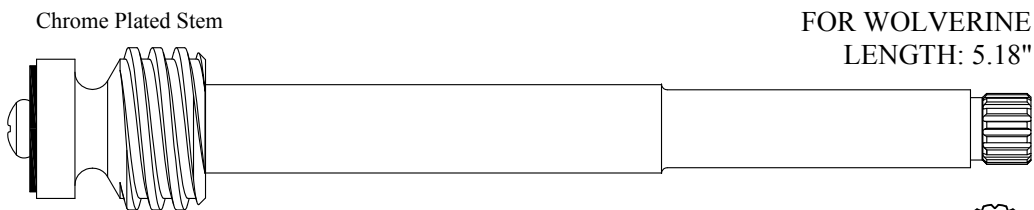

215921

15  
3-27

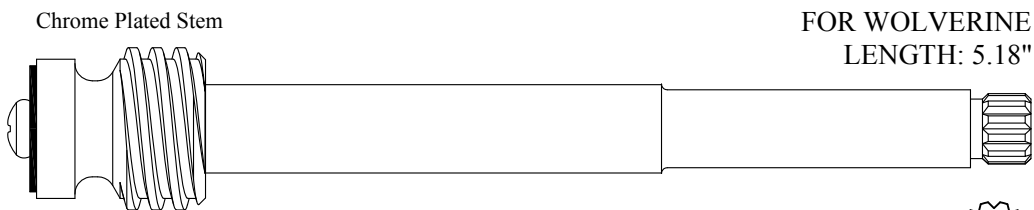

215971

12  
1-2

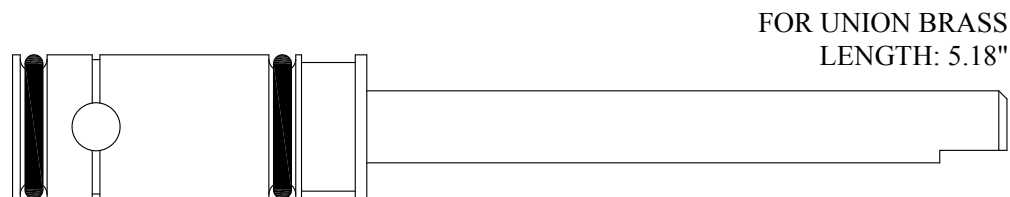

232700



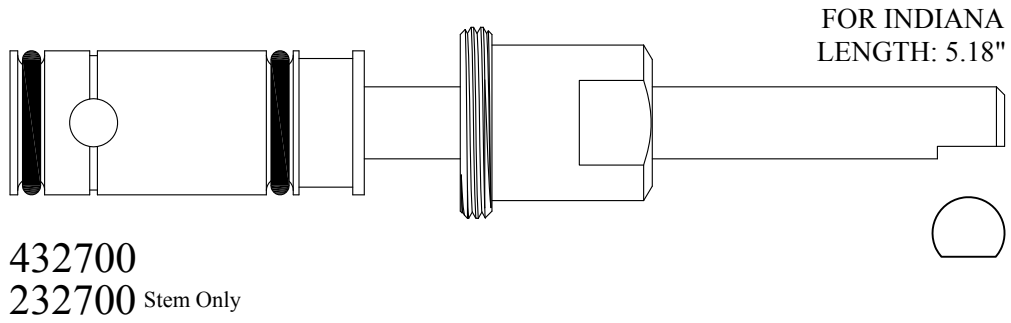

432700  
232700 Stem Only

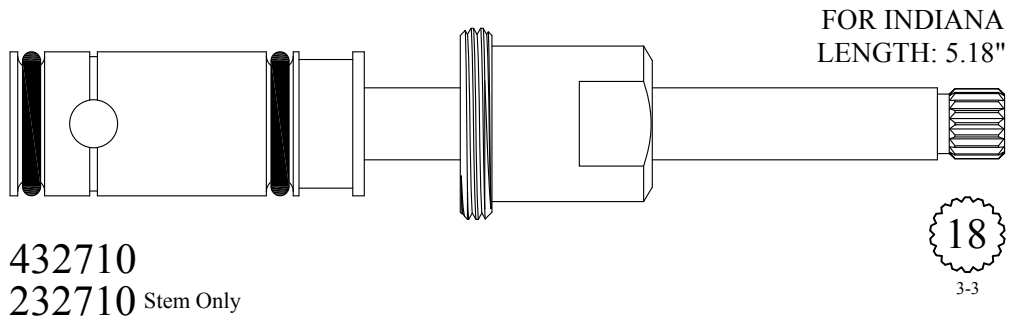

432710  
232710 Stem Only

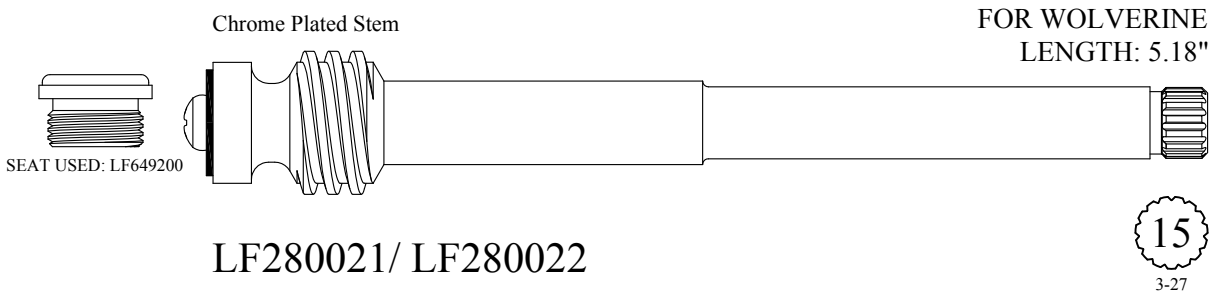

LF280021/ LF280022

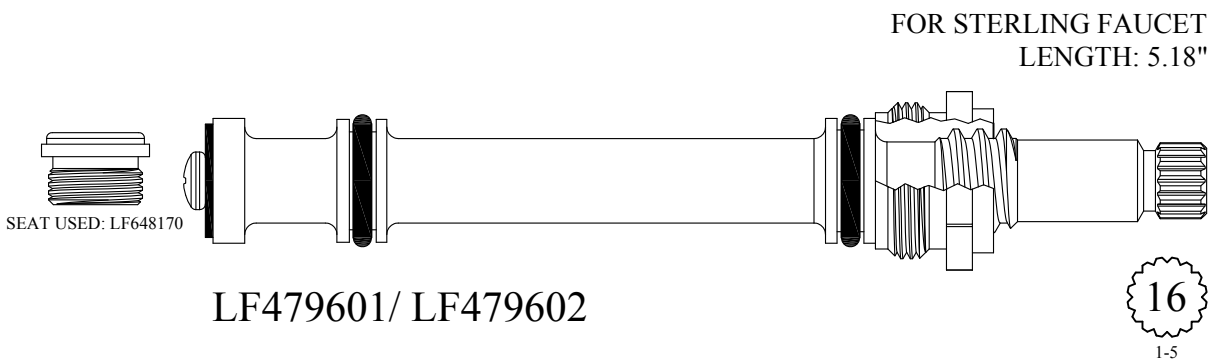

LF479601/ LF479602

Chrome Plated Stem & Sleeve

FOR ACME  
LENGTH: 5.19"

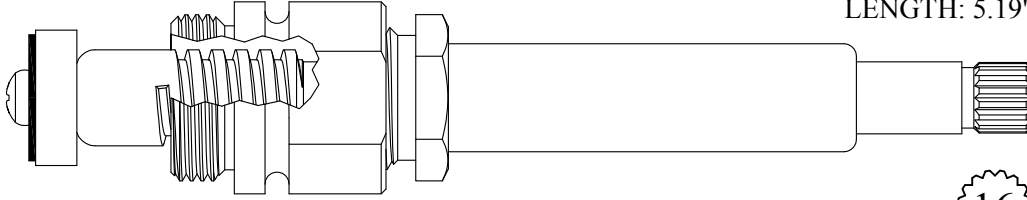

414621  
214621 Stem Only  
GASKET: 895180

16  
1-6

Chrome Plated Stem

FOR CENTRAL  
LENGTH: 5.19"

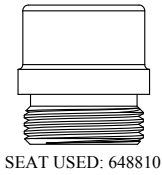

SEAT USED: 648810

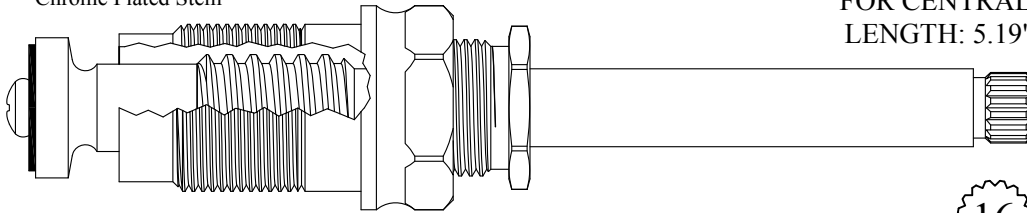

416801  
216801 Stem Only  
GASKET: 895400

16  
1-6

FOR ACME  
LENGTH: 5.19"

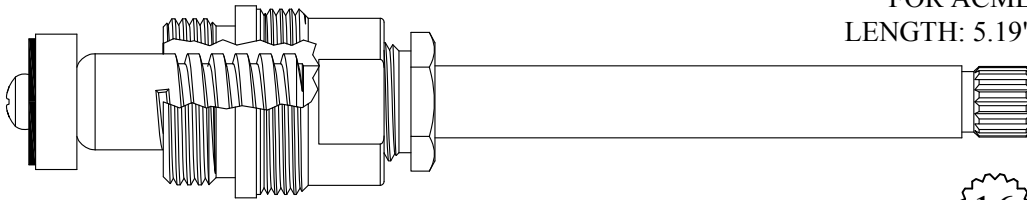

416911  
216911 Stem Only  
GASKET: 895180

16  
1-6

Chrome Plated Stem

FOR STERLING BRASS  
FOR DICK BROS.  
LENGTH: 5.19"

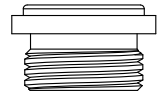

SEAT USED: LF649010

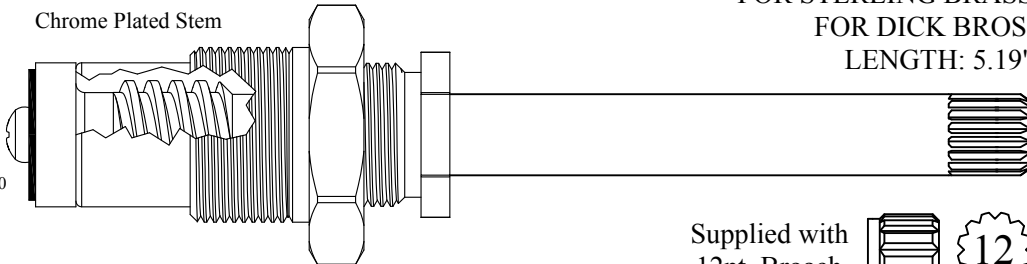

Supplied with  
12pt. Broach

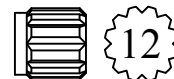

416951/ 416952  
GASKET: 895370

12  
1-2

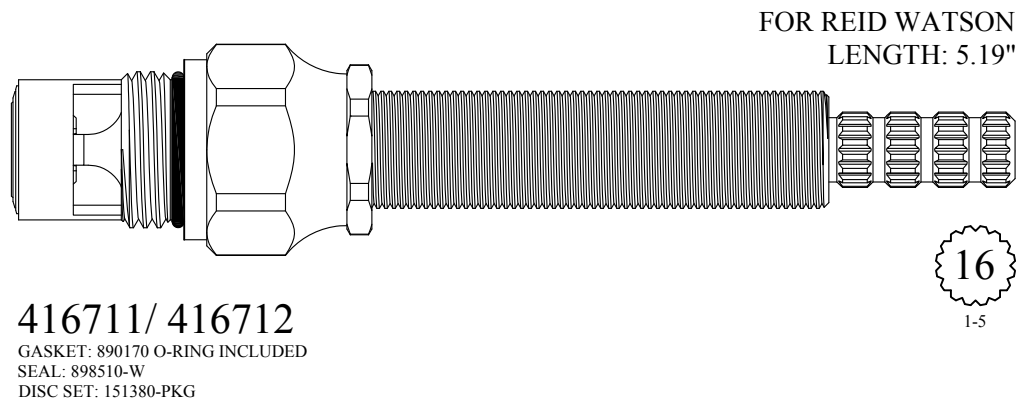
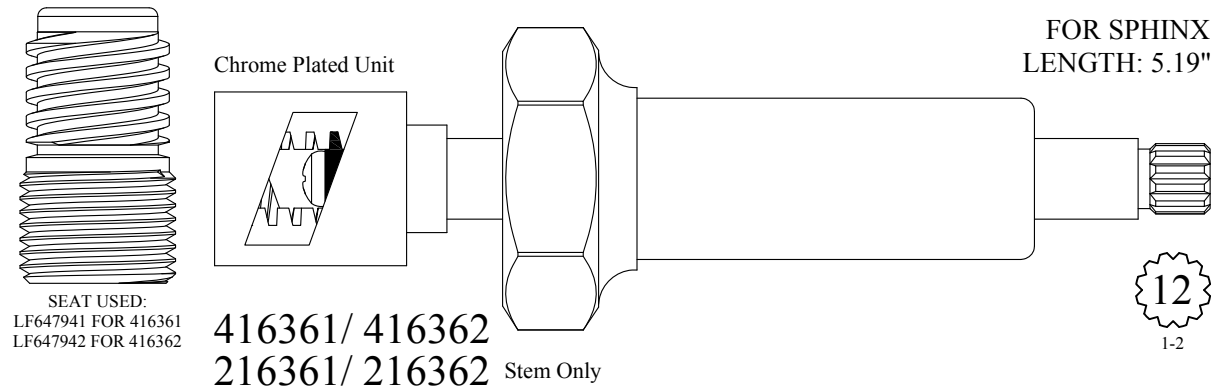
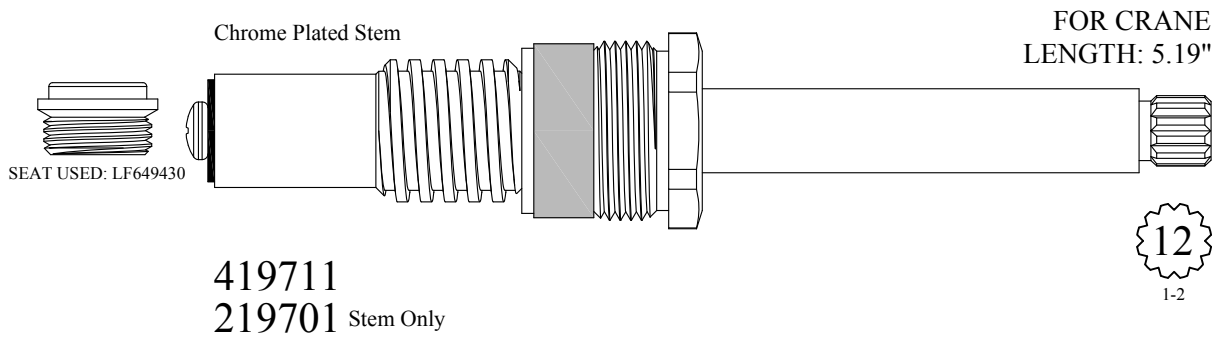
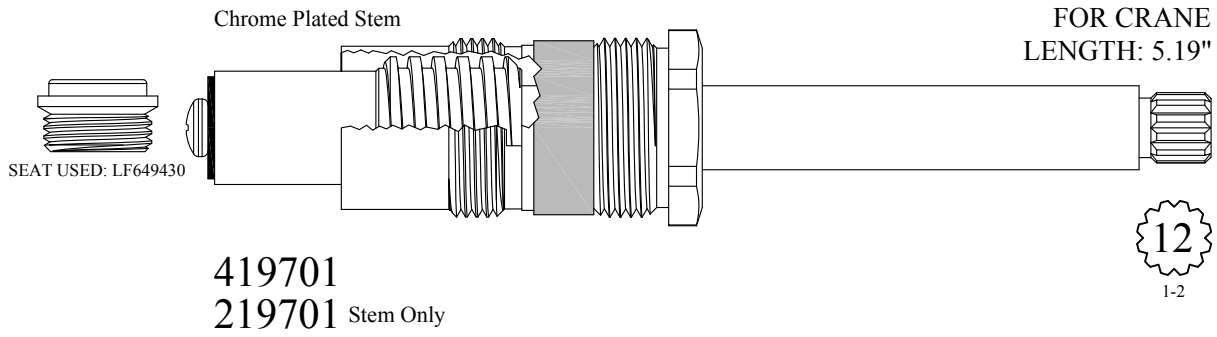

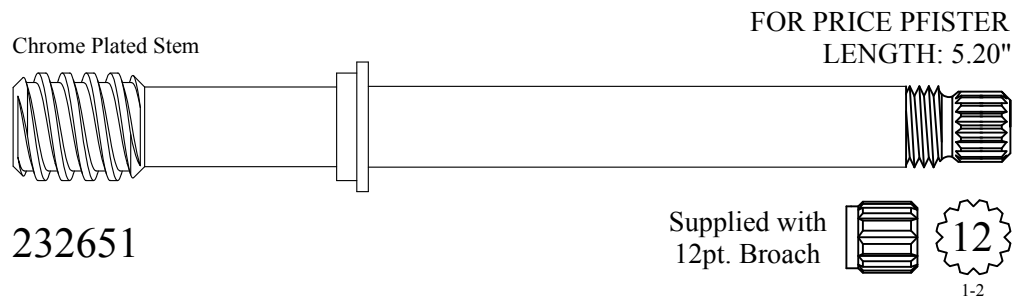
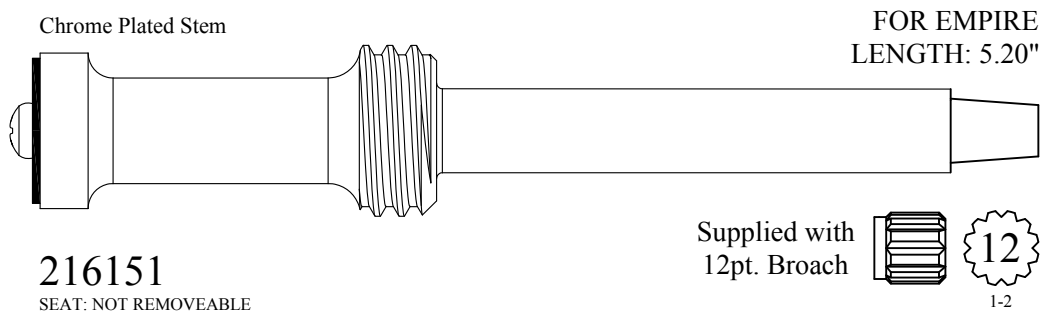
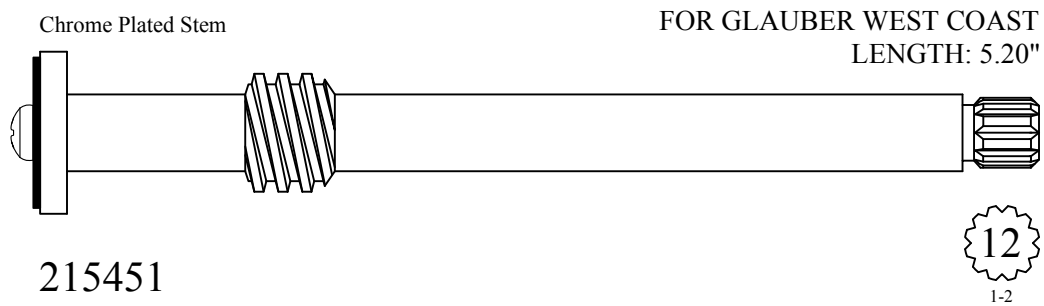
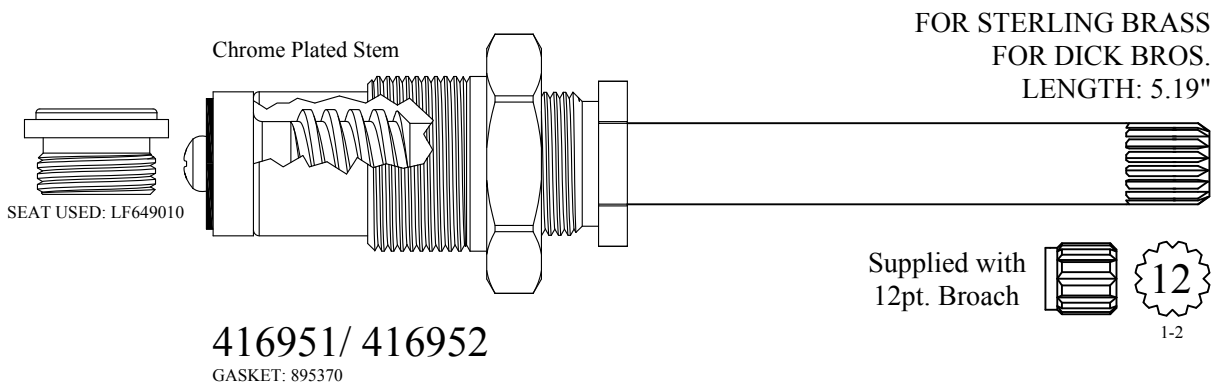



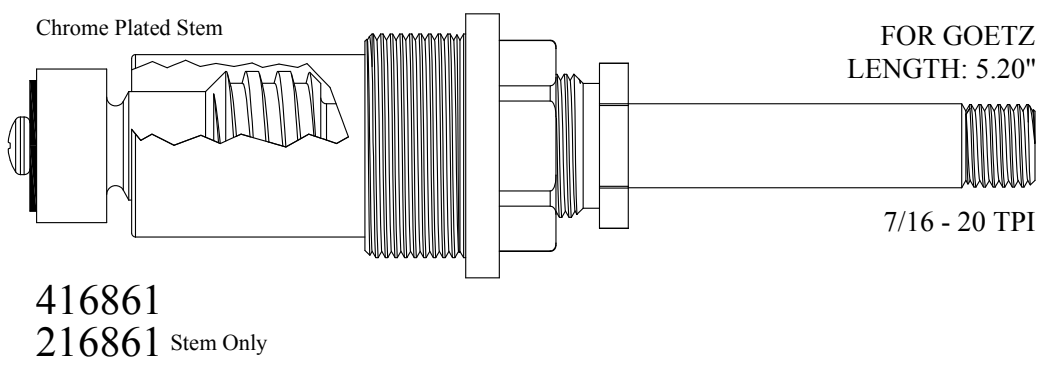
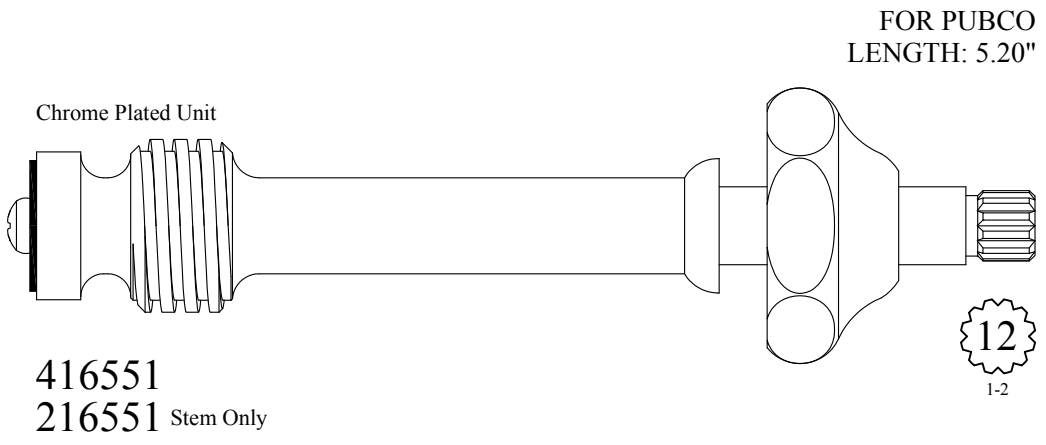
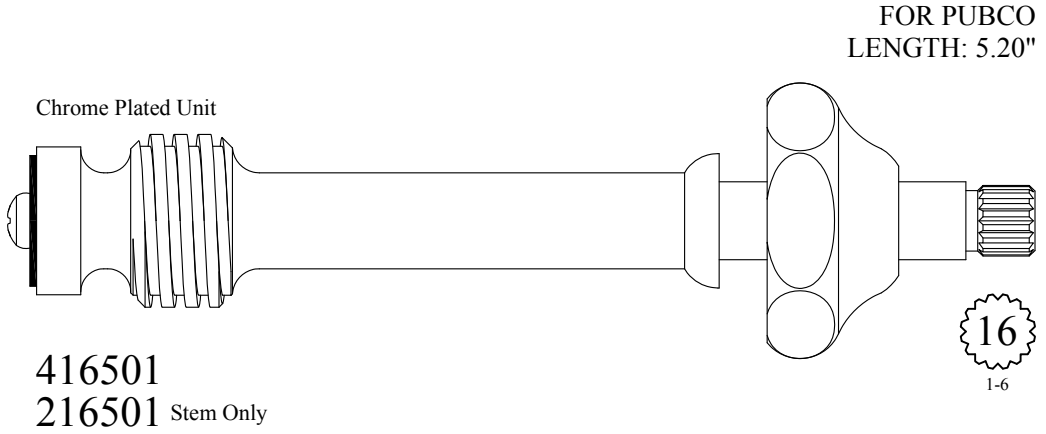
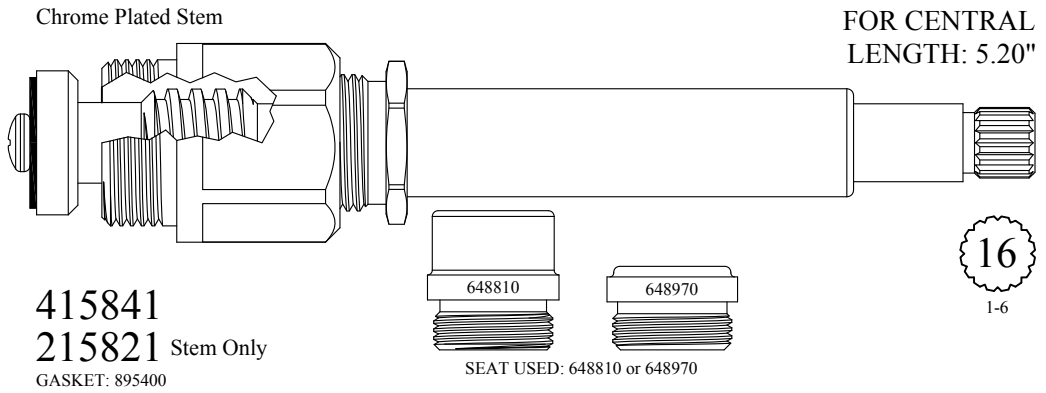

Also available with chrome plated stem

415831/ 415832

215821/ 215822 Stem Only

FOR CENTRAL  
LENGTH: 5.20"

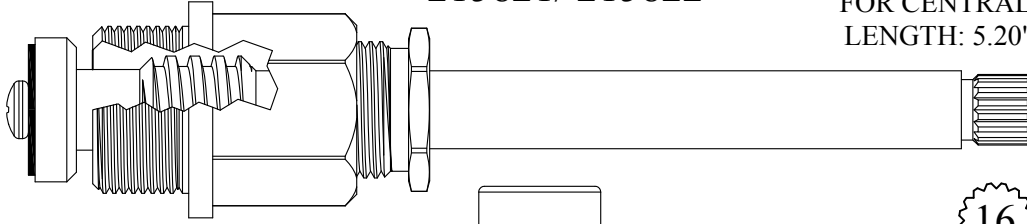

16  
1-6

415801/ 415802

215801/ 215802 Stem Only

GASKET: 895400

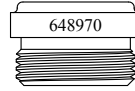
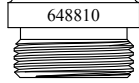

SEAT USED: 648810 or 648970

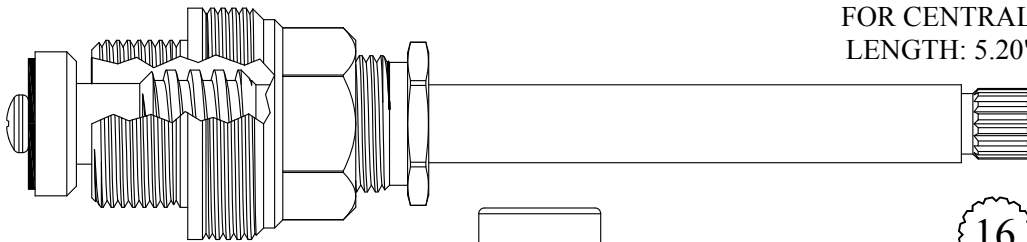

FOR CENTRAL  
LENGTH: 5.20"

16  
1-6

415811/ 415812

215801/ 215802 Stem Only

GASKET: 895400

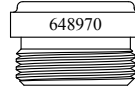

SEAT USED: 648810 or 648970

Chrome Plated Stem

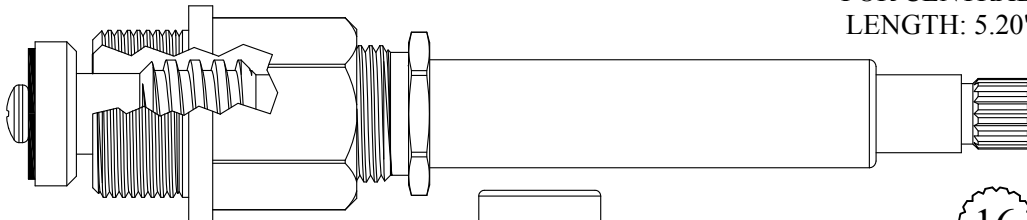

FOR CENTRAL  
LENGTH: 5.20"

16  
1-6

415821/ 415822

215821/ 215822 Stem Only

GASKET: 895400

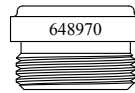

SEAT USED: 648810 or 648970

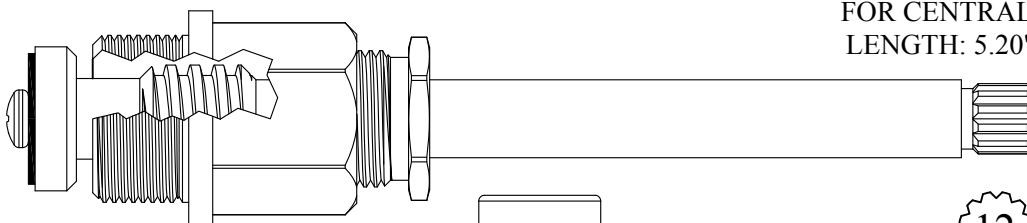

FOR CENTRAL  
LENGTH: 5.20"

12  
1-2

415851/ 415852

215851/ 215852 Stem Only

GASKET: 895400

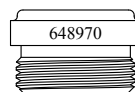

SEAT USED: 648810 or 648970

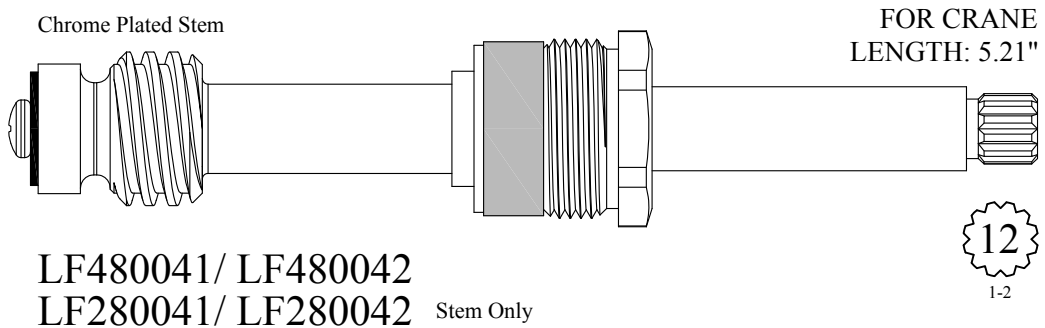
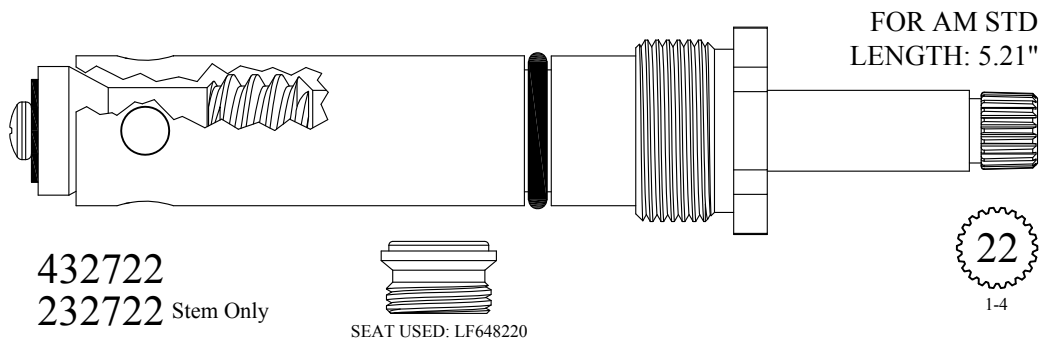
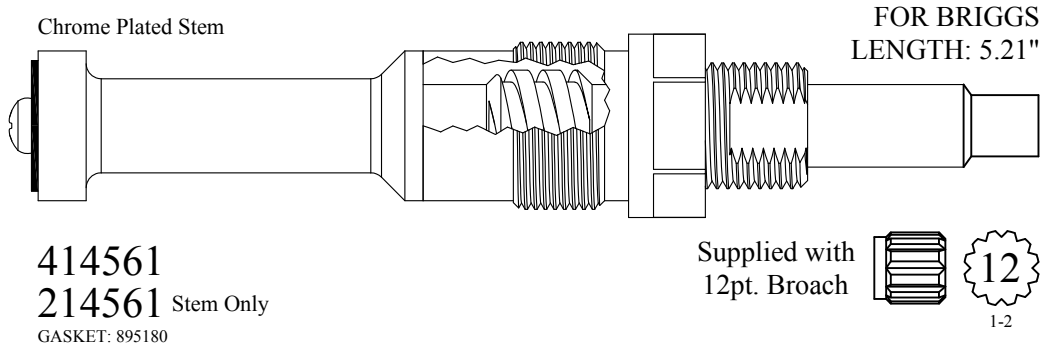
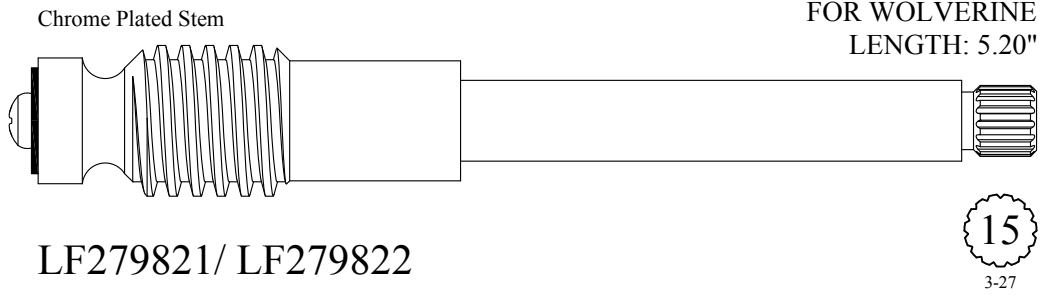

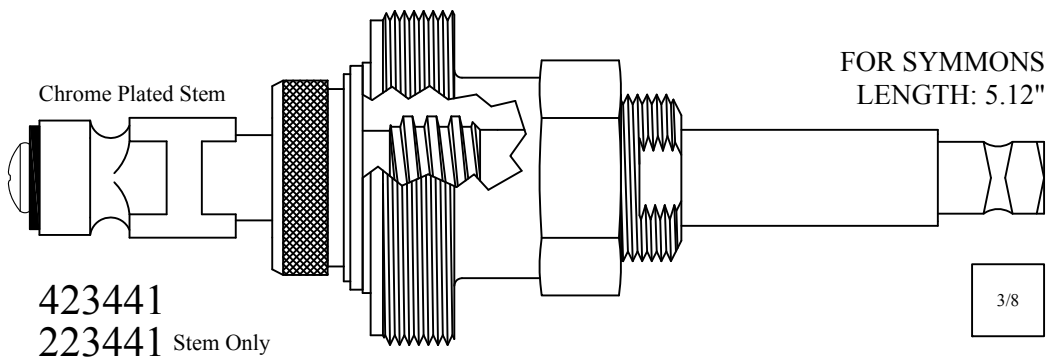
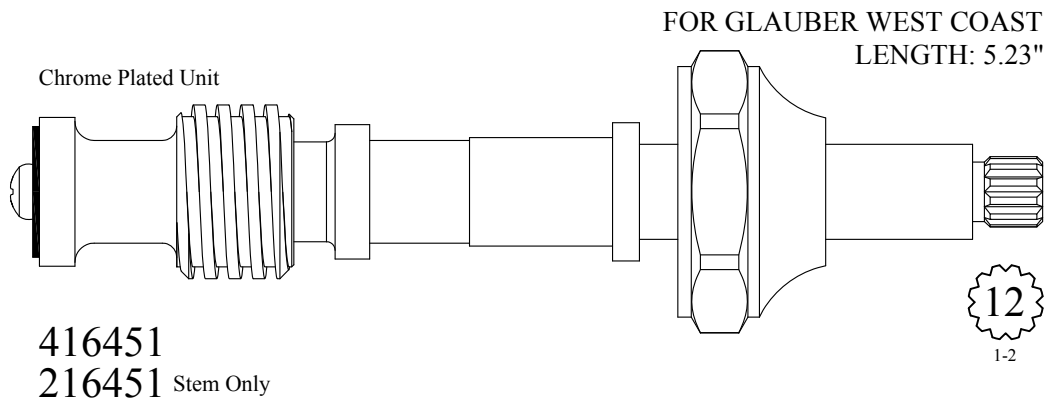
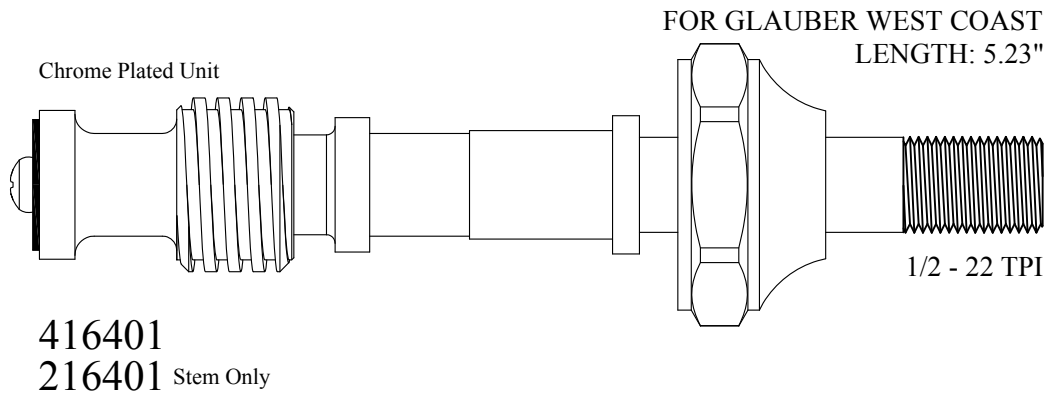
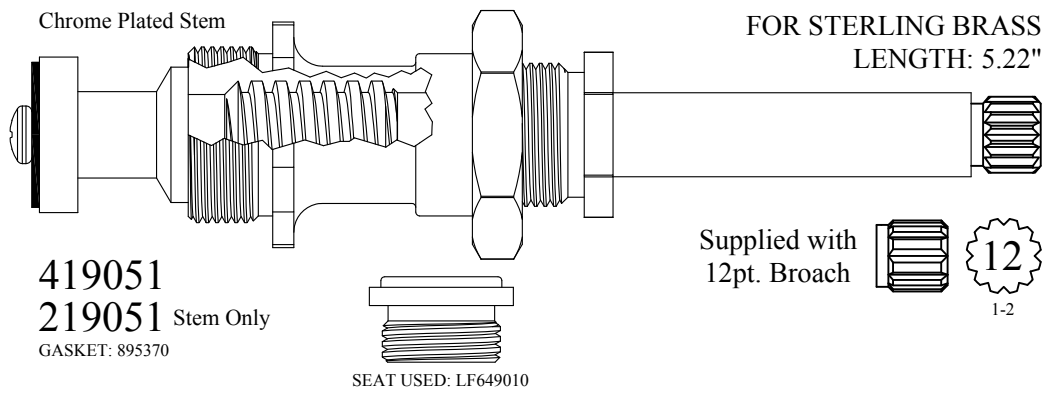

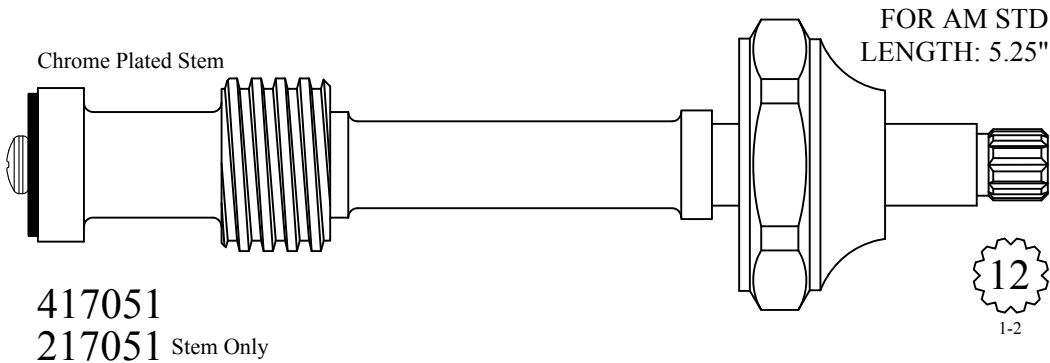
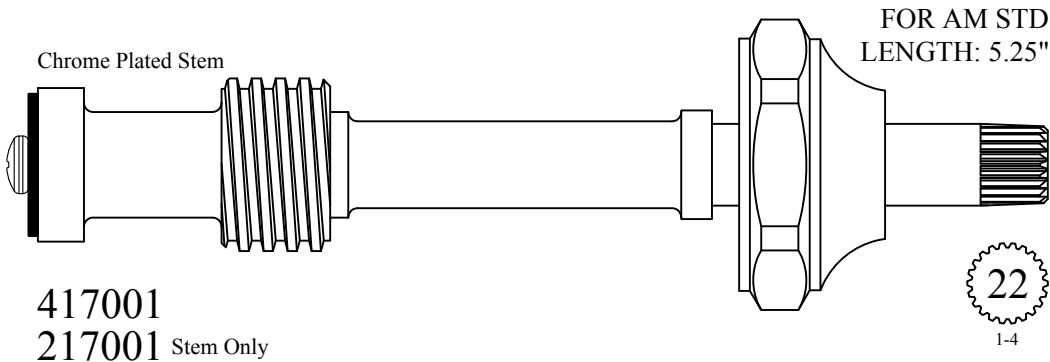
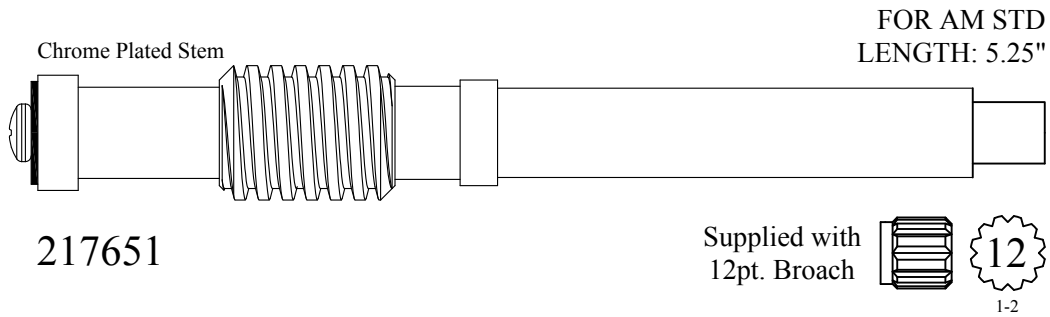
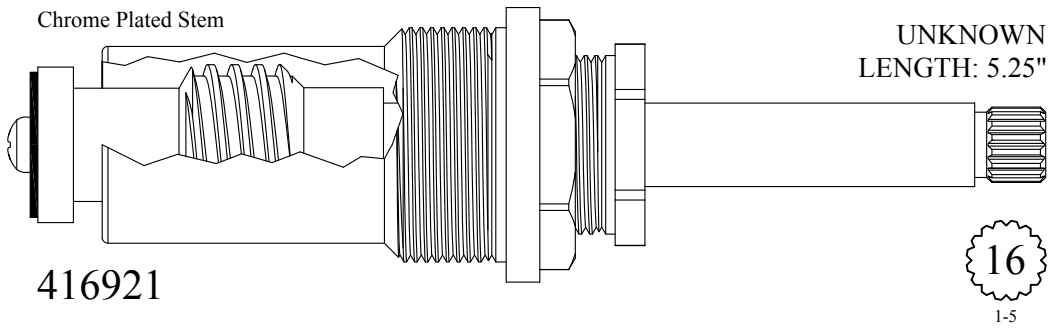
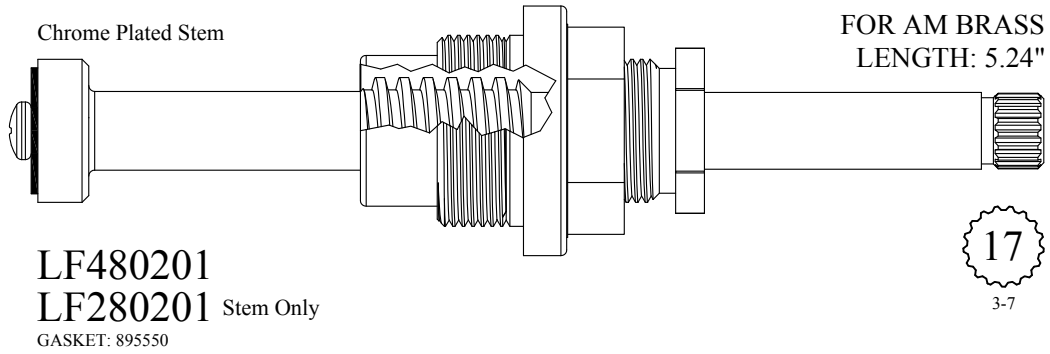

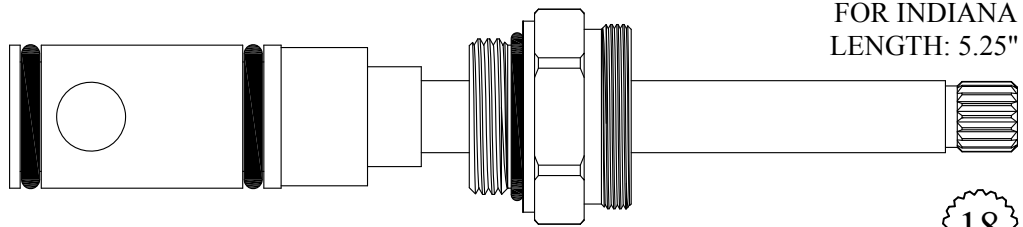

FOR INDIANA  
LENGTH: 5.25"

18  
3-3

432730  
232730 Stem Only  
GASKET: 890180 O-RING INCLUDED

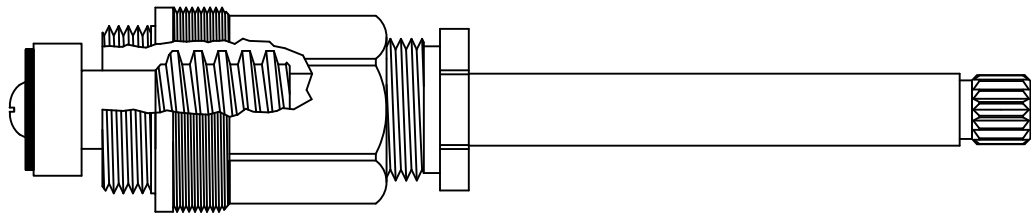

Old Style, Use 413301 or 413301-CP

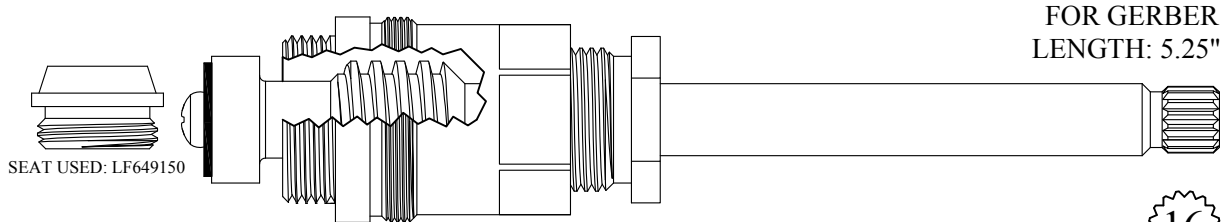

FOR GERBER  
LENGTH: 5.25"

SEAT USED: LF649150

16  
2-3

413301/ 413302  
213301/ 213302 Stem Only  
GASKET: 895400

Also available with chrome plated stem

413301-CP

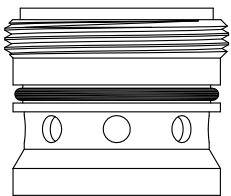

SEAT KIT USED: 106090

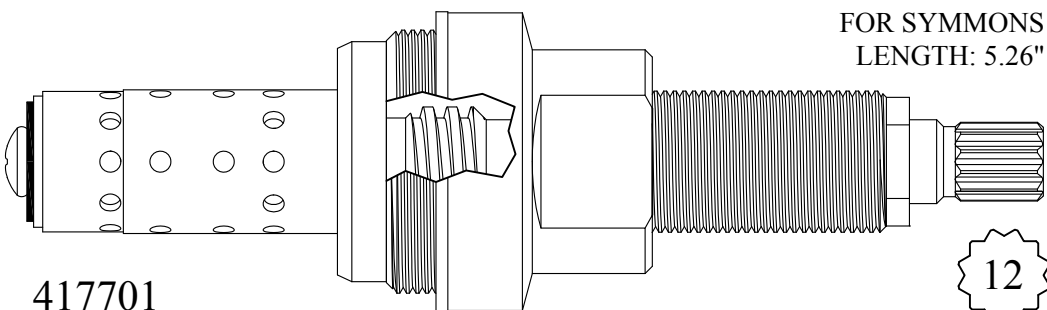

FOR SYMMONS  
LENGTH: 5.26"

12

Symmons Large

417701  
217701 Stem Only  
GASKET: 895500 INCLUDED

Nickel Plated Stem

FOR CHICAGO  
LENGTH: 5.26"

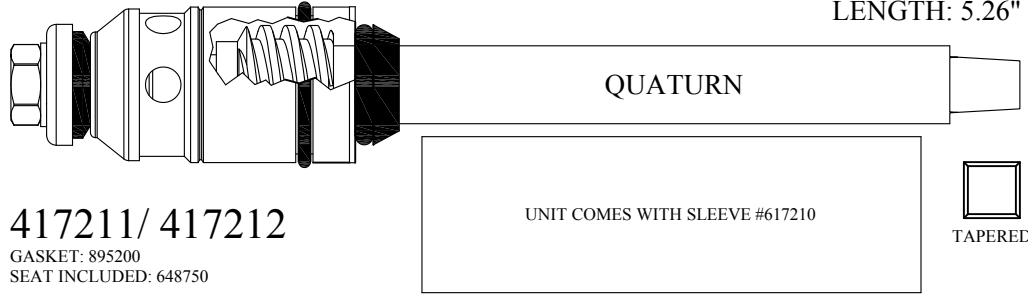

417211/ 417212

GASKET: 895200  
SEAT INCLUDED: 648750

Chrome Plated Stem

FOR ENTERPRISE  
LENGTH: 5.27"

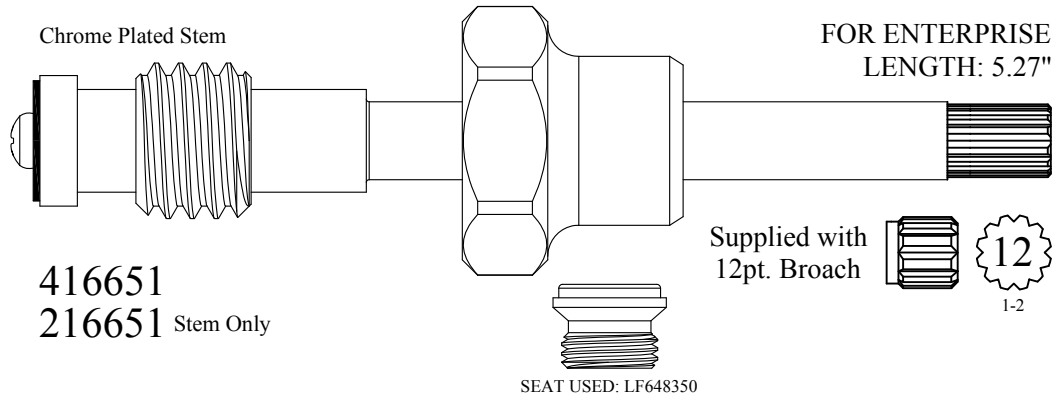

416651

216651 Stem Only

Chrome Plated Stem  
18 TPI Gland

FOR UNION BRASS  
LENGTH: 5.27"

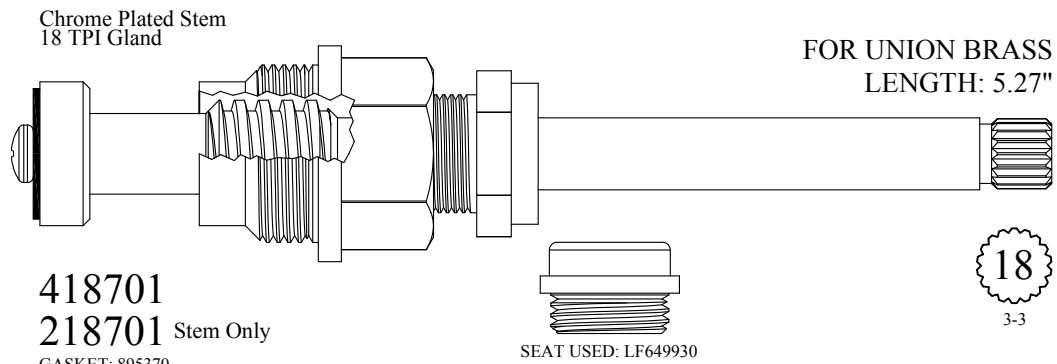

418701

218701 Stem Only

GASKET: 895370

Chrome Plated Stem  
20 TPI Gland

FOR UNION BRASS  
LENGTH: 5.27"

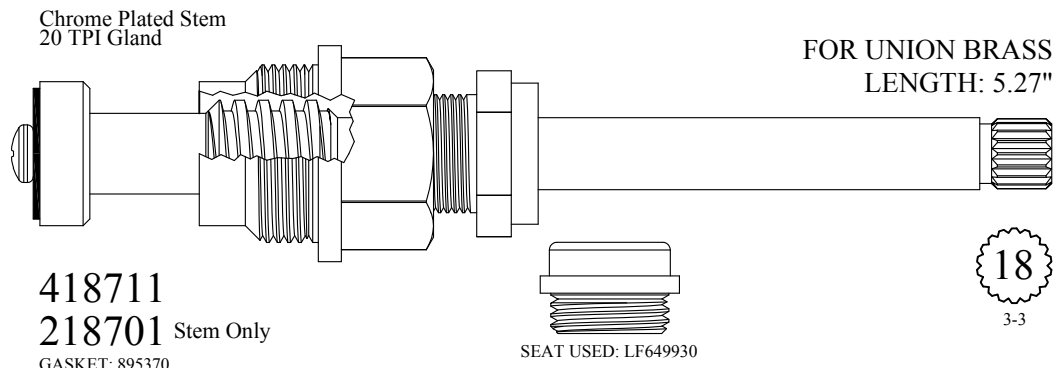

418711

218701 Stem Only

GASKET: 895370

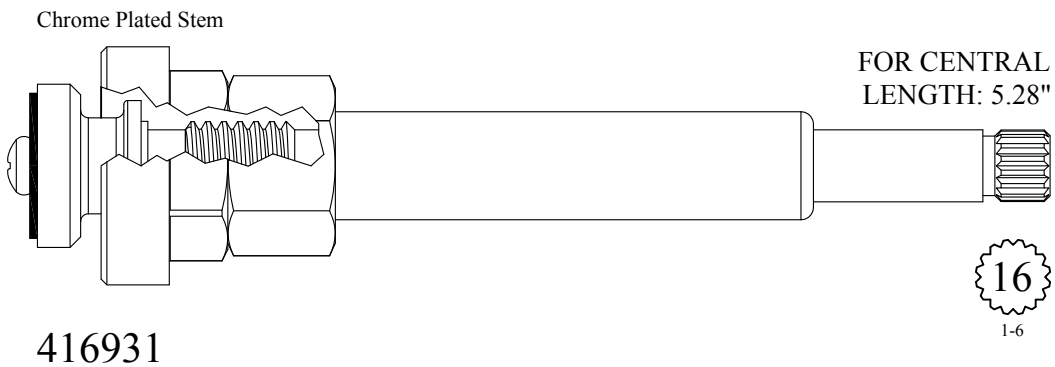
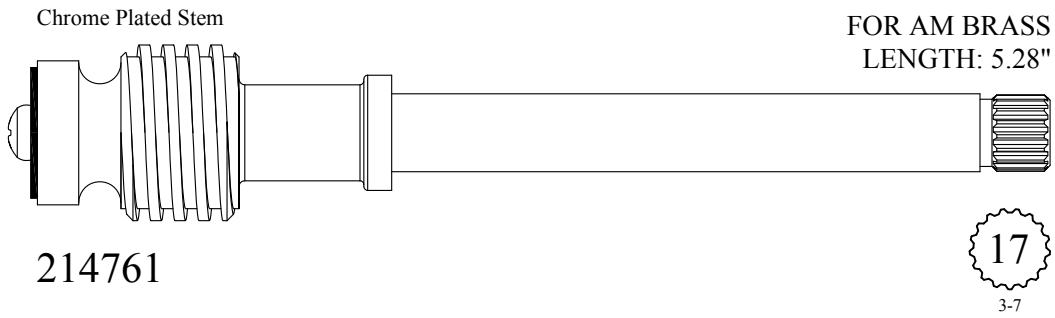
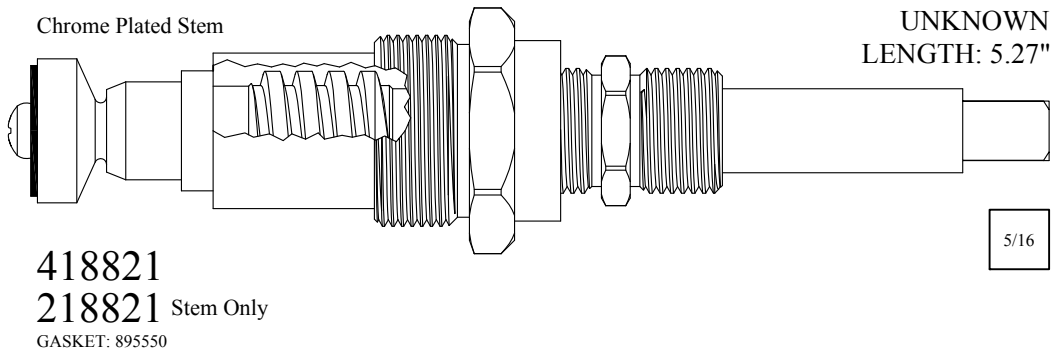
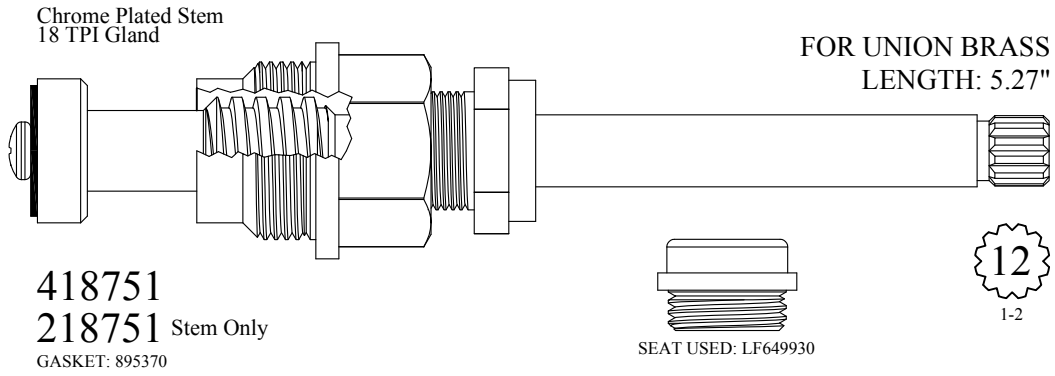



FOR SEARS  
FOR FEDERAL HUBER  
LENGTH: 5.28"

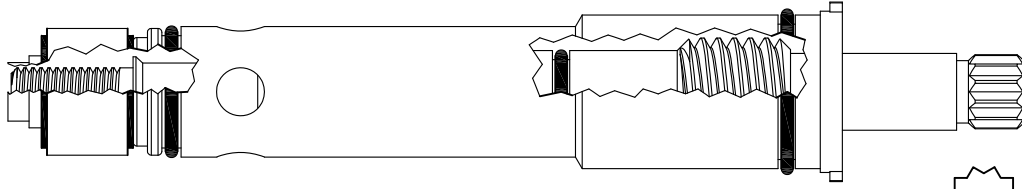

432901

12  
3-10

FOR ELJER  
LENGTH 5.28"

Plastic Plunger End

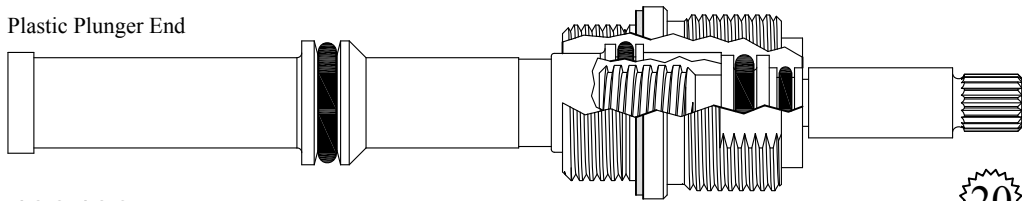

433432

GASKET: 895160 INCLUDED

20  
3-20

Nickel Plated Stem

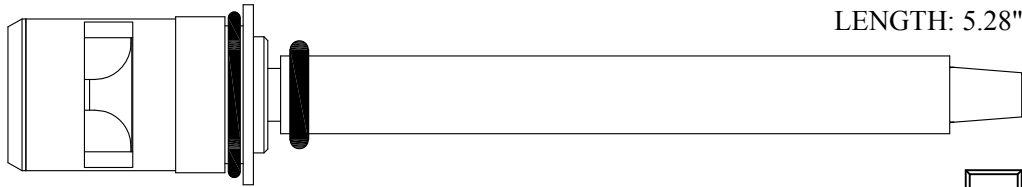

FOR CHICAGO  
LENGTH: 5.28"

LF475411/ LF475412

GASKET: 890170 O-RING INCLUDED  
SEAL: 898590  
DISC SET: 151380-PKG

TAPERED

Chrome Plated Stem

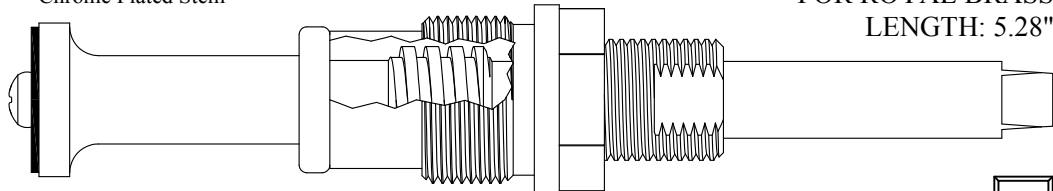

FOR ROYAL BRASS  
LENGTH: 5.28"

LF479901  
LF279901 Stem Only

5/16  
TAPERED

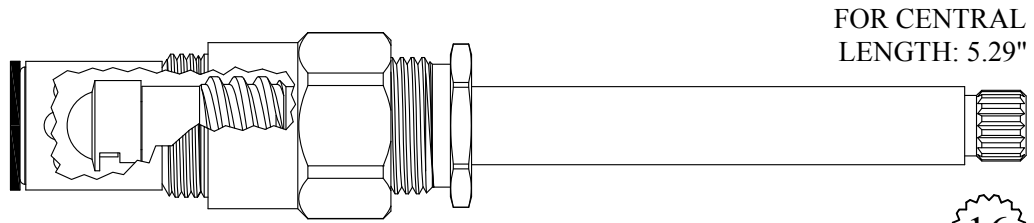

**411021**  
GASKET: 895100

**16**  
1-6

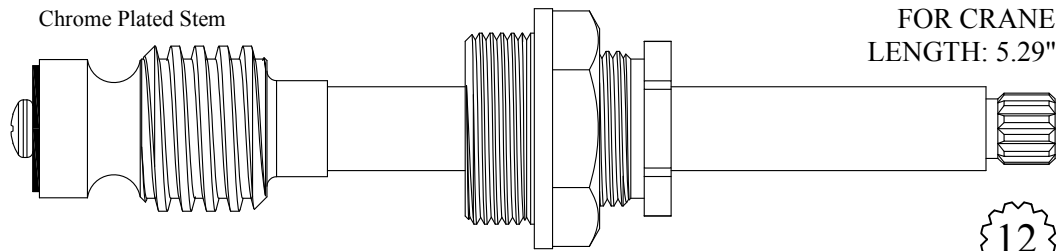

**417201**  
**217201** Stem Only  
GASKET: 895560

**12**  
1-2

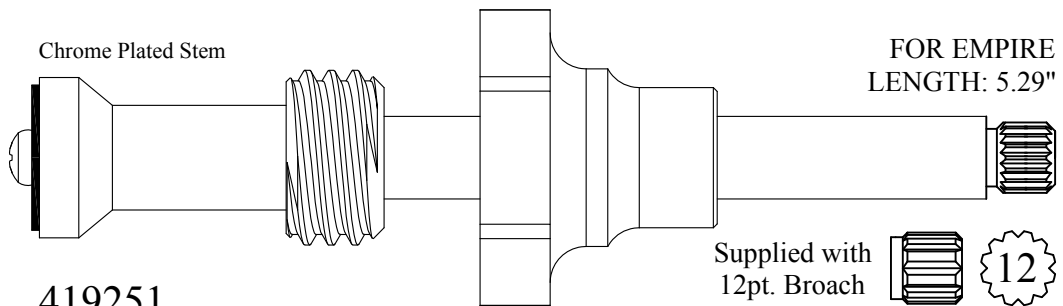

**419251**  
**219251** Stem Only

Supplied with  
12pt. Broach  **12**  
1-2

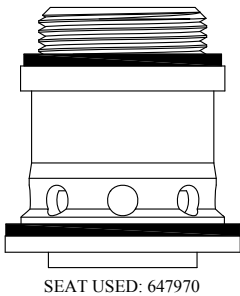

SEAT USED: 647970

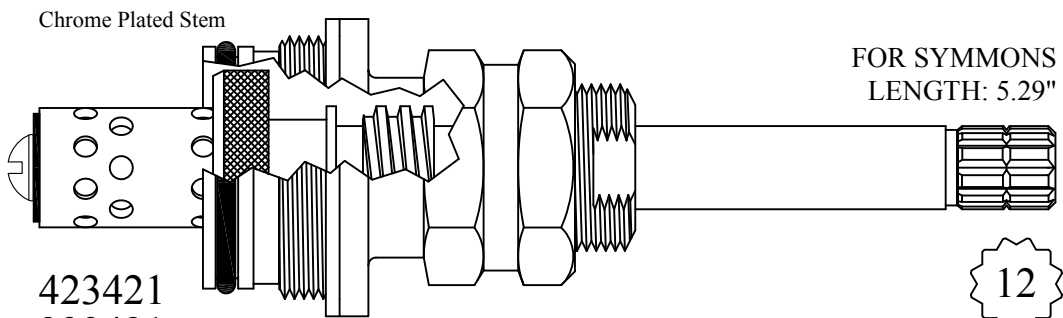

**423421**  
**223421** Stem Only  
GASKET: 895500 INCLUDED

**12**  
Symmons Large

FOR KOHLER  
LENGTH: 5.34"

Chrome Escutcheon Tube

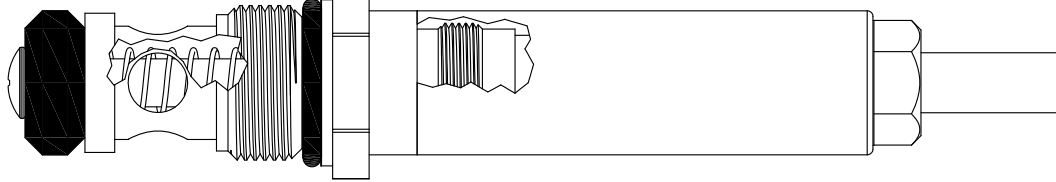

**432910**

GASKET: 891150 O-RING INCLUDED

FOR AM STD  
LENGTH: 5.30"

Chrome Plated Stem

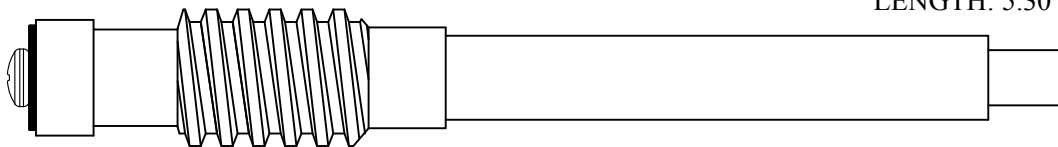

**225151**

Supplied with  
12pt. Broach



**12**

1-2

FOR MILWAUKEE  
LENGTH: 5.30"

Chrome Plated Stem

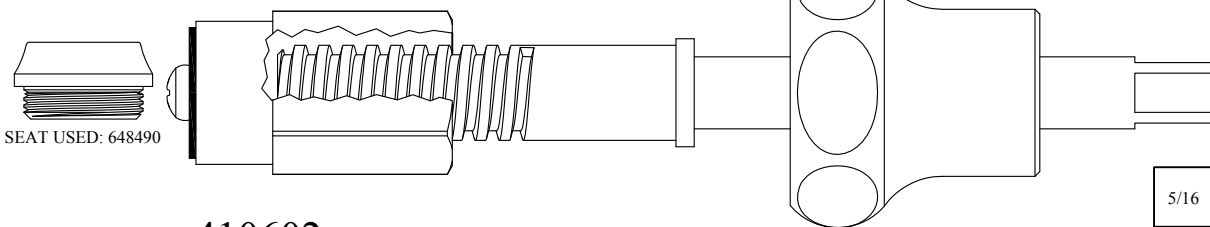

SEAT USED: 648490

**410602**

**210602** Stem Only

GASKET: 894960 INCLUDED

5/16

FOR MILWAUKEE  
LENGTH: 5.30"

Chrome Plated Stem

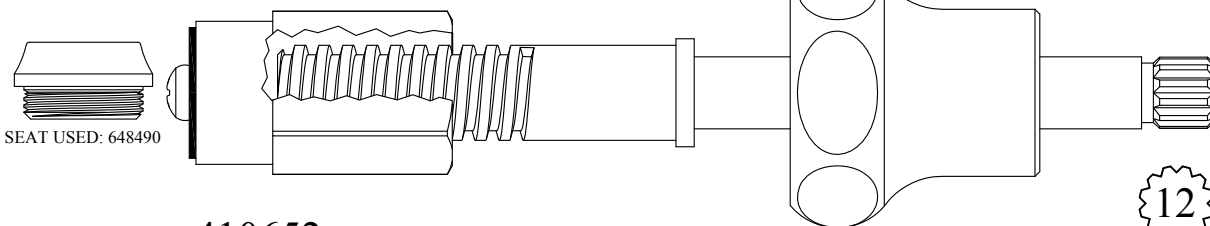

SEAT USED: 648490

**410652**

**210652** Stem Only

GASKET: 894960 INCLUDED

**12**

1-2

FOR NFC / AMERICAN FAUCETS  
 LENGTH: 5.30"

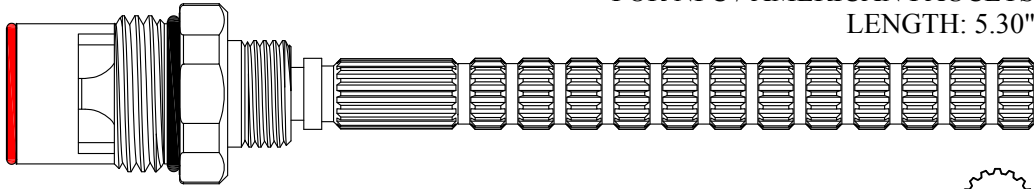

**417221/ 417222**  
 GASKET: 890170 O-RING INCLUDED  
 SEAL: 898580-R/B  
 DISC SET: 151380-PKG

16  
 3-16

Chrome Plated Stem

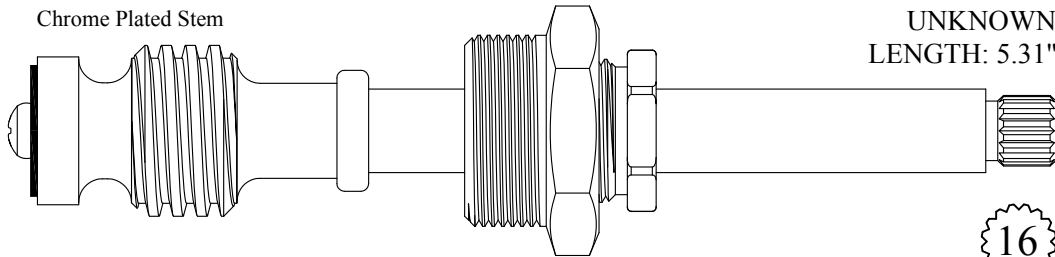

UNKNOWN  
 LENGTH: 5.31"

**418121**  
**218121** Stem Only  
 GASKET: 895550

16  
 1-6

Chrome Plated Stem

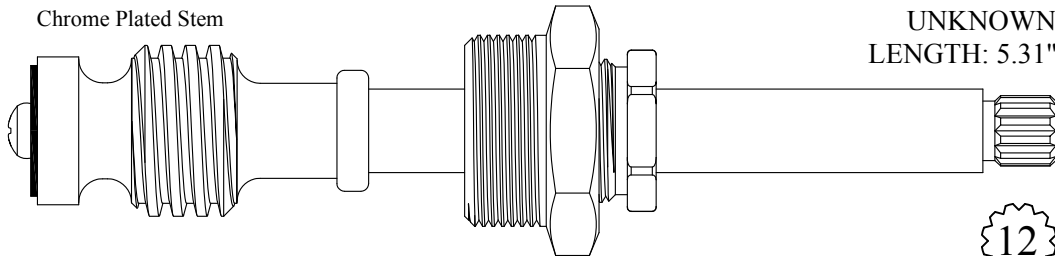

UNKNOWN  
 LENGTH: 5.31"

**418171**  
**218171** Stem Only  
 GASKET: 895340

12  
 1-2

Chrome Plated Stem

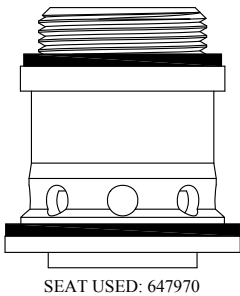

SEAT USED: 647970

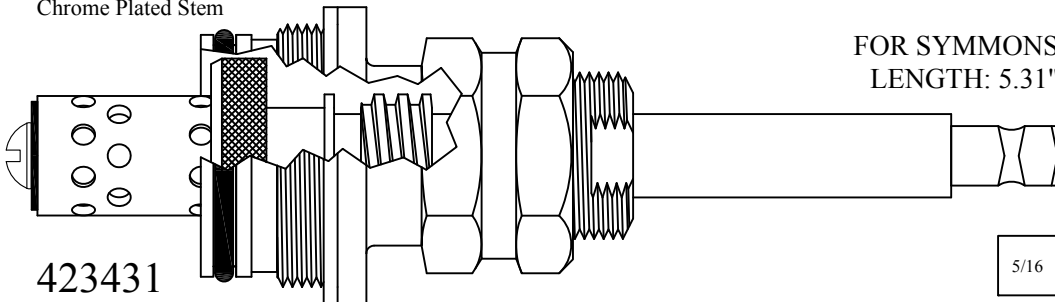

FOR SYMONS  
 LENGTH: 5.31"

**423431**  
**223431** Stem Only  
 GASKET: 895500 INCLUDED

5/16

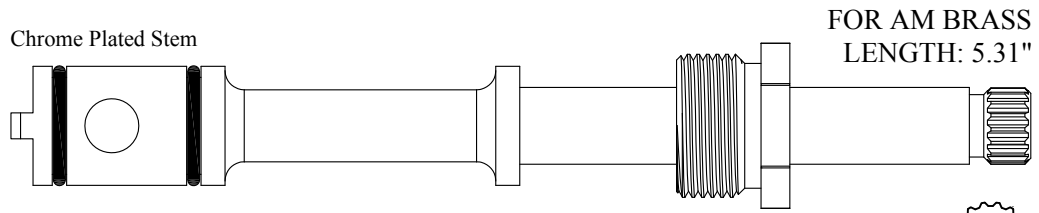

432800  
232800 Stem Only

17  
3-7

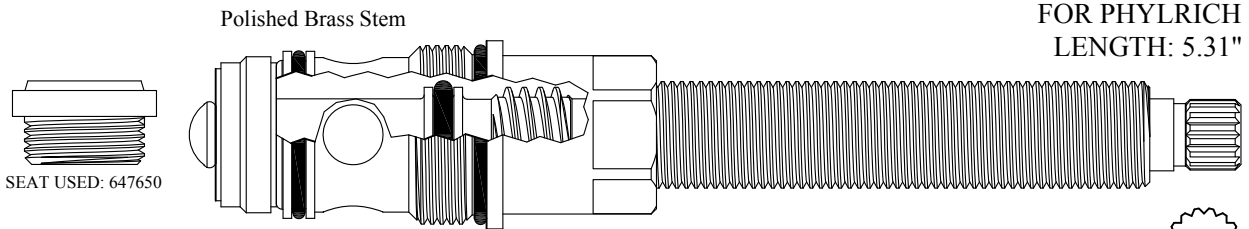

433361  
GASKET: 890190 O-RING INCLUDED

Also available with chrome plated stem  
433361-CP

16  
1-6

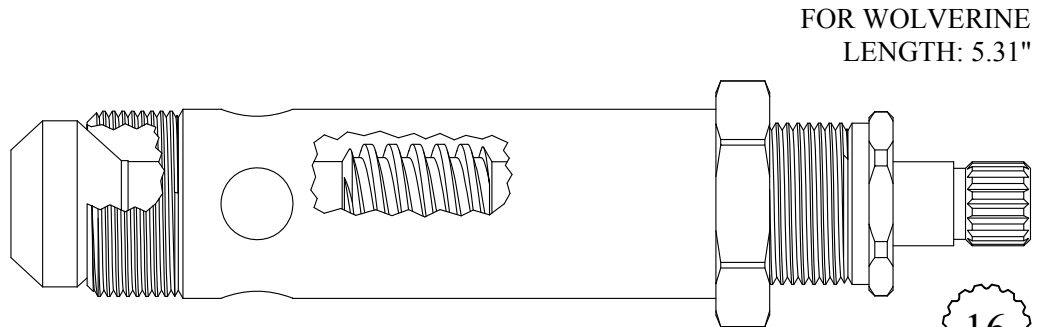

433381  
233381 Stem Only  
GASKET: 895550

16  
3-26

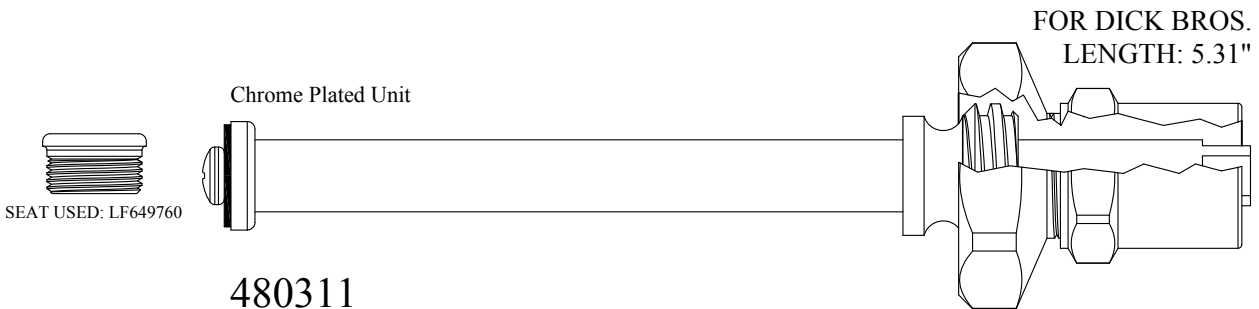

480311  
280311 Stem Only  
GASKET: 895400 INCLUDED

5/16

Chrome Plated Stem

FOR AM STD  
STEM LENGTH: 5.31"

USES BARREL:  
LF647021/LF647022

418001/ 418002  
218001/ 218002 Stem Only  
GASKET: 818000

Also available less barrel  
199651/ 199652

22  
1-4

Chrome Plated Stem

FOR AM STD  
STEM LENGTH: 5.31"

USES BARREL:  
LF647021/LF647022

418011/ 418012  
218001/ 218002 Stem Only  
GASKET: 818000

22  
1-4

Chrome Plated Stem

FOR AM STD  
STEM LENGTH: 5.31"

USES BARREL:  
LF647021/LF647022

418021/ 418022  
218021/ 218022 Stem Only  
GASKET: 818010

3/8" Shank

20  
3-14

Chrome Plated Stem

FOR AM STD  
STEM LENGTH: 5.31"

USES BARREL:  
LF647021/LF647022

418031/ 418032  
218001/ 218002 Stem Only  
GASKET: 818010

22  
1-4

USES BARREL:  
LF647021/LF647022

Chrome Plated Stem

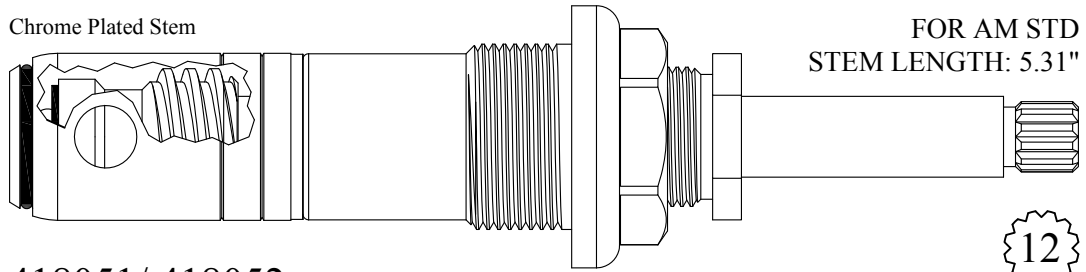

FOR AM STD  
STEM LENGTH: 5.31"

418051/ 418052  
218051/ 218052 Stem Only  
GASKET: 818000

12  
1-2

USES BARREL:  
LF647021/LF647022

Chrome Plated Stem

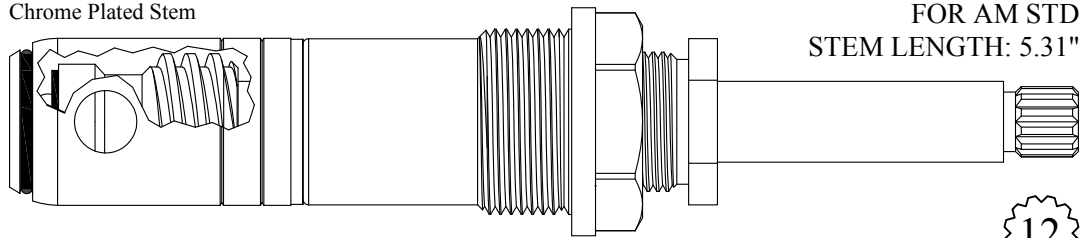

FOR AM STD  
STEM LENGTH: 5.31"

418061/ 418062  
218051/ 218052 Stem Only  
GASKET: 818000

12  
1-2

Chrome Plated Stem

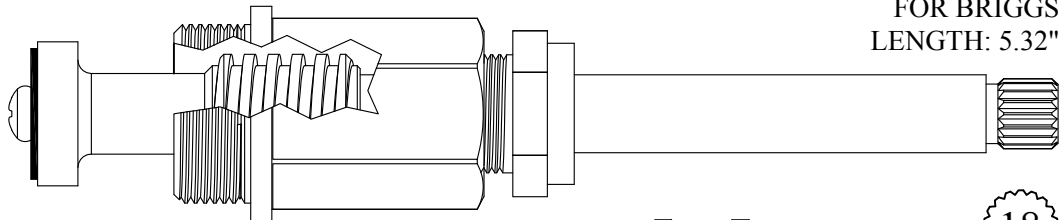

FOR BRIGGS  
LENGTH: 5.32"

417901  
217901 Stem Only  
GASKET: 895370

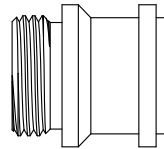

SEAT USED: 648630

18  
3-3

Chrome Plated Unit  
20 TPI Gland

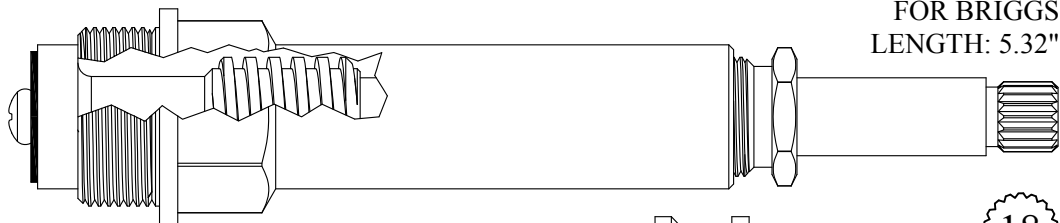

FOR BRIGGS  
LENGTH: 5.32"

417911  
217901 Stem Only  
GASKET: 895370

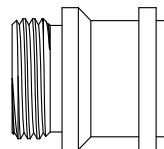

SEAT USED: 648630

18  
3-3

Chrome Plated Stem

FOR BRIGGS  
LENGTH: 5.32"

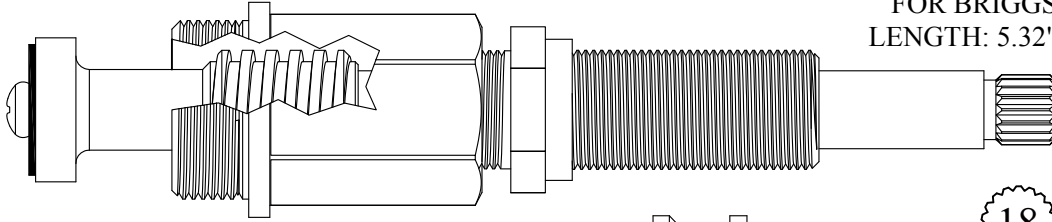

417921  
417901 Stem Only  
GASKET: 895370

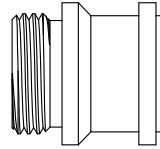

SEAT USED: 648630

18  
3-3

Chrome Plated Unit  
18 TPI Gland

FOR BRIGGS  
LENGTH: 5.32"

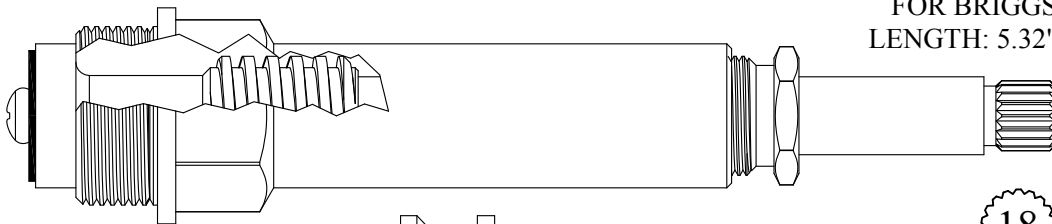

417931  
217901 Stem Only  
GASKET: 895370

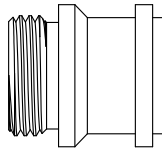

SEAT USED: 648630

18  
3-3

Chrome Plated Stem

FOR STERLING FAUCET  
LENGTH: 5.32"



SEAT USED: LF648170

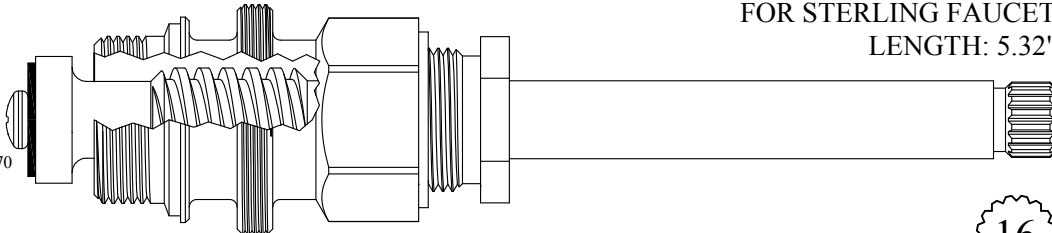

418201  
218201 Stem Only  
GASKET: 895400

16  
1-5

Chrome Plated Stem

FOR STERLING FAUCET  
LENGTH: 5.32"



SEAT USED: LF648170

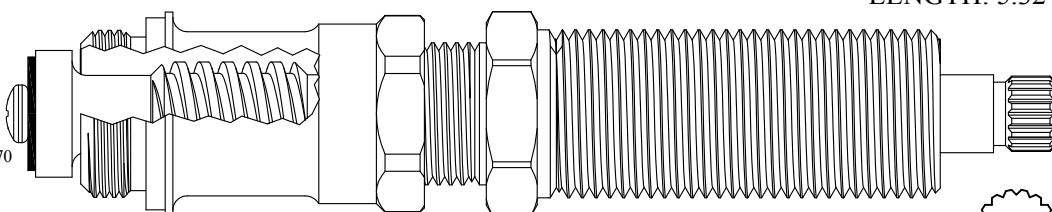

418231  
218201 Stem Only  
GASKET: 895400

16  
1-5



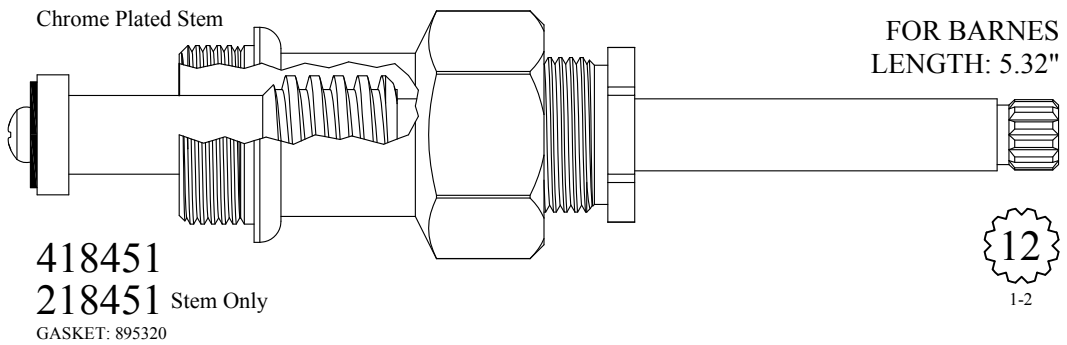
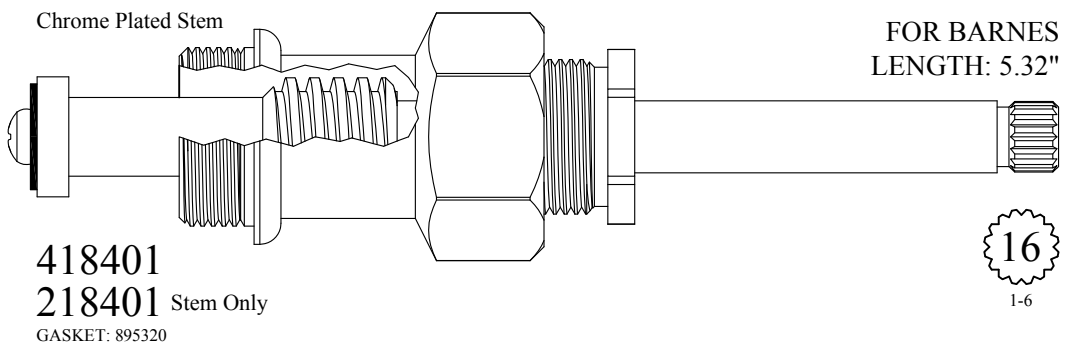
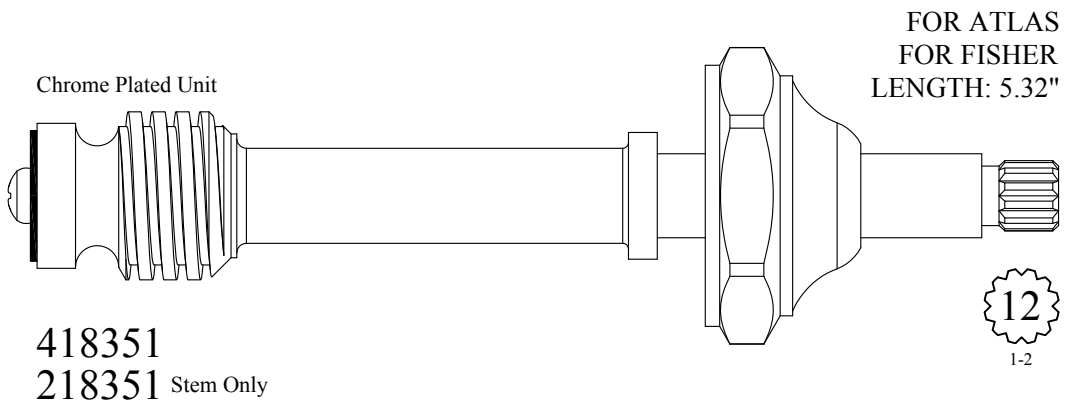
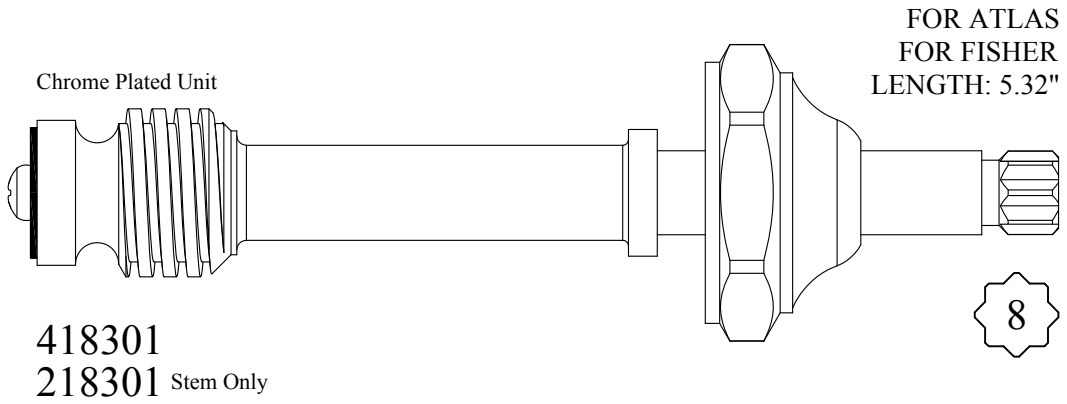

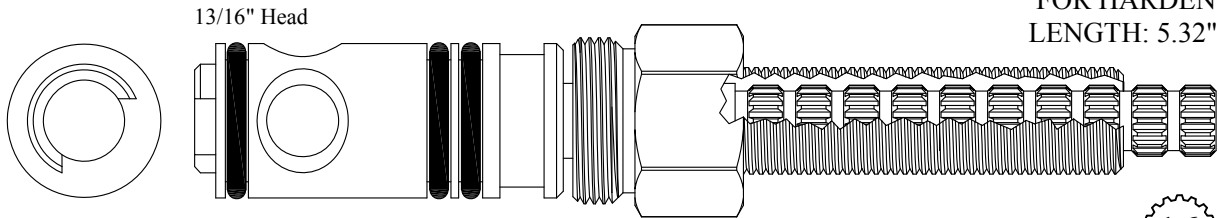

432920  
232920 Stem Only

16  
3-16

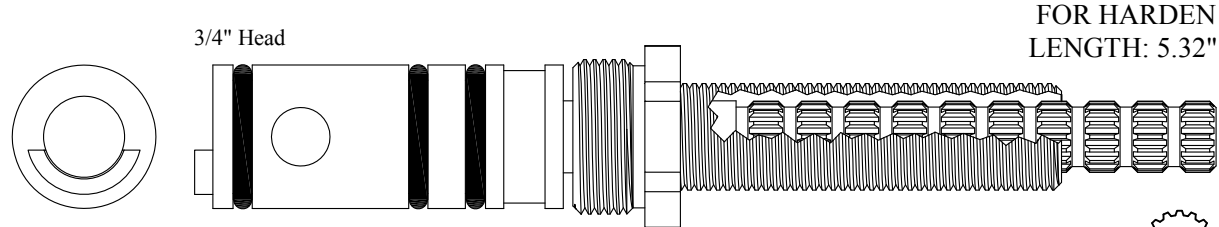

432930  
232930 Stem Only

16  
3-16

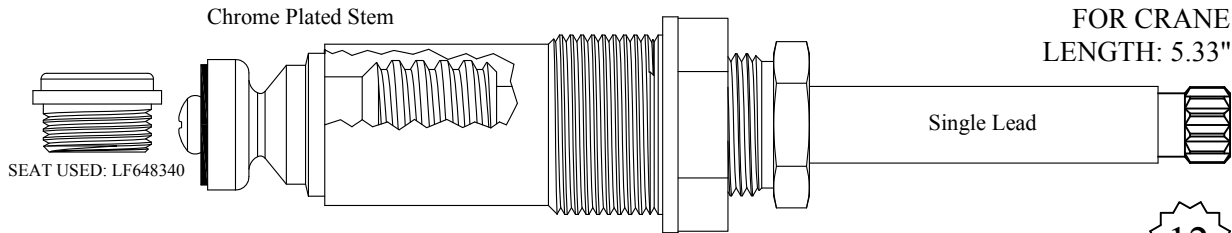

418501  
218501 Stem Only  
GASKET: 895370

12  
3-10

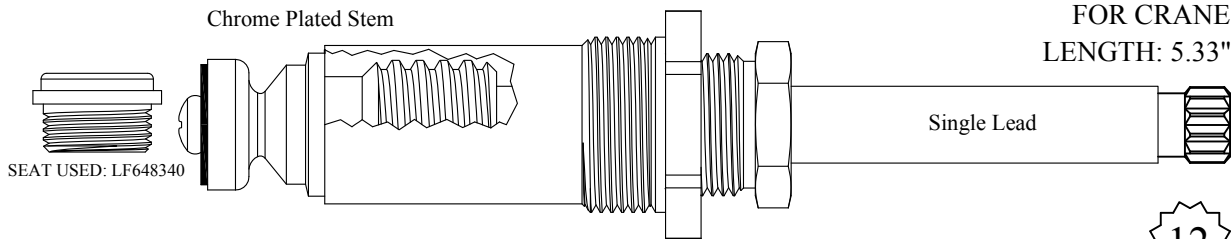

418541  
218501 Stem Only  
GASKET: 895370

12  
3-10

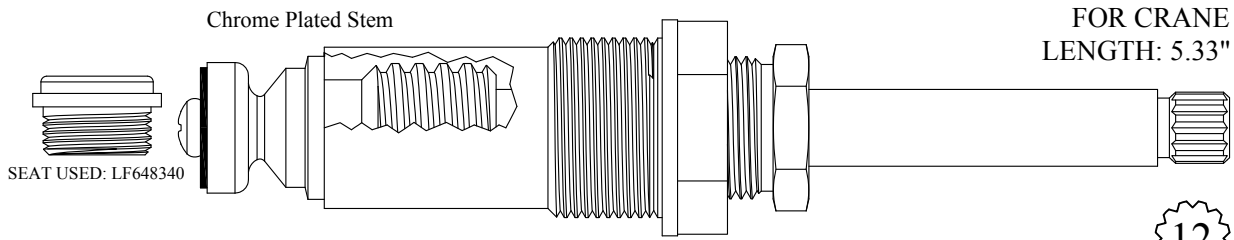

418551  
 218551 Stem Only  
 GASKET: 895370

12  
 1-2

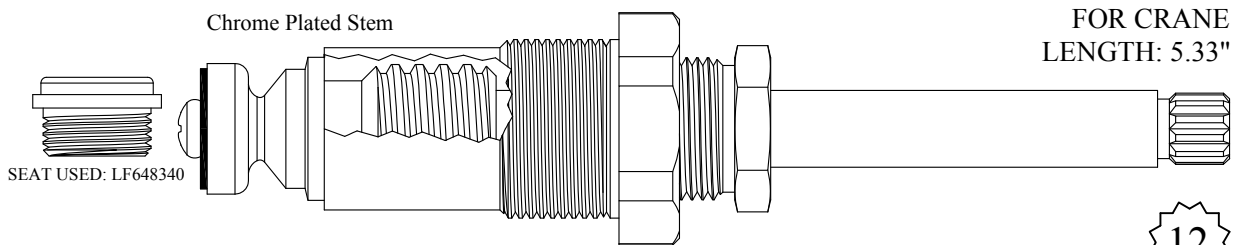

418621  
 218501 Stem Only  
 GASKET: 895370

12  
 3-10

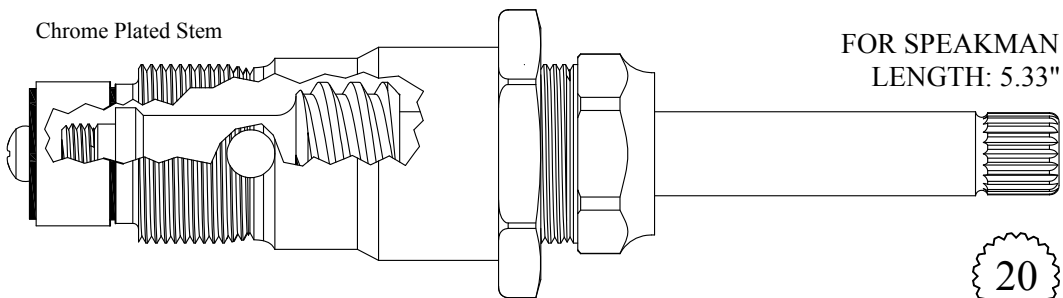

433001  
 233001 Stem Only  
 GASKET: 895450

20  
 2-4

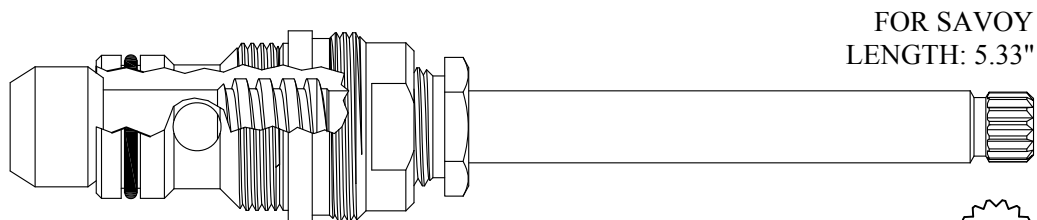

433391  
 233391 Stem Only  
 GASKET: 895400

15  
 1-13

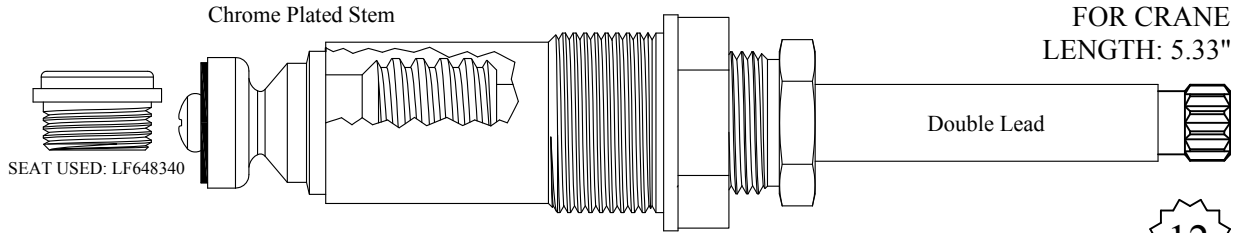

FOR CRANE  
LENGTH: 5.33"

Double Lead

12  
3-10

418531/ 418532  
218531/ 218532 Stem Only  
GASKET: 895370

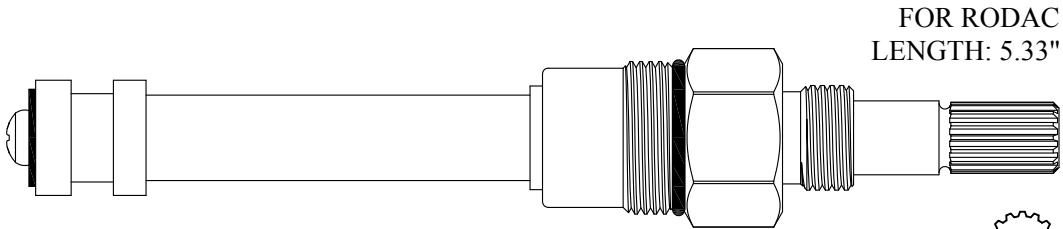

FOR RODAC  
LENGTH: 5.33"

16  
3-16

LF479801/ LF479802  
GASKET: 890170 O-RING INCLUDED

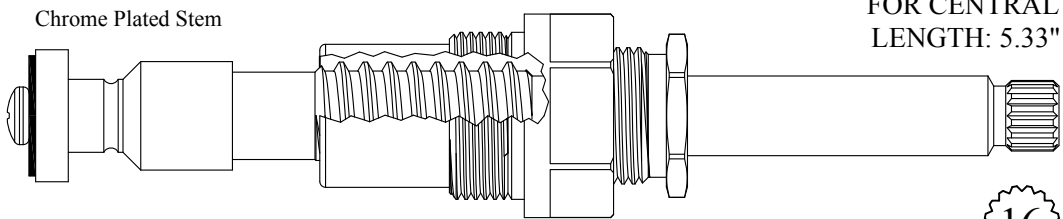

FOR CENTRAL  
LENGTH: 5.33"

16  
1-6

LF480171  
LF280171 Stem Only  
GASKET: 895400

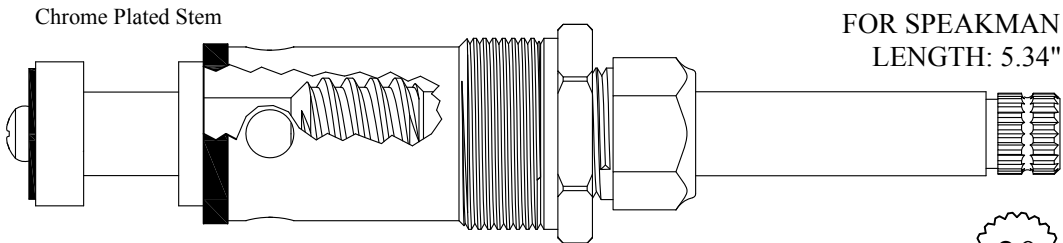

FOR SPEAKMAN  
LENGTH: 5.34"

20  
2-4

433201  
233201 Stem Only

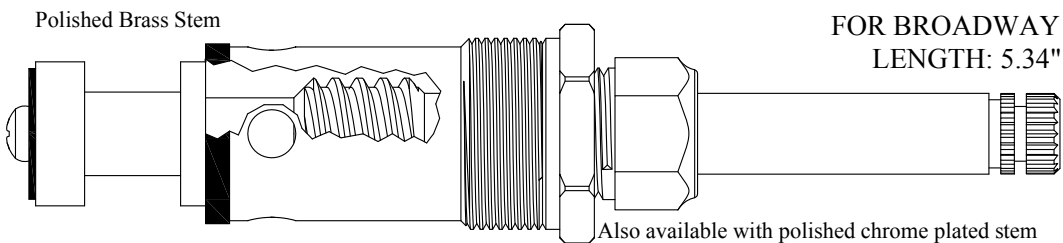

FOR BROADWAY  
LENGTH: 5.34"

20  
2-4

433221  
233221 Stem Only

Also available with polished chrome plated stem

433221-CP  
233221-CP Stem Only

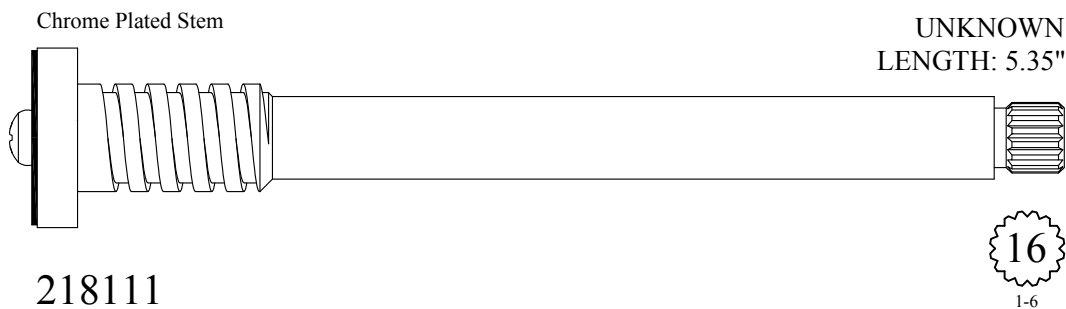
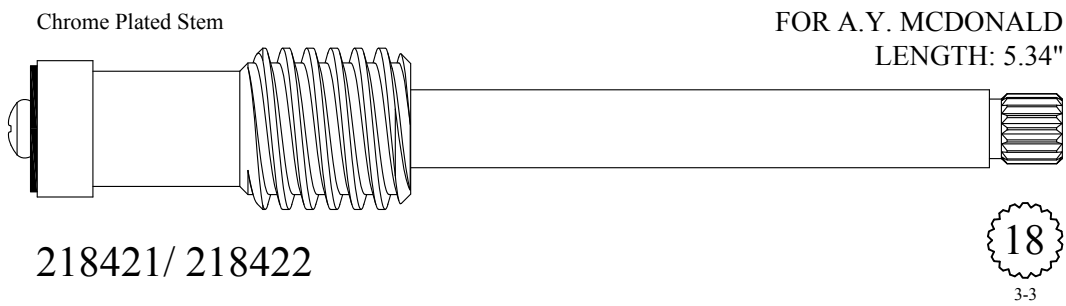
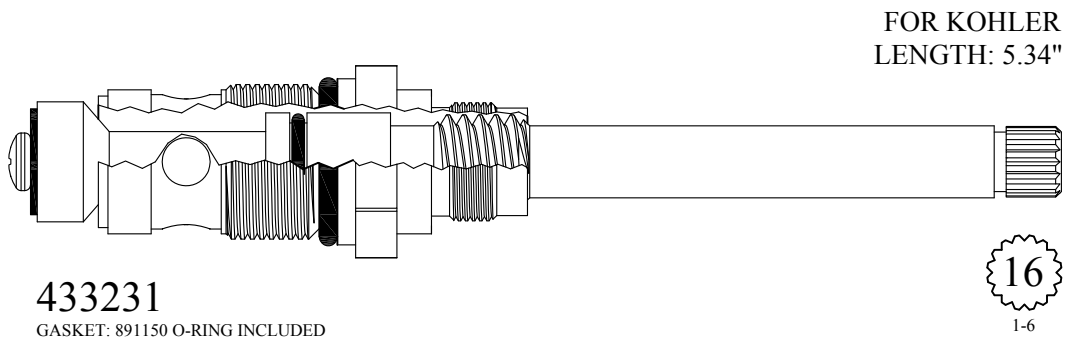
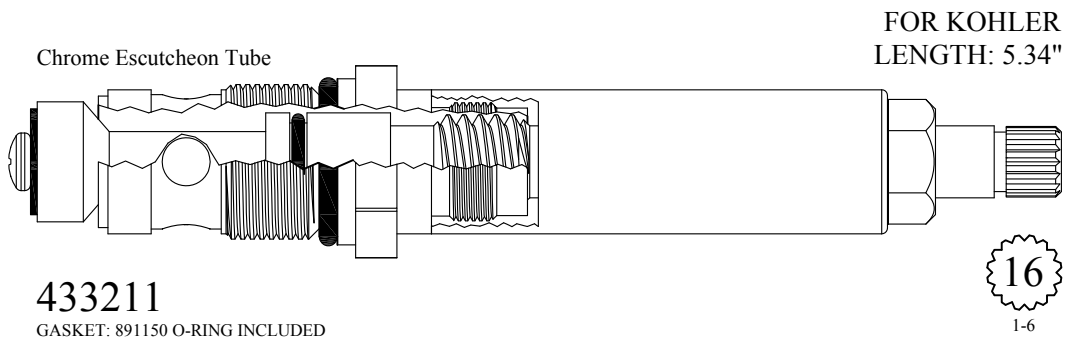

Chrome Plated Stem

FOR AM STD  
LENGTH: 5.35"

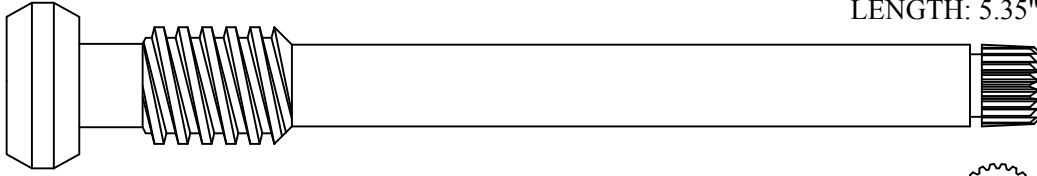

233531

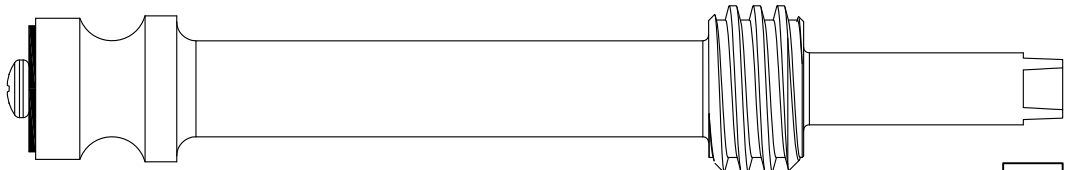

Not Available, Use 418521



Chrome Plated Unit

FOR DICK BROS.  
LENGTH: 5.35"



SEAT USED: 648980

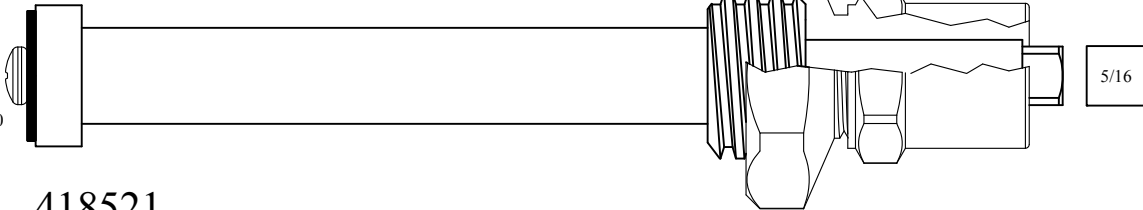

5/16

418521

218521 Stem Only

GASKET: 895400 INCLUDED

Chrome Plated Stem

FOR GLAUBER WEST COAST  
LENGTH: 5.35"

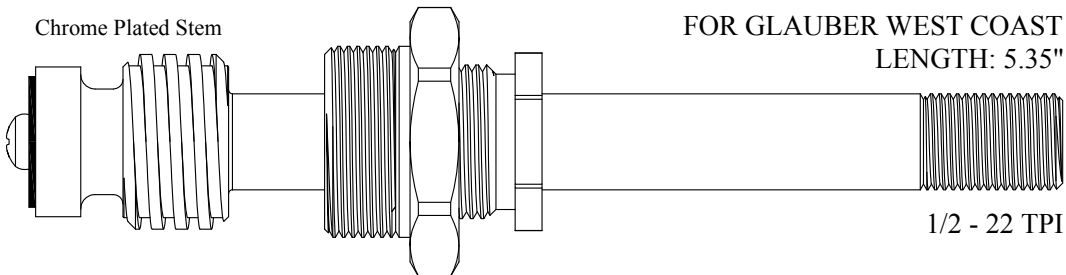

1/2 - 22 TPI

418601

218601 Stem Only

GASKET: 895570

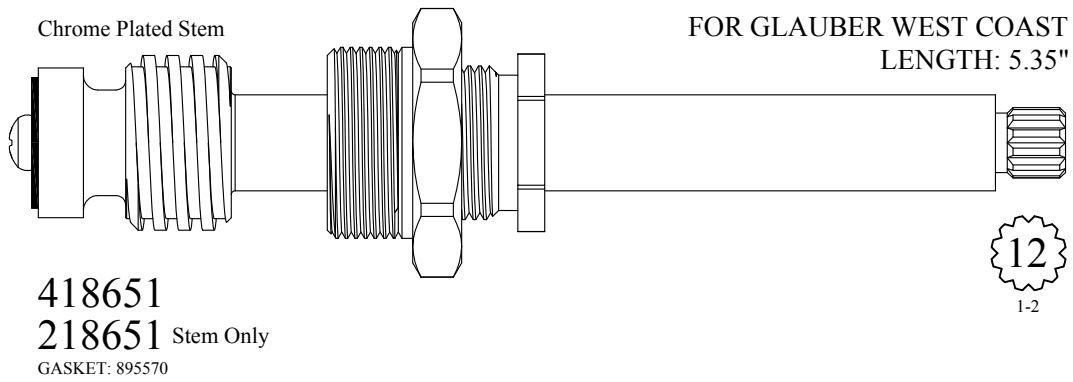

418651  
 218651 Stem Only  
 GASKET: 895570

12  
 1-2

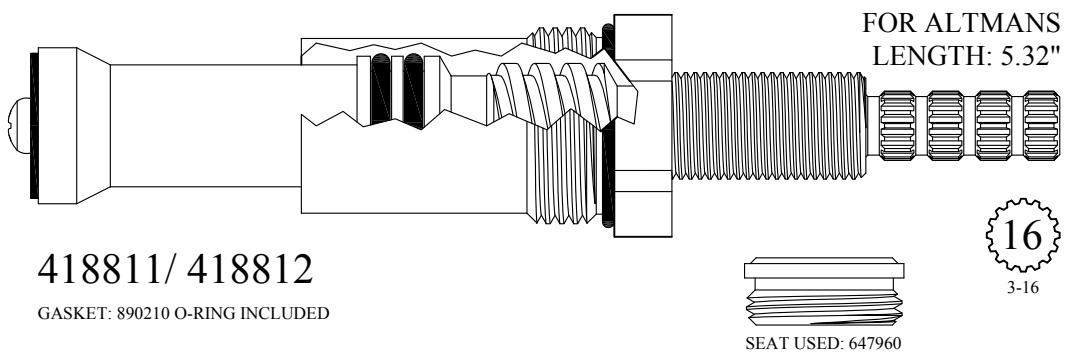

418811/ 418812  
 GASKET: 890210 O-RING INCLUDED

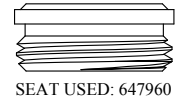

16  
 3-16

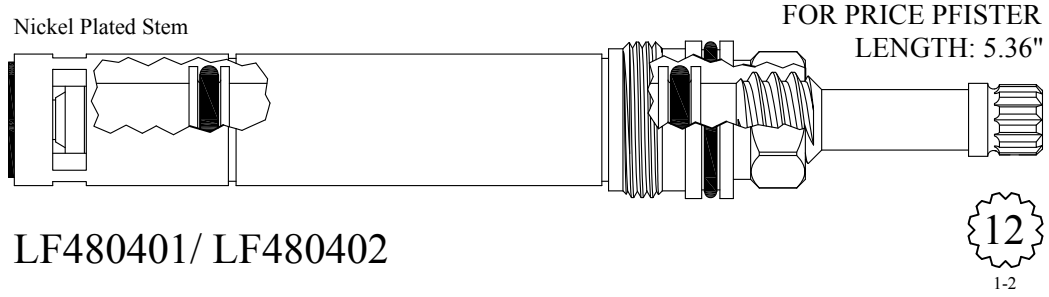

LF480401/ LF480402

12  
 1-2

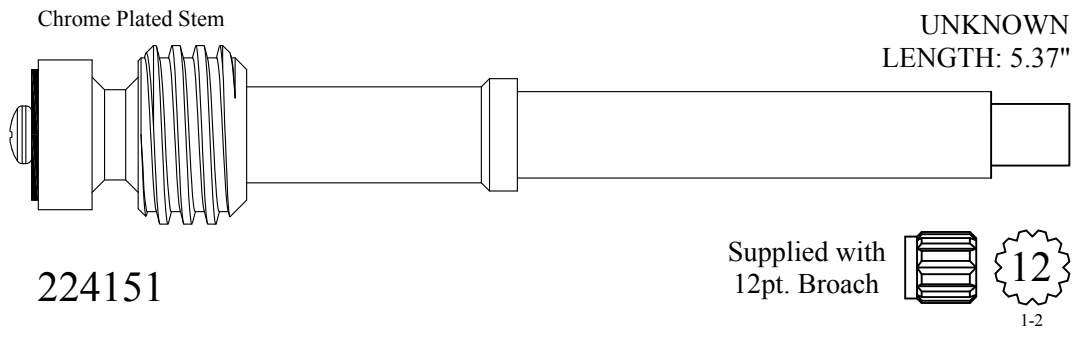

224151

Supplied with  
 12pt. Broach  12  
 1-2

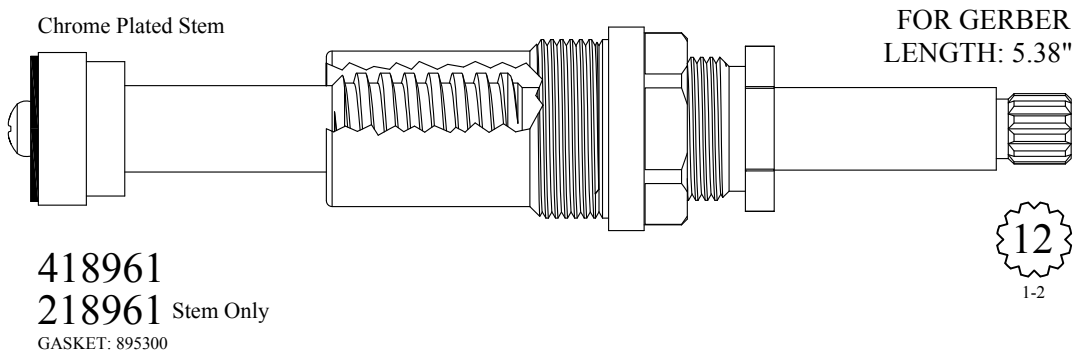
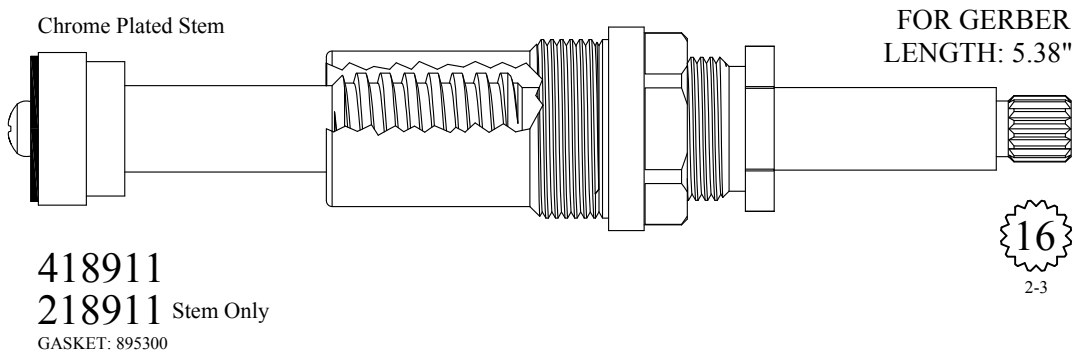
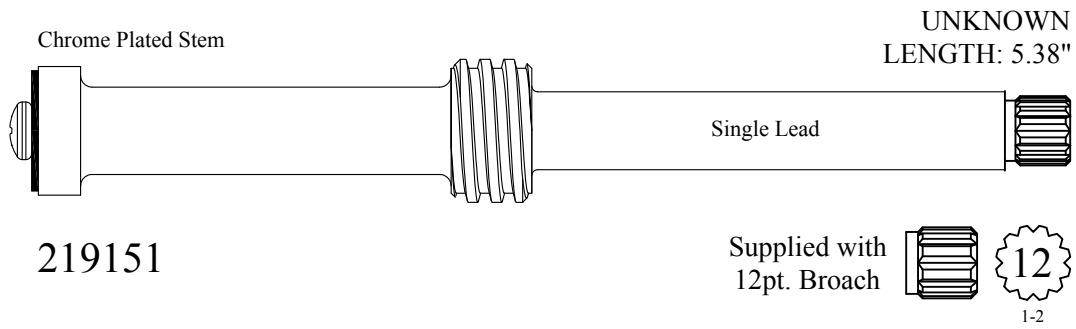
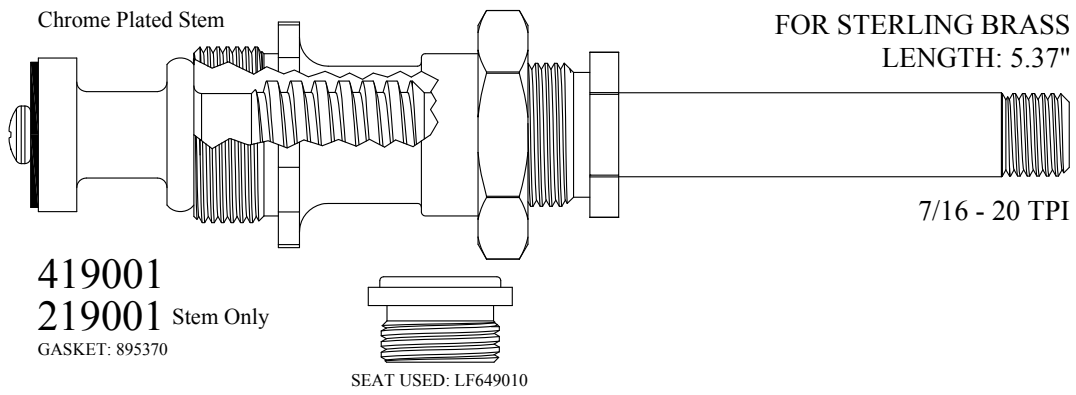



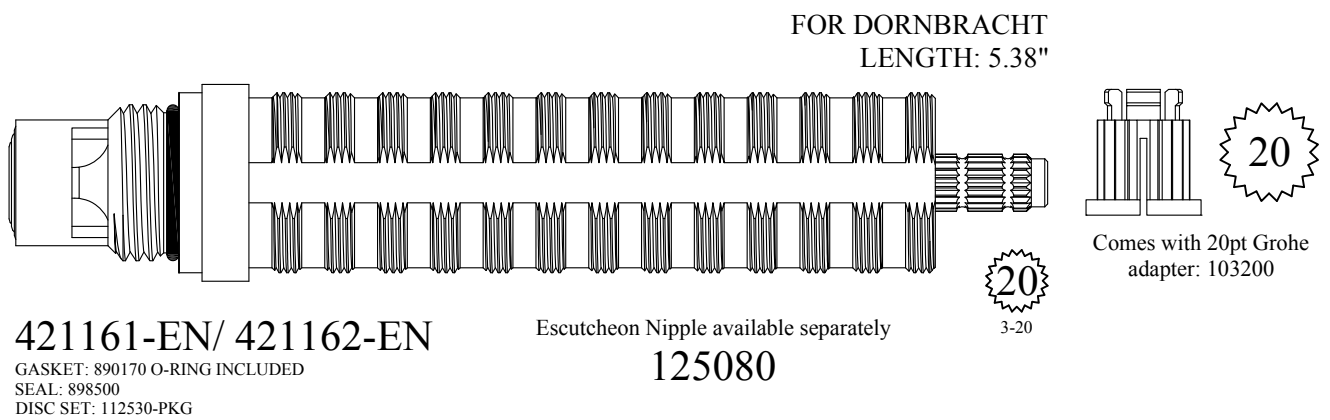
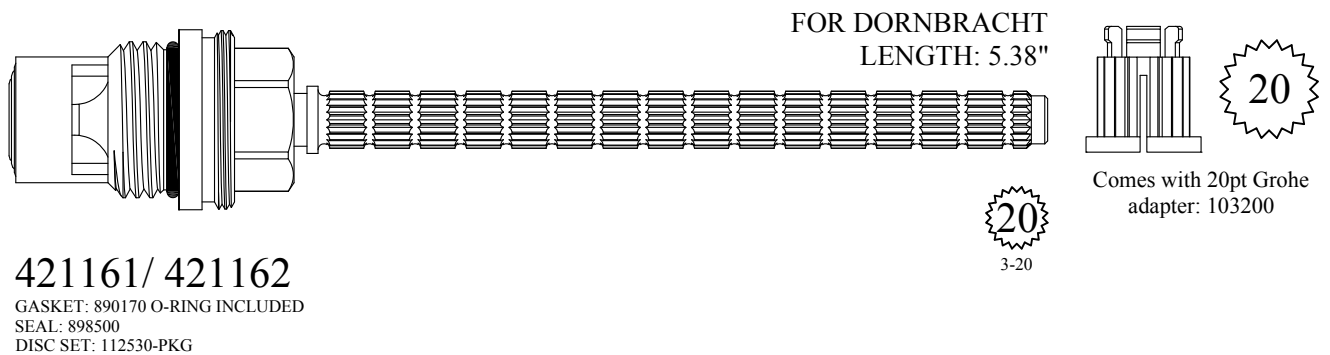
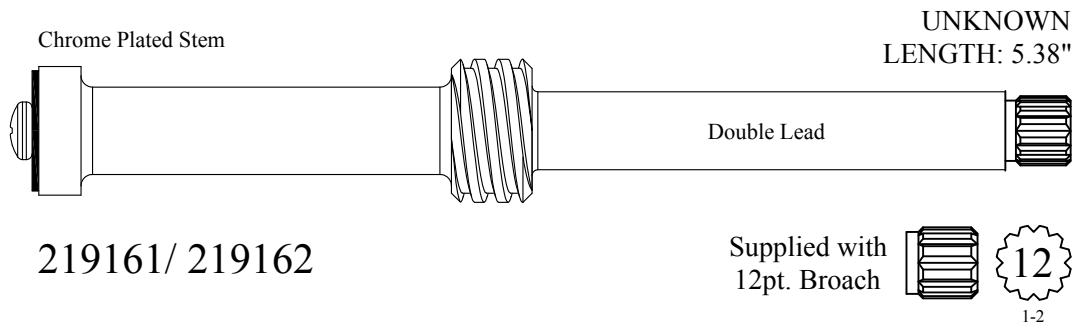
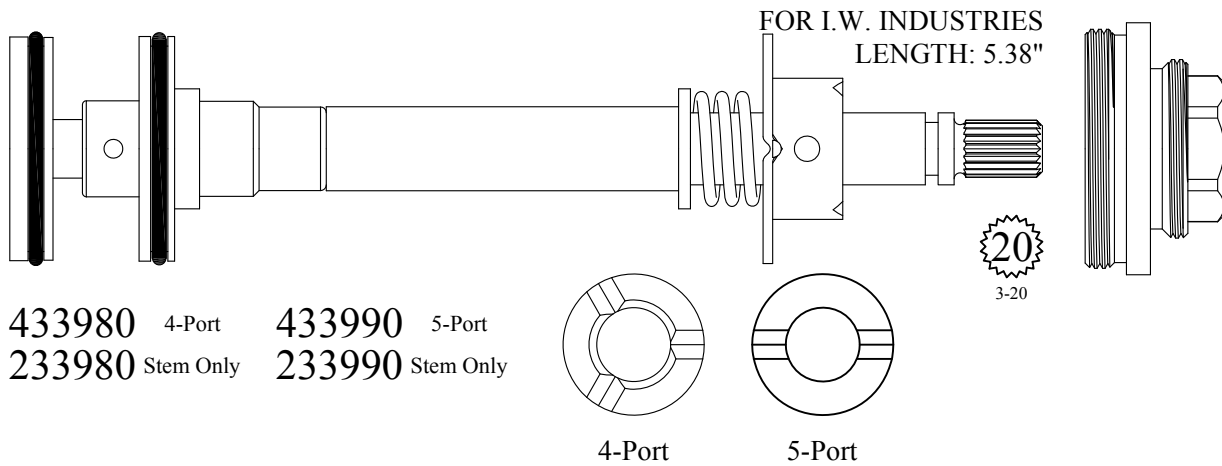

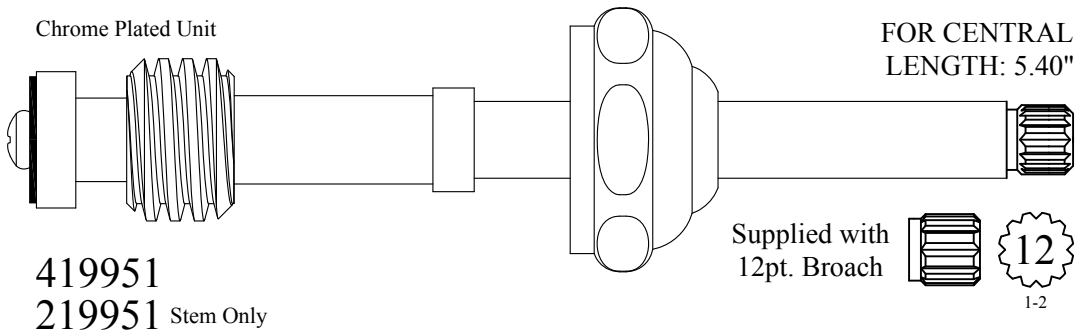
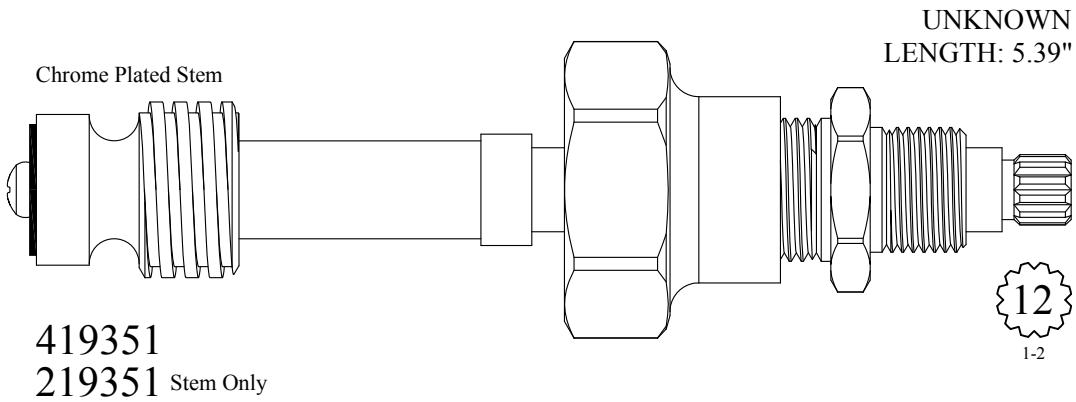
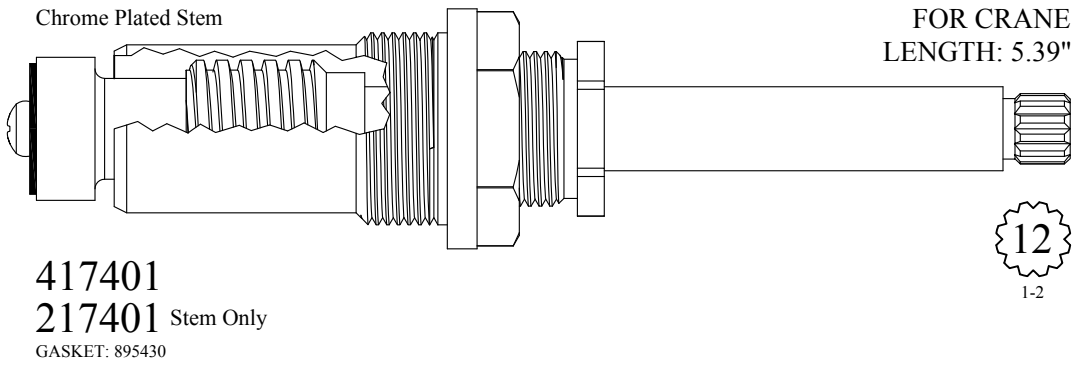
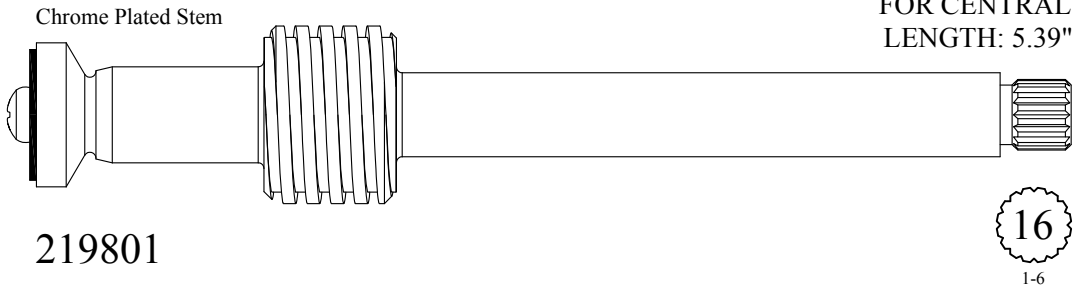

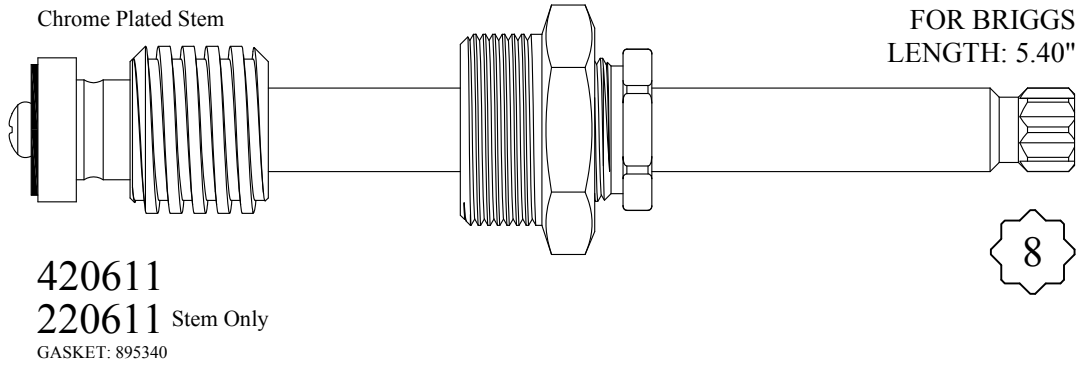

**420611**  
**220611** Stem Only  
 GASKET: 895340

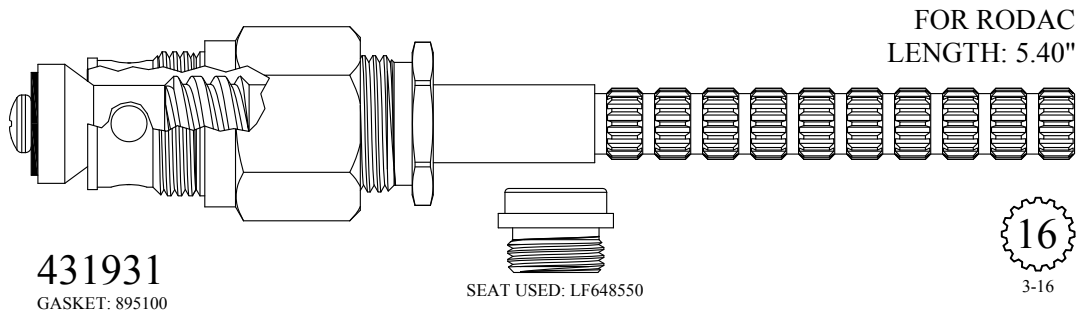

**431931**  
 GASKET: 895100

SEAT USED: LF648550

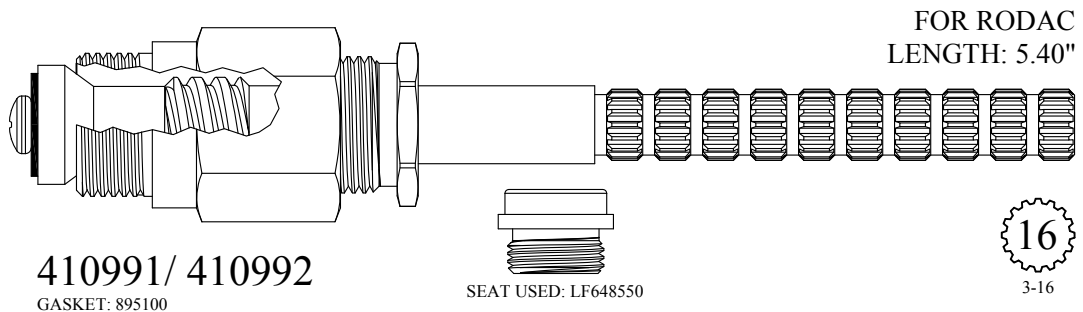

**410991/ 410992**  
 GASKET: 895100

SEAT USED: LF648550

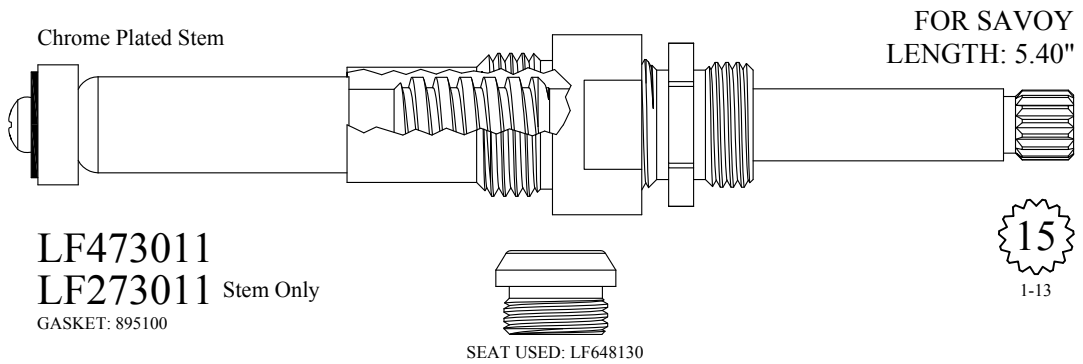

**LF473011**  
**LF273011** Stem Only  
 GASKET: 895100

SEAT USED: LF648130



Chrome Plated Stem

FOR DICK BROS.  
LENGTH: 5.41"

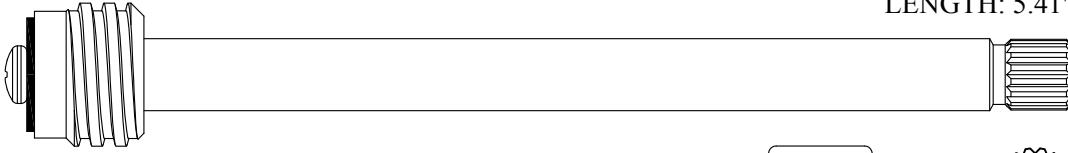

220411



Chrome Plated Stem

FOR ROYAL BRASS  
LENGTH: 5.41"

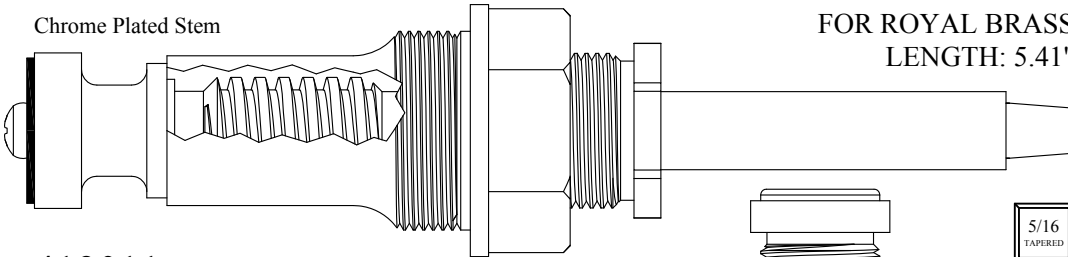

419011

219011 Stem Only

GASKET: 895560

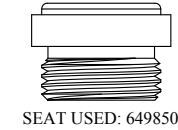

Chrome Plated Stem

FOR ROYAL BRASS  
LENGTH: 5.41"

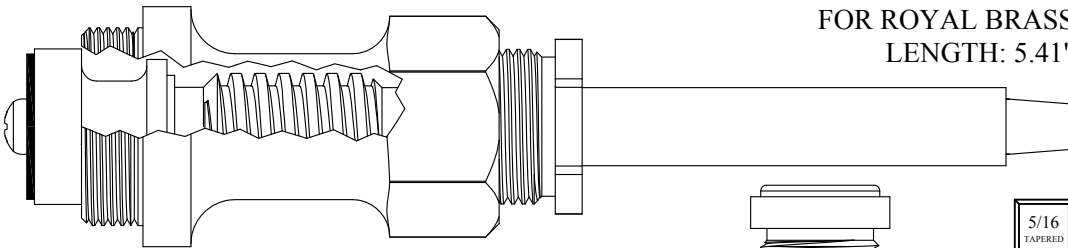

419021

219011 Stem Only

GASKET: 895560

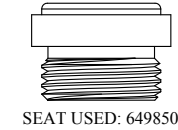

Chrome Plated Stem

FOR ROYAL BRASS  
LENGTH: 5.41"

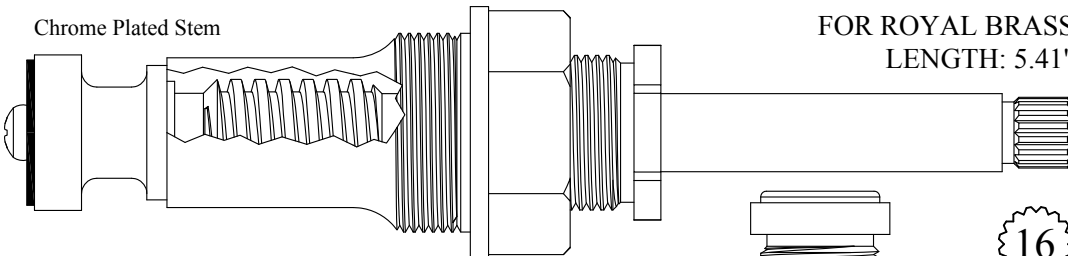

419031

219031 Stem Only

GASKET: 895560

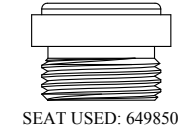

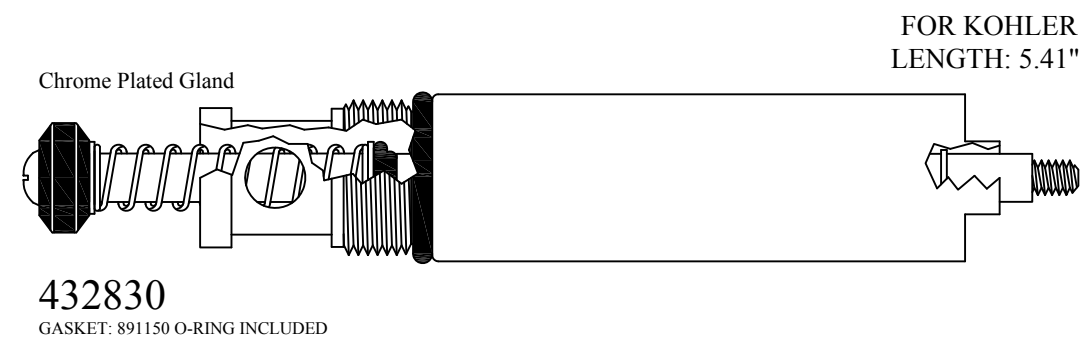
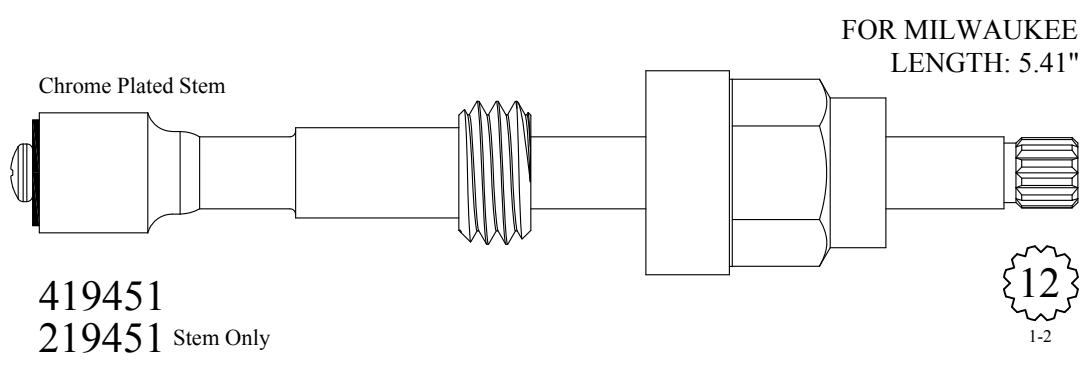
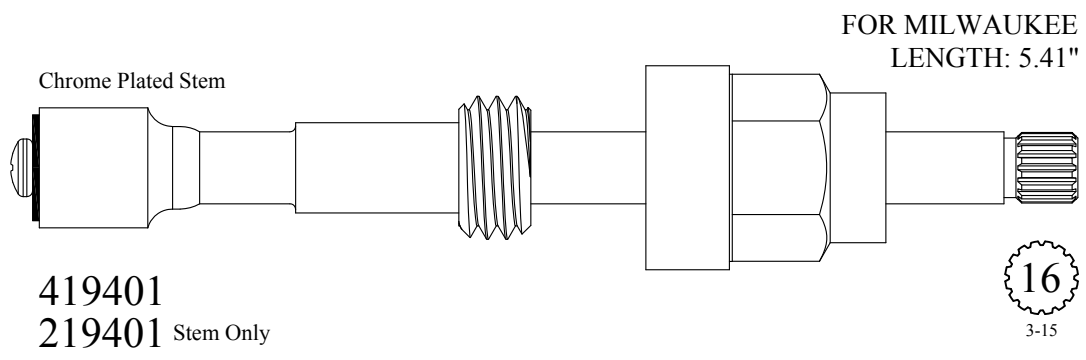
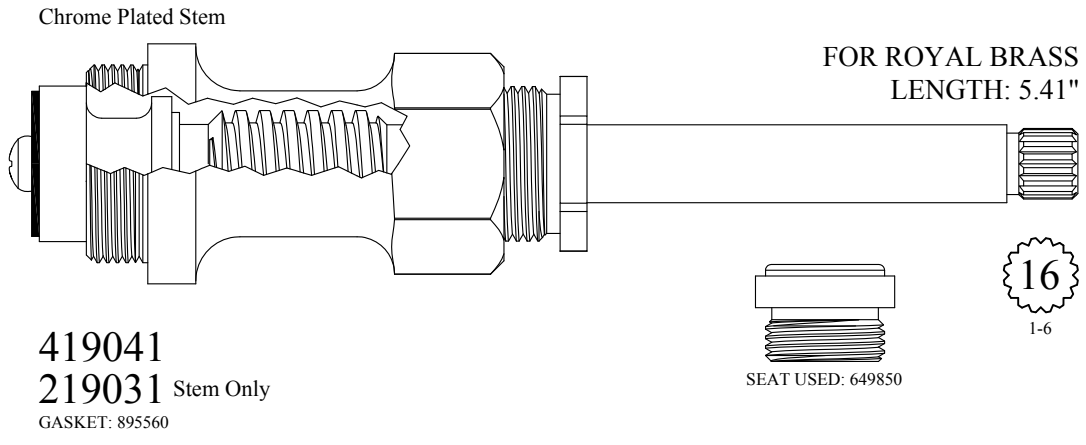

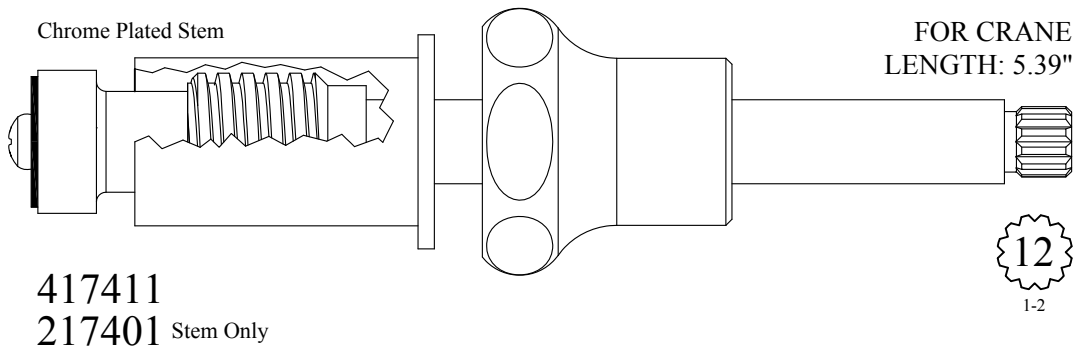
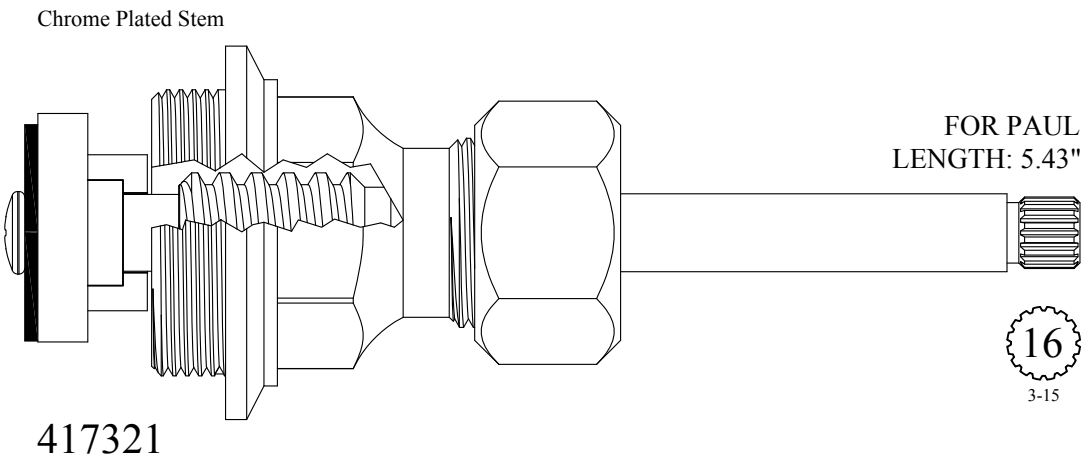
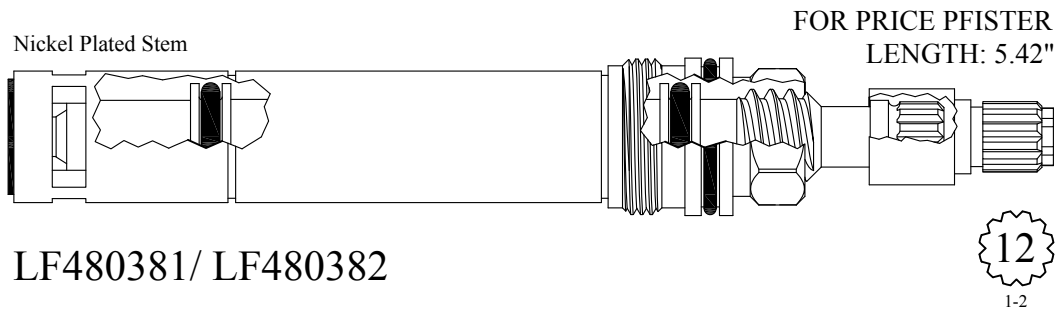
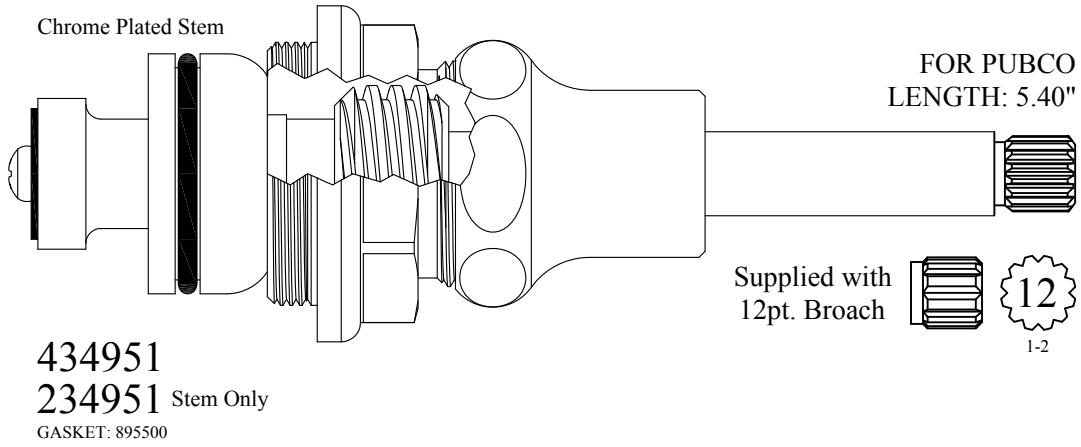

FOR MUELLER  
LENGTH: 5.43"

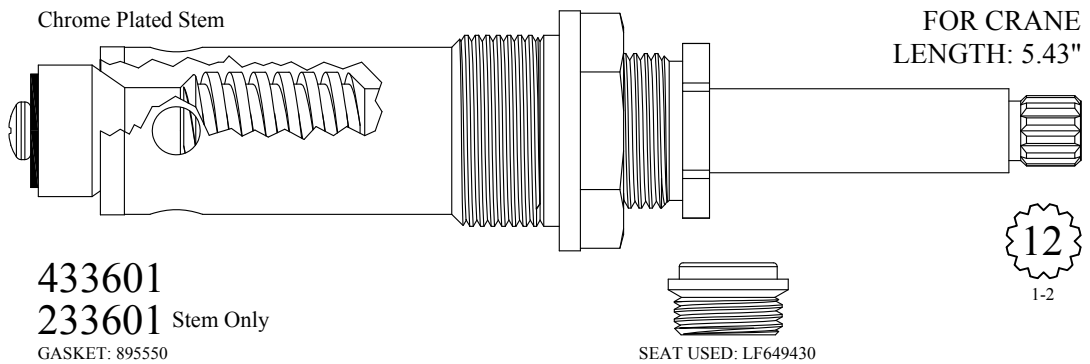
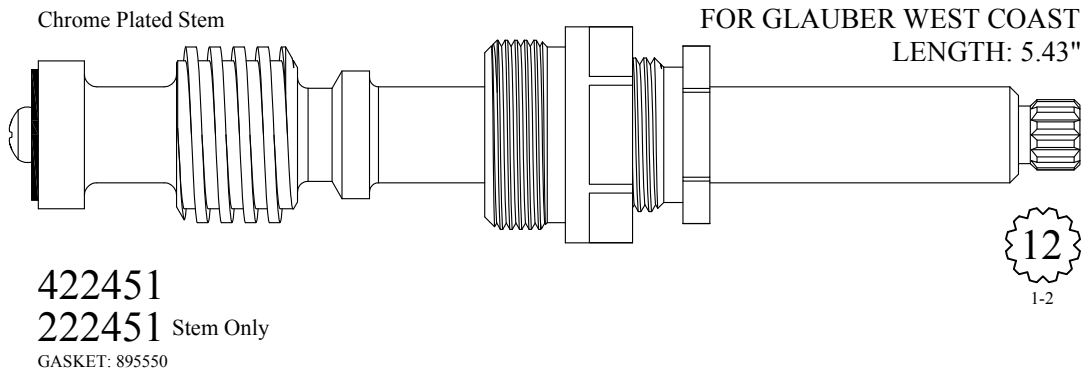
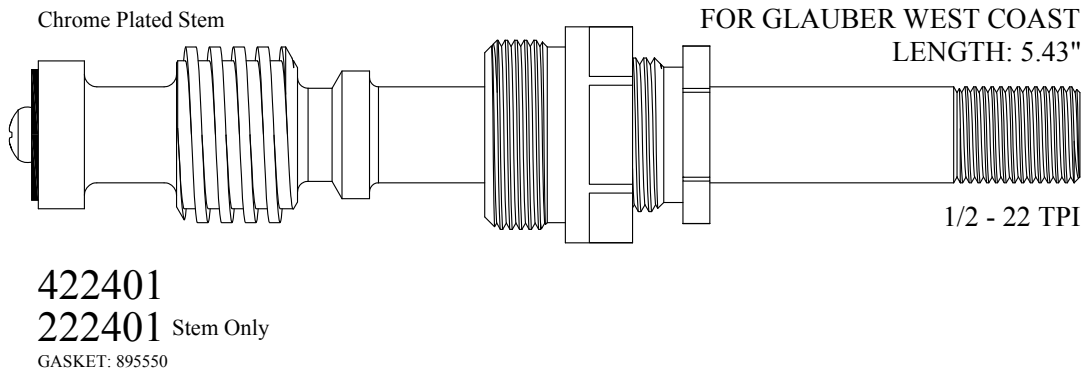
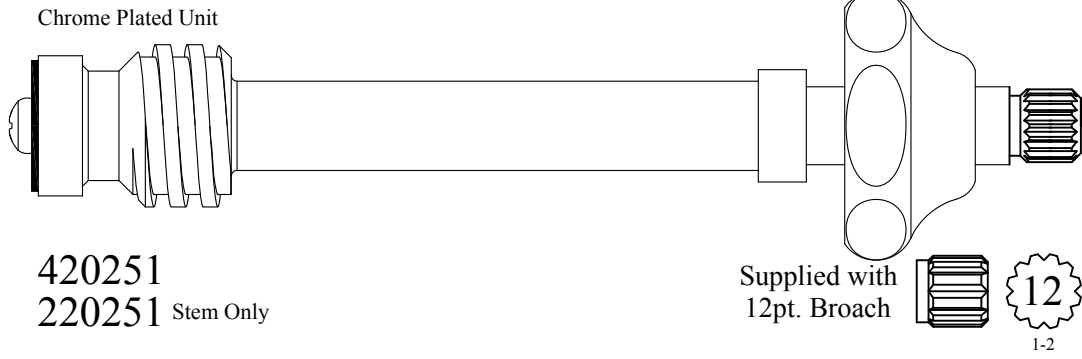



FOR ONDINE  
LENGTH: 5.43"

421221/ 421222

GASKET: 890170 O-RING INCLUDED  
SEAL: 898570-R/B  
DISC SET: 151380-PKG

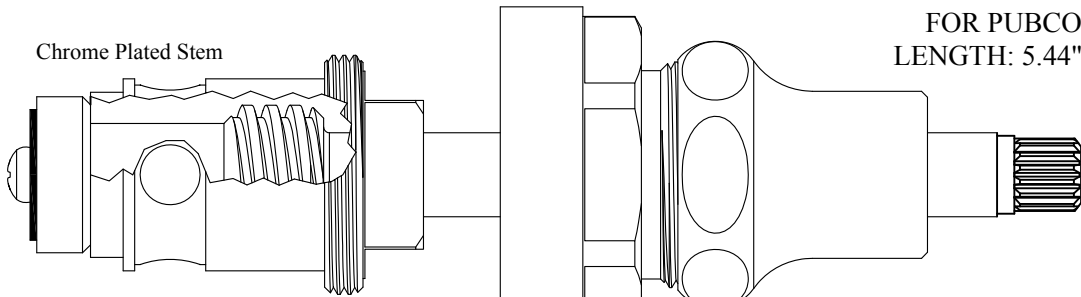

Chrome Plated Stem

FOR PUBCO  
LENGTH: 5.44"

433351

233351 Stem Only

Supplied with  
12pt. Broach

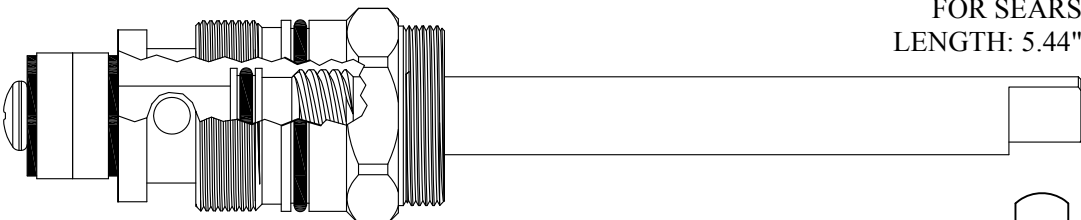

FOR SEARS  
LENGTH: 5.44"

434741

GASKET: 890200

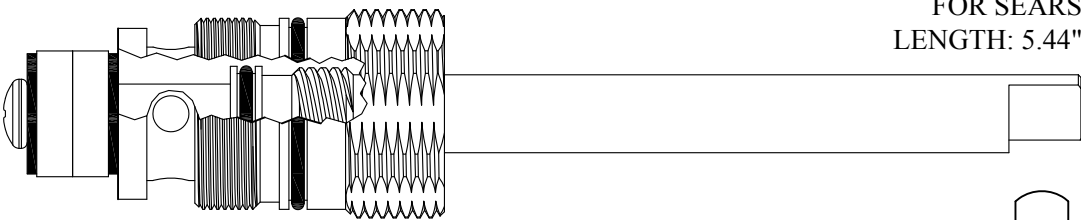

FOR SEARS  
LENGTH: 5.44"

434841

GASKET: 890200





FOR ONDINE  
LENGTH: 5.44"

16  
3-16

**421241/ 421242**

GASKET: 890210 O-RING INCLUDED  
SEAL: 898610-R/B  
DISC SET: 109850-PKG

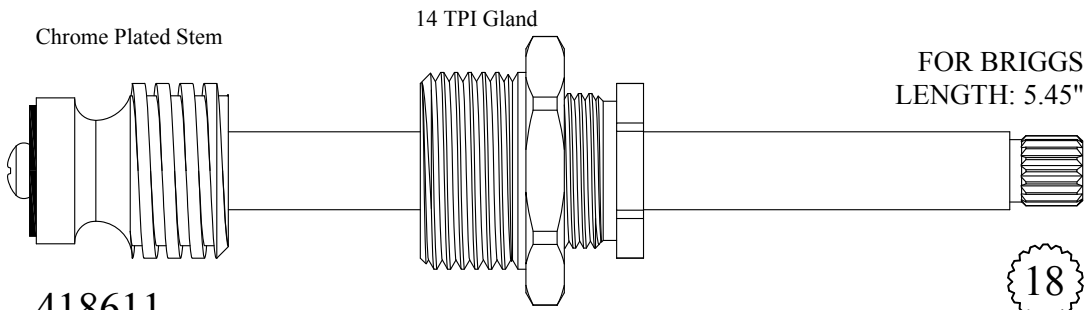

FOR BRIGGS  
LENGTH: 5.45"

18  
3-3

**418611**

**220301** Stem Only

GASKET: 895570

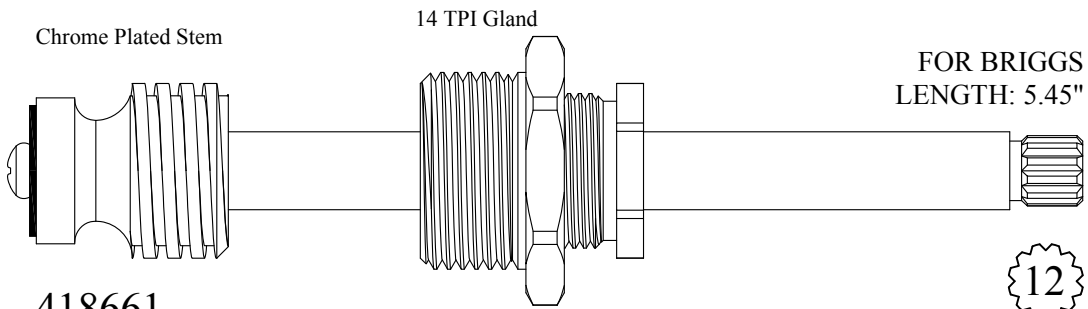

FOR BRIGGS  
LENGTH: 5.45"

12  
1-2

**418661**

**220351** Stem Only

GASKET: 895570

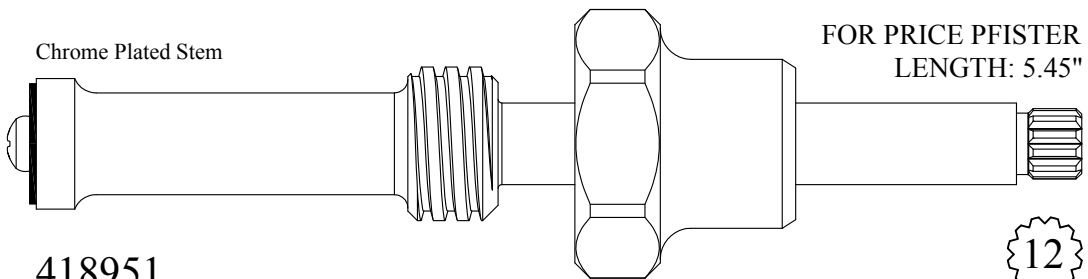

FOR PRICE PFISTER  
LENGTH: 5.45"

12  
1-2

**418951**

**218951** Stem Only

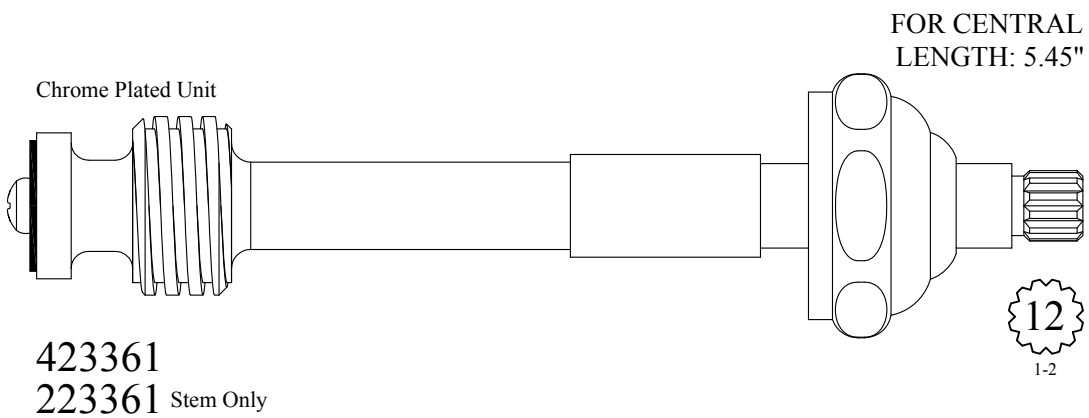
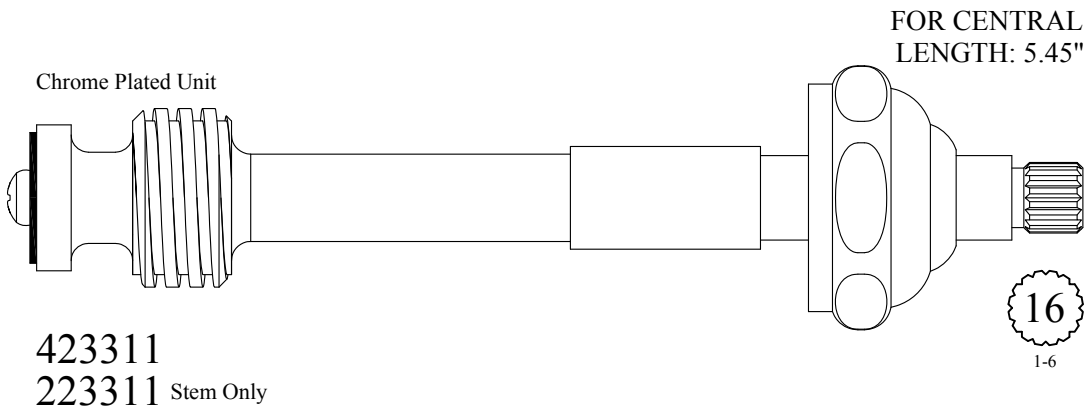
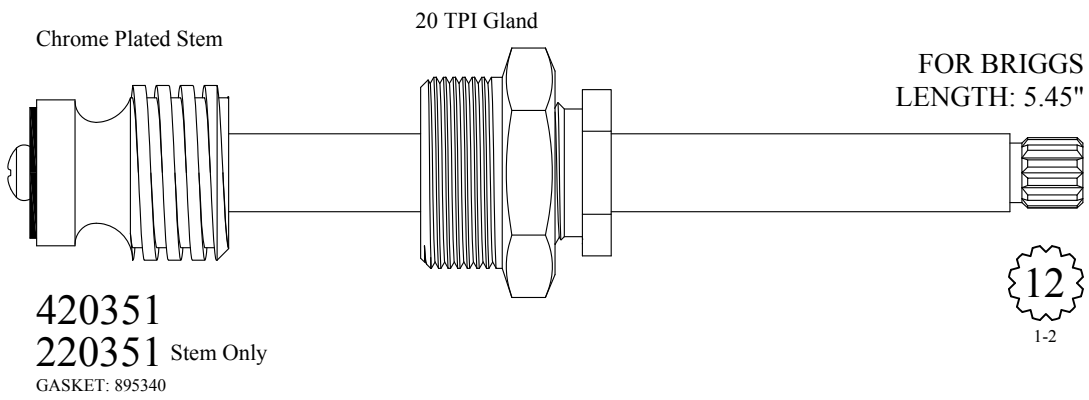
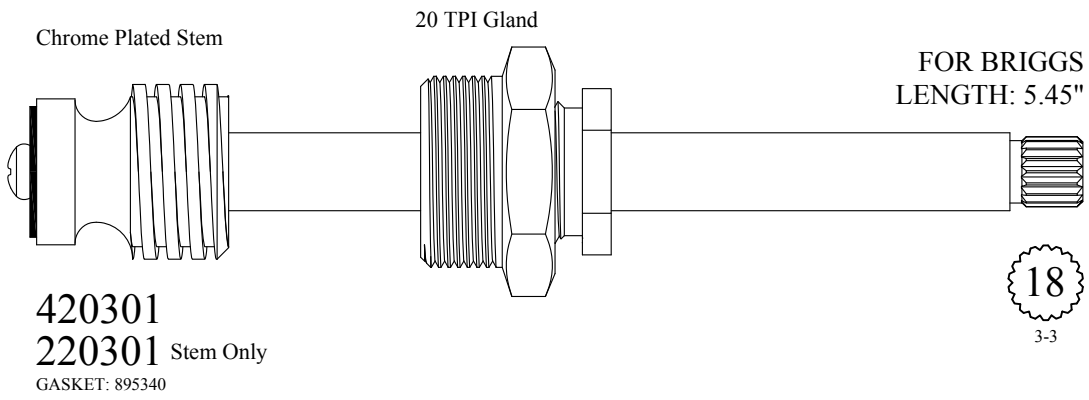

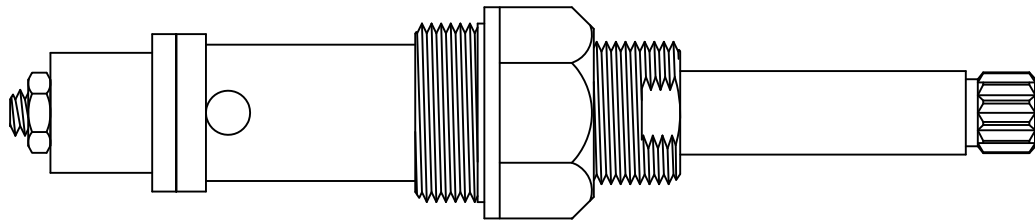

Old Style, Use 433281

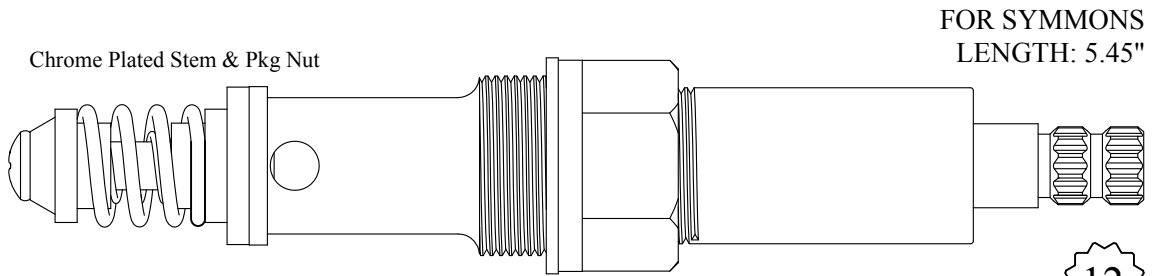

433281

GASKET: 895350 INCLUDED



Symmons Small

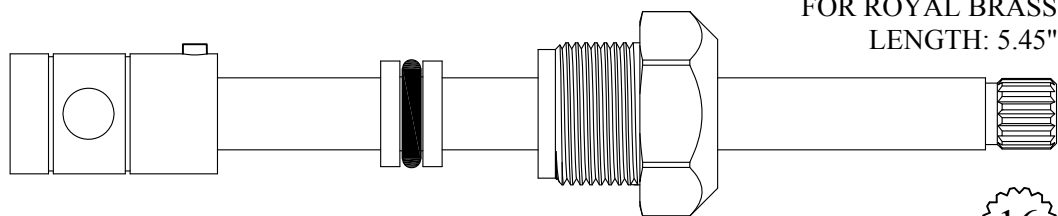

433520

233520 Stem Only

GASKET: 895100



1-6

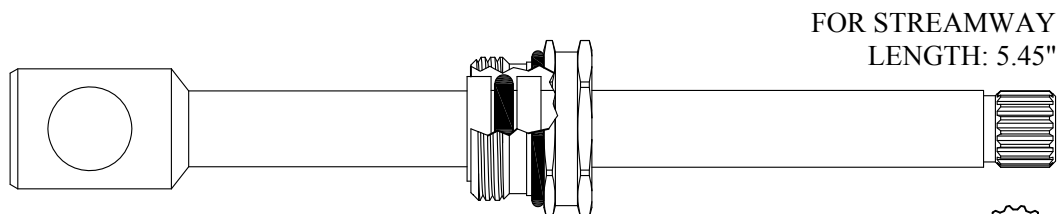

434810

234810 Stem Only

GASKET: 890170 O-RING INCLUDED



3-7

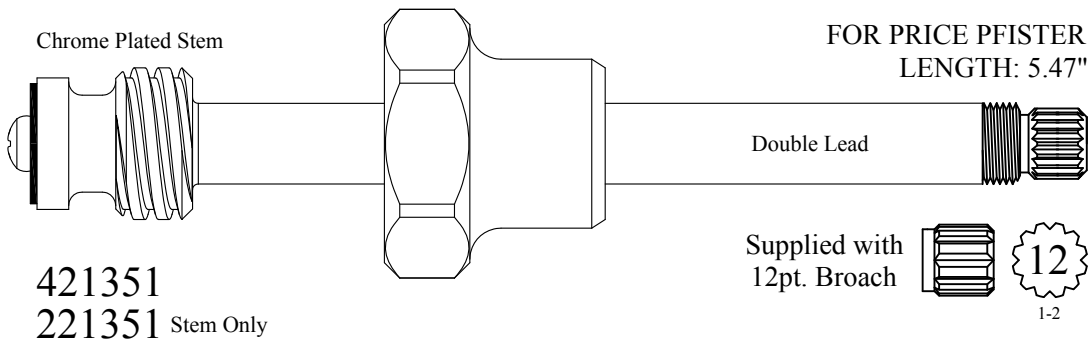
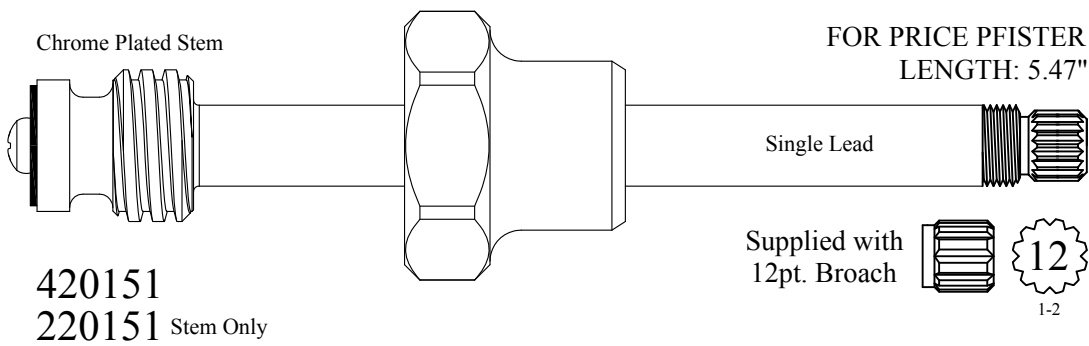
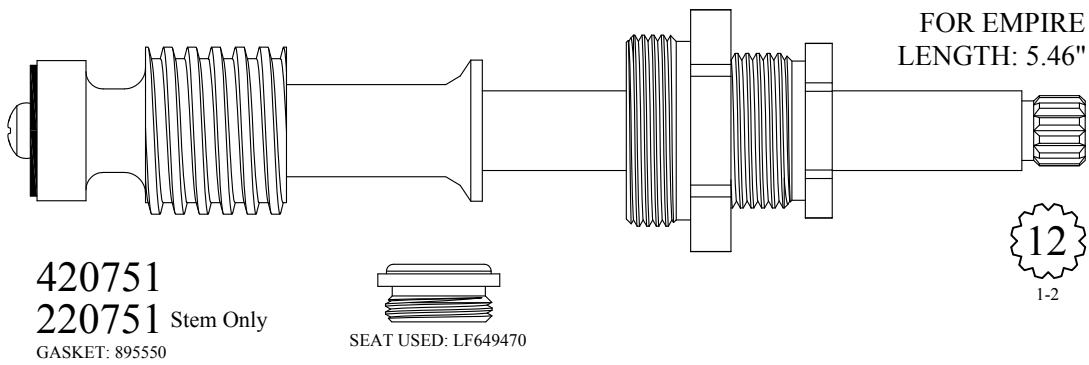
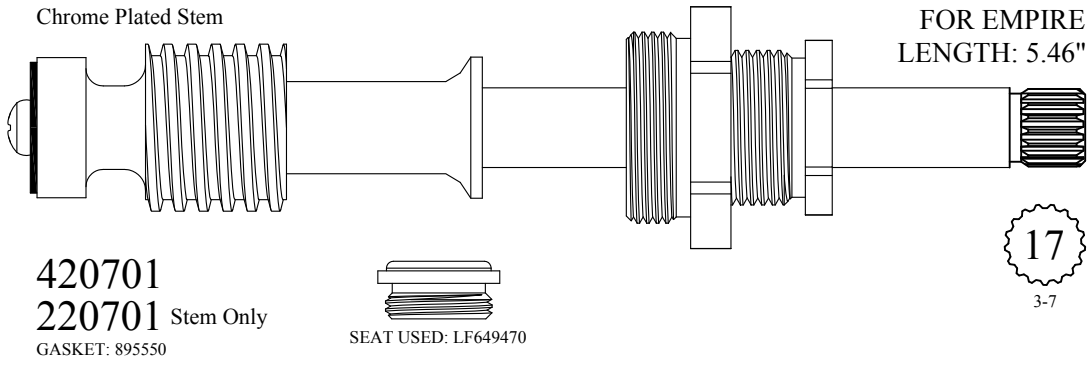

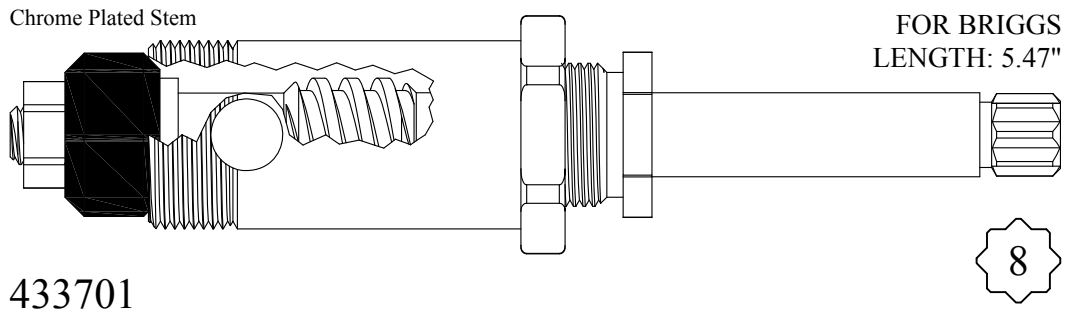

433701  
 233701 Stem Only  
 GASKET: 895340

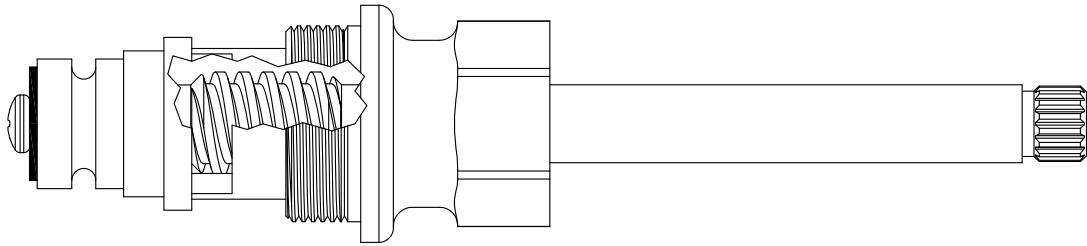

Not Available, Use 434001

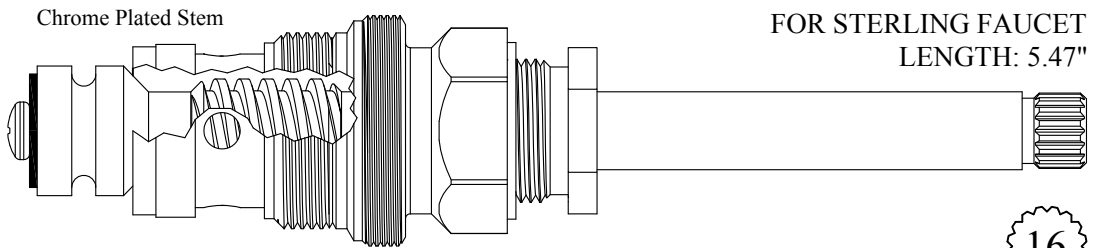

434001  
 234001 Stem Only  
 GASKET: 895560

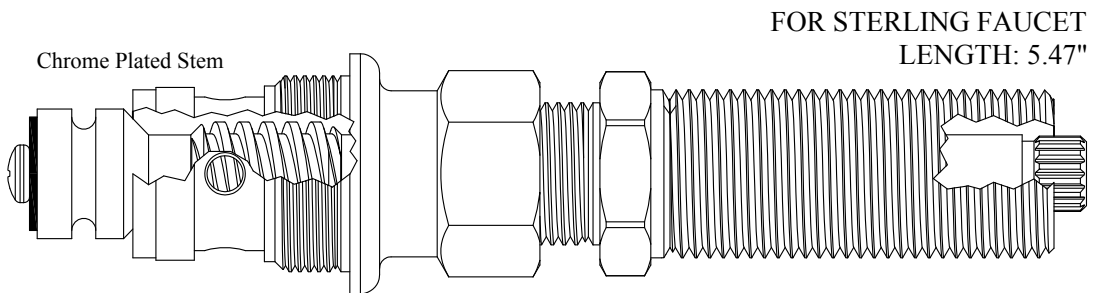

434011  
 234001 Stem Only  
 GASKET: 895560



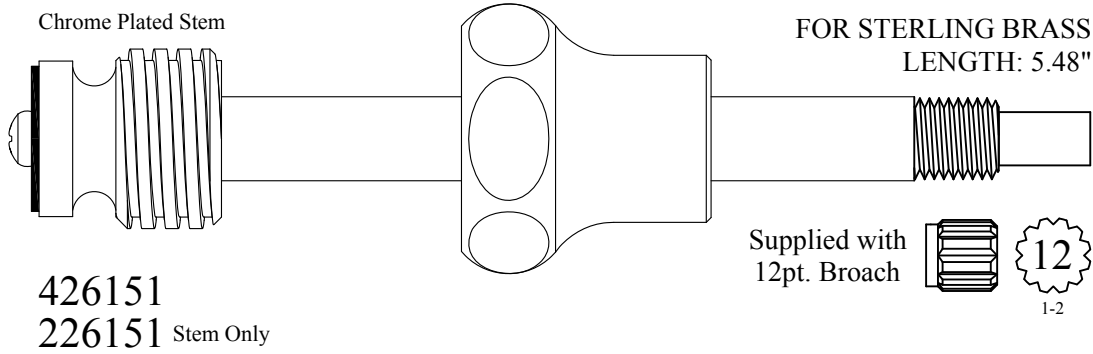

426151  
226151 Stem Only

Supplied with  
12pt. Broach  **12**  
1-2

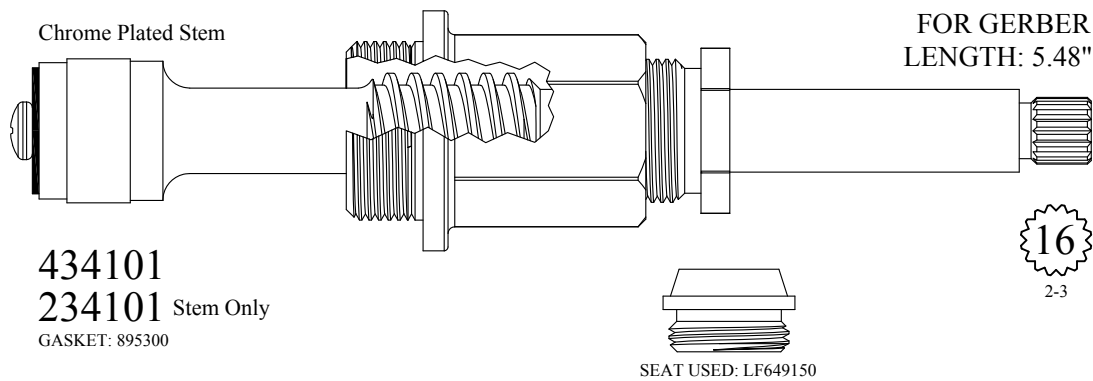

434101  
234101 Stem Only  
GASKET: 895300

  
SEAT USED: LF649150

FOR GERBER  
LENGTH: 5.48"  
**16**  
2-3

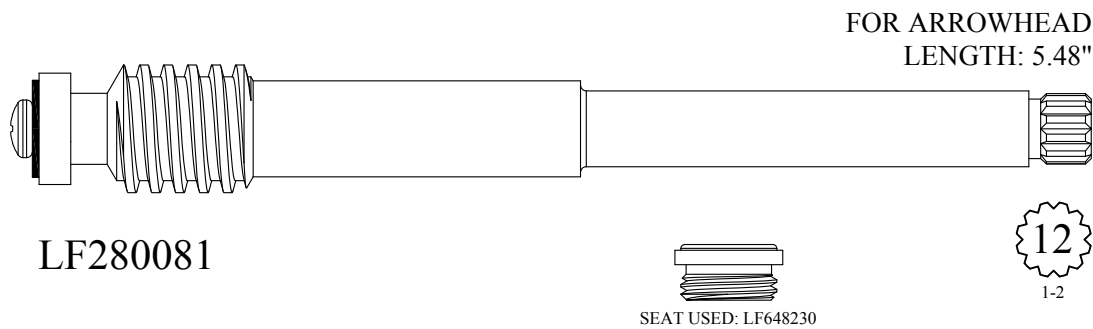

LF280081

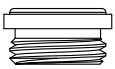
  
SEAT USED: LF648230

FOR ARROWHEAD  
LENGTH: 5.48"  
**12**  
1-2

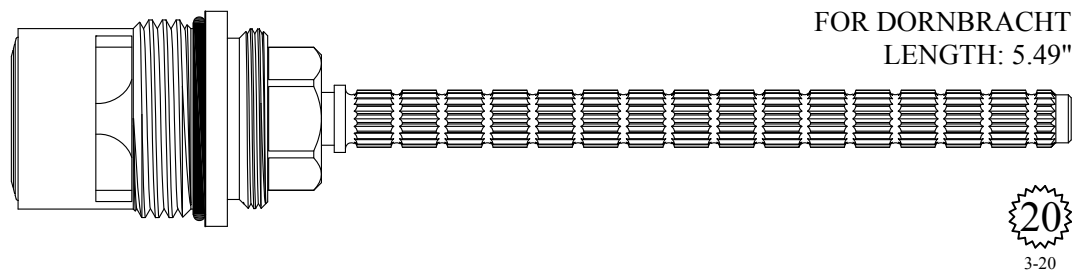

422601/ 422602  
GASKET: 890210 O-RING INCLUDED  
SEAL: 898520  
DISC SET: 109850-PKG

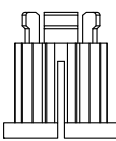
 **20**  
Comes with 20pt Grohe  
adapter: 103200

**20**  
3-20

FOR DORNBRACHT  
LENGTH: 5.49"

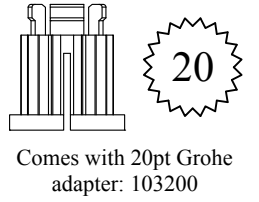
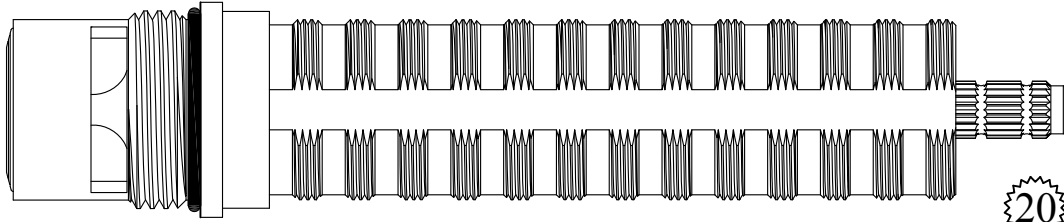

Comes with 20pt Grohe  
adapter: 103200



**422601-EN/ 422602-EN**

GASKET: 890210 O-RING INCLUDED  
SEAL: 898520  
DISC SET: 109850-PKG

Escutcheon Nipple available separately  
**125080**

Chrome Plated Stem

UNKNOWN  
LENGTH: 5.50"

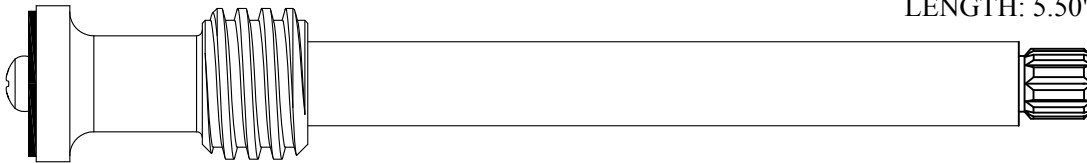

**221021**

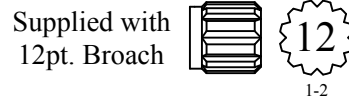

1-2

FOR WOLVERINE  
LENGTH: 5.50"

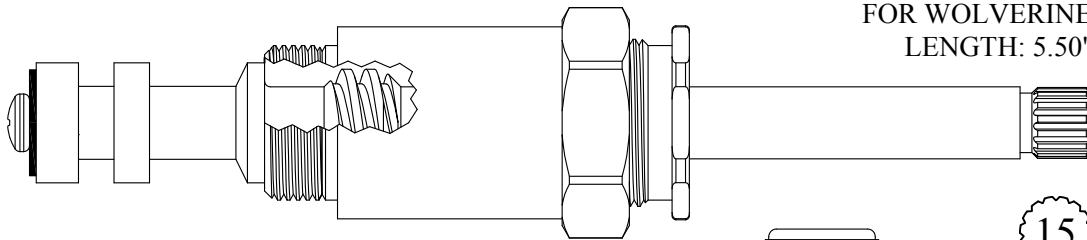

**418311**

GASKET: 895150

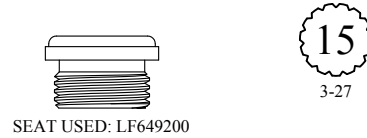

3-27

FOR WOLVERINE  
LENGTH: 5.50"

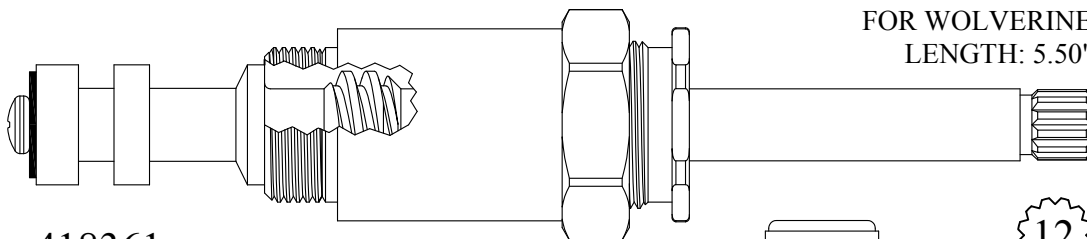

**418361**

GASKET: 895150

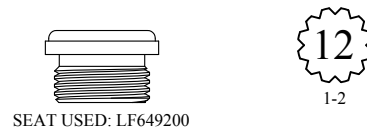

1-2

Chrome Plated Stem

FOR ART F  
LENGTH: 5.50"

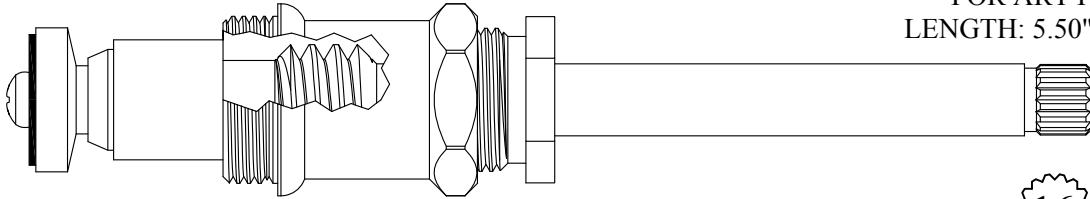

420501  
220501 Stem Only  
GASKET: 895400

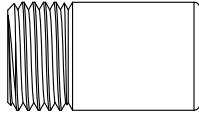

SEAT USED: 649260

16  
1-6

Chrome Plated Stem

FOR ART F  
LENGTH: 5.50"

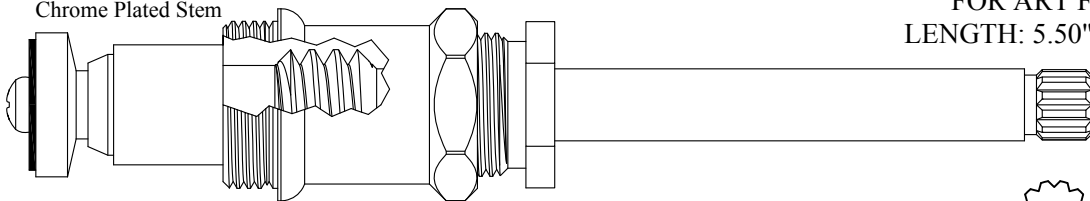

420551  
220551 Stem Only  
GASKET: 895400

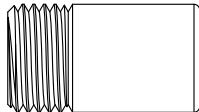

SEAT USED: 649260

12  
1-2

Chrome Plated Stem

FOR ART F  
LENGTH: 5.50"

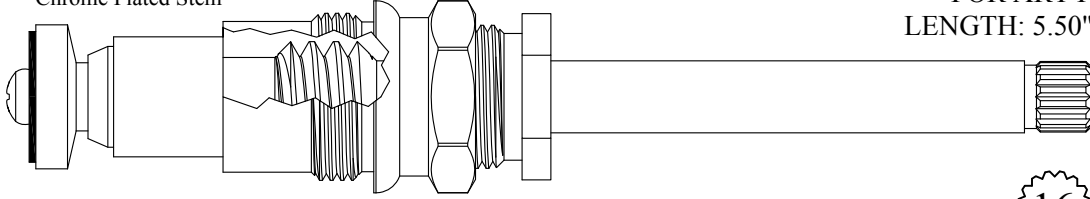

420511  
220501 Stem Only  
GASKET: 895400



SEAT USED: LF649430

16  
1-6

Chrome Plated Stem

FOR ART F  
LENGTH: 5.50"

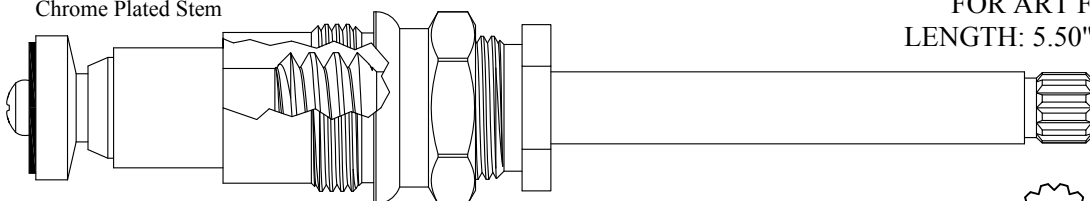

420561  
220551 Stem Only  
GASKET: 895400

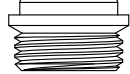

SEAT USED: LF649430

12  
1-2



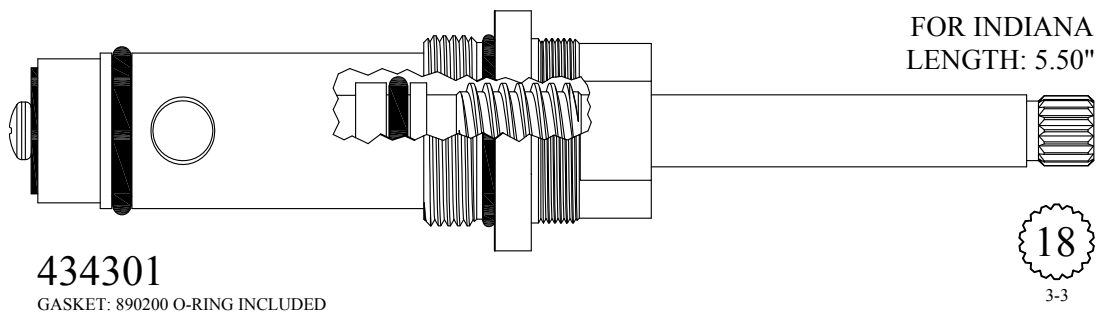
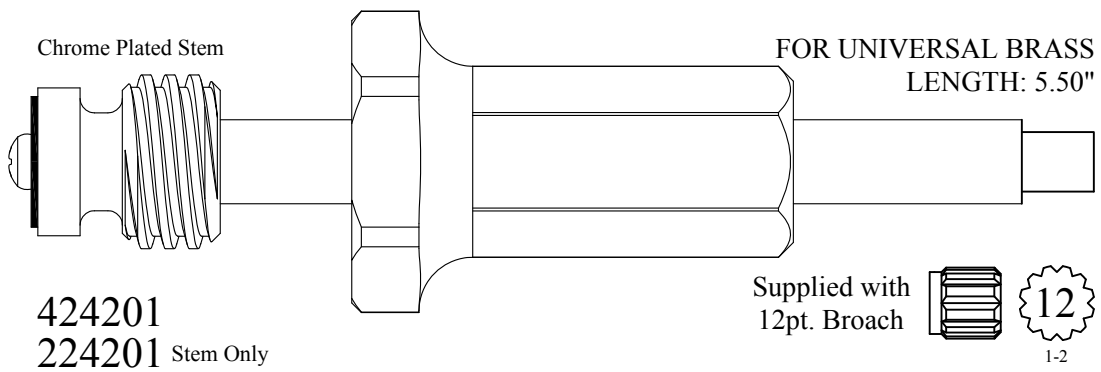
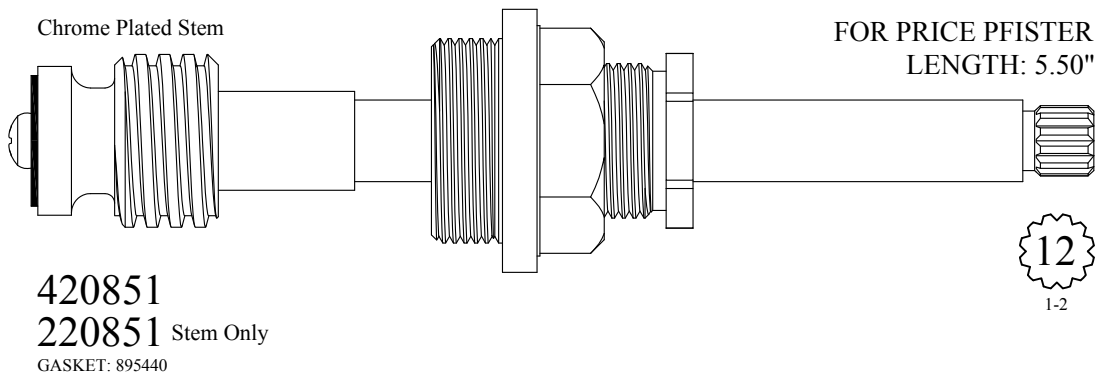
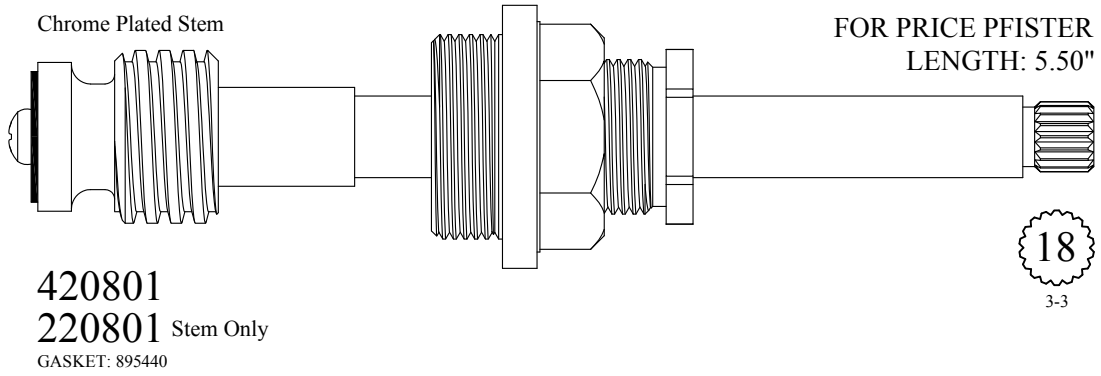

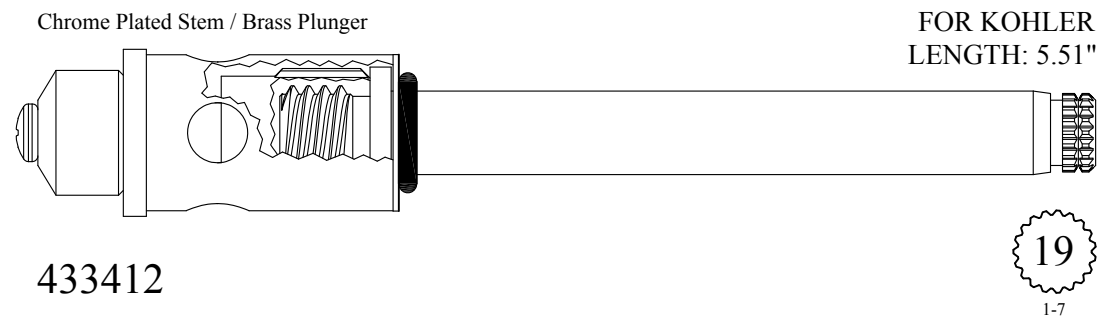
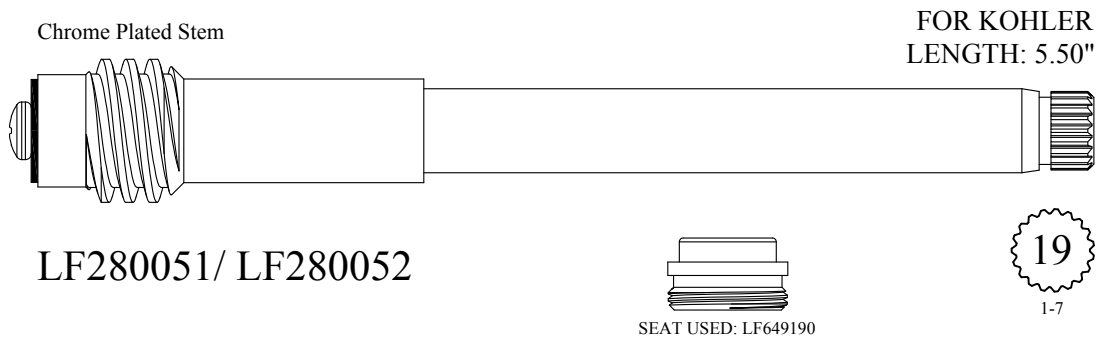
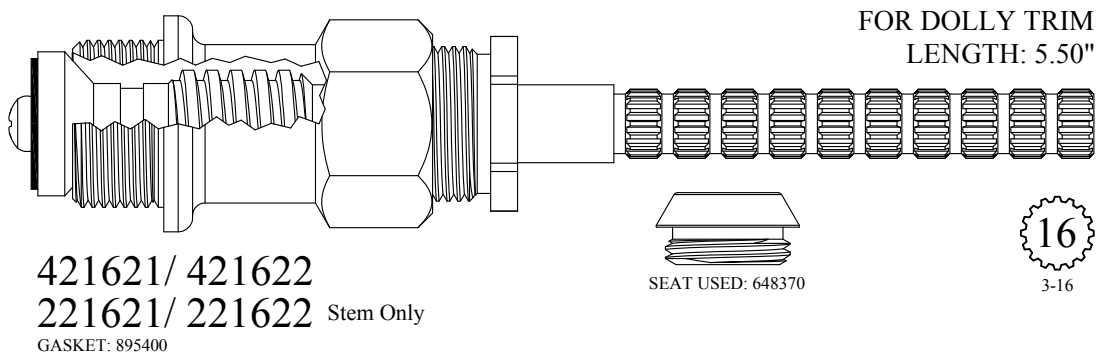
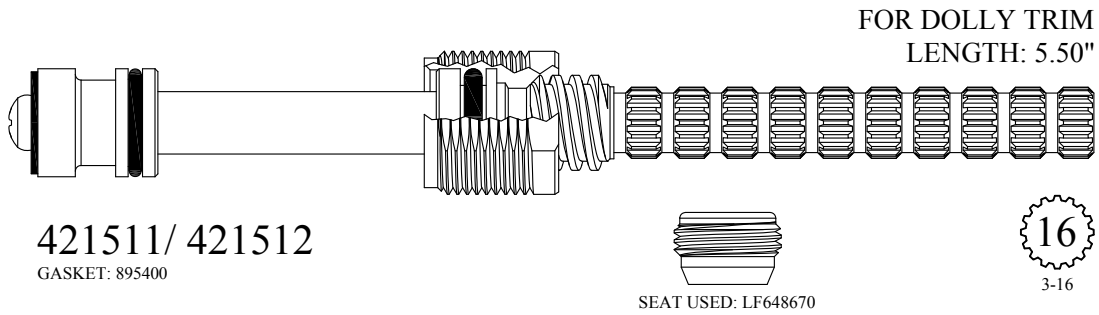

Chrome Plated Stem & Bonnet / Brass Plunger

FOR KOHLER  
LENGTH: 5.51"

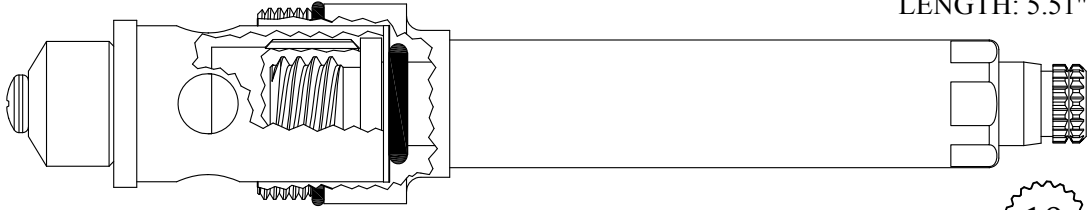

433422

GASKET: 890210 O-RING INCLUDED

19  
1-7

Chrome Plated Stem

UNKNOWN  
LENGTH: 5.52"

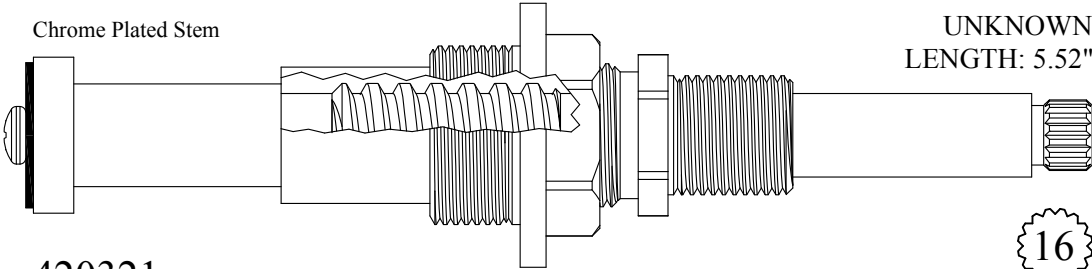

420321

GASKET: 895370

16  
1-6

Chrome Plated Unit

FOR BRIGGS  
LENGTH: 5.52"

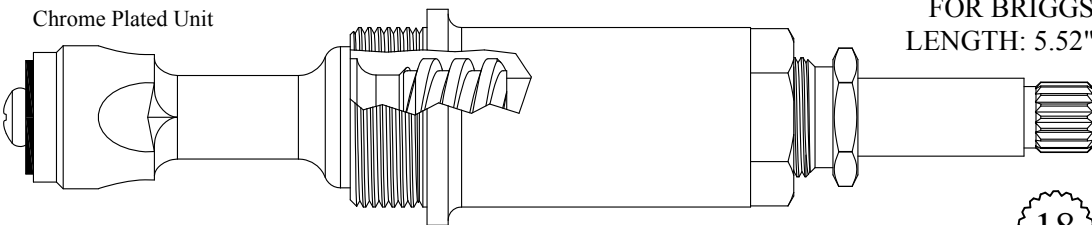

433712

233712 Stem Only

GASKET: 895370

18  
3-3

Chrome Plated Stem

FOR GERBER  
LENGTH: 5.52"

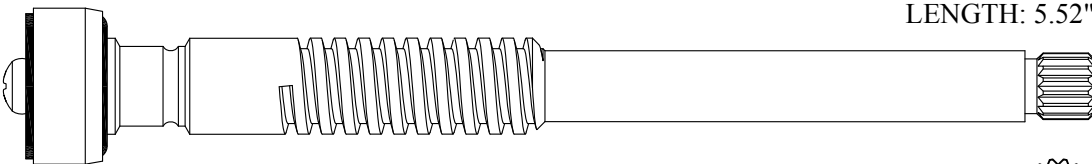

236411

16  
2-3

Chrome Plated Stem

FOR PRICE PFISTER  
LENGTH: 5.53"

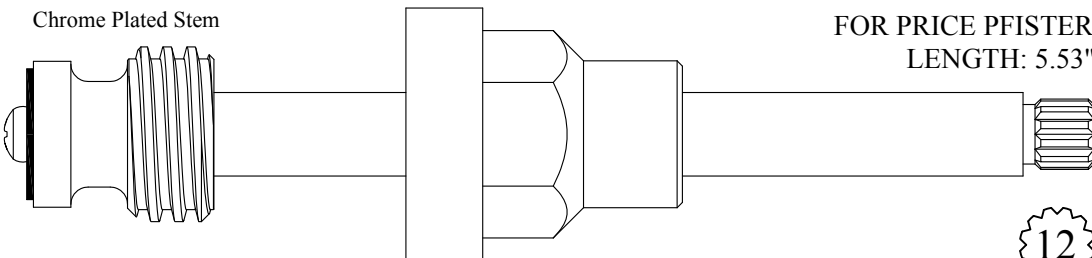

420861

220861 Stem Only

12  
1-2

Chrome Plated Unit

FOR APEX  
LENGTH: 5.53"

420951  
220951 Stem Only

Supplied with  
12pt. Broach

12  
1-2

Chrome Plated Unit

FOR BRIGGS  
LENGTH: 5.45"

421051  
220951 Stem Only

Supplied with  
12pt. Broach

12  
1-2

FOR DOLLY TRIM  
LENGTH: 5.53"

432021  
234731 Stem Only  
GASKET: 895560

SEAT USED: 648370

16  
3-16

FOR DOLLY TRIM  
LENGTH: 5.53"

434731  
234731 Stem Only  
GASKET: 895550

SEAT USED: 648370

16  
3-16

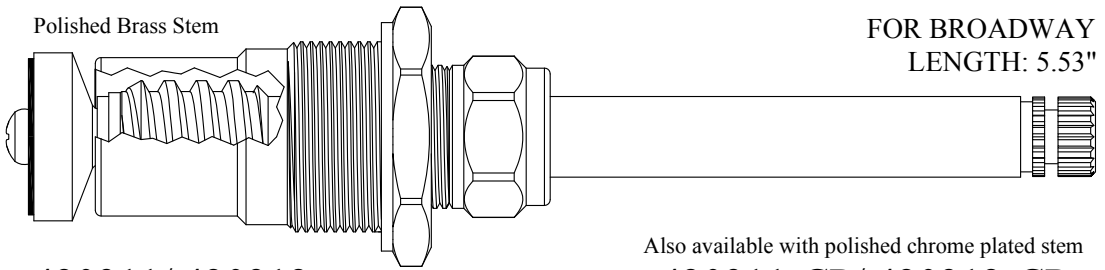

20  
2-4

420311/ 420312  
220311/ 220312 Stem Only  
GASKET: 895570

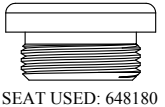

SEAT USED: 648180

Also available with polished chrome plated stem  
420311-CP/ 420312-CP  
220311-CP/ 220312-CP Stem Only

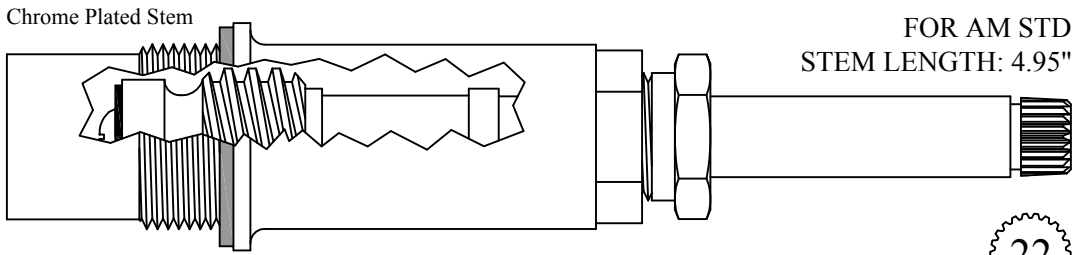

22  
1-4

412311  
LF278011 Stem Only  
GASKET INCLUDED: 895350

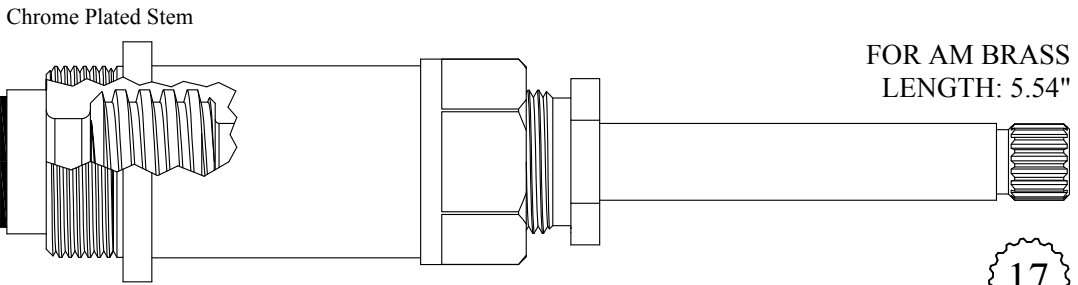

17  
3-7

421201  
221201 Stem Only  
GASKET: 895550



SEAT USED: LF648140

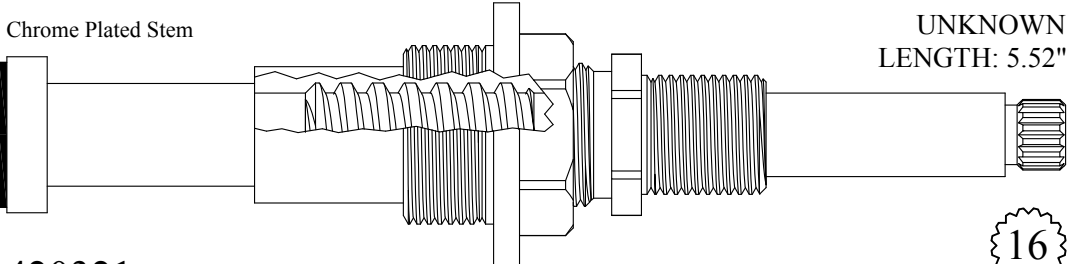

16  
1-6

420321  
GASKET: 895370

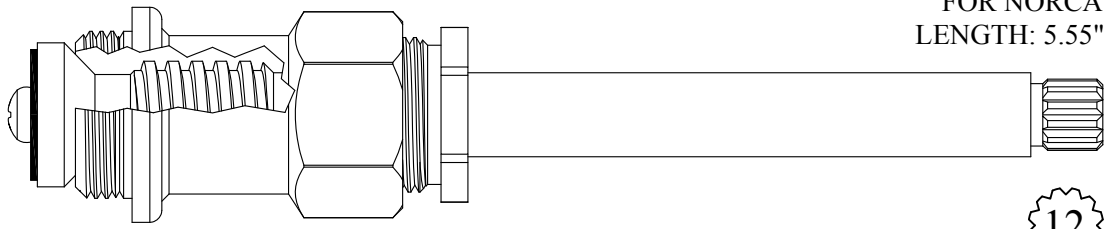

FOR NORCA  
LENGTH: 5.55"

12  
1-2

421631  
GASKET: 895400

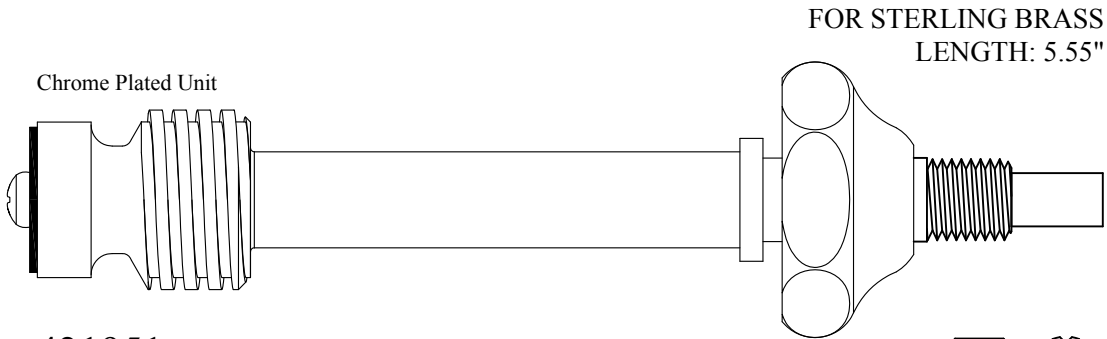

FOR STERLING BRASS  
LENGTH: 5.55"

Chrome Plated Unit

Supplied with  
12pt. Broach  12  
1-2

421951  
221951 Stem Only

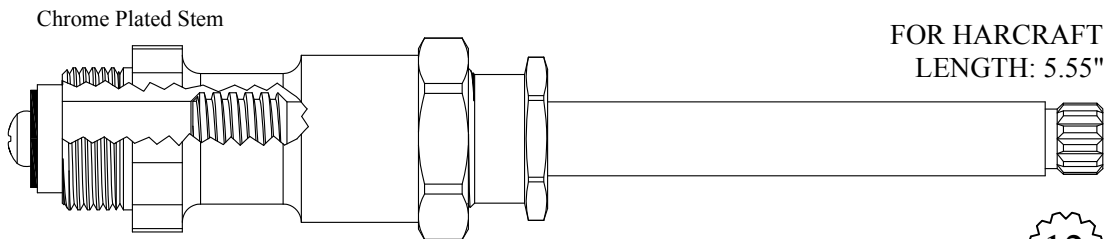

FOR HARCRAFT  
LENGTH: 5.55"

Chrome Plated Stem

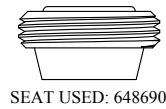

SEAT USED: 648690

12  
1-2

423001  
223001 Stem Only  
GASKET: 895100

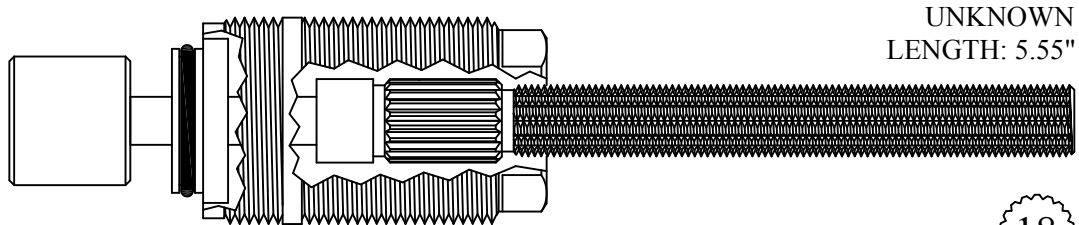

UNKNOWN  
LENGTH: 5.55"

18  
3-3

434610

19  
1-7

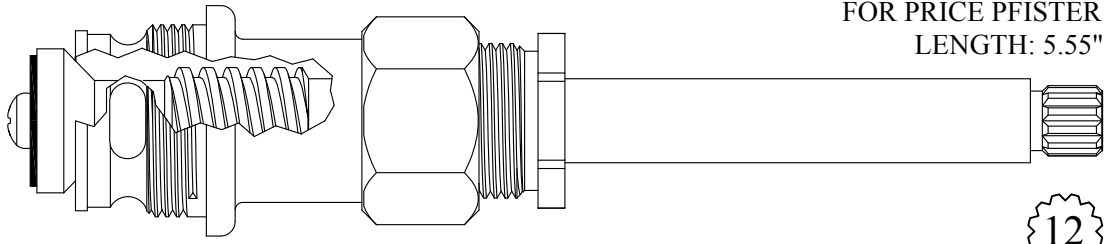

FOR PRICE PFISTER  
LENGTH: 5.55"

**434701**  
**234701** Stem Only  
GASKET: 895550

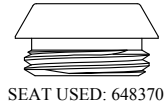

12  
1-2

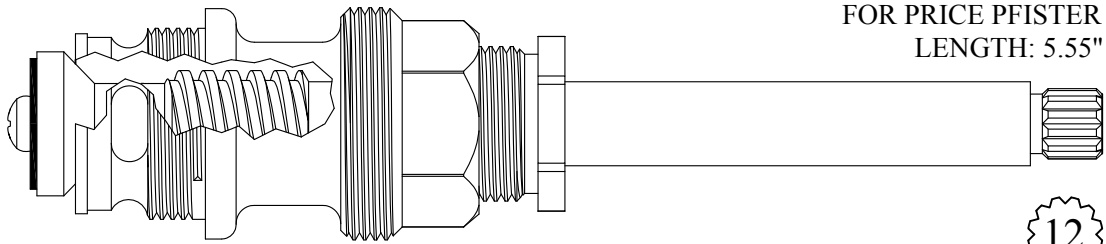

FOR PRICE PFISTER  
LENGTH: 5.55"

**434711**  
**234701** Stem Only  
GASKET: 895550



12  
1-2

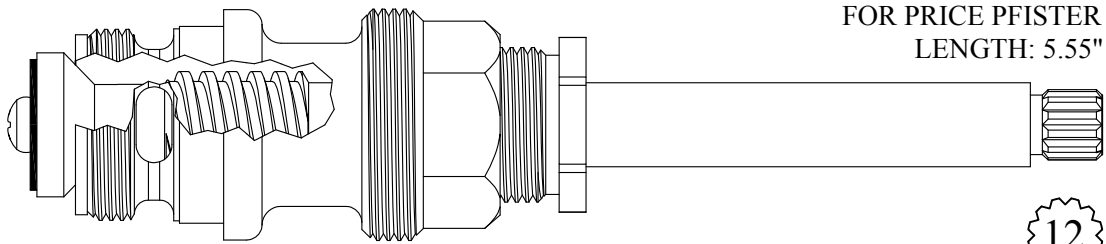

FOR PRICE PFISTER  
LENGTH: 5.55"

**434751**  
**234701** Stem Only  
GASKET: 895560



12  
1-2

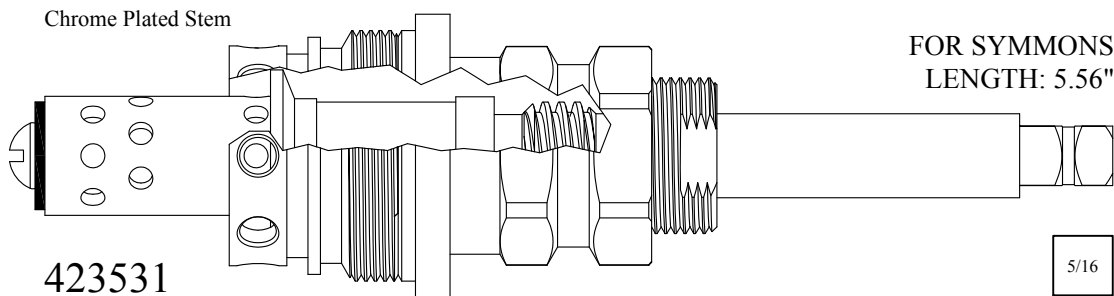

Chrome Plated Stem

FOR SYMMONS  
LENGTH: 5.56"

**423531**  
**223531** Stem Only  
GASKET: 895500 INCLUDED

5/16

FOR NEWPORT  
FOR PHYLRICH  
LENGTH: 5.56"

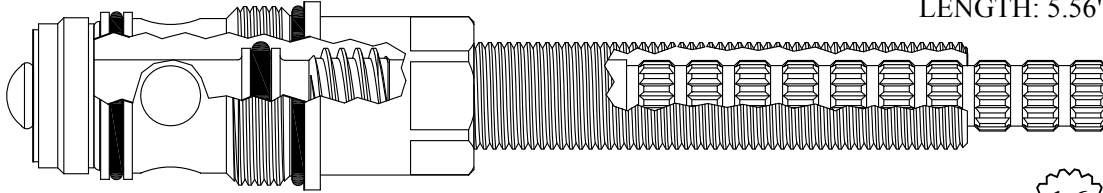

433371

GASKET: 890190 O-RING INCLUDED

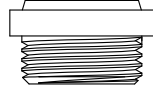

SEAT USED: 647650

16  
1-6

FOR PRICE PFISTER  
LENGTH: 5.55"

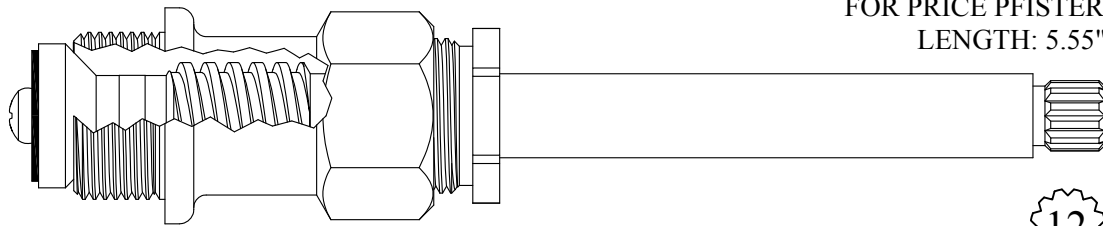

421601/ 421602

221601/ 221602 Stem Only

GASKET: 895400

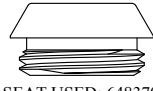

SEAT USED: 648370

12  
1-2

FOR PRICE PFISTER  
LENGTH: 5.55"

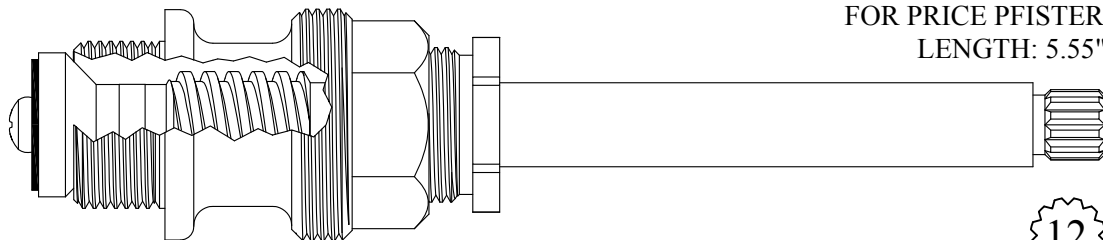

421611/ 421612

221601/ 221602 Stem Only

GASKET: 895400

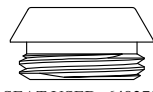

SEAT USED: 648370

12  
1-2

1/2 Turn Ceramic

FOR GERBER  
LENGTH: 5.56"

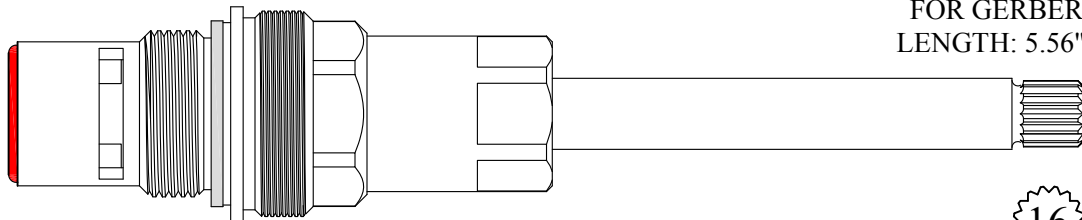

422411/ 422412

GASKET: 895180 INCLUDED

SEAL: 898570-R/B

DISC SET: 124290-PKG

16  
2-3



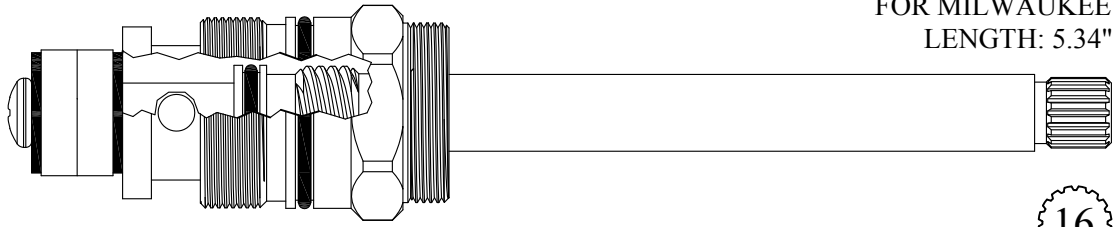

FOR MILWAUKEE  
LENGTH: 5.34"

**434721**

GASKET: 890200 O-RING INCLUDED

16  
3-15

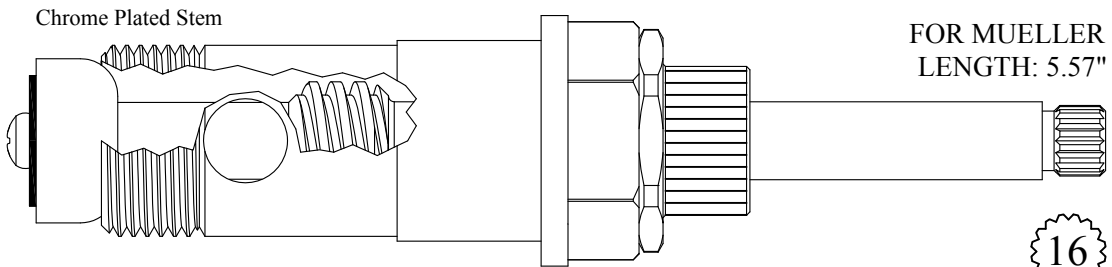

Chrome Plated Stem

FOR MUELLER  
LENGTH: 5.57"

**434821**

GASKET: 895440

16  
1-6

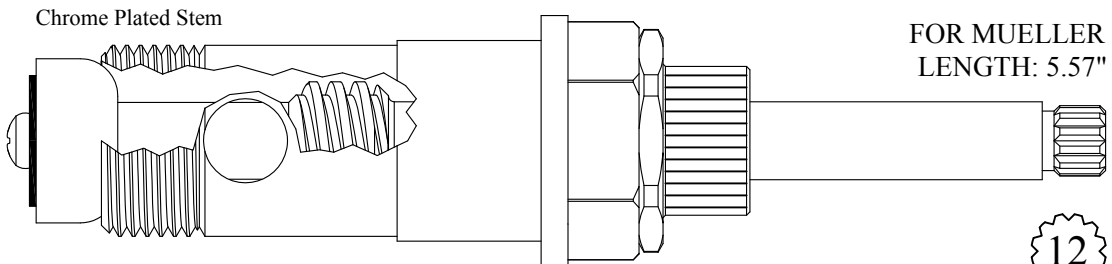

Chrome Plated Stem

FOR MUELLER  
LENGTH: 5.57"

**434871**

**234871** Stem Only

GASKET: 895440

12  
1-2

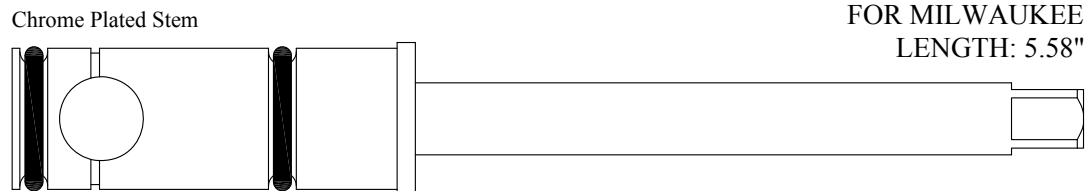

Chrome Plated Stem

FOR MILWAUKEE  
LENGTH: 5.58"

**237420**

5/16

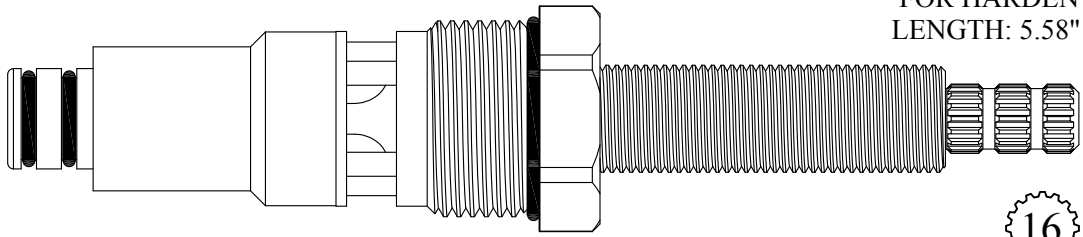

FOR HARDEN  
LENGTH: 5.58"

16  
3-16

423931/ 423932

GASKET: 890210 O-RING INCLUDED  
DISC SET: 151380-PKG



Chrome Plated Stem

FOR CENTRAL  
LENGTH: 5.59"

16  
1-6

222201

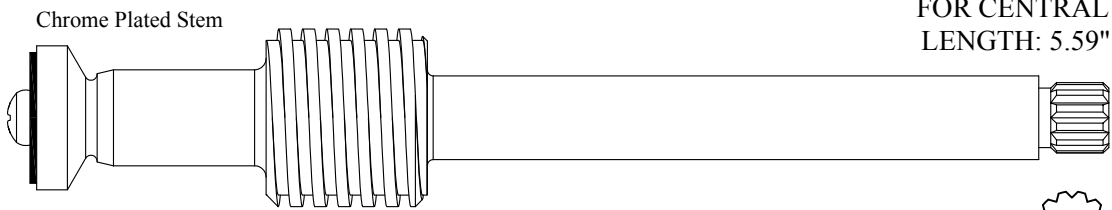

Chrome Plated Stem

FOR CENTRAL  
LENGTH: 5.59"

12  
1-2

222251

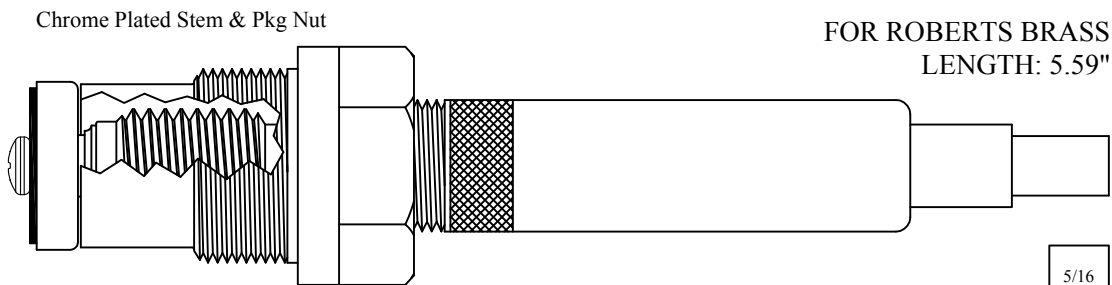

Chrome Plated Stem & Pkg Nut

FOR ROBERTS BRASS  
LENGTH: 5.59"

5/16

420711

220711 Stem Only

GASKET: 895450

Chrome Plated Stem & Pkg Nut

FOR ROBERTS BRASS  
LENGTH: 5.59"

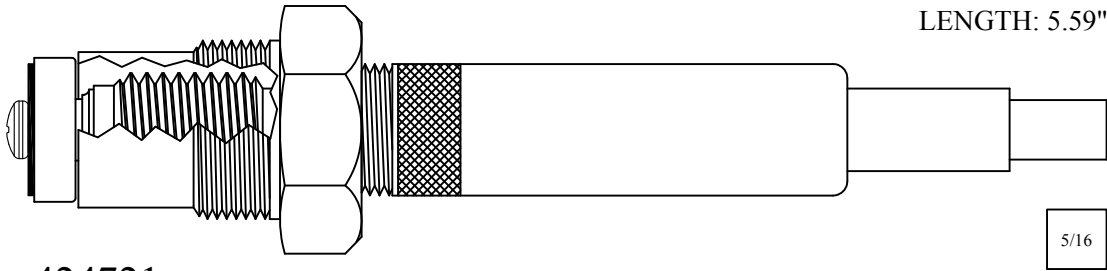

424721

224721 Stem Only

GASKET: 895320

Chrome Plated Stem

FOR CRANE  
LENGTH: 5.60"

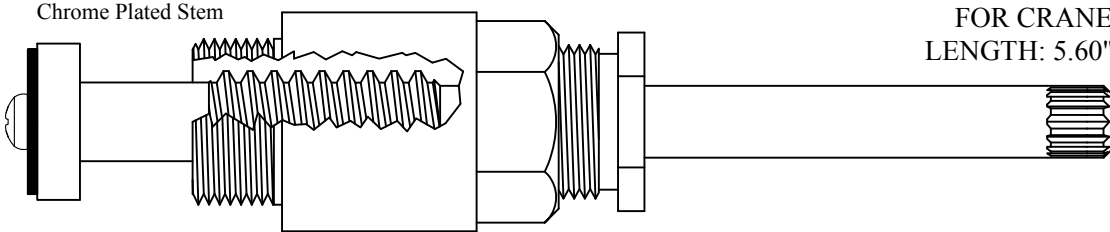

Not Available, Use 423151

Chrome Plated Stem

FOR CRANE  
LENGTH: 5.60"

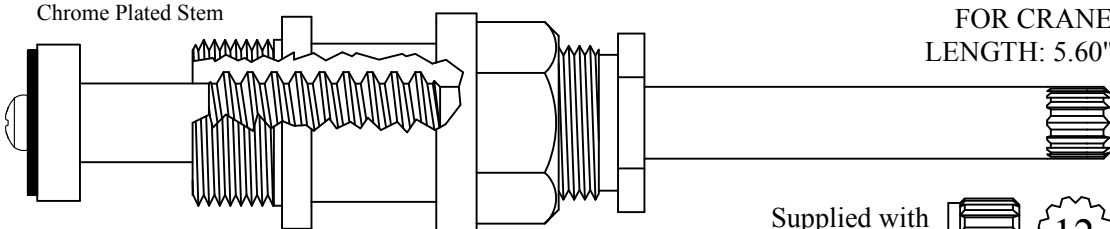

423151

223151 Stem Only

GASKET: 895400

Supplied with  
12pt. Broach



1-2



SEAT USED: 648370

Chrome Plated Stem

FOR ROYAL BRASS  
LENGTH: 5.60"

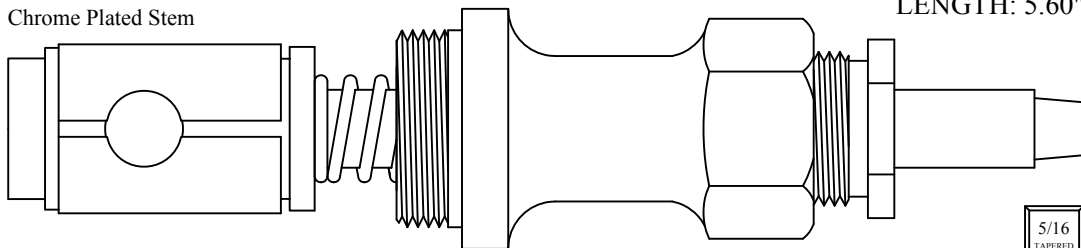

433540

233540 Stem Only

GASKET: 895560

Chrome Plated Stem

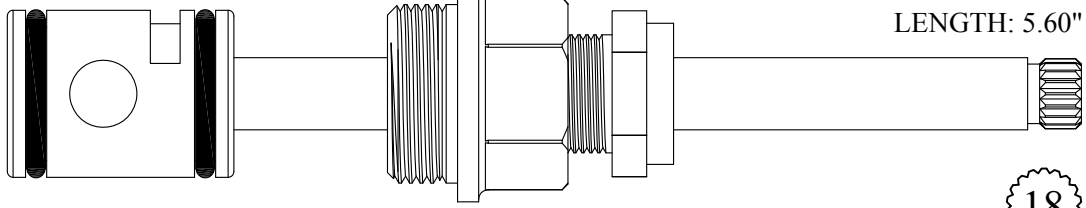

FOR UNION BRASS  
LENGTH: 5.60"

435200  
235200 Stem Only

18  
3-3

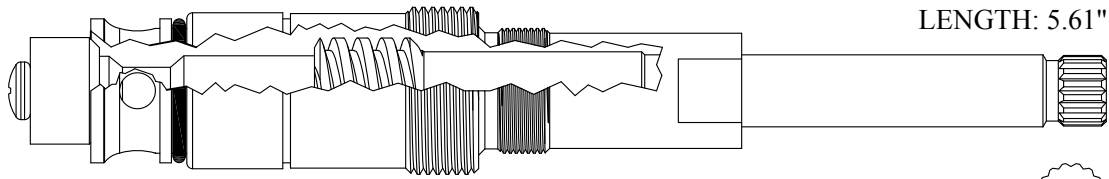

FOR AM STD  
LENGTH: 5.61"

433801  
233801 Stem Only  
WAVE WASHER INCLUDED: 897110

16

Chrome Plated Stem & Esc Tube

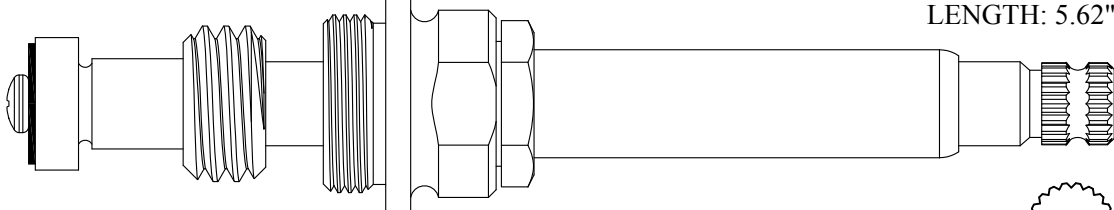

FOR SAVOY  
LENGTH: 5.62"

422711  
222711 Stem Only  
GASKET: 895320

20  
2-4

Chrome Plated Stem & Esc Tube

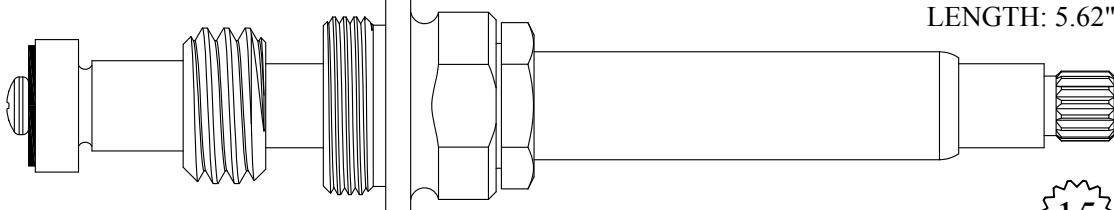

FOR SAVOY  
LENGTH: 5.62"

422721  
222721 Stem Only  
GASKET: 895320

15  
1-13

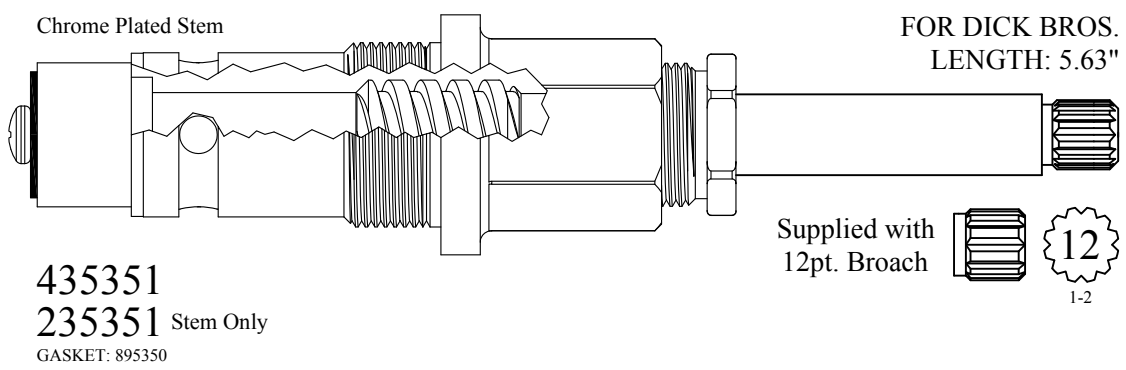
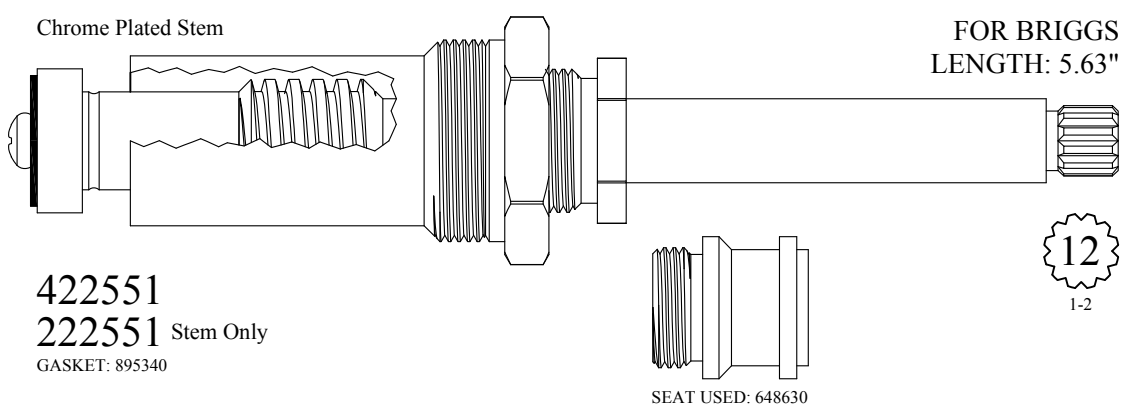
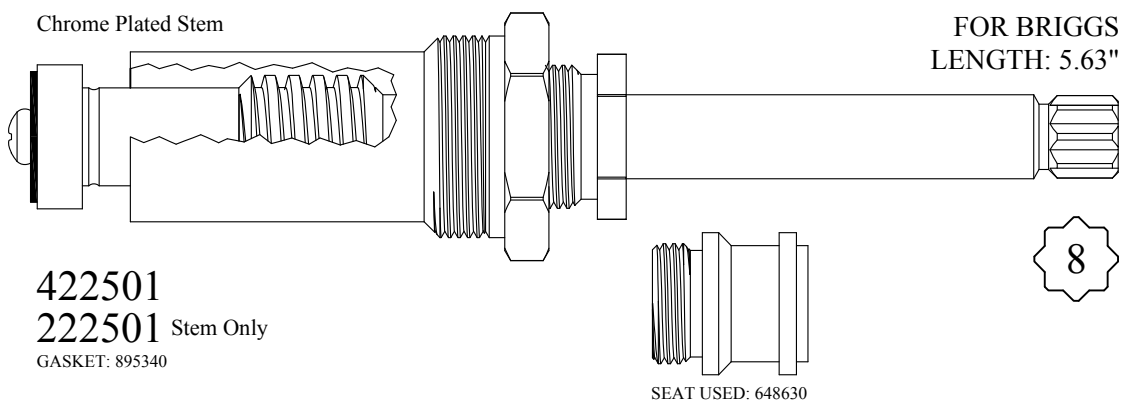
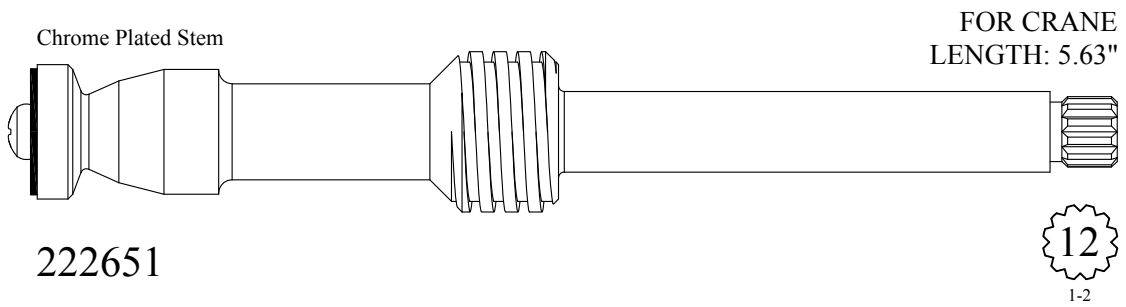

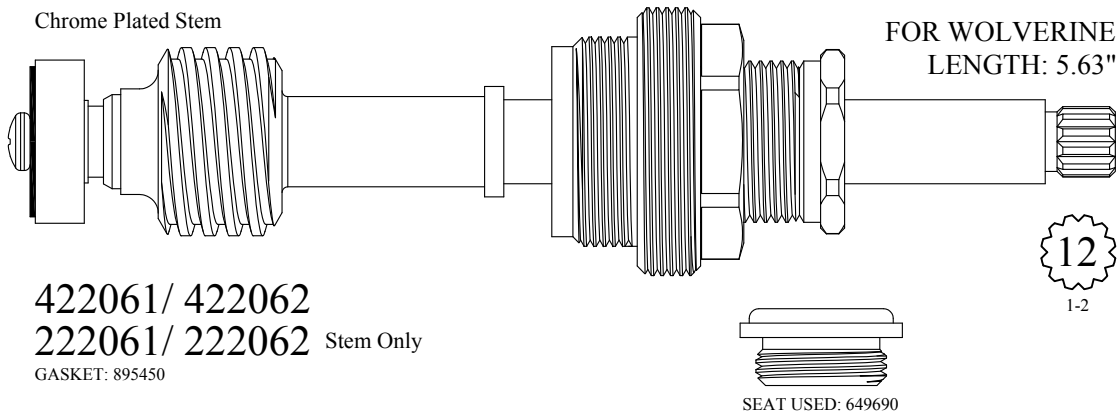
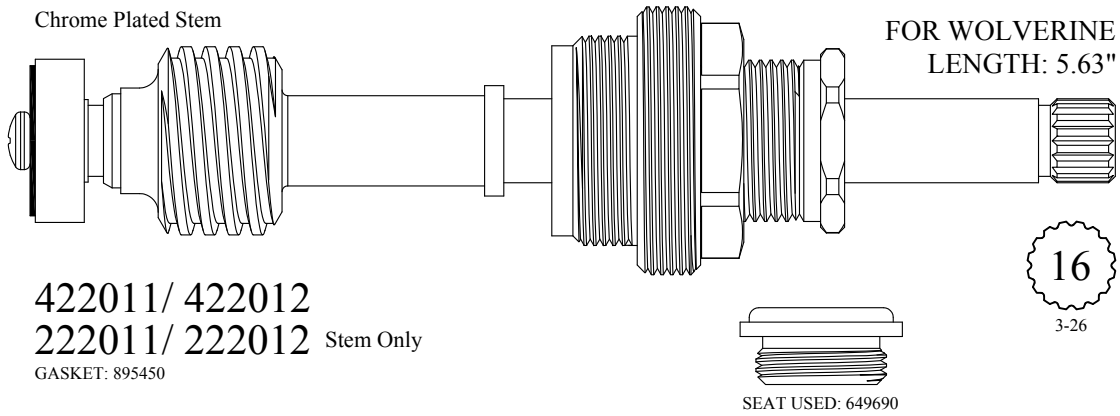
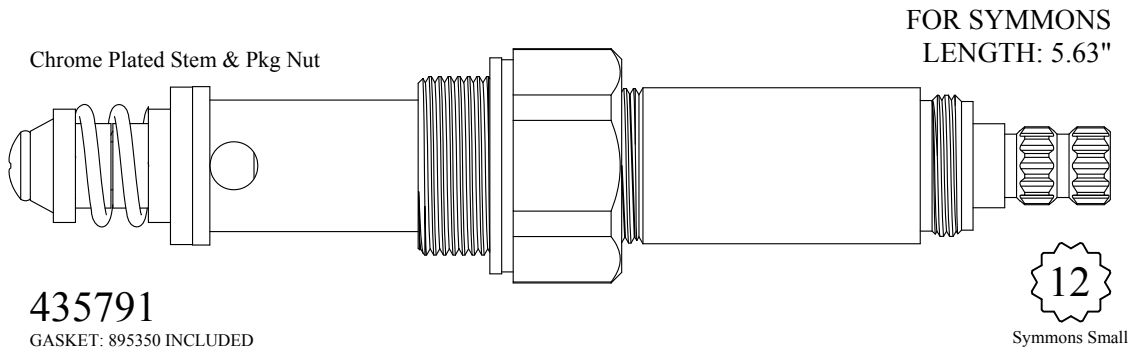
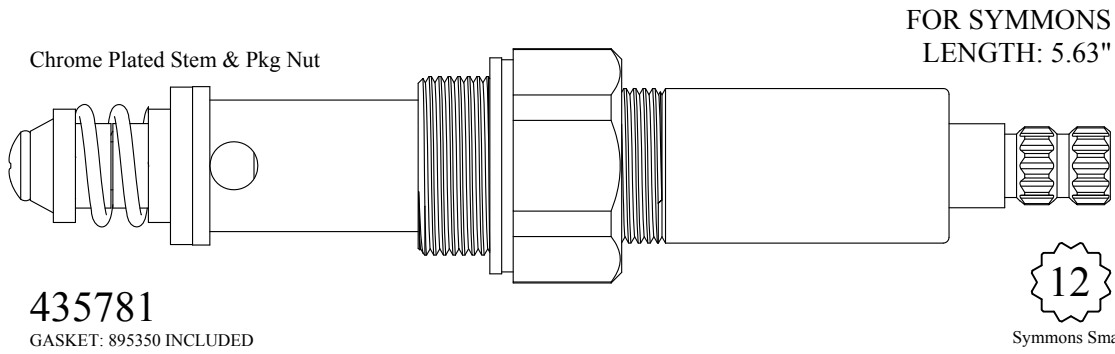

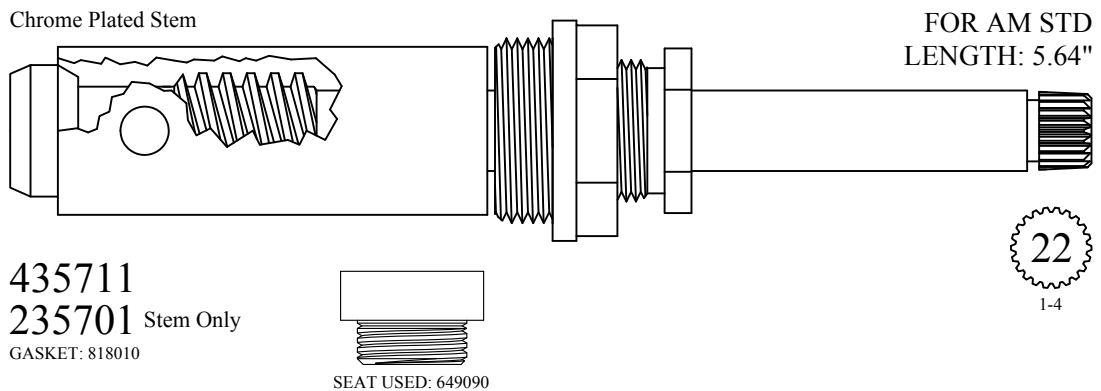
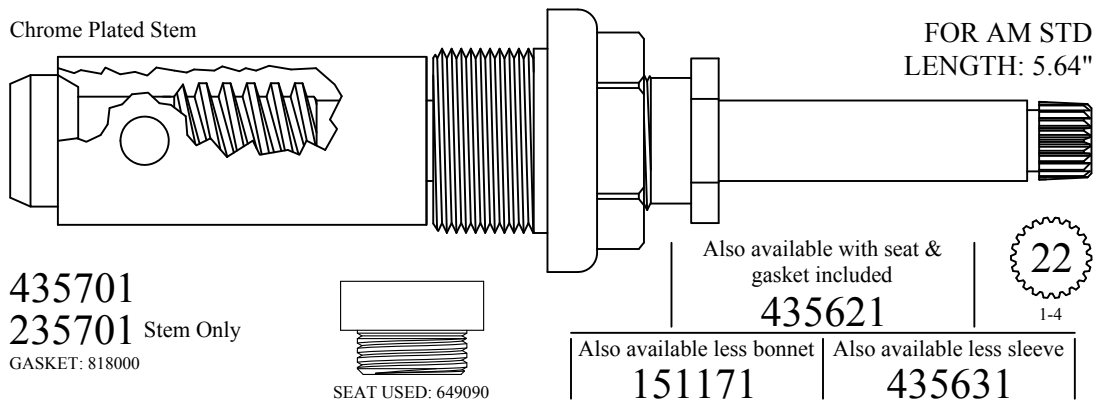
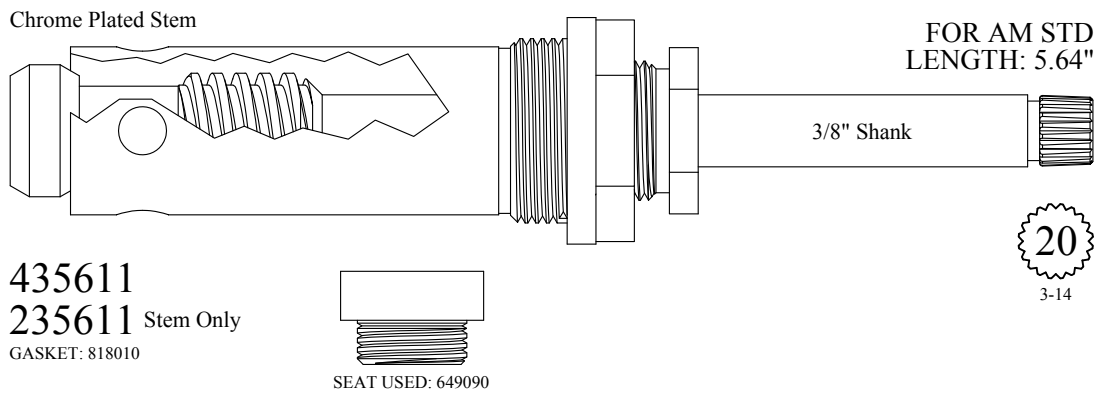
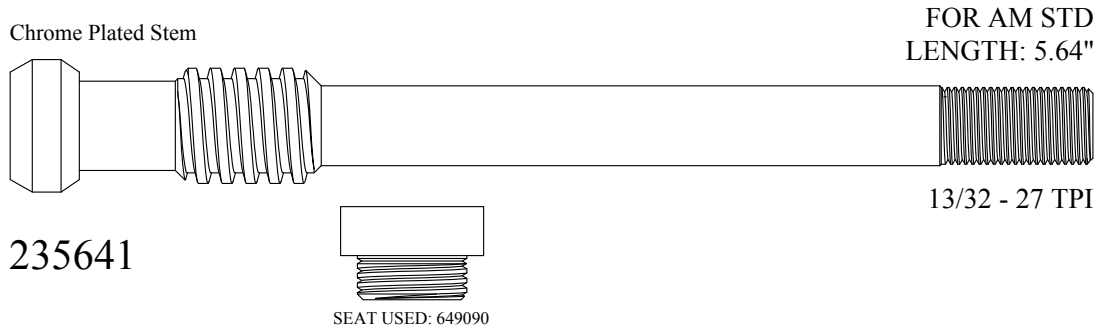

Chrome Plated Stem

FOR AM STD  
LENGTH: 5.64"

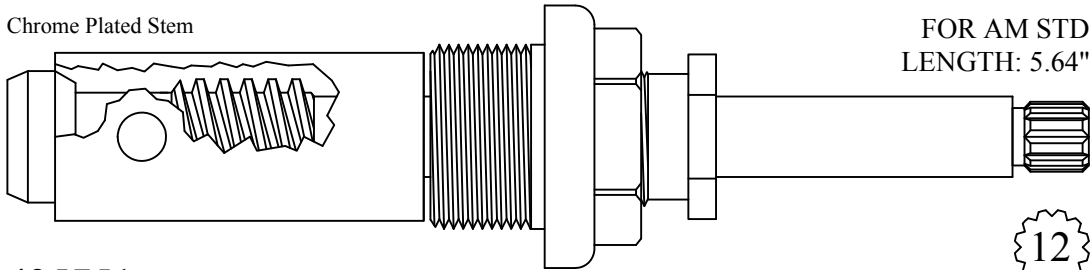

435751  
235751 Stem Only  
GASKET: 818000

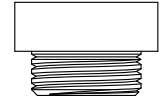

SEAT USED: 649090

12  
1-2

Chrome Plated Stem

FOR CRANE  
LENGTH: 5.64"

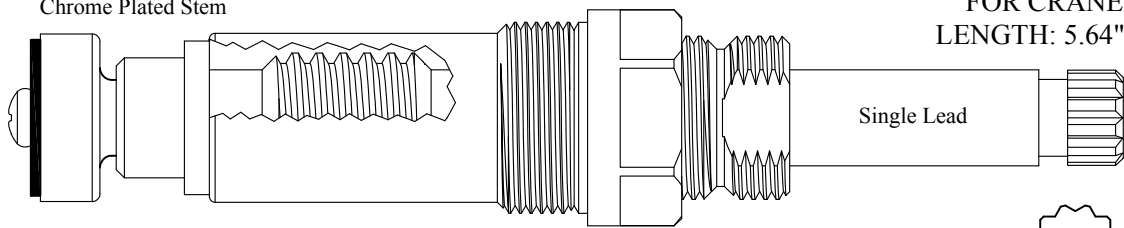

LF480101  
LF280101 Stem Only  
GASKET: 895340



SEAT USED: LF649660

12

Chrome Plated Stem

FOR CRANE  
LENGTH: 5.64"

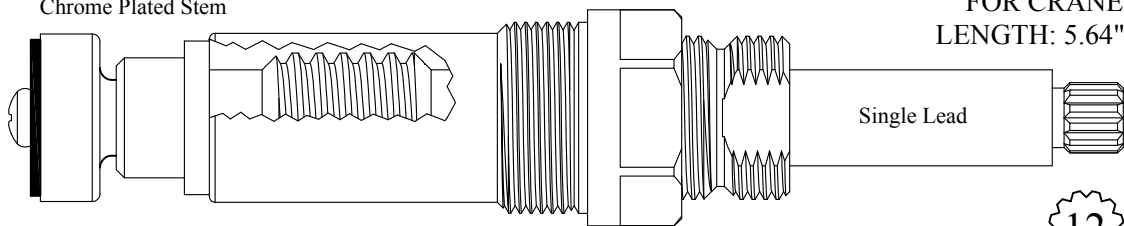

LF480111  
LF280111 Stem Only  
GASKET: 895340



SEAT USED: LF649660

12  
1-2

Chrome Plated Stem

FOR CRANE  
LENGTH: 5.64"

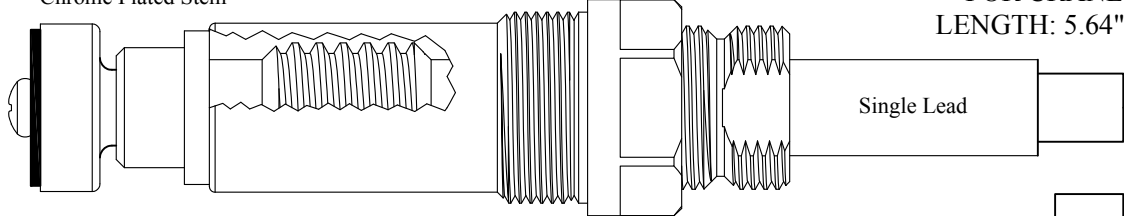

LF480121  
LF280121 Stem Only  
GASKET: 895340



SEAT USED: LF649660

23/64



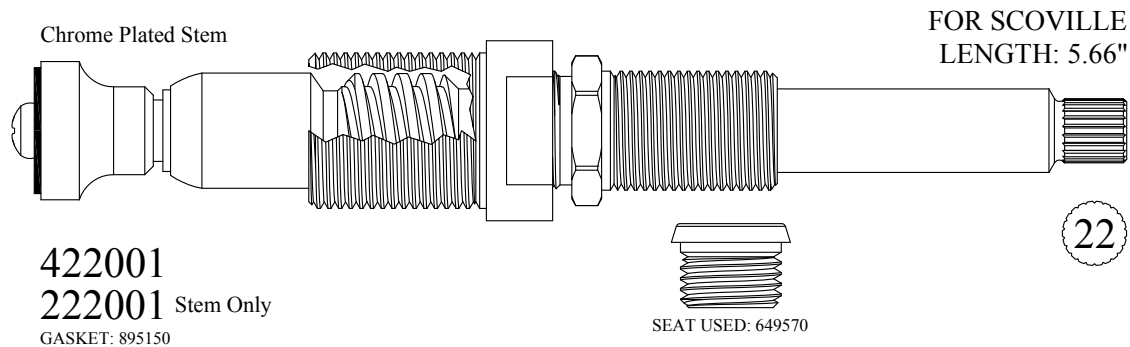
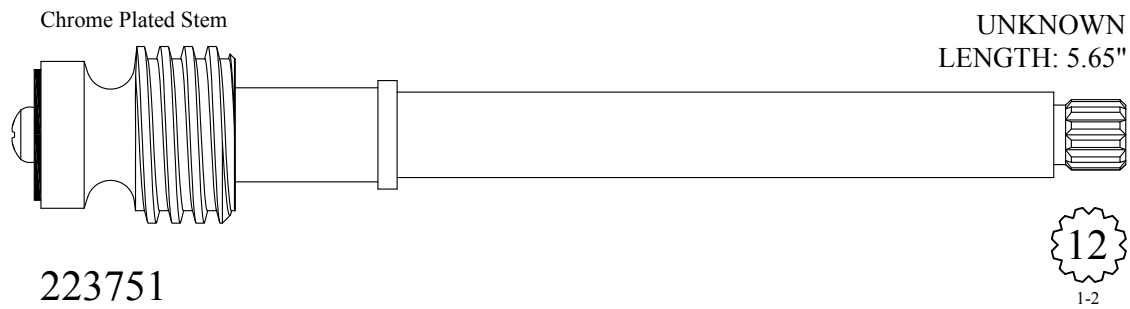
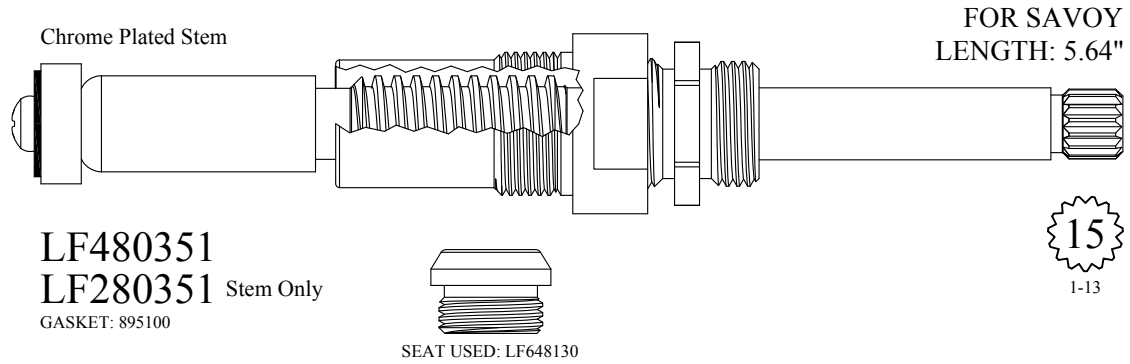
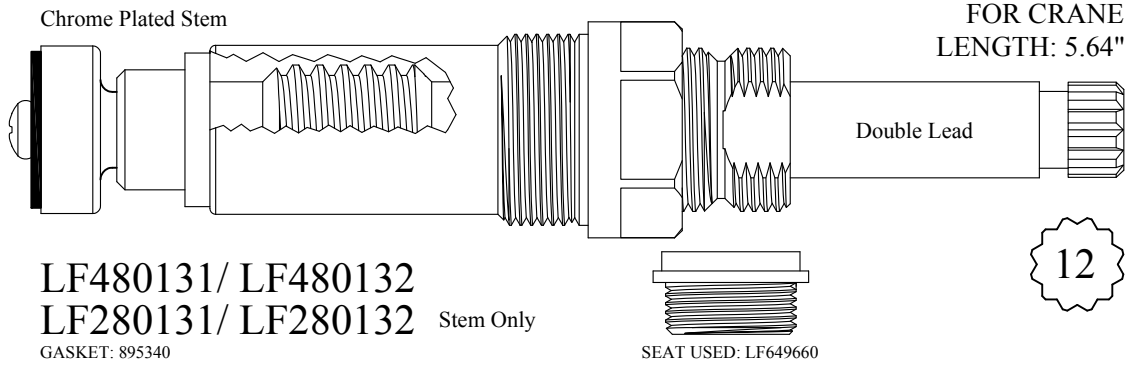

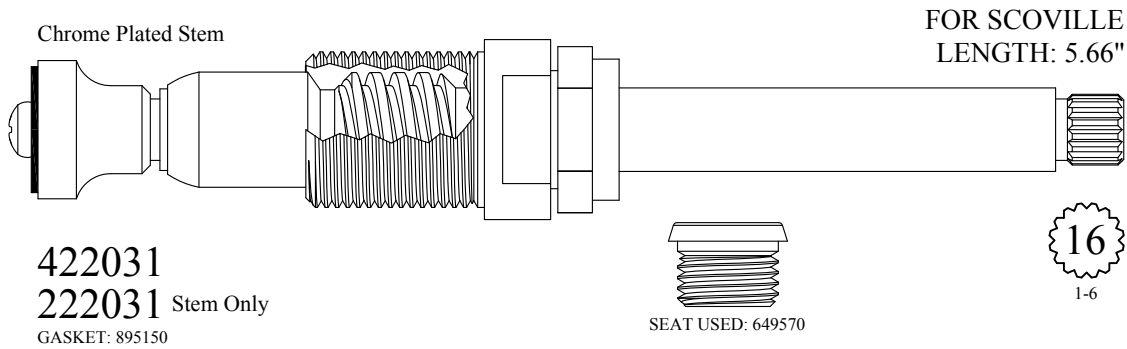

422031  
 222031 Stem Only  
 GASKET: 895150

SEAT USED: 649570

16  
 1-6

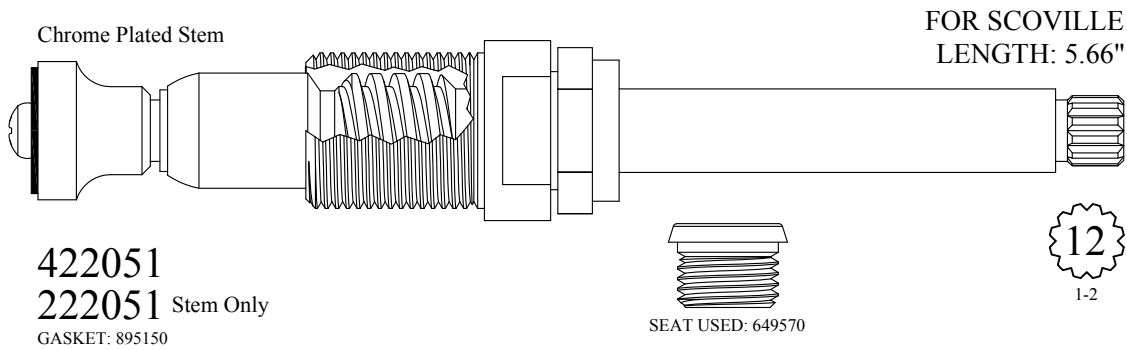

422051  
 222051 Stem Only  
 GASKET: 895150

SEAT USED: 649570

12  
 1-2

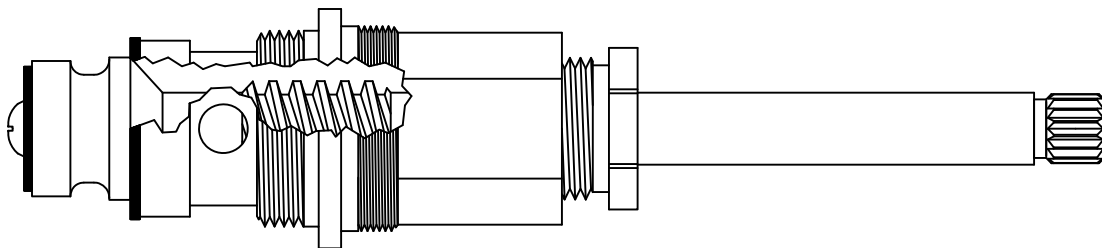

Old Style, Use 433401

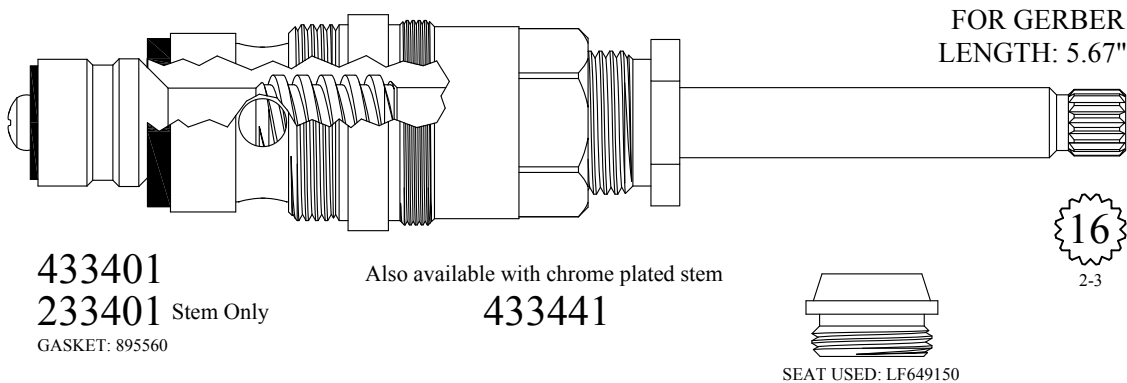

433401  
 233401 Stem Only  
 GASKET: 895560

Also available with chrome plated stem  
 433441

SEAT USED: LF649150

16  
 2-3

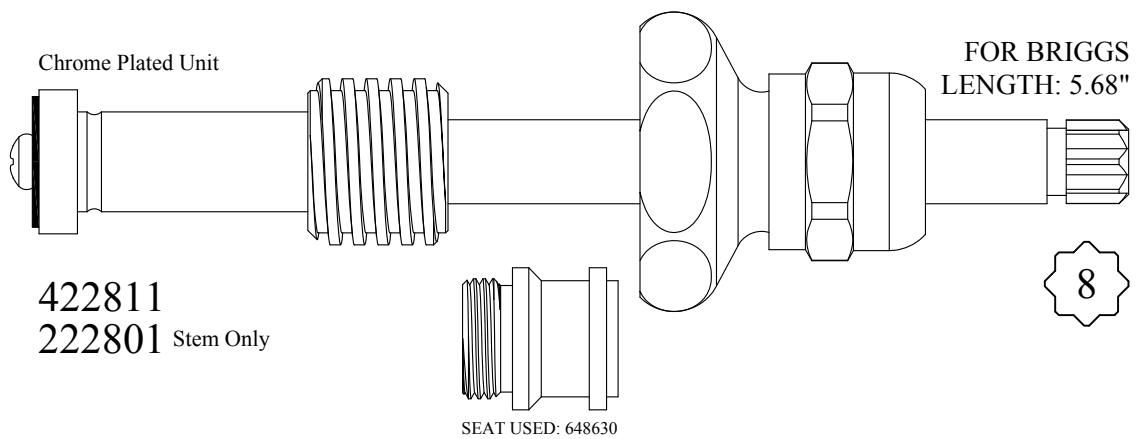
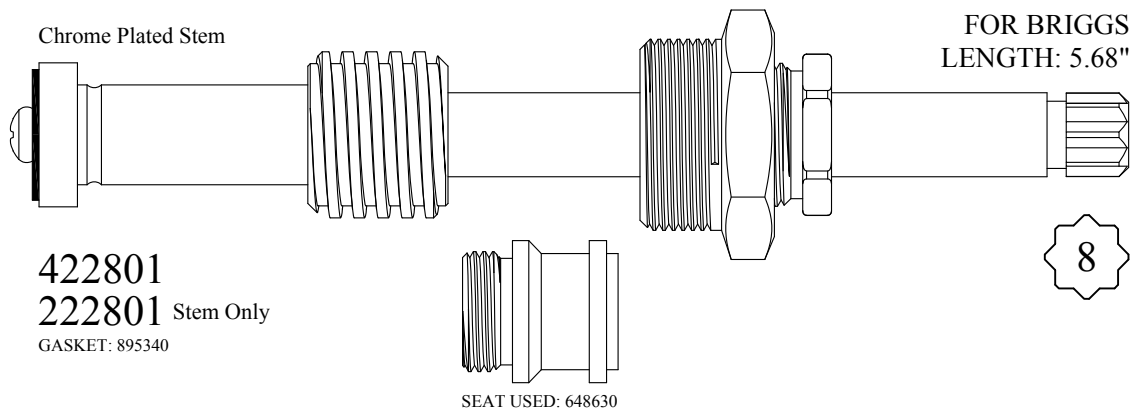
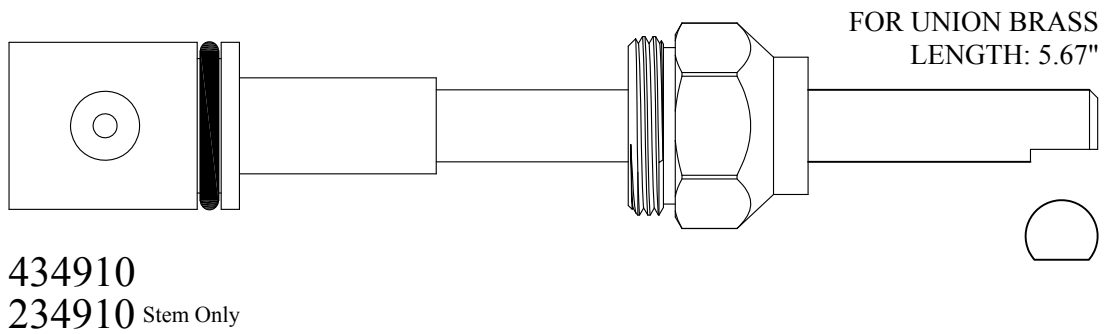
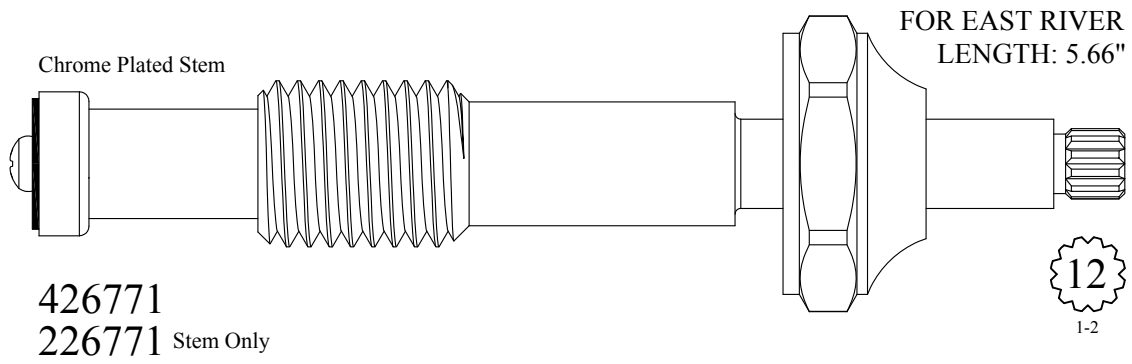

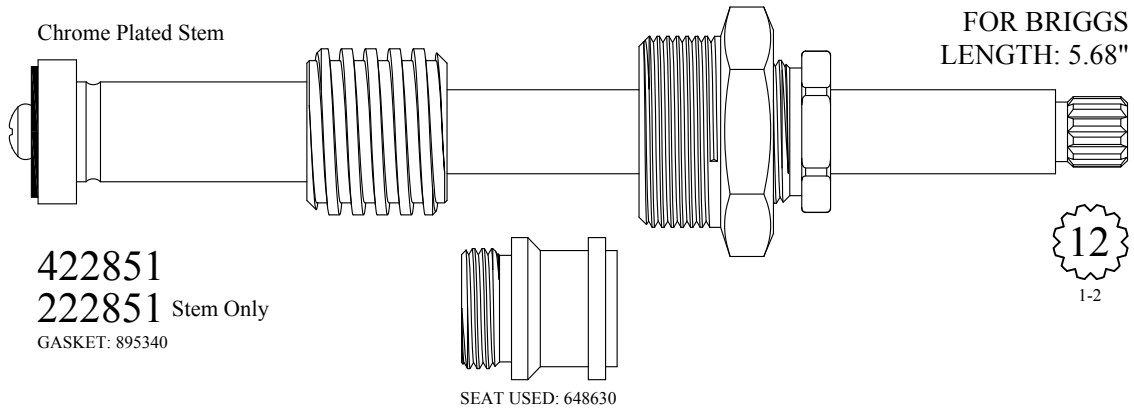

422851  
222851 Stem Only  
GASKET: 895340

12  
1-2

SEAT USED: 648630

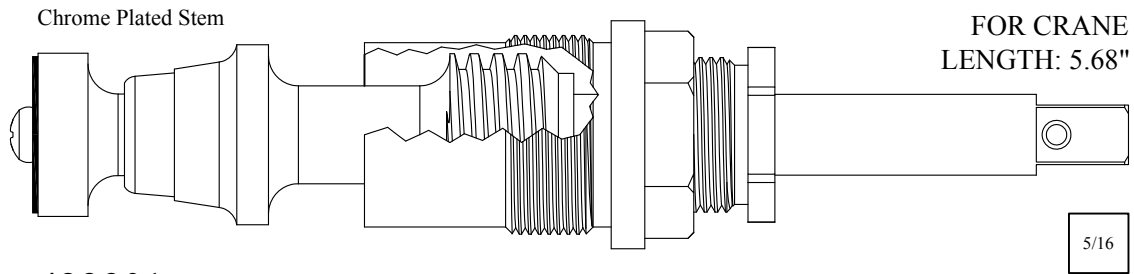

423901  
223901 Stem Only  
GASKET: 895440

5/16

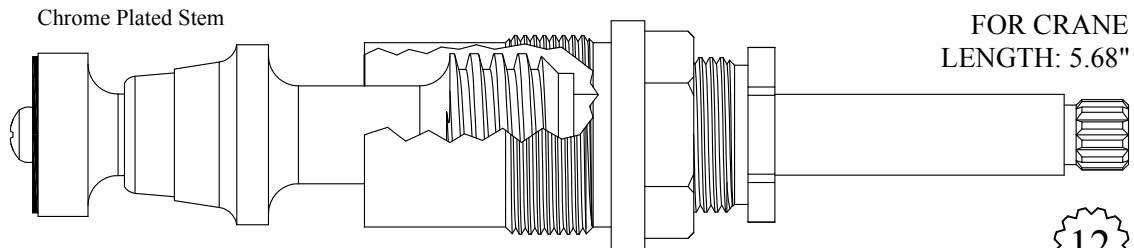

423951  
223951 Stem Only  
GASKET: 895440

12  
1-2

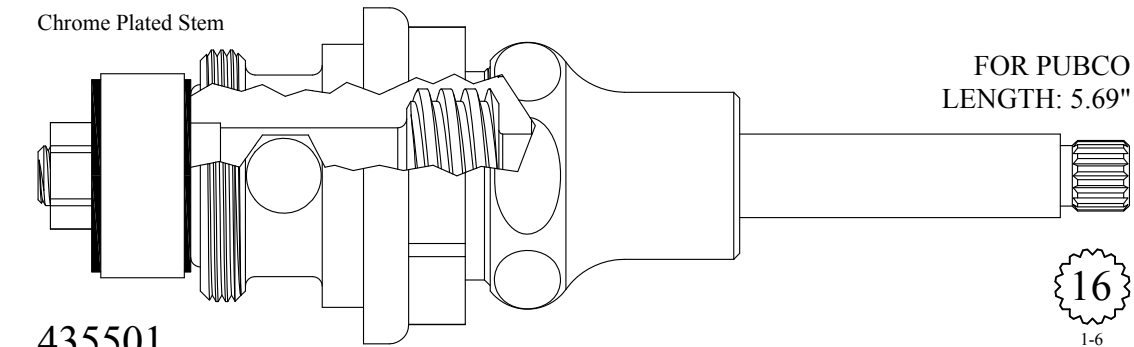

435501  
235501 Stem Only  
GASKET: 895500

16  
1-6

Chrome Plated Stem

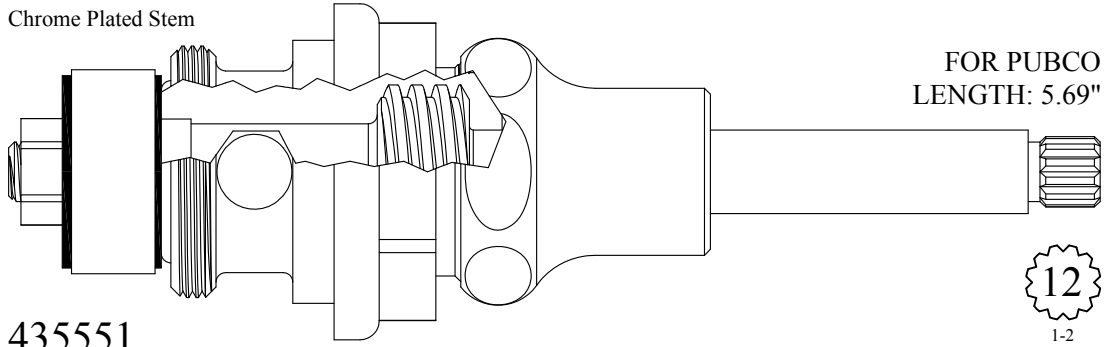

435551  
 235551 Stem Only  
 GASKET: 895500



Chrome Plated Stem

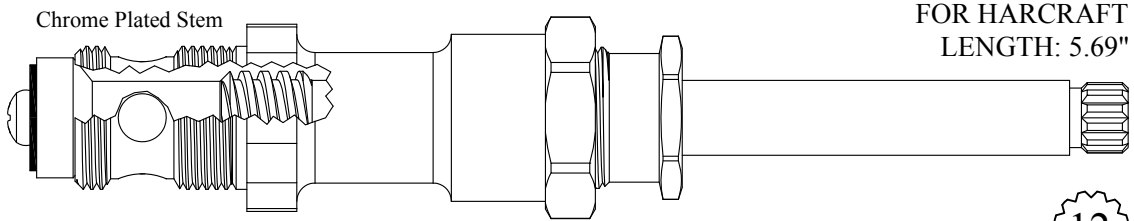



435721  
 235721 Stem Only  
 GASKET: 895100

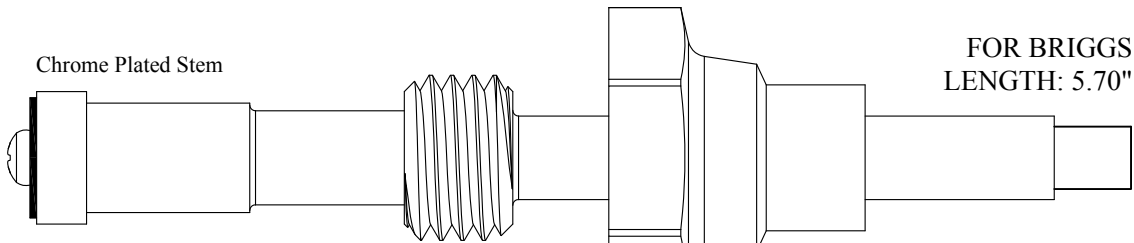

Chrome Plated Stem



417851  
 217851 Stem Only

Supplied with  
 12pt. Broach    
 1-2

Chrome Plated Stem

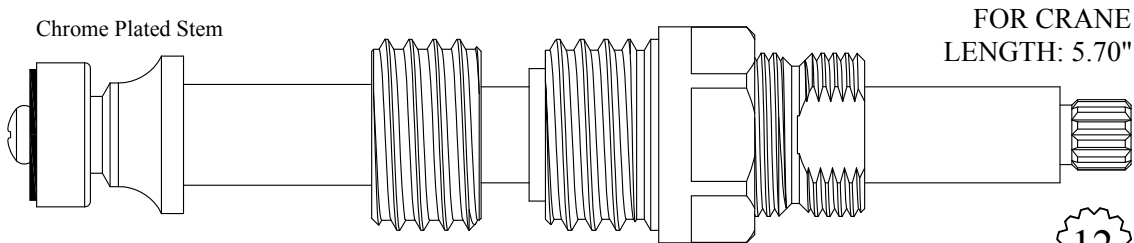

424561  
 224561 Stem Only  
 GASKET: 895340



Chrome Plated Stem

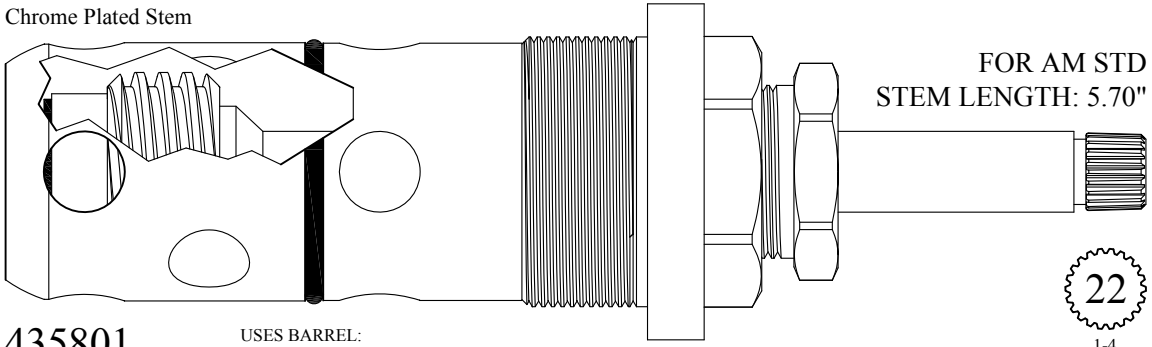

FOR AM STD  
STEM LENGTH: 5.70"



435801  
235801 Stem Only

USES BARREL:  
635801

Chrome Plated Stem

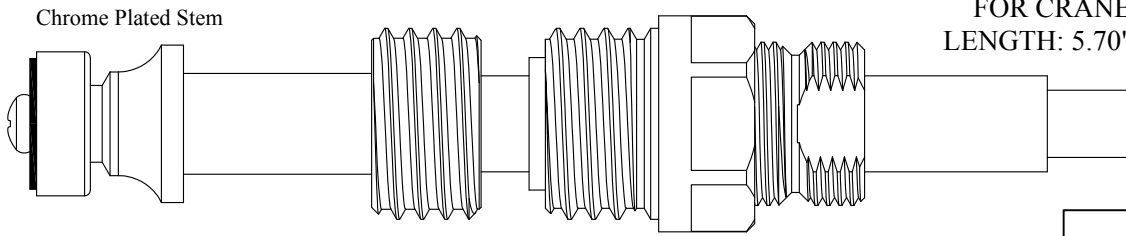

FOR CRANE  
LENGTH: 5.70"



424511/ 424512  
224511/ 224512 Stem Only  
GASKET: 895340

Chrome Plated Stem

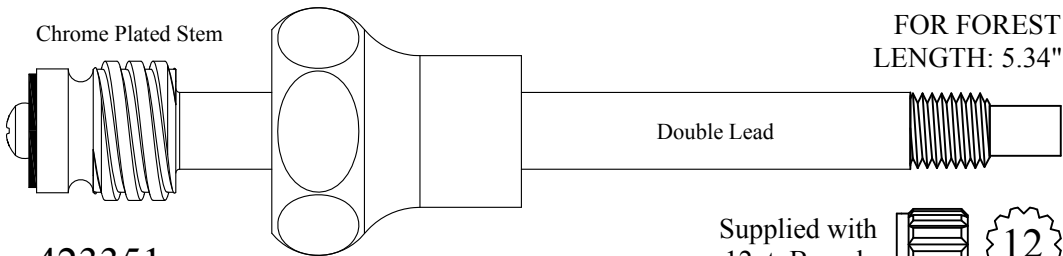

FOR FOREST  
LENGTH: 5.34"

Double Lead

Supplied with  
12pt. Broach

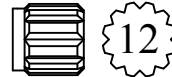

423351  
223351 Stem Only

Chrome Plated Stem

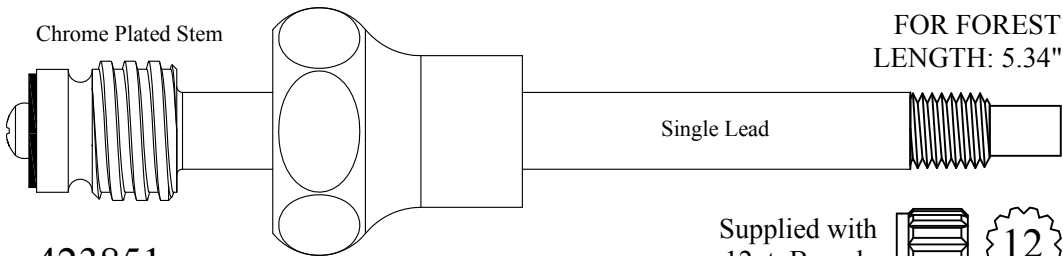

FOR FOREST  
LENGTH: 5.34"

Single Lead

Supplied with  
12pt. Broach



423851  
223851 Stem Only

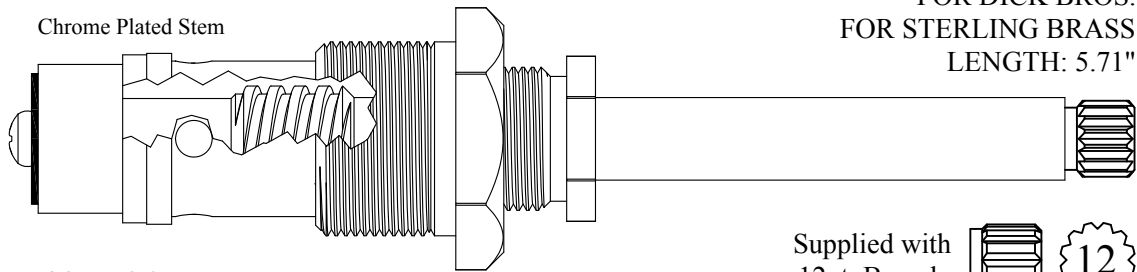

FOR DICK BROS.  
FOR STERLING BRASS  
LENGTH: 5.71"

**435732**  
**235732** Stem Only  
GASKET: 895430

Supplied with  
12pt. Broach  **12**  
1-2

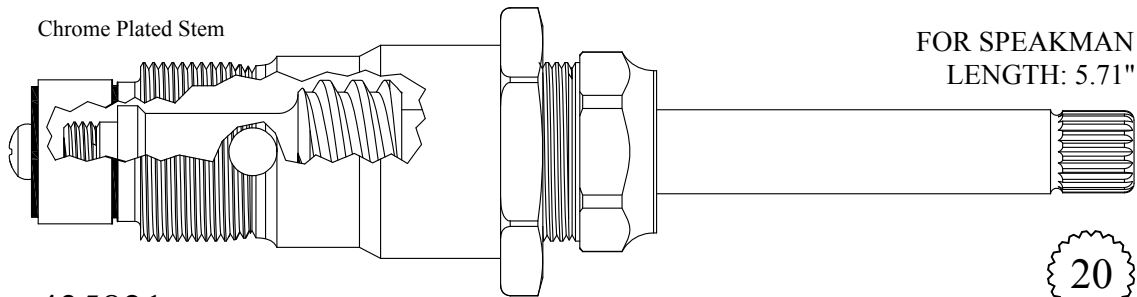

FOR SPEAKMAN  
LENGTH: 5.71"

**435821**  
**235821** Stem Only  
GASKET: 895450

**20**  
2-4

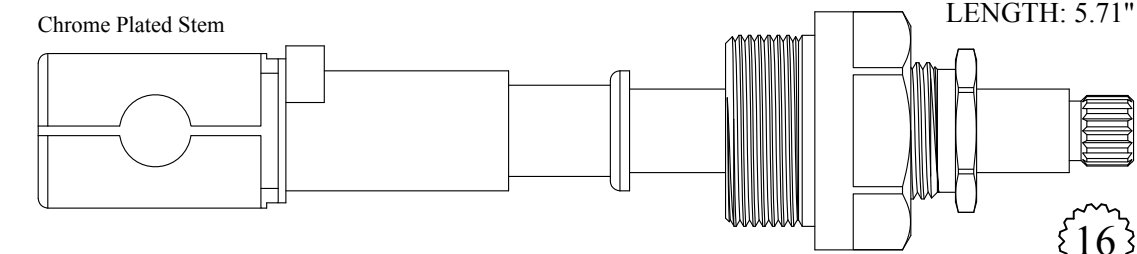

FOR CENTRAL  
LENGTH: 5.71"

**437410**  
**237410** Stem Only  
GASKET: 895550

**16**  
1-6

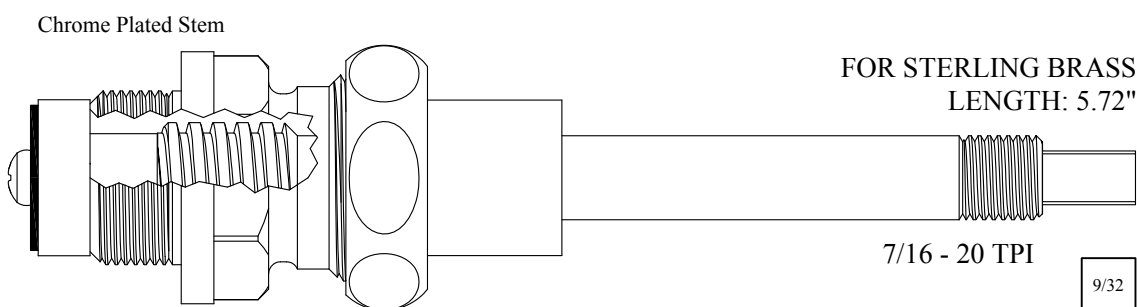

FOR STERLING BRASS  
LENGTH: 5.72"

**425401**  
**225401** Stem Only  
GASKET: 895370

7/16 - 20 TPI **9/32**

Chrome Plated Stem

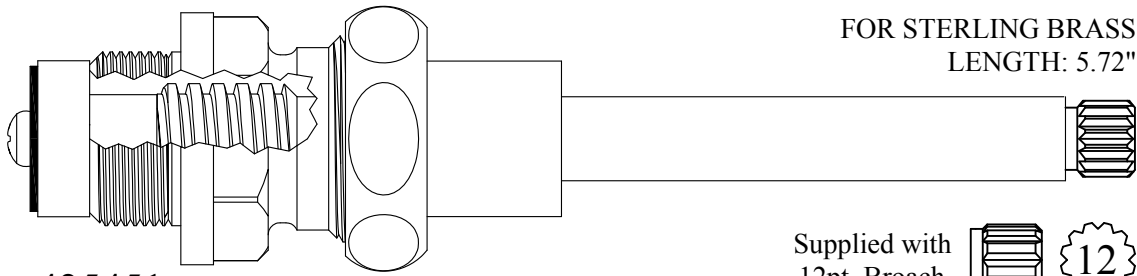

FOR STERLING BRASS  
LENGTH: 5.72"

425451  
225451 Stem Only  
GASKET: 895370

Supplied with  
12pt. Broach

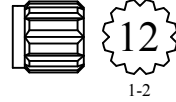

12  
1-2

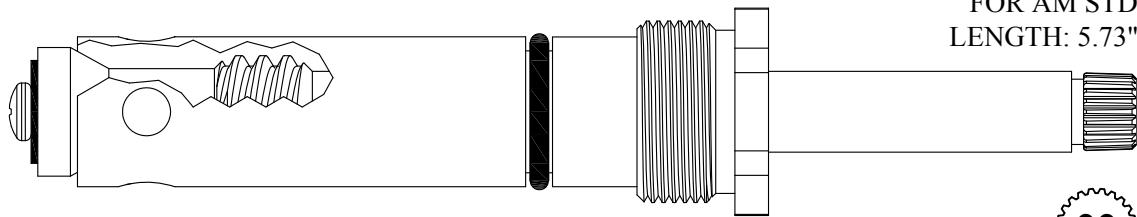

FOR AM STD  
LENGTH: 5.73"

435312  
235312 Stem Only



SEAT USED: LF648220

22  
1-4

Chrome Plated Stem

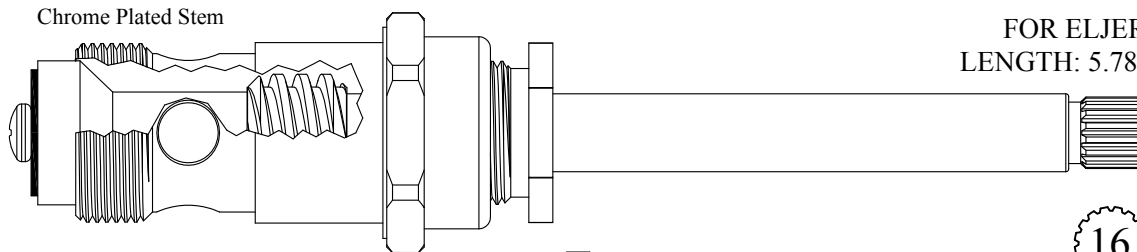

FOR ELJER  
LENGTH: 5.78"

435811  
235811 Stem Only  
GASKET: 895350

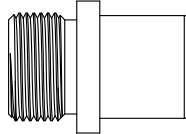

SEAT USED: LF649640

16  
3-15

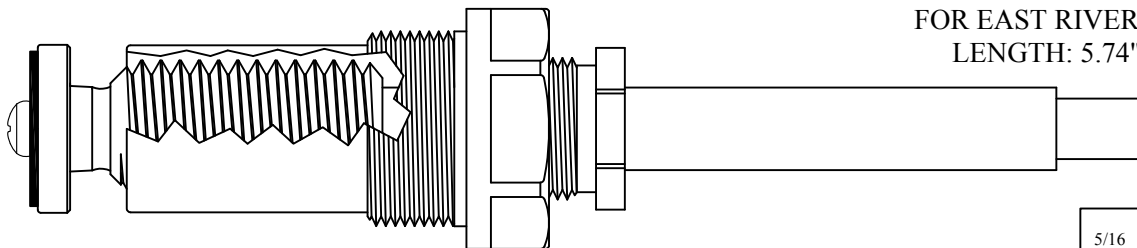

FOR EAST RIVER  
LENGTH: 5.74"

427211  
227211 Stem Only  
GASKET: 895540

5/16



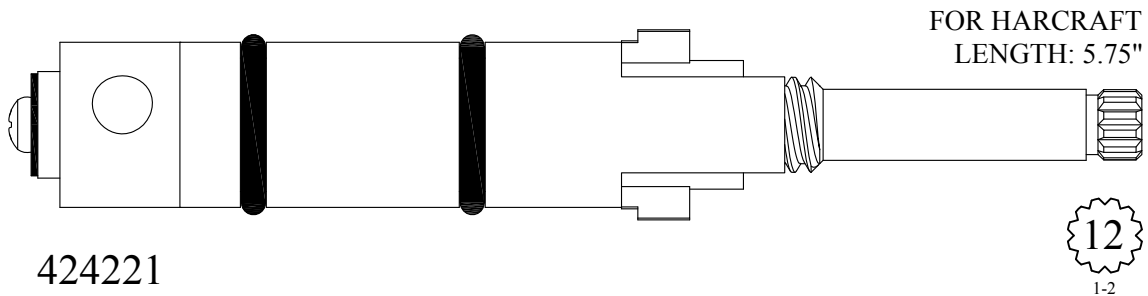
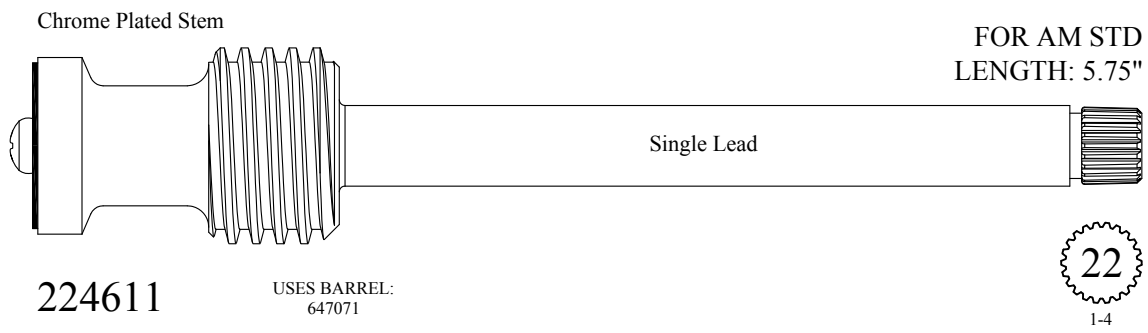
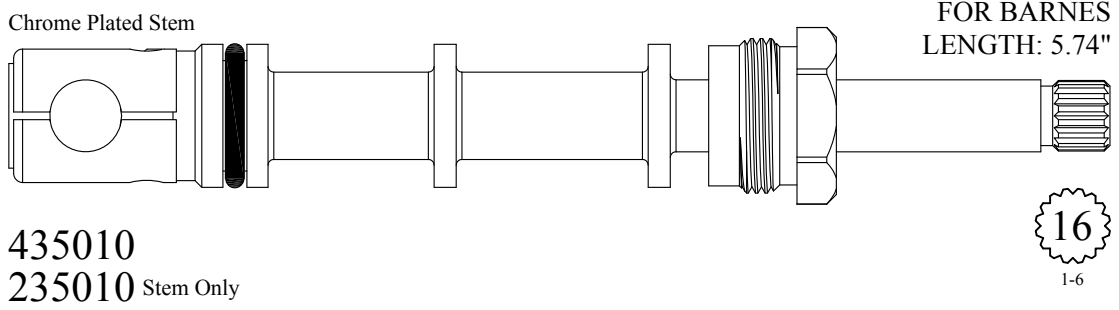
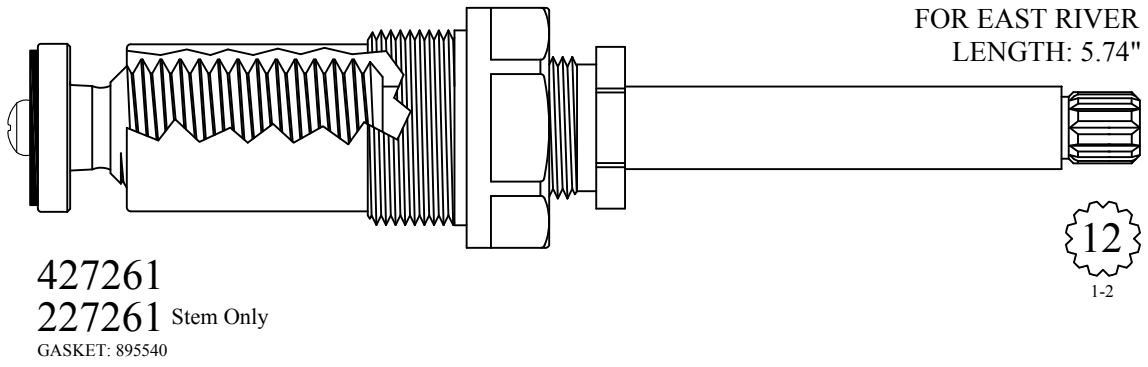

Chrome Plated Stem

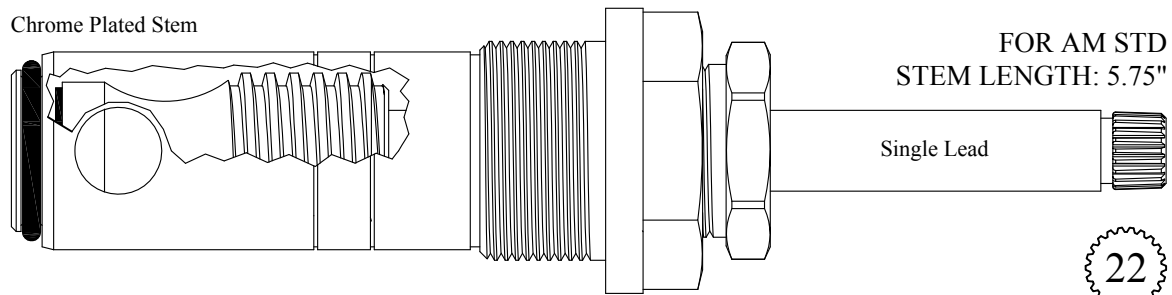

FOR AM STD  
STEM LENGTH: 5.75"

Single Lead



424601

USES BARREL:  
647051

224601 Stem Only

GASKET: 824600

Also available less barrel

424631

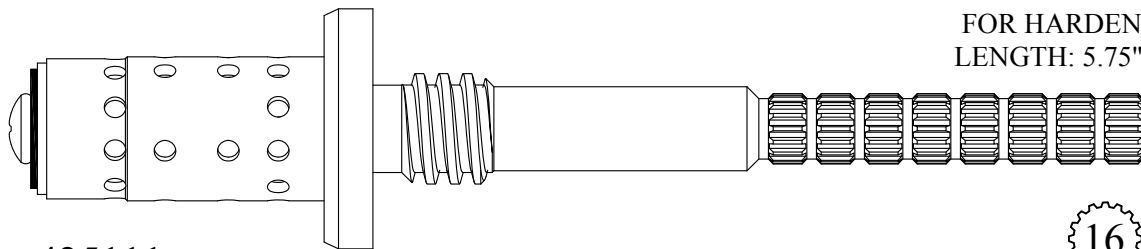

FOR HARDEN  
LENGTH: 5.75"



425111

225111 Stem Only

GASKET: 895500

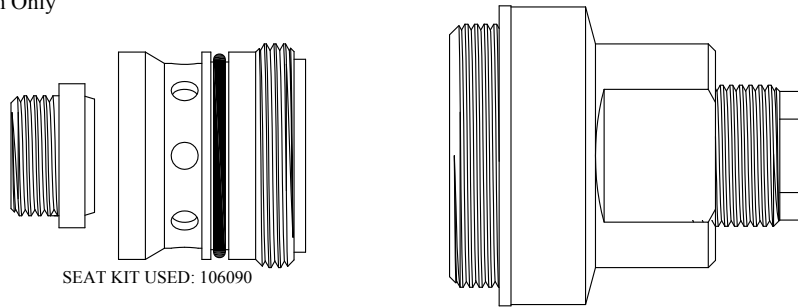

SEAT KIT USED: 106090

Chrome Plated Stem

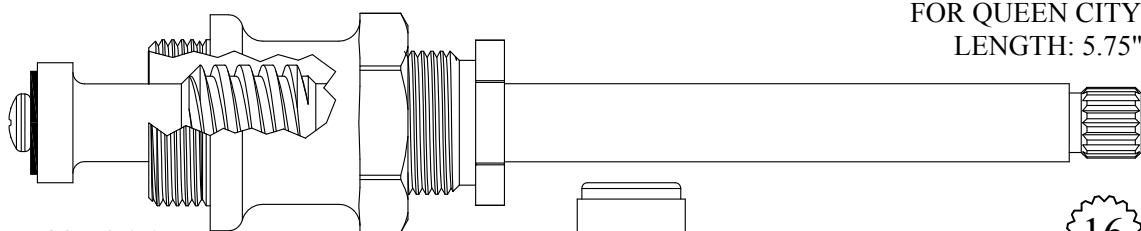

FOR QUEEN CITY  
LENGTH: 5.75"



425201

225201 Stem Only

GASKET: 895400

SEAT USED: 649840

Chrome Plated Stem

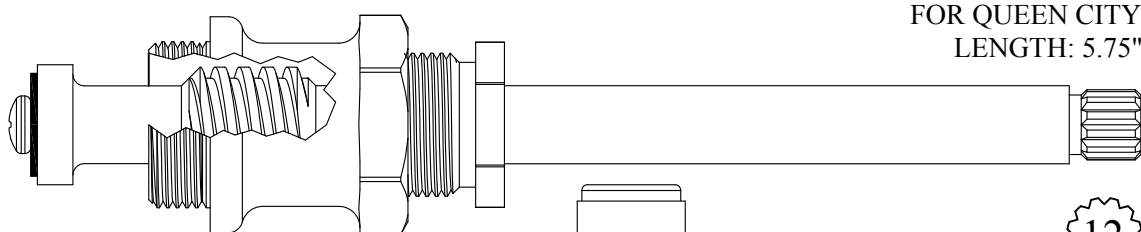

FOR QUEEN CITY  
LENGTH: 5.75"



425251

225251 Stem Only

GASKET: 895400

SEAT USED: 649840

FOR HOT & COLD STEM USE PRICE PFISTER 421601/421602

Chrome Plated Stem

FOR CALIFORNIA BRASS  
LENGTH: 5.75"

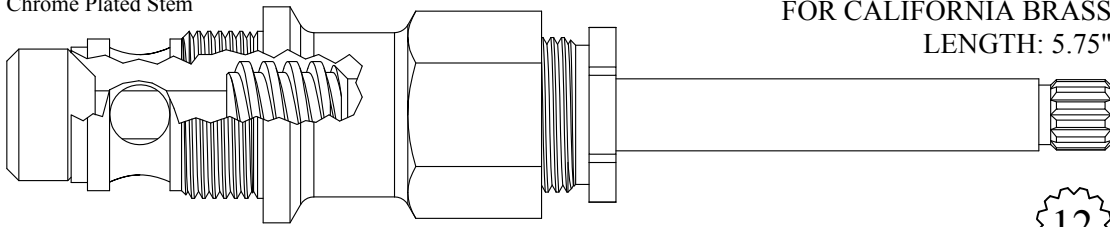

434801

234801 Stem Only

GASKET: 895400

12  
1-2

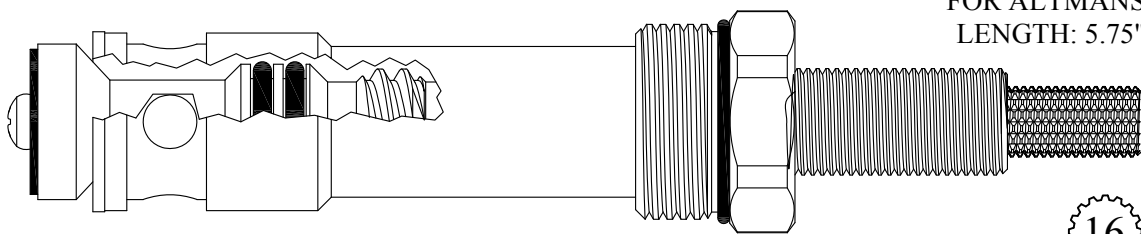

FOR ALTMANS  
LENGTH: 5.75"

435841

GASKET: 890210 O-RING INCLUDED

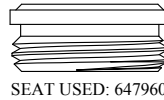

SEAT USED: 647960

16  
3-16

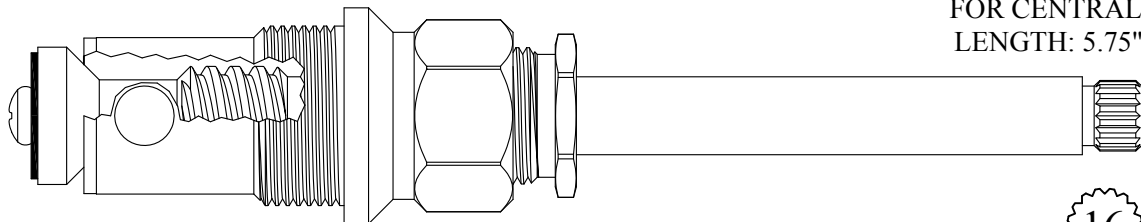

FOR CENTRAL  
LENGTH: 5.75"

436101

236101 Stem Only

GASKET: 895370



SEAT USED: 648970

16  
1-6

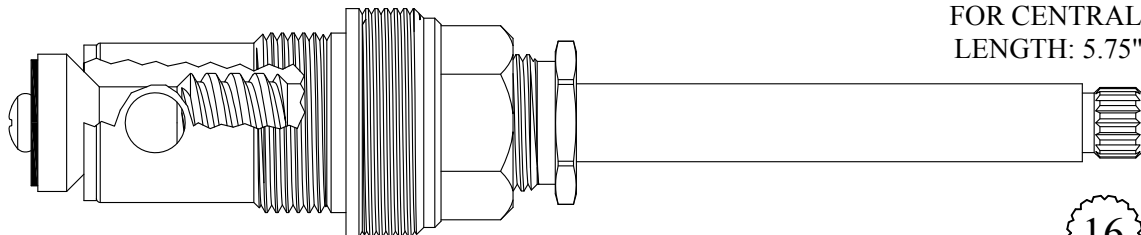

FOR CENTRAL  
LENGTH: 5.75"

436111

236101 Stem Only

GASKET: 895370



SEAT USED: 648970

16  
1-6

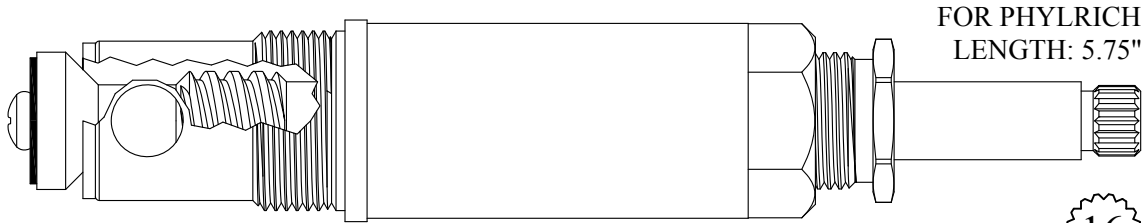

FOR PHYLRICH  
LENGTH: 5.75"

436131  
236101 Stem Only  
GASKET: 895370



SEAT USED: 648970

16  
1-6

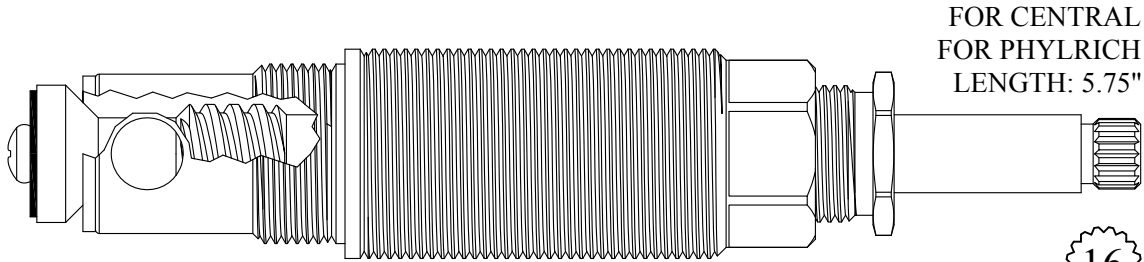

FOR CENTRAL  
FOR PHYLRICH  
LENGTH: 5.75"

436141  
236101 Stem Only  
GASKET: 895370

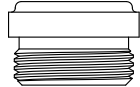

SEAT USED: 648970

16  
1-6

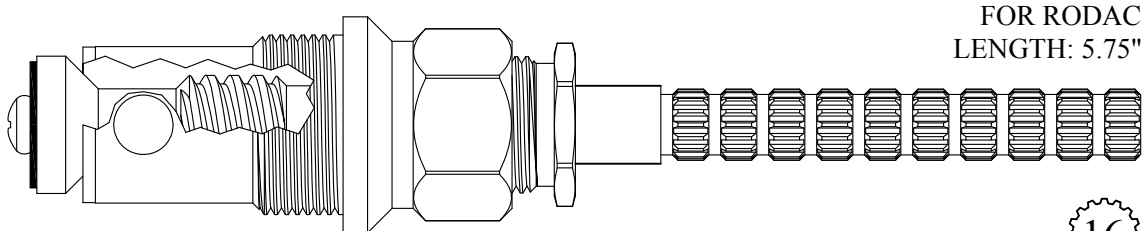

FOR RODAC  
LENGTH: 5.75"

436151  
236151 Stem Only  
GASKET: 895370



SEAT USED: 648970

16  
3-16

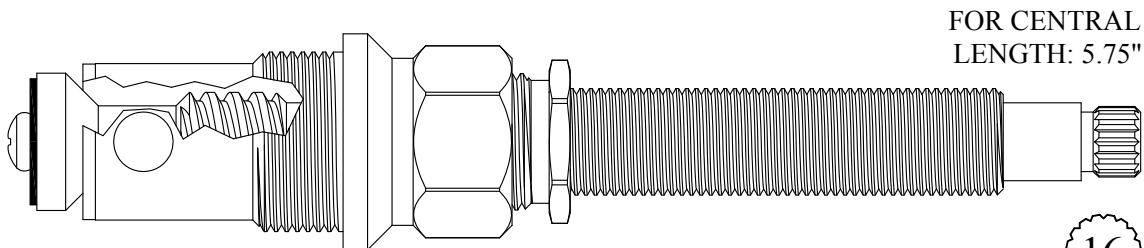

FOR CENTRAL  
LENGTH: 5.75"

436161  
236101 Stem Only  
GASKET: 895370



SEAT USED: 648970

16  
1-6

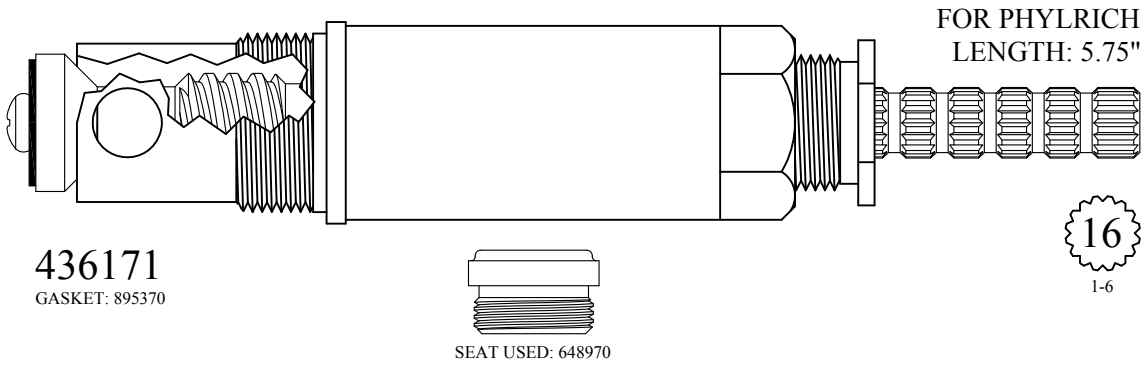

**436171**  
GASKET: 895370

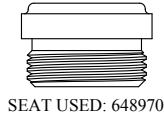

**16**  
1-6

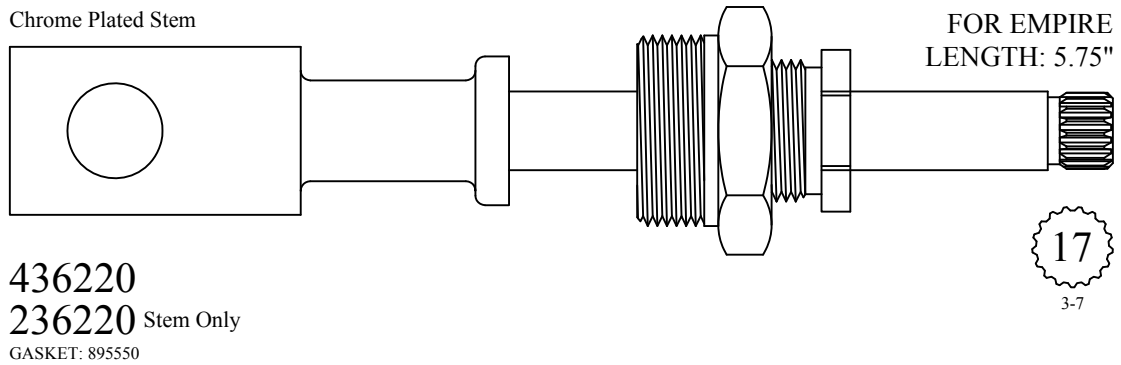

**436220**  
**236220** Stem Only  
GASKET: 895550

**17**  
3-7

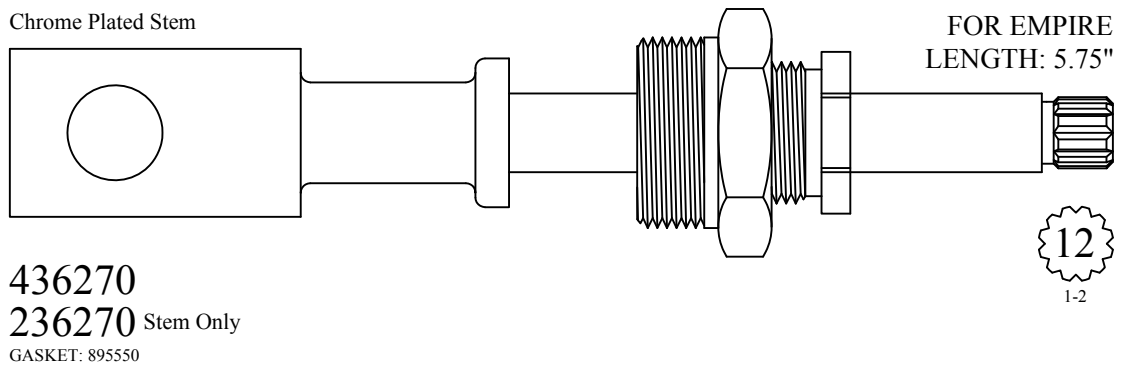

**436270**  
**236270** Stem Only  
GASKET: 895550

**12**  
1-2

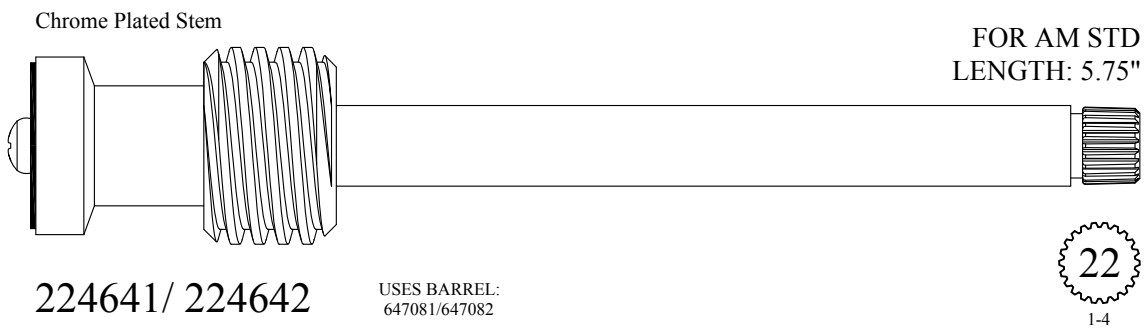

**224641/ 224642** USES BARREL:  
647081/647082

**22**  
1-4

Chrome Plated Stem

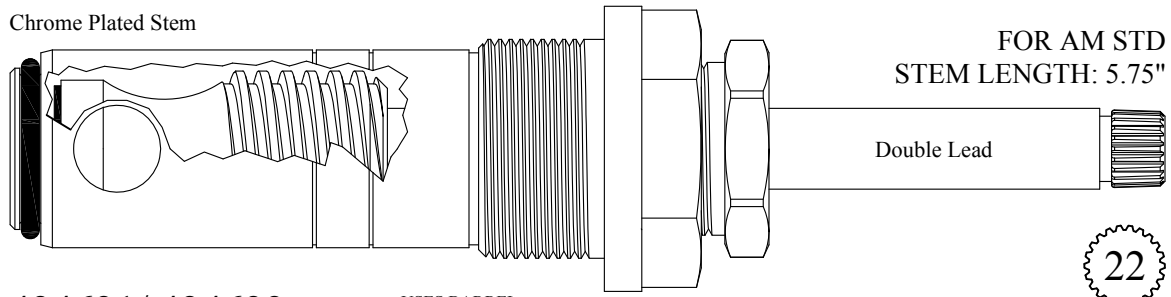

FOR AM STD  
STEM LENGTH: 5.75"

Double Lead



424621/ 424622

USES BARREL:  
647061 / 647062

224621/ 224622 Stem Only

GASKET: 824600

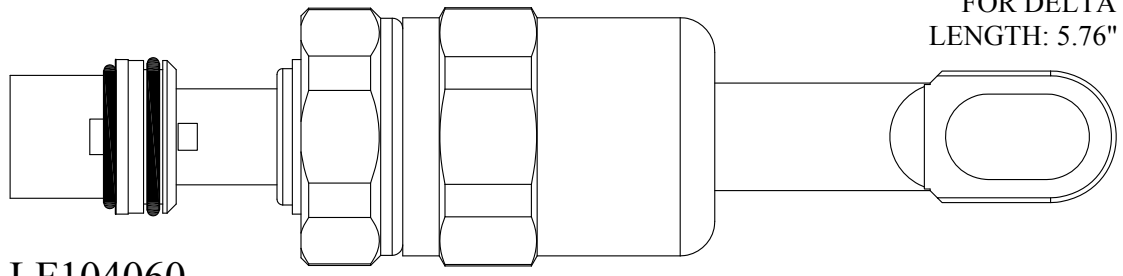

FOR DELTA  
LENGTH: 5.76"

LF104060

Chrome Plated Stem

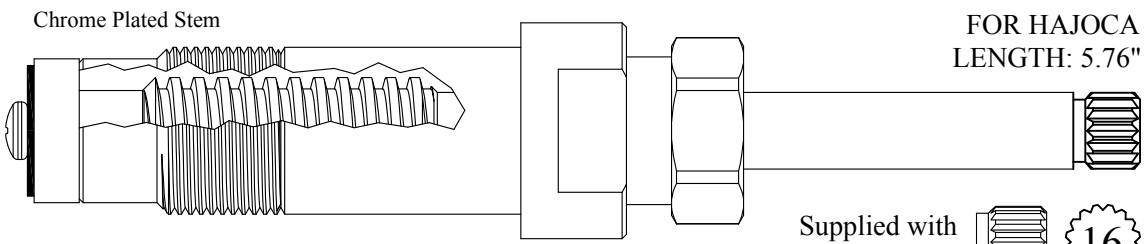

FOR HAJOCA  
LENGTH: 5.76"

Supplied with  
12pt. Broach



422021

222021 Stem Only

GASKET: 895400

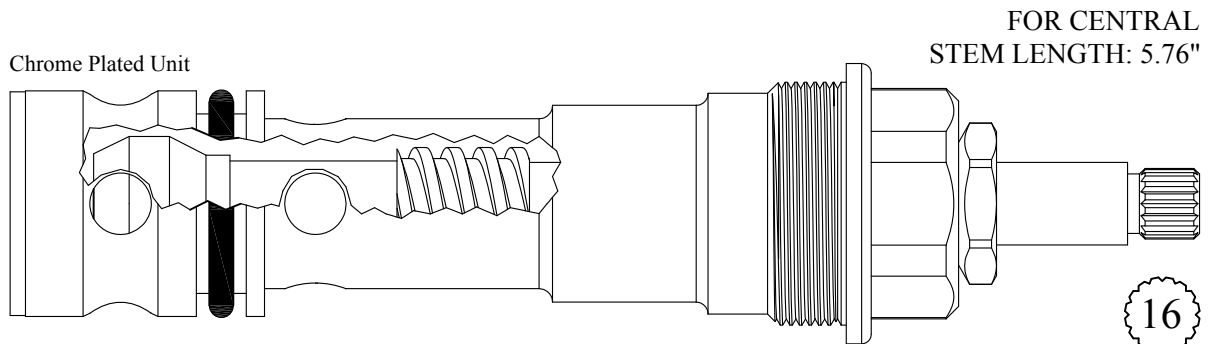

FOR CENTRAL  
STEM LENGTH: 5.76"

Chrome Plated Unit



438671

238741 Stem Only

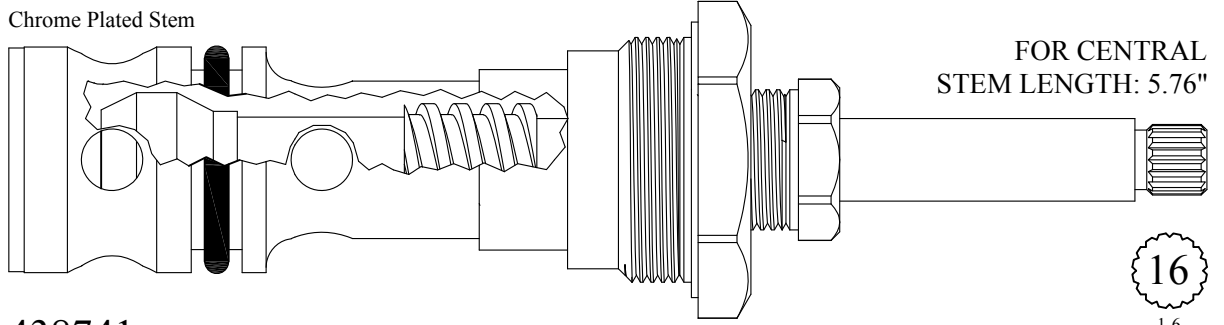

438741  
238741 Stem Only

16  
1-6

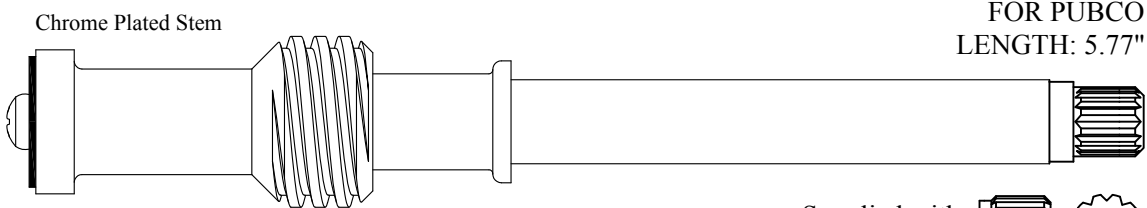

225361

Supplied with  
12pt. Broach  12  
1-2

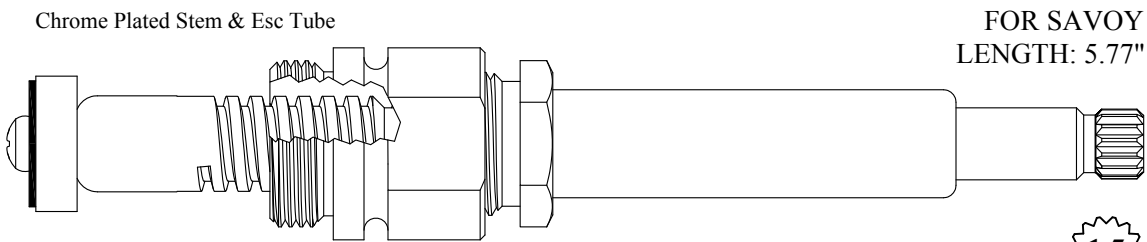

423211  
223411 Stem Only  
GASKET: 895400

15  
1-13

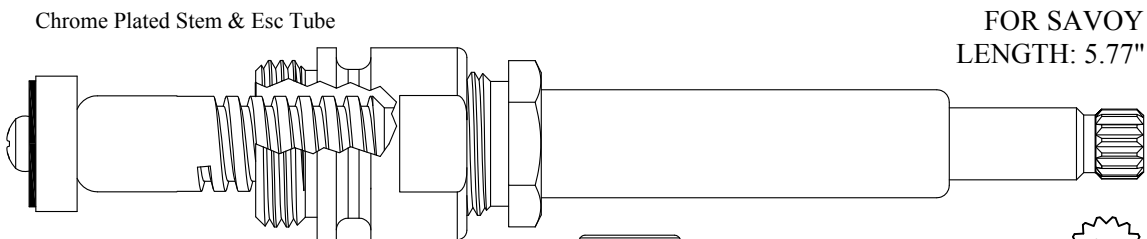

423411  
223411 Stem Only  
GASKET: 895400

15  
1-13



Chrome Plated Stem

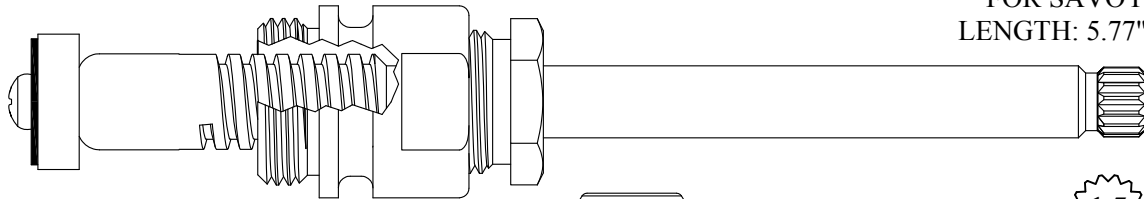

FOR SAVOY  
LENGTH: 5.77"

423411-LT  
223411 Stem Only  
GASKET: 895400



SEAT USED: LF648130

15  
1-13

Chrome Plated Stem & Esc Tube

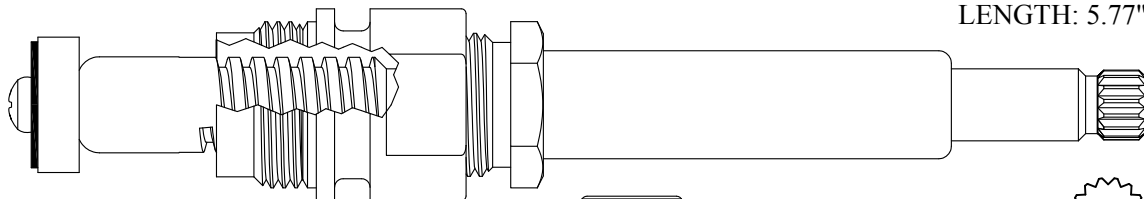

FOR SAVOY  
LENGTH: 5.77"

423511  
223411 Stem Only  
GASKET: 895400



SEAT USED: LF648130

15  
1-13

Chrome Plated Stem & Esc Holder

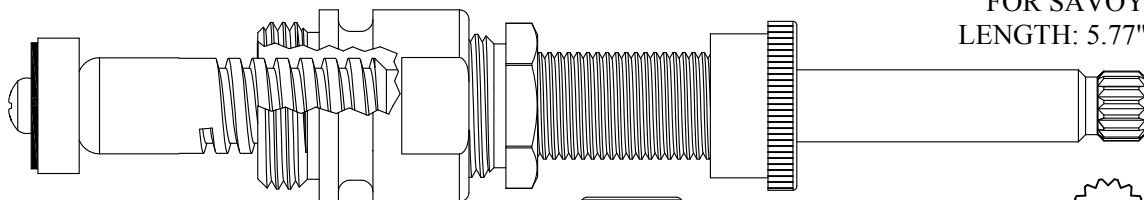

FOR SAVOY  
LENGTH: 5.77"

423521  
223411 Stem Only  
GASKET: 895400



SEAT USED: LF648130

15  
1-13

Chrome Plated Stem & Esc Tube

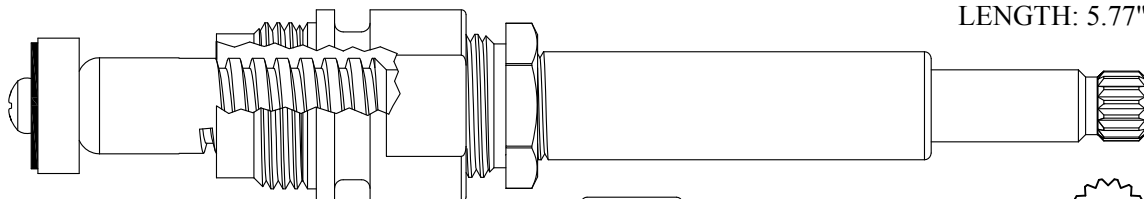

FOR SAVOY  
LENGTH: 5.77"

423541  
223411 Stem Only  
GASKET: 895400



SEAT USED: LF648130

15  
1-13



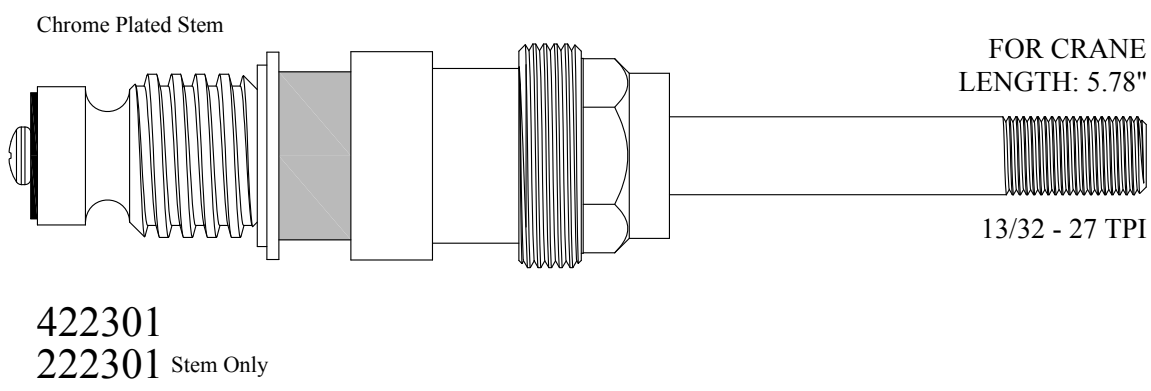
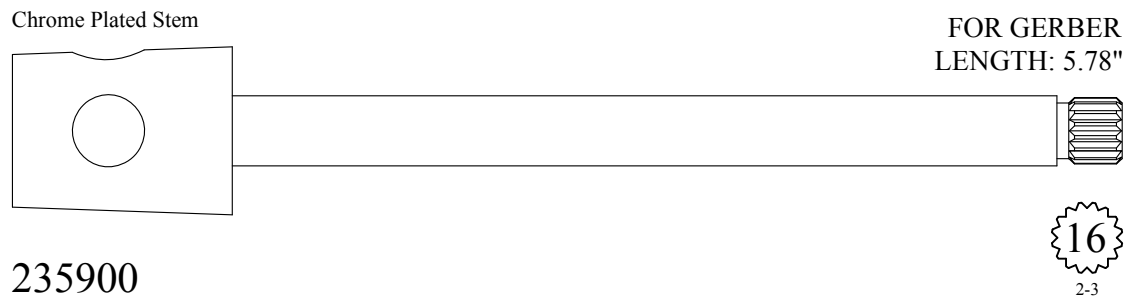
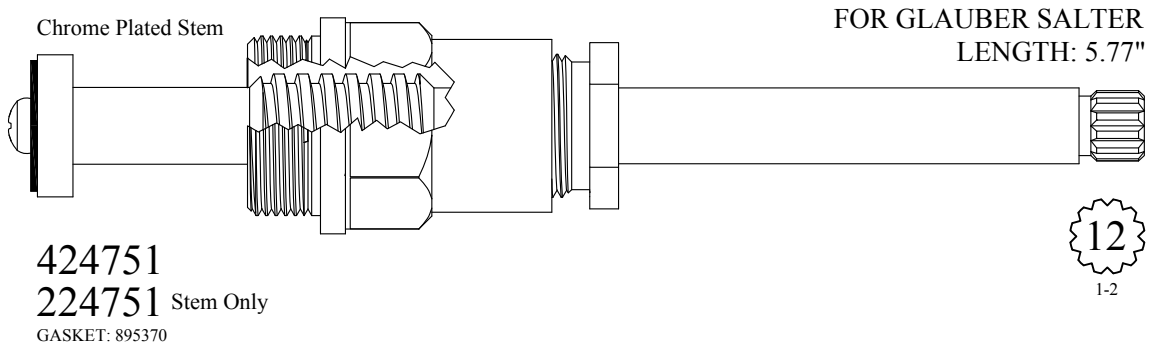
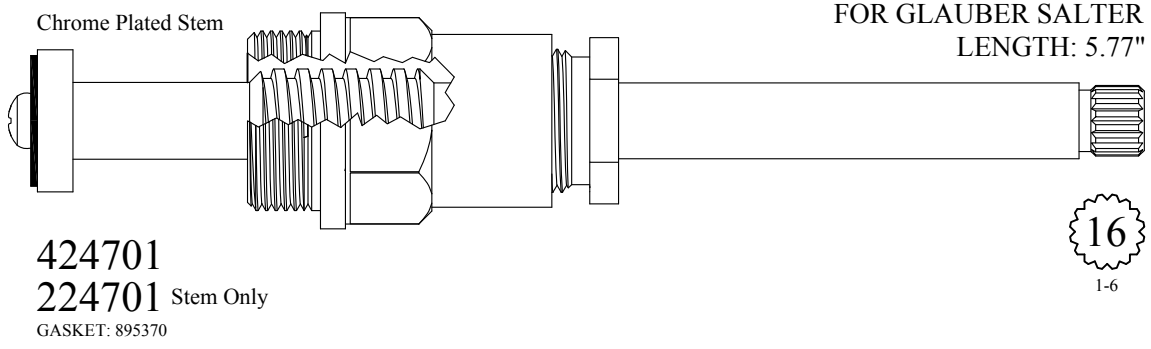

Chrome Plated Stem

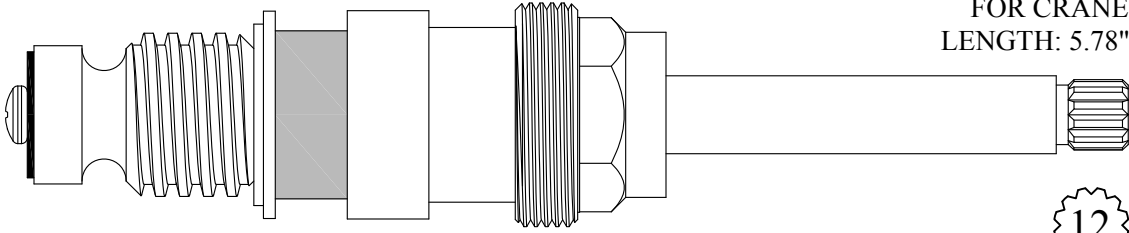

FOR CRANE  
LENGTH: 5.78"

12  
1-2

422351  
222351 Stem Only

Chrome Plated Stem

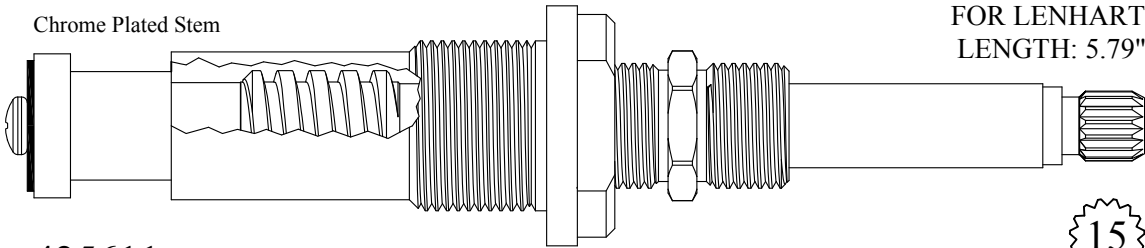

FOR LENHART  
LENGTH: 5.79"

15  
1-13

425611  
225611 Stem Only  
GASKET: 895370

Chrome Plated Stem

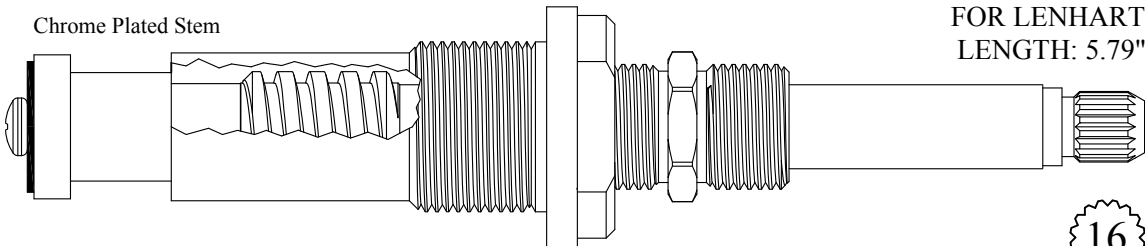

FOR LENHART  
LENGTH: 5.79"

16  
1-6

425621  
225621 Stem Only  
GASKET: 895370

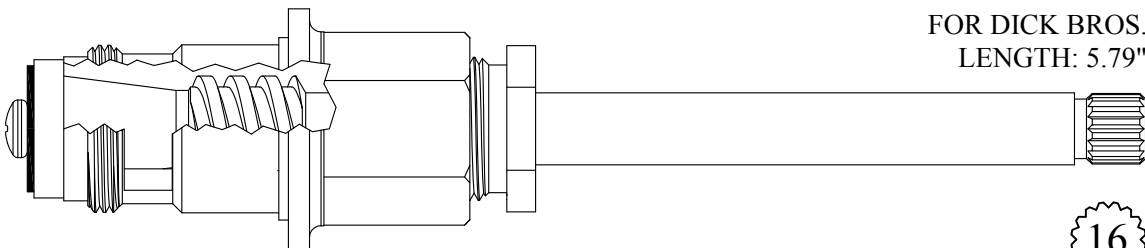

FOR DICK BROS.  
LENGTH: 5.79"

16  
1-6

436301  
236301 Stem Only  
GASKET: 895350

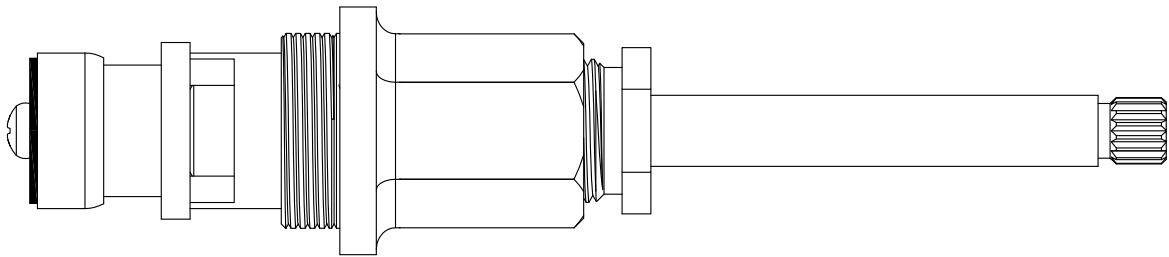
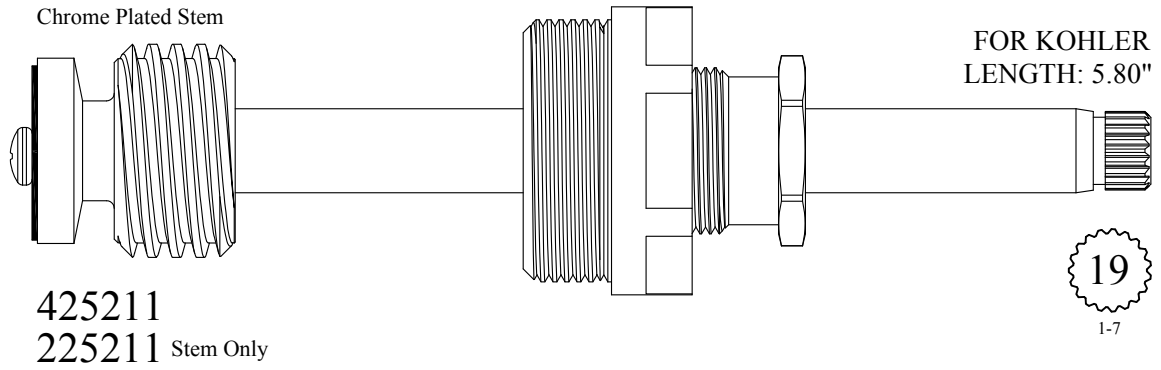

Old Style, Use 434401 or 236411 stem only

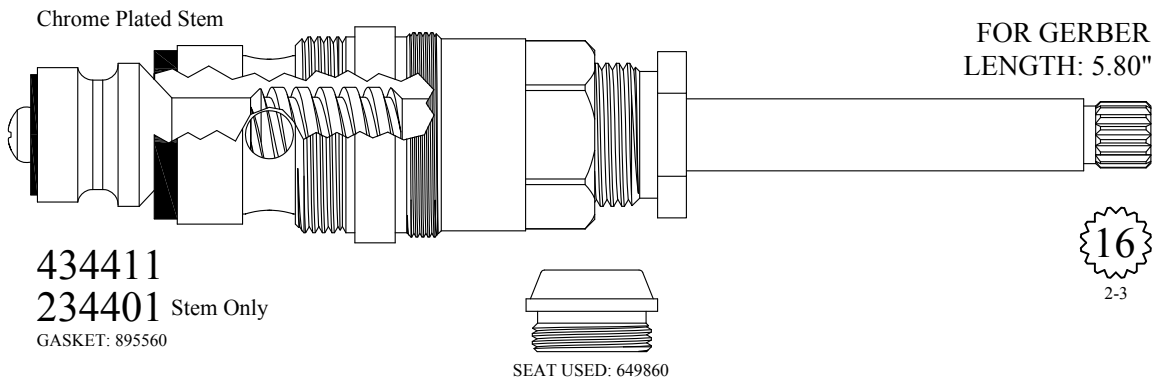
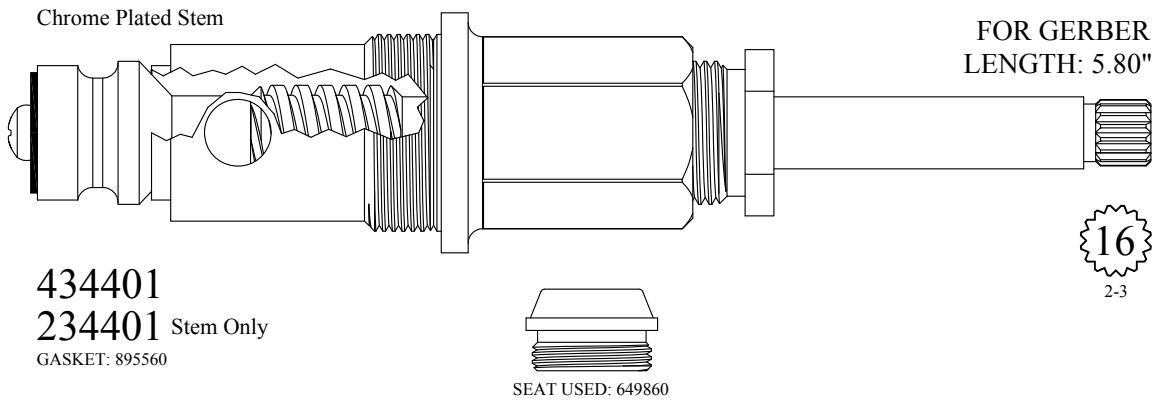

Chrome Plated Stem

FOR AM STD  
STEM LENGTH: 5.81"

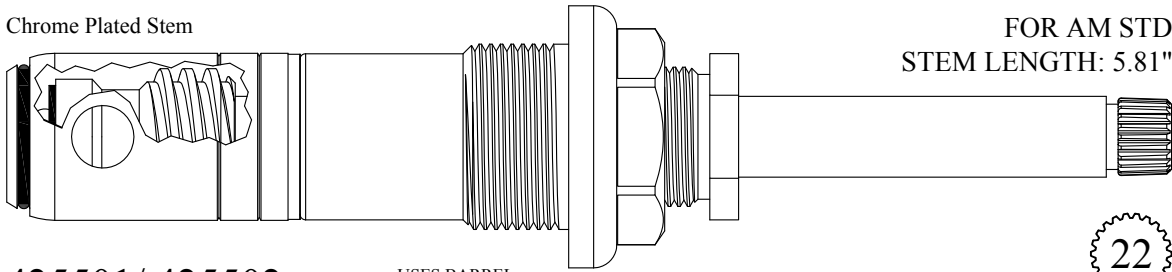

425501/ 425502  
225501/ 225502 Stem Only  
GASKET: 818000

USES BARREL:  
LF647021/LF647022

22  
1-4

Chrome Plated Stem

FOR AM STD  
STEM LENGTH: 5.81"

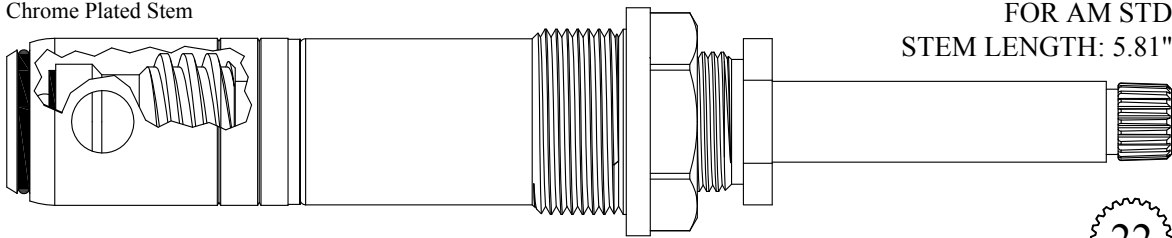

425511  
225501 Stem Only  
GASKET: 818010

USES BARREL:  
LF647021

22  
1-4

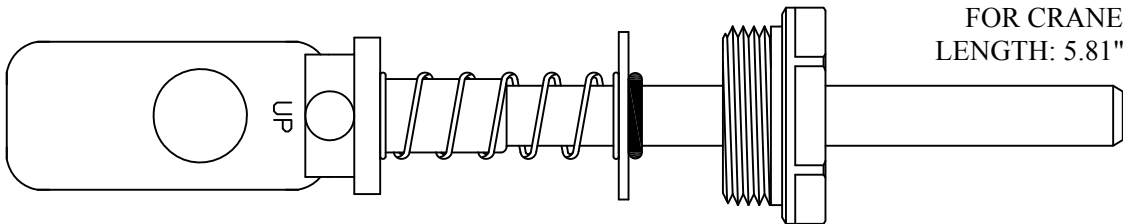

FOR CRANE  
LENGTH: 5.81"

436000  
236000 Stem Only  
GASKET: 895370 INCLUDED

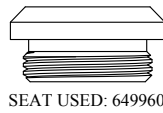

SEAT USED: 649960

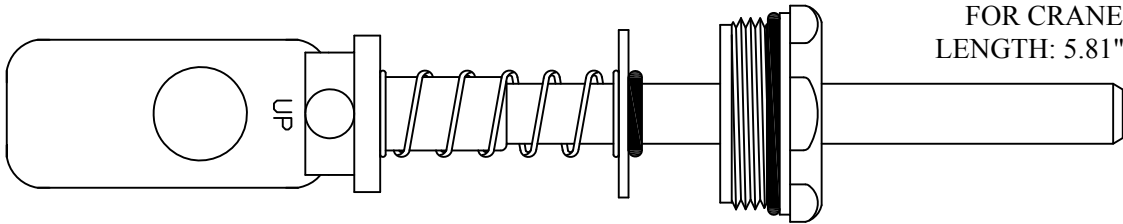

FOR CRANE  
LENGTH: 5.81"

436010  
236000 Stem Only  
GASKET: 890210 O-RING INCLUDED

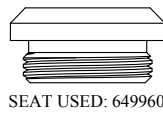

SEAT USED: 649960

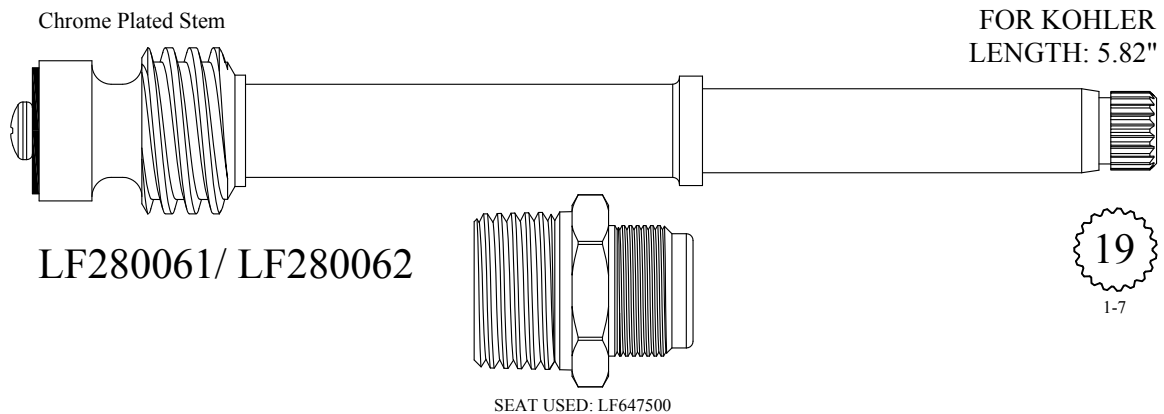
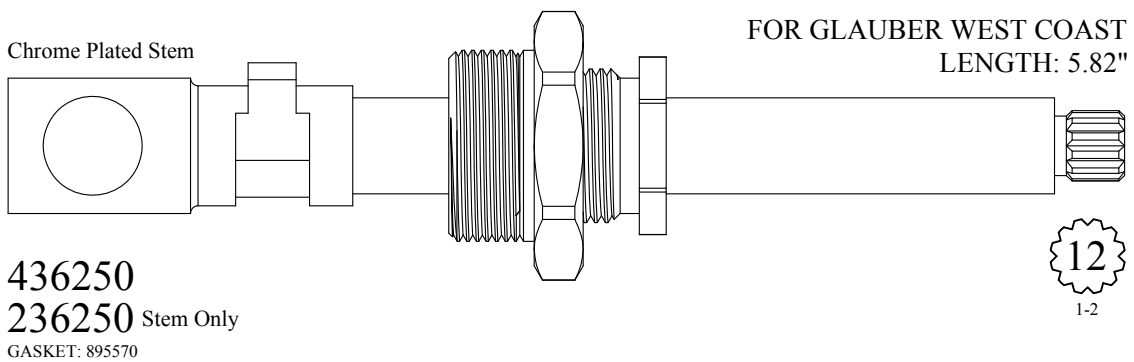
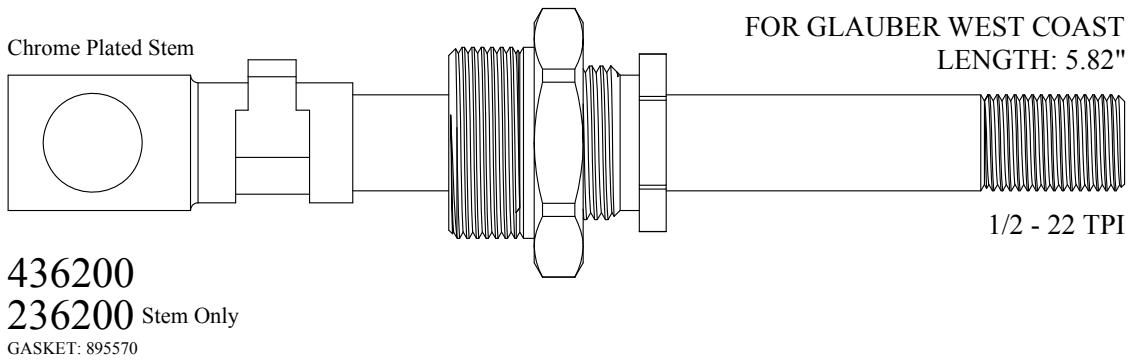
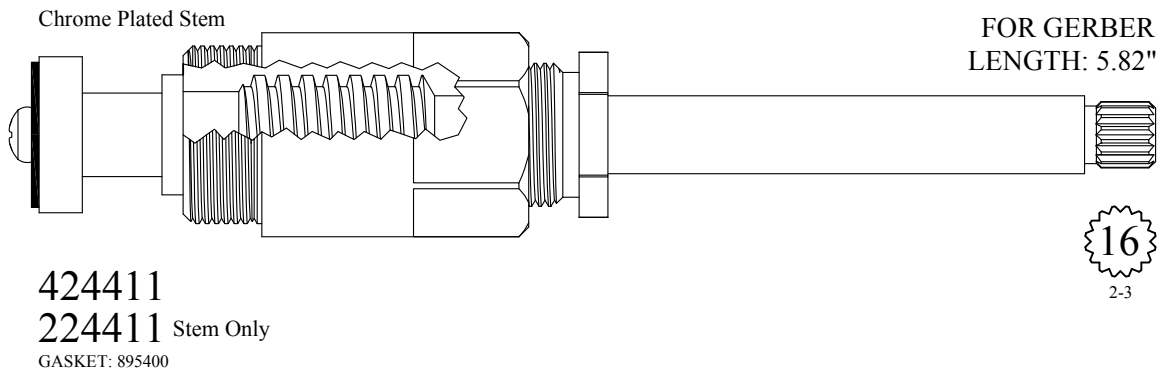

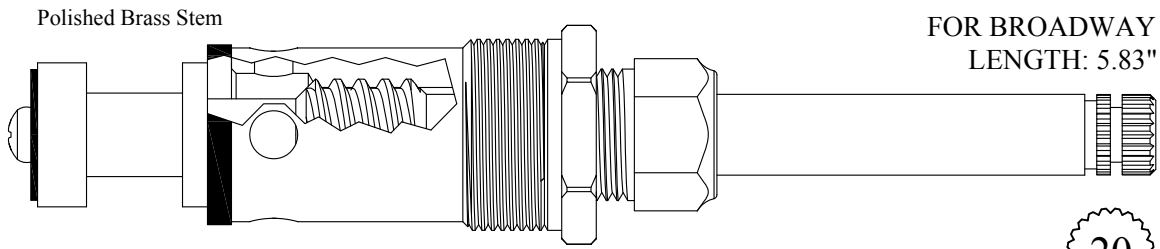

Polished Brass Stem

FOR BROADWAY  
LENGTH: 5.83"

436321  
236321 Stem Only

Also available with polished chrome plated stem

436321-CP  
236321-CP Stem Only

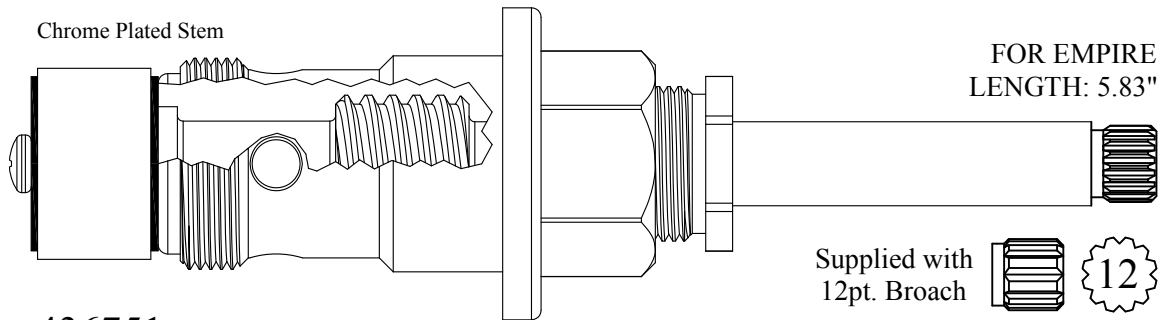

Chrome Plated Stem

FOR EMPIRE  
LENGTH: 5.83"

436751  
236751 Stem Only  
GASKET: 895450

Supplied with  
12pt. Broach

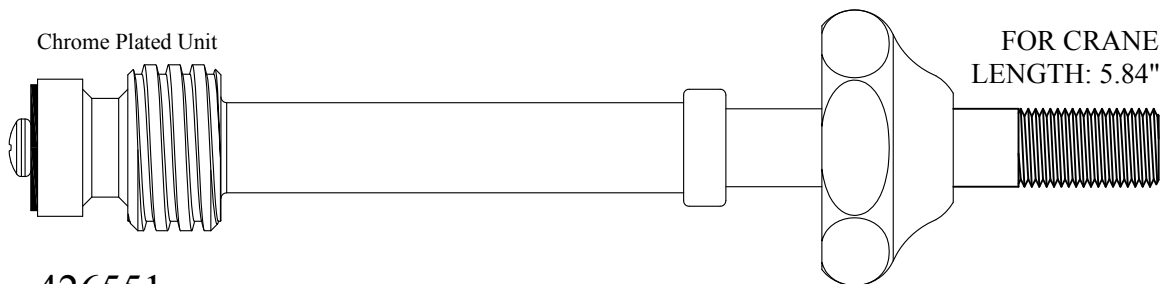

Chrome Plated Unit

FOR CRANE  
LENGTH: 5.84"

426551  
226551 Stem Only

Supplied with  
12pt. Broach

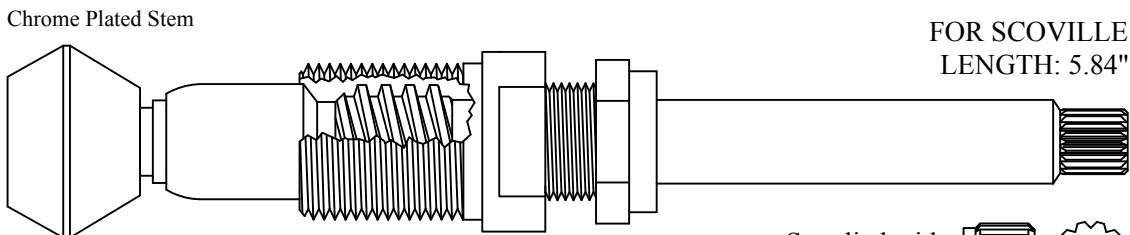

Chrome Plated Stem

FOR SCOVILLE  
LENGTH: 5.84"

436241  
236241 Stem Only  
GASKET: 895150

Supplied with  
12pt. Broach



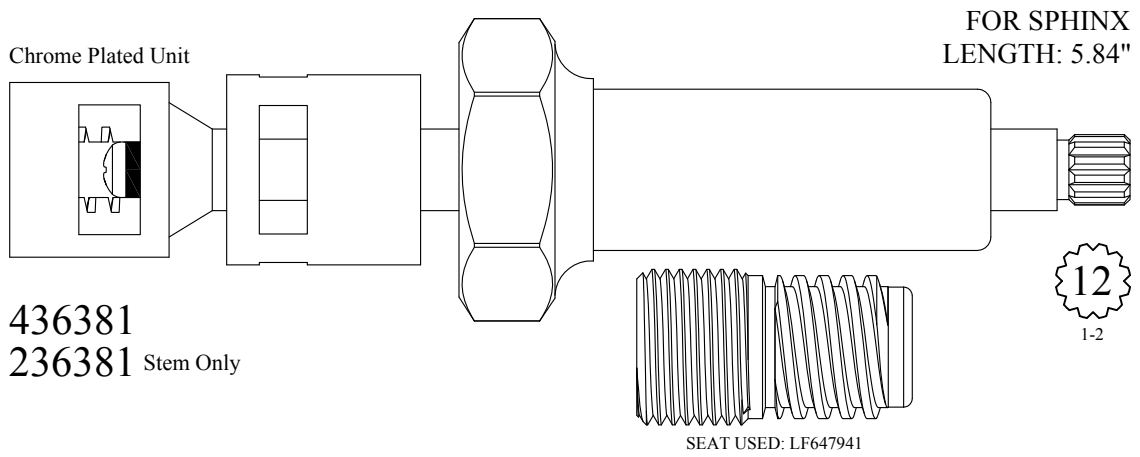

436381  
236381 Stem Only

12  
1-2

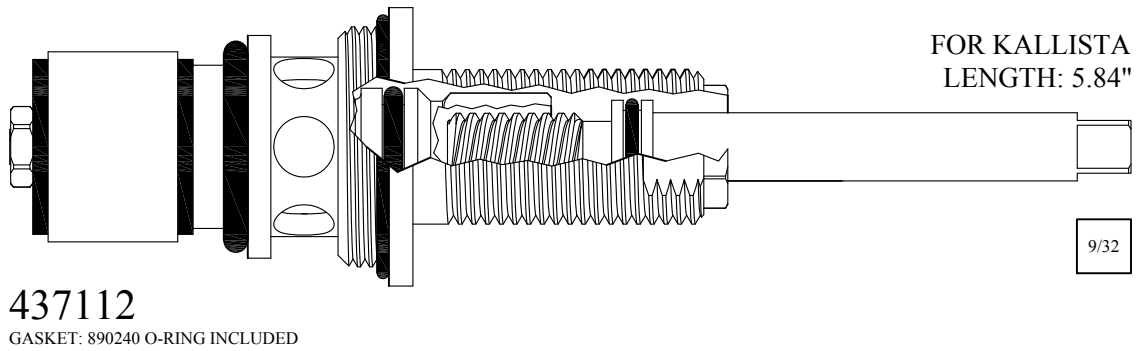

437112  
GASKET: 890240 O-RING INCLUDED

9/32

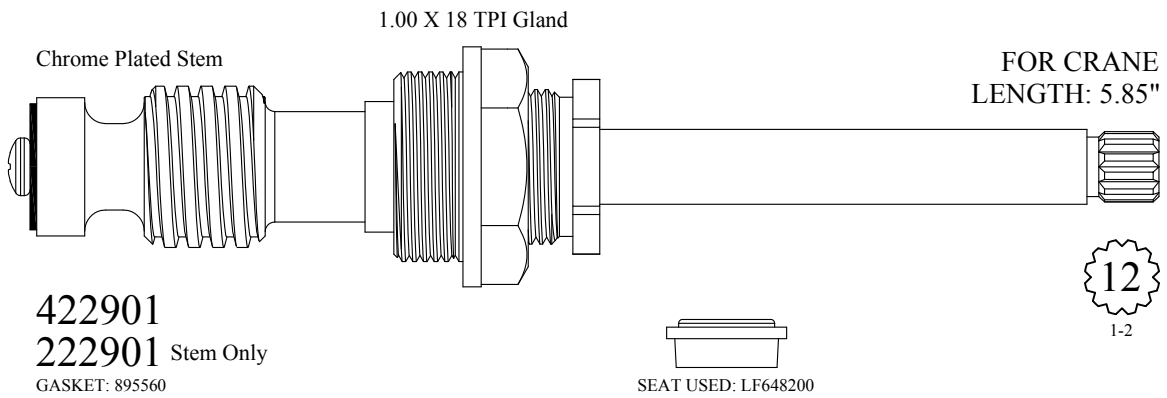

422901  
222901 Stem Only  
GASKET: 895560

12  
1-2

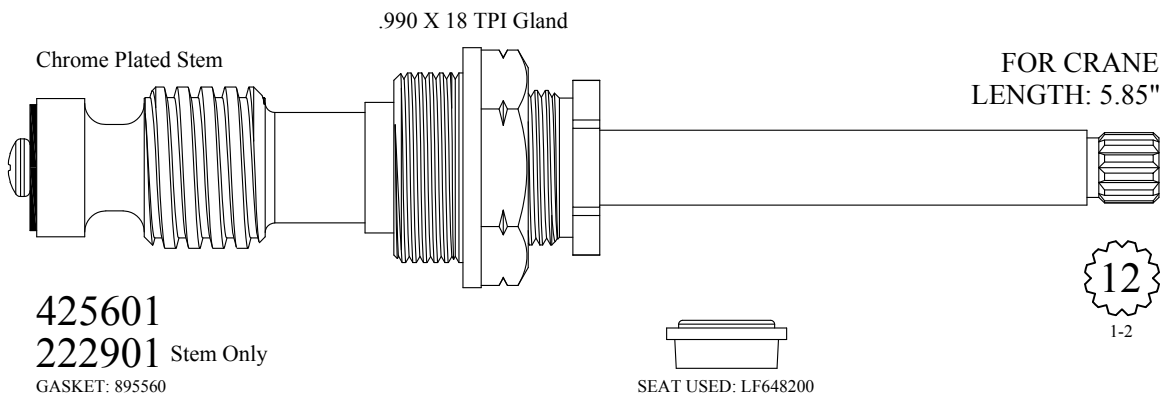

425601  
222901 Stem Only  
GASKET: 895560

12  
1-2

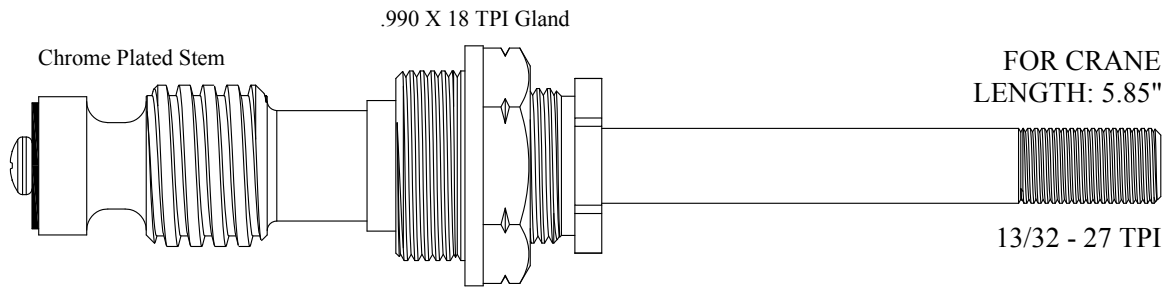

425631  
225631 Stem Only  
GASKET: 895560

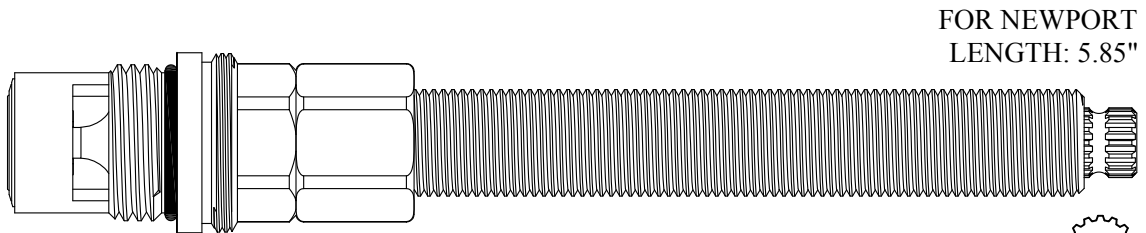
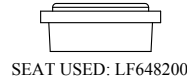

411271/ 411272  
GASKET: 890170 O-RING INCLUDED  
SEAL: 898510-W  
DISC SET: 151380-PKG

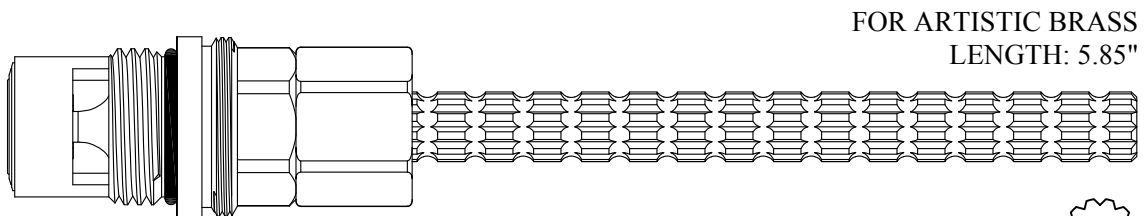

425721/ 425722  
GASKET: 890170 O-RING INCLUDED  
SEAL: 898510-W  
DISC SET: 151380-PKG

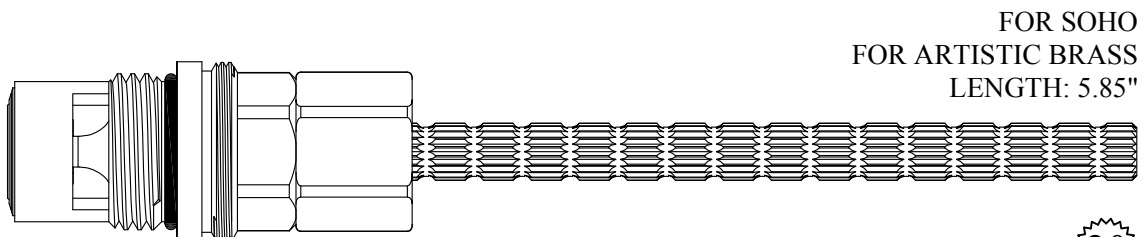

425741/ 425742  
GASKET: 890170 O-RING INCLUDED  
SEAL: 898510-W  
DISC SET: 151380-PKG





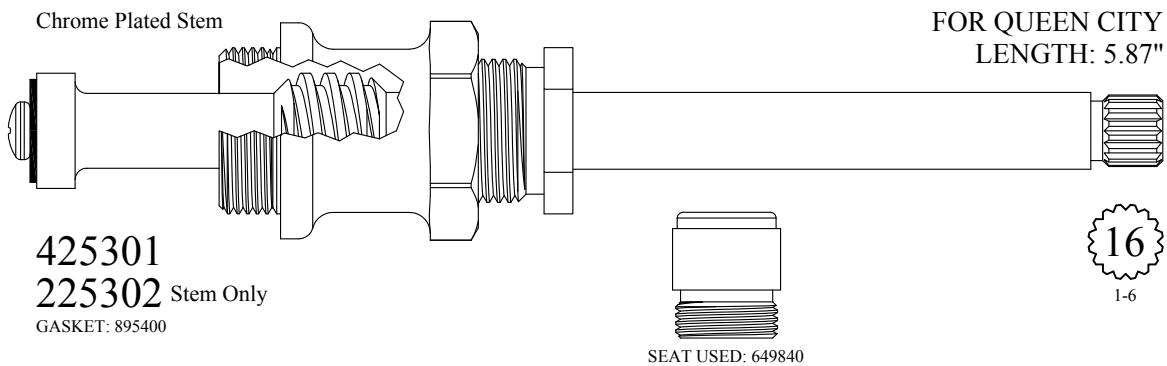
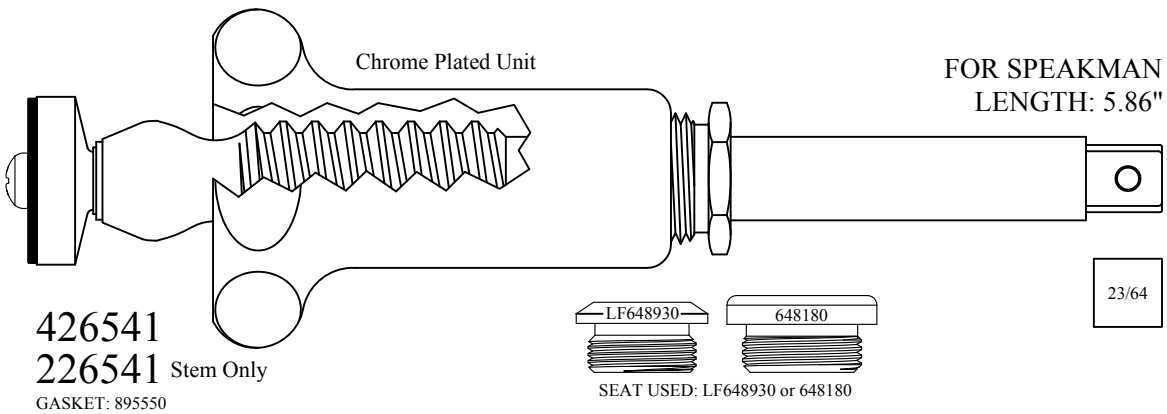
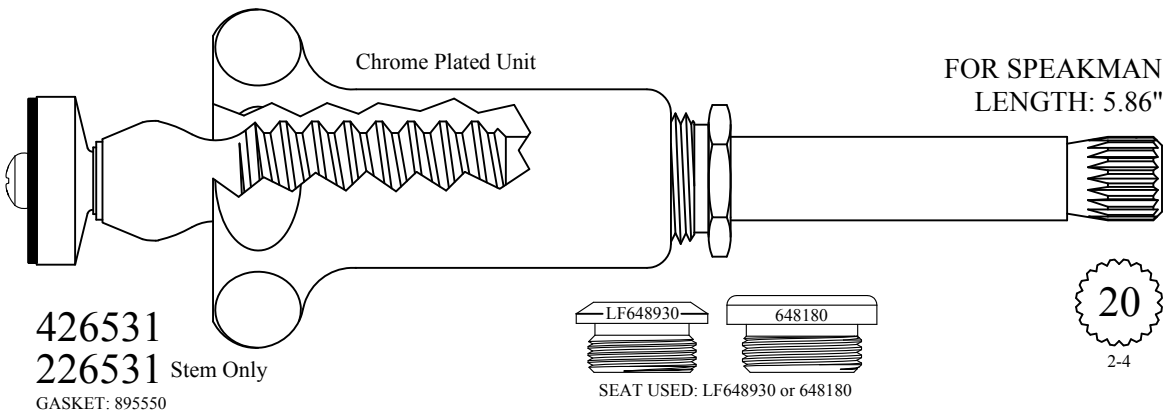
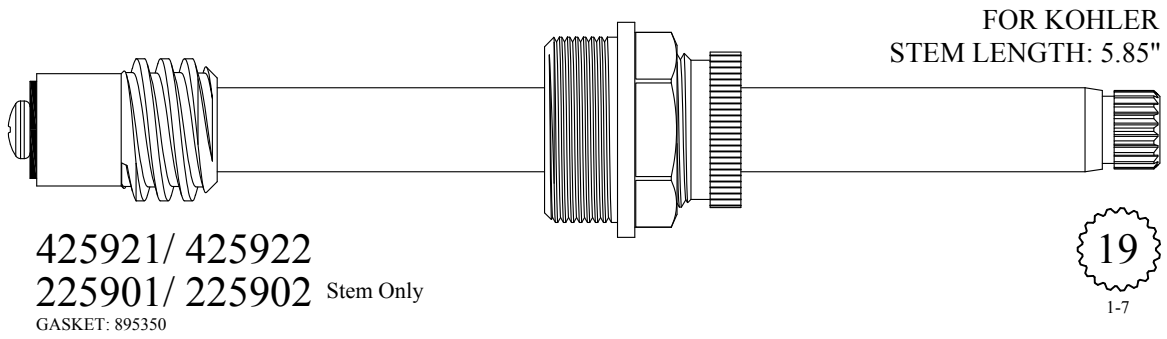

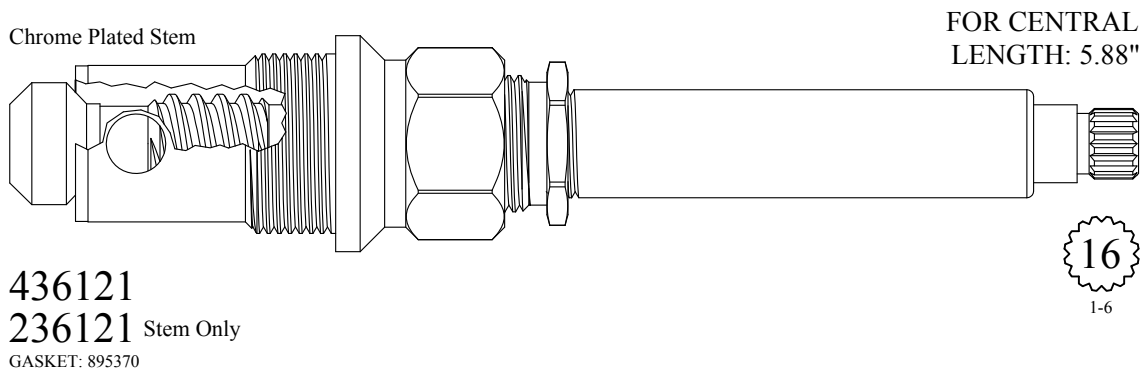
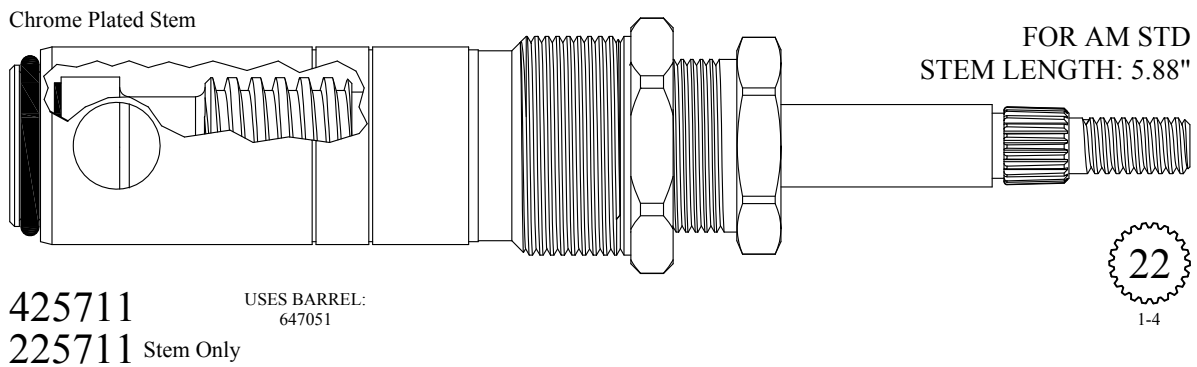
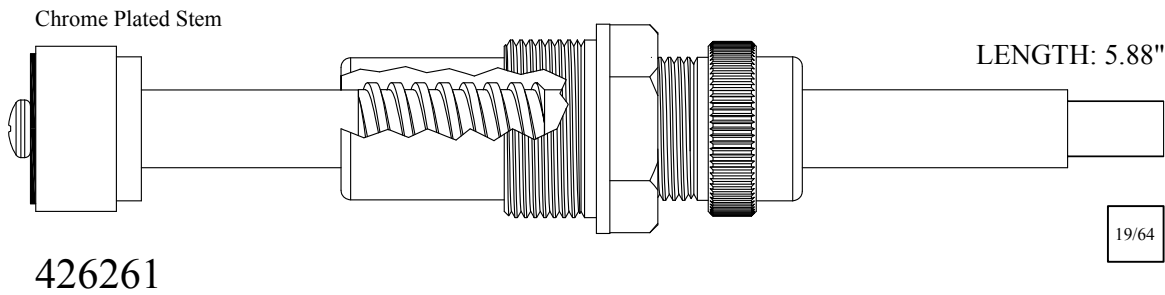
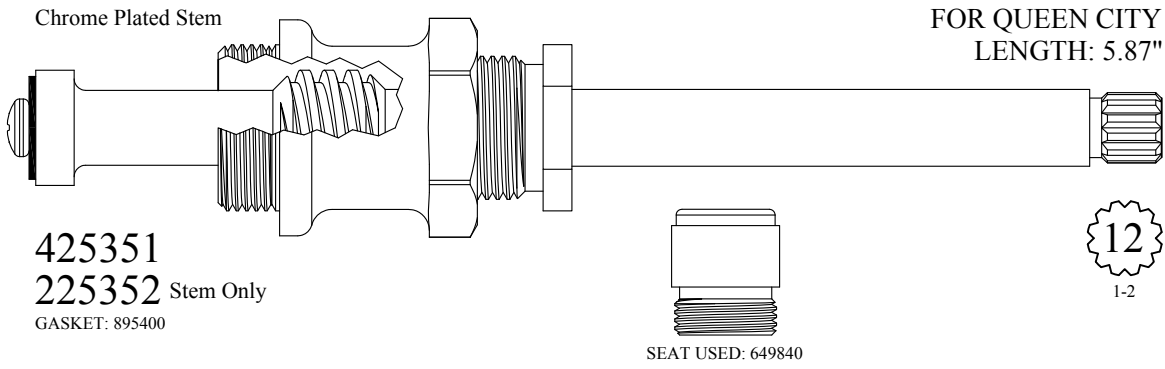

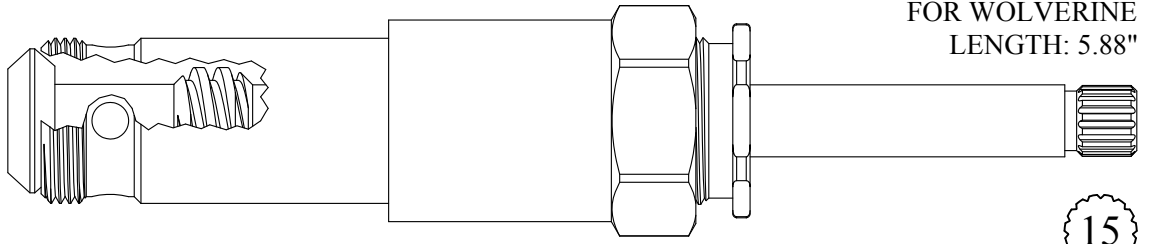

FOR WOLVERINE  
LENGTH: 5.88"

**436711**  
GASKET: 895400

15  
3-27

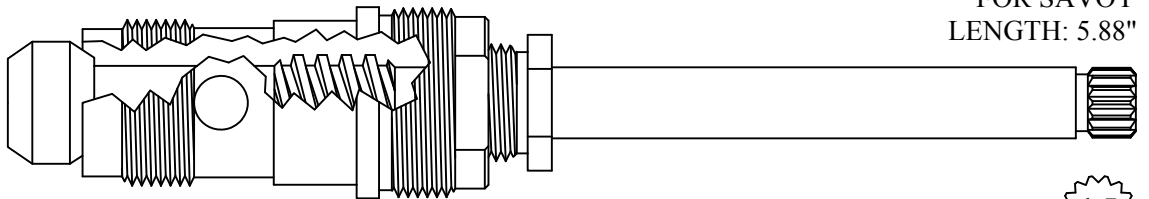

FOR SAVOY  
LENGTH: 5.88"

**438921**  
**238921** Stem Only  
GASKET: 895400

15  
1-13

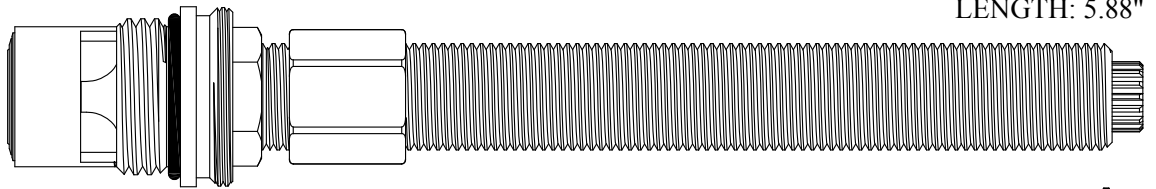

FOR NEWPORT  
LENGTH: 5.88"

**411281/ 411282**  
GASKET: 890170 O-RING INCLUDED  
SEAL: 898510-W  
DISC SET: 151380-PKG

16  
3-16

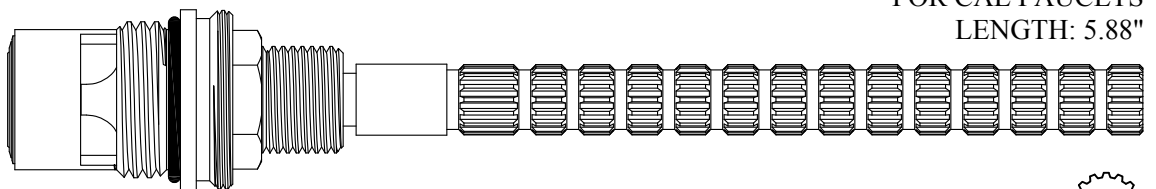

FOR CAL FAUCETS  
LENGTH: 5.88"

**411291/ 411292**  
GASKET: 890170 O-RING INCLUDED  
SEAL: 898510-W  
DISC SET: 151380-PKG

16  
3-16

Ceramic Conversion for 421601 / 421602

FOR ARTISTIC BRASS  
FOR PRICE PFISTER  
LENGTH: 5.88"

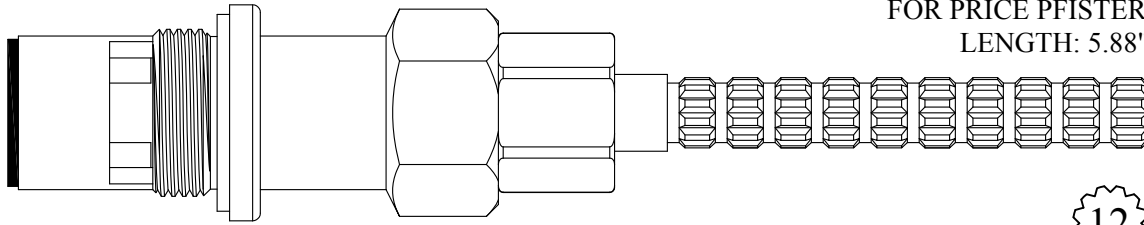

421691/ 421692

GASKET: 895390 INCLUDED  
SEAL: 898550  
DISC SET: 124290-PKG

12  
1-2

Chrome Plated Stem

FOR QUEEN CITY  
LENGTH: 5.89"

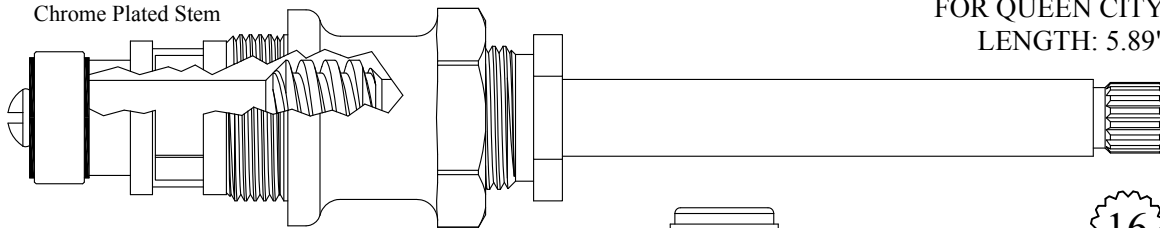

436211  
236211 Stem Only

GASKET: 895400

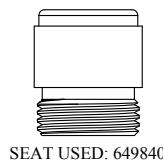

SEAT USED: 649840

16  
1-6

1/2 Turn Ceramic

FOR DOLLY TRIM  
LENGTH: 5.89"

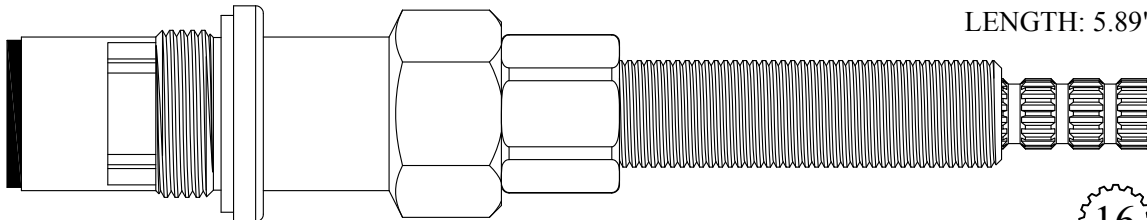

421641/ 421642

GASKET: 895390 INCLUDED  
SEAL: 898550  
DISC SET: 124290-PKG

16  
3-16

FOR PRICE PFISTER  
LENGTH: 5.89"

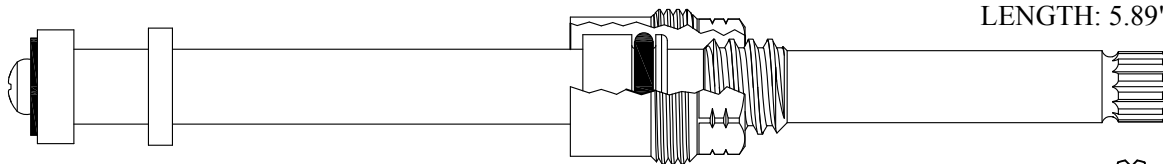

LF480071/ LF480072

GASKET: 895060



SEAT USED: LF648270

12  
1-2

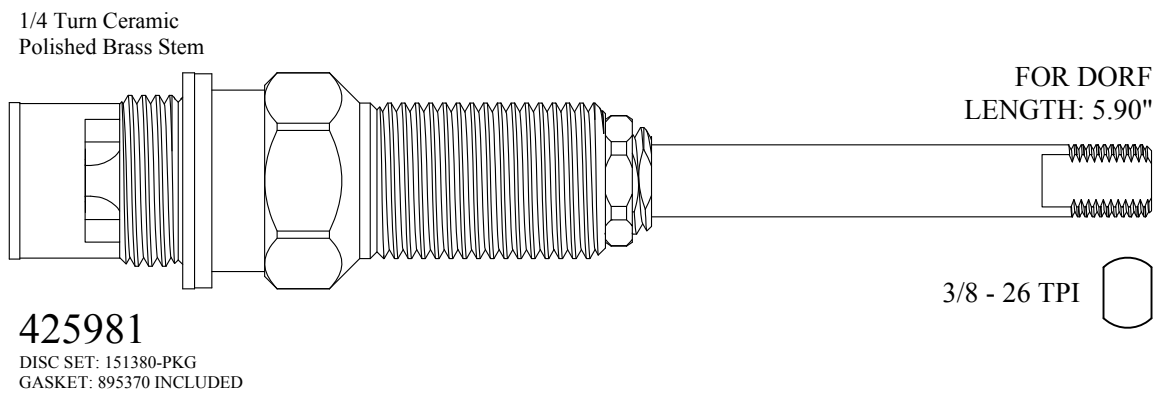
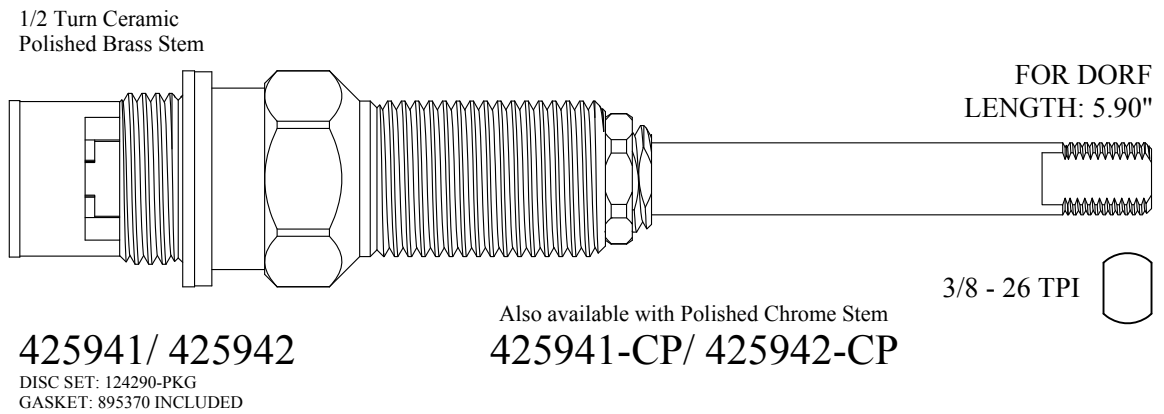
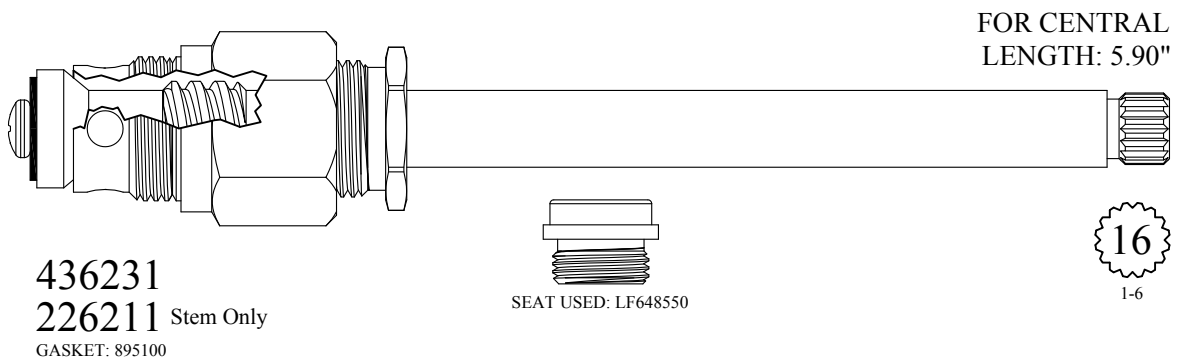
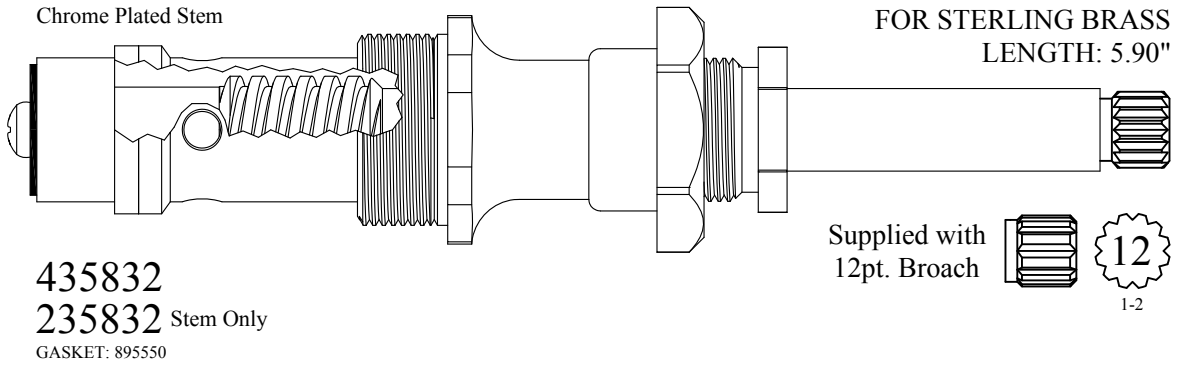

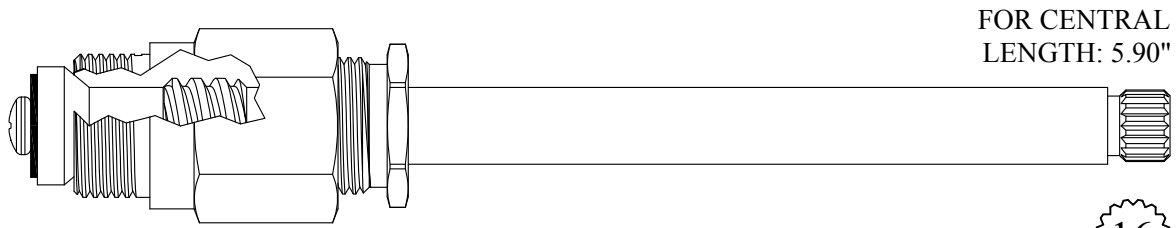

FOR CENTRAL  
LENGTH: 5.90"

426211/ 426212  
226211/ 226212 Stem Only  
GASKET: 895100

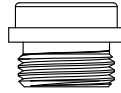

SEAT USED: LF648550

16  
1-6

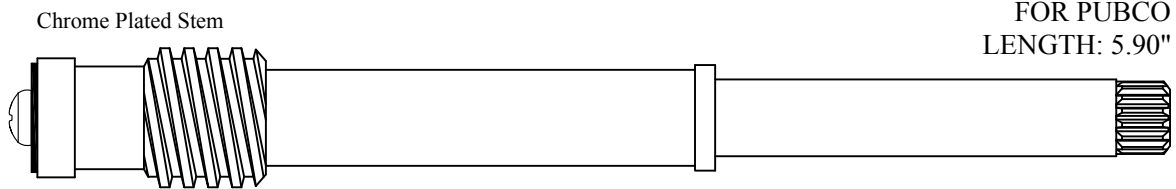

FOR PUBCO  
LENGTH: 5.90"

LF280091

16  
1-6

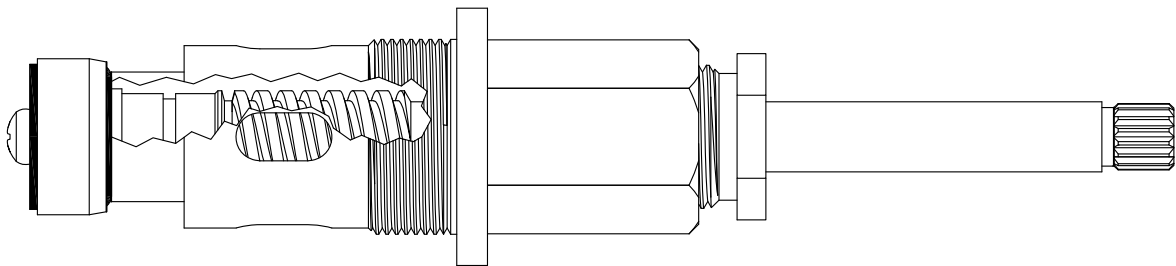

Old Style, Use 433441 or 236401 stem only

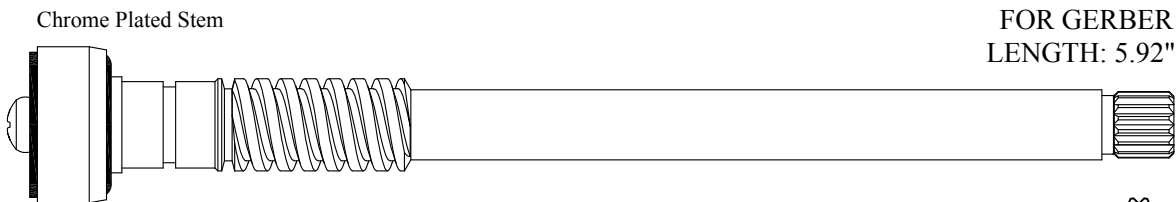

FOR GERBER  
LENGTH: 5.92"

236401

16  
2-3

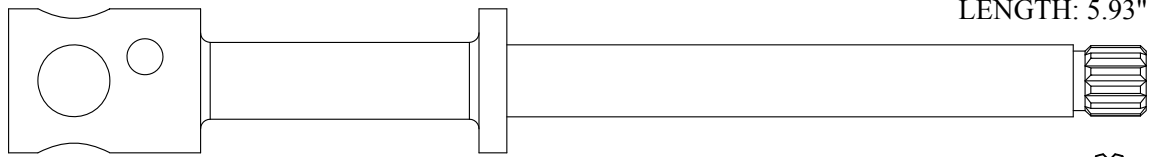

FOR GRAND HAVEN  
LENGTH: 5.93"

236310

12  
1-2

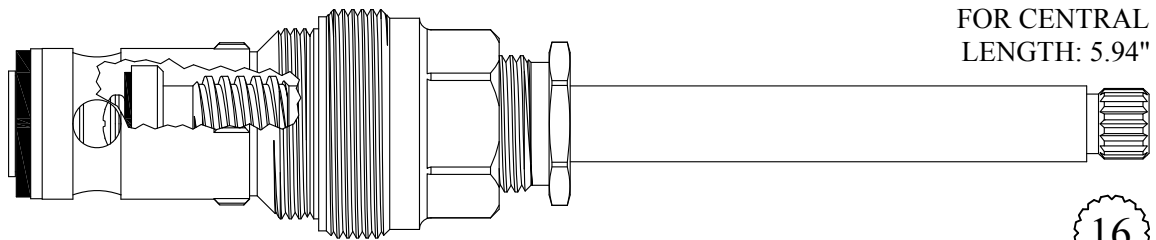

FOR CENTRAL  
LENGTH: 5.94"

424711

GASKET: 895340  
SEAT INCLUDED : 647850

16  
1-6

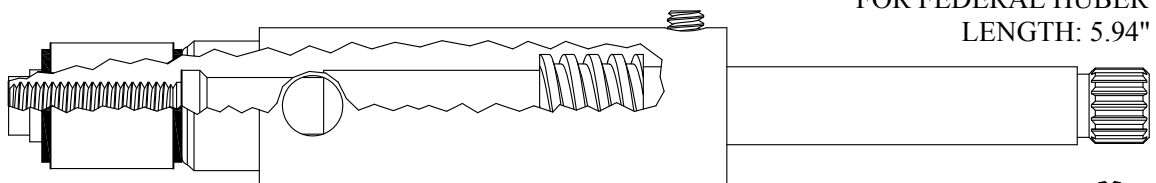

FOR FEDERAL HUBER  
LENGTH: 5.94"

436441

16  
1-5

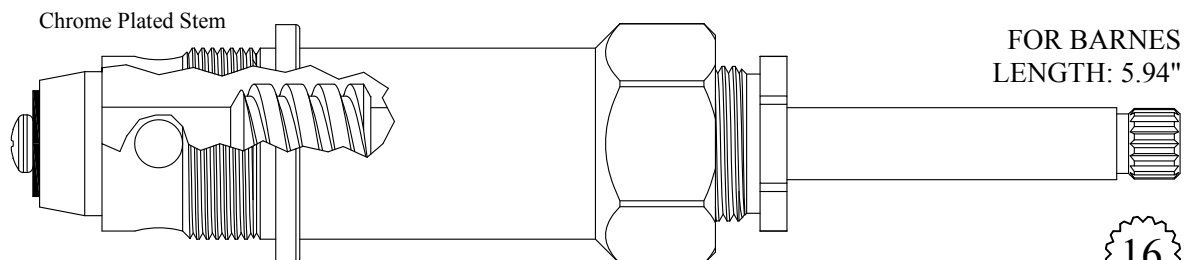

FOR BARNES  
LENGTH: 5.94"

437601

237601 Stem Only

16  
1-6

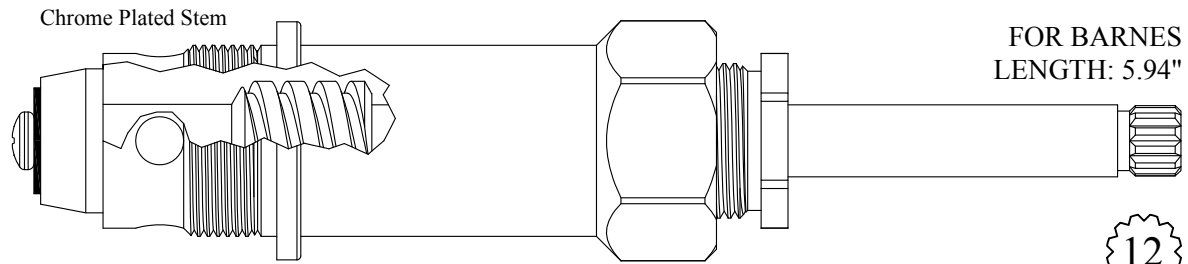

Chrome Plated Stem

FOR BARNES  
LENGTH: 5.94"

437651  
237651 Stem Only

12  
1-2

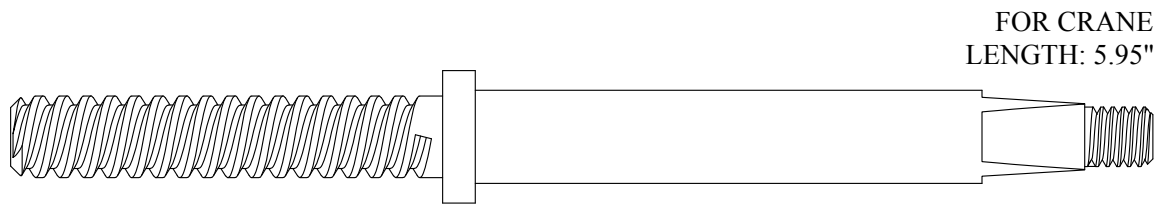

FOR CRANE  
LENGTH: 5.95"

281522

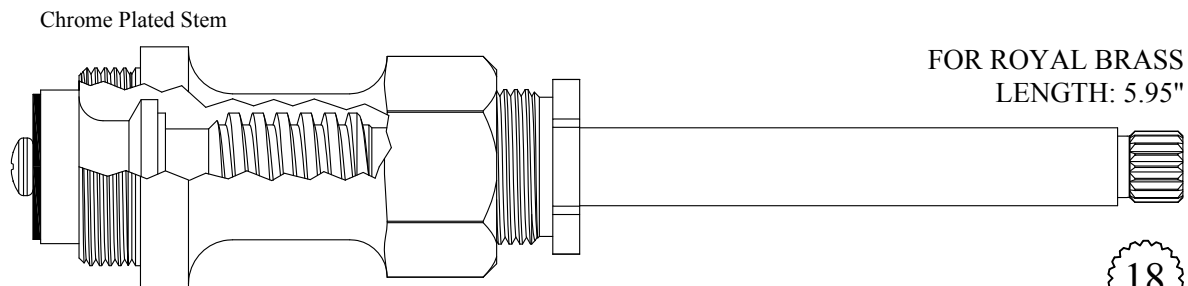

Chrome Plated Stem

FOR ROYAL BRASS  
LENGTH: 5.95"

426001  
226001 Stem Only  
GASKET: 895560

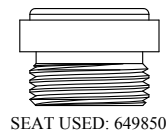

SEAT USED: 649850

18  
3-3

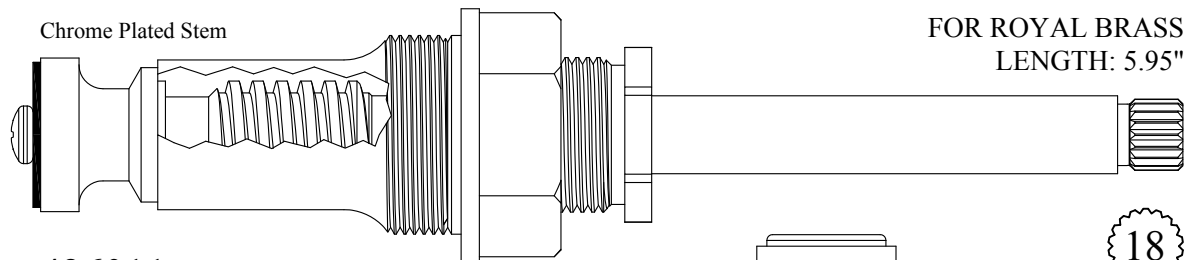

Chrome Plated Stem

FOR ROYAL BRASS  
LENGTH: 5.95"

426011  
226001 Stem Only  
GASKET: 895560

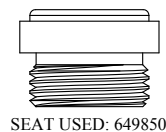

SEAT USED: 649850

18  
3-3



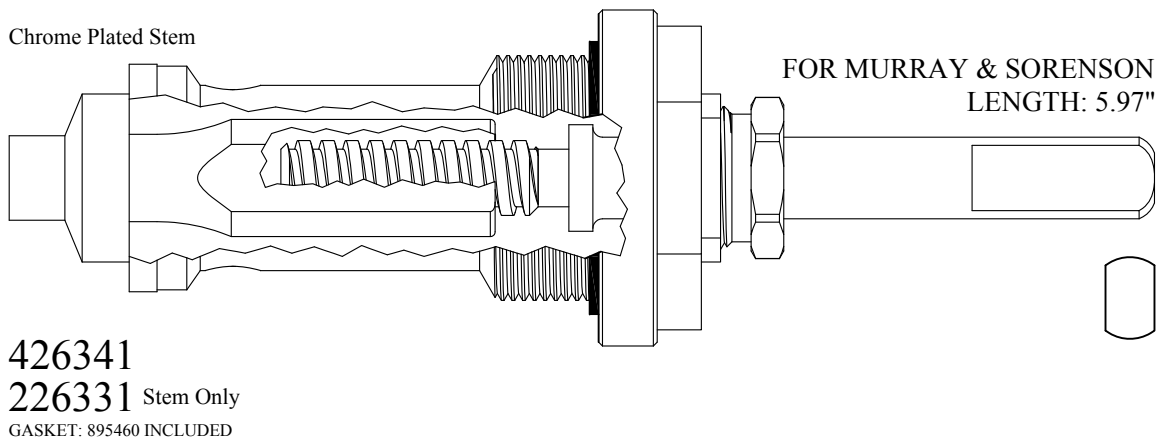
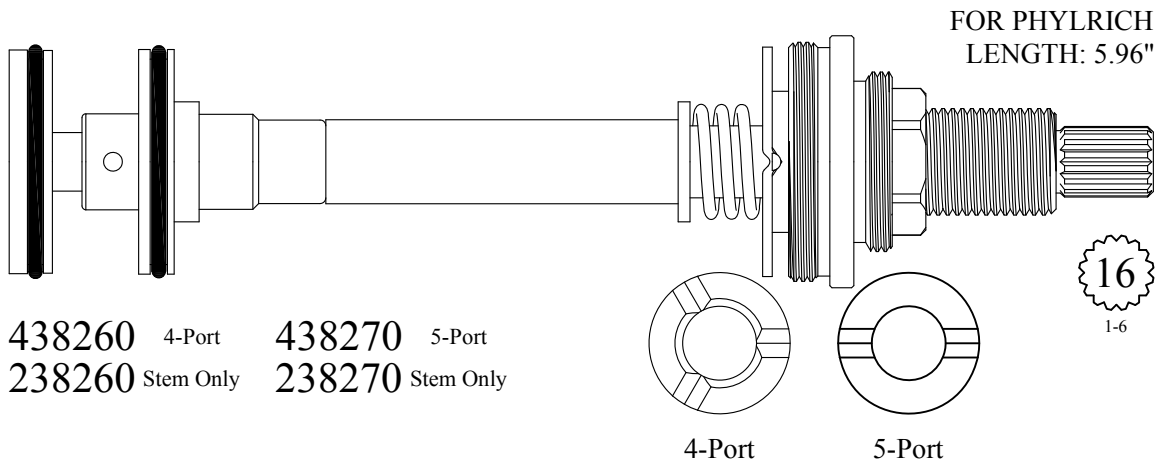
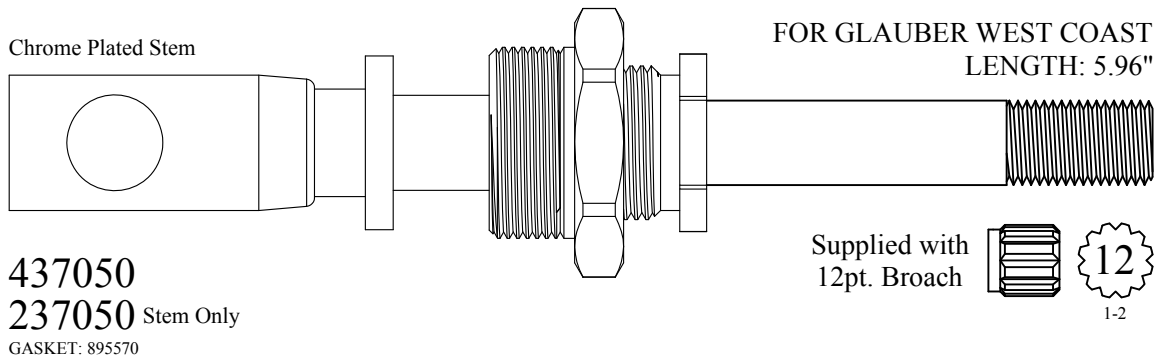
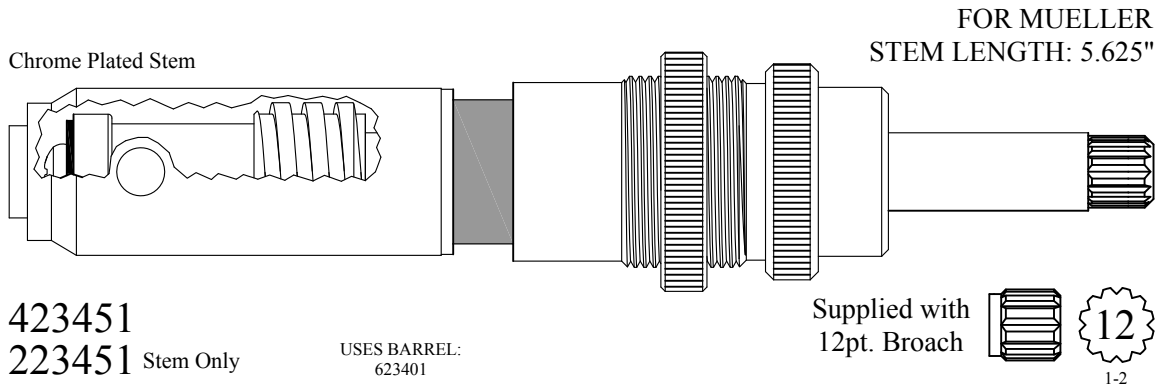

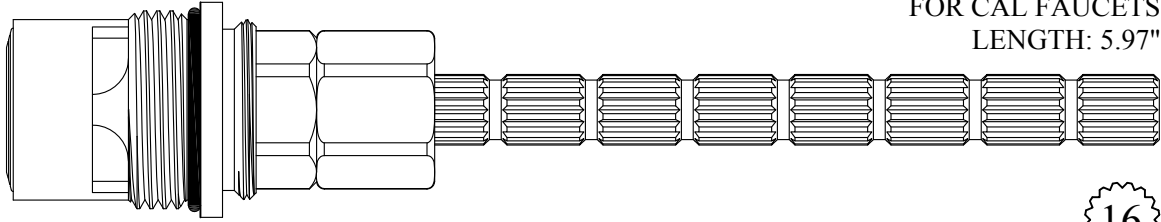

FOR CAL FAUCETS  
LENGTH: 5.97"

16  
1-6

**421661/ 421662**  
GASKET: 890210 O-RING INCLUDED  
SEAL: 898520  
DISC SET: 109850-PKG

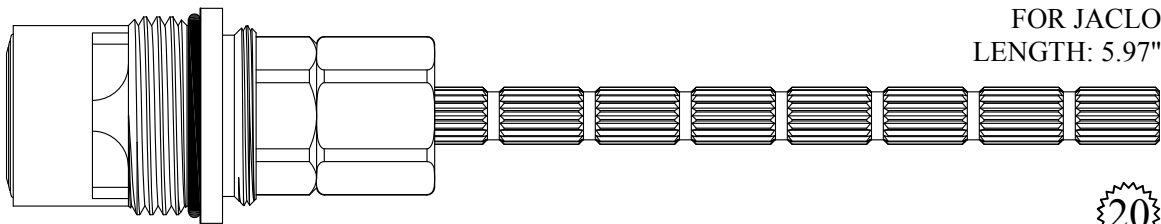

FOR JACLO  
LENGTH: 5.97"

20  
3-20

**421681/ 421682**  
GASKET: 890210 O-RING INCLUDED  
SEAL: 898520  
DISC SET: 109850-PKG

Chrome Plated Stem

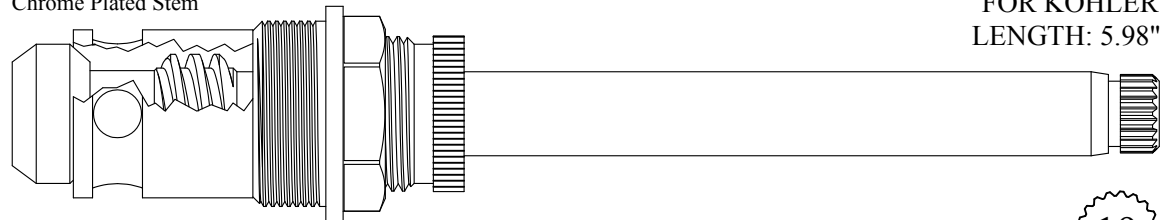

FOR KOHLER  
LENGTH: 5.98"

19  
1-7

**437311**  
**237311** Stem Only  
GASKET: 895350

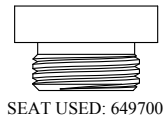

SEAT USED: 649700

Chrome Plated Stem & Packing Nut

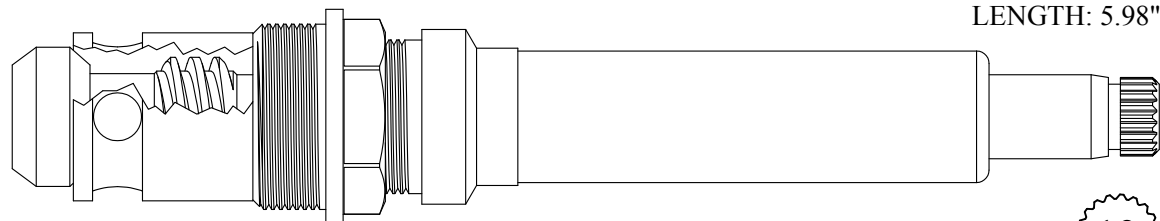

FOR KOHLER  
LENGTH: 5.98"

19  
1-7

**437321**  
**237311** Stem Only  
GASKET: 895350

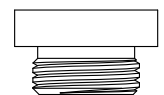

SEAT USED: 649700

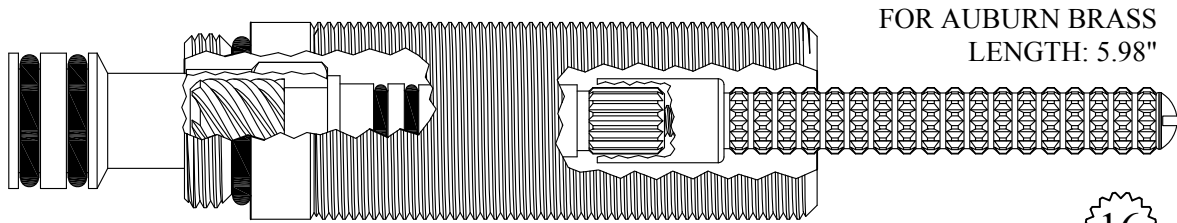

FOR AUBURN BRASS  
LENGTH: 5.98"

**437611**  
GASKET: 891150 O-RING INCLUDED

16  
2-3

Chrome Plated Stem

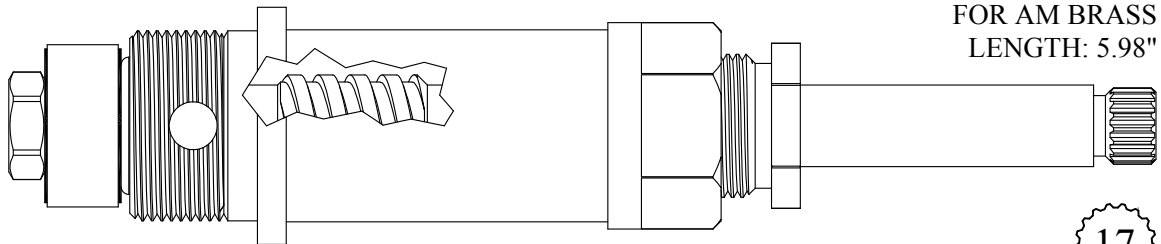

FOR AM BRASS  
LENGTH: 5.98"

**438701**  
**238701** Stem Only  
GASKET: 895550

17  
3-7

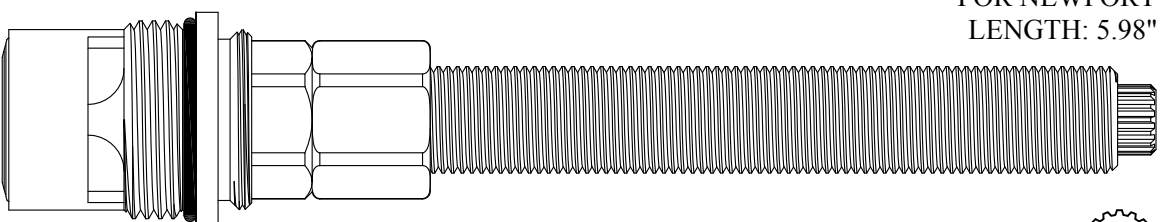

FOR NEWPORT  
LENGTH: 5.98"

**424911/ 424912**  
GASKET: 890210 O-RING INCLUDED  
SEAL: 898520  
DISC SET: 109850-PKG

16  
3-16

Chrome Plated Stem

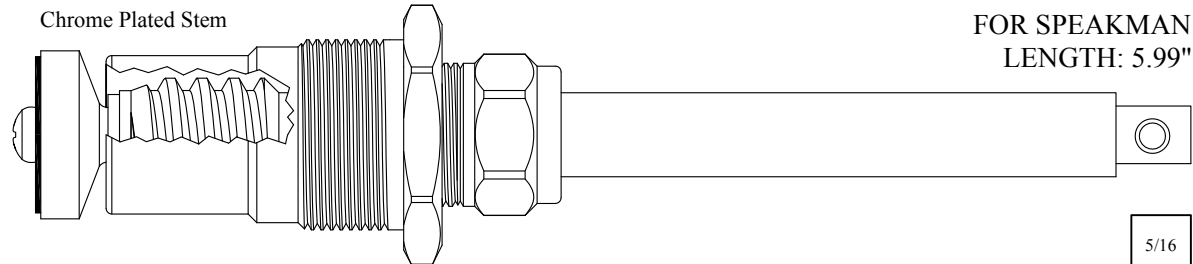

FOR SPEAKMAN  
LENGTH: 5.99"

**426041**  
**226041** Stem Only  
GASKET: 895550

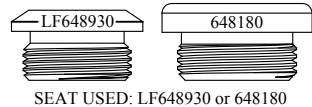

SEAT USED: LF648930 or 648180

5/16

Chrome Plated Stem

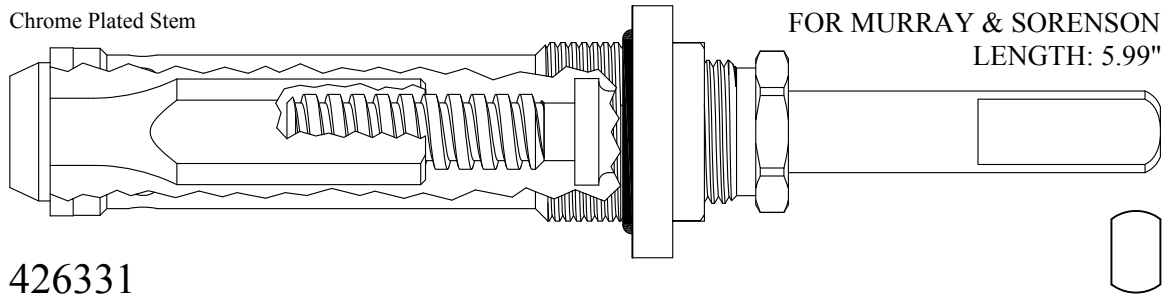

426331

226331 Stem Only

GASKET: 891180 O-RING INCLUDED

Chrome Plated Stem

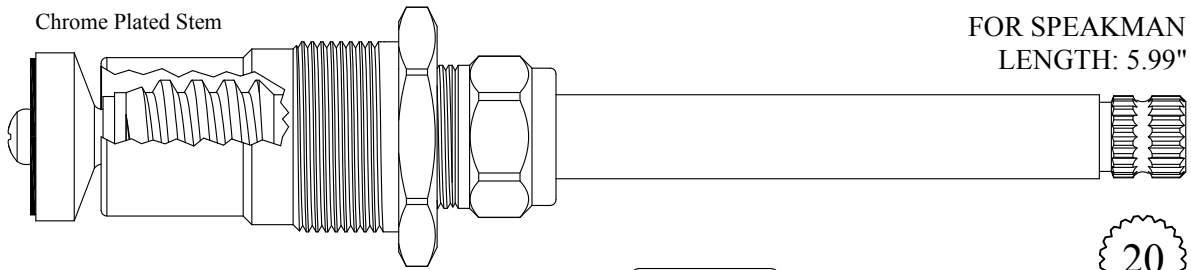

426021/ 426022

226021/ 226022 Stem Only

GASKET: 895550

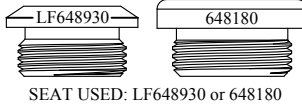

20  
2-4

Chrome Plated Stem

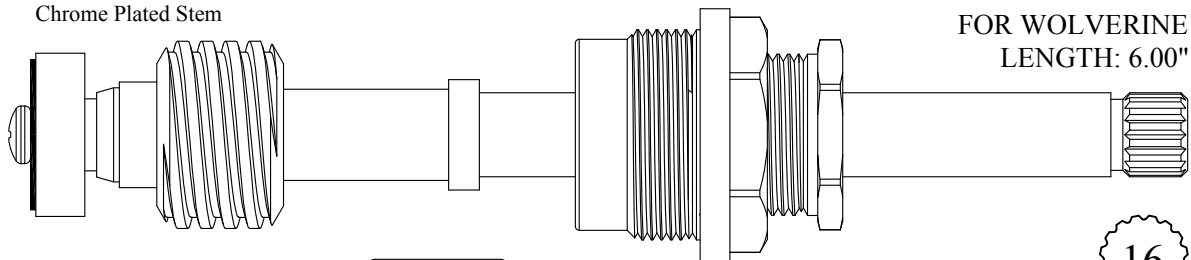

426201

226201 Stem Only

GASKET: 895450

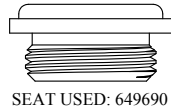

16  
3-26

Chrome Plated Stem

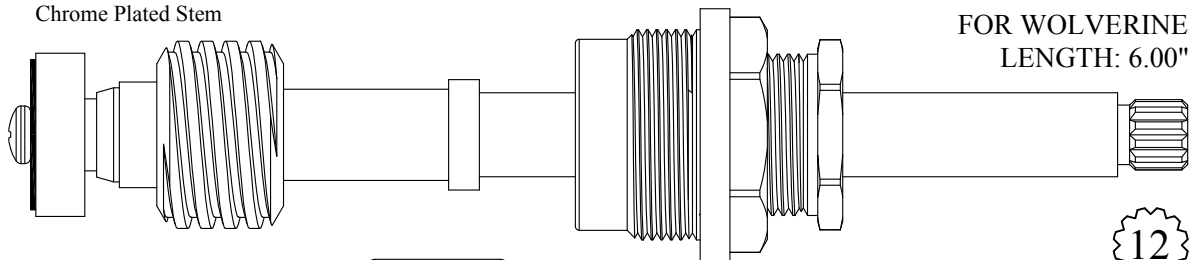

426251

226251 Stem Only

GASKET: 895450

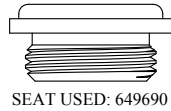

12  
1-2

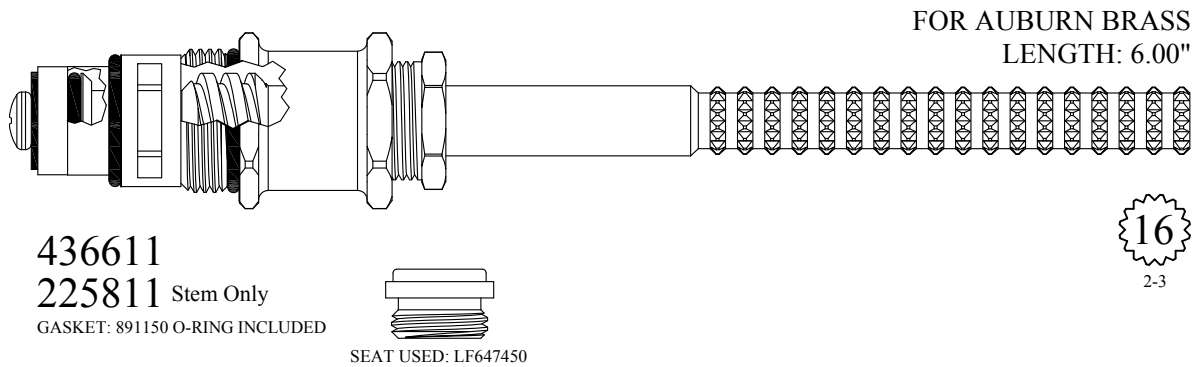
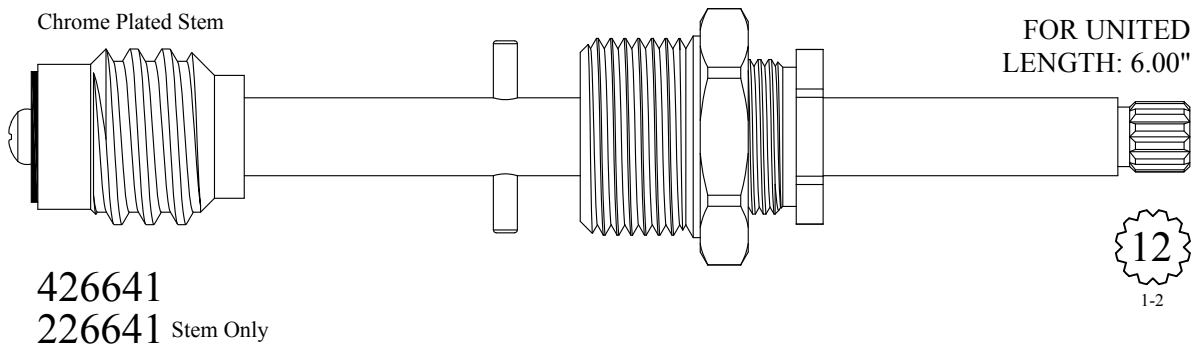
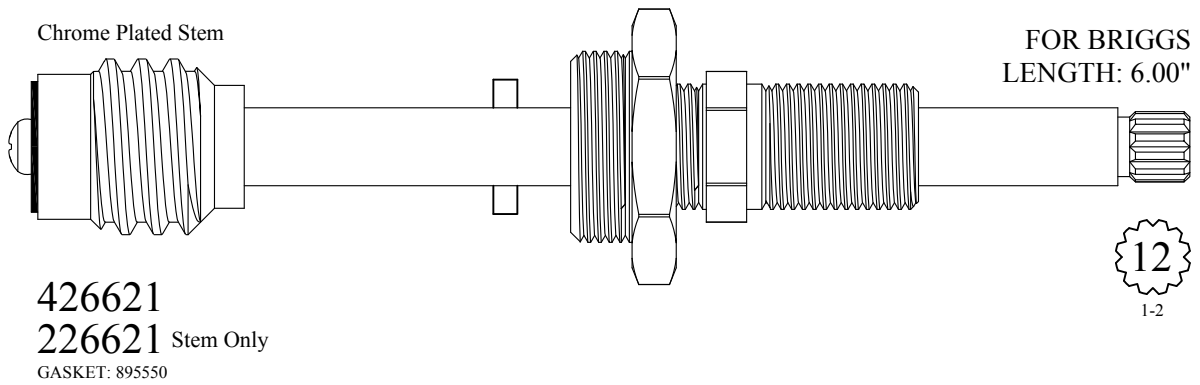
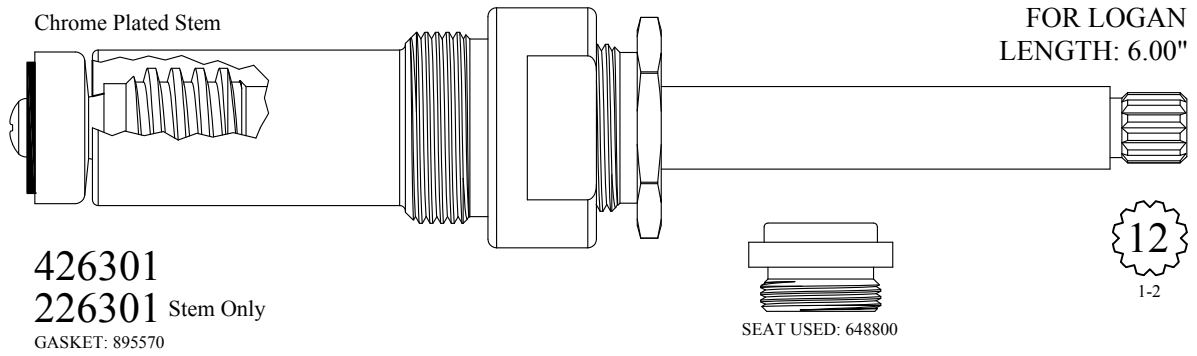

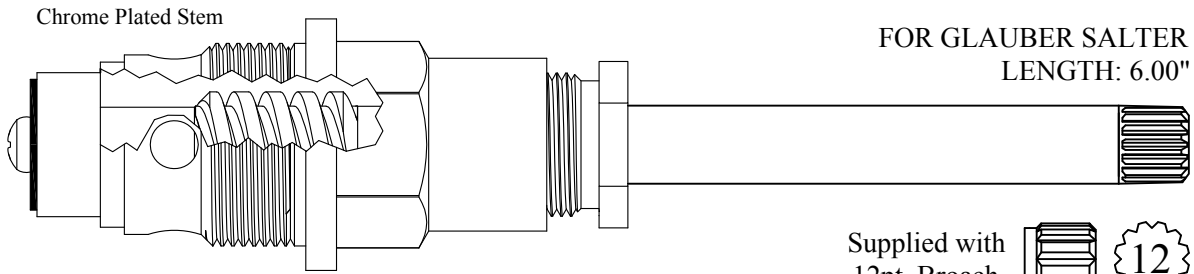

437451  
 237451 Stem Only  
 GASKET: 895440

Supplied with  12  
 1-2

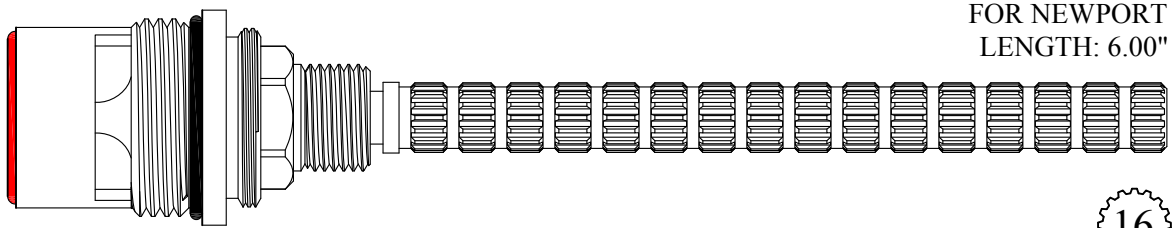

423651/ 423652  
 GASKET: 890210 O-RING INCLUDED  
 SEAL: 898610-R/B  
 DISC SET: 109850-PKG

FOR NEWPORT  
 LENGTH: 6.00"

  
 3-16

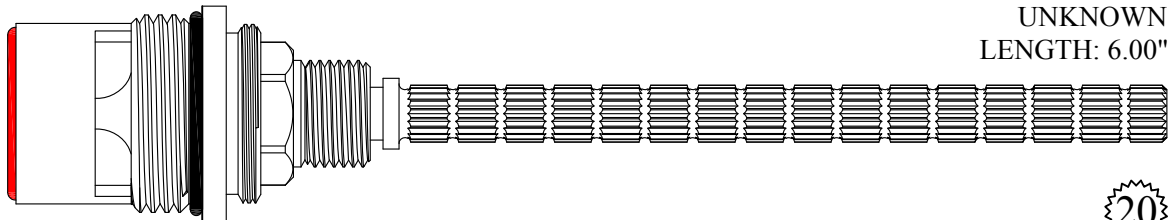

423671/ 423672  
 GASKET: 890170 O-RING INCLUDED  
 SEAL: 898610-R/B  
 DISC SET: 109850-PKG

UNKNOWN  
 LENGTH: 6.00"

  
 3-20

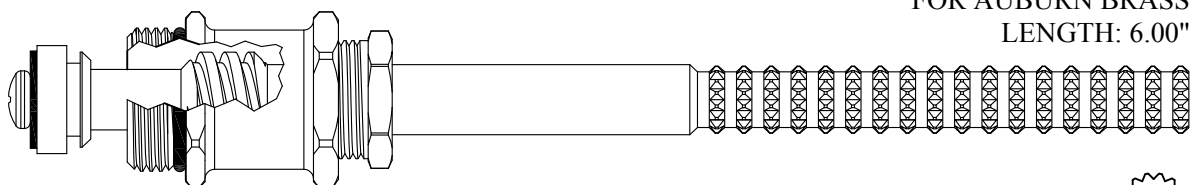

425811/ 425812  
 225811/ 225812 Stem Only  
 GASKET: 891150 O-RING INCLUDED

FOR AUBURN BRASS  
 LENGTH: 6.00"

  
 2-3

  
 SEAT USED: LF647450

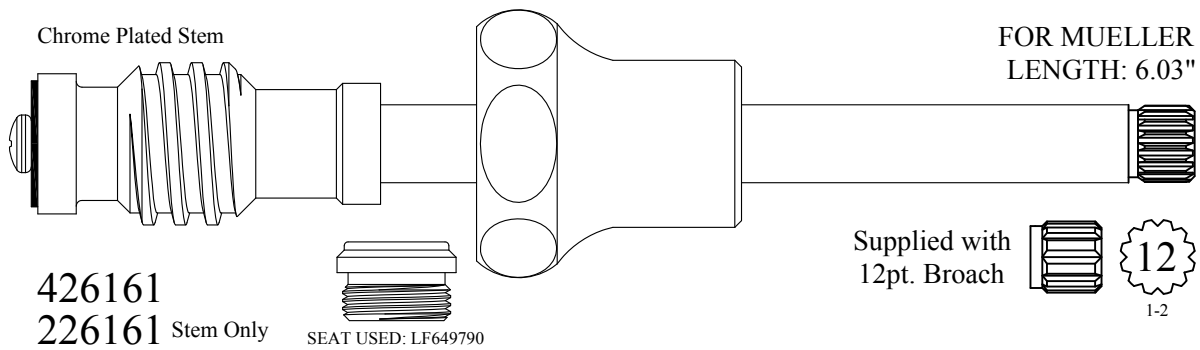
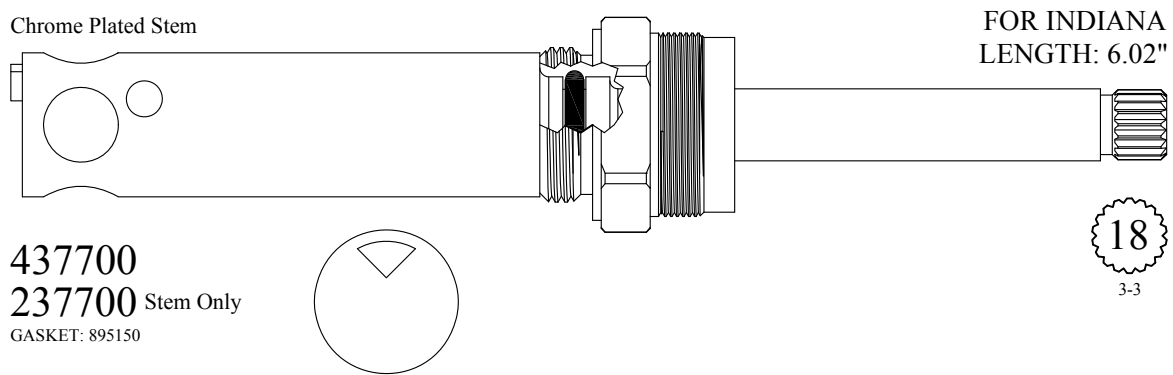
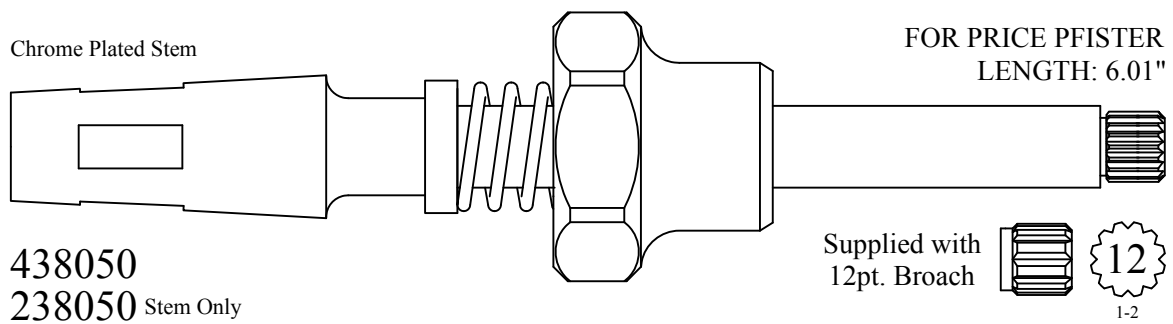
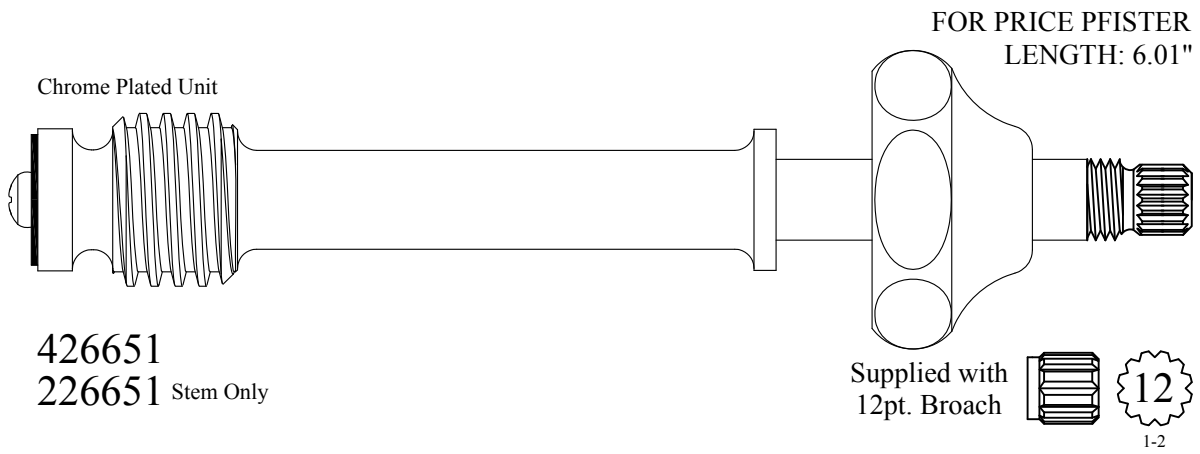

Polished Brass Stem

FOR BROADWAY  
LENGTH: 6.03"

20  
2-4

Also available with polished chrome plated stem

426031-CP/ 426032-CP  
226031-CP/ 226032-CP Stem Only

GASKET: 895570

SEAT USED: 648180

FOR ALTMANS  
LENGTH: 6.04"

20  
2-4

16  
3-16

225730

Chrome Plated Stem

FOR BRIGGS  
LENGTH: 6.05"

18  
3-3

437502  
237502 Stem Only

GASKET: 895370

Chrome Plated Unit

FOR BRIGGS  
LENGTH: 6.05"

18  
3-3

437512  
237502 Stem Only

GASKET: 895370



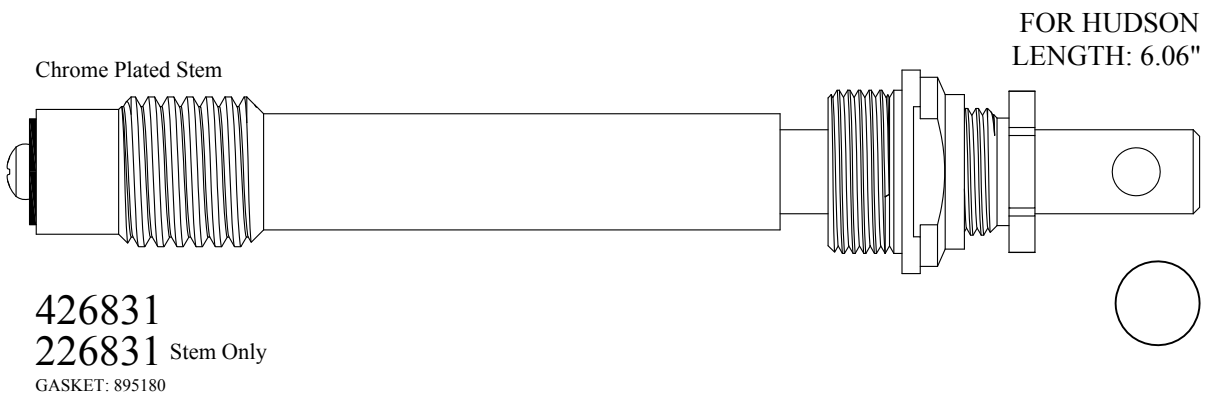
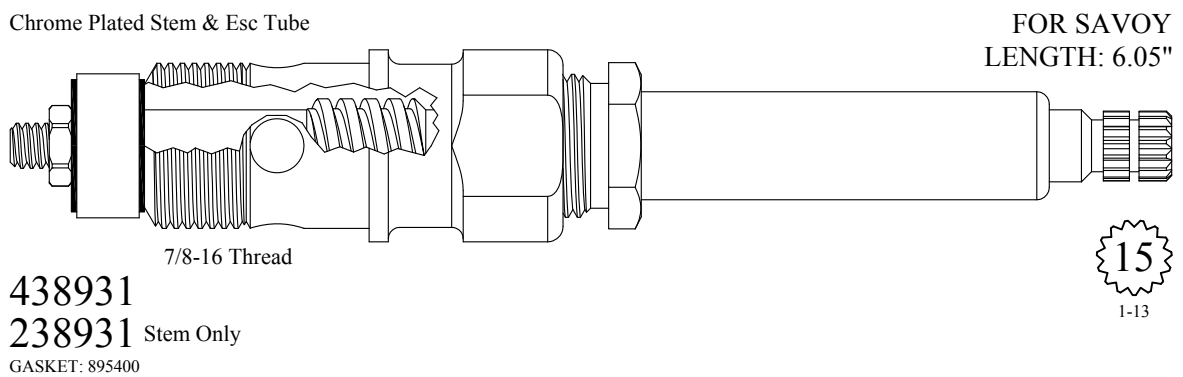
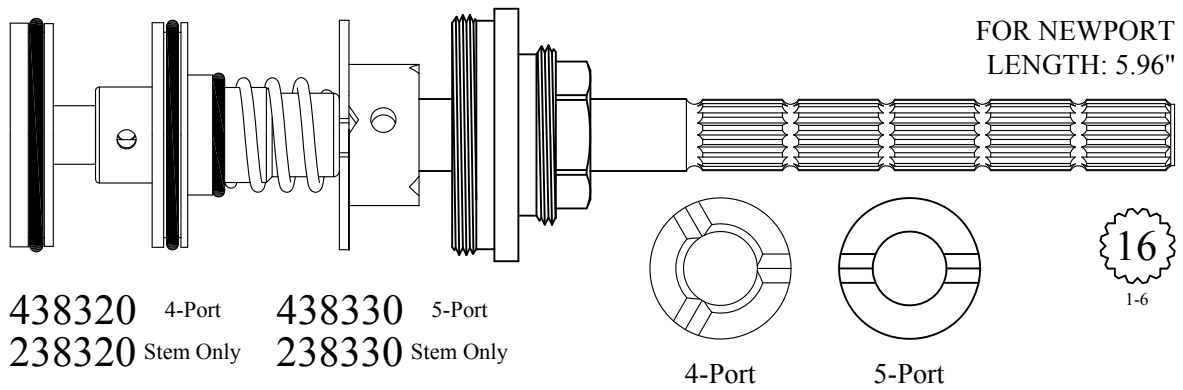
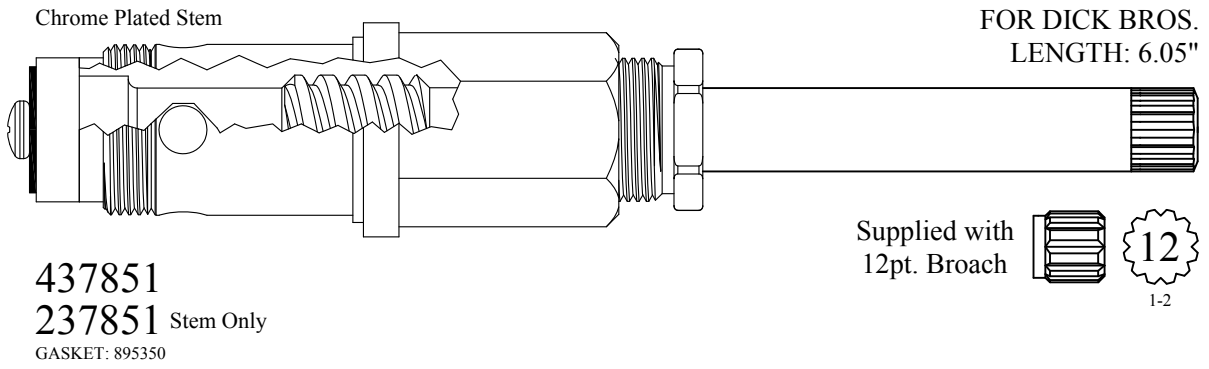

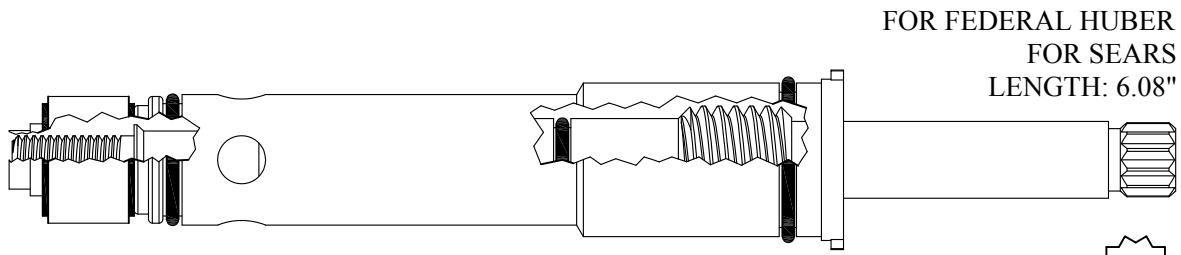

437011

12  
3-10

Chrome Plated Stem

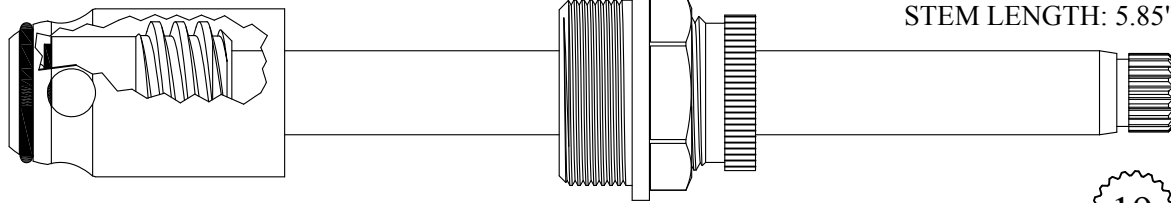

425931  
225901 Stem Only  
GASKET: 895350

USES BARREL:  
647321

FOR KOHLER  
STEM LENGTH: 5.85"

19  
1-7

Chrome Plated Stem

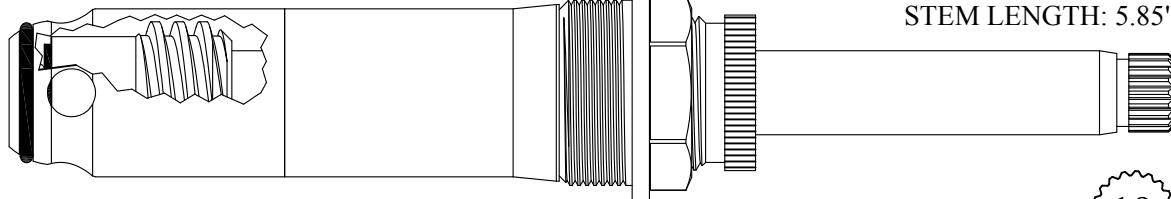

425901/ 425902  
225901/ 225902 Stem Only  
GASKET: 895350

USES BARREL:  
647321/647322

FOR KOHLER  
STEM LENGTH: 5.85"

19  
1-7

Chrome Plated Stem

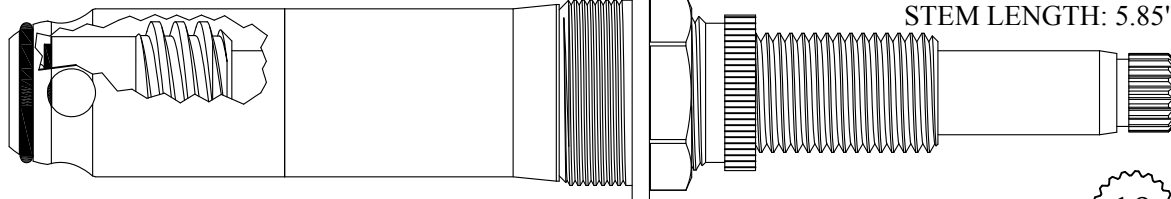

425911/ 425912  
225901/ 225902 Stem Only  
GASKET: 895350

USES BARREL:  
647321/647322

FOR KOHLER  
STEM LENGTH: 5.85"

19  
1-7

Chrome Plated Stem

FOR KOHLER  
STEM LENGTH: 5.85"

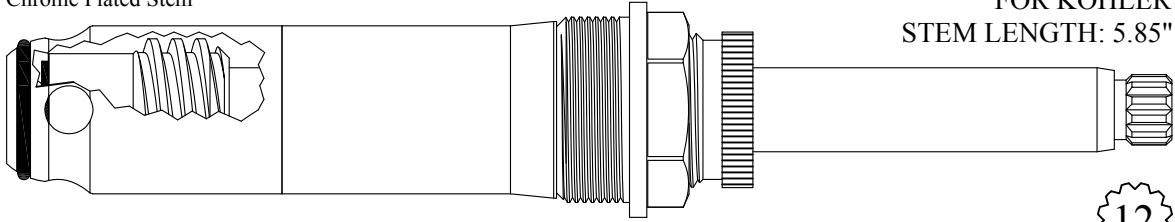

425951/ 425952  
225951/ 225952 Stem Only  
GASKET: 895350

USES BARREL:  
647321/647322

12  
1-2

Chrome Plated Stem & Packing Nut

FOR KOHLER  
STEM LENGTH: 5.85"

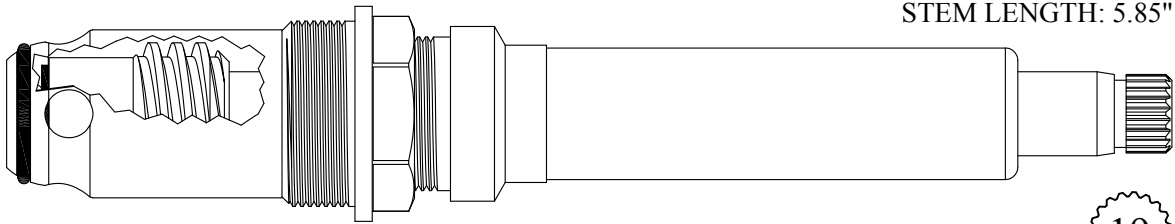

425961/ 425962  
225901/ 225902 Stem Only  
GASKET: 895350

USES BARREL:  
647321/647322

19  
1-7

Chrome Plated Stem

FOR FEDERAL HUBER  
LENGTH: 6.08"

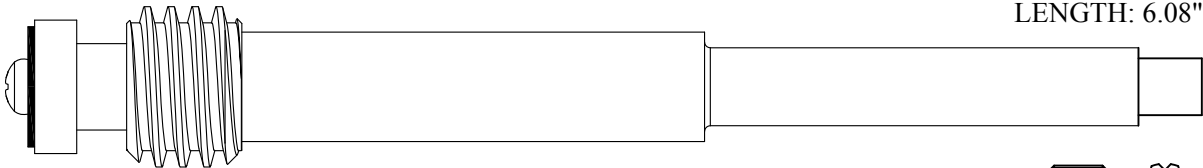

226631

Supplied with  
12pt. Broach



12  
1-2

FOR FEDERAL HUBER  
FOR SEARS  
LENGTH: 6.08"

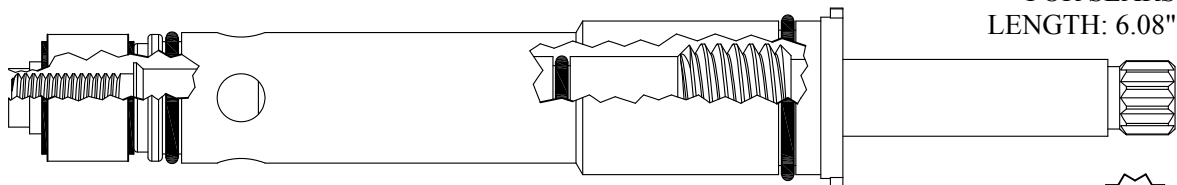

437011

12  
3-10

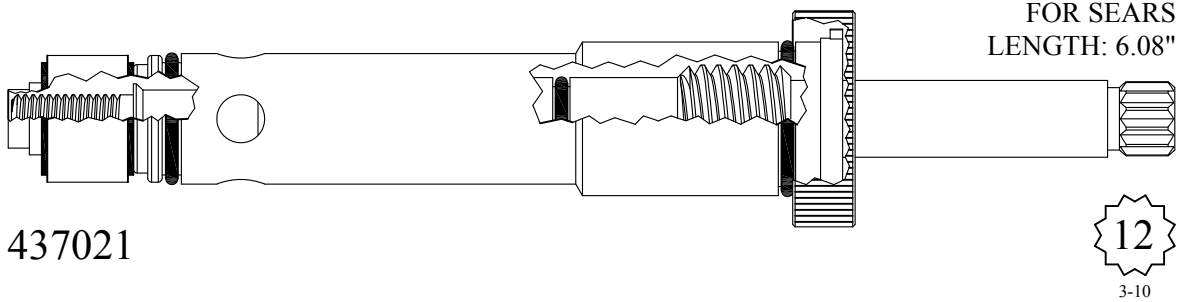

437021

12  
3-10

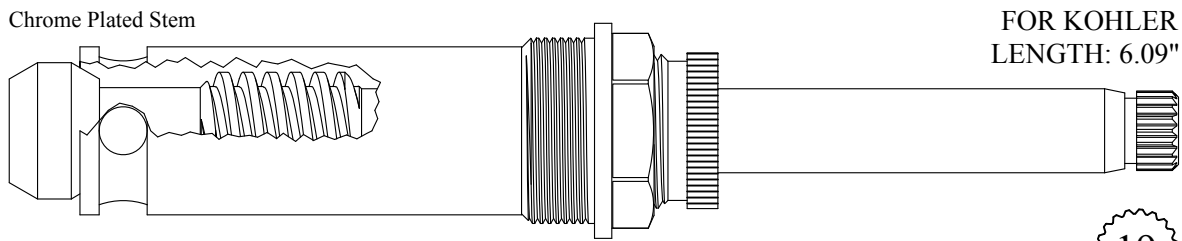

437301

237301 Stem Only  
GASKET: 895350

Also available with seat 649700  
LF437301-S

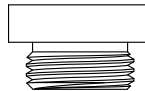

19  
1-7

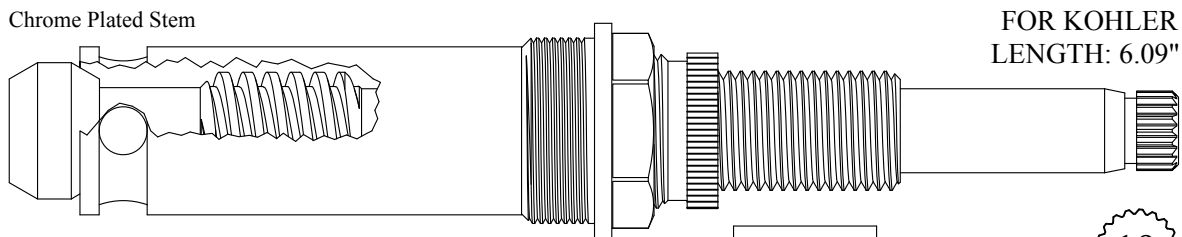

437331

237301 Stem Only  
GASKET: 895350

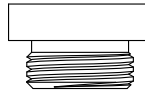

SEAT USED: 649700

19  
1-7

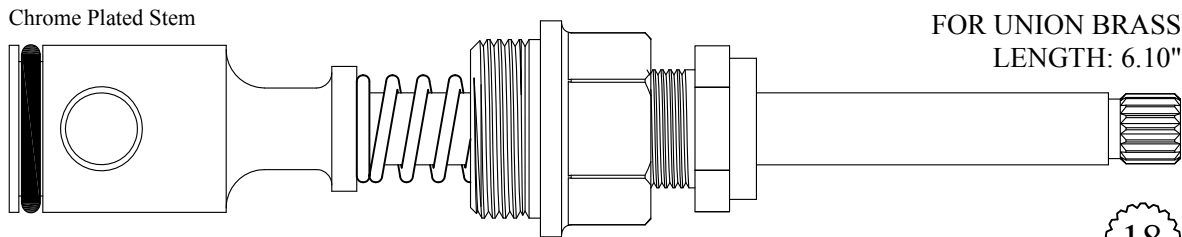

437900

237900 Stem Only  
GASKET: 895330

18  
3-3

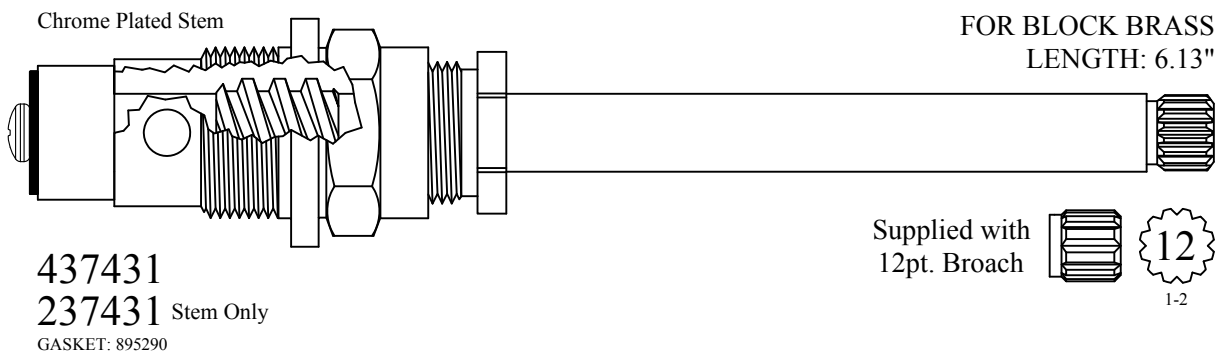
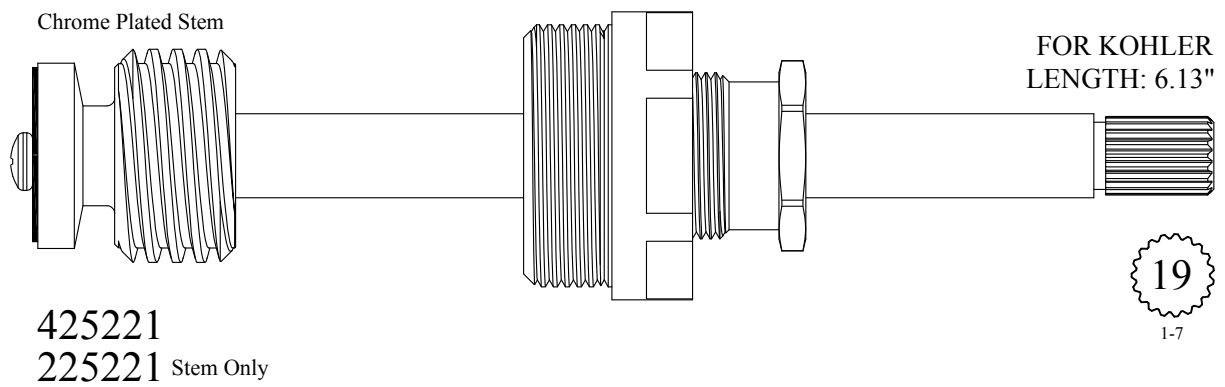
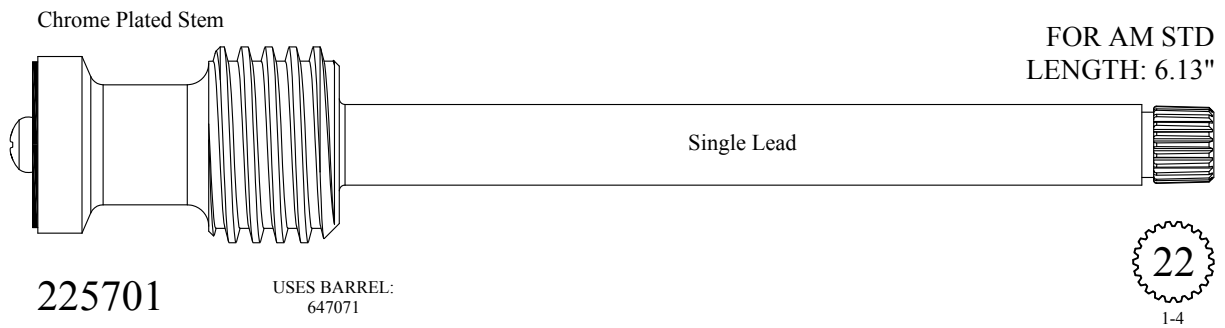
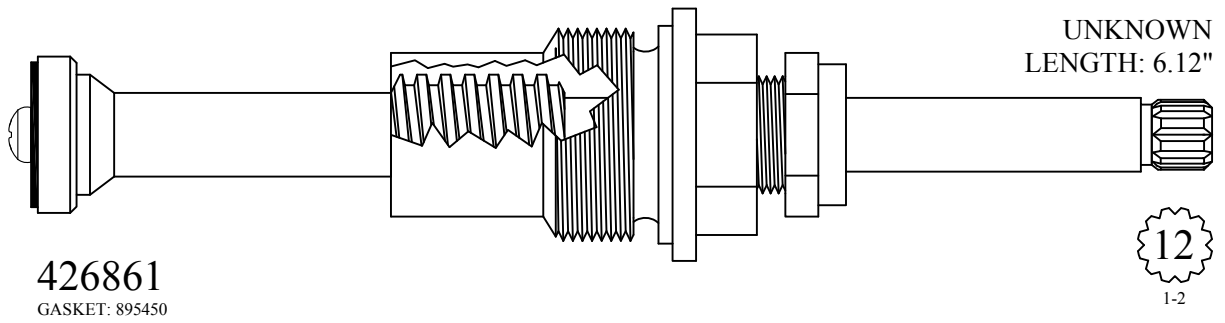

Chrome Plated Stem

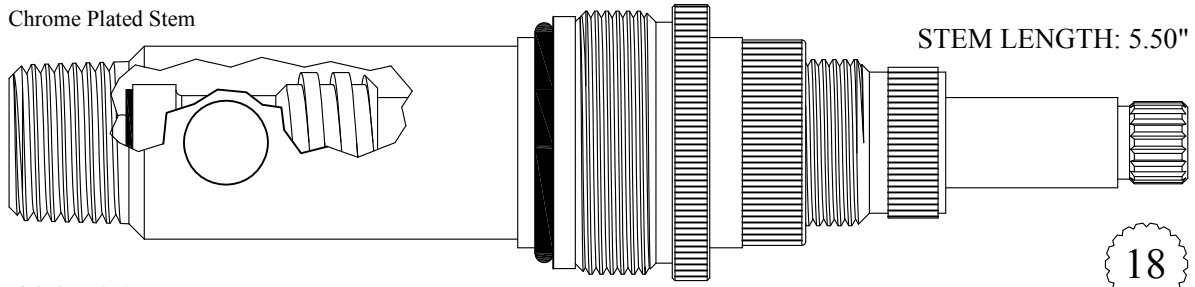

STEM LENGTH: 5.50"

18

**422701**

**222701** Stem Only

GASKET: 891210 O-RING INCLUDED

Chrome Plated Stem

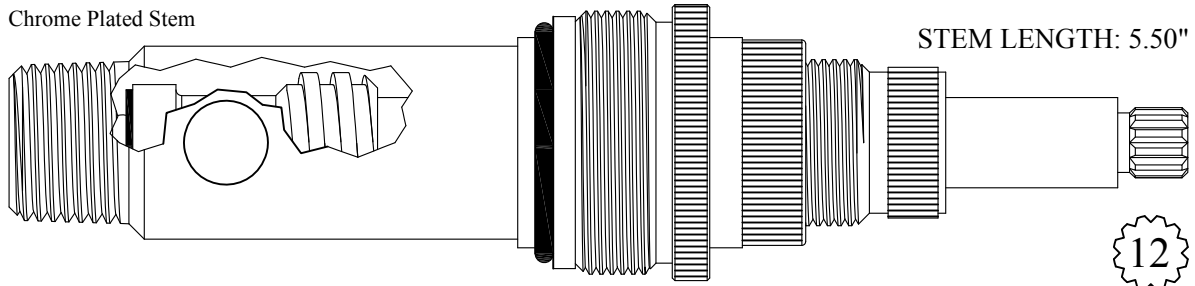

STEM LENGTH: 5.50"

12

1-2

**422751**

**222751** Stem Only

GASKET: 891210 O-RING INCLUDED

Chrome Plated Stem

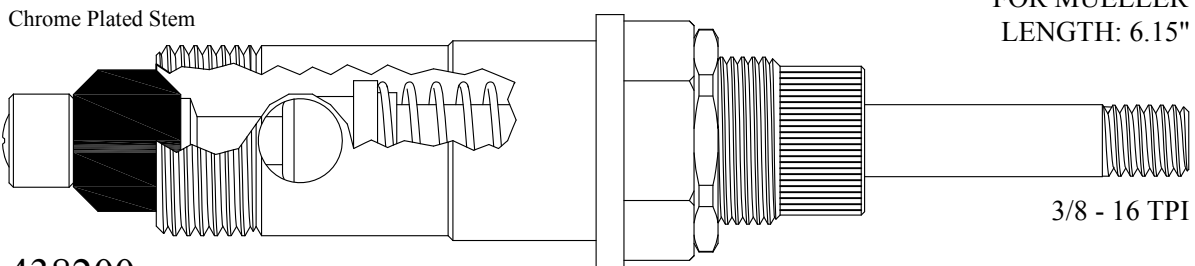

FOR MUELLER  
LENGTH: 6.15"

3/8 - 16 TPI

**438200**

**238200** Stem Only

GASKET: 895440

Chrome Plated Stem

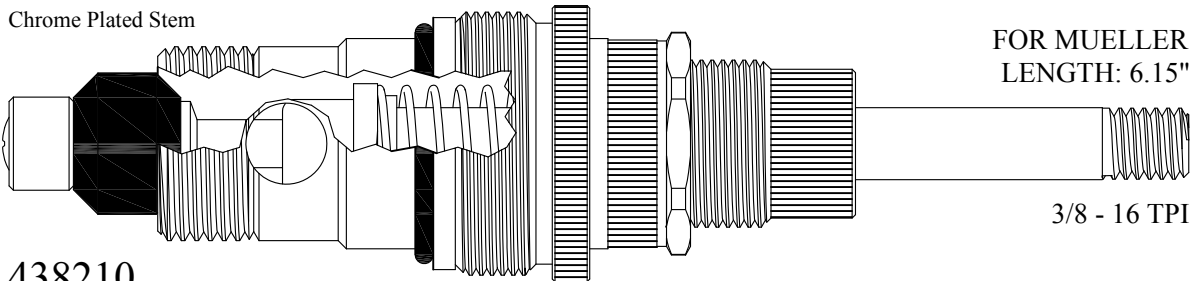

FOR MUELLER  
LENGTH: 6.15"

3/8 - 16 TPI

**438210**

**238200** Stem Only

GASKET: 895440

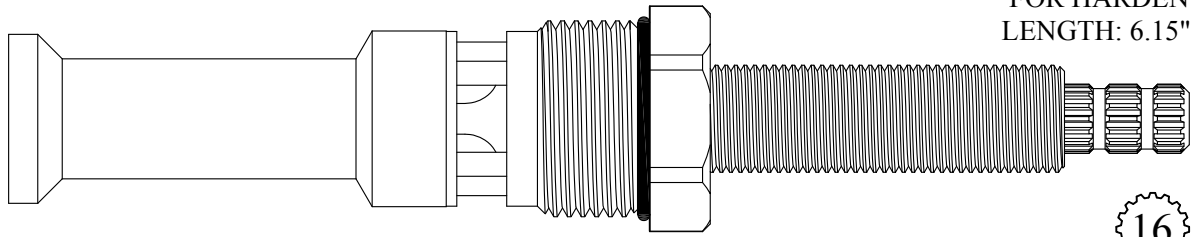

FOR HARDEN  
LENGTH: 6.15"

**426411/ 426412**

GASKET: 890210 O-RING INCLUDED  
SEAL: 64705-07  
DISC SET: 151380-PKG



3-16

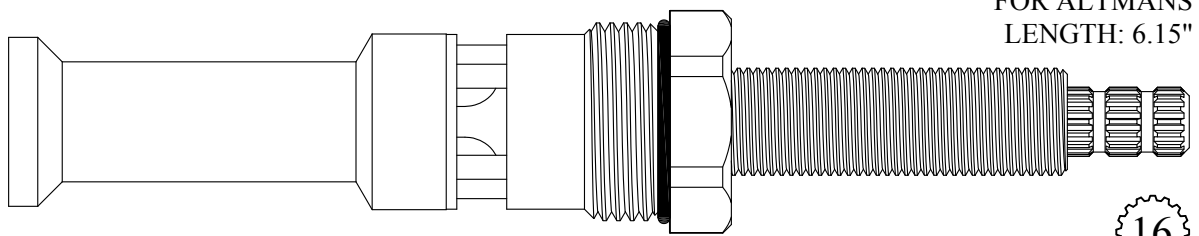

FOR ALTMANS  
LENGTH: 6.15"

**426421/ 426422** (Replaces Walter# 418811 / 418812 Compression Units)

GASKET: 890210 O-RING INCLUDED  
SEAL: 898510-W  
DISC SET: 151380-PKG



3-16

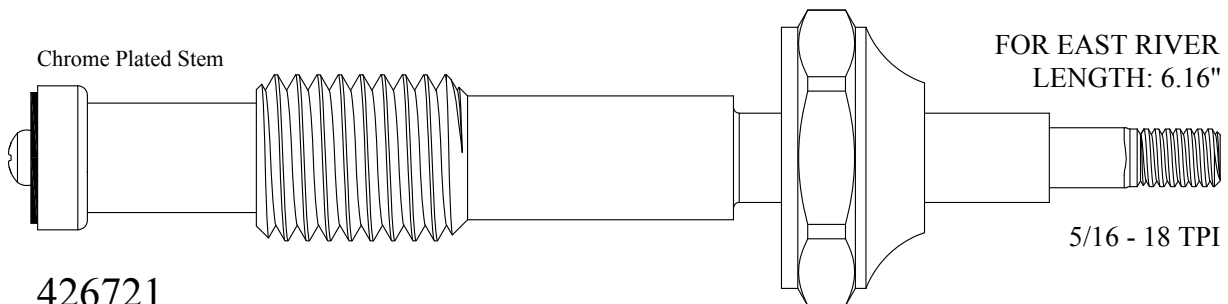

Chrome Plated Stem

FOR EAST RIVER  
LENGTH: 6.16"

**426721**  
**226721** Stem Only

5/16 - 18 TPI

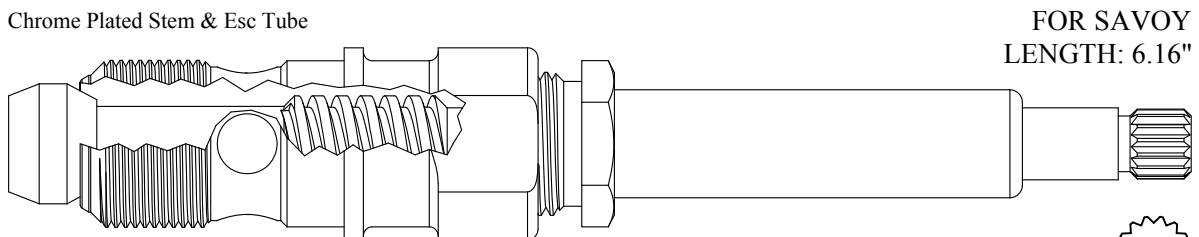

Chrome Plated Stem & Esc Tube

FOR SAVOY  
LENGTH: 6.16"

**438911**  
**238911** Stem Only

GASKET: 895400



1-13

Chrome Plated Stem & Esc Tube

FOR SAVOY  
LENGTH: 6.16"

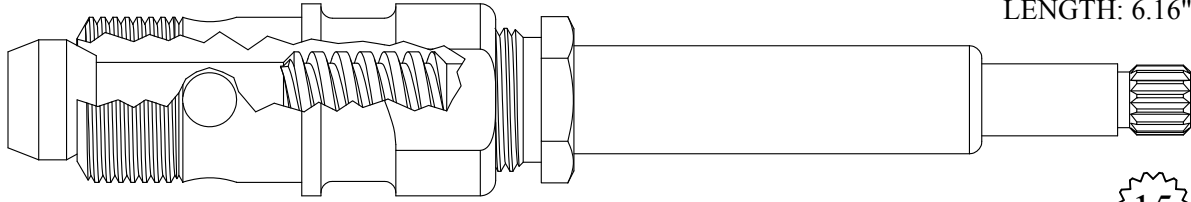

7/8-16 Thread

438941

238911 Stem Only

GASKET: 895400



1-13

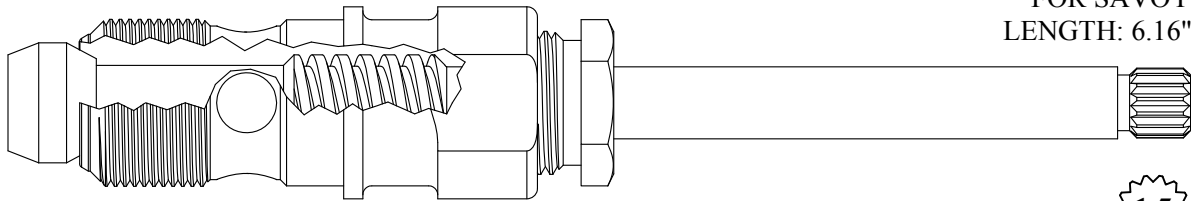

FOR SAVOY  
LENGTH: 6.16"

438951

238951 Stem Only

GASKET: 895400



1-13

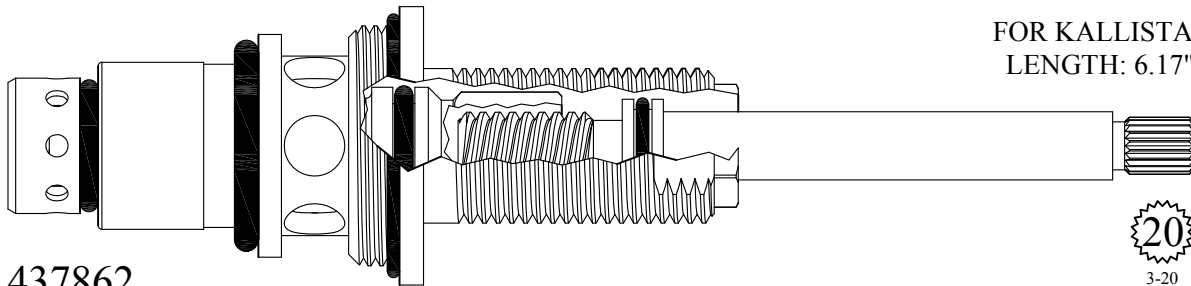

FOR KALLISTA  
LENGTH: 6.17"

437862

GASKET: 890240 O-RNG INCLUDED



3-20

Chrome Plated Stem

FOR PRICE PFISTER  
LENGTH: 6.17"

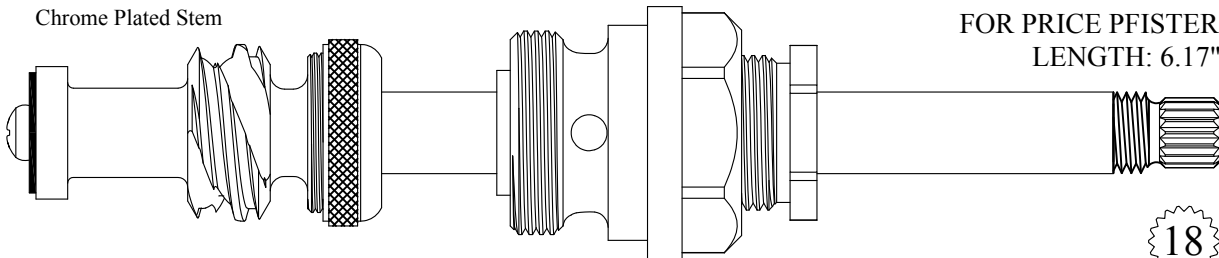

438301

238301 Stem Only

GASKET: 895450



Old Style  
Price Pfister



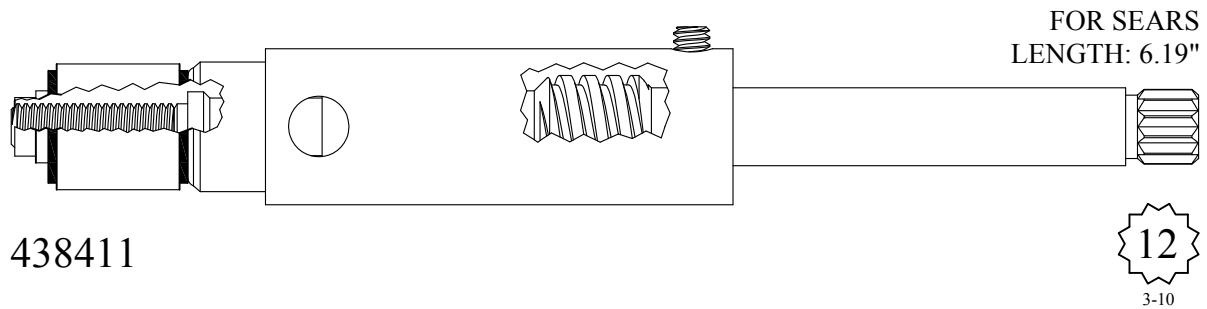
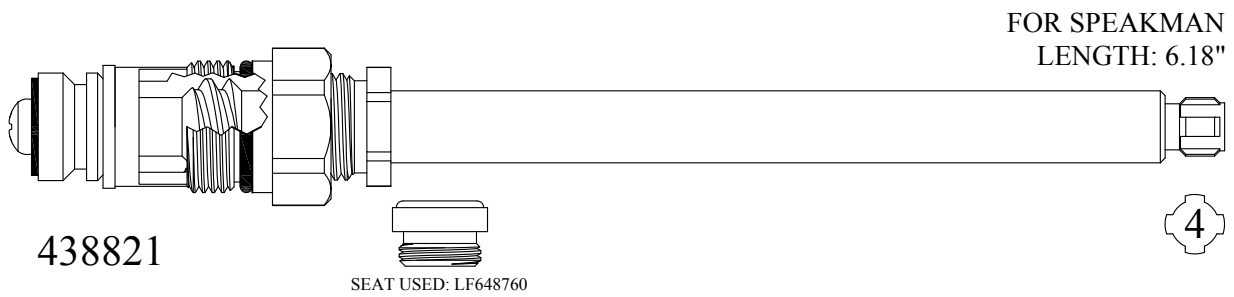
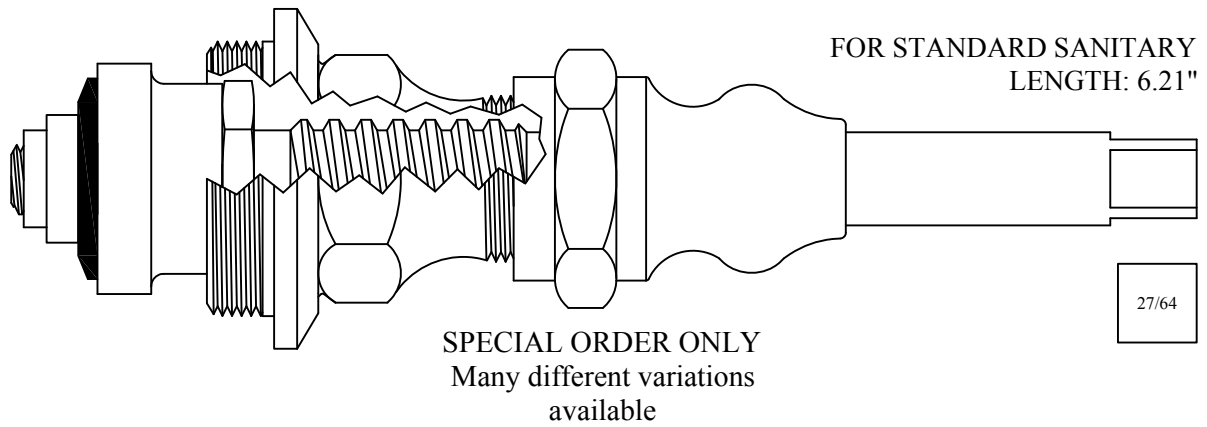
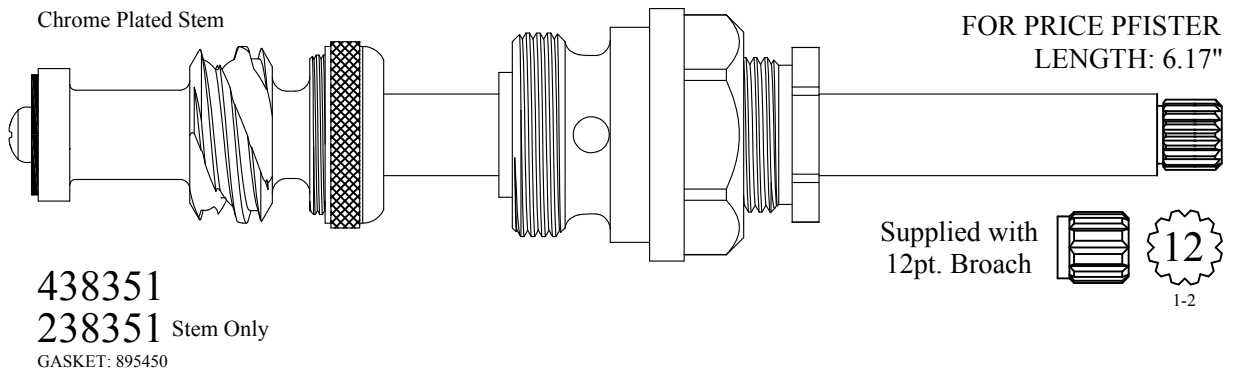

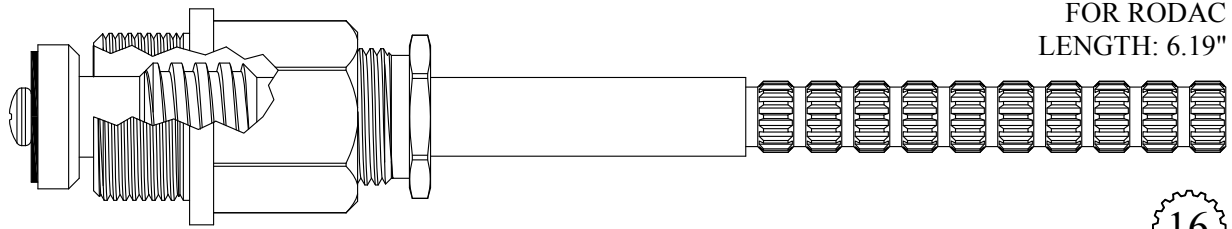

FOR RODAC  
LENGTH: 6.19"



3-16

421711/ 421712  
221711/ 221712 Stem Only



SEAT USED: 648970

GASKET: 895400

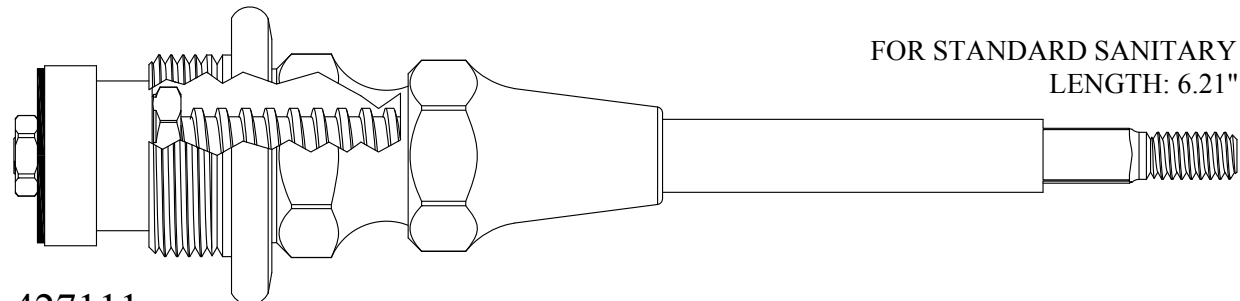

FOR STANDARD SANITARY  
LENGTH: 6.21"

427111  
GASKET: 895440

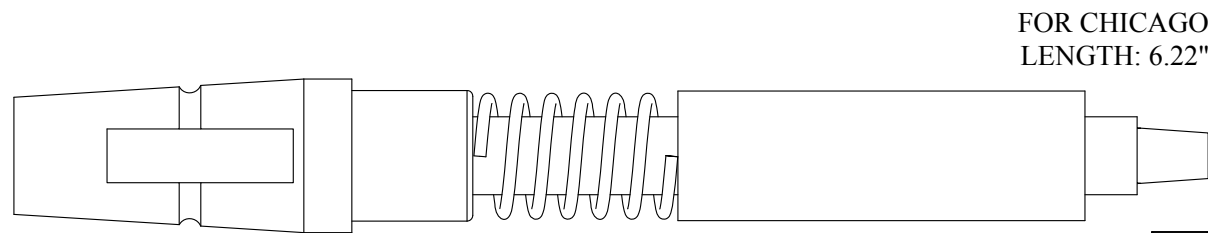

FOR CHICAGO  
LENGTH: 6.22"

238840



TAPERED

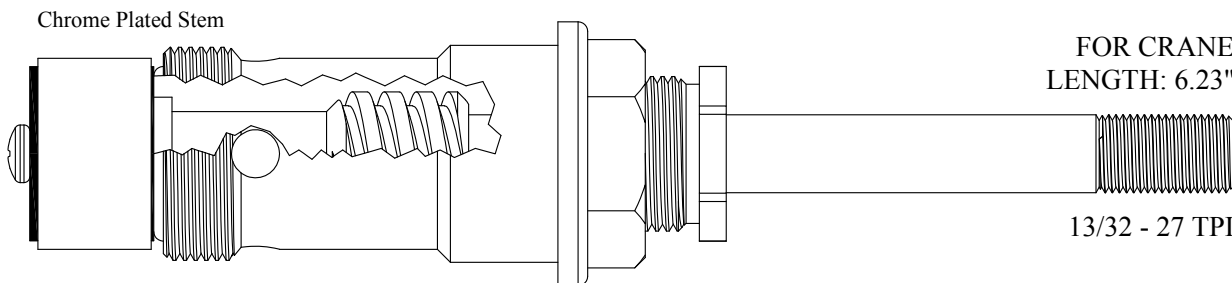

FOR CRANE  
LENGTH: 6.23"

13/32 - 27 TPI

438601  
238601 Stem Only

GASKET: 895450

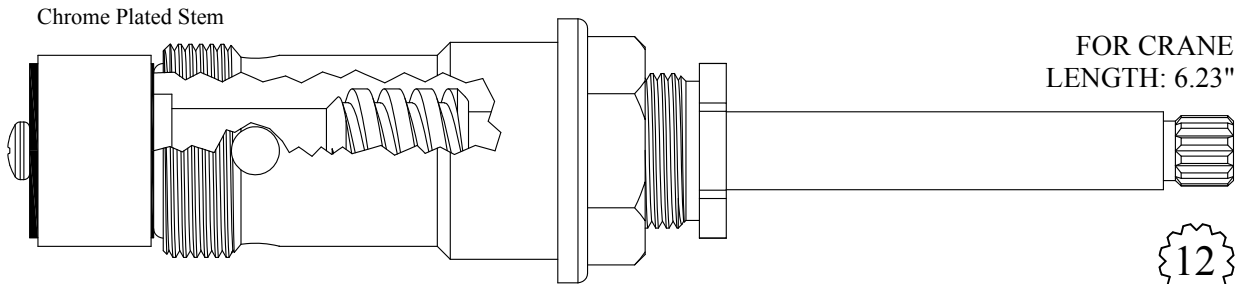

438651  
 238651 Stem Only  
 GASKET: 895450

12  
 1-2

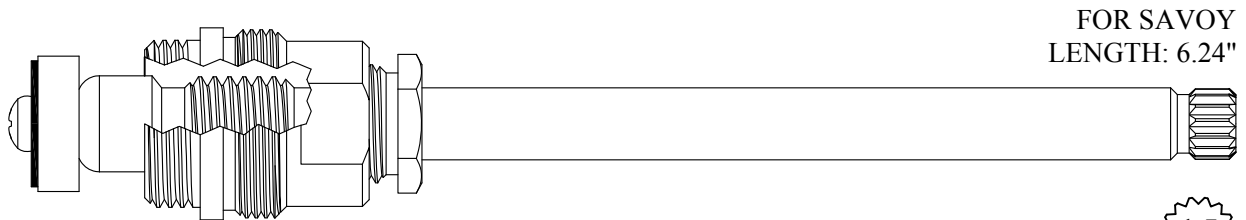

426741  
 226741 Stem Only  
 GASKET: 895400



15  
 1-13

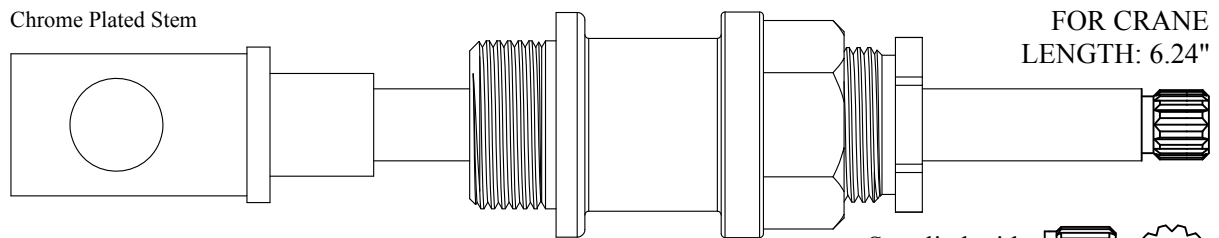

438550  
 238550 Stem Only  
 GASKET: 895400

Supplied with  
 12pt. Broach



12  
 1-2



438850  
 238850 Stem Only

Supplied with  
 12pt. Broach



12  
 1-2

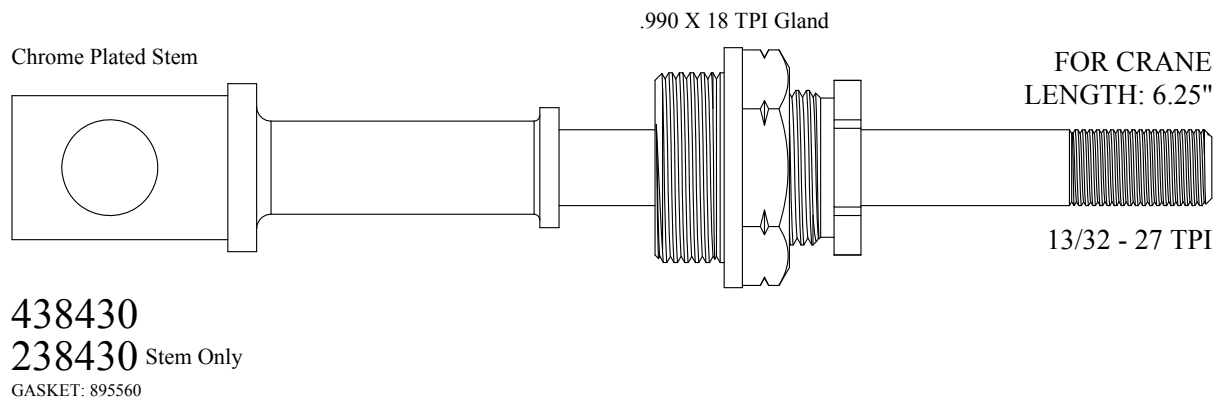
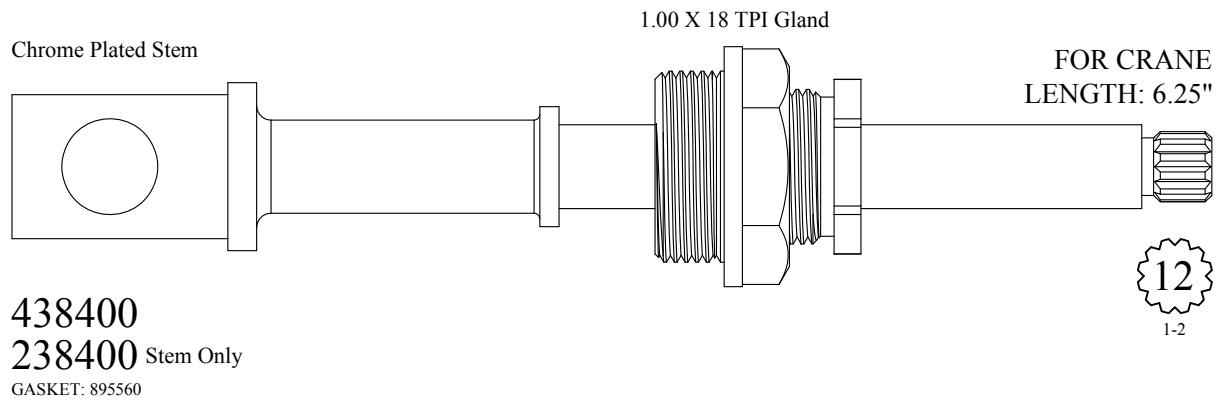
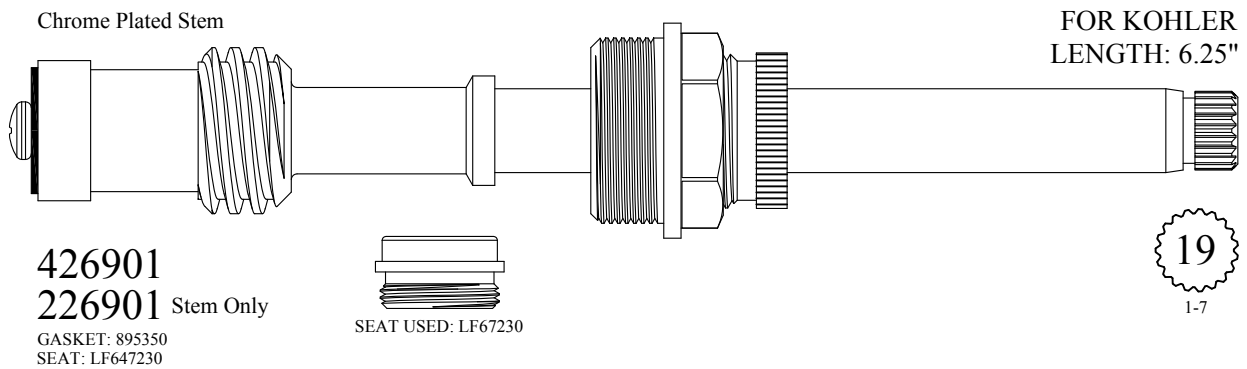
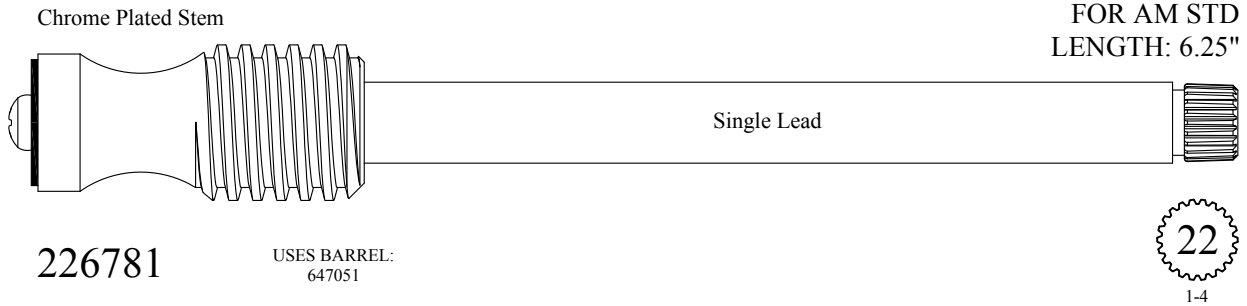

Chrome Plated Stem

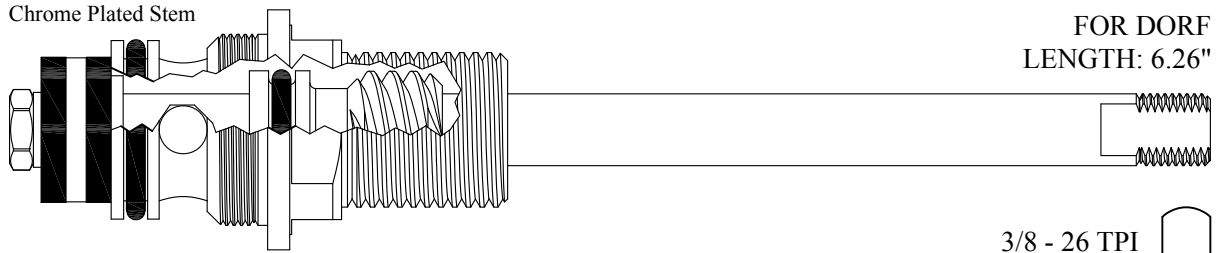

FOR DORF  
LENGTH: 6.26"

3/8 - 26 TPI



**438511**  
GASKET: 895550

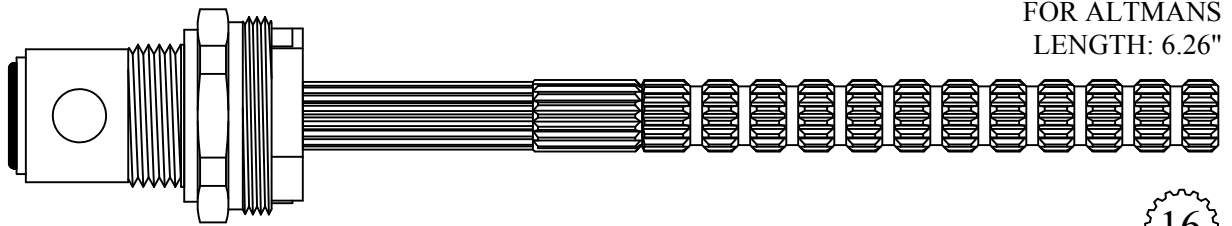

FOR ALTMANS  
LENGTH: 6.26"



**426731/ 426732**  
GASKET: 895100

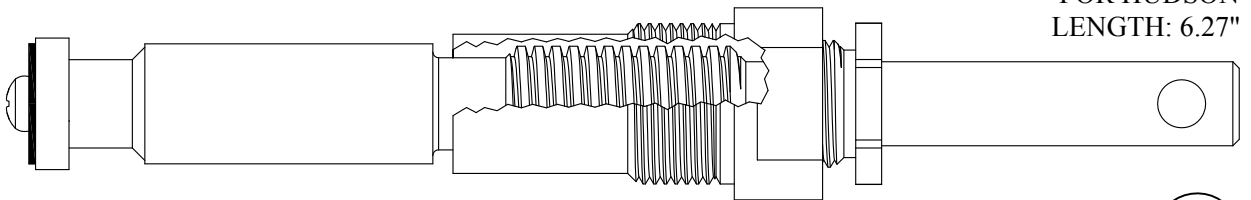

FOR HUDSON  
LENGTH: 6.27"



**427121**  
**227121** Stem Only  
GASKET: 895380

Chrome Plated Sleeve

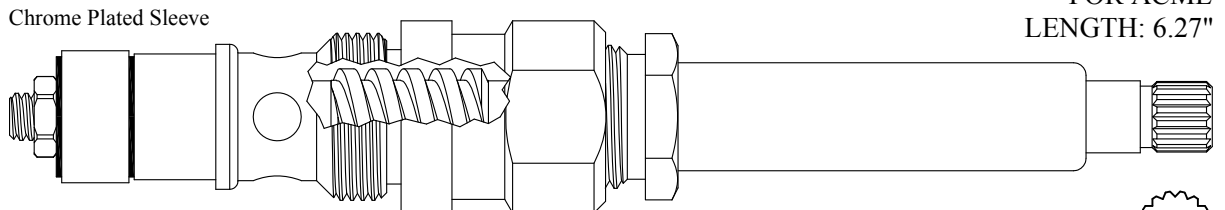

FOR ACME  
LENGTH: 6.27"



**438611**  
**238611** Stem Only  
GASKET: 895180

FOR ACME  
LENGTH: 6.27"

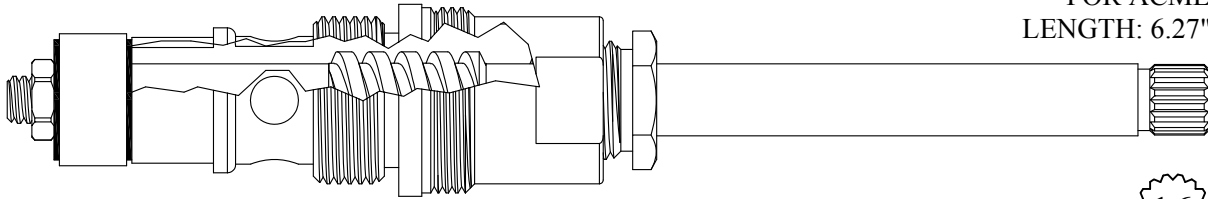

438621  
238611 Stem Only  
GASKET: 895180

16  
1-6

FOR AM BRASS  
LENGTH: 6.29"

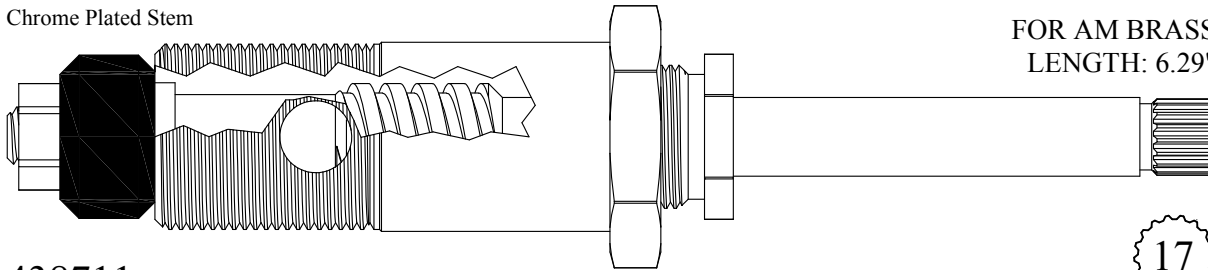

438711  
238711 Stem Only  
GASKET: 895550

17  
3-7

FOR KOHLER  
LENGTH: 6.29"

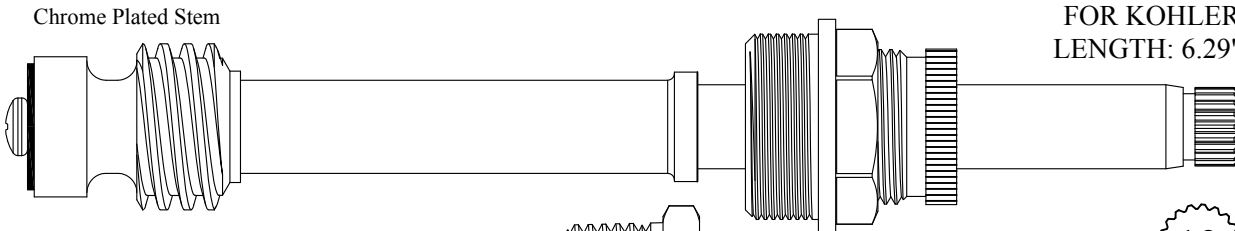

LF480501/ LF480502  
LF280501/ LF280502 Stem Only  
GASKET: 895350

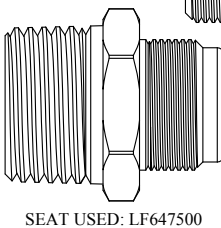

SEAT USED: LF647500

19  
1-7

FOR BROADWAY  
LENGTH: 6.33"

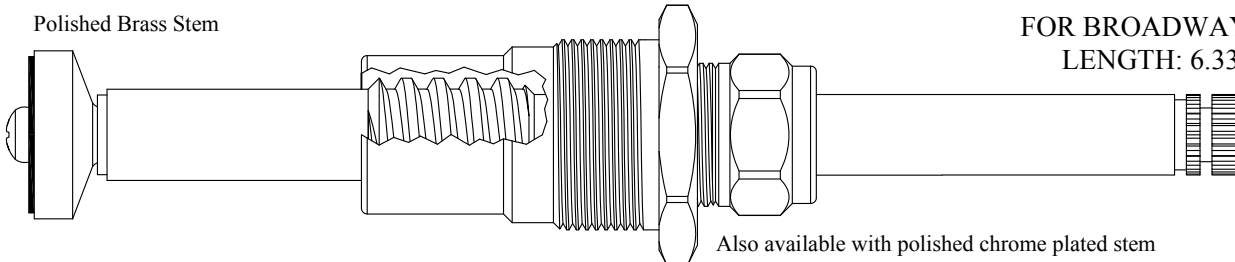

426931/ 426932  
226931/ 226932 Stem Only  
GASKET: 895570



SEAT USED: 648180

Also available with polished chrome plated stem  
426931-CP/ 426932-CP  
226931-CP/ 226932-CP Stem Only

20  
2-4

Polished Brass Stem

FOR BROADWAY  
LENGTH: 6.34"

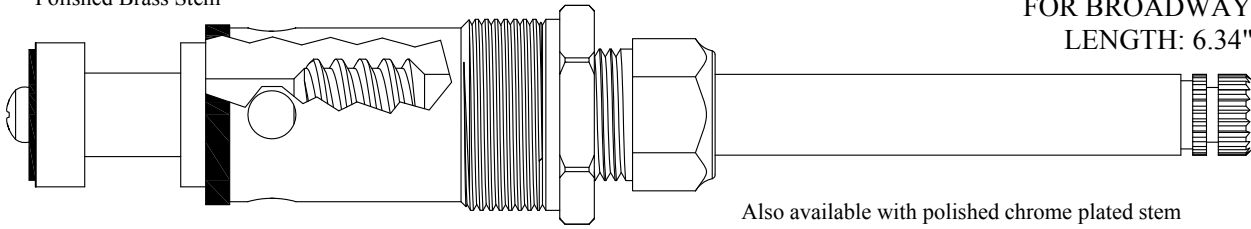

20  
2-4

438311  
238311 Stem Only

Also available with polished chrome plated stem

438311-CP  
238311-CP Stem Only

Also available less bonnet  
426521-B

Chrome Plated Stem

FOR KOHLER  
STEM LENGTH: 6.06"

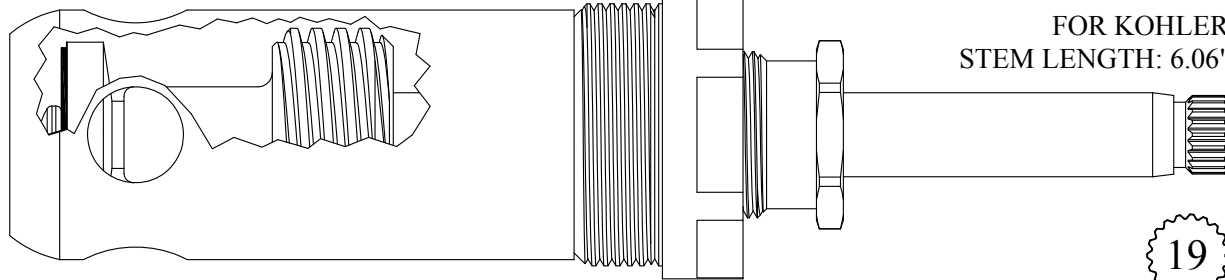

19  
1-7

426521  
226521 Stem Only

USES BARREL:  
647361

Chrome Plated Stem

FOR GLAUBER WEST COAST  
LENGTH: 6.38"

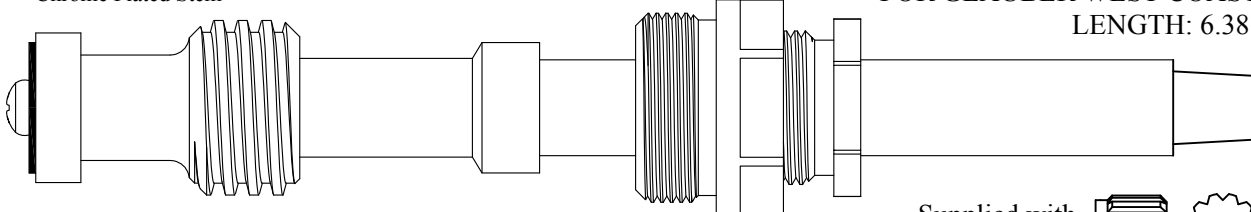

Supplied with  
12pt. Broach



12  
1-2

424351  
224351 Stem Only  
GASKET: 895550

FOR ARTISTIC BRASS  
LENGTH: 6.39"

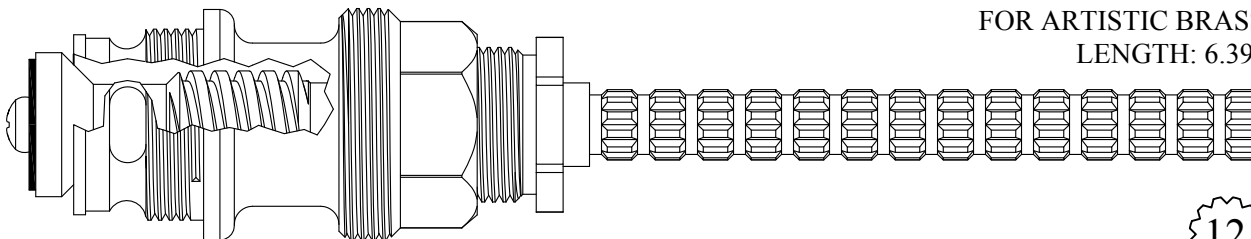

12  
1-2

438831  
238831 Stem Only  
GASKET: 895550



SEAT USED: 648370

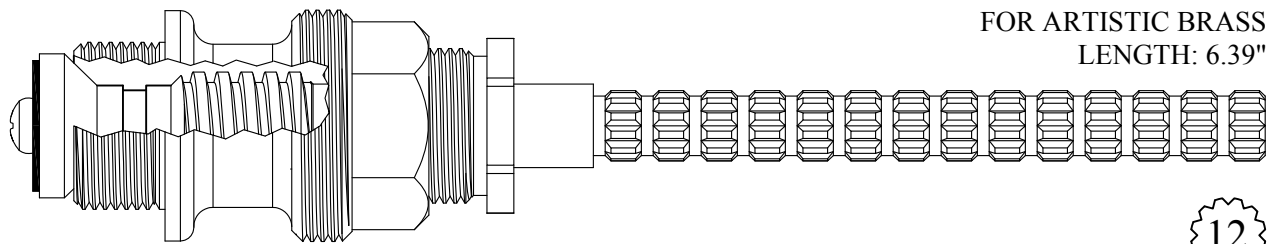

FOR ARTISTIC BRASS  
LENGTH: 6.39"

12  
1-2

426911/ 426912  
226911/ 226912 Stem Only  
GASKET: 895400



SEAT USED: 648370

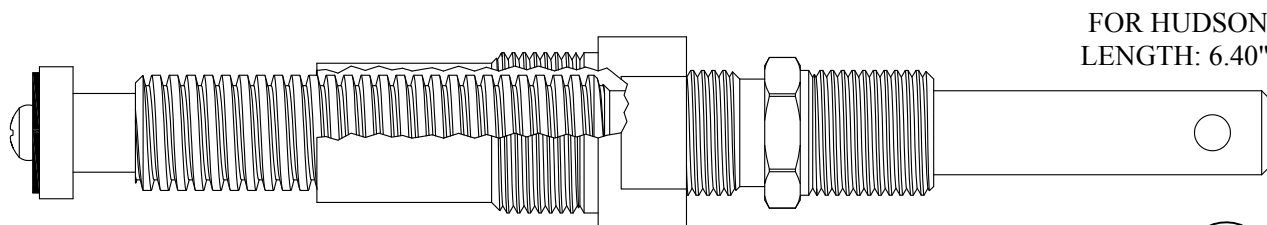

FOR HUDSON  
LENGTH: 6.40"

427131  
227131 Stem Only  
GASKET: 895380

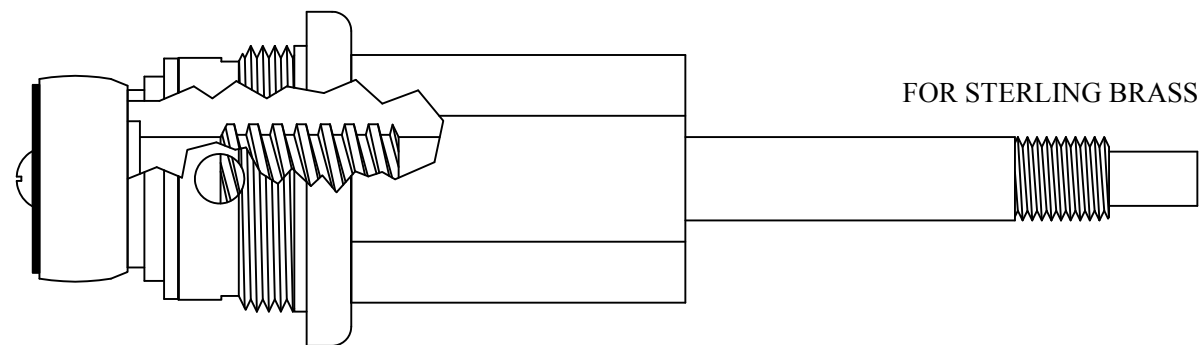

FOR STERLING BRASS

Not Available, Use 438101

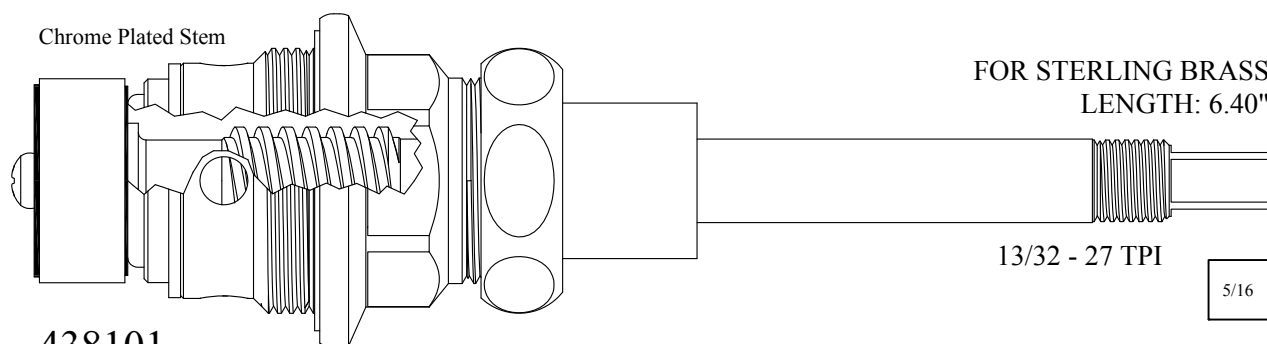

Chrome Plated Stem

FOR STERLING BRASS  
LENGTH: 6.40"

13/32 - 27 TPI

5/16

438101  
238101 Stem Only  
GASKET: 895500



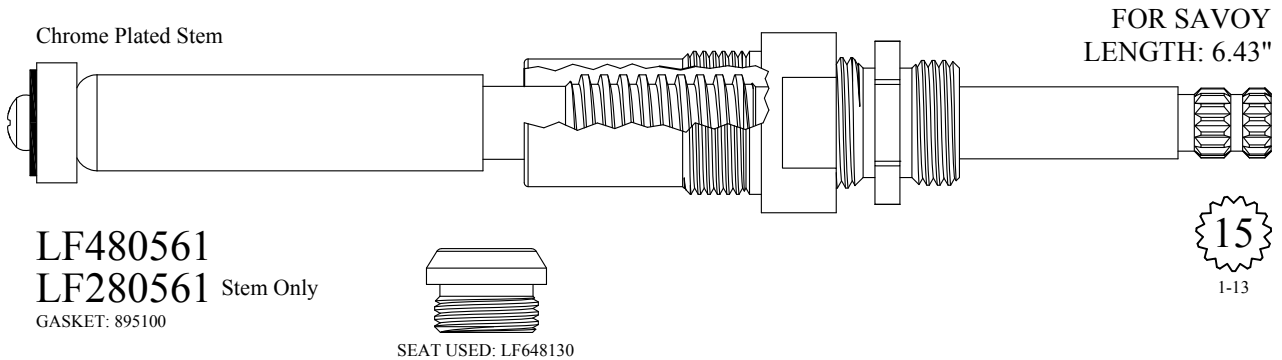
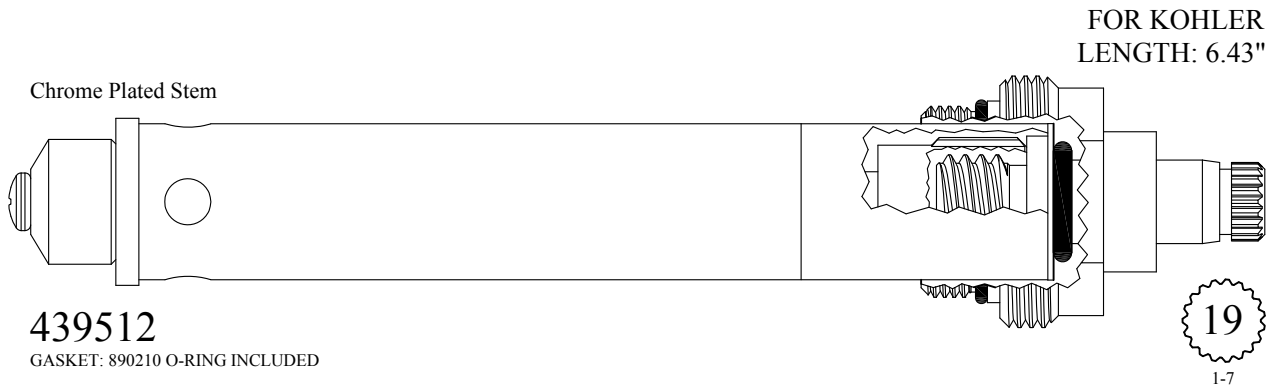
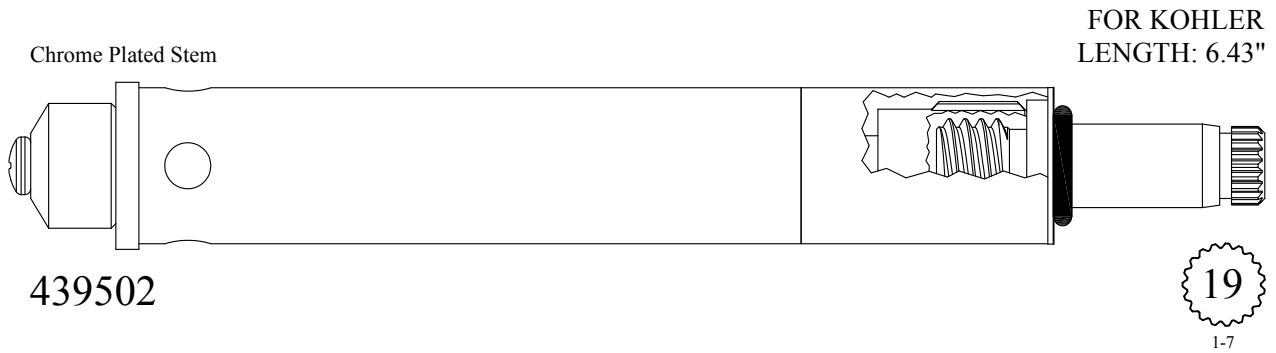
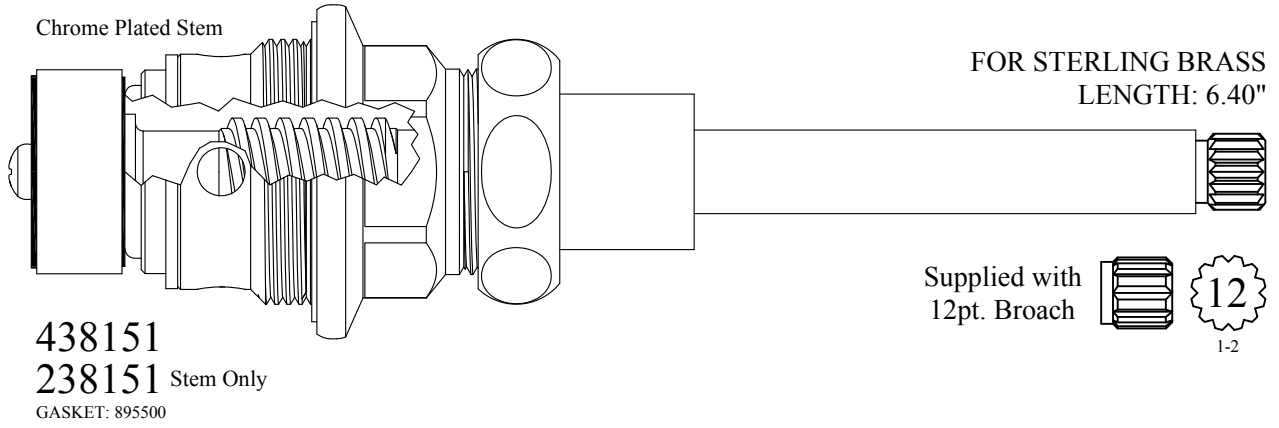

Chrome Plated Stem

FOR ROYAL BRASS  
LENGTH: 6.44"

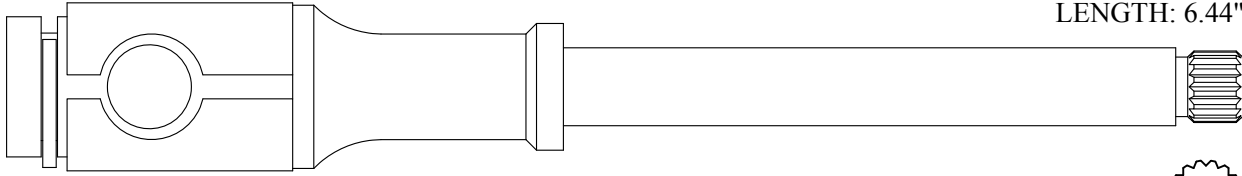

239420

16  
1-6

Chrome Plated Stem

FOR AM STD  
LENGTH: 6.44"

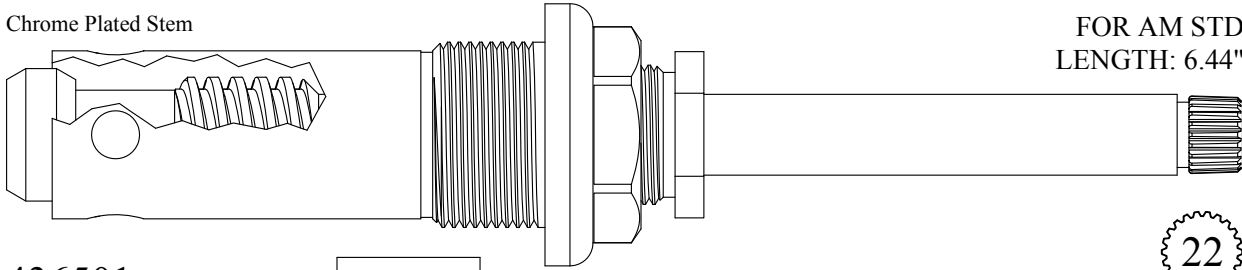

436501  
236501 Stem Only  
GASKET: 818000

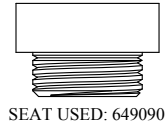

SEAT USED: 649090

22  
1-4

Chrome Plated Stem & Esc Tube

FOR SAVOY  
LENGTH: 6.44"

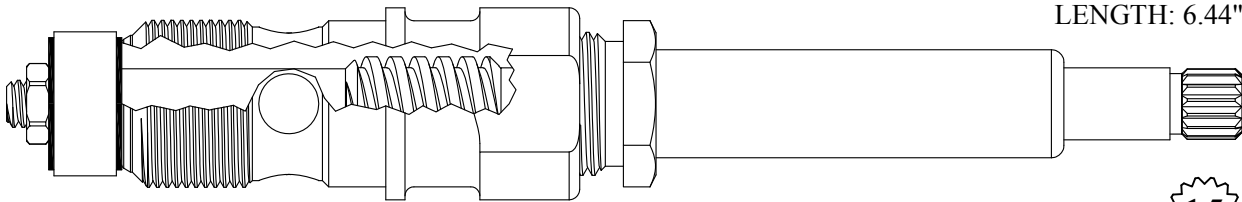

7/8-20 Thread

438901  
238901 Stem Only  
GASKET: 895400

15  
1-13

Chrome Plated Stem

FOR ROYAL BRASS  
LENGTH: 6.44"

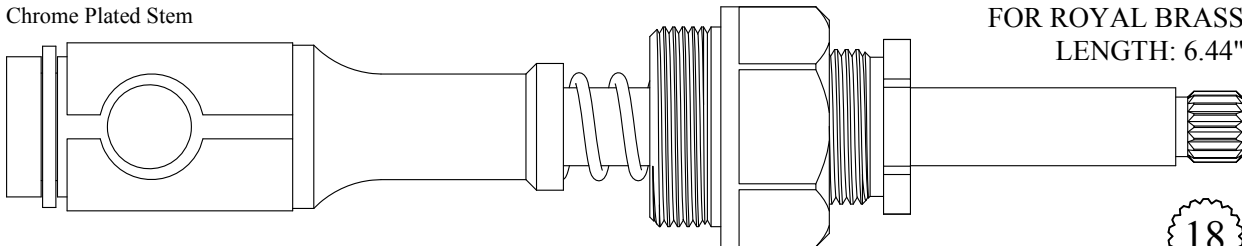

439400  
239400 Stem Only  
GASKET: 895560

18  
3-3

Chrome Plated Stem

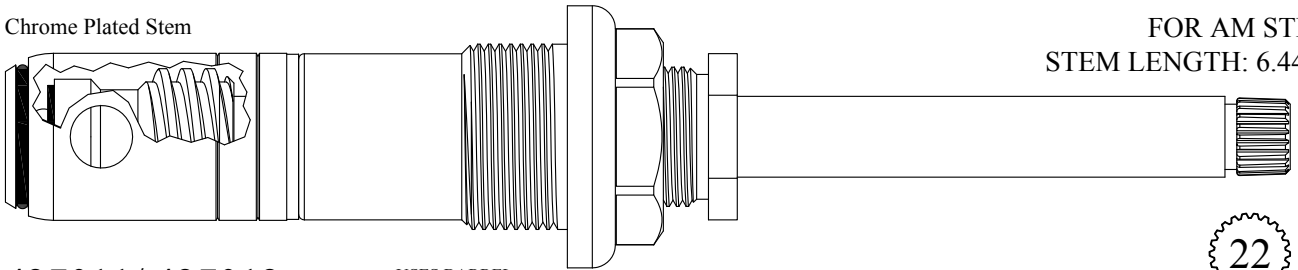

FOR AM STD  
STEM LENGTH: 6.44"

427011/ 427012  
227011/ 227012 Stem Only  
GASKET: 818000

USES BARREL:  
LF647021/LF647022

22  
1-4

Chrome Plated Stem

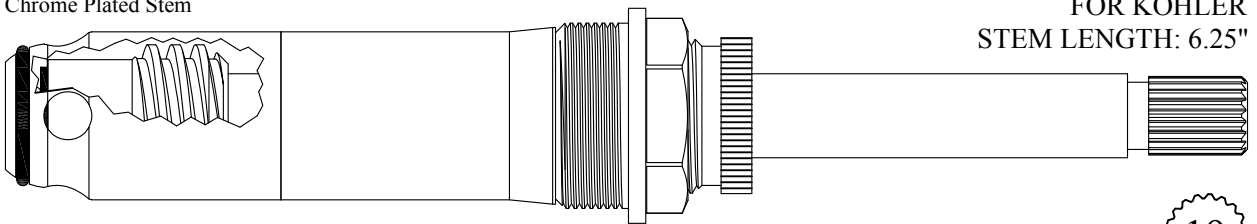

FOR KOHLER  
STEM LENGTH: 6.25"

426701  
226701 Stem Only  
GASKET: 895350

USES BARREL:  
647321

19  
1-7

Chrome Plated Stem

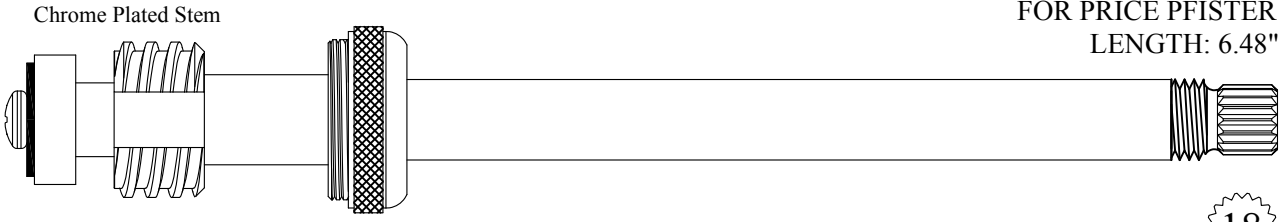

FOR PRICE PFISTER  
LENGTH: 6.48"

239152

18  
Old Style  
Price Pfister

Chrome Plated Stem

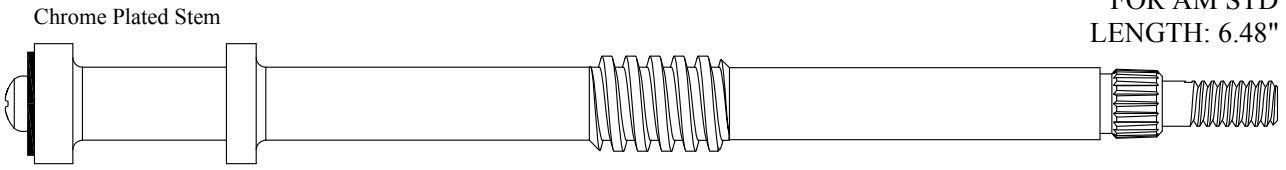

FOR AM STD  
LENGTH: 6.48"

LF280511

20  
3-14

FOR ALTMANS  
LENGTH: 6.49"

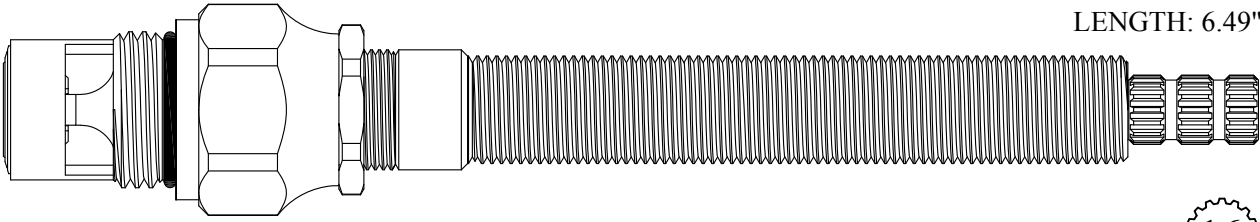

426841/ 426842 (459201 / 459202 w/ Ceramic Adapter Parts)

GASKET: 890170 O-RING INCLUDED  
SEAL: 898510-W  
DISC SET: 151380-PKG

16  
3-16

UNKNOWN  
LENGTH: 6.50"

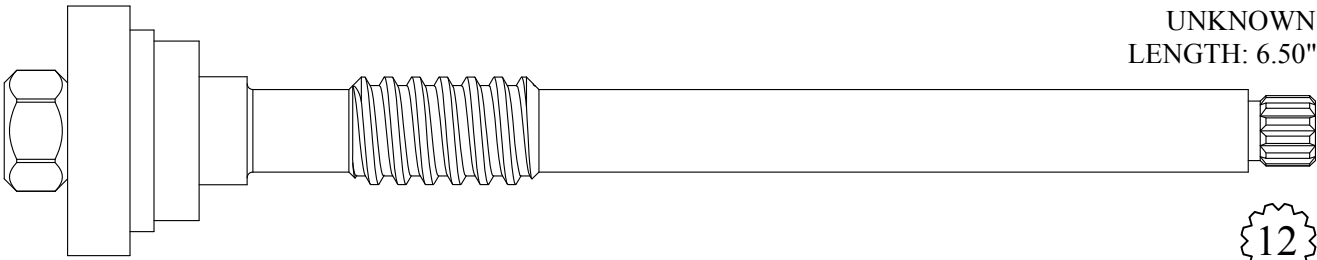

227461

12  
1-2

Chrome Plated Stem

FOR BRIGGS  
LENGTH: 6.50"

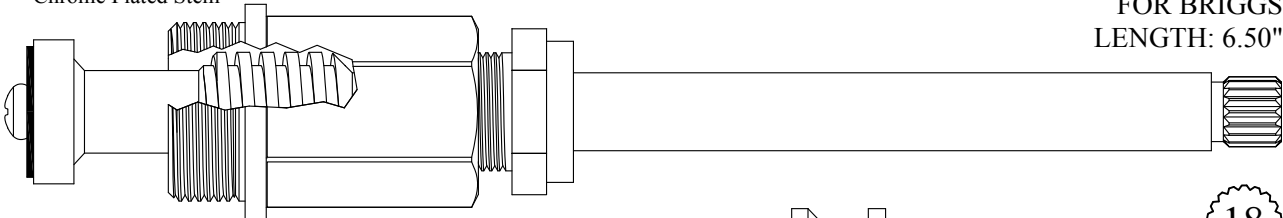

427141  
227141 Stem Only  
GASKET: 895370

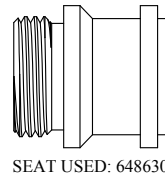

SEAT USED: 648630

18  
3-3

Chrome Plated Stem

FOR LOGAN  
LENGTH: 6.50"

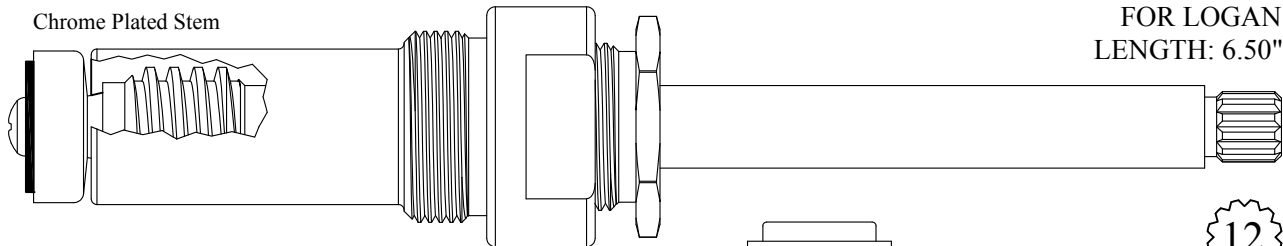

427201  
227201 Stem Only  
GASKET: 895570

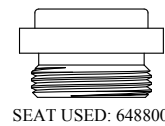

SEAT USED: 648800

12  
1-2

Chrome Plated Stem

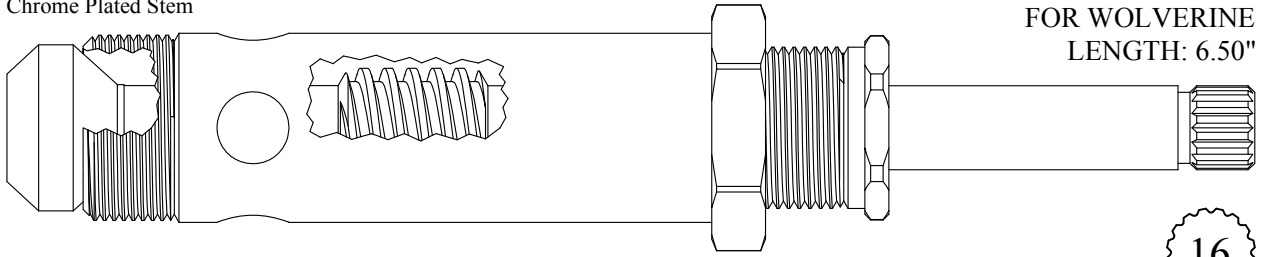

FOR WOLVERINE  
LENGTH: 6.50"

439171  
239171 Stem Only  
GASKET: 895550

16  
3-26

Chrome Plated Stem

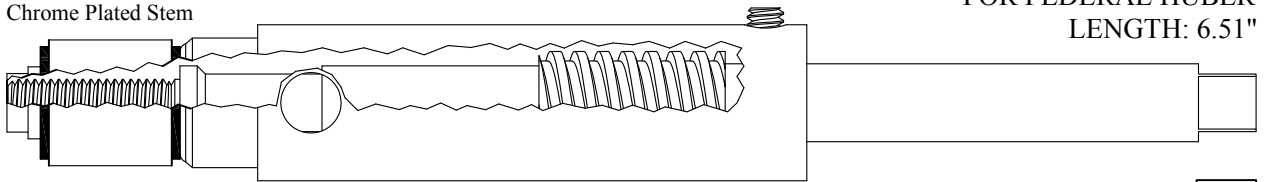

FOR FEDERAL HUBER  
LENGTH: 6.51"

439001

5/16

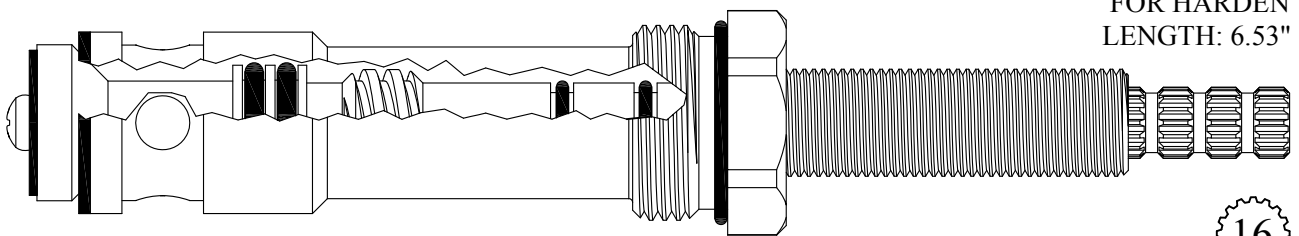

FOR HARDEN  
LENGTH: 6.53"

439141  
GASKET: 891180 O-RING INCLUDED

16  
3-16

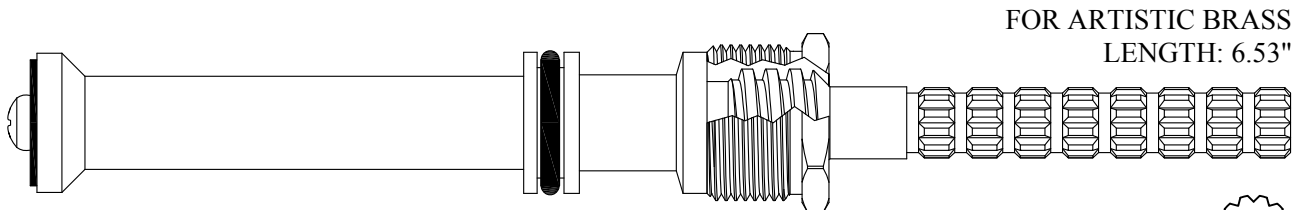

FOR ARTISTIC BRASS  
LENGTH: 6.53"

426941/ 426942

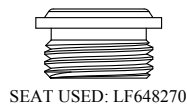

12  
1-2

Chrome Plated Stem

FOR HAJOCA  
LENGTH: 6.55"

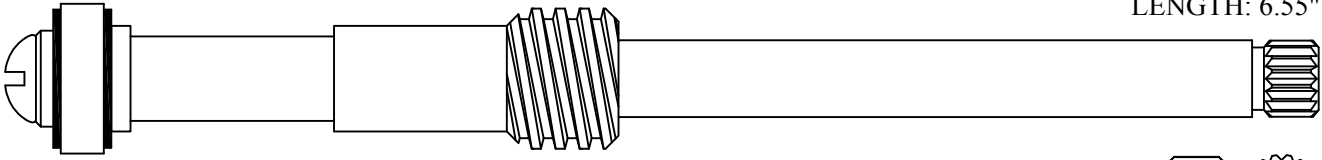

239601

Supplied with  
12pt. Broach

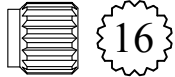

16  
1-6

Also available less barrel  
426821

Chrome Plated Stem

FOR KOHLER  
STEM LENGTH: 6.24"

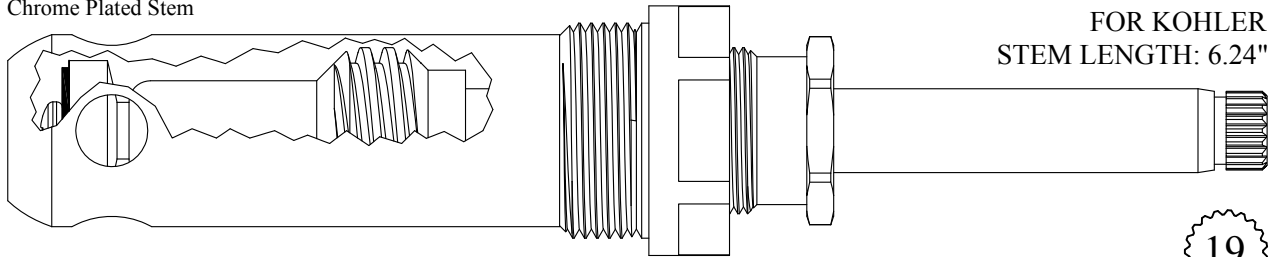

426801

226801 Stem Only

GASKET: 895450

USES BARREL:  
647331

19  
1-7

FOR SPEAKMAN  
LENGTH: 6.57"

Chrome Plated Stem

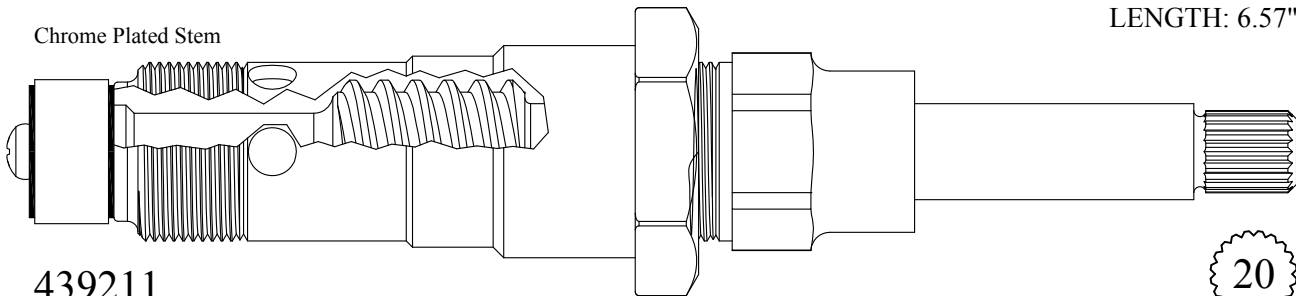

439211

239211 Stem Only

GASKET: 895450

20  
2-4

Chrome Plated Stem

FOR ROYAL BRASS  
LENGTH: 6.57"

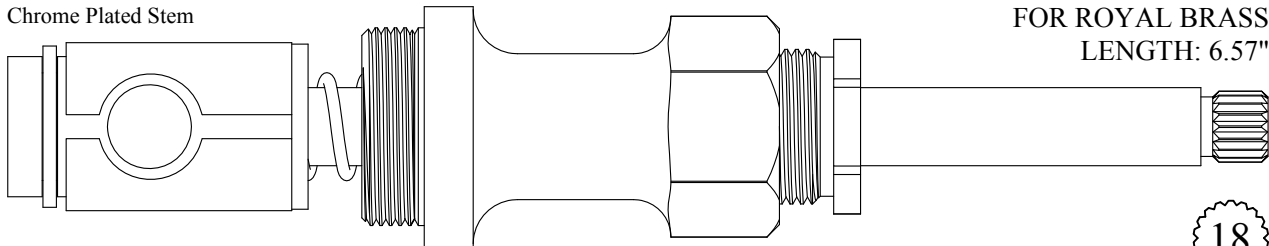

439630

239630 Stem Only

GASKET: 895560

18  
3-3

FOR PHYLRICH  
LENGTH: 6.58"

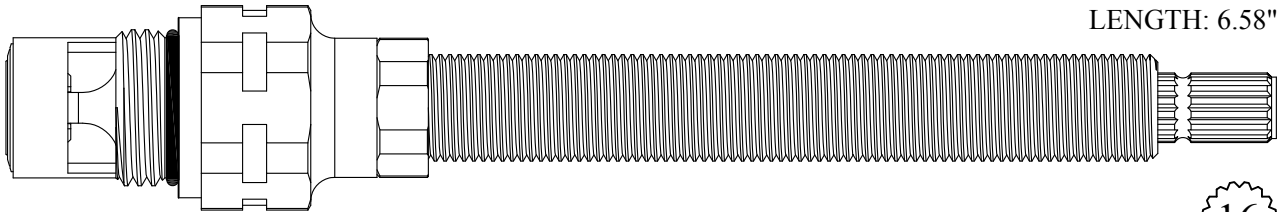

427281/ 427282

GASKET: 890170 O-RING INCLUDED  
SEAL: 898510-W  
DISC SET: 151380-PKG

Individual items available  
Stem Ext. 5.00": #136050  
Ext. Adap. Screw: #103310

16  
1-6

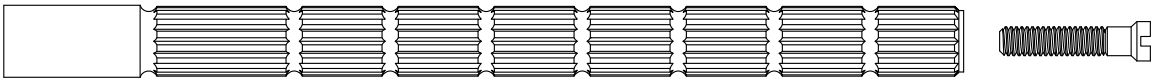

Plastic Body

FOR PRECISION  
LENGTH: 6.59"

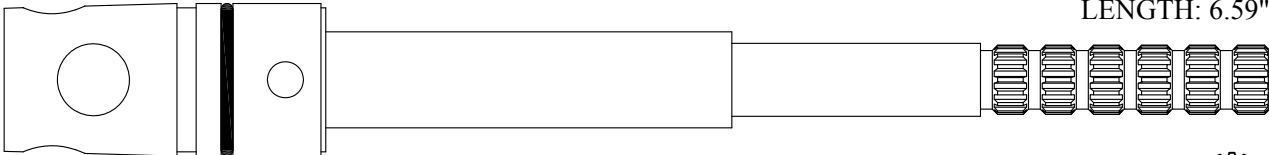

239160

16  
3-16

FOR HARDEN  
LENGTH: 6.60"

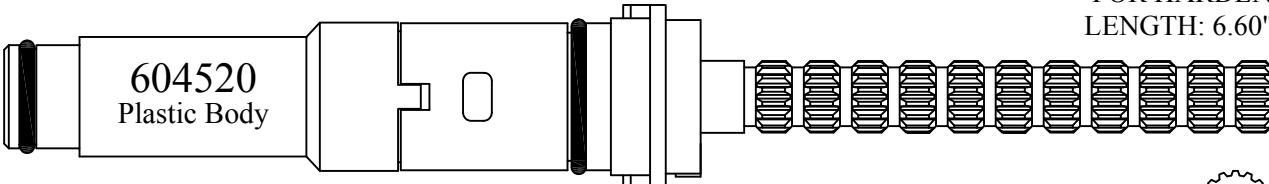

403941/ 403942

604520  
Plastic Body

Available: Stem Only  
203941  
203942

16  
3-16

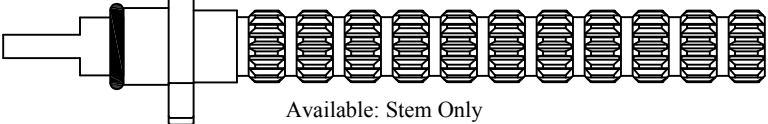

Chrome Plated Unit

FOR CRANE  
LENGTH: 6.60"

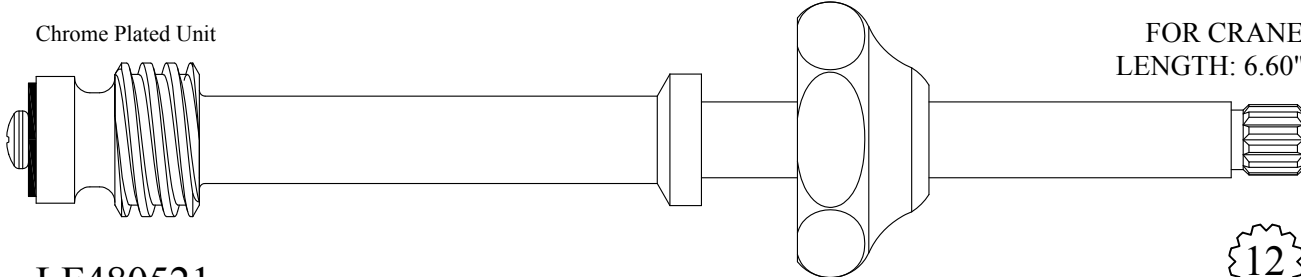

LF480521  
LF280521 Stem Only

12  
1-2

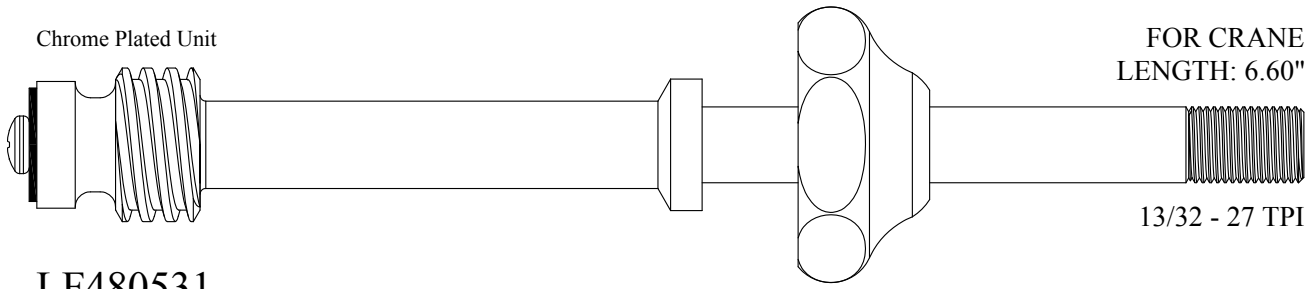

Chrome Plated Unit

FOR CRANE  
LENGTH: 6.60"

13/32 - 27 TPI

LF480531  
LF280531 Stem Only

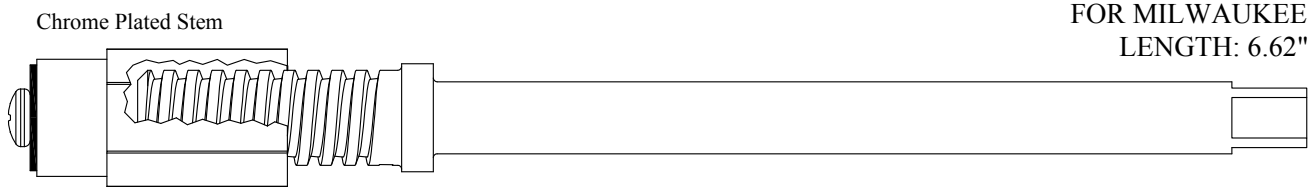

Chrome Plated Stem

FOR MILWAUKEE  
LENGTH: 6.62"

426312  
226312 Stem Only

5/16

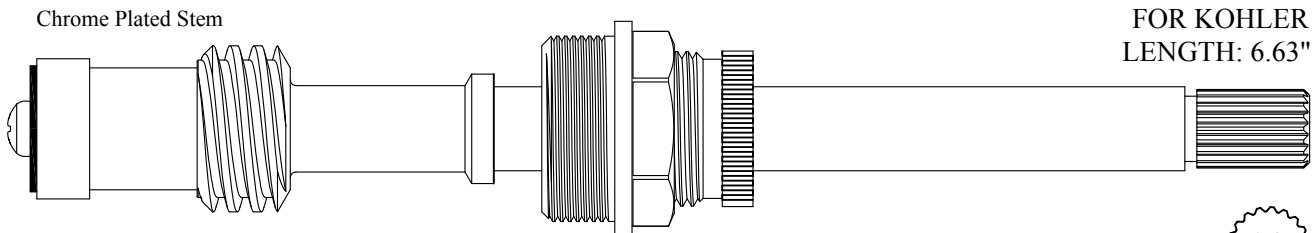

Chrome Plated Stem

FOR KOHLER  
LENGTH: 6.63"

426921  
226921 Stem Only  
GASKET: 895350

SEAT USED: LF647230

19  
1-7

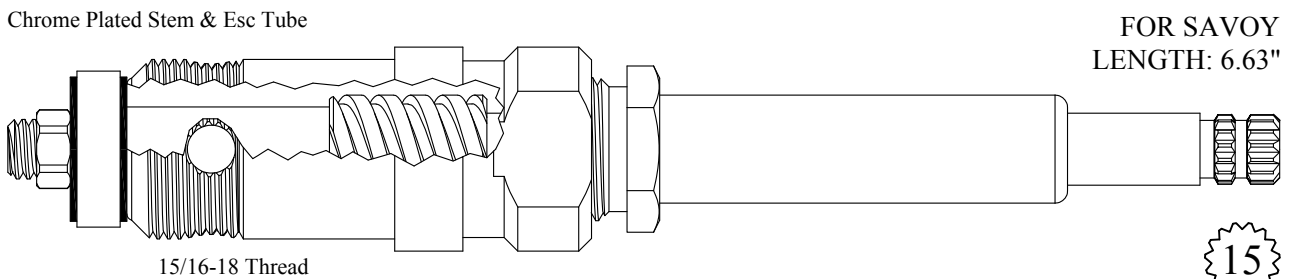

Chrome Plated Stem & Esc Tube

FOR SAVOY  
LENGTH: 6.63"

15/16-18 Thread

439121  
239121 Stem Only  
GASKET: 895320

15  
1-13



Chrome Plated Stem & Esc Tube

FOR SAVOY  
LENGTH: 6.63"

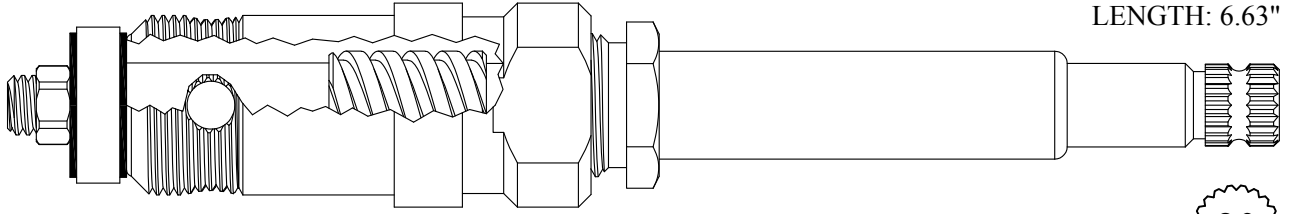

439131  
239131 Stem Only  
GASKET: 895320

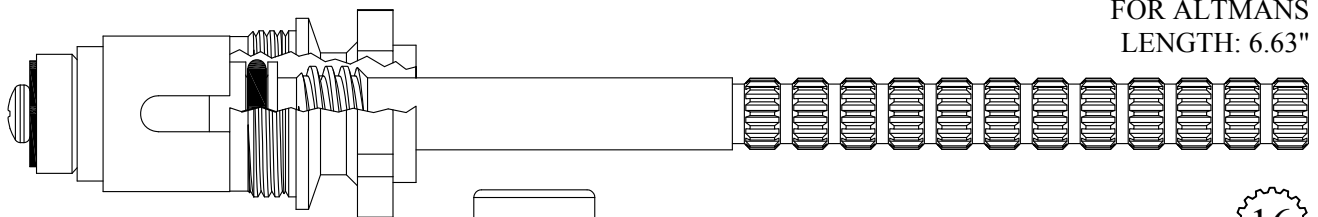

FOR ALTMANS  
LENGTH: 6.63"

439181  
GASKET: 895180

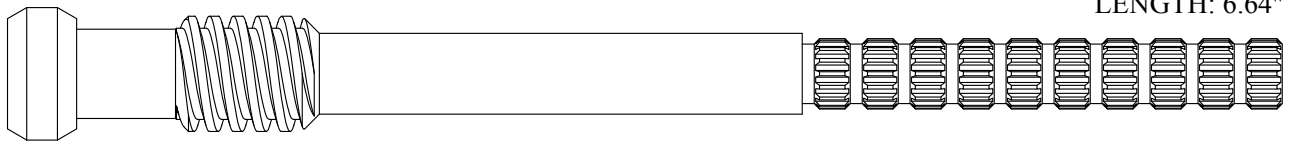

FOR AM STD  
LENGTH: 6.64"

235741

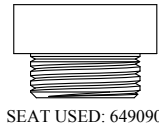

Chrome Plated Gland

FOR KOHLER  
LENGTH: 6.67"

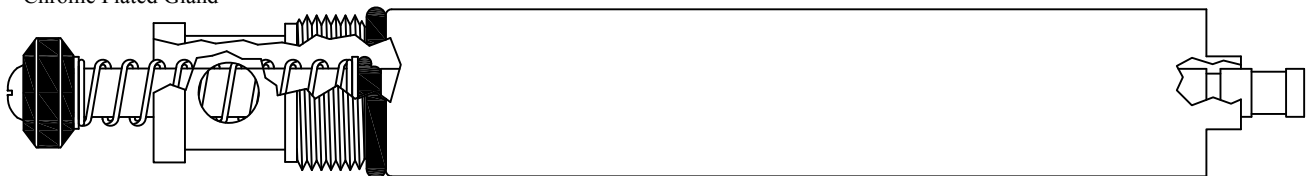

434600  
GASKET: 891150 O-RING INCLUDED

Chrome Plated Stem

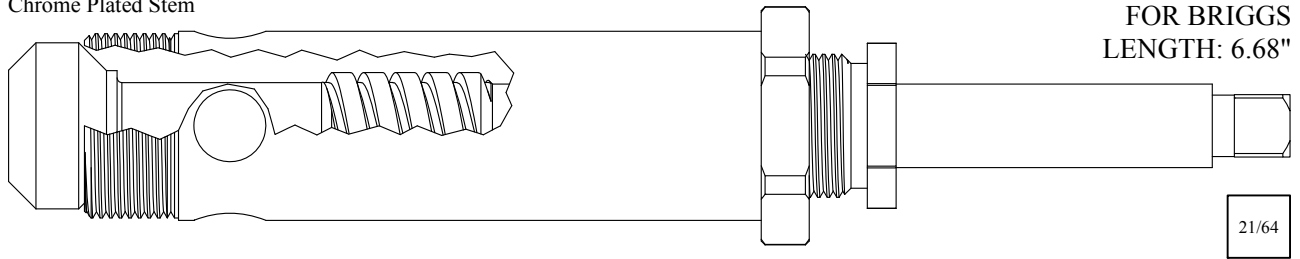

FOR BRIGGS  
LENGTH: 6.68"

21/64

439201

239201 Stem Only

GASKET: 895340

Chrome Plated Stem

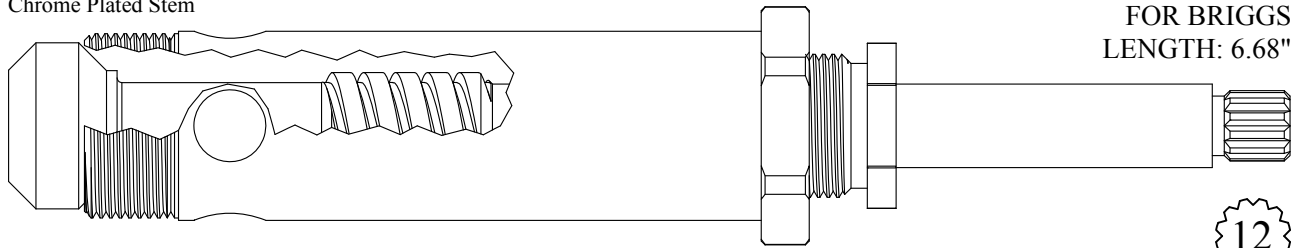

FOR BRIGGS  
LENGTH: 6.68"

12  
1-2

439251

239251 Stem Only

GASKET: 895340

Chrome Plated Stem

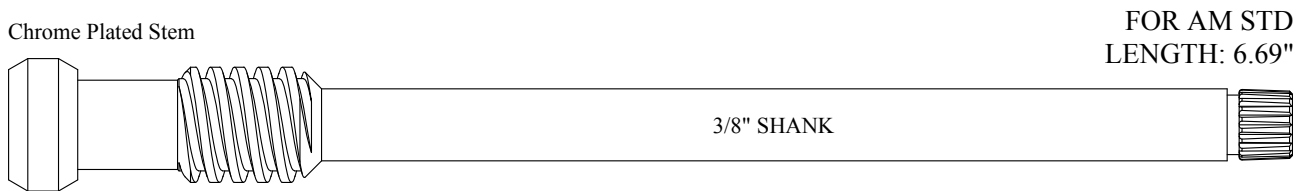

FOR AM STD  
LENGTH: 6.69"

3/8" SHANK

20  
3-14

239231

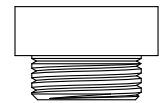

SEAT USED: 649090

Nickel Plated Gland

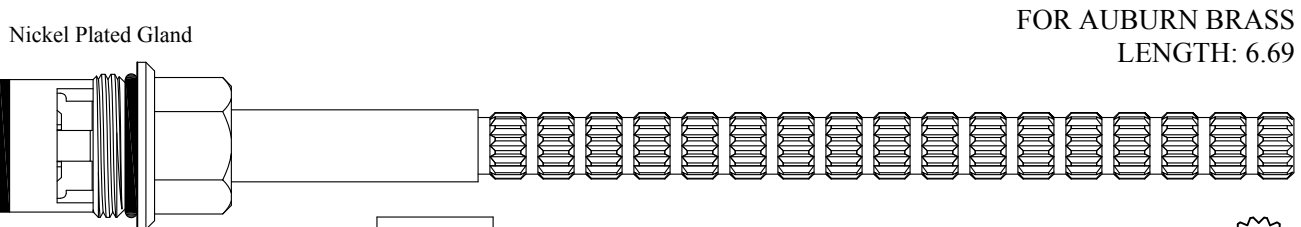

FOR AUBURN BRASS  
LENGTH: 6.69"

16  
2-3

427601/ 427602

GASKET: 890160 O-RING INCLUDED  
DISC SET: 151380-PKG

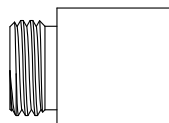

SEAT USED: 649350

FOR ARTISTIC BRASS  
LENGTH: 6.72

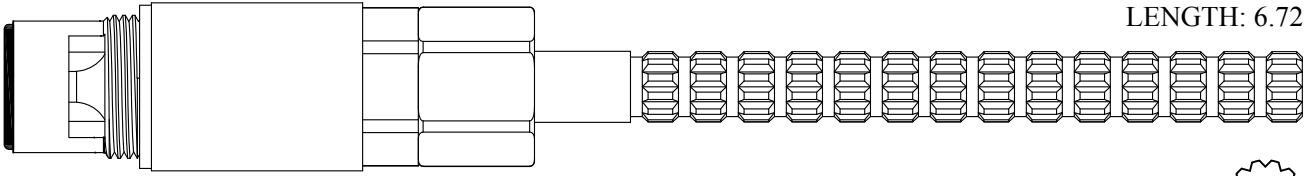

427301/ 427302

GASKET: 895100 INCLUDED  
SEAL: 898540  
DISC SET: 112530-PKG

Also available with  
16pt Harden Broach  
427331 / 427332



FOR CONCINNY  
LENGTH: 6.72"

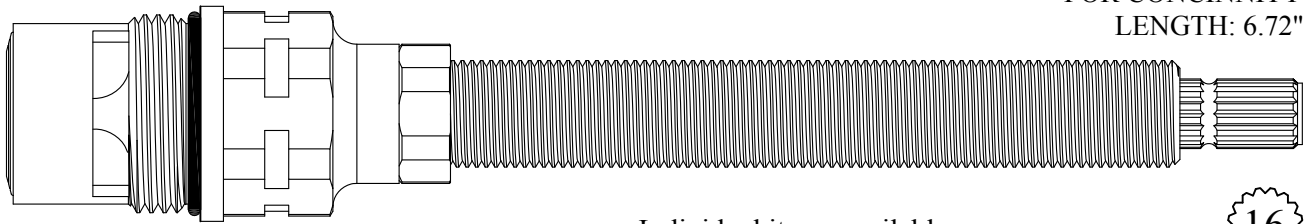

428031/ 428032

GASKET: 890210 O-RING INCLUDED  
SEAL: 898520  
DISC SET: 109850-PKG

Individual items available  
Stem Ext. 5.00": #136050  
Ext. Adap. Screw: #103310

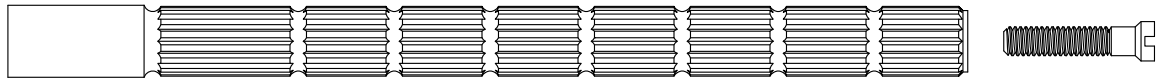

Chrome Plated Stem

FOR CRANE  
LENGTH: 6.74"

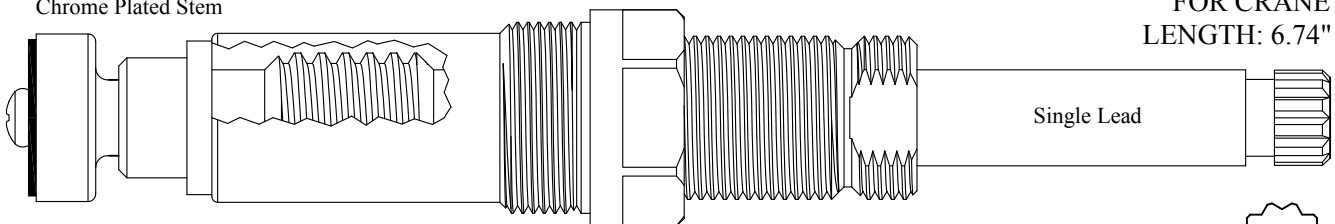

427001

227001 Stem Only

GASKET: 895340

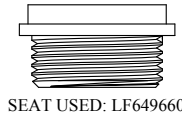

SEAT USED: LF649660



Chrome Plated Stem

FOR CRANE  
LENGTH: 6.74"

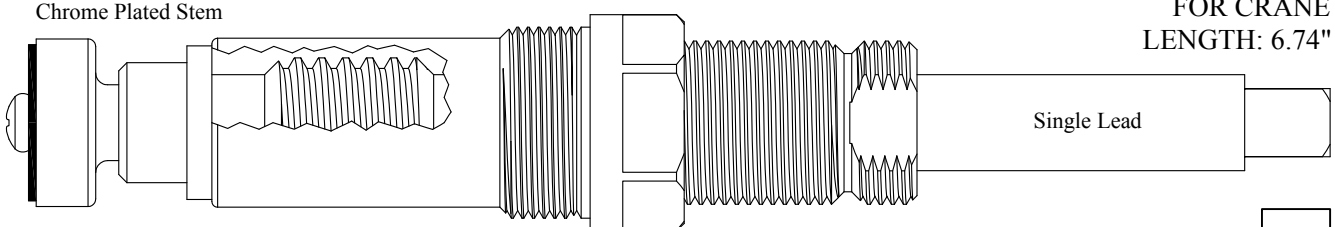

427031

227031 Stem Only

GASKET: 895340



SEAT USED: LF649660



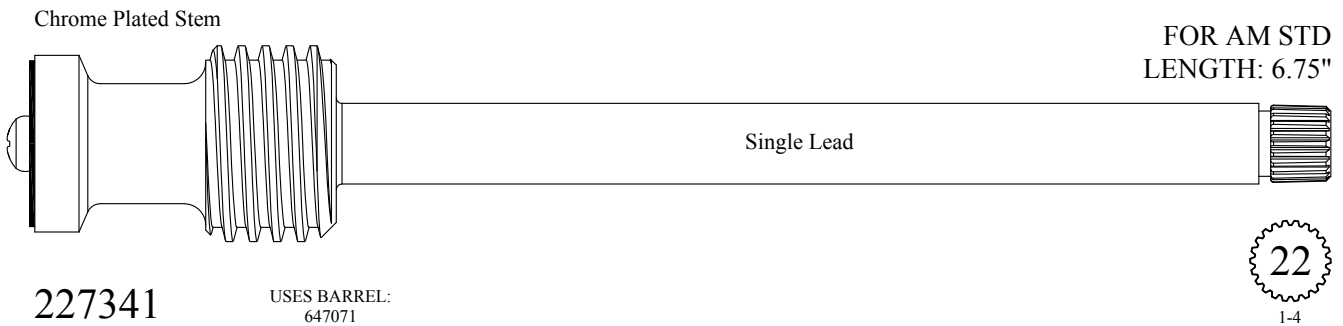
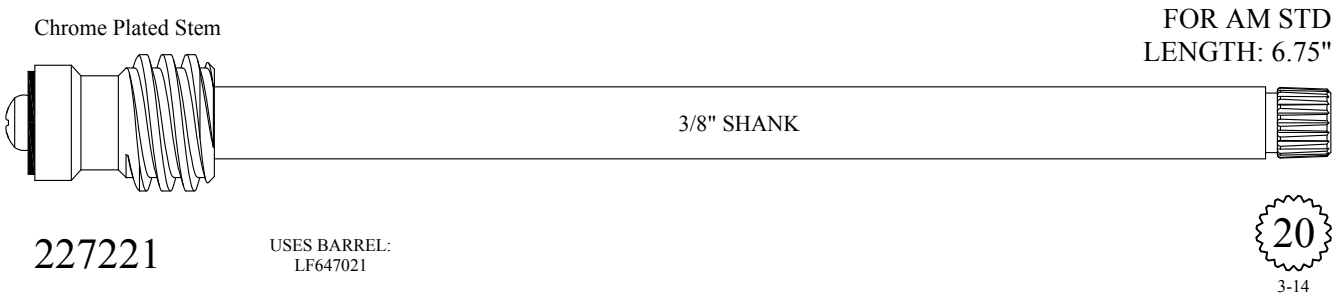
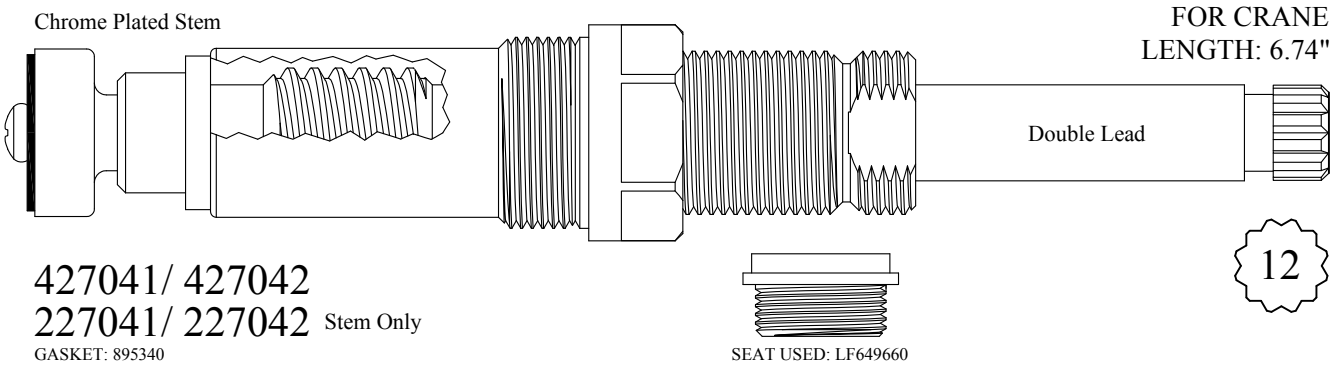
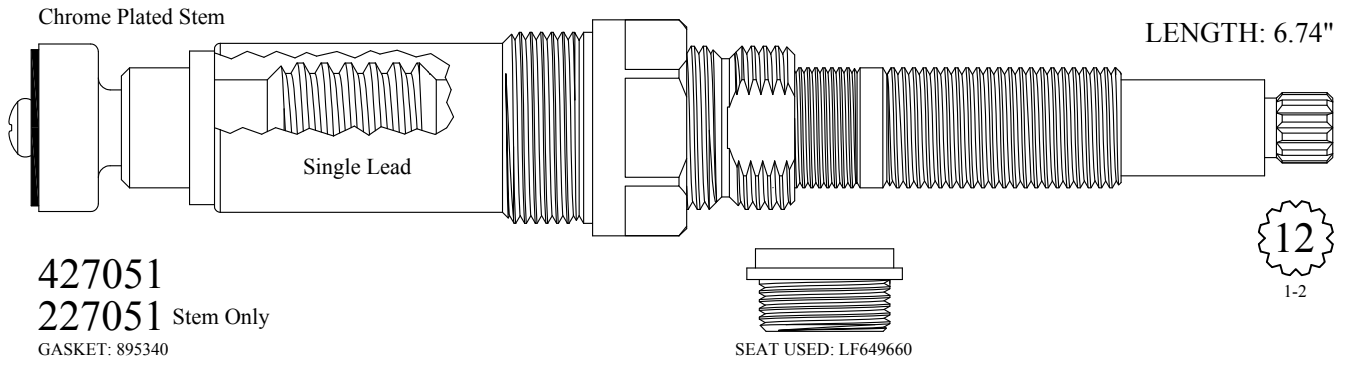

Chrome Plated Stem

FOR AM STD  
STEM LENGTH: 6.75"

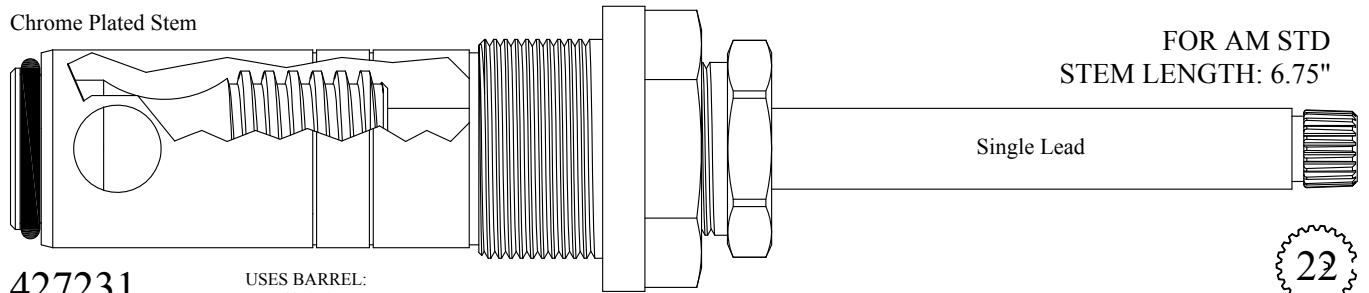

427231  
227231 Stem Only  
GASKET: 824600

USES BARREL:  
647051

22  
1-4

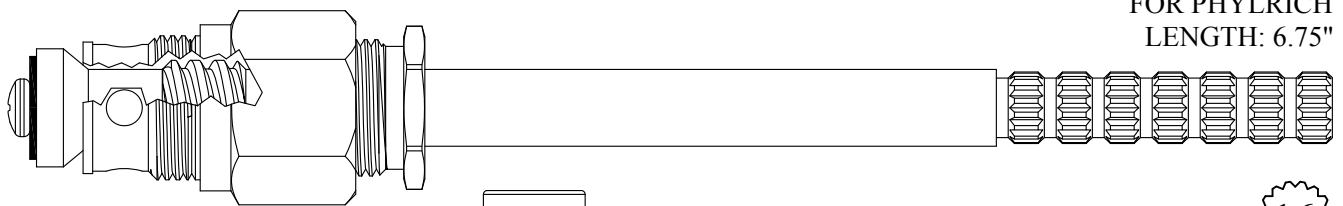

FOR PHYLRICH  
LENGTH: 6.75"

439621  
GASKET: 895100



SEAT USED: LF648550

16  
1-6

Chrome Plated Stem

FOR AM STD  
LENGTH: 6.75"

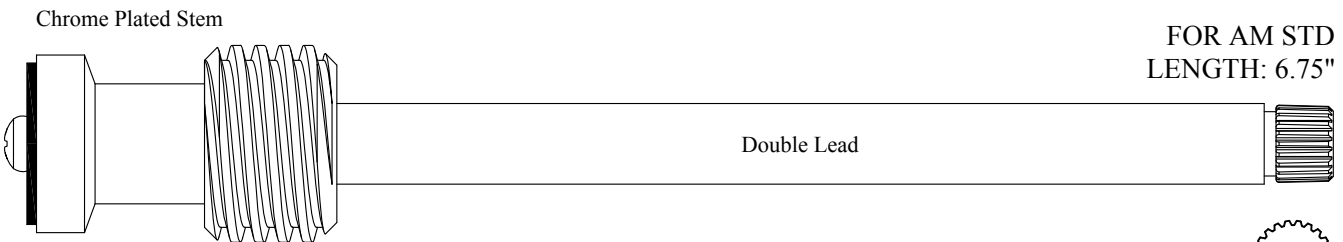

227351/ 227352

USES BARREL:  
647081/647082

22  
1-4

Chrome Plated Stem

FOR AM STD  
LENGTH: 6.75"

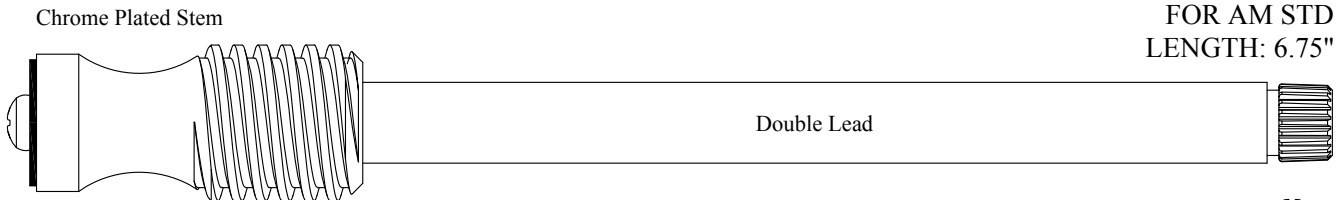

227361/ 227362

USES BARREL:  
647061/647062

22  
1-4

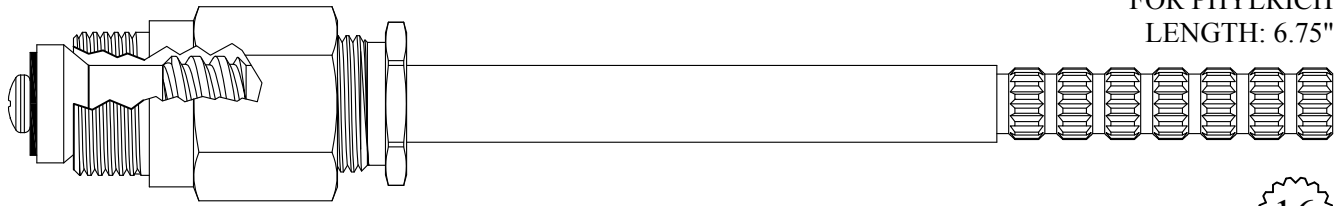

FOR PHYLRICH  
LENGTH: 6.75"

427241/ 427242

GASKET: 895100

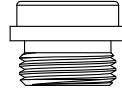

SEAT USED: LF648550

16  
1-6

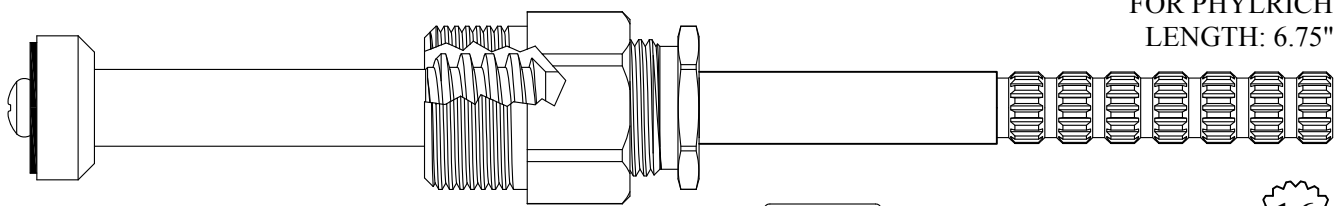

FOR PHYLRICH  
LENGTH: 6.75"

427321/ 427322

GASKET: 895400



SEAT USED: 648970

16  
1-6

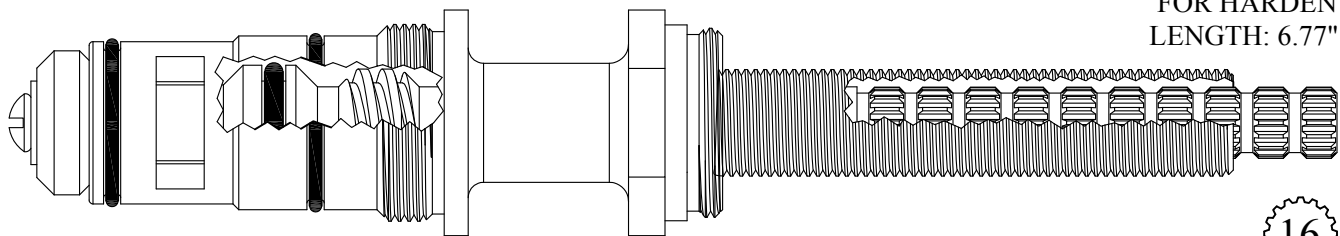

FOR HARDEN  
LENGTH: 6.77"

439241

16  
3-16

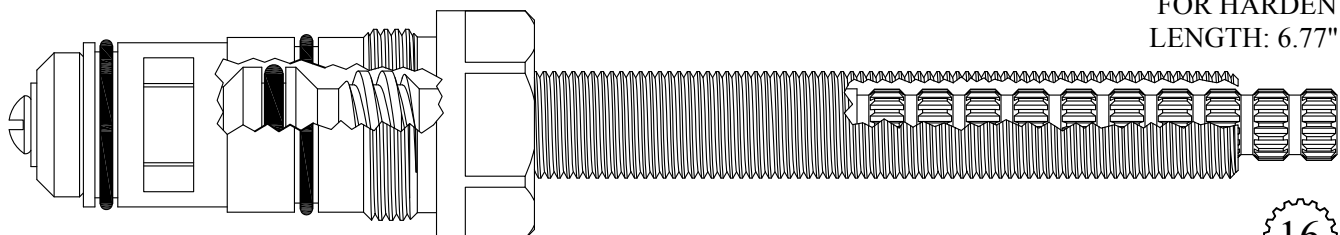

FOR HARDEN  
LENGTH: 6.77"

439221

16  
3-16

Chrome Plated Stem

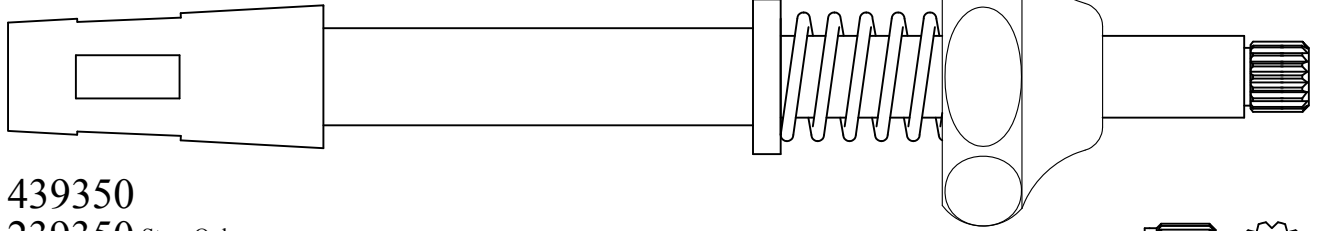

FOR PRICE PFISTER  
LENGTH: 6.78"

439350  
239350 Stem Only

Supplied with  
12pt. Broach



12  
1-2

Chrome Plated Stem

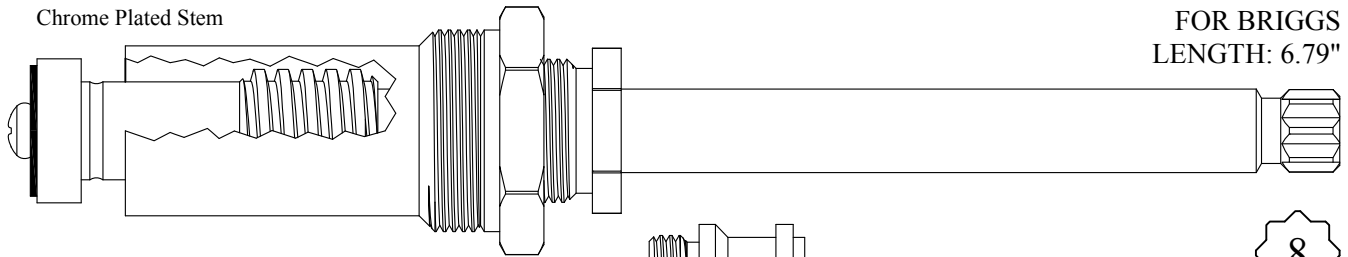

FOR BRIGGS  
LENGTH: 6.79"

427441  
227441 Stem Only  
GASKET: 895340

SEAT USED: 648630

8

Chrome Plated Stem

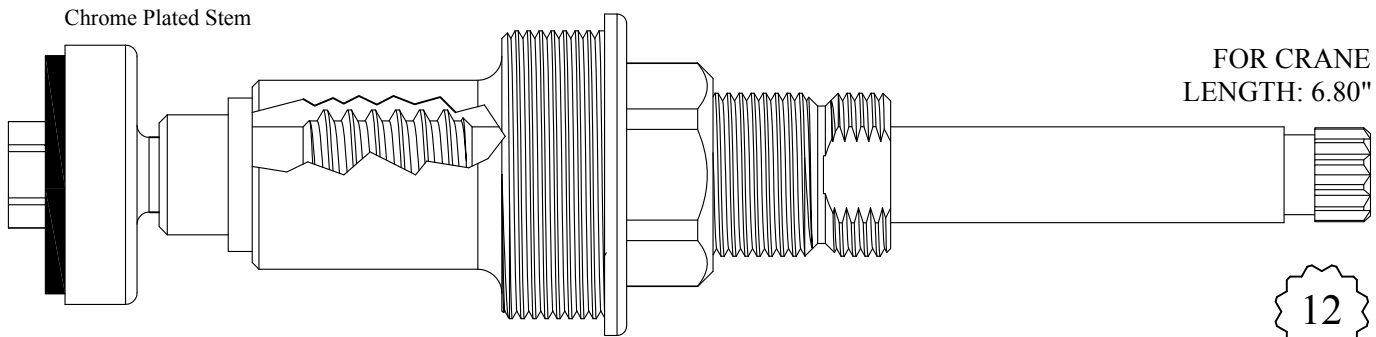

FOR CRANE  
LENGTH: 6.80"

427181  
227181 Stem Only

12

Chrome Plated Stem

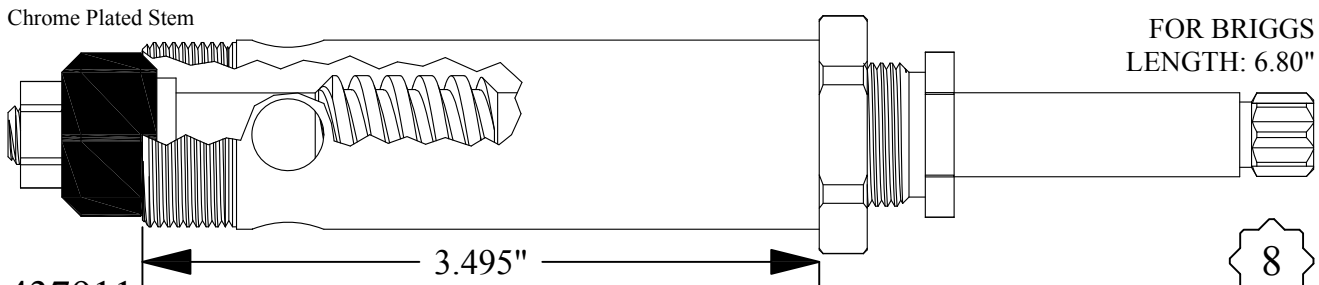

FOR BRIGGS  
LENGTH: 6.80"

437911  
237911 Stem Only  
GASKET: 895340

8

Chrome Plated Stem

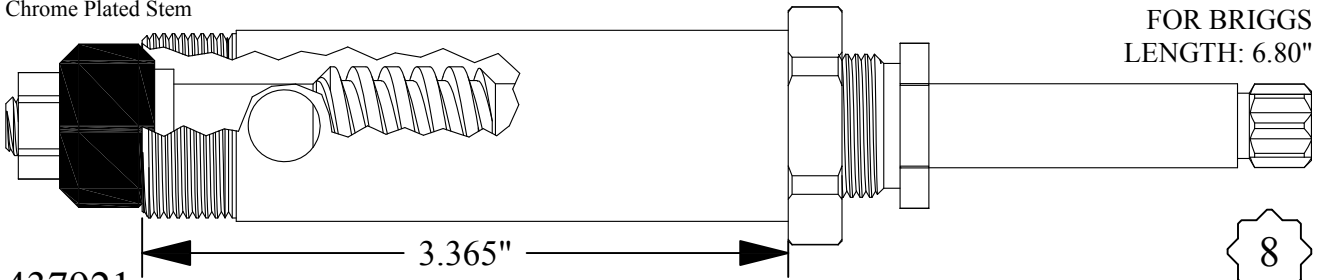

437921  
 237911 Stem Only  
 GASKET: 895340

8

Chrome Plated Stem

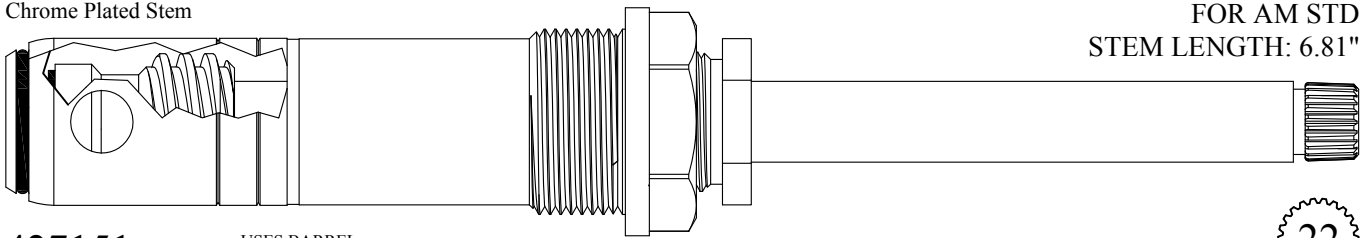

427151  
 227021 Stem Only  
 GASKET: 818010  
 USES BARREL:  
 LF647021

22  
 1-4

Chrome Plated Stem

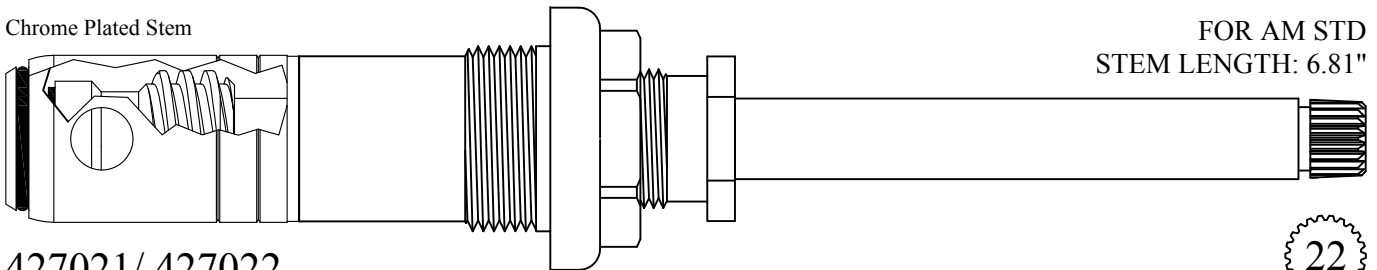

427021/ 427022  
 227021/ 227022 Stem Only  
 GASKET: 818000  
 USES BARREL:  
 LF647021/LF647022

22  
 1-4

Chrome Plated Stem

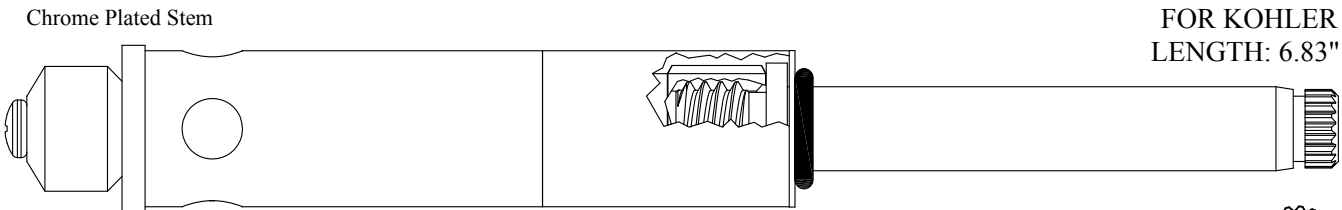

439312

19  
 1-7



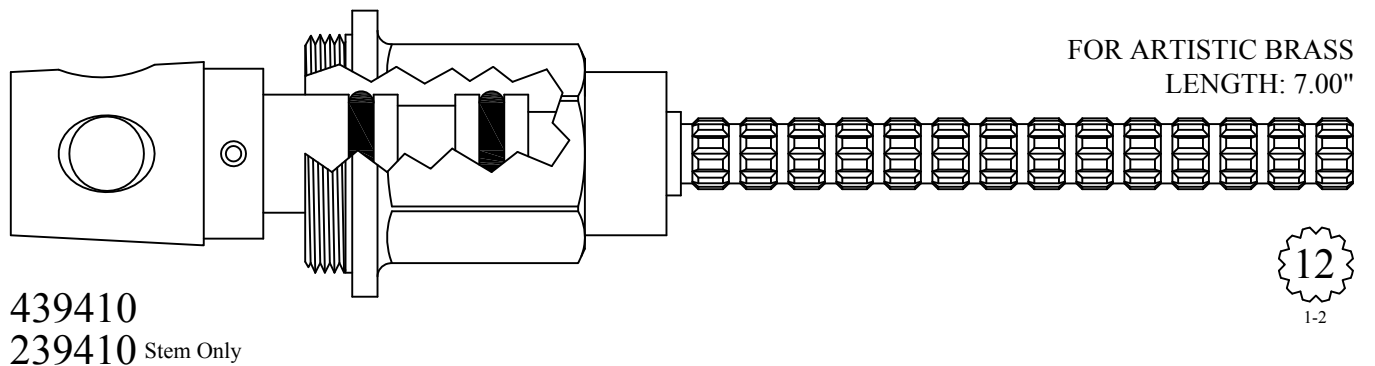
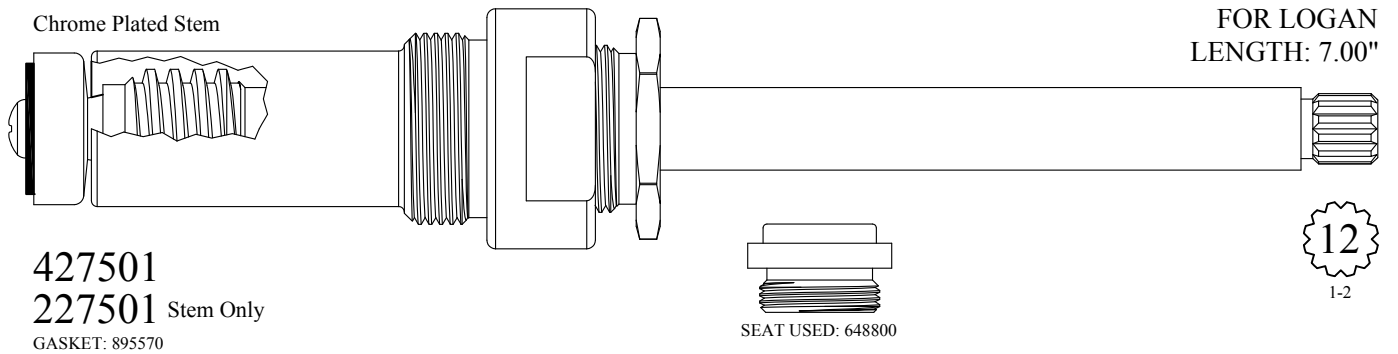
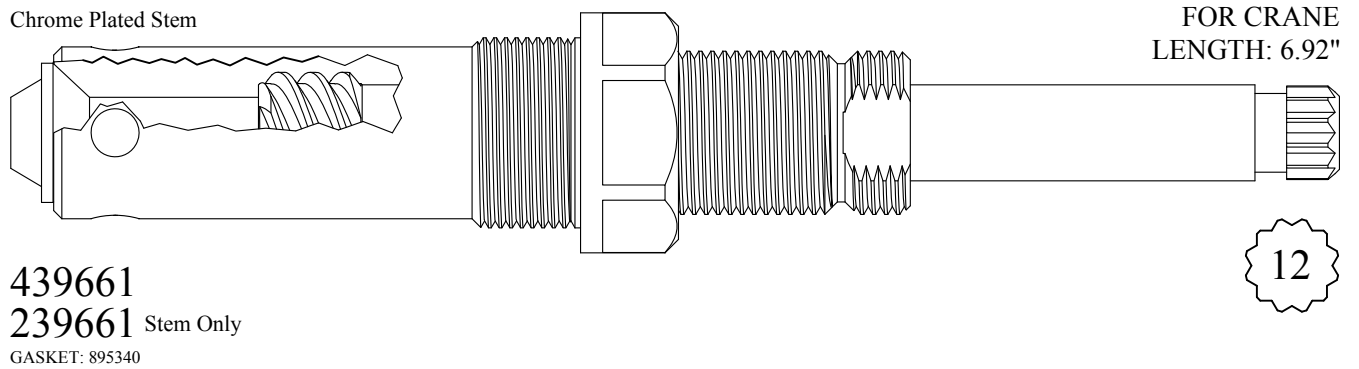
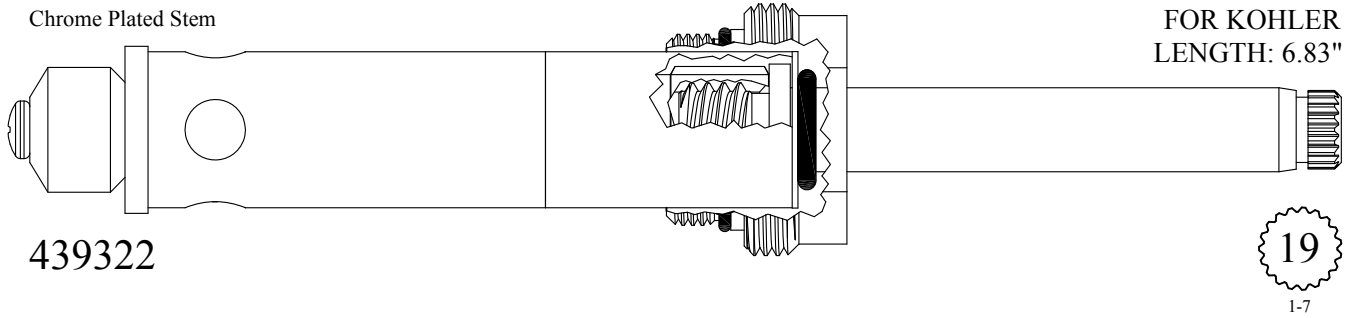

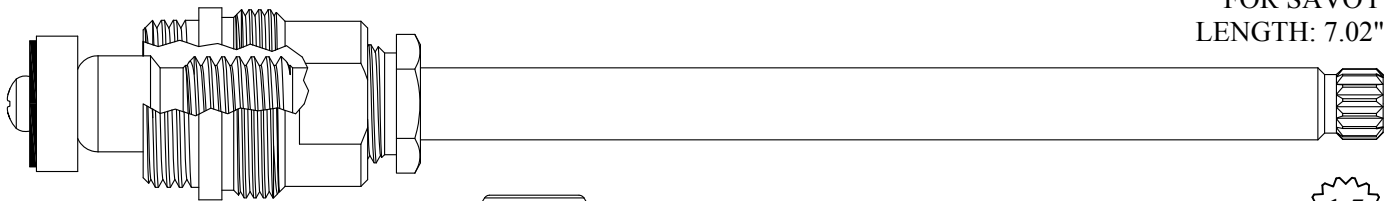

FOR SAVOY  
LENGTH: 7.02"

427081  
GASKET: 895400

SEAT USED: LF648130

15  
1-13

Chrome Plated Stem

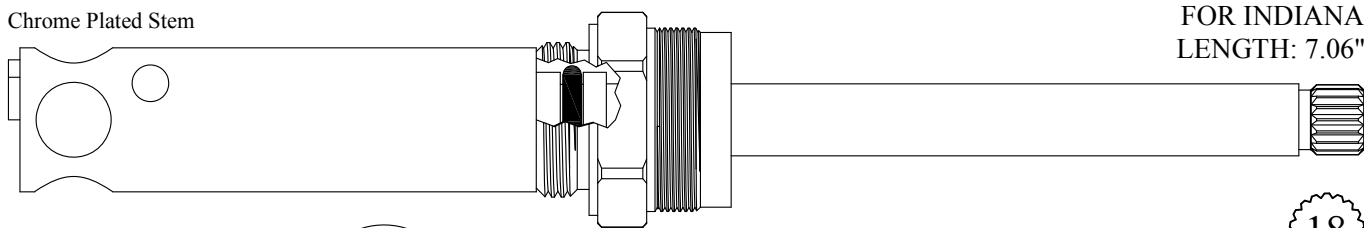

FOR INDIANA  
LENGTH: 7.06"

439520  
239520 Stem Only  
GASKET: 895150

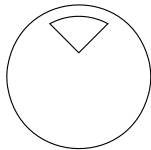

18  
3-3

Chrome Plated Stem

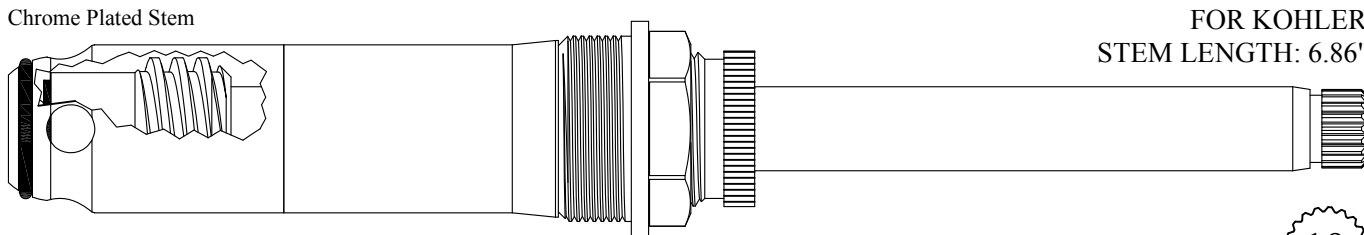

FOR KOHLER  
STEM LENGTH: 6.86"

426711  
226711 Stem Only  
GASKET: 895350

USES BARREL:  
647321

19  
1-7

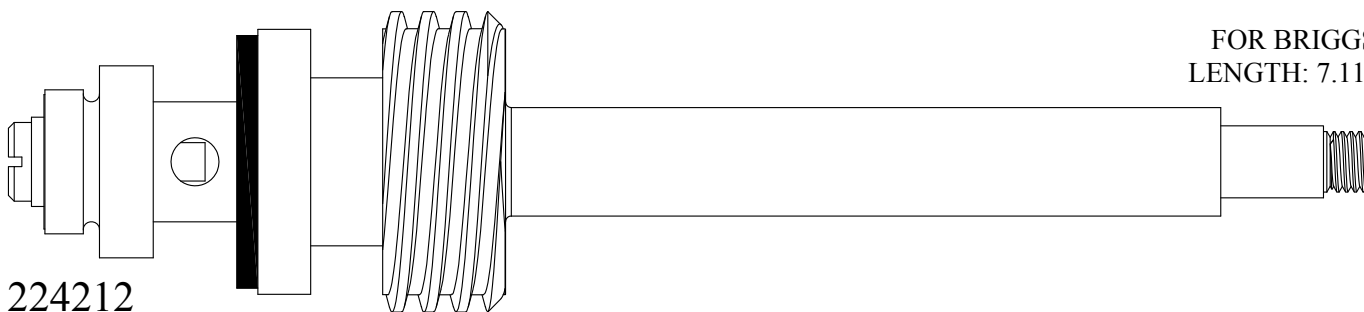

FOR BRIGGS  
LENGTH: 7.11"

224212

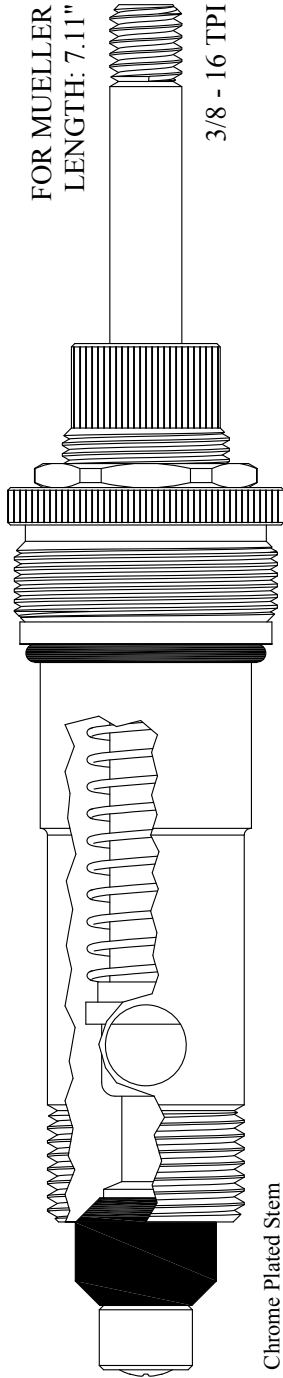

439640  
239640 Stem Only

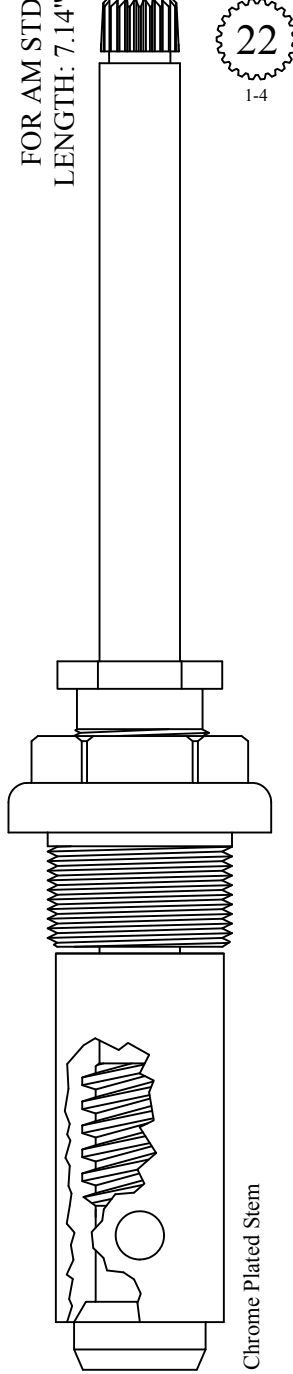

GASKET: 818000

435041  
235041 Stem Only

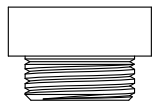

SEAT USED: 649090

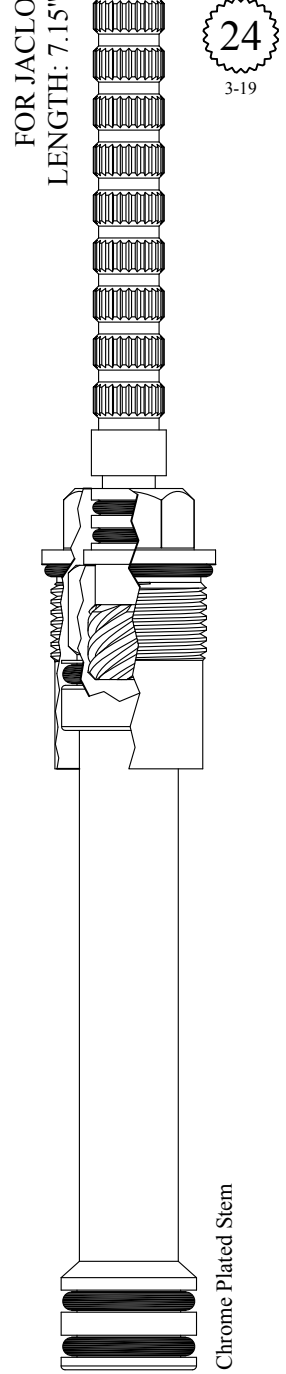

GASKET: 890180 O-RING INCLUDED

439421

FOR AM STD  
LENGTH: 7.25"

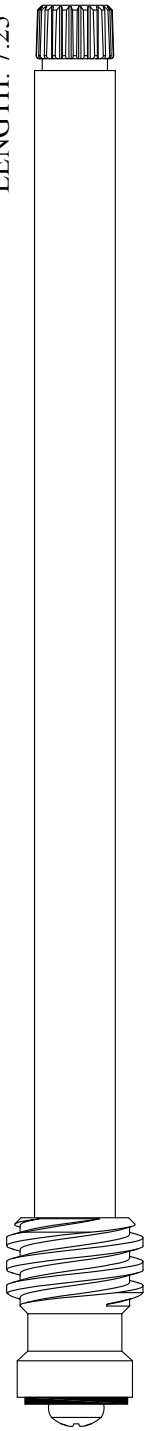

22  
1-4

Chrome Plated Stem

227611  
USES BARREL:  
LF647021

FOR HARDEN  
LENGTH: 7.32"

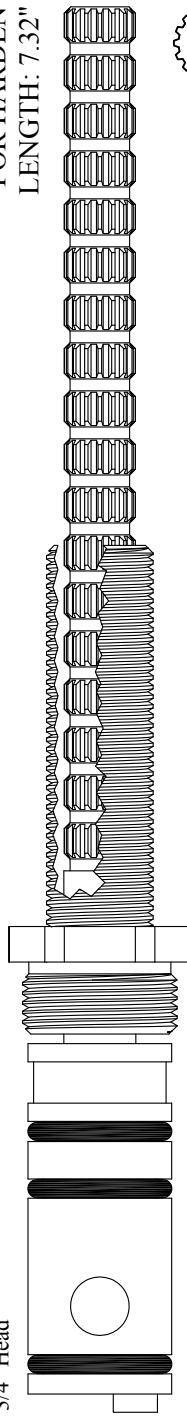

16  
3-16

3/4" Head

439730  
239730 Stem Only

FOR ARTISTIC BRASS  
LENGTH: 7.35"

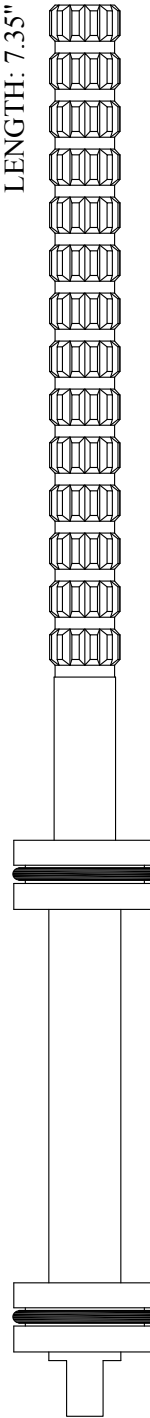

12  
1-2

239690

FOR SPEAKMAN  
LENGTH: 7.35"

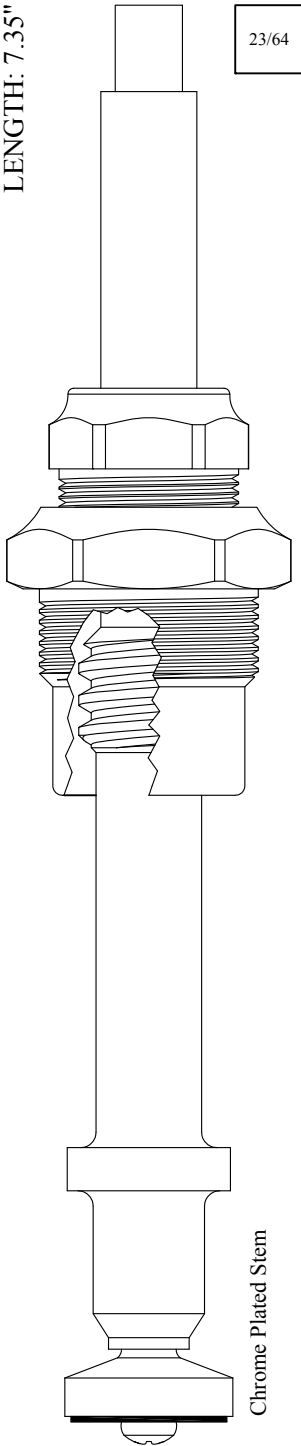

Chrome Plated Stem

GASKET: 895450

428321

228321 Stem Only

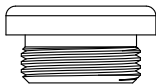

SEAT USED: 648180

FOR PHYLRICH  
LENGTH: 7.60"

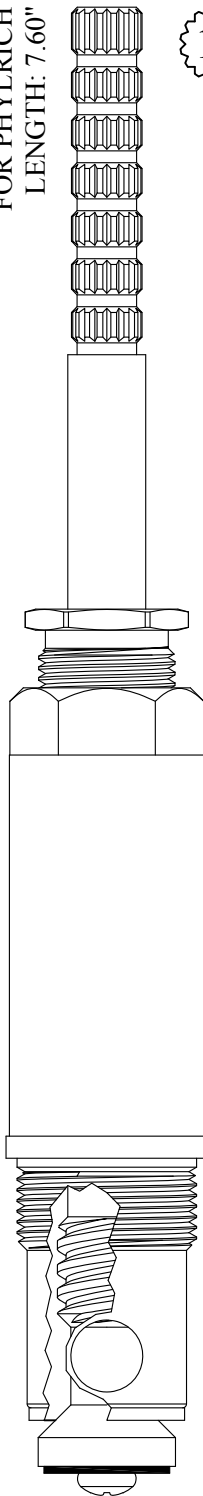

16  
1-6

GASKET: 895370

439681



SEAT USED: 648970

FOR STANDARD SANITARY  
LENGTH: 7.74"

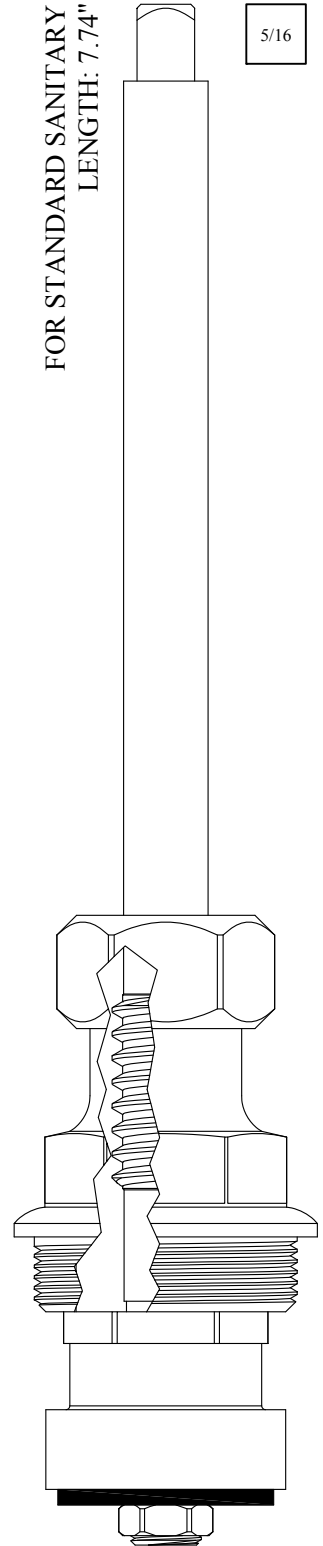

5/16

GASKET: 895500

427801

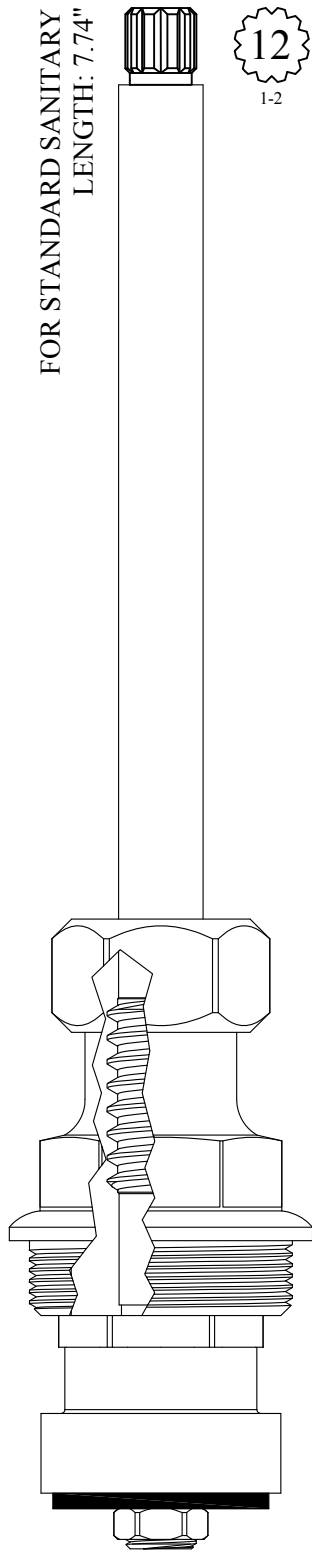

FOR STANDARD SANITARY  
LENGTH: 7.74"

12  
1-2

GASKET: 895500

427851

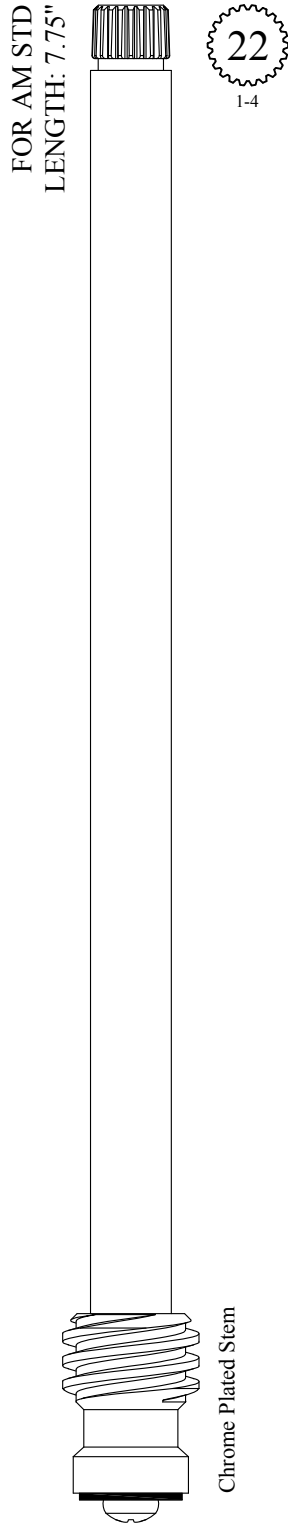

FOR AM STD  
LENGTH: 7.75"

22  
1-4

Chrome Plated Stem

227811

USES BARREL:  
LF647021

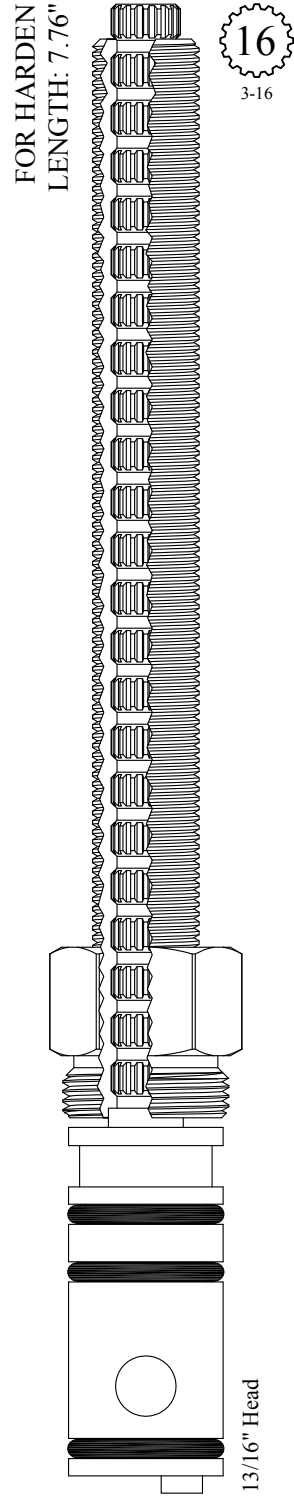

FOR HARDEN  
LENGTH: 7.76"

16  
3-16

13/16" Head

439760

239760 Stem Only

FOR HARDEN  
LENGTH: 7.88"

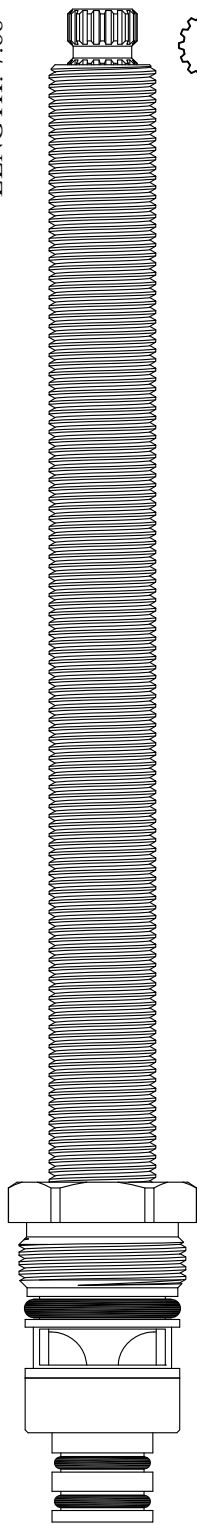

16  
3-16

DISC SET: 151380-PKG

428201  
428202

FOR CRANE  
LENGTH: 7.91"

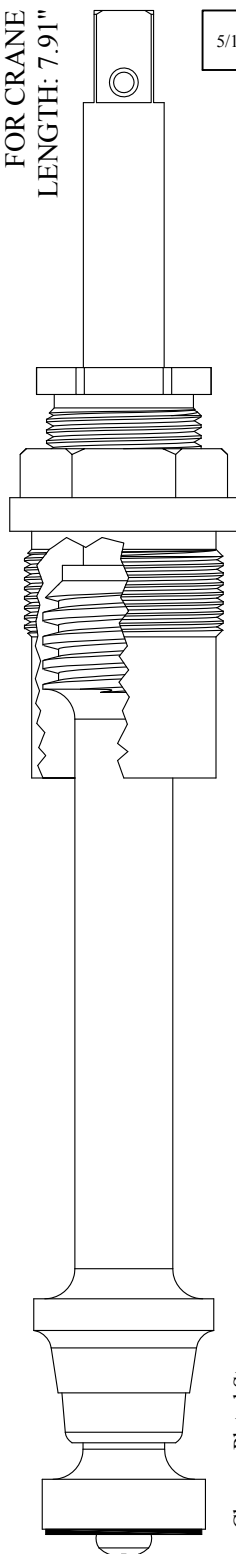

5/16

GASKET: 895560

428001  
228001 Stem Only

Chrome Plated Stem

FOR CRANE  
LENGTH: 7.91"

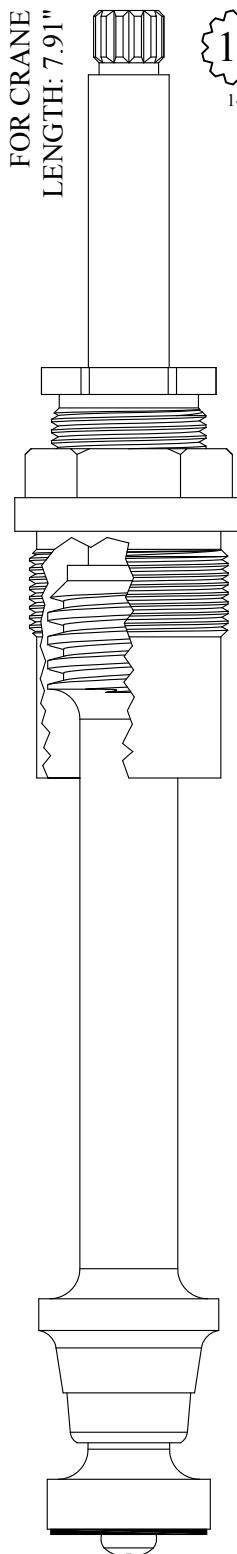

12  
1-2

GASKET: 895560

428051  
228051 Stem Only

Chrome Plated Stem

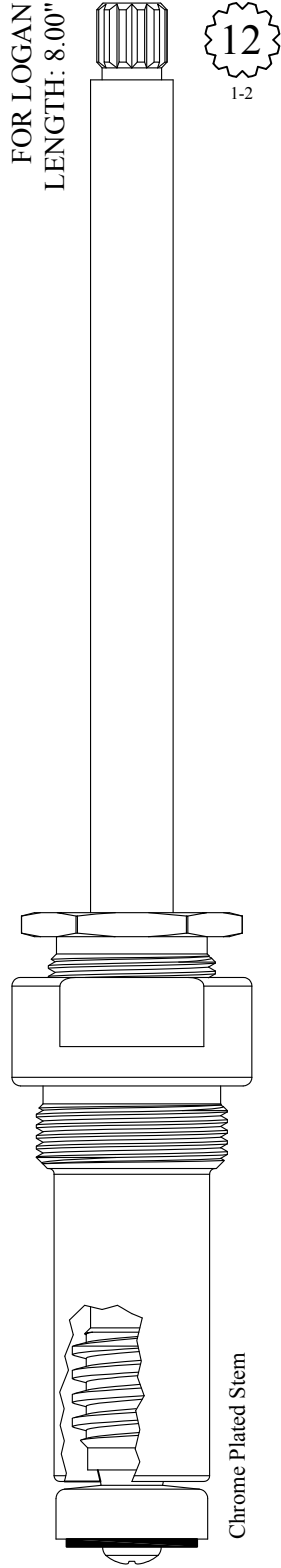

GASKET: 895570

428301

228301 Stem Only



SEAT USED: 648800

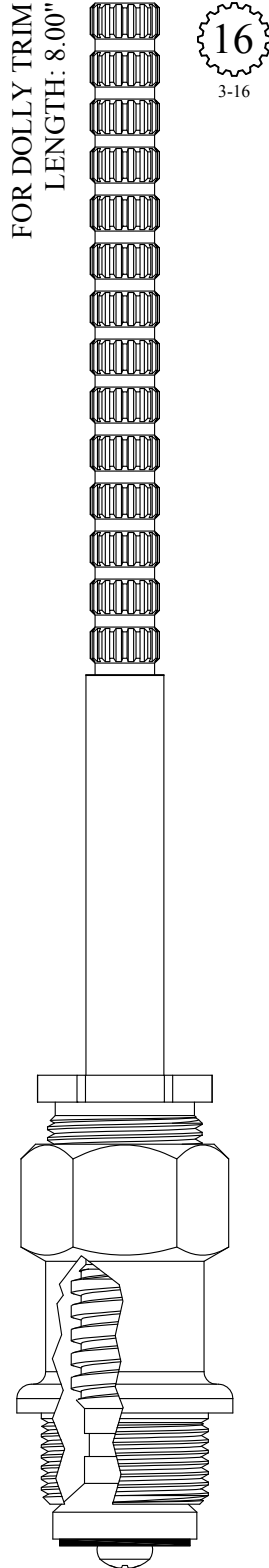

GASKET: 895400

428221

428222

228221 Stem Only

228222 Stem Only



SEAT USED: 648370

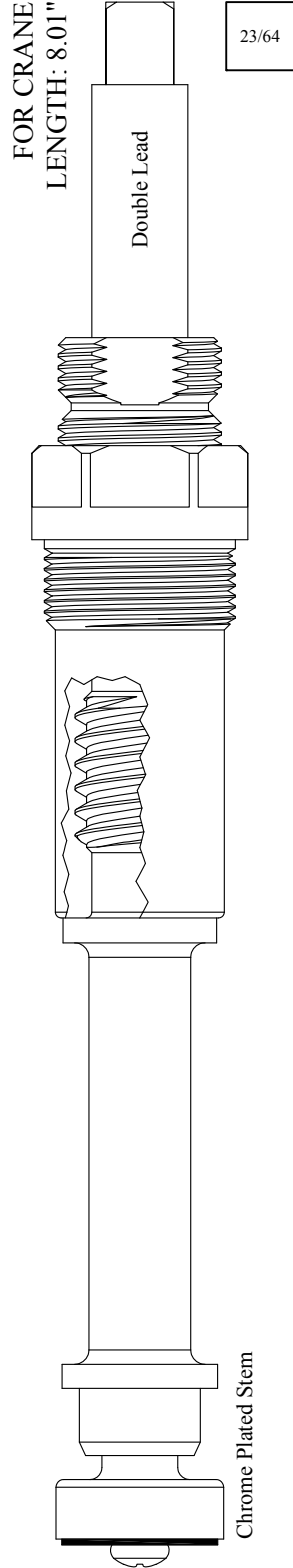

GASKET: 895550

LF480911

LF480912

LF280911 Stem Only

LF280912 Stem Only



FOR CRANE  
LENGTH: 8.01"

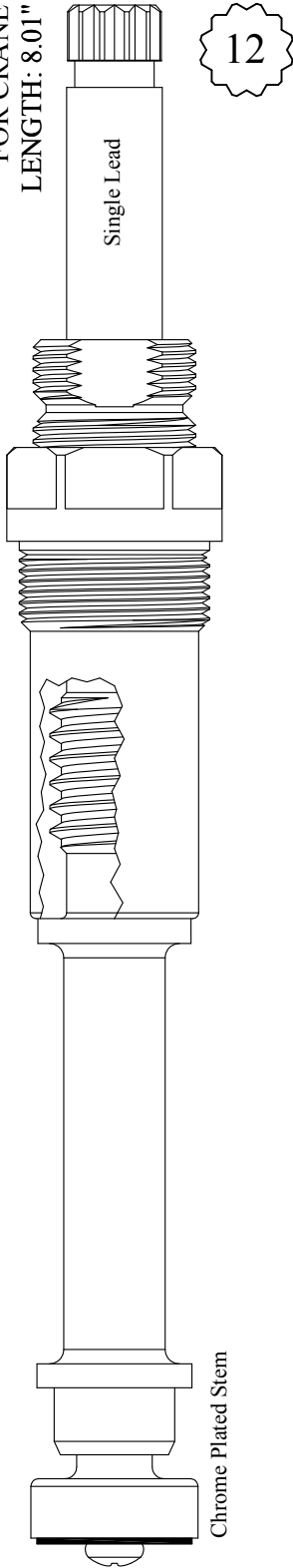

GASKET: 895340

LF480991  
LF280991 Stem Only



SEAT USED: LF649660

FOR NEWPORT  
LENGTH: 8.17"

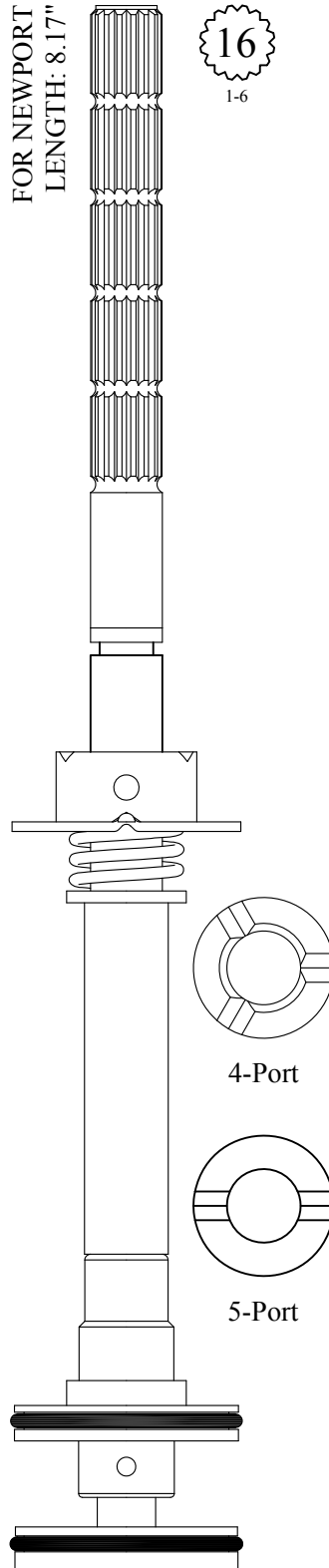

439860 4-Port  
239860 Stem Only  
439870 5-Port  
239870 Stem Only

FOR HARDEN  
LENGTH: 8.18"

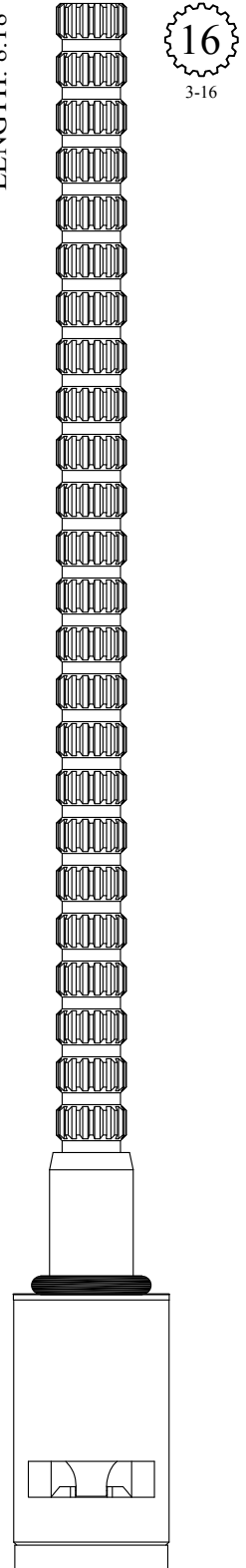

DISC SET: 151380-PKG

428211  
428212

FOR HARDEN  
LENGTH: 8.28"

16  
3-16

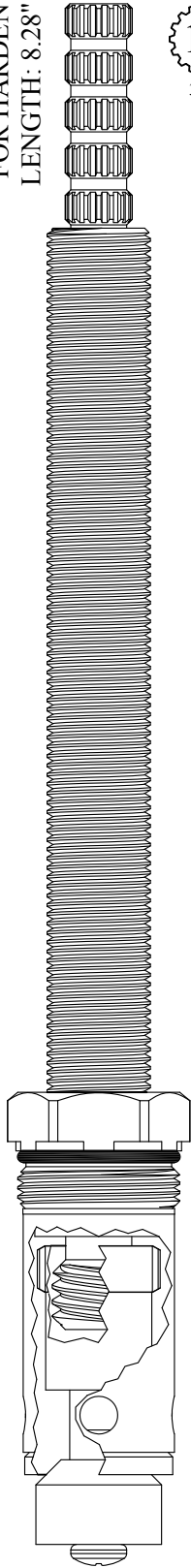

GASKET: 891140 O-RING INCLUDED

439722

FOR HARDEN  
LENGTH: 8.32"

16  
3-16

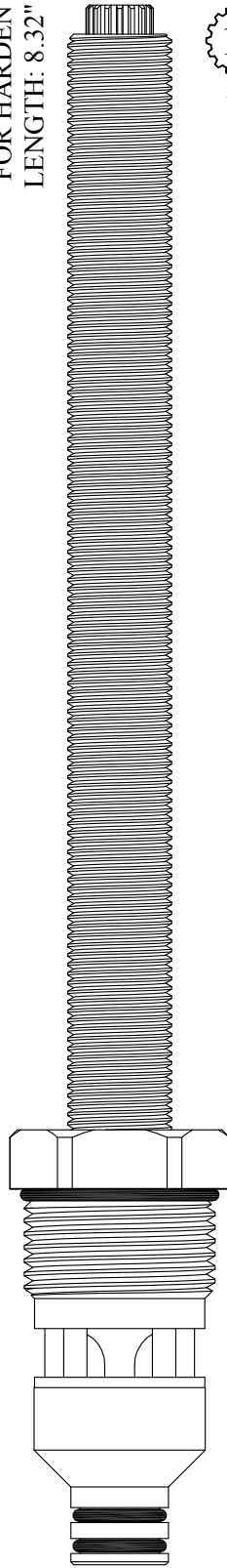

GASKET: 890210 O-RING INCLUDED  
DISC SET: 151380-PRG

428111  
428112

FOR CRANE  
LENGTH: 8.38"

13/32 - 27 TPI

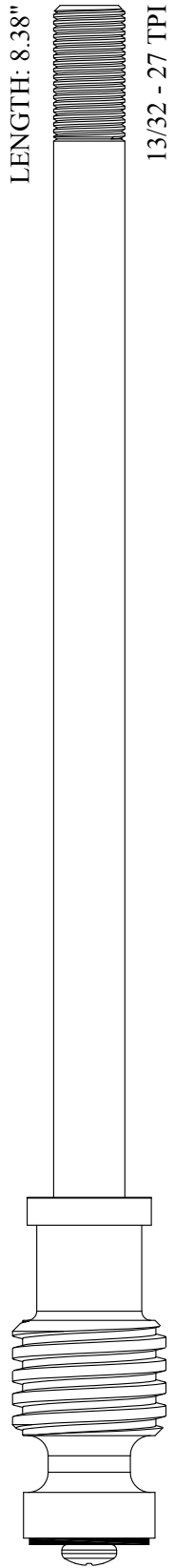

Chrome Plated Stem

227101

FOR AM STD  
LENGTH: 8.38"

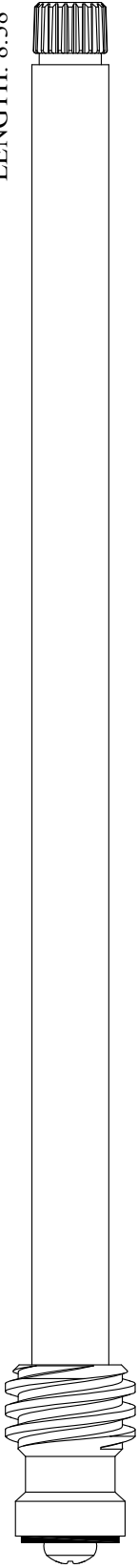

22  
1-4

Chrome Plated Stem

228241  
USES BARREL:  
LF647021

FOR ALTMANS  
LENGTH: 8.50"

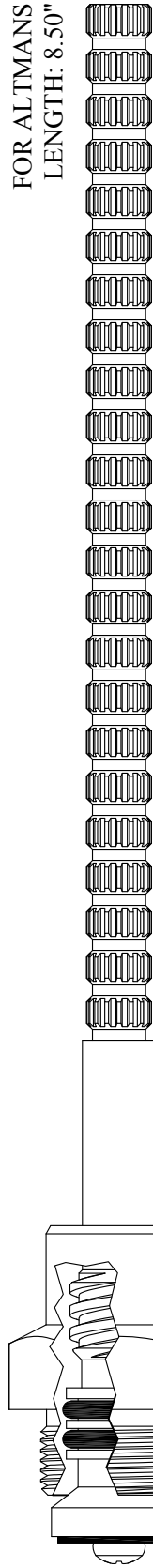

16  
3-16

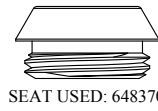

SEAT USED: 648370

GASKET: 895390

428271  
428272

FOR HARDEN  
LENGTH: 8.57"

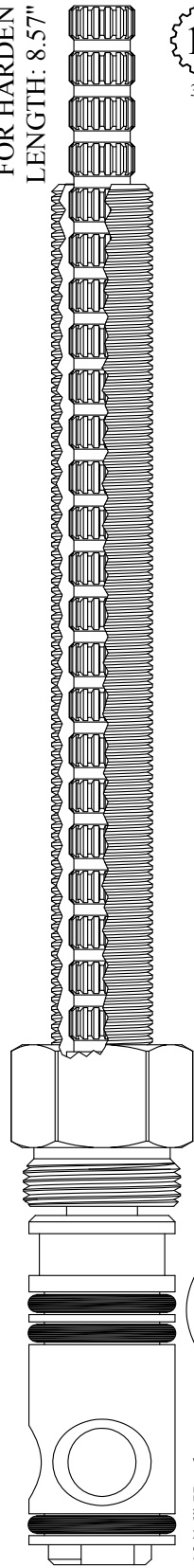

16  
3-16

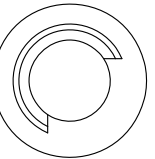

13/16" Head

439740  
239740 Stem Only

FOR ALTMANS  
LENGTH: 8.73"

16  
3-16

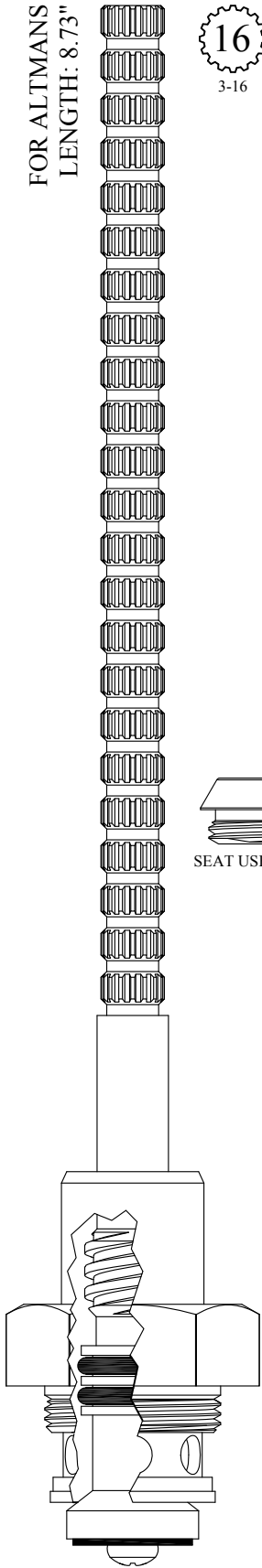

SEAT USED: 648370

GASKET: 895550

439771

FOR KOHLER  
LENGTH: 8.87"

19  
1-7

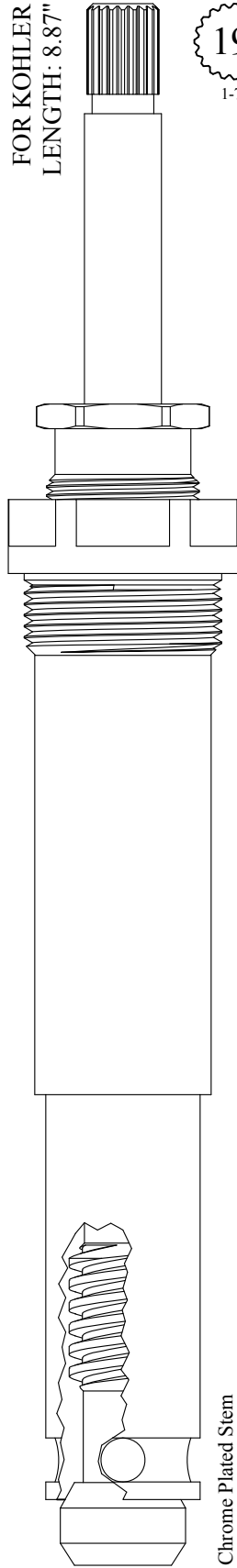

Chrome Plated Stem

GASKET: 895450

439801

239801 Stem Only

FOR KOHLER  
LENGTH: 8.87"

12  
1-2

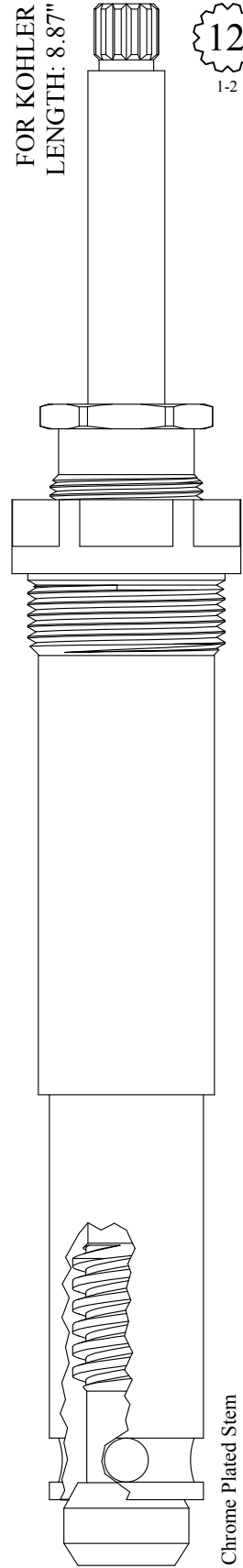

Chrome Plated Stem

GASKET: 895450

439851

239851 Stem Only

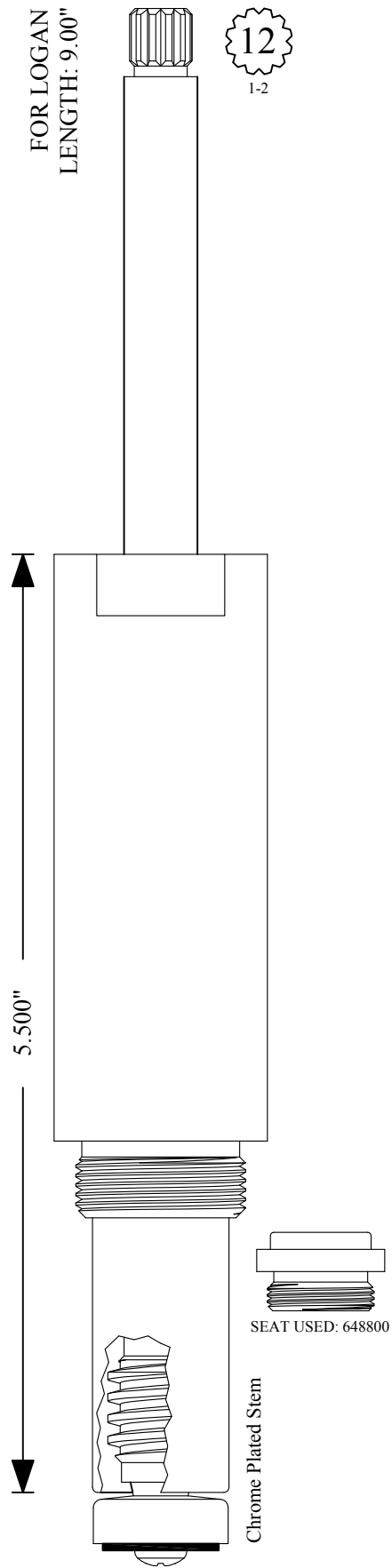

GASKET: 895570

428311

228311 Stem Only

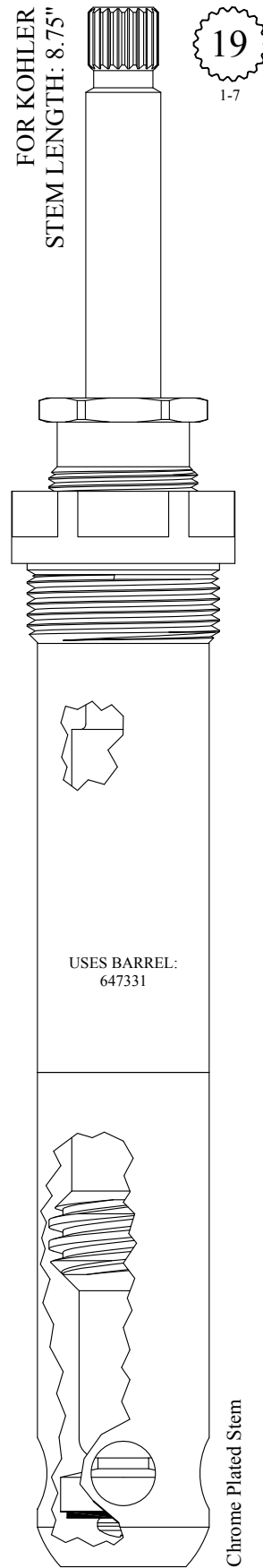

GASKET: 895450

428331

228331 Stem Only

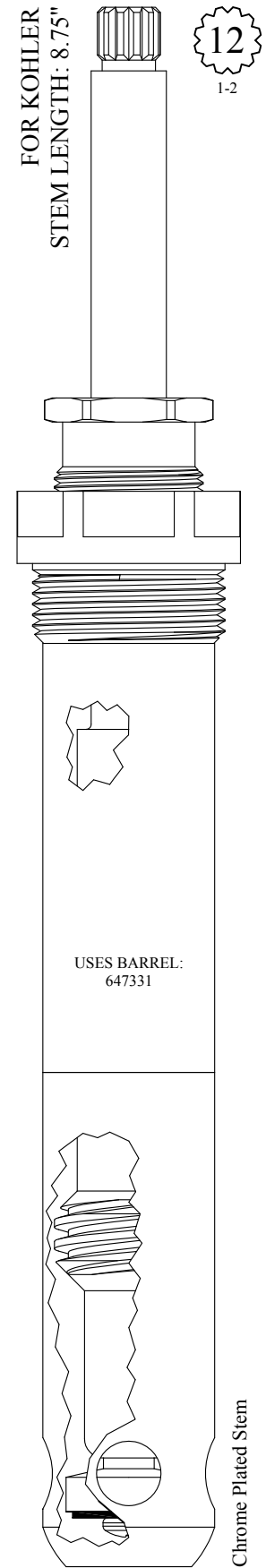

GASKET: 895450

428381

228381 Stem Only

FOR SPEAKMAN  
LENGTH: 9.09"

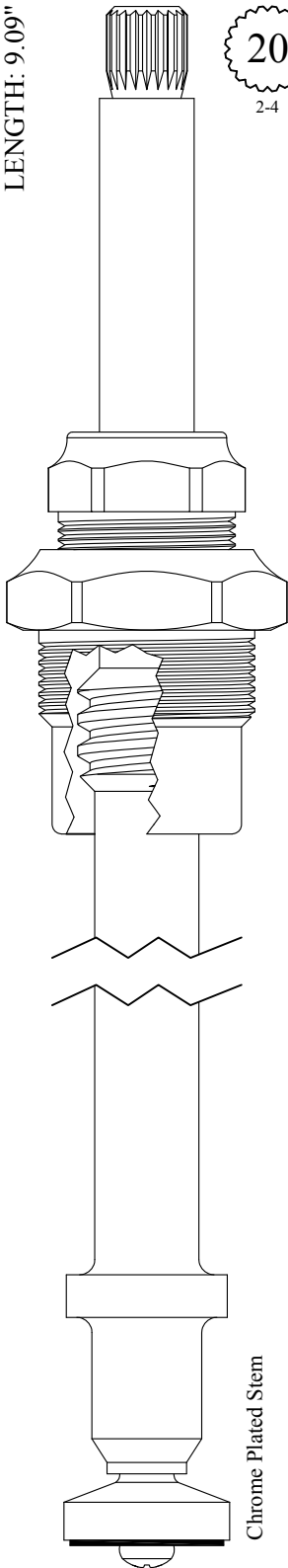

Chrome Plated Stem

GASKET: 895450

428341

228341 Stem Only

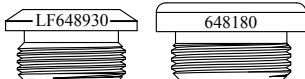

SEAT USED: LF648930 or 648180

FOR SPEAKMAN  
LENGTH: 9.09"

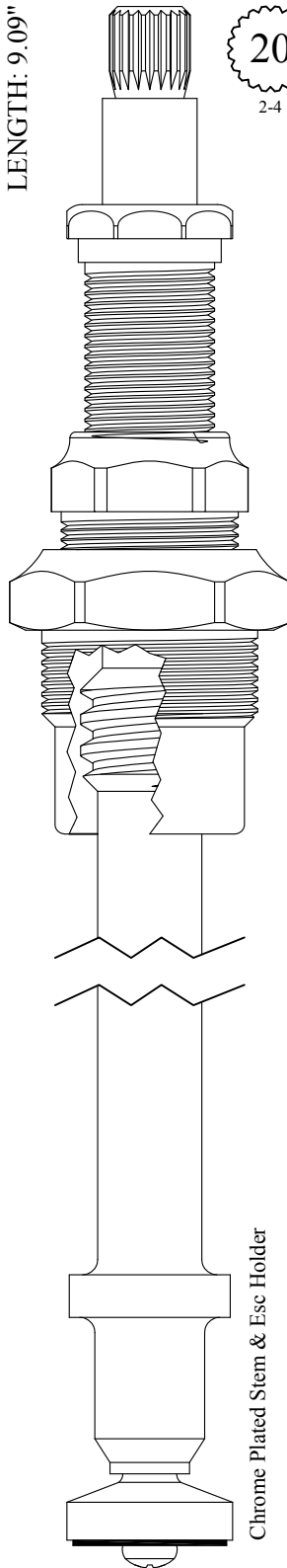

Chrome Plated Stem & Esc Holder

GASKET: 895450

428421

228421 Stem Only

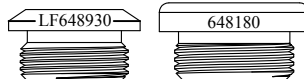

SEAT USED: LF648930 or 648180

FOR FEDERAL HUBER  
LENGTH: 9.13"

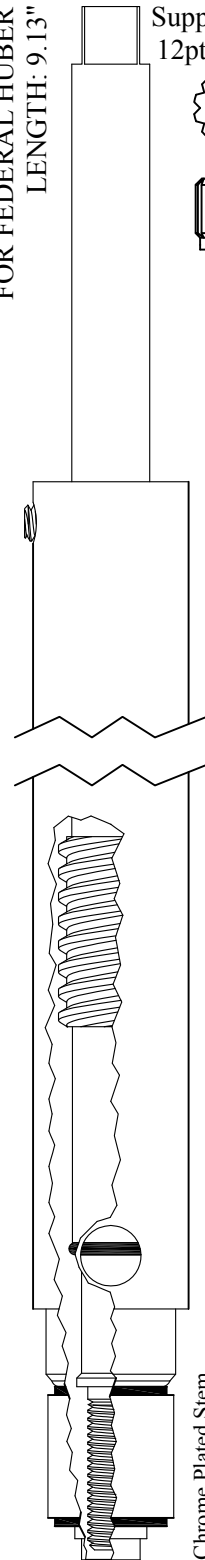

Chrome Plated Stem

Supplied with  
12pt. Broach

439921

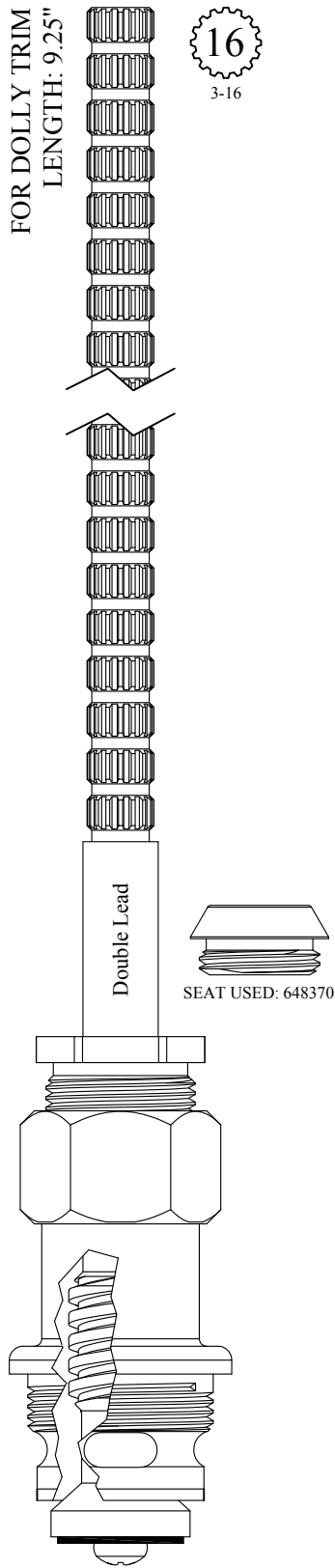

16  
3-16

GASKET: 895550

439881  
239881 Stem Only

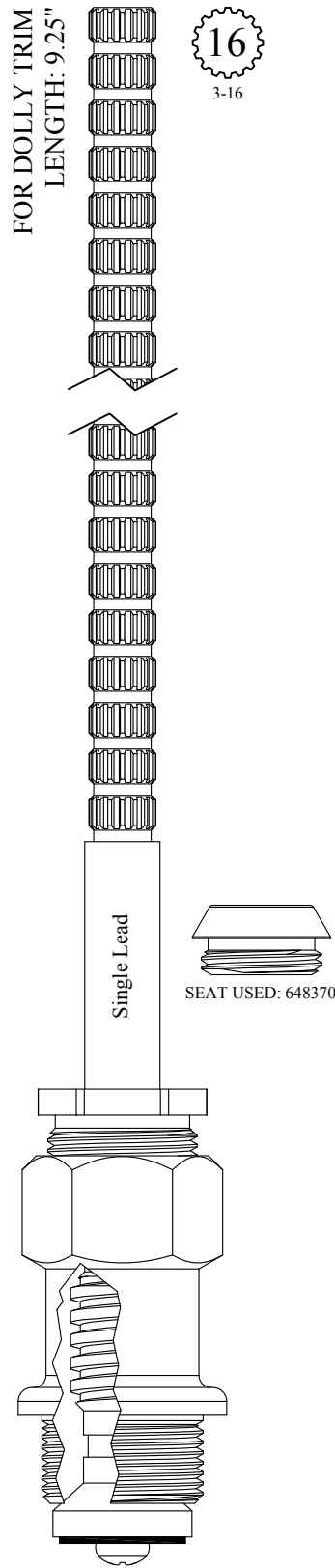

16  
3-16

GASKET: 895400

428391  
428392  
228391 Stem Only  
228392 Stem Only

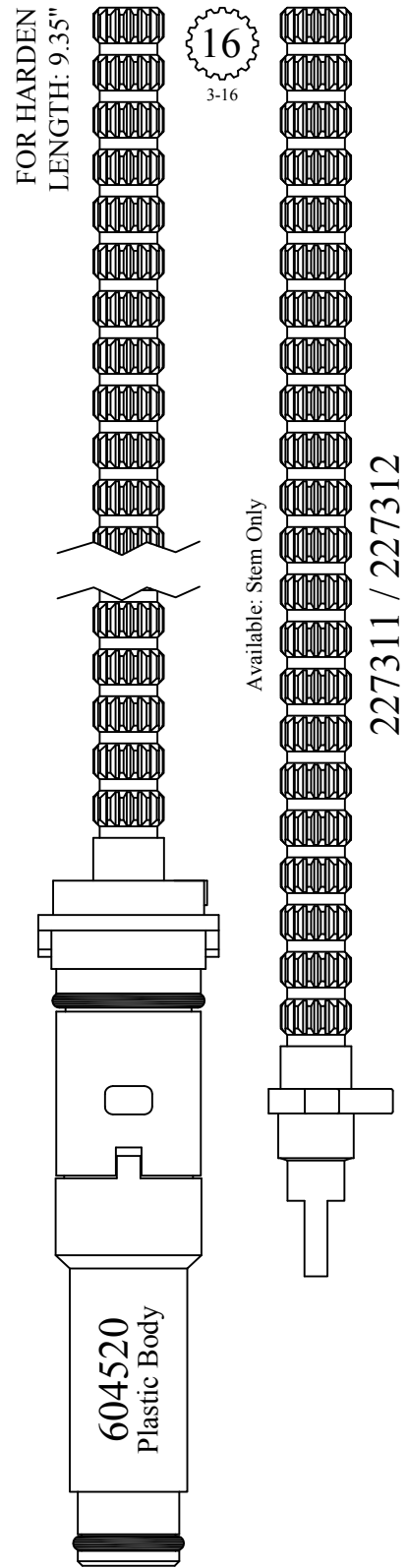

16  
3-16

427311  
427312

227311 / 227312

FOR AM STD  
LENGTH: 9.38"

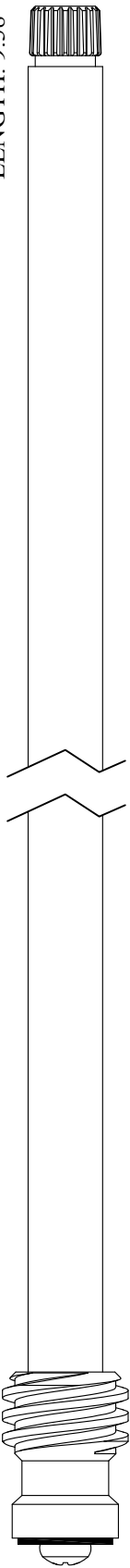

22  
1-4

Chrome Plated Stem

228411  
USES BARREL:  
LF647021

FOR LOGAN  
LENGTH: 9.50"



12  
1-2

Chrome Plated Stem

GASKET: 895570

428401  
228401 Stem Only

FOR ALTMANS  
LENGTH: 9.50"

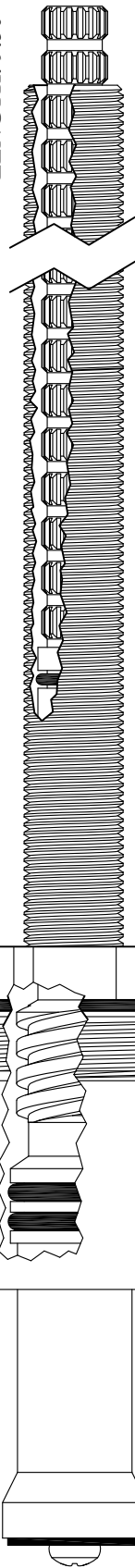

16  
3-16

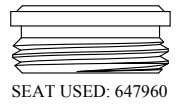

GASKET: 890210 O-RING INCLUDED

428451  
428452



FOR HARDEN  
LENGTH: 9.53"

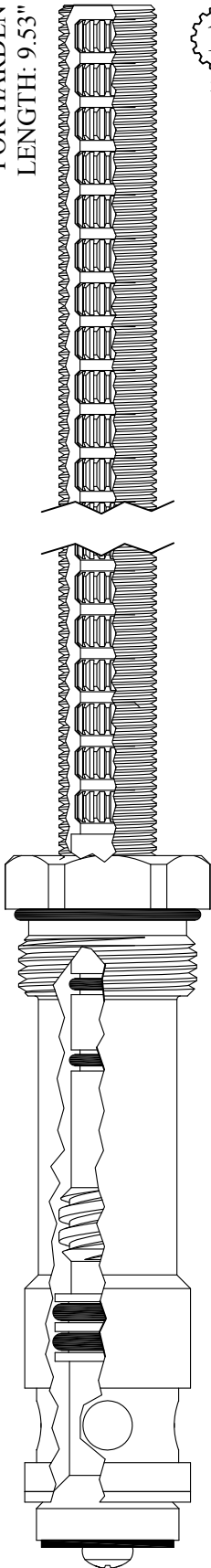

16  
3-16

GASKET: 891180 O-RING INCLUDED

439911

FOR HARDEN  
LENGTH: 9.66"

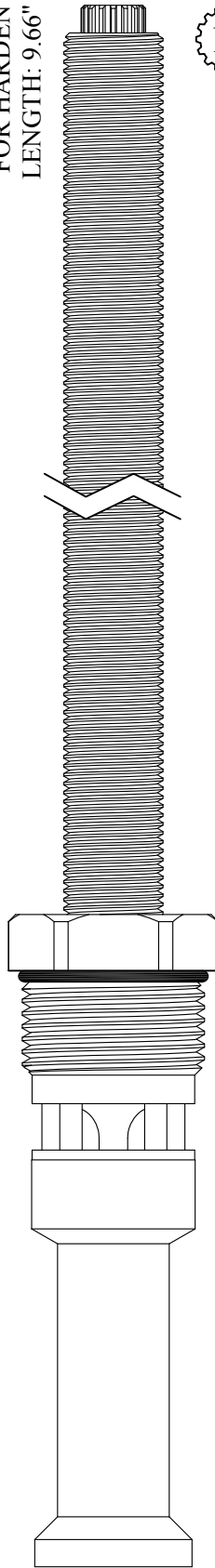

16  
3-16

GASKET: 890210 O-RING INCLUDED  
SEAL: 898510  
DISC SET: 151380-PKG

428441  
428442

FOR ALTMANS  
LENGTH: 9.66"

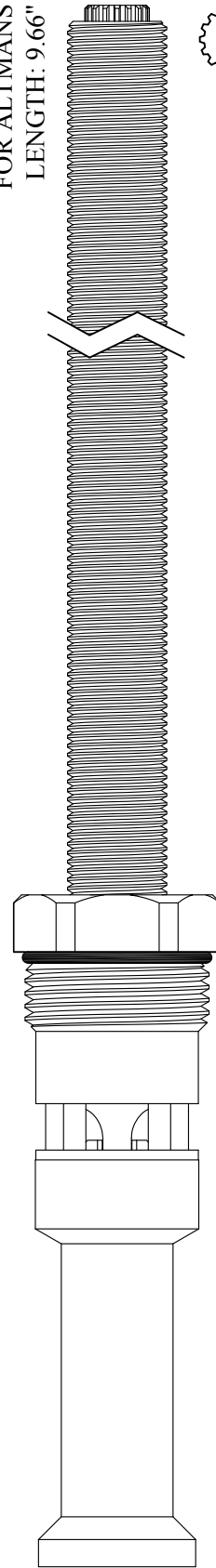

16  
3-16

GASKET: 890210 O-RING INCLUDED  
SEAL: 898510  
DISC SET: 151380-PKG

428461  
428462

Replaces Walter# 418811 / 418812 Compression Units

FOR AM STD  
LENGTH: 9.75"

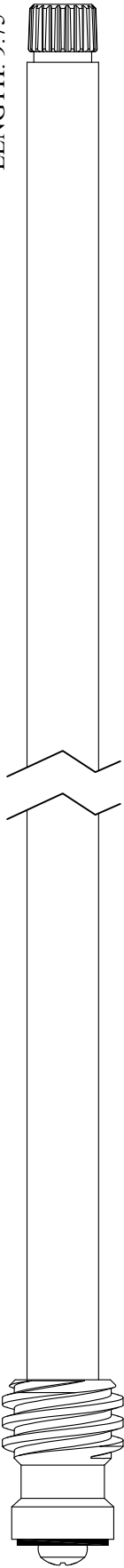

22  
1-4

228431  
USES BARREL:  
LF647021

FOR AM STD  
LENGTH: 10.75"

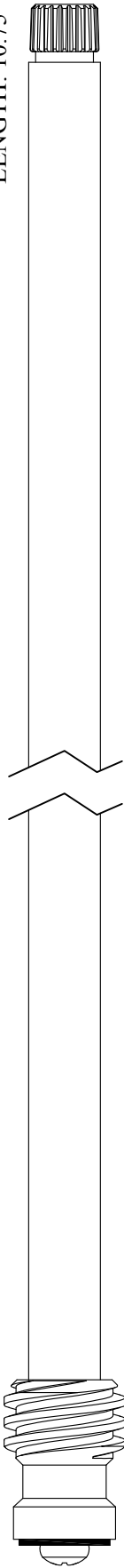

22  
1-4

228611  
USES BARREL:  
LF647021

FOR CRANE  
LENGTH: 10.80"

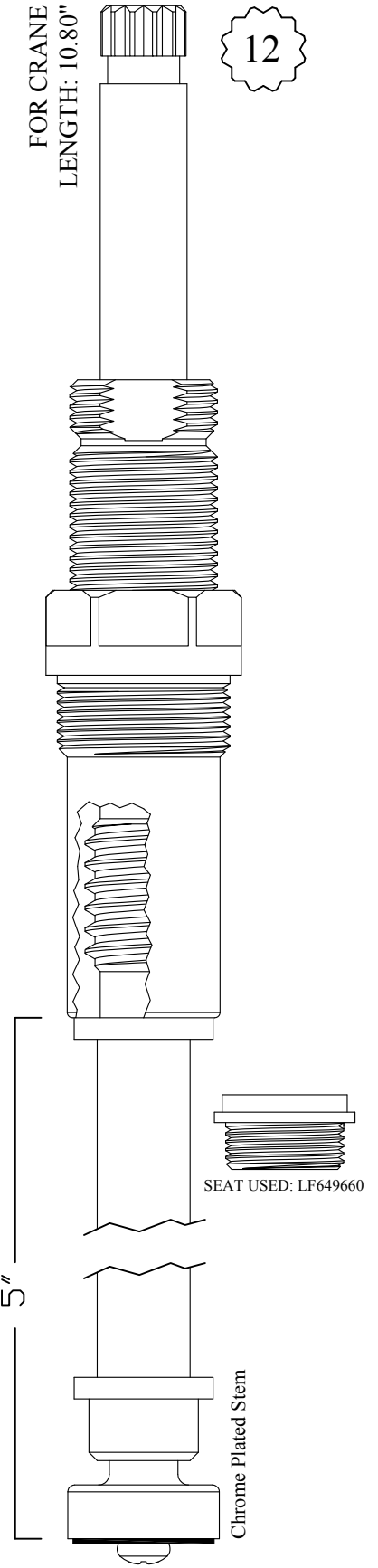

12

GASKET: 895340

428501  
228501 Stem Only

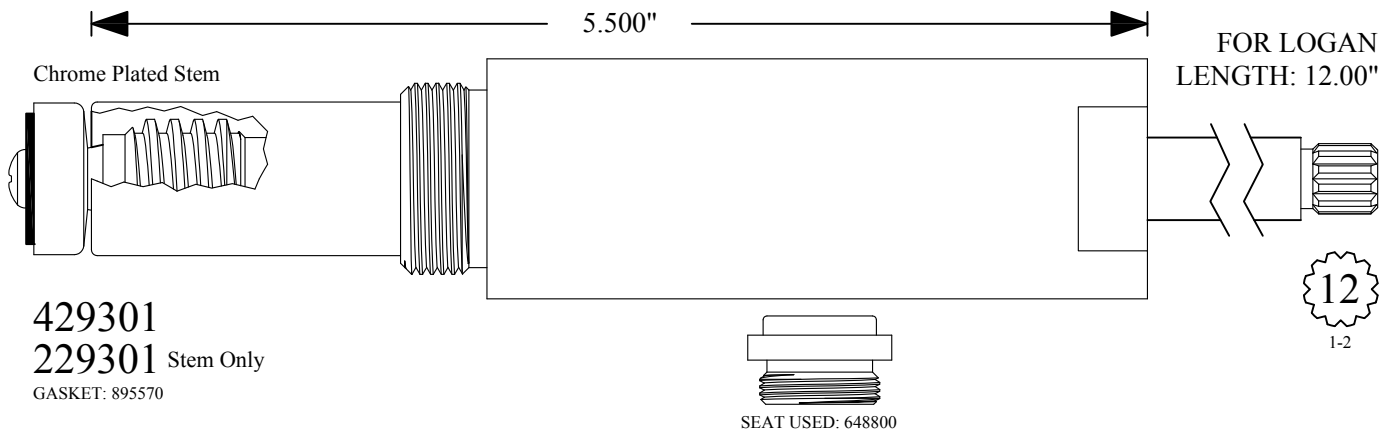
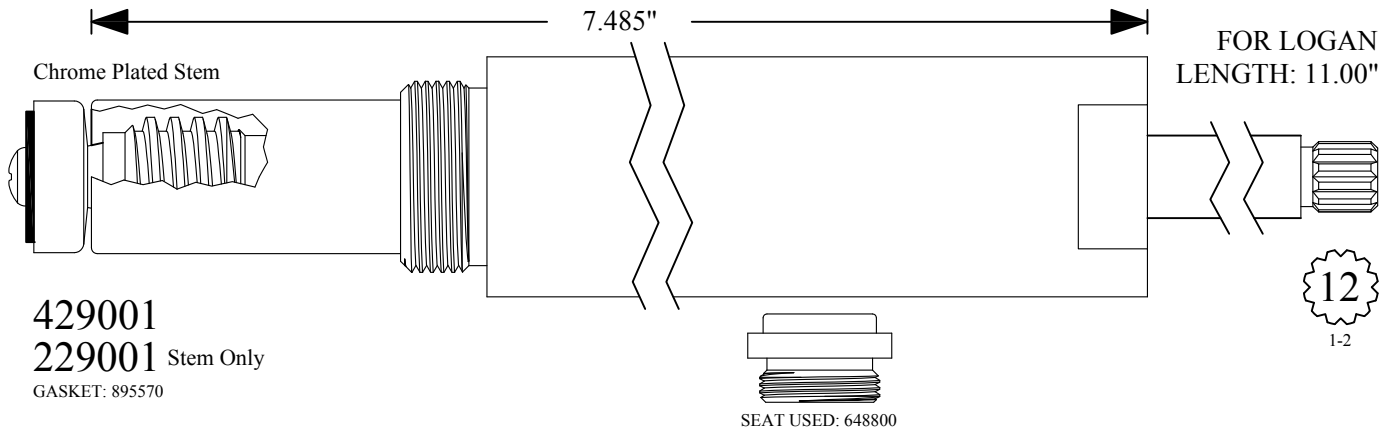

Also available in the following lengths:

UNIT	STEM ONLY	LENGTH
429501	229501	14.00"
429601	229601	16.00"
429701	229701	18.00"

***Send Your Orders To:***

BARRY E.  ALTER  SR. CO.

***E-mail: [orderdesk@barrywalter.com](mailto:orderdesk@barrywalter.com)***

***Fax: 1.800.886.9831***

***Phone: 1.800.767.5552***