

FOR CONCINNY
LENGTH: 0.94"

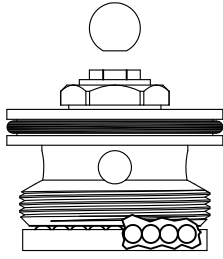

LF450111
LF450112

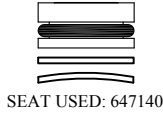

SEAT USED: 647140

FOR MILWAUKEE
LENGTH: 1.04"

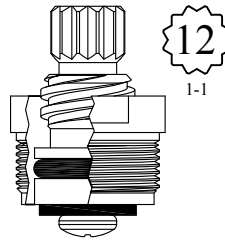

GASKET: 895100

LF450011
LF450012

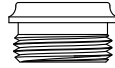

SEAT USED: LF649040

FOR SPEAKMAN
LENGTH: 1.07"

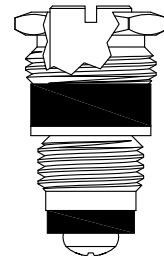

Nickel Plated Stem
Chrome Plated Pkg Nut

LF400111
LF200111 Stem Only

FOR CRANE
LENGTH: 1.15"

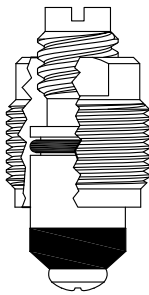

400201
200201 Stem Only

FOR CRANE
LENGTH: 1.15"

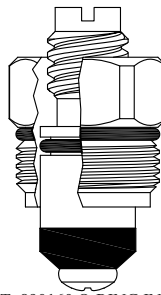

GASKET: 890160 O-RING INCLUDED

400211
200201 Stem Only

FOR ELJER
LENGTH: 1.16"

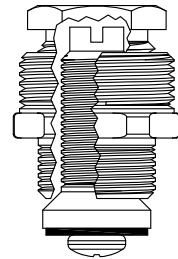

GASKET: 895060

400101

FOR GERBER
LENGTH: 1.19"

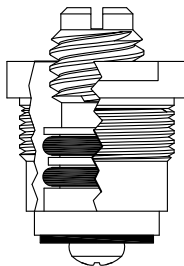

GASKET: 895150

400381

FOR GRAND HAVEN
LENGTH: 1.19"

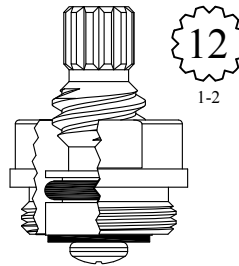

GASKET: 895160

LF450021



SEAT USED: LF649270

FOR ELJER
LENGTH: 1.19"

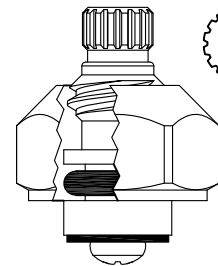

16
3-15

Nickel Plated Gland

LF450031
LF450032

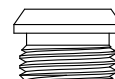

SEAT USED: LF648320

FOR CONCINITY
LENGTH: 1.19"

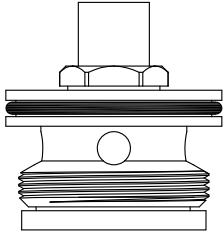

LF450161
LF450162



SEAT USED: 647140

FOR DELTA
LENGTH: 1.20"

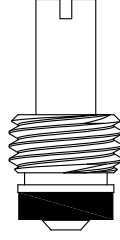

200141

FOR SPEAKMAN
LENGTH: 1.24"

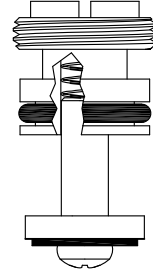

400220

FOR ARROWHEAD
LENGTH: 1.24"

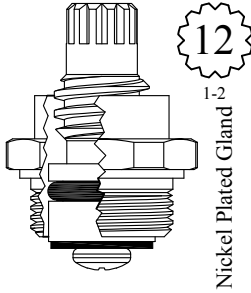

Nickel Plated Gland

GASKET: 895100

LF450041
LF450042



SEAT USED: LF648230

FOR ELJER
LENGTH: 1.25"

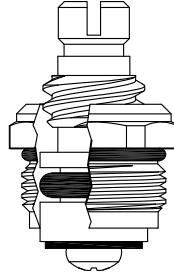

GASKET: 890160 O-RING INCLUDED

400131

FOR LAWLER
LENGTH: 1.25"



LF200751

FOR ELJER
LENGTH: 1.25"

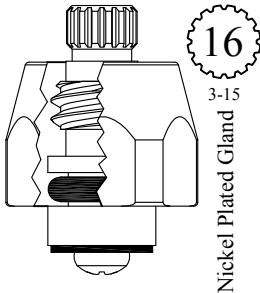

Nickel Plated Gland

LF450231
LF450232

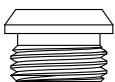

SEAT USED: LF648320

FOR ELJER
LENGTH: 1.25"

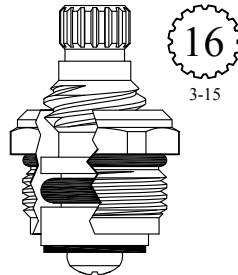

GASKET: 890160 O-RING INCLUDED

LF450851
LF450852



SEAT USED: LF648320

FOR ELJER
LENGTH: 1.25"

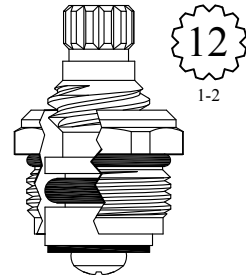

GASKET: 890160 O-RING INCLUDED

LF450861
LF450862

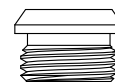

SEAT USED: LF648320

FOR BURLINGTON
LENGTH: 1.26"

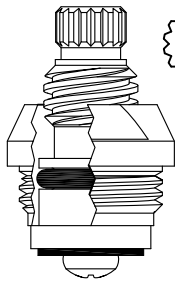

16
Nickel Plated Gland

GASKET: 895100

LF450061
LF450062



SEAT USED: LF648700

FOR STERLING FAUCET
LENGTH: 1.31"

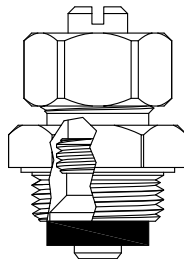

GASKET: 895100

400181

FOR SAVOY
LENGTH: 1.31"

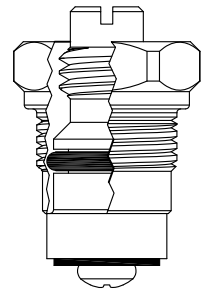

GASKET: 895100

400291

FOR STREAMLINER
LENGTH: 1.34"

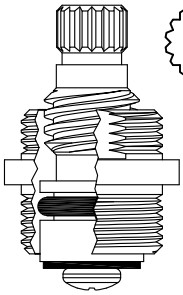

16
Nickel Plated Gland

GASKET: 895100

LF450131
LF450132

FOR INDIANA
LENGTH: 1.34"

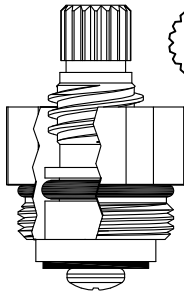

18
Nickel Plated Gland

GASKET: 890170 O-RING INCLUDED

450971

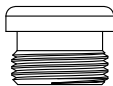

SEAT USED: LF648560

FOR INDIANA
LENGTH: 1.34"

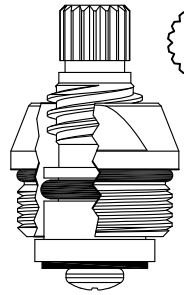

18
Nickel Plated Gland

GASKET: 890170 O-RING INCLUDED

LF451011
LF451012

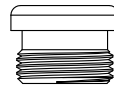

SEAT USED: LF648560

FOR CRANE
LENGTH: 1.35"

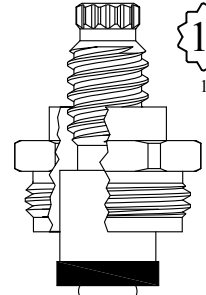

12
Nickel Plated Gland

GASKET: 895180

400411
400412

FOR SAYCO
LENGTH: 1.36"

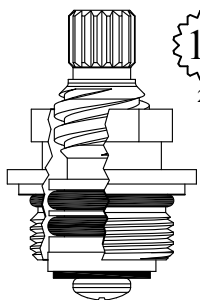

16
Nickel Plated Gland

GASKET: 890160 O-RING INCLUDED

LF450091
LF450092

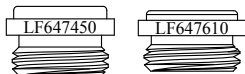

SEAT USED: LF647450 or LF647610

FOR INDIANA
LENGTH: 1.36"

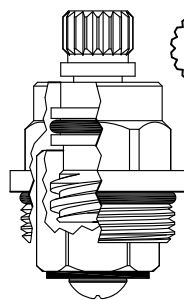

18
Chrome Plated Gland

GASKET: 890170 O-RING INCLUDED

LF450501
LF450502

FOR SAYCO
LENGTH: 1.36"

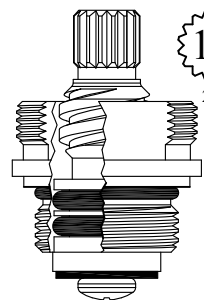

16
Nickel Plated Gland

GASKET: 890160 O-RING INCLUDED

LF451271
LF451272



SEAT USED: LF647450

FOR SAYCO
LENGTH: 1.37"

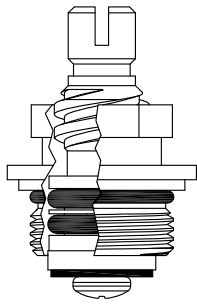

Nickel Plated Gland

GASKET: 890160 O-RING INCLUDED

400271

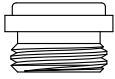

SEAT USED: LF647450

FOR SAYCO
LENGTH: 1.37"

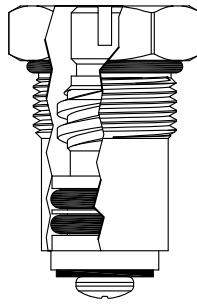

GASKET: 890170 O-RING INCLUDED

400281

FOR KOHLER
LENGTH: 1.37"

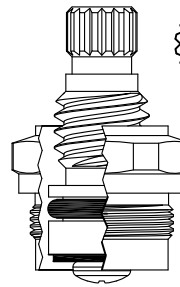

16
1-5

Nickel Plated Gland

GASKET: 895100

LF450051
LF450052

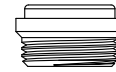

SEAT USED: LF648070

FOR STERLING FAUCET
LENGTH: 1.37"

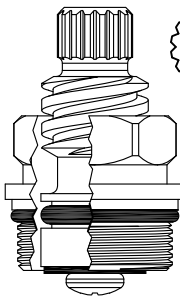

16
1-5

GASKET: 890180 O-RING INCLUDED

LF450401
LF450402

FOR UNION BRASS
LENGTH: 1.38"

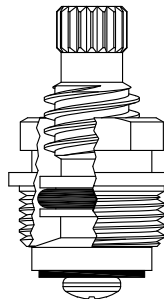

18
3-3

GASKET: 895100

LF450071
LF450072

FOR ELJER
LENGTH: 1.38"

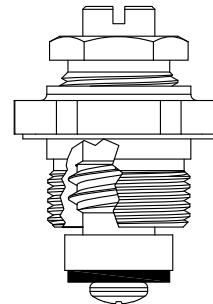

GASKET: 895100

400331
200331

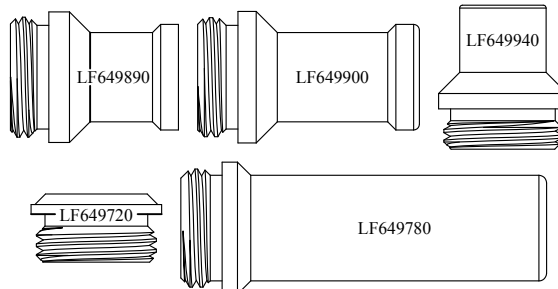

SEATS USED: LF649720,
LF649780, LF649890,
LF649900 or LF649940

FOR WEST BRASS (JAPAN)
LENGTH: 1.39"

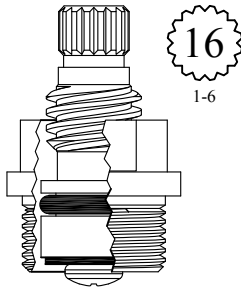

GASKET: 895100

LF450081
LF450082



SEAT USED: LF649600

FOR WEST BRASS (ITALY)
LENGTH: 1.39"

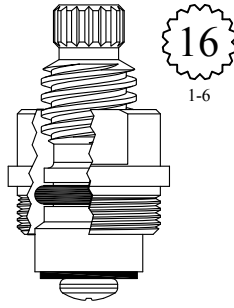

GASKET: 895100

LF450121
LF450122



SEAT USED: LF649600

Ceramic Conversion for:
Aqua-Seal

FOR AM STD
LENGTH: 1.39"

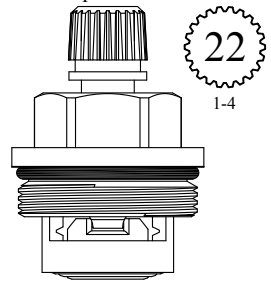

GASKET: 890180 O-RING INCLUDED

SEAL: 898500

DISC SET: 112530-PKG

LF450931
LF450932

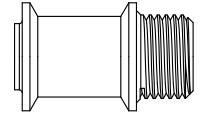

SEAT INCLUDED: LF646950

FOR ARTISTIC BRASS
LENGTH: 1.40"

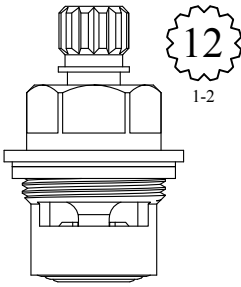

SEAL: 898500
DISC SET: 112530-PKG

LF450941
LF450942

FOR BRIGGS
LENGTH: 1.40"

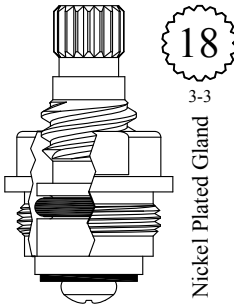

GASKET: 895100

LF452031
LF452032



SEAT USED: LF648120

FOR PRICE PFISTER
LENGTH: 1.41"

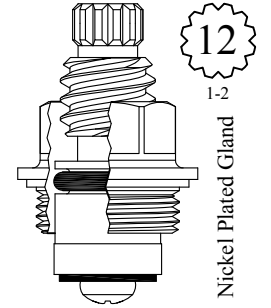

GASKET: 895100

LF451031
LF451032

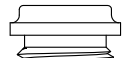

SEAT USED: LF648270

FOR INDIANA
LENGTH: 1.41"

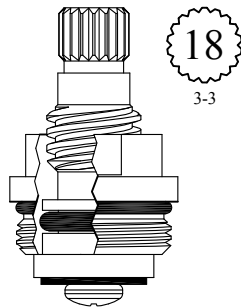

GASKET: 890170 O-RING INCLUDED

LF451121
LF451122

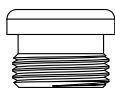

SEAT USED: LF648560

FOR PRICE PFISTER
LENGTH: 1.42"

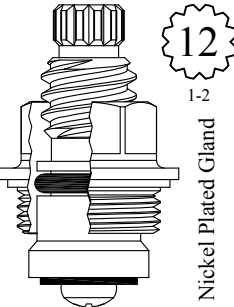

GASKET: 895100

LF451041
LF451042

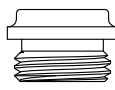

SEAT USED: LF648270

FOR ARROWHEAD
LENGTH: 1.43"

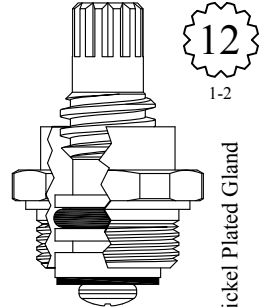

GASKET: 895100

LF452021
LF452022



SEAT USED: LF648230

FOR MILWAUKEE
LENGTH: 1.43"

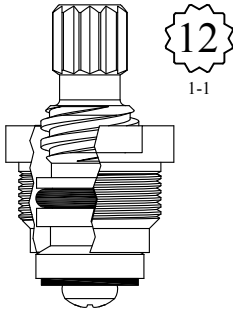

GASKET: 895100

LF451301
LF451302

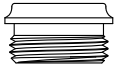

SEAT USED: LF649040

FOR CRANE
LENGTH: 1.43"

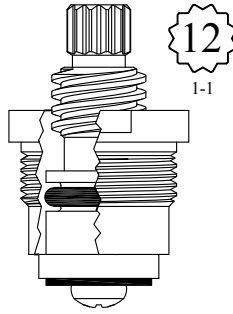

GASKET: 895180

LF451021
LF451022

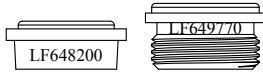

SEAT USED: LF648200 or LF649770

FOR ELJER
LENGTH: 1.44"

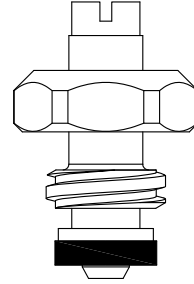

400251

FOR CRANE
LENGTH: 1.44"

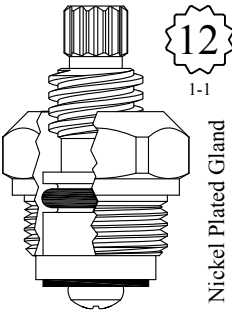

GASKET: 895100

LF451061
LF451062



SEAT USED: LF649430

FOR CENTRAL
LENGTH: 1.44"

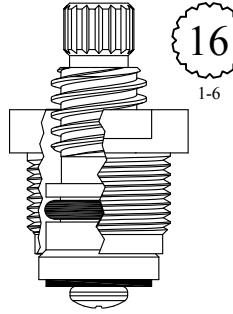

GASKET: 895100

LF451071
LF451072

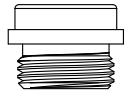

SEAT USED: LF648550

FOR ROYAL BRASS
LENGTH: 1.44"

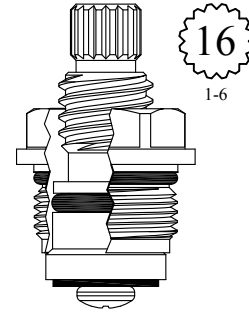

GASKET: 890160 O-RING INCLUDED

LF451131
LF451132

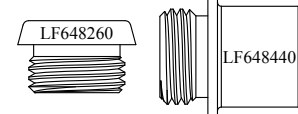

SEAT USED: LF648260 or LF648440

FOR DICK BROS.
LENGTH: 1.45"

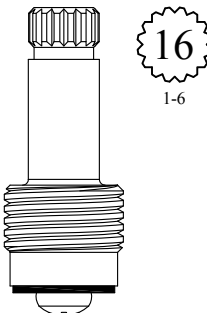

LF253011
LF253012



SEAT USED: LF649760

FOR GERBER
LENGTH: 1.45"

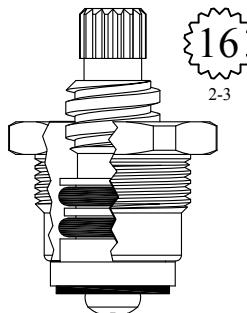

GASKET: 895150

LF451051
LF451052



SEAT USED: LF649150

FOR HARCRAFT
LENGTH: 1.45"

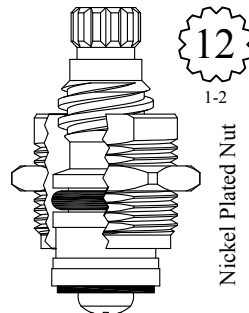

GASKET: 895040

LF451101

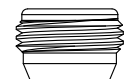

SEAT USED: LF648670

FOR HARCRAFT
LENGTH: 1.45"

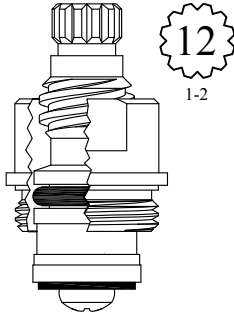

GASKET: 895100

LF451241
LF451242

FOR GERBER
LENGTH: 1.45"

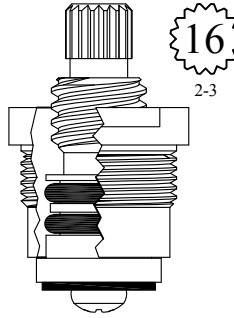

GASKET: 895150

LF451251
LF451252

FOR UNION BRASS
LENGTH: 1.45"

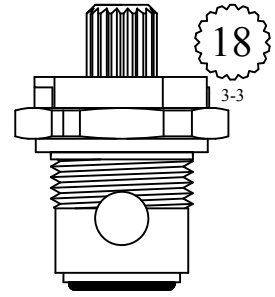

GASKET: 895100

LF452121
LF452122



SEAT USED: LF649150

FOR STERLING FAUCET
LENGTH: 1.46"

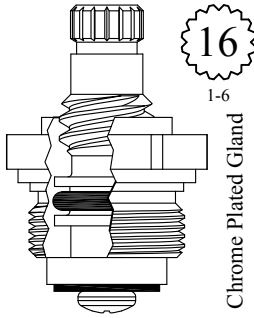

400511
400512



SEAT USED: LF648170

FOR ARROWHEAD
LENGTH: 1.46"

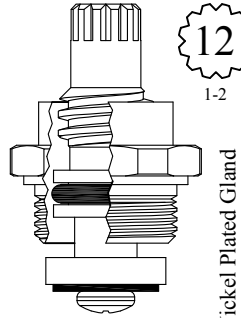

GASKET: 895100

LF450101
LF450102

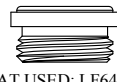

SEAT USED: LF648230

FOR INDIANA
LENGTH: 1.46"

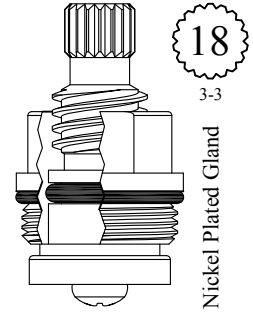

GASKET: 890180 O-RING INCLUDED

LF451141
LF451142

FOR BARNES
LENGTH: 1.47"

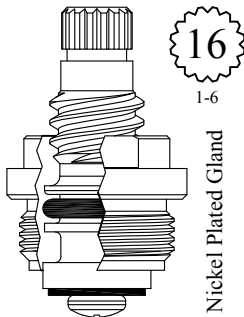

GASKET: 895100

LF452051
LF452052

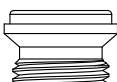

SEAT USED: LF648350

FOR MANSFIELD
LENGTH: 1.48"

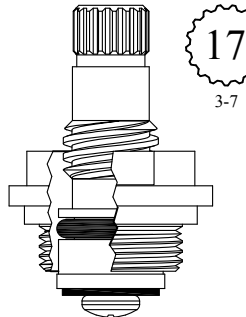

GASKET: 895100

LF450981
LF450982

FOR SPEAKMAN
LENGTH: 1.48"

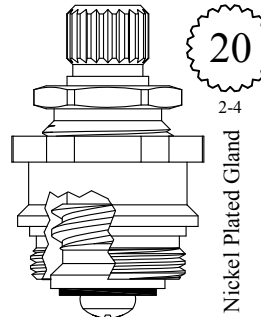

GASKET: 895150

LF451081
LF451082

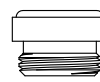

SEAT USED: LF648760

FOR PHOENIX
LENGTH: 1.49"

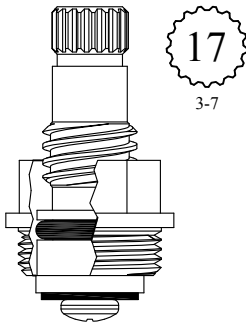

17
3-7

GASKET: 895100

400431

FOR SAYCO
LENGTH: 1.49"

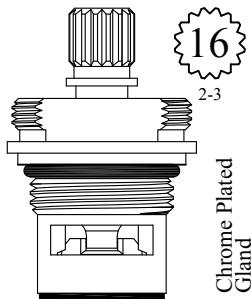

16
2-3

Chrome Plated
Gland

GASKET: 890170 O-RING INCLUDED

SEAL: 898540

DISC SET: 112530-PKG

LF451231
LF451232

FOR WATER SAVER
LENGTH: 1.50"

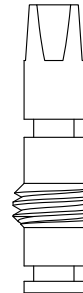

LF251341

FOR SEARS
LENGTH: 1.50"

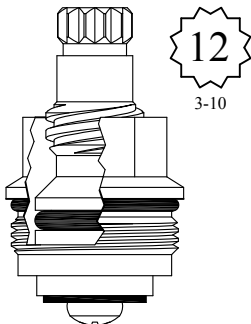

12
3-10

GASKET: 890180 O-RING INCLUDED

LF451091
LF451092

FOR CENTRAL
LENGTH: 1.50"

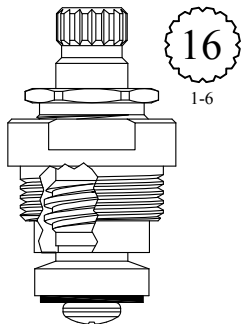

16
1-6

GASKET: 895100

LF452041
LF452042

UNKNOWN
LENGTH: 1.52"

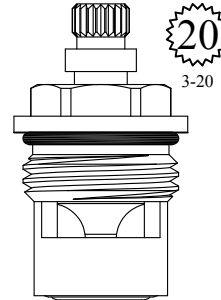

20
3-20

GASKET: 890170 O-RING INCLUDED

SEAL: 898500

DISC SET: 112530-PKG

LF450991
LF450992

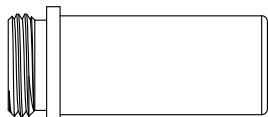

SEAT USED: LF648900



SEAT USED: LF648550

FOR PRICE PFISTER
LENGTH: 1.53"

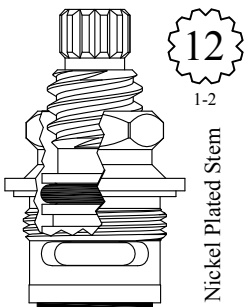

12
1-2

Nickel Plated
Stem

GASKET: 895100

LF450951
LF450952

FOR ARTISTIC BRASS
LENGTH: 1.53"

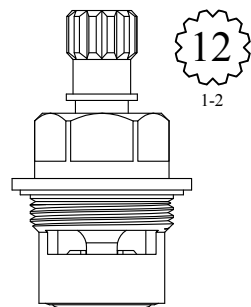

12
1-2

SEAL: 898500
DISC SET: 112530-PKG

LF451191
LF451192

FOR STERLING FAUCET
LENGTH: 1.54"

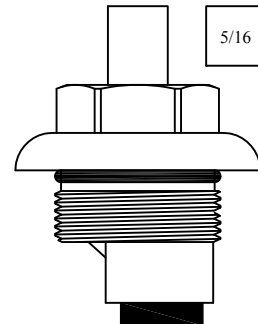

5/16

All Plastic
Unit

GASKET: 890180 O-RING INCLUDED

452290

FOR T & S
LENGTH: 1.55"

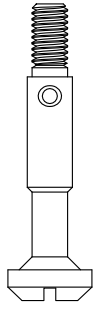

LF107910

UNKNOWN
LENGTH: 1.54"

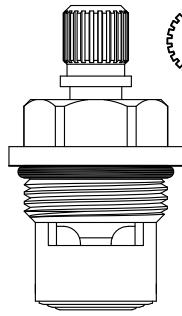

24
3-18

Chrome Plated Unit

GASKET: 890170 O-RING INCLUDED
SEAL: 898500
DISC SET: 112530-PKG

LF451201
LF451202

Single Lead
FOR PHOENIX
LENGTH: 1.55"

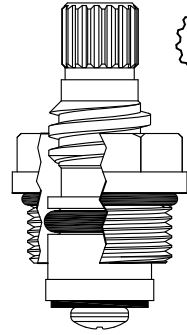

17
3-7

GASKET: 890170 O-RING INCLUDED

LF451211
LF451212



SEAT USED: LF648040

FOR PHOENIX
LENGTH: 1.55"

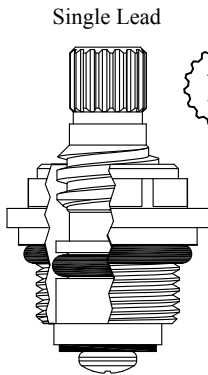

Single Lead

17
3-7

GASKET: 891150 O-RING INCLUDED

LF451221
LF451222



SEAT USED: LF649190

FOR AM BRASS
LENGTH: 1.55"

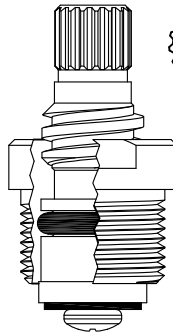

17
3-7

18 TPI Gland

GASKET: 895100

LF451111
LF451112

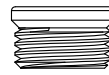

SEAT USED: LF648410

FOR STREAMWAY
LENGTH: 1.55"

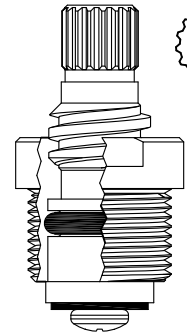

17
3-7

20 TPI Gland

GASKET: 895100

LF451161
LF451162



SEAT USED: LF649190

FOR AM BRASS
LENGTH: 1.55"

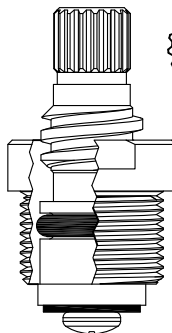

17
3-7

20 TPI Gland

GASKET: 895100

LF451161
LF451162

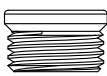

SEAT USED: LF648410

FOR PHOENIX
FOR STREAMWAY
LENGTH: 1.55"



17
3-7

Double Lead

GASKET: 890170 O-RING INCLUDED

LF451171
LF251111 Stem Only



SEAT USED: LF649190

FOR PHOENIX
LENGTH: 1.55"



17
3-7

Single Lead

GASKET: 890170 O-RING INCLUDED

LF451181



SEAT USED: LF649190

FOR STERLING FAUCET
LENGTH: 1.55"

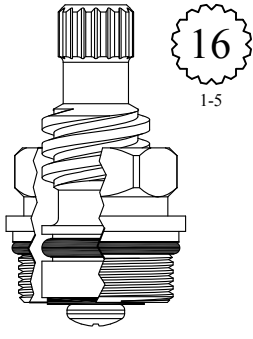

GASKET: 890180 O-RING INCLUDED

LF451401
LF451402

FOR AM BRASS
LENGTH: 1.55"

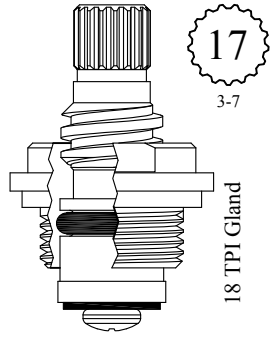

GASKET: 895100

LF452071
LF452072



SEAT USED: LF648410

FOR STREAMWAY
LENGTH: 1.55"

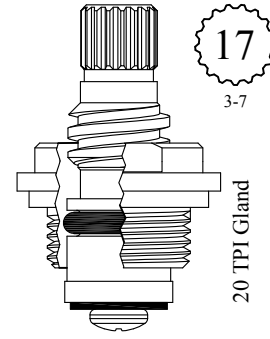

GASKET: 895100

LF452171
LF452172



SEAT USED: LF649190

FOR YUGO
LENGTH: 1.56"

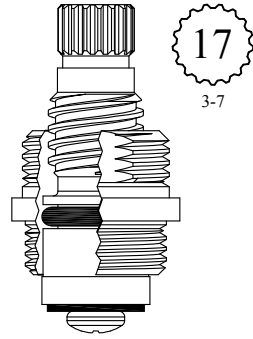

GASKET: 895100

LF452191
LF452192

FOR STERLING FAUCET
LENGTH: 1.56"

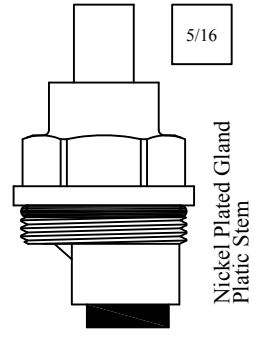

GASKET: 890180 O-RING INCLUDED

LF452300
252300 Stem Only

FOR BORG-WARNER
FOR GRAND HAVEN
LENGTH: 1.56"

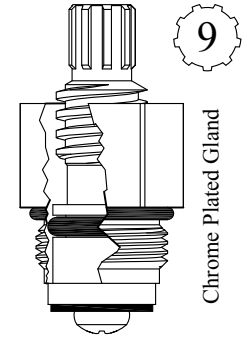

GASKET: 890160 O-RING INCLUDED

LF452861



SEAT USED: LF649050

FOR CRANE
LENGTH: 1.57"

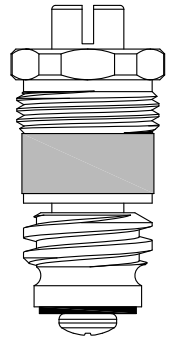

452821
252821 Stem Only

FOR AUBURN BRASS
LENGTH: 1.57"

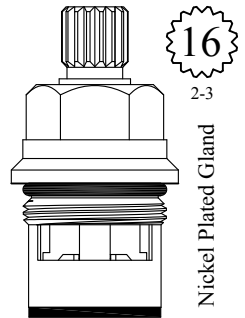

GASKET: 890160 O-RING INCLUDED
SEAL: 893030
DISC SET: 151380-PKG

LF450901
LF450902

FOR GLACIER BAY
LENGTH: 1.58"

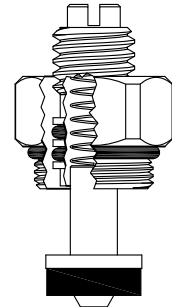

GASKET: 890150 O-RING INCLUDED

400231

FOR BURLINGTON
LENGTH: 1.58"

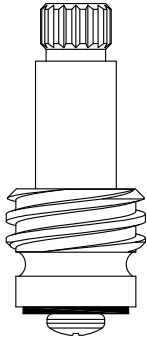

16
1-6

LF253061
LF253062



SEAT USED: LF648700

FOR DICK BROS.
LENGTH: 1.59"

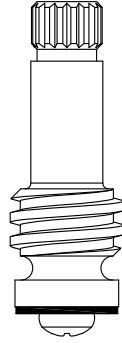

16
1-6

LF253161
LF253162

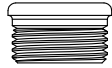

SEAT USED: LF649760

UNKNOWN
LENGTH: 1.59"

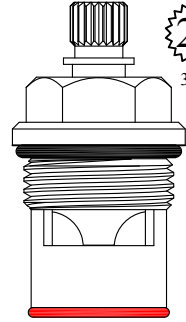

20
3-20

GASKET: 890170 O-RING INCLUDED
SEAL: 898580-R/B
DISC SET: 151380-PKG

LF451261
LF451262

FOR AM STD
LENGTH: 1.59"

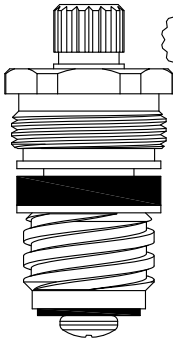

16

LF452011
LF452012
LF252081 Stem Only
LF252082 Stem Only



SEAT USED: LF648350

FOR AM STD
LENGTH: 1.59"

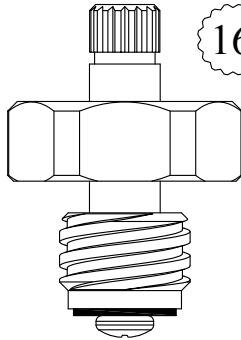

16

LF452081
LF452082
LF252081 Stem Only
LF252082 Stem Only



SEAT USED: LF648350

FOR ADVANCED TABCO
LENGTH: 1.60"

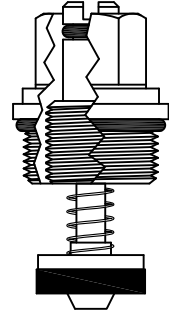

GASKET: 890170 O-RING INCLUDED

400241

FOR MIXET
LENGTH: 1.60"

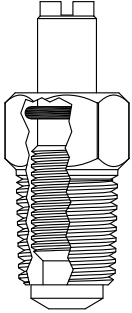

400721

Single Lead

FOR DICK BROS.
LENGTH: 1.60"

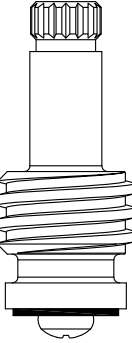

16
1-6

LF252251

Double Lead

FOR DICK BROS.
LENGTH: 1.60"

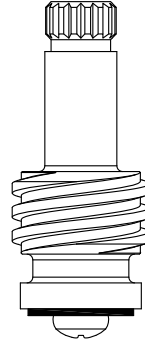

16
1-6

LF253151
LF253152

Gland turns
clockwise
into valve body

FOR CHG
FOR ADVANCED TABCO
LENGTH: 1.61"

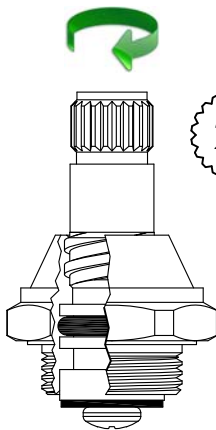

20
2-4

Chrome Plated Unit

GASKET: 895100

LF455411
LF455412



SEAT USED: LF648270

Gland turns
counter-clockwise
into valve body

FOR CHG
FOR ADVANCED TABCO
LENGTH: 1.61"

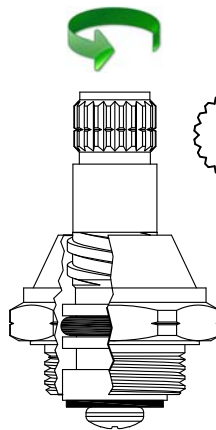

20
2-4

Chrome Plated Unit

GASKET: 895100

LF455462



SEAT USED: LF648270

FOR ELJER
LENGTH: 1.62"

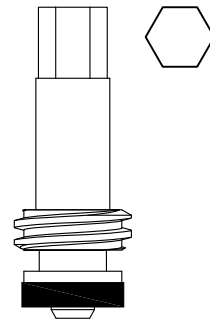

200351

FOR DICK BROS.
LENGTH: 1.62"

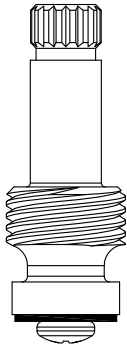

16
1-6

LF252151
LF252152

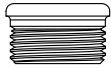

SEAT USED: LF649760

FOR AM STD
LENGTH: 1.62"

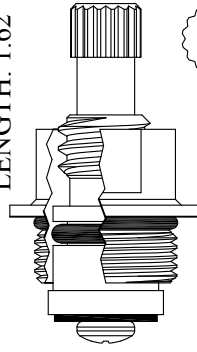

16

Nickel Plated Gland

GASKET: 890160 O-RING INCLUDED

LF453041
LF453042

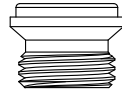

SEAT USED: LF648350

FOR SEARS
LENGTH: 1.63"

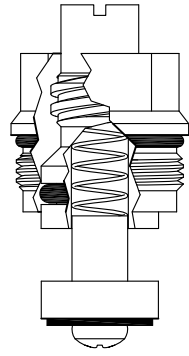

GASKET: 890180 O-RING INCLUDED

400261

FOR PRICE PFISTER
LENGTH: 1.63"

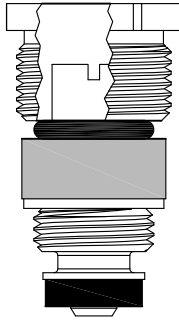

400301
200301 Stem Only

FOR PRICE PFISTER
LENGTH: 1.63"

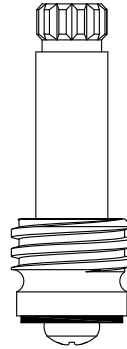

12
1-2

LF252401

FOR SPEAKMAN
LENGTH: 1.63"

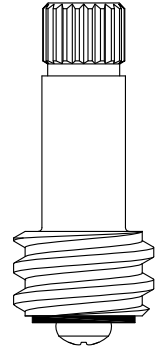

20
2-4

LF253071
LF253072

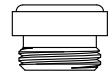

SEAT USED: LF648760

FOR PRICE PFISTER
LENGTH: 1.63"

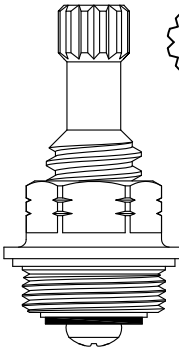

12
1-2

GASKET: 895100
SEAT INCLUDED: LF648310

LF451001

UNKNOWN
LENGTH: 1.63"

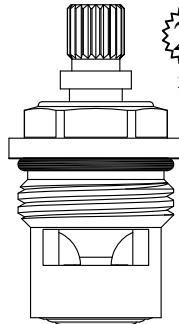

20
3-20

GASKET: 890170 O-RING INCLUDED
SEAL: 898500
DISC SET: 112530-PKG

LF451281
LF451282

FOR SAVOY
LENGTH: 1.63"

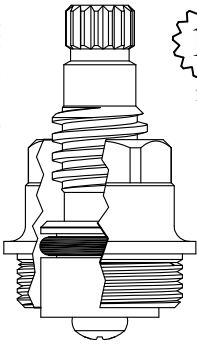

15
1-13

Chrome Plated Gland

GASKET: 895150

LF452201
LF452202



SEAT USED: LF649740

FOR SAVOY
LENGTH: 1.63"

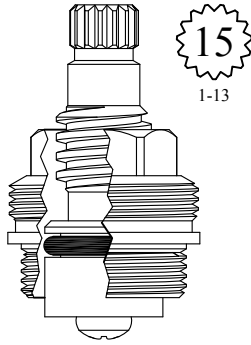

GASKET: 895150

LF452211
LF452212

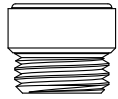

SEAT USED: LF649740

FOR BRIGGS
LENGTH: 1.63"

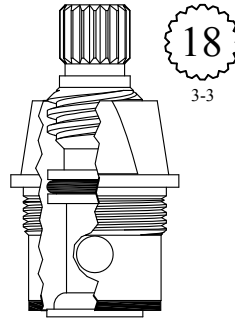

GASKET: 895100

LF453031
LF453032

FOR PRICE PFISTER
LENGTH: 1.63"

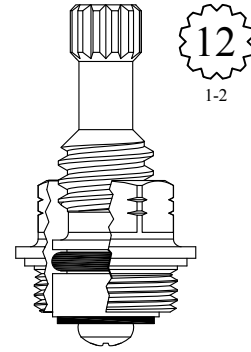

GASKET: 895100

LF453051
LF453052

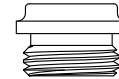

SEAT USED: LF648270

FOR SPEAKMAN
LENGTH: 1.64"

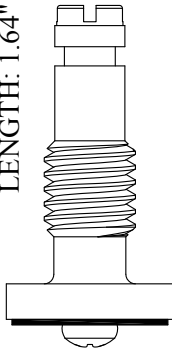

Chrome Plated Stem

252911

FOR MOEN
STEM LENGTH: 1.48"

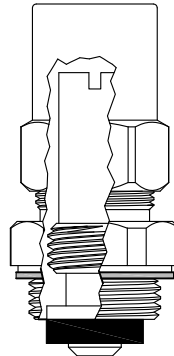

11/16-20 TPI Gland

GASKET: 895110 INCLUDED

400311

FOR MOEN
STEM LENGTH: 1.48"

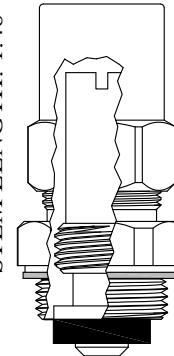

11/16-27 TPI Gland

GASKET: 895110 INCLUDED

400321

FOR MOEN
STEM LENGTH: 1.48"

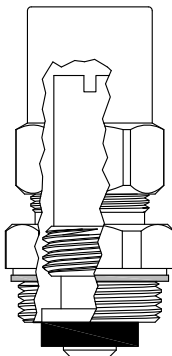

3/4-20 TPI Gland

GASKET: 895110 INCLUDED

400341

FOR WEST BRASS
LENGTH: 1.64"

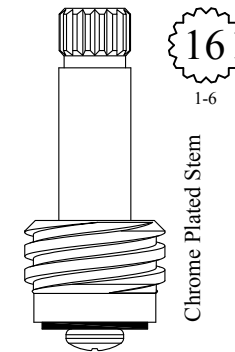

Chrome Plated Stem

LF252111
LF252112



SEAT USED: LF649600

FOR INDIANA
LENGTH: 1.64"

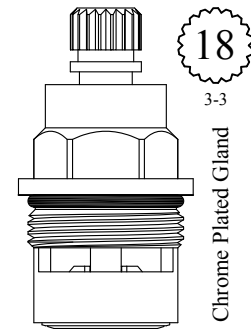

Chrome Plated Gland

GASKET: 890170 O-RING INCLUDED
SEAL: 898510-W
DISC SET: 151380-PKG

LF451901
LF451902

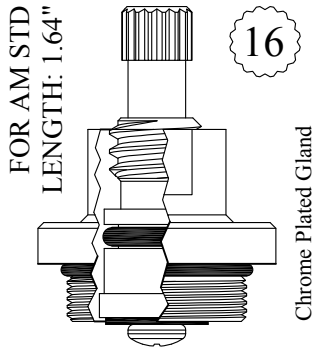

GASKET: 890200 O-RING INCLUDED

LF453141

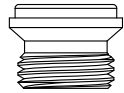

SEAT USED: LF648350

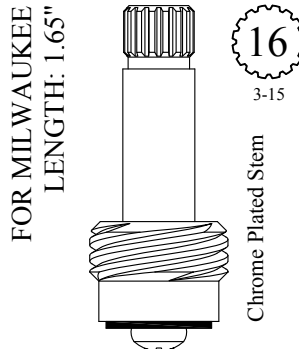

201211
201212



SEAT USED: 648370

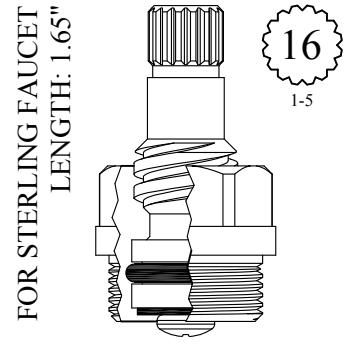

GASKET: 895160

LF452091
LF452092



SEAT USED: LF648170

Gland turns
clockwise
into valve body



Knurled lock ring also available

952900

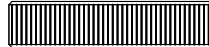

GASKET: 890170 O-RING INCLUDED

SEAL: 898570-R/B
DISC SET: 151380-PKG

LF452601
LF452602

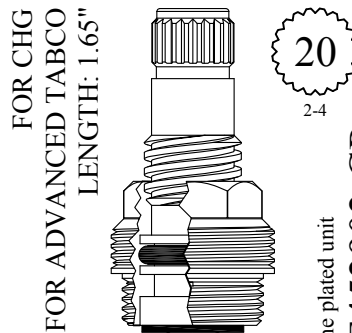

GASKET: 895100

LF452901
LF452902

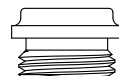

SEAT USED: LF648270

Also available as chrome plated unit
LF452901-CP/ LF452902-CP

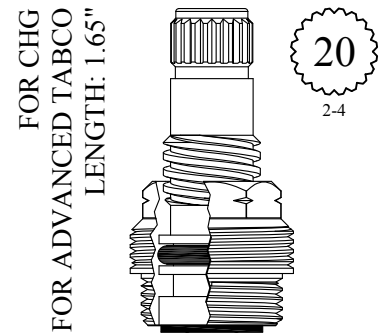

GASKET: 895100

LF452922

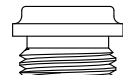

SEAT USED: LF648270

Gland turns
counter-clockwise
into valve body



FOR GERBER
LENGTH: 1.65"

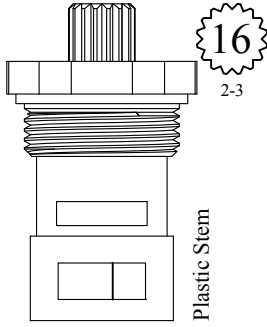

GASKET: 895150

LF453171
LF453172

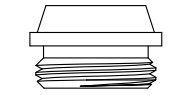

SEAT USED: LF649150

UNKNOWN
LENGTH: 1.66"

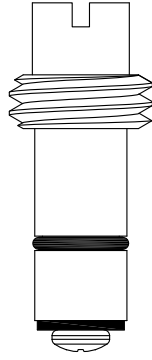

200611

FOR WILLOUGHBY
LENGTH: 1.66"

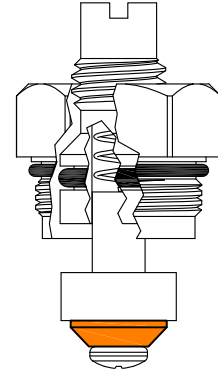

GASKET: 890190 O-RING INCLUDED

LF400451

FOR HARCRAFT
LENGTH: 1.67"

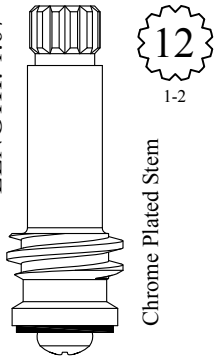

Chrome Plated Stem

LF254021
LF254022

FOR SUNRISE / PRO PLUS
LENGTH: 1.67"

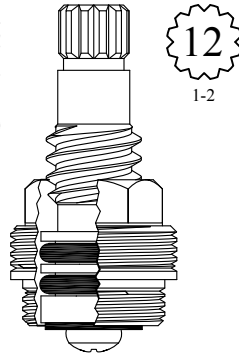

GASKET: 895100

LF453251
LF453252

UNKNOWN
LENGTH: 1.68"

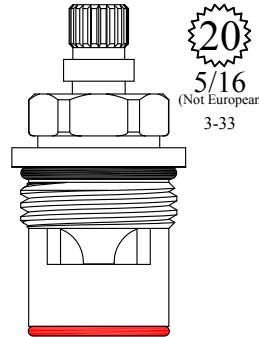

GASKET: 890170 O-RING INCLUDED
SEAL: 898580-R/B
DISC SET: 151380-PKG

LF452611
LF452612

FOR ADVANCED TABCO
LENGTH: 1.68"

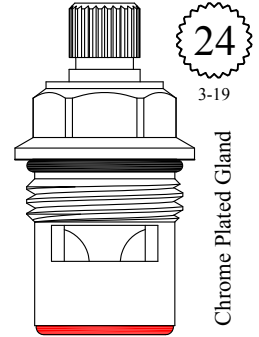

Chrome Plated Gland

GASKET: 890170 O-RING INCLUDED
SEAL: 898570-R/B
DISC SET: 151380-PKG

LF452621
LF452622

FOR CAMBRIDGE
LENGTH: 1.68"

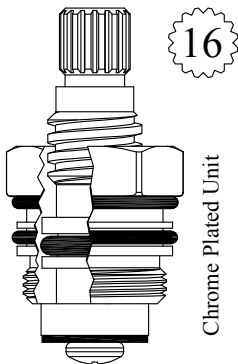

Chrome Plated Unit

GASKET: 890170 O-RING INCLUDED

LF452961
LF452962

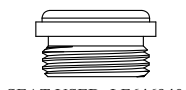

SEAT USED: LF646940

FOR AM STD
LENGTH: 1.69"

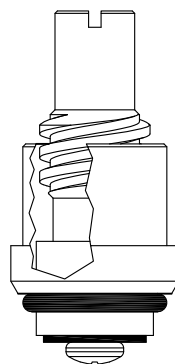

GASKET: 891130

453181
253181 Stem Only

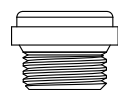

SEAT USED: LF648990

FOR MICHIGAN BRASS
LENGTH: 1.69"

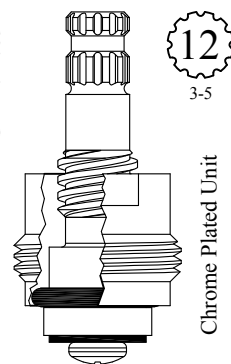

Chrome Plated Unit

GASKET: 891120 O-RING INCLUDED

400621
400622

FOR STERLING FAUCET
LENGTH: 1.69"

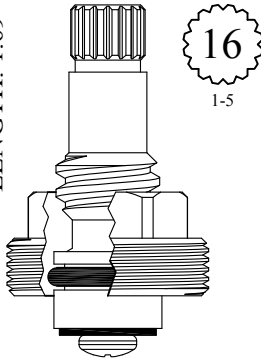

16
1-5

400711
400712

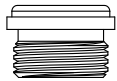

SEAT USED: LF648170

UNKNOWN
LENGTH: 1.69"

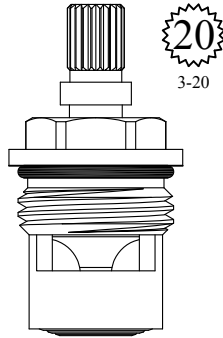

20
3-20

GASKET: 890170 O-RING INCLUDED
SEAL: 898500
DISC SET: 112530-PKG

LF452381
LF452382

Also available with locknut:
LF453091-N / LF453092-N

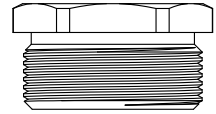

FOR AM STD
LENGTH: 1.69"

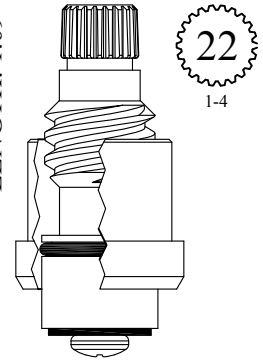

22
1-4

GASKET: 891130

LF453091
LF453092

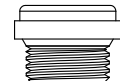

SEAT USED: LF648990

FOR AM STD
LENGTH: 1.69"

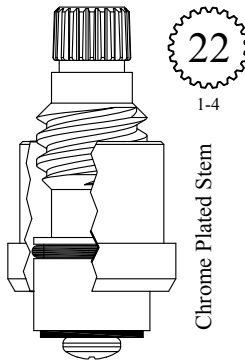

22
1-4

Chrome Plated Stem

GASKET: 891130

LF453101
LF453102

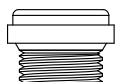

SEAT USED: LF648990

FOR AM STD
LENGTH: 1.69"

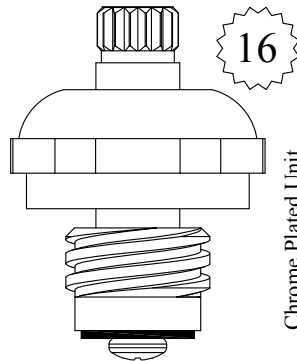

16

Chrome Plated Unit

LF454011
LF454012
LF254011 Stem Only
LF254012 Stem Only



SEAT USED: LF648100

FOR ACORN
LENGTH: 1.70"

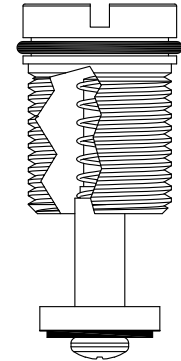

LF400190

FOR MIXET
LENGTH: 1.70"

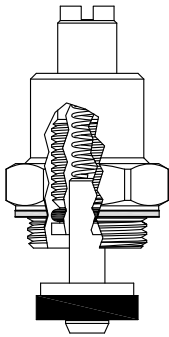

GASKET: 895060 INCLUDED

400371

FOR ROYAL BRASS
LENGTH: 1.70"

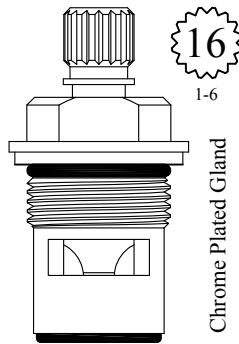

GASKET: 890160 O-RING INCLUDED
SEAL: 898540
DISC SET: 112530-PKG

Chrome Plated Gland

LF451501
LF451502

FOR EMCO
LENGTH: 1.70"

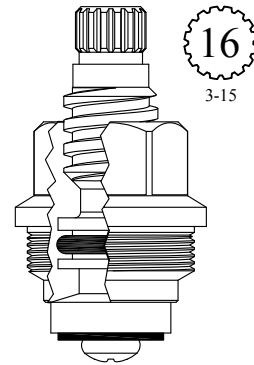

GASKET: 895180

LF452701
LF452702

Also available with
stainless steel knurled ring:
LF453021-SS / LF453022-SS
Also available with locknut:
LF453021-N / LF453022-N

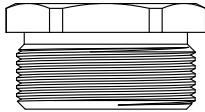

FOR AM STD
LENGTH: 1.70"

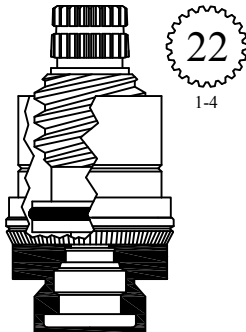

LF453021
LF453022



SEAT USED: LF648990

FOR URREA
LENGTH: 1.70"

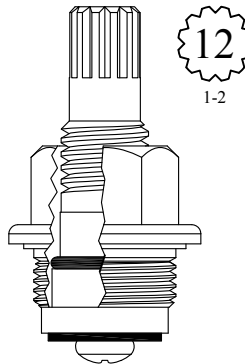

LF453401

FOR AM STD
LENGTH: 1.71"

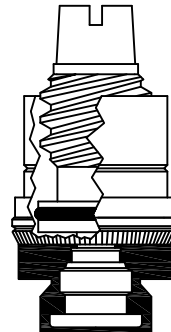

453191

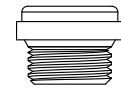

SEAT USED: LF648990

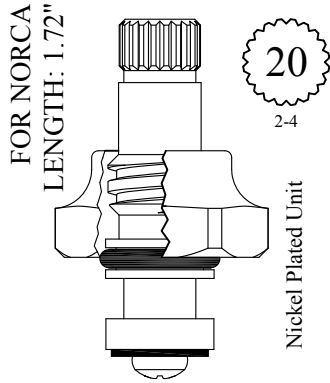

LF454181
LF454182

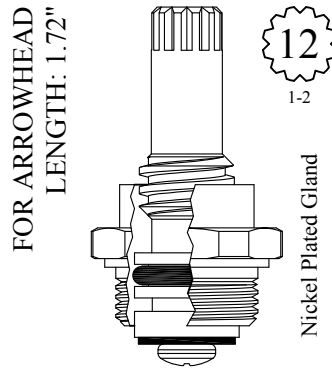

GASKET: 895100
LF454191
LF454192

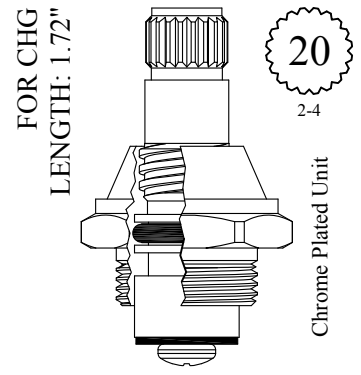

GASKET: 895100
LF455401
LF455402



Also available as chrome plated unit

400471-CP
200471-CP Stem Only

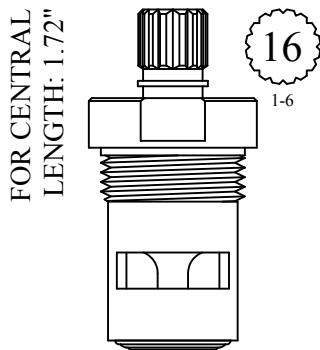

GASKET INCLUDED: 895270
SEAL: 898500
DISC SET: 112530-PKG
LF455901
LF455902

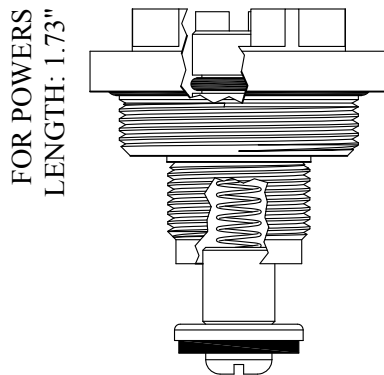

GASKET: 891230 O-RING INCLUDED
400471
200471 Stem Only
500470-KIT Retainer & Spring Only

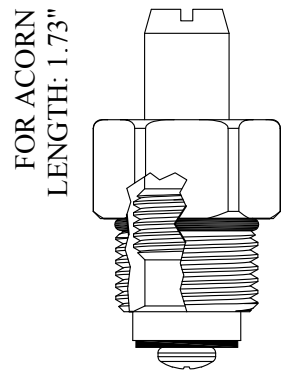

GASKET: 890160 O-RING INCLUDED
LF454071
LF254071 Stem Only

FOR PRICE PFISTER
LENGTH: 1.73"

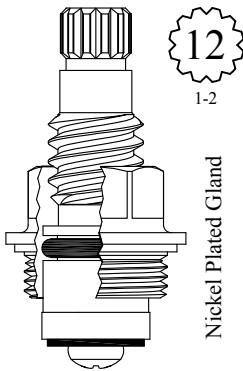

12
1/2

Nickel Plated Gland

GASKET: 895100

LF454121
LF454122



SEAT USED: LF648270

FOR SAYCO
LENGTH: 1.74"

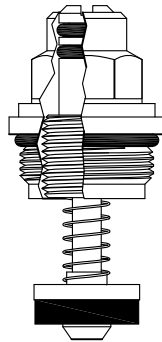

Nickel Plated Stem

GASKET: 890160 O-RING INCLUDED

400121

FOR AM STD
LENGTH: 1.74"

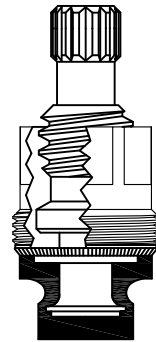

16

Special w/ Hex Gland

SEAT: LF647910
OR LF649650

452991

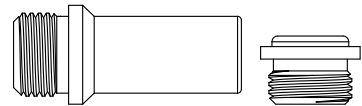

SEAT USED: LF647910 or LF649650

FOR SEARS
LENGTH: 1.74"

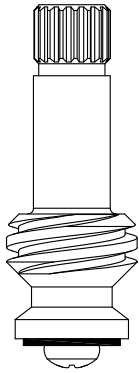

17
3-7

LF254141
LF254142



SEAT USED: LF648700

FOR AM STD
LENGTH: 1.74"

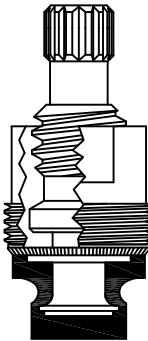

16

LF453001
LF453002

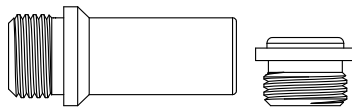

SEAT USED: LF647910 or LF649650

FOR MILWAUKEE
LENGTH: 1.74"

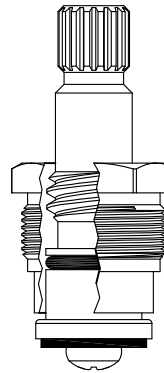

16
3-15

GASKET: 199930

LF453121
LF453122



SEAT USED: LF649040

FOR MILWAUKEE
LENGTH: 1.74"

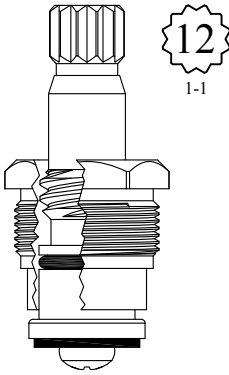

GASKET: 199930

LF453241
LF453242

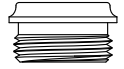

SEAT USED: LF649040

FOR CRANE
LENGTH: 1.74"

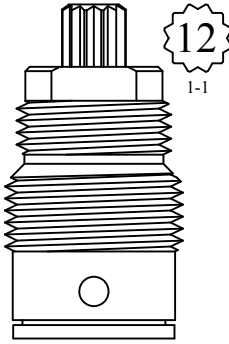

GASKET: 895250

LF453300

FOR INDIANA
LENGTH: 1.74"

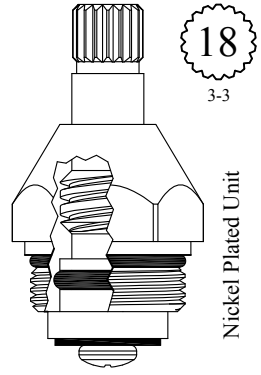

GASKET: 890170 O-RING INCLUDED

LF454031
LF454032

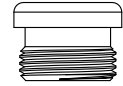

SEAT USED: LF648560

FOR STERLING FAUCET
LENGTH: 1.74"

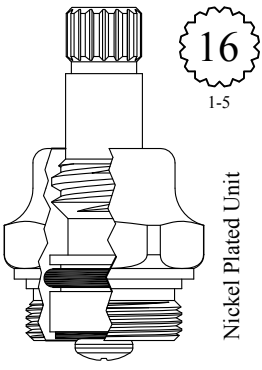

GASKET: 895160

LF455131
LF455132

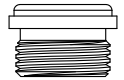

SEAT USED: LF648170

FOR SYMMONS
LENGTH: 1.75"



400661
200661 Stem Only

FOR STERLING FAUCET
LENGTH: 1.75"

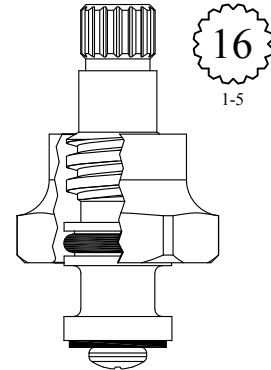

454241
454242

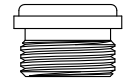

SEAT USED: LF648170

Also available as nickel plated unit
LF454111/ LF454112

FOR PRICE PFISTER
LENGTH: 1.75"

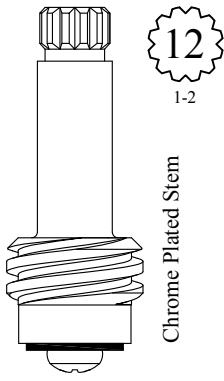

Chrome Plated Stem

LF255161
LF255162



SEAT USED: LF648270

FOR SPEAKMAN
LENGTH: 1.75"

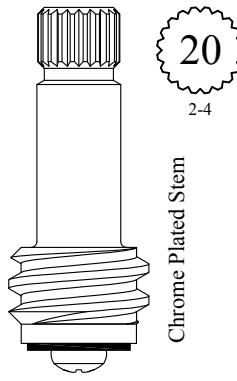

Chrome Plated Stem

LF256011
LF256012

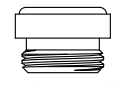

SEAT USED: LF648760

FOR GERBER
LENGTH: 1.75"

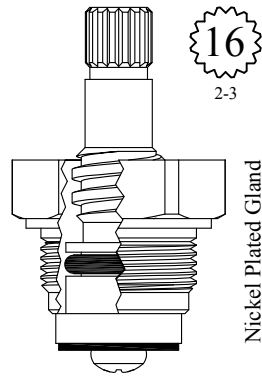

Nickel Plated Gland

GASKET: 895150

LF453111
LF453112

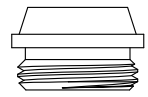

SEAT USED: LF649150

FOR ARROWHEAD
LENGTH: 1.75"

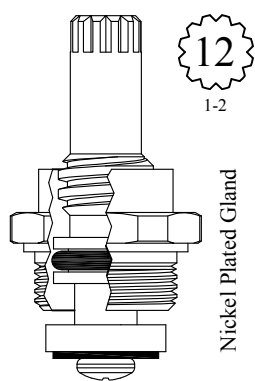

Nickel Plated Gland

GASKET: 895100

LF454091
LF454092

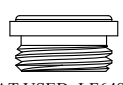

SEAT USED: LF648230

FOR BRIGGS
LENGTH: 1.75"

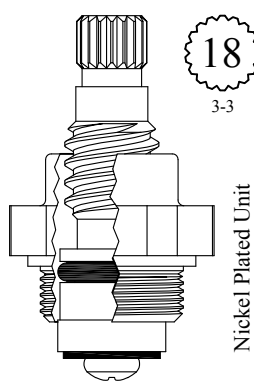

Nickel Plated Unit

GASKET: 895100

LF454101
LF454102

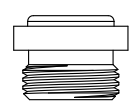

SEAT USED: LF648120

LENGTH: 1.75"

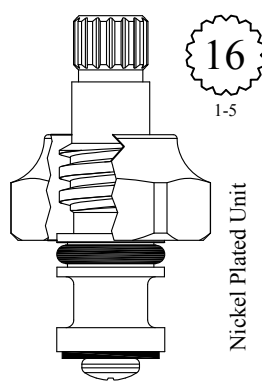

Nickel Plated Unit

LF454161
LF454162



SEAT USED: LF648170

FOR SEARS
LENGTH: 1.75"

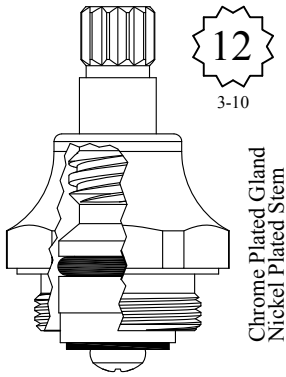

Chrome Plated Gland
Nickel Plated Stem

GASKET: 895150

LF454171
LF454172



SEAT USED: LF648700

FOR SEARS
LENGTH: 1.75"

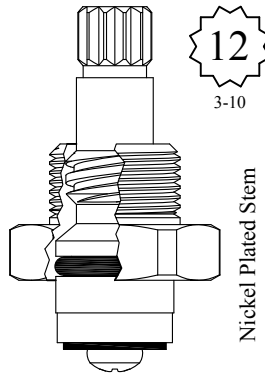

Nickel Plated Stem

LF454221
LF454222

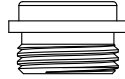

SEAT USED: LF648700

FOR SEARS
LENGTH: 1.75"

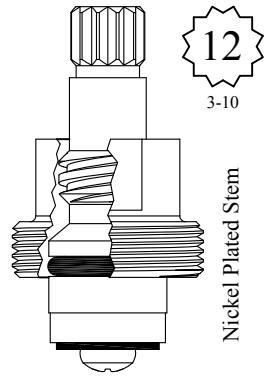

Nickel Plated Stem

LF454231
LF454232

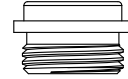

SEAT USED: LF648700

FOR STREAMWAY
LENGTH: 1.75"

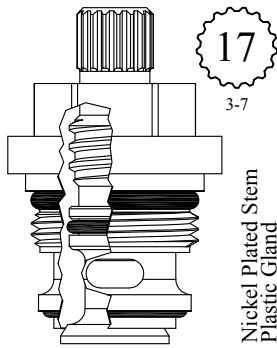

Nickel Plated Stem
Plastic Gland

GASKET: 891150 O-RING INCLUDED

LF454302

FOR UNION BRASS
LENGTH: 1.75"

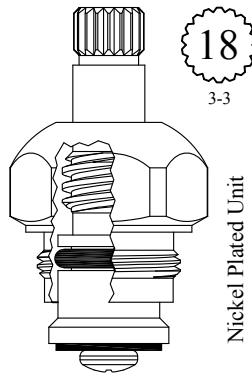

Nickel Plated Unit

GASKET: 895100

LF455011
LF455012

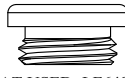

SEAT USED: LF648480

FOR SEARS
FOR MILWAUKEE
LENGTH: 1.75"

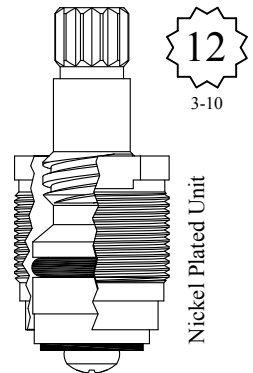

Nickel Plated Unit

GASKET: 894670

LF455021
LF455022



SEAT USED: LF648700

FOR STERLING FAUCET
LENGTH: 1.75"

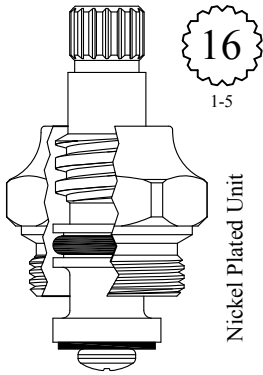

GASKET: 895160

LF455031
LF455032

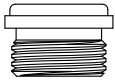

SEAT USED: LF648170

FOR SEARS
LENGTH: 1.75"

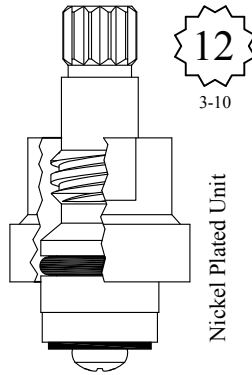

3-10

Nickel Plated Unit

LF455041
LF455042



SEAT USED: LF648700

FOR STERLING FAUCET
LENGTH: 1.75"

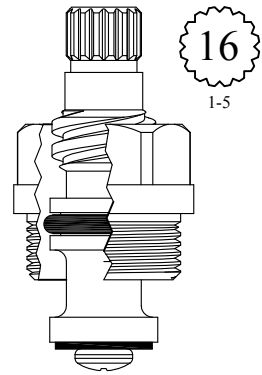

1-5

GASKET: 895160

LF455051
LF455052

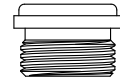

SEAT USED: LF648170

FOR STERLING FAUCET
LENGTH: 1.75"

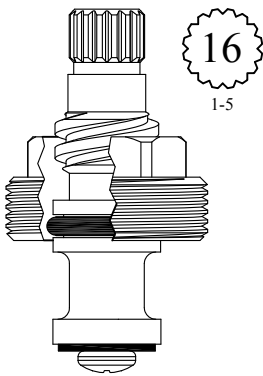

1-5

Chrome Plated Unit

LF455071
LF455072

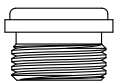

SEAT USED: LF648170

FOR AM STD
LENGTH: 1.75"

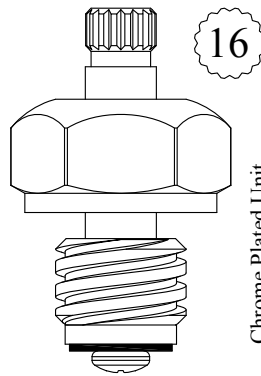

16

LF455081
LF455082
LF255081 Stem Only
LF255082 Stem Only

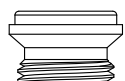

SEAT USED: LF648350

FOR MICHIGAN BRASS
LENGTH: 1.75"

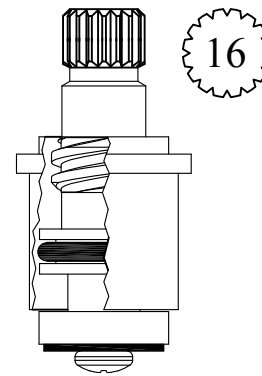

16

GASKET: 895140

LF455091
LF455092

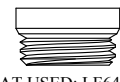

SEAT USED: LF648210

FOR DONNER
LENGTH: 1.75"

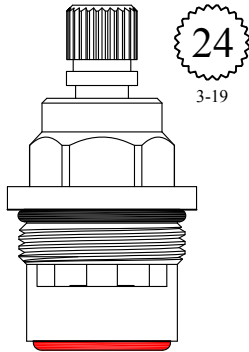

GASKET: 890180 O-RING INCLUDED
SEAL: 898570-R/B
DISC SET: 151380-PKG

LF455301
LF455302

FOR DONNER
LENGTH: 1.75"

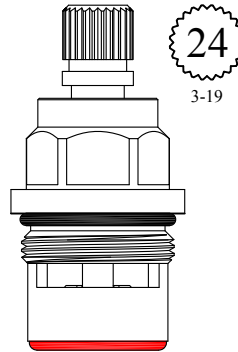

GASKET: 890170 O-RING INCLUDED
SEAL: 898570-R/B
DISC SET: 151380-PKG

LF455311
LF455312

UNKNOWN
LENGTH: 1.75"

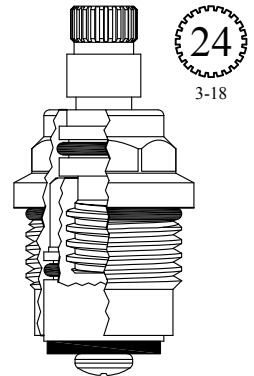

GASKET: 890170 O-RING INCLUDED

LF455422

FOR PRICE PFISTER
LENGTH: 1.76"

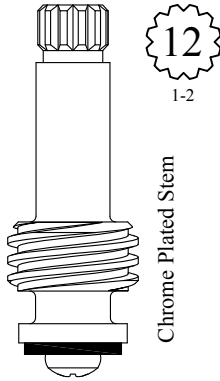

LF255061
LF255062



SEAT USED: LF648270

FOR GERBER
LENGTH: 1.76"

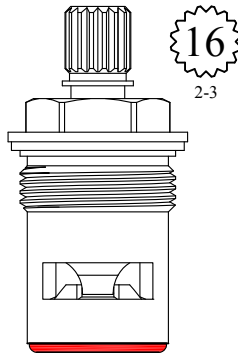

GASKET: 895140 INCLUDED
SEAL: 898570-R/B
DISC SET: 151380-PKG

LF455951
LF455952

FOR AM STD
LENGTH: 1.77"

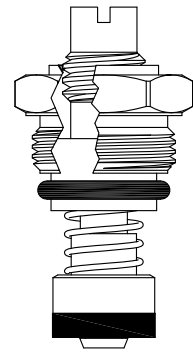

400171

FOR PRICE PFISTER
LENGTH: 1.77"

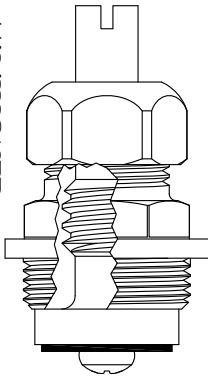

GASKET: 895400

400741
200741 Stem Only

FOR BARDES
LENGTH: 1.77"

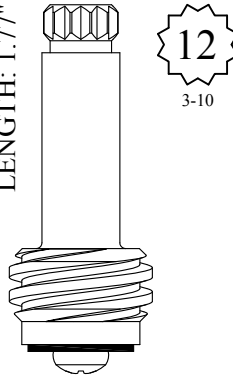

3-10

LF254001
LF254002

FOR STERLING FAUCET
LENGTH: 1.77"

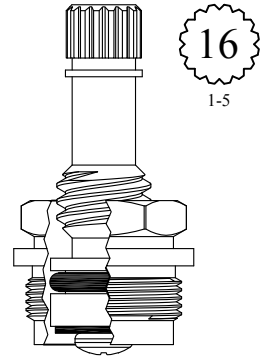

1-5

GASKET: 895160

LF452951
LF452952

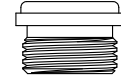

SEAT USED: LF648170

FOR BRADLEY
LENGTH: 1.78"

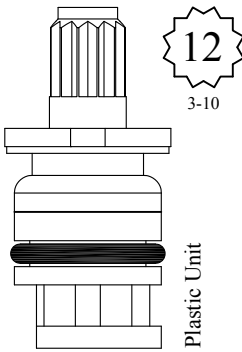

3-10

Plastic Unit

453201

FOR PRICE PFISTER
LENGTH: 1.78"

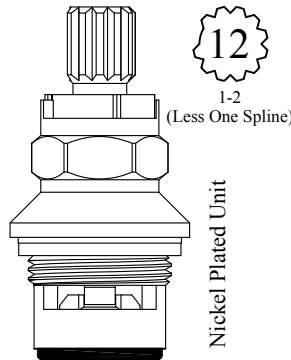

1-2
(Less One Spline)

Nickel Plated Unit

GASKET: 895190 INCLUDED
SEAL: 898540
DISC SET: 112530-PKG

LF452801
LF452802

FOR STERLING FAUCET
LENGTH: 1.78"

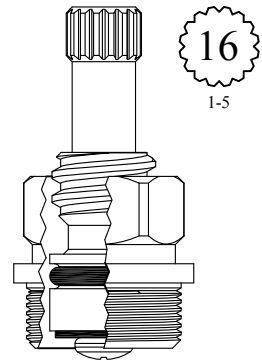

1-5

GASKET: 895160

LF453081
LF453082



SEAT USED: LF648170

UNKNOWN
LENGTH: 1.78"

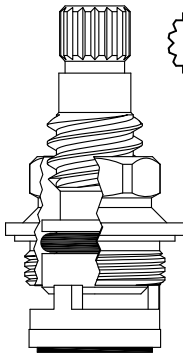

16
1-6

Nickel Plated Stem
Chrome Plated Gland

GASKET: 895100

LF455141
LF455142

UNKNOWN
LENGTH 1.78"

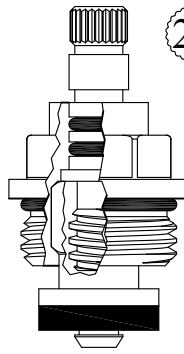

24

GASKET: 890170 O-RING INCLUDED

LF455942

FOR DELTA
LENGTH: 1.79"

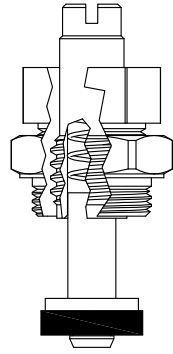

GASKET: 895060 INCLUDED

400151

FOR SEARS
LENGTH: 1.79"

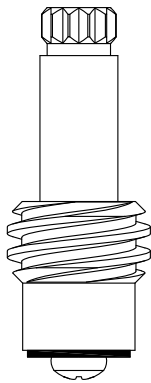

12
3-10

LF255101
LF255102

SEAT USED: LF648700

FOR MICHIGAN BRASS
LENGTH: 1.79"

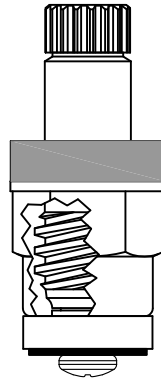

16

LF454151
LF454152

FOR MOEN
LENGTH: 1.79"

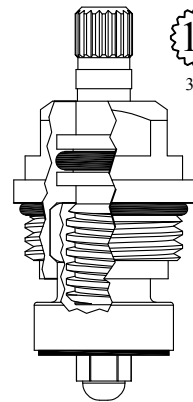

18
3-30

GASKET: 890180 O-RING INCLUDED

LF455362

FOR ELJER
LENGTH: 1.79"

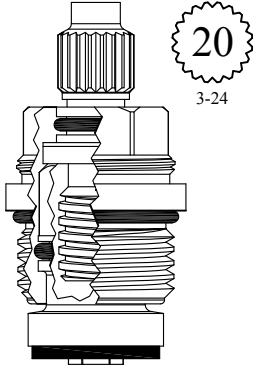

GASKET: 890170 O-RING INCLUDED

LF455962

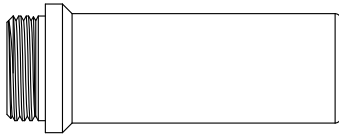

SEAT USED: LF647430

FOR MOEN
LENGTH: 1.80"

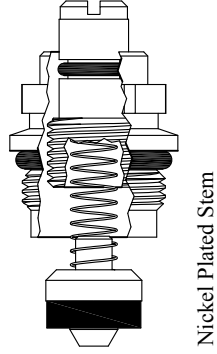

GASKET: 891140 O-RING INCLUDED

400421

FOR KOHLER
LENGTH: 1.80"

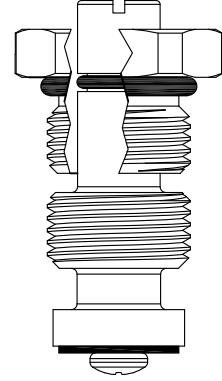

GASKET: 891140 O-RING INCLUDED

400921
200921 Stem Only

FOR BURLINGTON
LENGTH: 1.80"

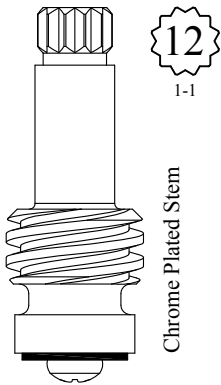

LF255111
LF255112

FOR PACIFICA
LENGTH: 1.80"

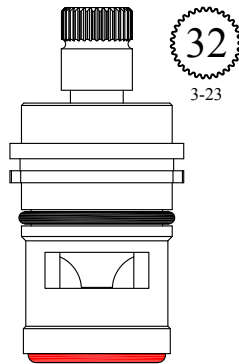

GASKET: 890170 O-RING INCLUDED
SEAL: 898570-R/B
DISC SET: 151380-PKG

LF456221
LF456222

FOR CUTHBERT
LENGTH: 1.80"

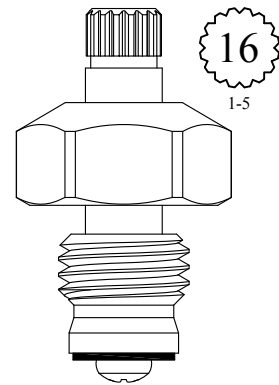

LF456971
LF256971 Stem Only

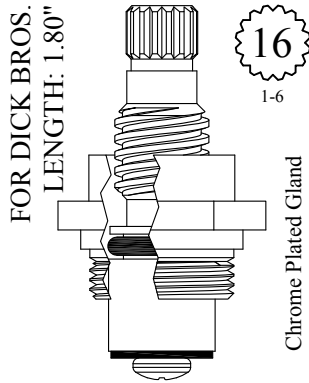

GASKET: 895100

LF457071
LF457072

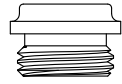

SEAT USED: LF648270

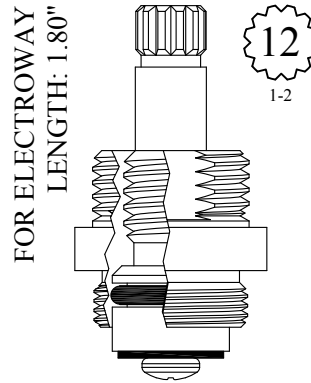

LF457141
LF457142

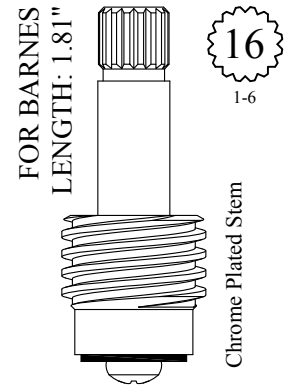

LF260131
LF260132



SEAT USED: LF648350

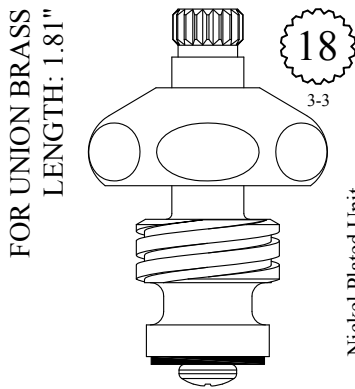

LF455121
LF455122
LF255121 Stem Only
LF255122 Stem Only



SEAT USED: LF648480

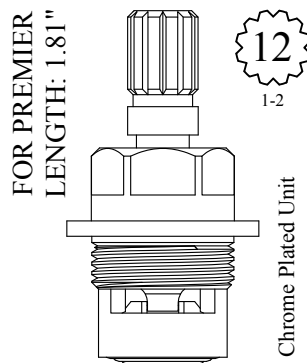

SEAL: 898500
DISC SET: 112530-PKG

LF455981
LF455982

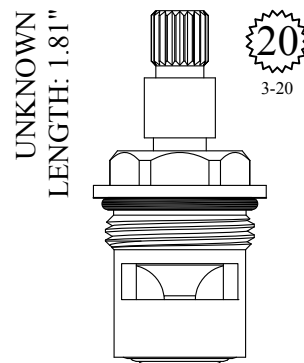

GASKET: 890170 O-RING INCLUDED

SEAL: 898500
DISC SET: 112530-PKG

LF456031
LF456032

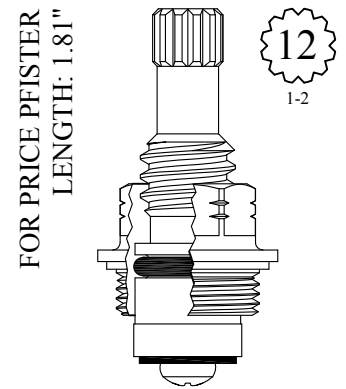

GASKET: 895100

LF456041

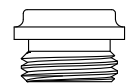

SEAT USED: LF648270

FOR GRAND HAVEN
LENGTH: 1.81"

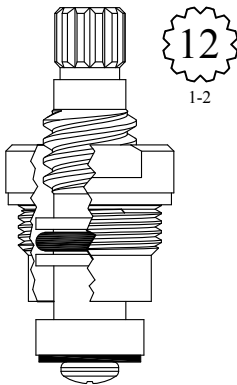

1-2

GASKET: 895100

LF456071
LF456072



SEAT USED: LF649270

FOR CRANE
LENGTH: 1.81"
STEM LENGTH: 1.00"

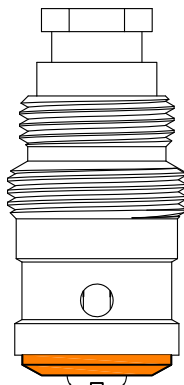

STEM LENGTH: 0.87"



Shorter version stem available

LF103990

GASKET: 895250

LF458700
LF258700 Stem Only

FOR LARDEN
LENGTH: 1.82"

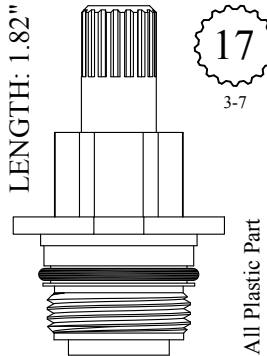

3-7

All Plastic Part

454351

FOR BARNES
LENGTH: 1.82"

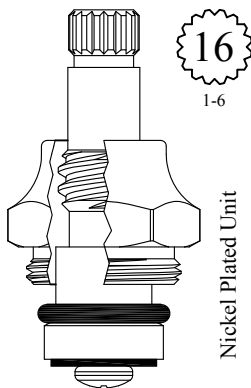

1-6

Nickel Plated Unit

LF456051
LF456052

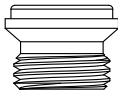

SEAT USED: LF648350

FOR SEARS
LENGTH: 1.83"

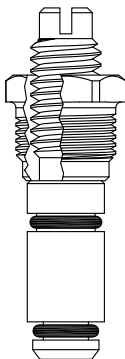

400361

IMPORT
LENGTH: 1.83"

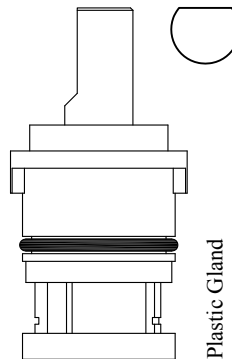

Plastic Gland

456211
456212

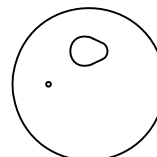

FOR GERBER
LENGTH: 1.83"

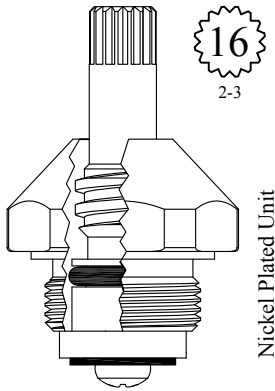

GASKET: 895150

LF454131
LF454132

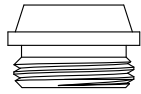

SEAT USED: LF649150

FOR KINGSBURY
LENGTH: 1.83"

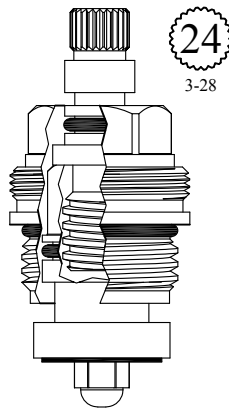

GASKET: 890170 O-RING INCLUDED

LF455972

FOR DICK BROS.
LENGTH: 1.84"

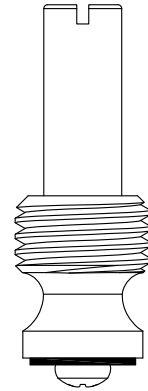

LF257001

FOR AM STD
LENGTH: 1.84"

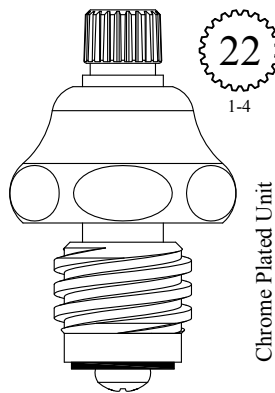

Chrome Plated Unit

LF456021
LF456022

LF256021 Stem Only

LF256022 Stem Only

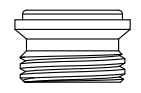

SEAT USED: LF648220

FOR ARROWHEAD
LENGTH: 1.84"

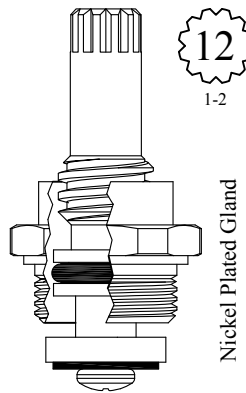

Nickel Plated Gland

GASKET: 895100

LF457031
LF457032



SEAT USED: LF648230

FOR DICK BROS.
LENGTH: 1.85"

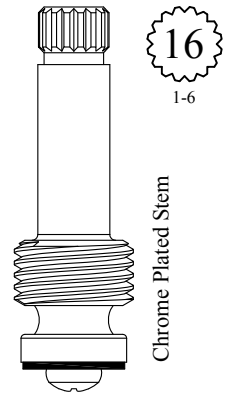

Chrome Plated Stem

LF257061
LF257062



SEAT USED: LF649760

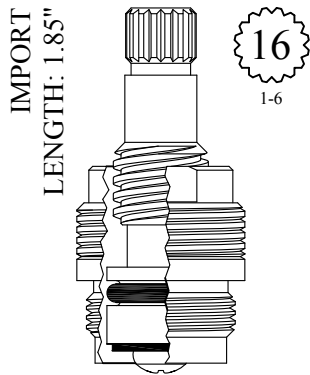

LF454051
LF454052

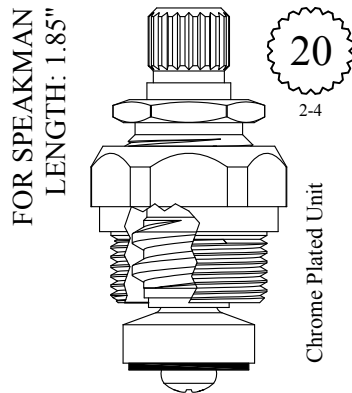

GASKET: 895150
LF456061
LF456062
LF256061 Stem Only
LF256062 Stem Only



SEAT USED: LF648930

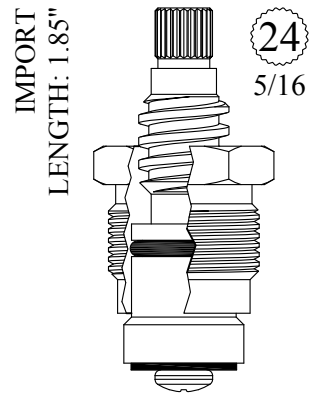

LF456141

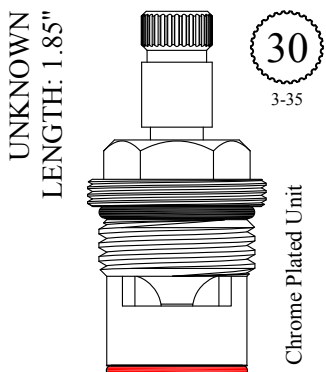

GASKET: 890170 O-RING INCLUDED
SEAL: 898580-R/B
DISC SET: 151380-PKG

LF456481
LF456482

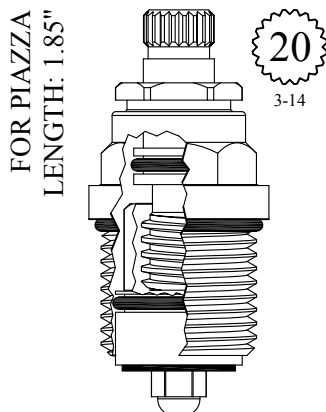

GASKET: 890180 O-RING INCLUDED

LF460802

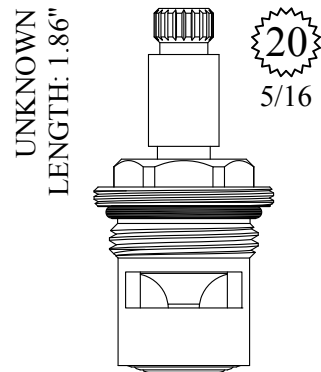

GASKET: 890170 O-RING INCLUDED
SEAL: 898500
DISC SET: 112530-PKG

LF456251
LF456252

UNKNOWN
LENGTH: 1.86"

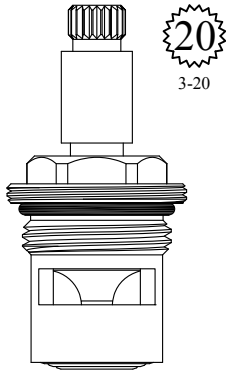

GASKET: 890170 O-RING INCLUDED
SEAL: 898500
DISC SET: 112530-PKG

LF456271
LF456272

UNKNOWN
LENGTH: 1.86"

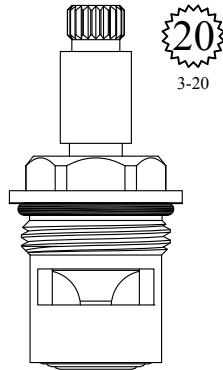

GASKET: 890170 O-RING INCLUDED
SEAL: 898500
DISC SET: 112530-PKG

LF456281
LF456282

UNKNOWN
LENGTH: 1.86"

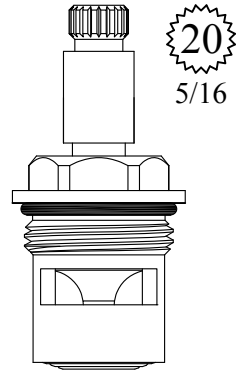

GASKET: 890170 O-RING INCLUDED
SEAL: 898500
DISC SET: 112530-PKG

LF456291
LF456292

FOR SAYCO
LENGTH: 1.87"

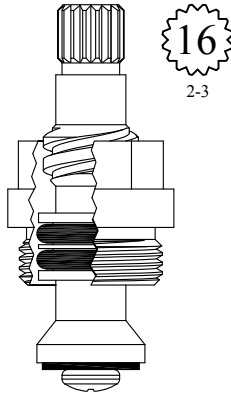

GASKET: 895100

LF456081
LF456082



SEAT USED: LF647450

FOR T & S
LENGTH: 1.87"

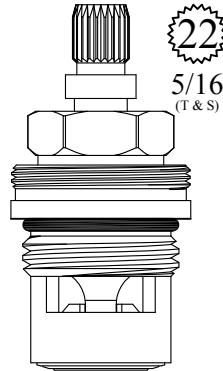

GASKET: 890170 O-RING INCLUDED
SEAL: 898500
DISC SET: 112530-PKG

LF456261
LF456262

FOR AM STD
LENGTH: 1.87"

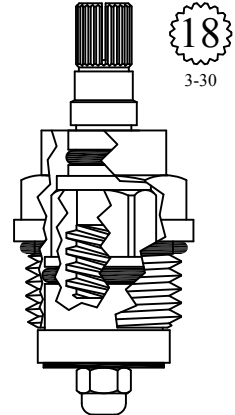

GASKET: 890180 O-RING INCLUDED

LF456302

FOR AM STD
LENGTH: 1.87"

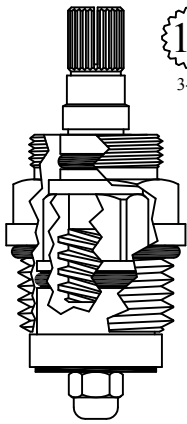

18
3-30

GASKET: 890180 O-RING INCLUDED

LF456312

FOR GLACIER BAY
LENGTH: 1.87"

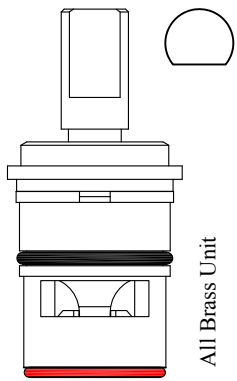

GASKET: 890170 O-RING INCLUDED
SEAL: 898580-R/B
DISC SET: 151380-PKG

LF456341
LF456342

FOR MOUNTAIN
LENGTH: 1.87"

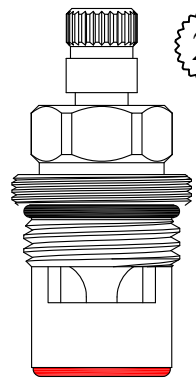

24
3-19

GASKET: 890170 O-RING INCLUDED
SEAL: 898570-R/B
DISC SET: 151380-PKG

LF456371
LF456372

UNKNOWN
LENGTH: 1.87"

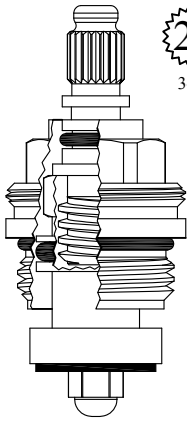

20
3-20

GASKET: 890170 O-RING INCLUDED

LF456462

FOR AM KITCHEN
LENGTH: 1.87"

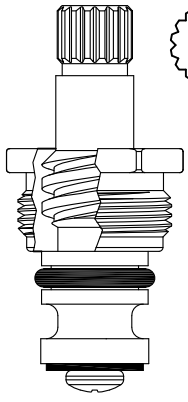

16
1-5

LF457091
LF457092

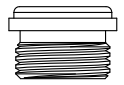

SEAT USED: LF648170

FOR MOUNTAIN
LENGTH: 1.87"

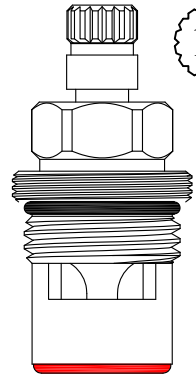

16
1-6

GASKET: 890170 O-RING INCLUDED
SEAL: 898570-R/B
DISC SET: 151380-PKG

LF456381
LF456382

UNKNOWN
LENGTH: 1.87"

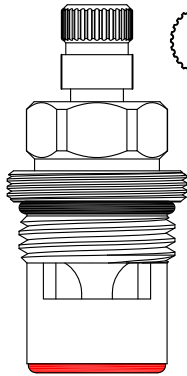

30
3-35

GASKET: 890170 O-RING INCLUDED
SEAL: 898570-R/B
DISC SET: 151380-PKG

LF456411
LF456412

FOR STREAMWAY
LENGTH: 1.88"

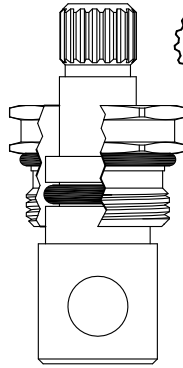

17
3-7

GASKET: 890170 O-RING INCLUDED

430010
230010 Stem Only

FOR BARNES
LENGTH: 1.88"

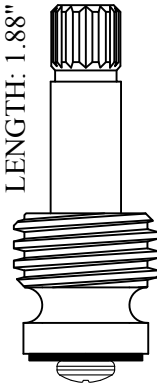

16
1-6

LF256101
LF256102

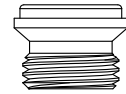

SEAT USED: LF648350

FOR CENTRAL
LENGTH: 1.88"

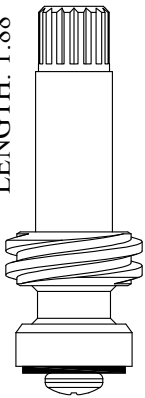

16
1-6

LF256111
LF256112



SEAT USED: LF648550

FOR MILWAUKEE
LENGTH: 1.88"

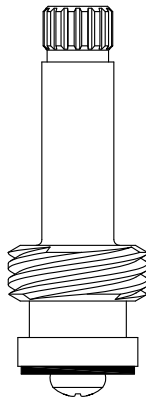

16
3-15

Chrome Plated Stem

LF256121
LF256122



SEAT USED: LF649040

FOR PRICE PFISTER
LENGTH: 1.88"

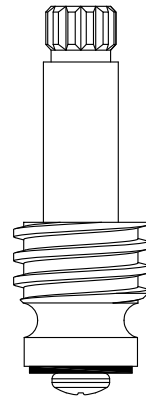

12
1-2

Chrome Plated Stem

LF256251

UNKNOWN
LENGTH: 1.88"

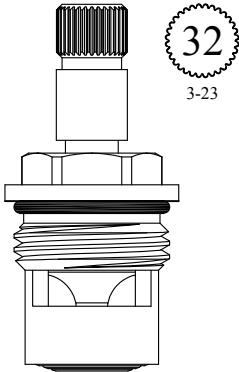

GASKET: 890170 O-RING INCLUDED
SEAL: 898500
DISC SET: 112530-PKG

LF455381
LF455382

FOR BELVEDERE
LENGTH: 1.88"

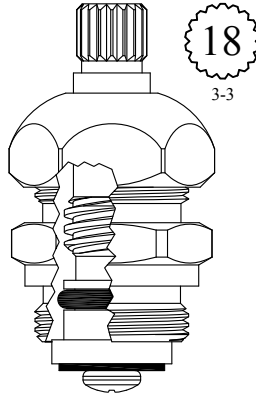

GASKET: 895150

LF456131
LF456132



SEAT USED: LF648500

FOR GLACIER BAY
LENGTH: 1.88"

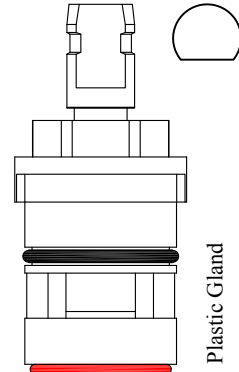

GASKET: 890170 O-RING INCLUDED
SEAL: 898580-R
DISC SET: 115520-PKG

LF456201
LF456202

FOR GLACIER BAY
LENGTH: 1.88"

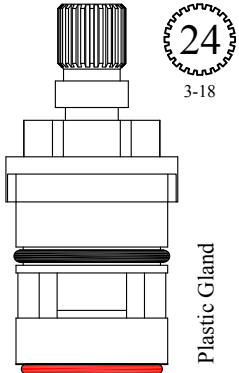

GASKET: 890170 O-RING INCLUDED
SEAL: 898580-R
DISC SET: 115520-PKG

LF456231
LF456232

FOR P.E. GUERIN
LENGTH: 1.88"

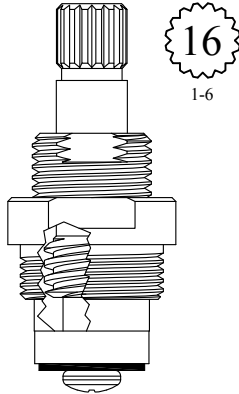

GASKET: 895100

LF456321
LF456322

FOR BURLINGTON
LENGTH: 1.88"

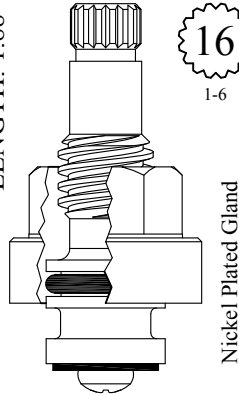

LF457011
LF457012



SEAT USED: LF648700

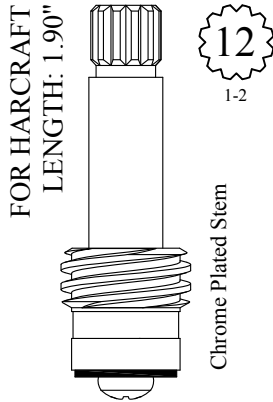

LF257111
LF257112

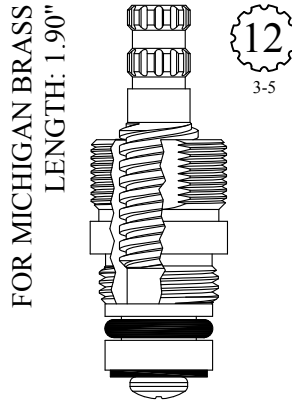

LF456821
LF456822

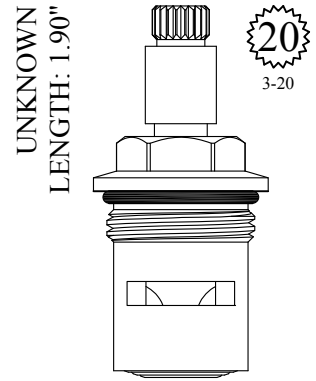

GASKET: 890170 O-RING INCLUDED
SEAL: 898500
DISC SET: 112530-PKG

LF456881
LF456882

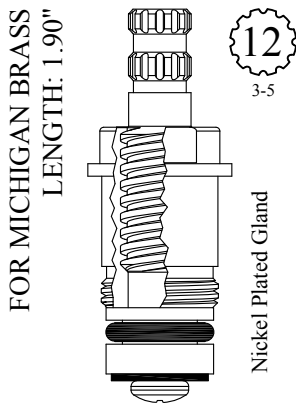

LF457021
LF457022

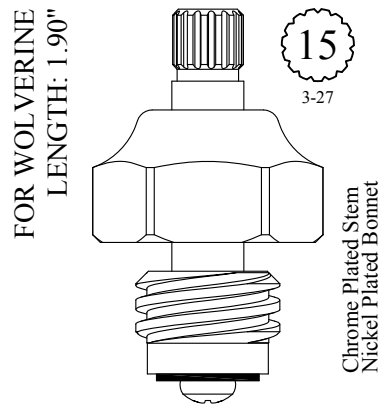
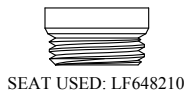

LF457161
LF457162
LF257161 Stem Only
LF257162 Stem Only

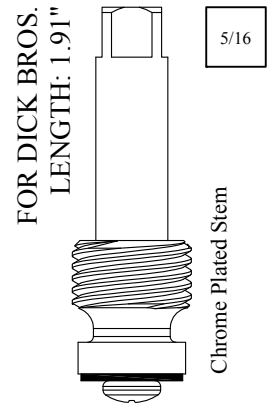

258211

FOR INDIANA
LENGTH: 1.91"

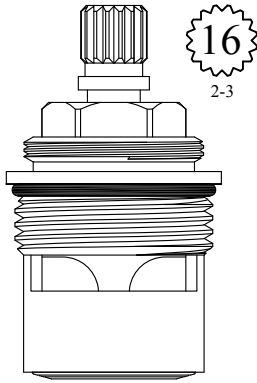

GASKET: 890210 O-RING INCLUDED
SEAL: 898520
DISC SET: 109850-PKG

400811
400812

FOR PRICE PFISTER
LENGTH: 1.91"

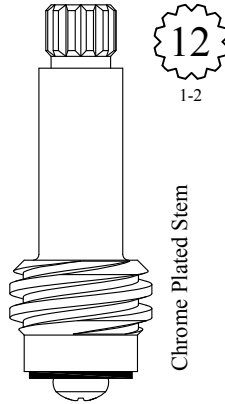

Chrome Plated Stem

LF257051
LF257052

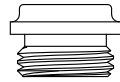

SEAT USED: LF648270

FOR GLACIER BAY
LENGTH: 1.91"

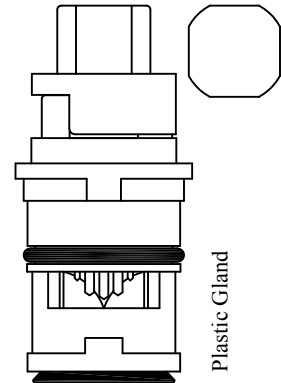

Plastic Gland

GASKET: 890170 O-RING INCLUDED
SEAL: 898510
DISC SET: 151380-PKG

LF456351
LF456352

FOR DORNBRACHT
LENGTH: 1.91"

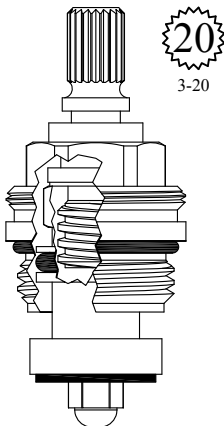

20
3-20

GASKET: 890170 O-RING INCLUDED

LF456362



SEAT USED: LF647110

FOR AM STD
LENGTH: 1.91"

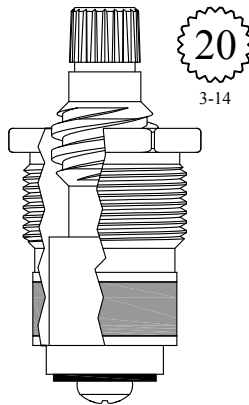

20
3-14

LF457101

LF457102

LF257101 Stem Only

LF257102 Stem Only



SEAT USED: LF648220

FOR PRICE PFISTER
LENGTH: 1.91"

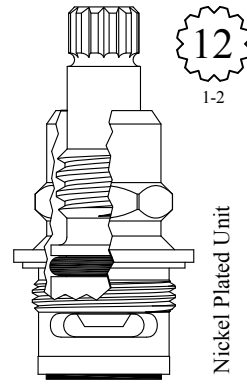

12
1-2

Nickel Plated Unit

GASKET: 895190

LF457201

LF457202

FOR PRICE PFISTER
LENGTH: 1.91"

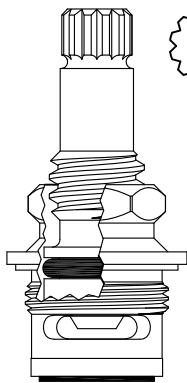

12
1-2

Nickel Plated Stem

GASKET: 895190

LF457221
LF457222

UNKNOWN
LENGTH: 1.91"

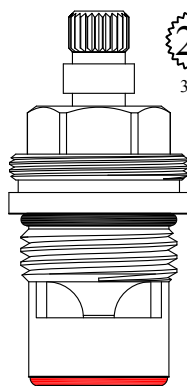

24
3-28

GASKET: 890170 O-RING INCLUDED
SEAL: 898570-R/B
DISC SET: 151380-PKG

LF459131
LF459132

FOR MILWAUKEE
LENGTH: 1.92"

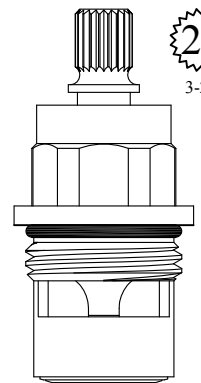

20
3-20

GASKET: 890170 O-RING INCLUDED
SEAL: 898510-W
DISC SET: 151380-PKG

LF456401
LF456402

UNKNOWN
LENGTH: 1.92"

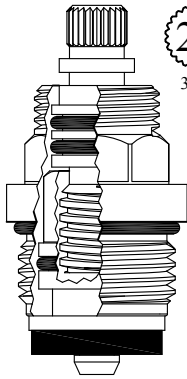

24
3-28

GASKET: 890170 O-RING INCLUDED

LF456422

FOR WOLVERINE
LENGTH: 1.92"

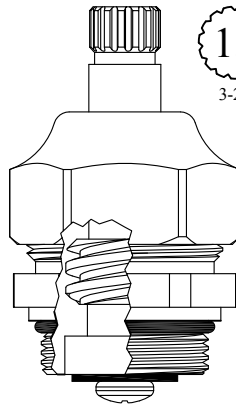

15
3-27

Chrome Plated Stem
Nickel Plated Gland & Bonnet

GASKET: 890190 O-RING INCLUDED

LF457081
LF457082

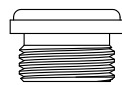

SEAT USED: LF649200

FOR COYNE DELANEY
LENGTH: 1.93"

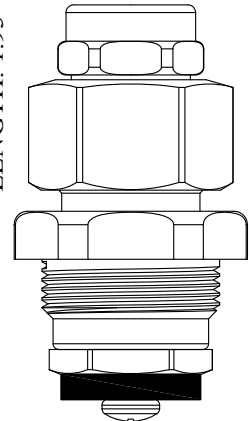

Chrome Plated Unit

GASKET INCLUDED: 895370

460302

FOR DOBO
LENGTH: 1.93"

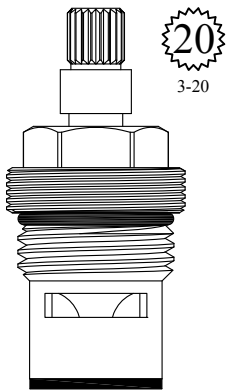

GASKET: 890170 O-RING INCLUDED
SEAL: 853030
DISC SET: 151380-PKG

LF456391
LF456392

FOR SIMBOLO
LENGTH: 1.92"

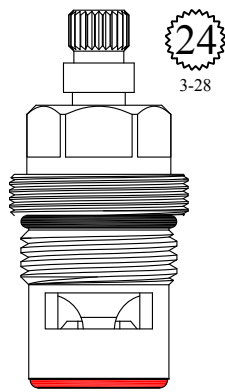

GASKET: 890170 O-RING INCLUDED
SEAL: 898570-R/B
DISC SET: 151380-PKG

LF456911
LF456912

FOR NICOLAZZI
LENGTH: 1.92"

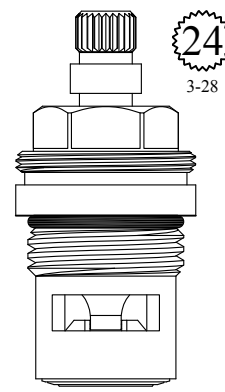

GASKET: 890170 O-RING INCLUDED
SEAL: 898510-W
DISC SET: 151380-PKG

LF456921
LF456922

FOR AQUASOURCE
LENGTH 1.94"

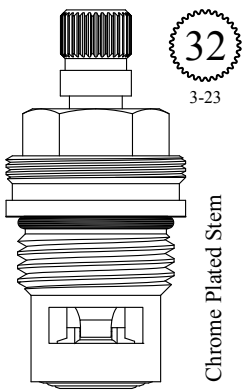

GASKET: 890170 O-RING INCLUDED
SEAL: 898500
DISC SET: 112530-PKG

LF457311
LF457312

FOR OMNI
LENGTH: 1.95"

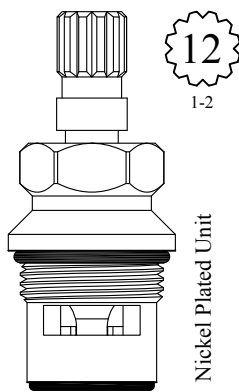

GASKET: 890170 O-RING INCLUDED
SEAL: 898540
DISC SET: 112530-PKG

LF458821
LF458822

FOR CHATSWORTH
LENGTH: 1.94"

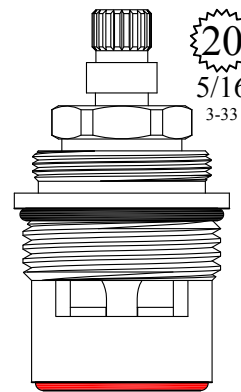

GASKET: 890210 O-RING INCLUDED
SEAL: 898610-R
DISC SET: 109850-PKG

400971
400972

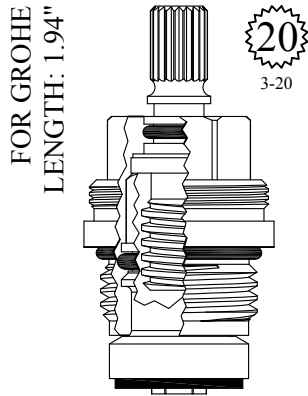

GASKET: 890170 O-RING INCLUDED

LF457282



SEAT USED: LF647580

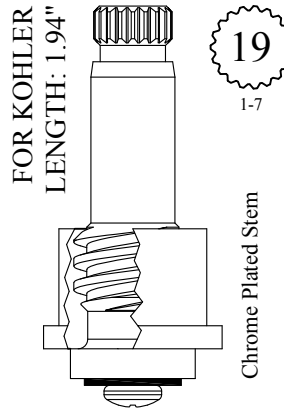

LF458041
LF458042
LF258041 Stem Only
LF258042 Stem Only



SEAT USED: LF647230

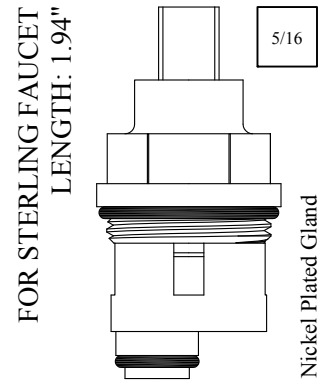

GASKET: 890180 O-RING INCLUDED

LF458171
LF458172

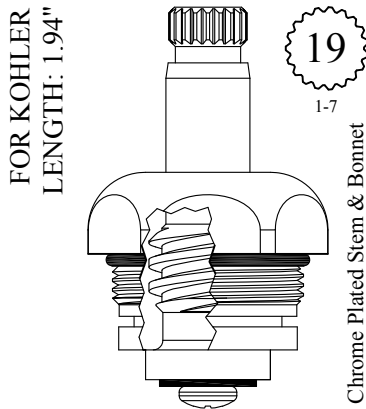

GASKET: 890210 O-RING INCLUDED

LF458241
LF458242
LF258041 Stem Only
LF258042 Stem Only

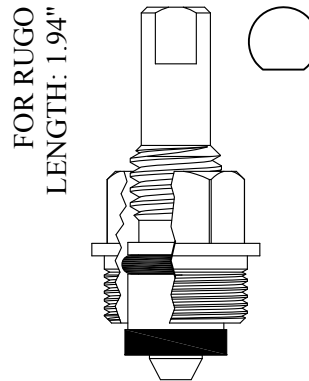

GASKET: 895100

LF458301

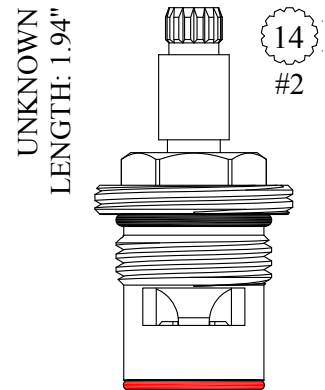

GASKET: 890170 O-RING INCLUDED
SEAL: 898580-R/B
DISC SET: 151380-PKG

LF458431
LF458432

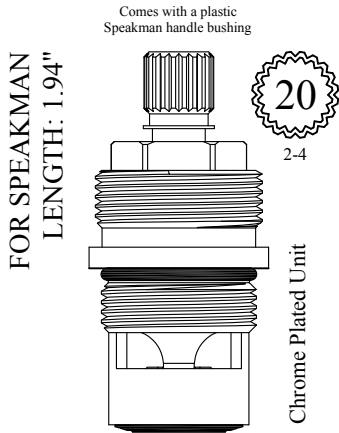

GASKET: 890170 O-RING INCLUDED
SEAL: 898510-W
DISC SET: 151380-PKG

LF458801
LF458802

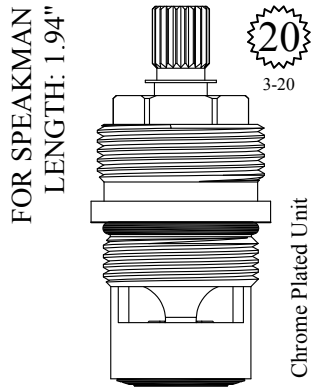

GASKET: 890170 O-RING INCLUDED
SEAL: 898510-W
DISC SET: 151380-PKG

LF458811
LF458812

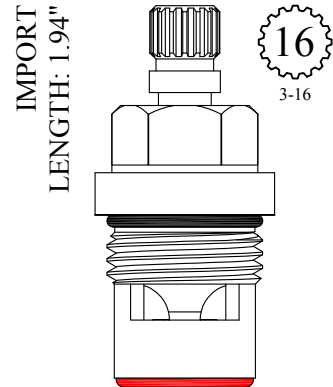

GASKET: 890170 O-RING INCLUDED
SEAL: 898570-R/B
DISC SET: 151380-PKG

LF458871
LF458872

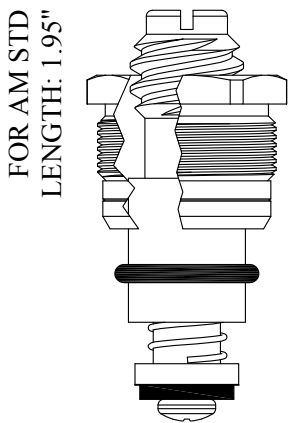

400591
200591 Stem Only

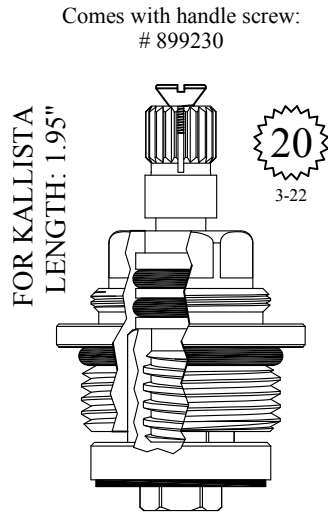

GASKET: 891180 O-RING INCLUDED

401072

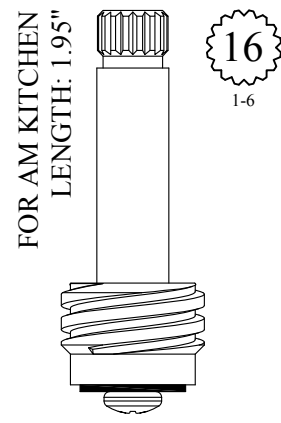

LF258021
LF258022



FOR SISCO
LENGTH: 1.95"

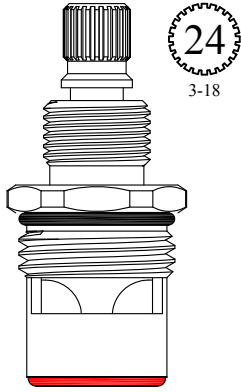

GASKET: 890170 O-RING INCLUDED
SEAL: 898570-R/B
DISC SET: 151380-PKG

LF456901
LF456902

FOR BRIGGS
LENGTH: 1.95"

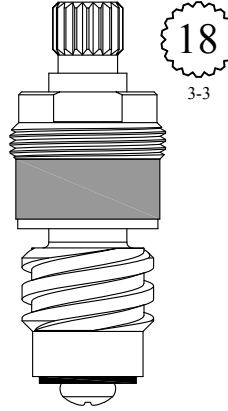

LF457131
LF457132
LF257131 Stem Only
LF257132 Stem Only



FOR ELJER
LENGTH 1.95"

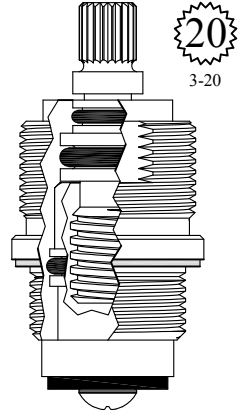

GASKET: 895160 INCLUDED

LF457242



FOR MILWAUKEE
LENGTH: 1.95"

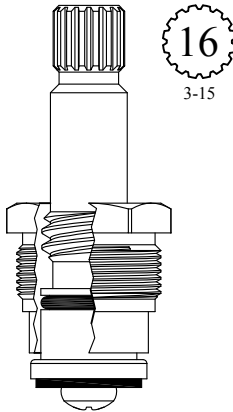

GASKET: 199930

LF457301



FOR GLACIER BAY
LENGTH: 1.95"

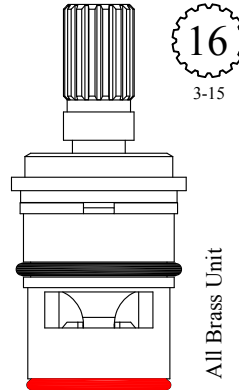

GASKET: 890170 O-RING INCLUDED
SEAL: 898580-R/B
DISC SET: 151380-PKG

LF457611
LF457612

FOR PRICE PFISTER
LENGTH: 1.95"

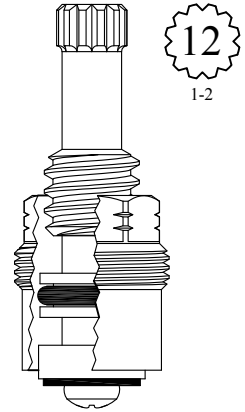

GASKET: 895060

LF458051



Comes with handle screw:
899230

FOR ELJER
LENGTH: 1.95"

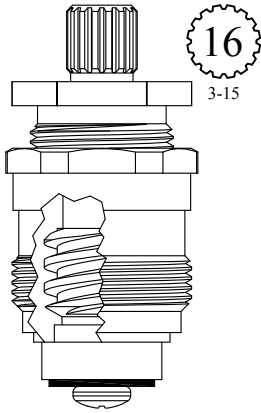

GASKET: 895120

LF458101
LF458102
LF258101 Stem Only
LF258102 Stem Only



SEAT USED: LF648160

FOR KALLISTA
LENGTH: 1.95"

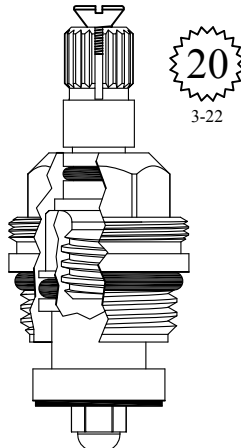

GASKET: 891150 O-RING INCLUDED

LF458502

FOR AM STD
LENGTH: 1.96"

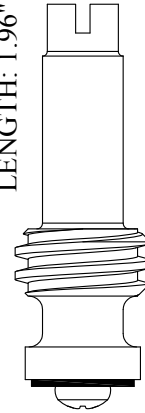

257351

FOR GERBER
LENGTH: 1.96"

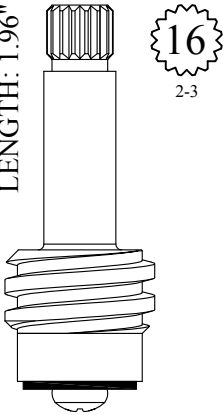

LF259021
LF259022



SEAT USED: LF649150

FOR SAYCO
LENGTH: 1.96"

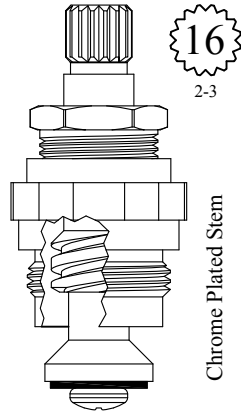

GASKET: 895100

LF458061
LF458062
LF258061 Stem Only
LF258062 Stem Only

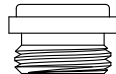

SEAT USED: LF647450

FOR AM STD
LENGTH: 1.96"

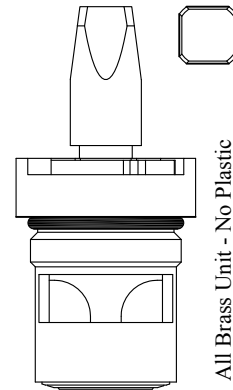

GASKET: 890170 O-RING INCLUDED
SEAL: 898510-W
DISC SET: 151380-PKG

LF458901
LF458902

All Brass Unit - No Plastic

FOR SAYCO
LENGTH: 1.96"

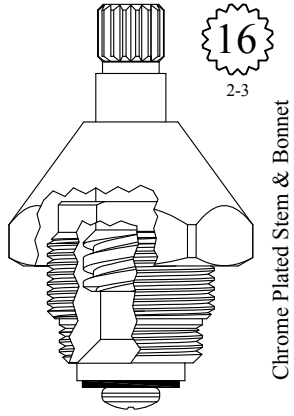

GASKET: 895100

LF459081
LF459082
LF258061 Stem Only
LF258062 Stem Only

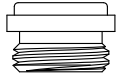

SEAT USED: LF647450

FOR STREAMWAY
LENGTH: 1.97"

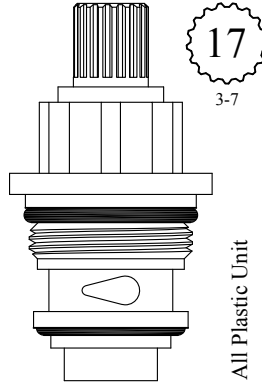

GASKET: 891150 O-RING INCLUDED

454041
454042

FOR DICK BROS.
LENGTH: 1.97"

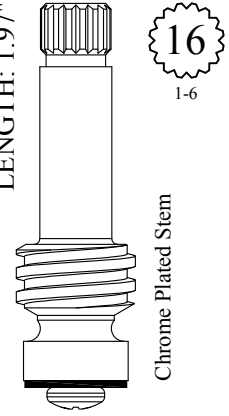

LF257271
LF257272

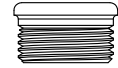

SEAT USED: LF649760

FOR RAPETTI
FOR ELJER
LENGTH 1.97"

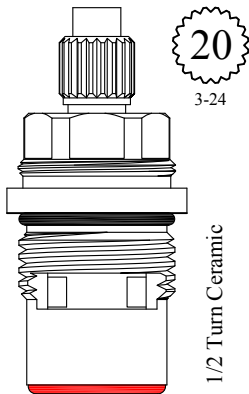

GASKET: 890170 O-RING INCLUDED
SEAL: 898570-R/B
DISC SET: 124290-PKG

LF457361
LF457362

FOR BROADWAY
LENGTH 1.97"

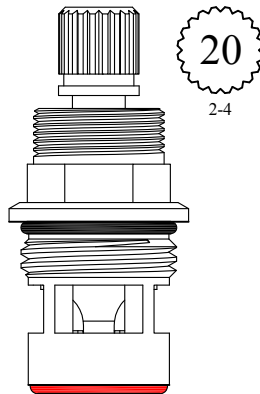

GASKET: 890170 O-RING INCLUDED
SEAL: 898570-R/B
DISC SET: 151380-PKG

LF457601
LF457602

FOR ARTISTIC BRASS
LENGTH 1.97"

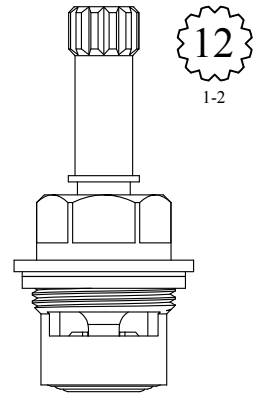

GASKET: 895100 INCLUDED
SEAL: 898500
DISC SET: 112530-PKG

LF458151
LF458152

FOR ARTISTIC BRASS
LENGTH: 1.97"

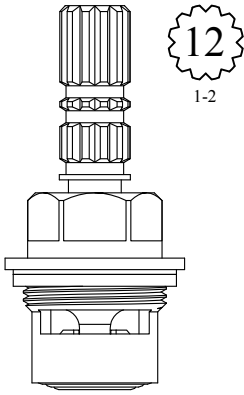

SEAL: 898500
DISC SET: 112530-PKG
LF458161
LF458162

FOR URREA
LENGTH: 1.97"

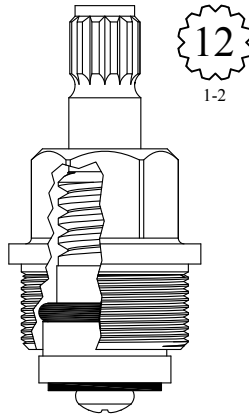

GASKET: 895180
LF458401

FOR KOHLER
LENGTH: 1.98"

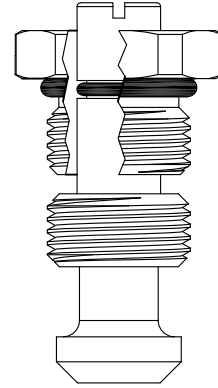

GASKET: 891140 O-RING INCLUDED
400911
200911 Stem Only

FOR CRANE
LENGTH: 1.97"

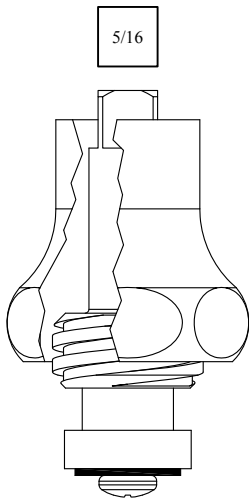

Also available with chrome plated bonnet
461541-CP

461541
261541 Stem Only

FOR DICK BROS.
LENGTH: 1.98"

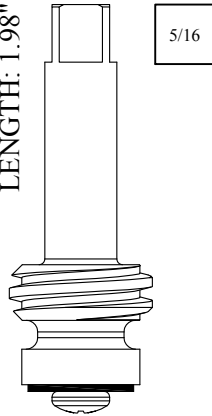

LF256711

FOR PRICE PFISTER
LENGTH: 1.98"

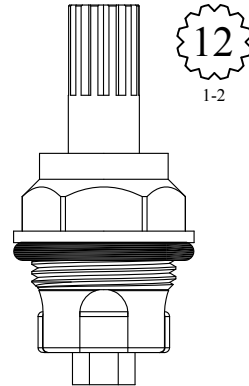

GASKET: 891100 O-RING INCLUDED
LF456331
LF456332

Chrome Bonnet
available separately

757500

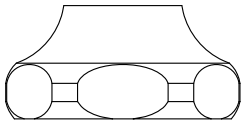

FOR SIGN OF THE CRAB
LENGTH: 1.98"

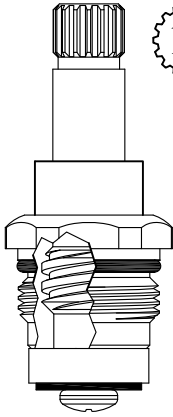

16
3-16

Chrome Plated Stem

Also available with polished brass stem

LF457501-PB / LF457502-PB

GASKET: 890160 O-RING INCLUDED

LF457501
LF457502

FOR ELJER
LENGTH: 1.98"

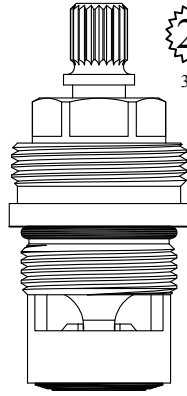

20
3-20

GASKET: 890170 O-RING INCLUDED
SEAL: 898510
DISC SET: 151380-PKG

LF457701
LF457702

FOR SIGN OF THE CRAB
LENGTH: 1.99"

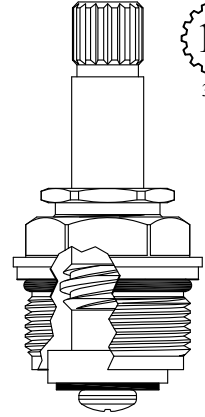

16
3-16

GASKET: 890180 O-RING INCLUDED

LF457721
LF457722

FOR SEARS
FOR RICHARD RHEEM
LENGTH: 1.99"

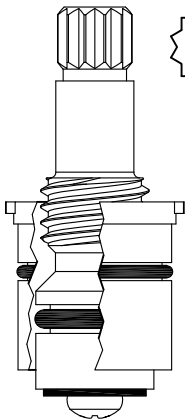

12
3-10

LF458131
LF458132

FOR BRIGGS
LENGTH: 2.00"

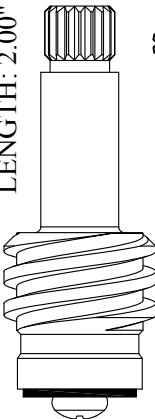

18
3-3

Chrome Plated Stem

LF255181
LF255182

FOR PEGASUS
FOR SIGN OF THE CRAB
LENGTH: 2.00"

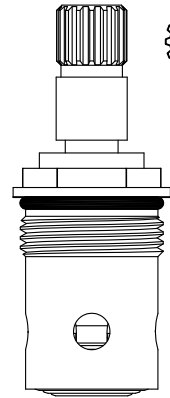

16
3-16

GASKET: 890160 O-RING INCLUDED
SEAL: 898500
DISC SET: 112530-PKG

LF457901
LF457902

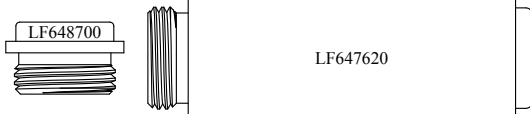

SEAT USED: LF648700 or LF647620

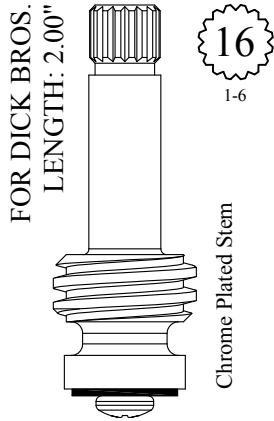

LF256701
LF256702

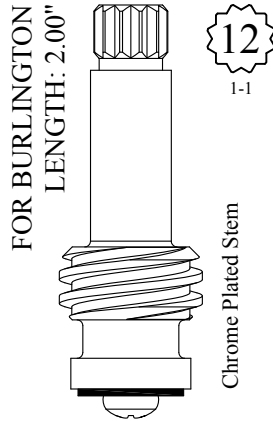

LF260071
LF260072

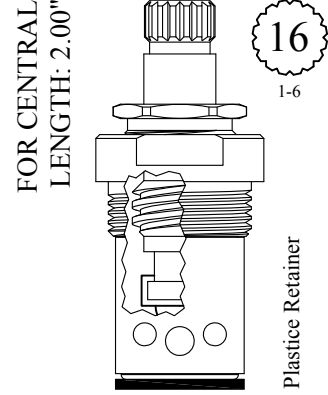

GASKET: 895100

LF453501
LF453502

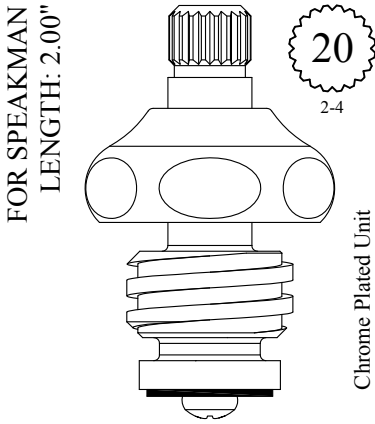

LF457121
LF457122
LF257121 Stem Only
LF257122 Stem Only

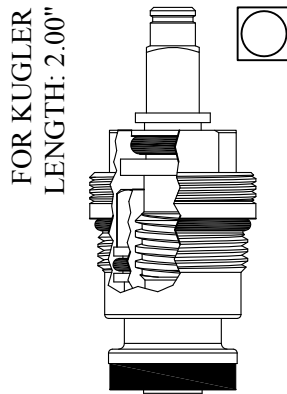

GASKET: 890170 O-RING INCLUDED

LF457262

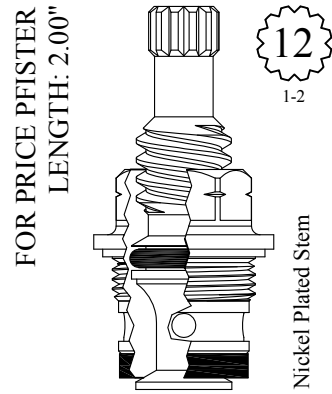

GASKET: 895100

LF458072

FOR STERLING FAUCET
LENGTH: 2.00"

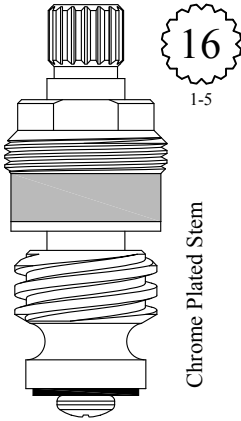

LF458091
LF458092
LF258091 Stem Only
LF458092 Stem Only



FOR T & S
LENGTH: 2.00"

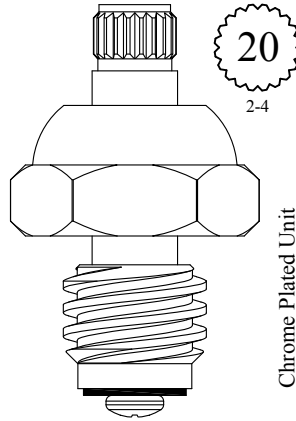

LF458201
LF458202
LF258201 Stem Only
LF258202 Stem Only



FOR MUELLER
LENGTH: 2.00"

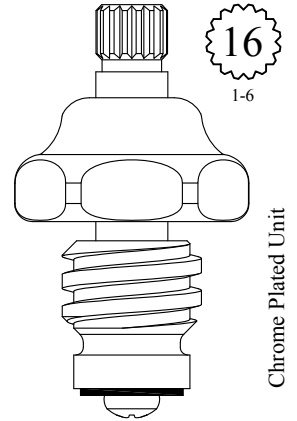

LF459011
LF459012
LF259011 Stem Only
LF259012 Stem Only

FOR KOHLER
LENGTH: 2.00"

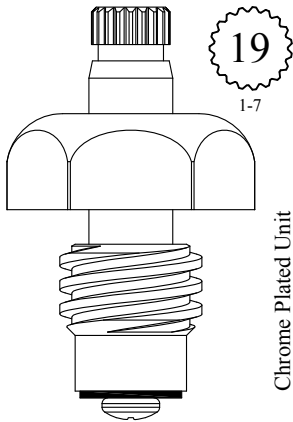

LF459041
LF459042
LF259041 Stem Only
LF259042 Stem Only



FOR MUELLER
LENGTH: 2.00"

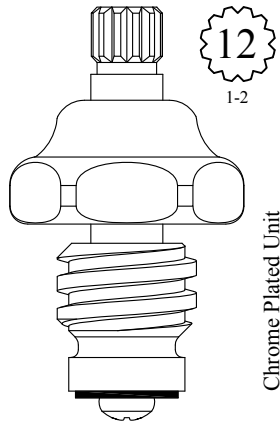

LF459061
LF459062
LF259061 Stem Only
LF259062 Stem Only

FOR FOREMOST
LENGTH: 2.00"

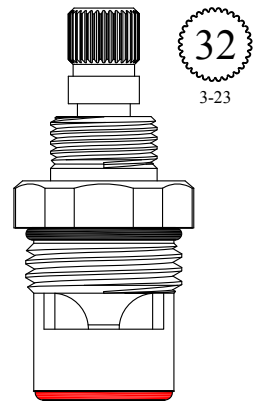

GASKET: 890170 O-RING INCLUDED
SEAL: 898580-R/B
DISC SET: 151380-PKG

LF459271
LF459272

UNKNOWN
LENGTH: 2.00"

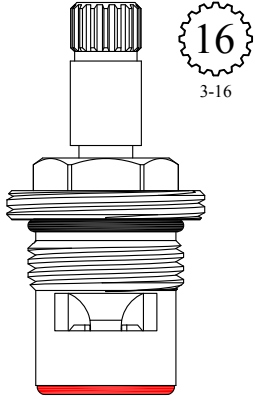

GASKET: 890170 O-RING INCLUDED
SEAL: 898570-R/B
DISC SET: 151380-PKG

LF459431
LF459432

FOR CENTRAL
LENGTH: 2.01"

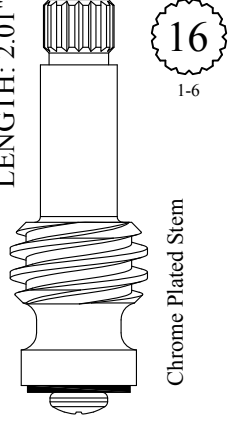

Chrome Plated Stem

LF258081
LF258082

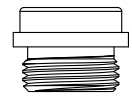

SEAT USED: LF648550

FOR INDIANA
LENGTH: 2.01"

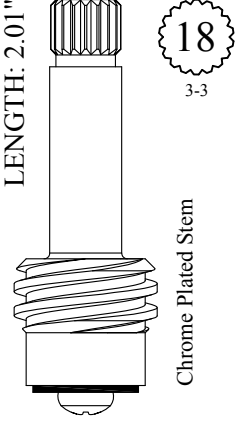

Chrome Plated Stem

LF259031
LF259032

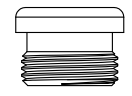

SEAT USED: LF648560

FOR GLACIER BAY
LENGTH: 2.00"

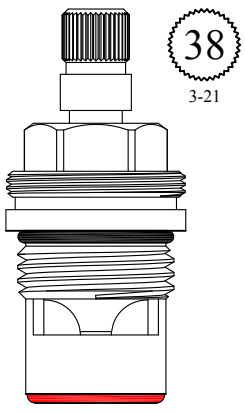

GASKET: 890170 O-RING INCLUDED
SEAL: 898570-R/B
DISC SET: 151380-PKG

LF458341
LF458342

FOR SEARS
LENGTH: 2.02"

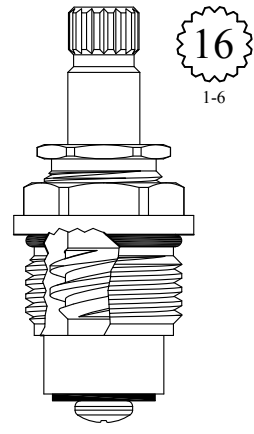

GASKET: 890170 O-RING INCLUDED

LF458281
LF458282

FOR PORCHER
LENGTH: 2.02"

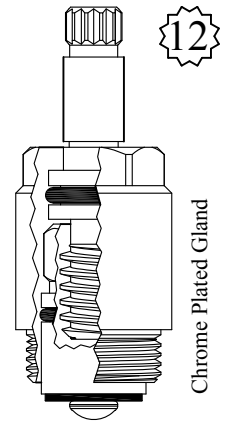

Chrome Plated Gland

LF458602

FOR PAINI
LENGTH 2.02"

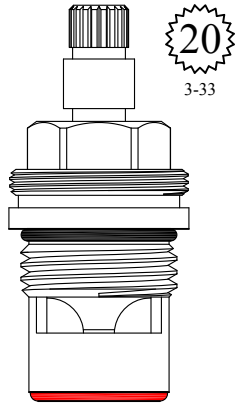

GASKET: 890170 O-RING INCLUDED
SEAL: 898570-R/B
DISC SET: 151380-PKG

LF458891
LF458892

FOR BALOCCHI
LENGTH 2.02"

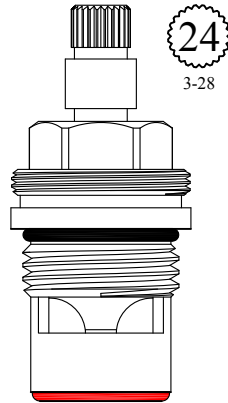

GASKET: 890170 O-RING INCLUDED
SEAL: 898570-R/B
DISC SET: 151380-PKG

LF459341
LF459342

FOR STERLING FAUCET
LENGTH: 2.03"

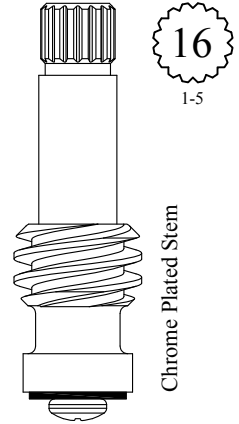

LF259071
LF259072

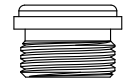

SEAT USED: LF648170

FOR FRANKE

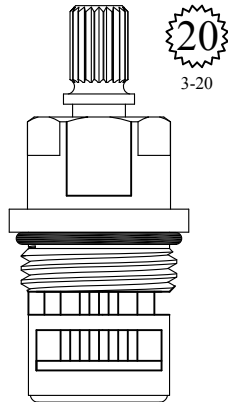

Not Available
USE LF458941/LF458942

FOR FRANKE
LENGTH: 2.03"

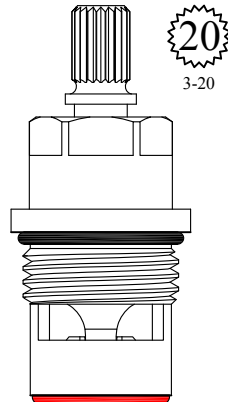

GASKET: 890170 O-RING INCLUDED
SEAL: 898570-R/B
DISC SET: 151380-PKG

LF458941
LF458942

FOR SEARS
LENGTH 2.03"

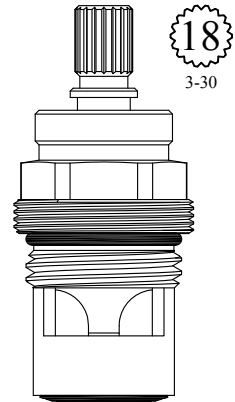

GASKET: 890170 O-RING INCLUDED
SEAL: 898510
DISC SET: 151380-PKG

LF459171
LF459172

FOR SEARS
LENGTH 2.03"

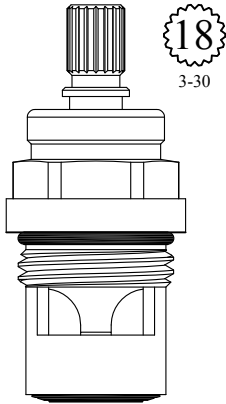

18
3-30

GASKET: 890170 O-RING INCLUDED
SEAL: 898510
DISC SET: 151380-PKG

LF459181
LF459182

UNKNOWN
LENGTH 2.03"

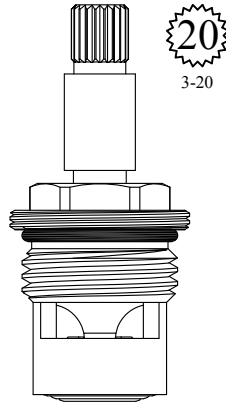

20
3-20

GASKET: 890170 O-RING INCLUDED
SEAL: 898500
DISC SET: 112530-PKG

LF459281
LF459282

UNKNOWN
LENGTH: 2.03"

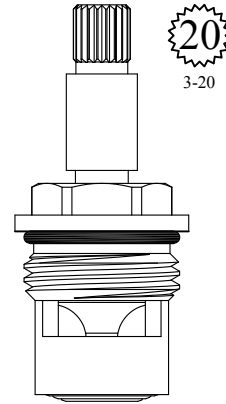

20
3-20

GASKET: 890170 O-RING INCLUDED
SEAL: 898500
DISC SET: 112530-PKG

LF459381
LF459382

FOR SEPCO
LENGTH: 2.04"

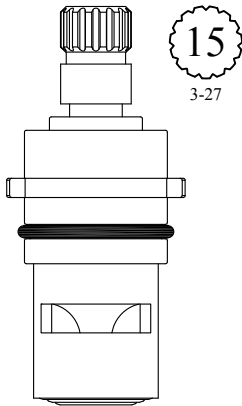

15
3-27

SEAL: 898500
DISC SET: 112530-PKG

LF458841
LF458842

UNKNOWN
LENGTH 2.04"

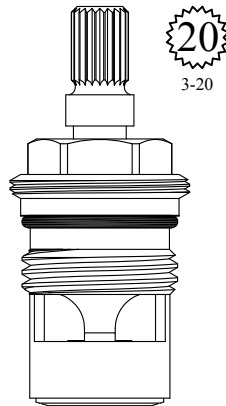

20
3-20

GASKET: 890170 O-RING INCLUDED
SEAL: 898510-W
DISC SET: 151380-PKG

LF459161
LF459162

IMPORT
LENGTH 2.04"

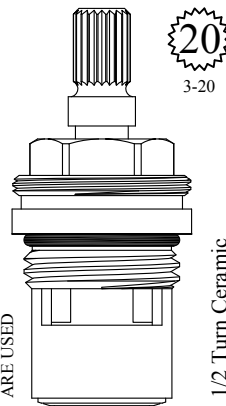

20
3-20

GASKET: 890170 O-RING INCLUDED
SEAL: 898510-W
DISC SET: 124290-PKG
FITS ALL BODIES
WHERE 459201/459202
ARE USED
1/2 Turn Ceramic

LF459211
LF459212

FOR SEARS
LENGTH 2.04"

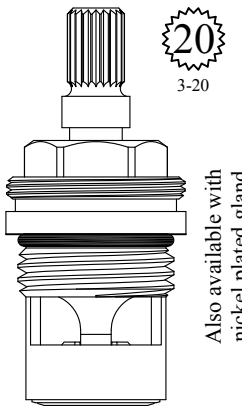

20
3-20

GASKET: 890170 O-RING INCLUDED
SEAL: 898510-W
DISC SET: 151380-PKG

LF459201
LF459202

Also available with
nickel plated gland
LF459201-NP / LF459202-NP

FOR CONCINITY
LENGTH 2.04"

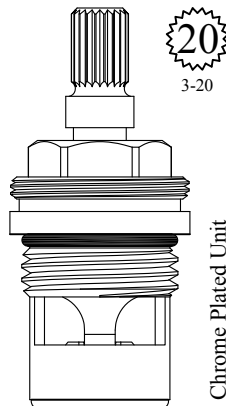

20
3-20

GASKET: 890170 O-RING INCLUDED
SEAL: 898570-W
DISC SET: 151380-PKG

LF459231
LF459232

Chrome Plated Unit

FOR SIGN OF THE CRAB
LENGTH: 2.04"

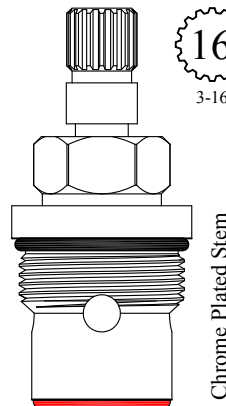

16
3-16

GASKET: 890170 O-RING INCLUDED
SEAL: 898570-R/B
DISC SET: 151380-PKG

LF459371
LF459372

Chrome Plated Stem

FOR SPRINGHOUSE
LENGTH: 2.04"

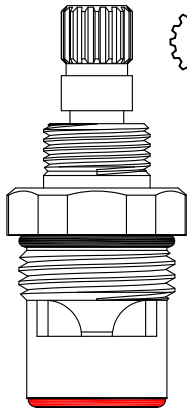

16
3-16

GASKET: 890170 O-RING INCLUDED
SEAL: 898580-R/B
DISC SET: 151380-PKG

LF459771
LF459772

FOR ARSELUX
LENGTH: 2.04"

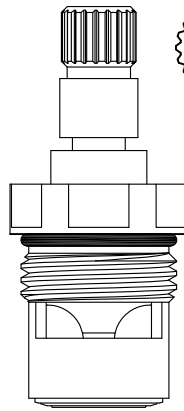

19
1-7

GASKET: 890170 O-RING INCLUDED
SEAL: 898510
DISC SET: 151380-PKG

LF461501
LF461502

FOR MILWAUKEE
LENGTH: 2.05"

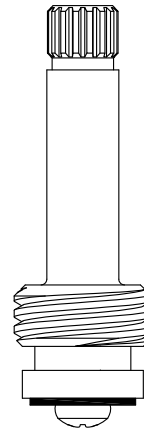

16
3-15

LF259051
LF259052

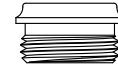

SEAT USED: LF649040

FOR METCRAFT
LENGTH: 2.05"

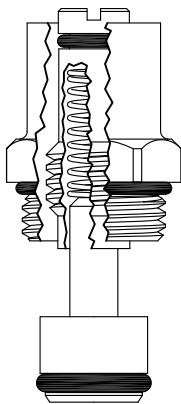

GASKET: 890170 O-RING INCLUDED

LF400751

FOR SAYCO
LENGTH: 2.05"

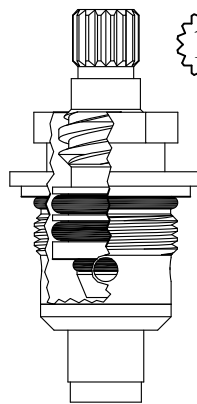

16
2-3

GASKET: 890160 O-RING INCLUDED
SEAT INCLUDED: 652360

LF452361
LF452362

FOR MILWAUKEE
LENGTH: 2.05"

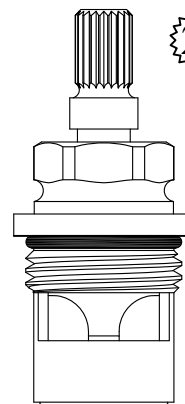

20
3-20

GASKET: 890170 O-RING INCLUDED
SEAL: 898510-W
DISC SET: 151380-PKG

LF458191
LF458192

FOR BELMONT
LENGTH: 2.05"

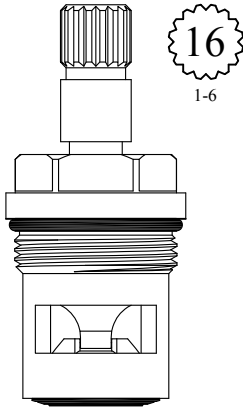

GASKET: 890170 O-RING INCLUDED
SEAL: 898510
DISC SET: 151380-PKG

LF459261
LF459262

FOR KOHLER
LENGTH: 2.05"



GASKET: 890170 O-RING INCLUDED
SEAL: 898510
DISC SET: 151380-PKG

LF459331
LF459332

Nickel Plated Gland

Also available with

19pt Kohler Adapter Broach #121230
LF460331 / LF460332

FOR OTTONE & MELODA
LENGTH: 2.05"

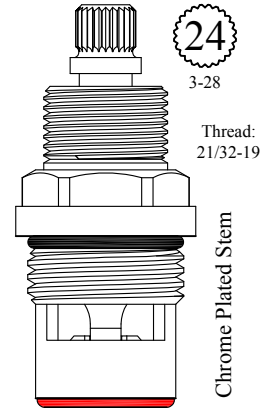

GASKET: 890170 O-RING INCLUDED
SEAL: 898570-R/B
DISC SET: 151380-PKG

LF459691
LF459692

Chrome Plated Stem

Thread:
21/32-19

FOR DORNBRACHT
LENGTH: 2.05"

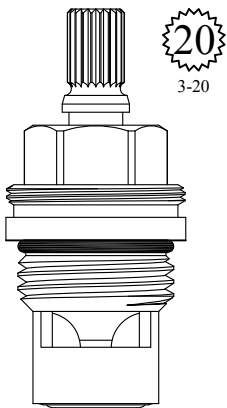

GASKET: 890170 O-RING INCLUDED
SEAL: 898500
DISC SET: 112530-PKG

LF459751
LF459752

FOR PRICE PFISTER
LENGTH: 2.06"

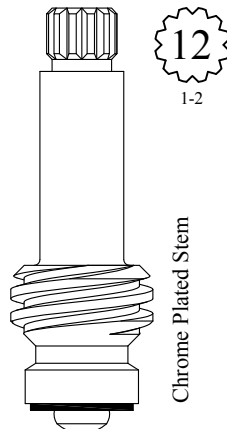

LF260081
LF260082

Chrome Plated Stem

UNKNOWN
LENGTH: 2.06"

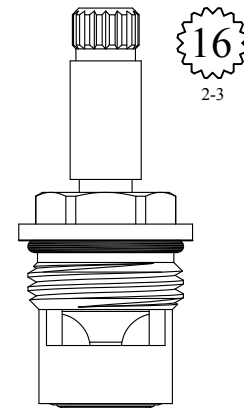

GASKET: 890170 O-RING INCLUDED
SEAL: 898500
DISC SET: 112530-PKG

LF457291
LF457292

FOR HELVIX
LENGTH: 2.06"

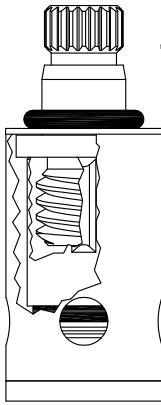

19
1-7

LF458992

FOR KRONIN BY VIOLA
LENGTH: 2.06"

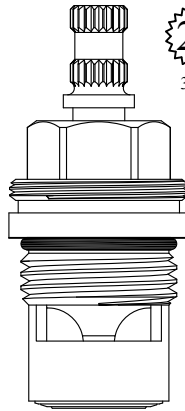

20
3-20

GASKET: 890170 O-RING INCLUDED
SEAL: 898510-W
DISC SET: 151380-PKG

LF459291
LF459292

FOR EMCO
LENGTH: 2.07"

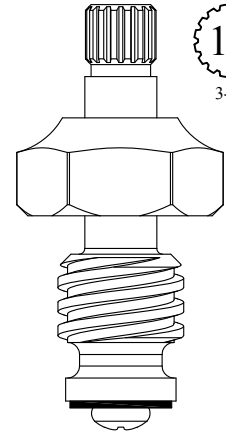

16
3-15

LF184561
LF184631 Stem Only

FOR BARNES
LENGTH: 2.07"

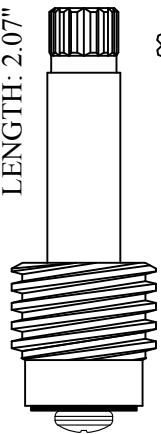

16
1-6

Chrome Plated Stem

LF263101
LF263102



SEAT USED: LF648350

UNKNOWN
LENGTH 2.07"

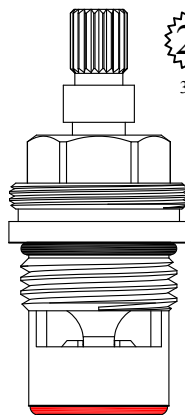

20
3-20

GASKET: 890170 O-RING INCLUDED
SEAL: 898570-R/B
DISC SET: 151380-PKG

LF458861
LF458862

FOR DELTA
LENGTH: 2.07"

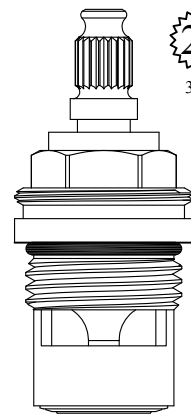

20
3-20

GASKET: 890170 O-RING INCLUDED
SEAL: 898510-W
DISC SET: 151380-PKG

LF459191
LF459192

FOR MANGORI
LENGTH: 2.07"

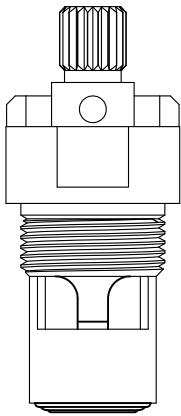

20
11/32
3-34

SEAL: 898500
DISC SET: 112530-PKG

LF459471
LF459472

FOR BRIGGS
LENGTH: 2.08"

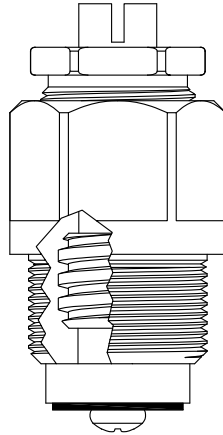

GASKET: 895370

401461
201461 Stem Only

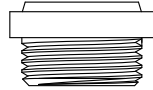

SEAT USED: 647650

FOR NICOLAZZI
LENGTH: 2.08"

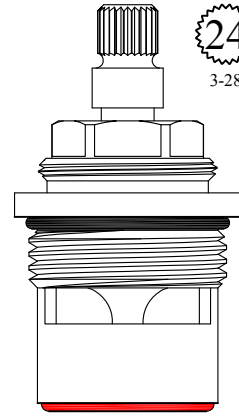

24
3-28

GASKET: 890210 O-RING INCLUDED
SEAL: 898610-R/B
DISC SET: 109850-PKG

401011
401012

FOR AM BRASS
LENGTH: 2.08"

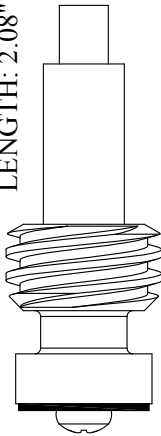

Chrome Plated Stem

LF260501

FOR AM BRASS
LENGTH: 2.08"

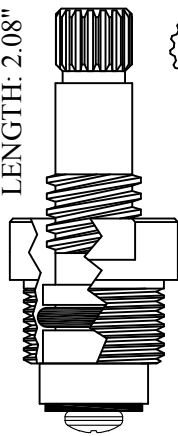

17
3-7

GASKET: 895100

LF458141
LF458142



SEAT USED: LF648410

FOR WELLINGTON
LENGTH: 2.08"

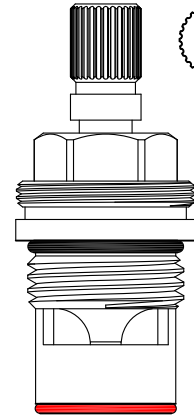

30
3-35

GASKET: 890170 O-RING INCLUDED
SEAL: 898580-R/B
DISC SET: 151380-PKG

LF459351
LF459352

Nickel Plated Unit

Comes with handle screw:
899230

FOR KALLISTA
LENGTH: 2.08"

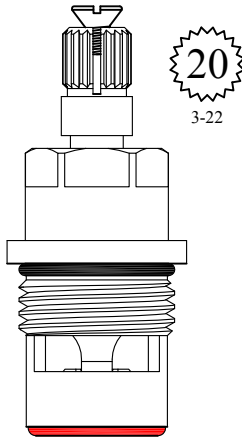

GASKET: 890170 O-RING INCLUDED
SEAL: 898570-R/B
DISC SET: 151380-PKG

LF459401
LF459402

FOR ZURN
LENGTH: 2.08"

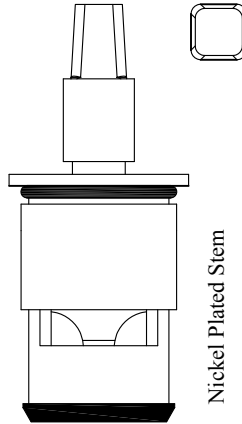

SEAL: 898590
DISC SET: 151380-PKG

LF459441
LF459442

FOR AVILION
FOR FRANKE
LENGTH: 2.08"

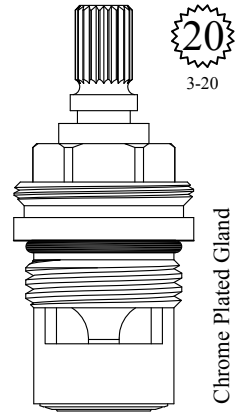

GASKET: 890170 O-RING INCLUDED
SEAL: 898510-W
DISC SET: 151380-PKG

LF459491
LF459492

FOR CRANE
CERAMIC CONVERSION FOR DIAL-EZE
LENGTH: 2.08"

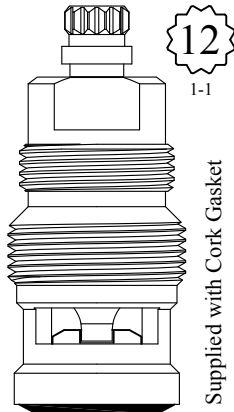

GASKET: 895250 INCLUDED
DISC SET: 151380-PKG

LF459521
LF459522

FOR ROHL
FOR FRANKE
LENGTH: 2.08"

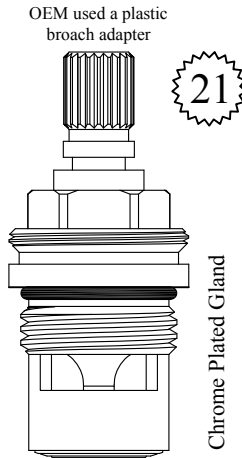

GASKET: 890170 O-RING INCLUDED
SEAL: 898510-W
DISC SET: 151380-PKG

LF459541
LF459542

UNKNOWN
LENGTH: 2.08"

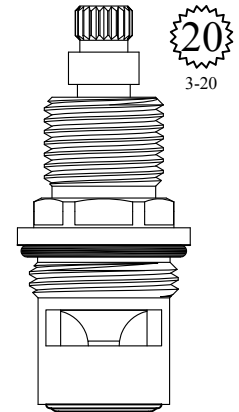

GASKET: 890170 O-RING INCLUDED
SEAL: 898500
DISC SET: 112530-PKG

LF459591
LF459592

FOR PAUL
FOR PHYLRICH
LENGTH: 2.08"

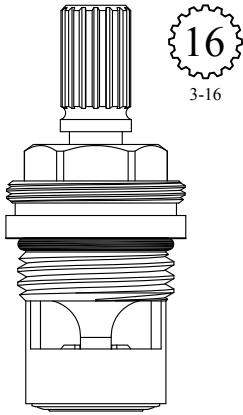

16
3-16

GASKET: 890170 O-RING INCLUDED
SEAL: 898510-W
DISC SET: 151380-PKG

LF461901
LF461902

FOR SANTEC
LENGTH: 2.08"

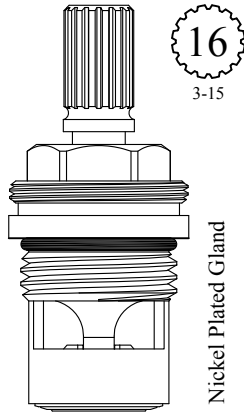

16
3-15

Nickel Plated Gland

GASKET: 890170 O-RING INCLUDED
SEAL: 898510-W
DISC SET: 151380-PKG

LF461911
LF461912

FOR BORG-WARNER
LENGTH: 2.09"

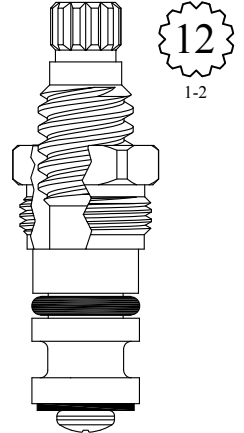

12
1-2

LF459091
LF459092

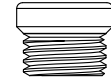

SEAT USED: LF649050

Comes with handle screw:
899230

CERAMIC 1/4 TURN

FOR KALLISTA
LENGTH: 2.09"

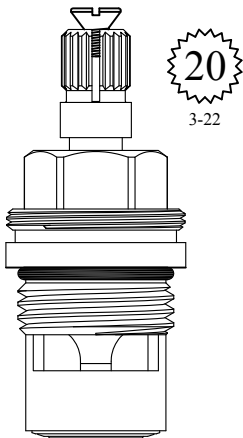

20
3-22

GASKET: 890170 O-RING INCLUDED
SEAL: 898510-W
DISC SET: 151380-PKG

LF459391
LF459392

FOR CHICAGO
LENGTH: 2.09"

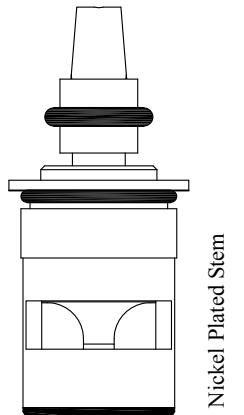

Nickel Plated Stem

GASKET: 890170 O-RING INCLUDED
SEAL: 898590
DISC SET: 151380-PKG

LF459411
LF459412

UNKNOWN
LENGTH: 2.09"

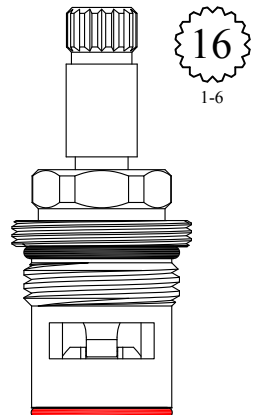

16
1-6

GASKET: 890170 O-RING INCLUDED
SEAL: 898580-R/B
DISC SET: 151380-PKG

LF459531
LF459532

FOR PRICE PFISTER
LENGTH: 2.10"

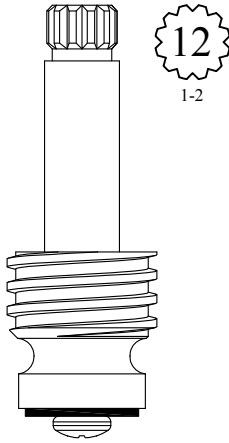

LF259251

FOR ELK
LENGTH: 2.10"

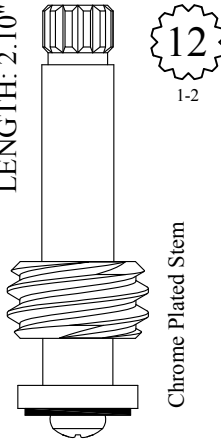

LF261101
LF261102

FOR METCRAFT
LENGTH: 2.10"

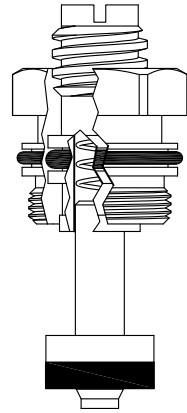

LF400441

FOR METCRAFT
LENGTH: 2.10"

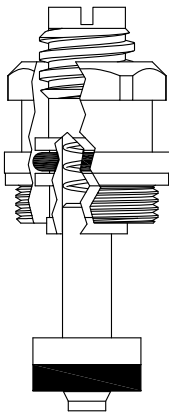

GASKET: 895100 INCLUDED

LF400461

FOR SISCO
LENGTH: 2.10"

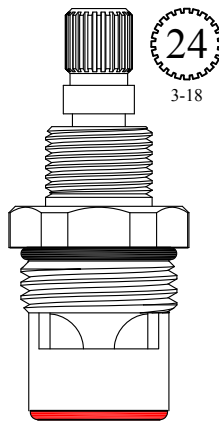

GASKET: 890170 O-RING INCLUDED
SEAL: 898580-R/B
DISC SET: 151380-PKG

LF459221
LF459222

FOR JADO
LENGTH 2.10"

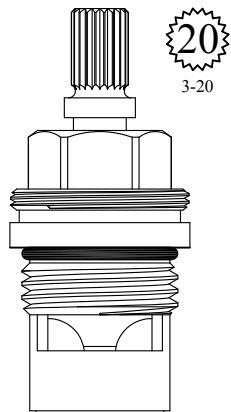

GASKET: 890170 O-RING INCLUDED
SEAL: 898510-W
DISC SET: 151380-PKG

LF459301
LF459302

FOR SANTEC
LENGTH: 2.10"

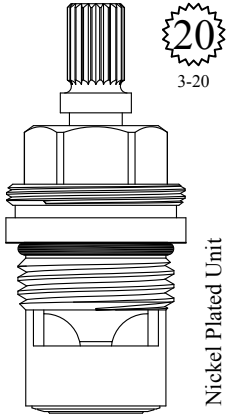

Nickel Plated Unit

GASKET: 890170 O-RING INCLUDED
SEAL: 898510-W
DISC SET: 151380-PKG

LF459311
LF459312

FOR BROADWAY
LENGTH: 2.10"

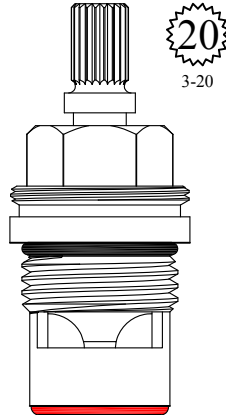

GASKET: 890170 O-RING INCLUDED
SEAL: 898570-R/B
DISC SET: 151380-PKG

LF459321
LF459322

FOR SEARS
LENGTH: 2.10"

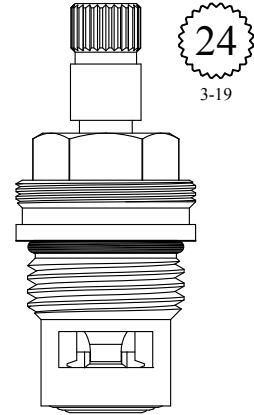

GASKET: 890170 O-RING INCLUDED
SEAL: 898500
DISC SET: 112530-PKG

LF459581
LF459582

FOR AM STD
LENGTH: 2.11"

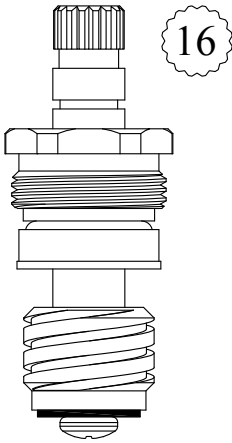

IMPORT
LENGTH: 2.11"

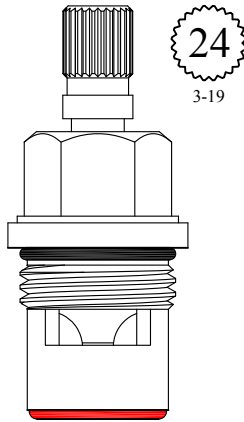

GASKET: 890170 O-RING INCLUDED
SEAL: 898570-R/B
DISC SET: 151380-PKG

LF459421
LF459422

UNKNOWN
LENGTH: 2.11"

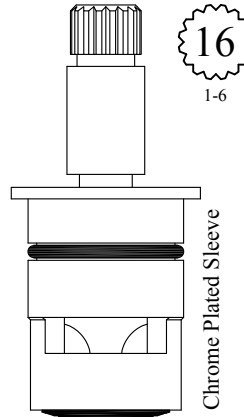

SEAL: 898510
DISC SET: 151380-PKG

LF459641
LF459642

UNKNOWN
LENGTH: 2.11"

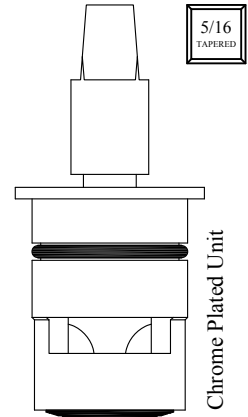

SEAL: 898510
DISC SET: 151380-PKG

LF459671
LF459672



SEAT USED: LF648350

FOR ARMONIA
LENGTH: 2.11"

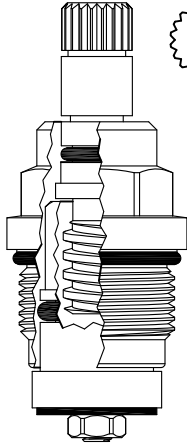

20
3-14

19 TPI Gland Fine Thread

GASKET: 890180 O-RING INCLUDED

LF460172

FOR ARMONIA
LENGTH: 2.11"

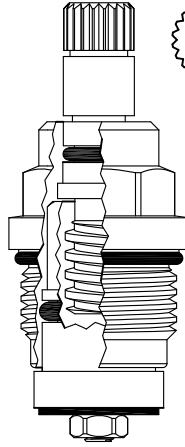

20
3-14

14 TPI Gland Coarse Thread

GASKET: 890180 O-RING INCLUDED

LF460182

FOR REID WATSON
LENGTH: 2.12"

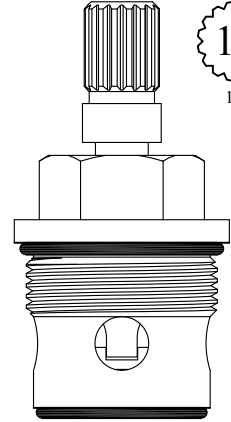

16
1-5

GASKET: 890210 O-RING INCLUDED
SEAL: 898530
DISC SET: 109850-PKG

401151
401152

FOR KOHLER
LENGTH: 2.12"

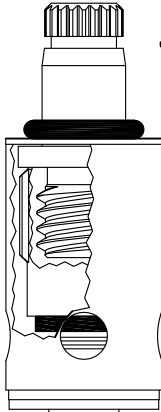

19
1-7

Chrome Plated Stem
Plastic Plunger

Also available with
Brass Plunger

SEAT: LF649460 INCLUDED

LF459101
LF459102
LF259101 Stem Only
LF259102 Stem Only

LF459101-B / LF459102-B

FOR KOHLER
LENGTH: 2.12"

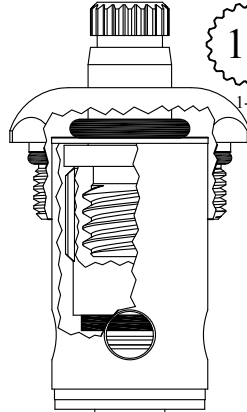

19
1-7

Chrome Plated Stem & Bonnet
Plastic Plunger

GASKET: 890210 O-RING INCLUDED
SEAT: LF649460 INCLUDED

LF459141
LF459142
LF259101 Stem Only
LF259102 Stem Only

FOR GROHE
LENGTH: 2.12"

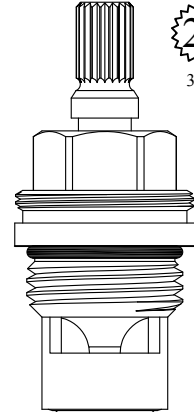

20
3-20

GASKET: 890170 O-RING INCLUDED
SEAL: 898500
DISC SET: 112530-PKG

LF459501
LF459502

FOR KOHLER
 CERAMIC CONVERSION FOR LF459101/2
 LENGTH: 2.12"

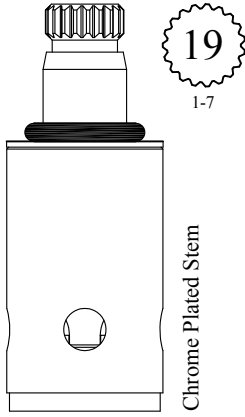

Chrome Plated Stem

DISC SET: 151380-PKG

LF459601
 LF459602

FOR ELJER
 LENGTH: 2.12"

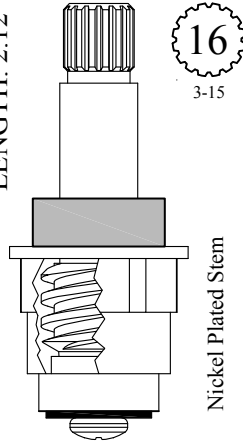

Nickel Plated Stem

LF460091
 LF460092
 LF260091 Stem Only
 LF260092 Stem Only

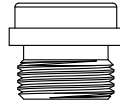

SEAT USED: LF648160

FOR ELJER
 LENGTH: 2.12"

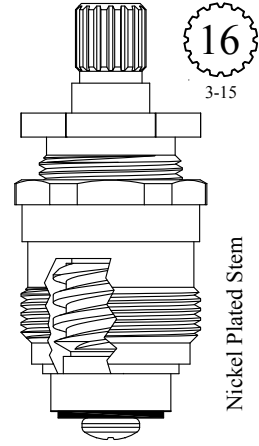

Nickel Plated Stem

GASKET: 895120

LF460111
 LF460112
 LF260091 Stem Only
 LF260092 Stem Only



SEAT USED: LF648160

FOR AM STD
 LENGTH: 2.12"

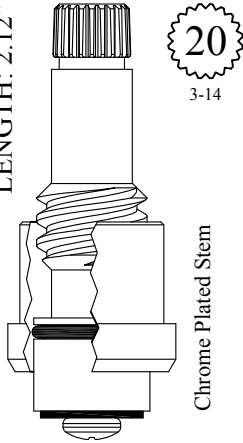

Chrome Plated Stem

GASKET: 891130

LF460121



SEAT USED: LF648990

FOR ELJER
 LENGTH: 2.12"

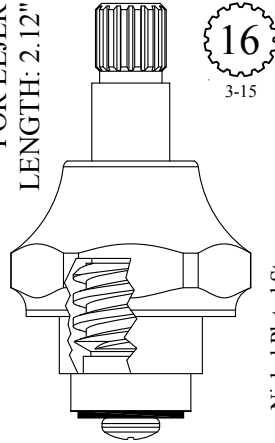

Nickel Plated Stem
 Chrome Plated Bonnet

LF460191
 LF460192
 LF260091 Stem Only
 LF260092 Stem Only

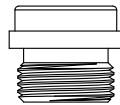

SEAT USED: LF648160

UNKNOWN
 LENGTH: 2.12"

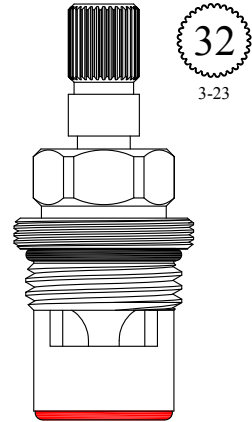

3-23

GASKET: 890170 O-RING INCLUDED
 SEAL: 898570-R/B
 DISC SET: 151380-PKG

LF460371
 LF460372

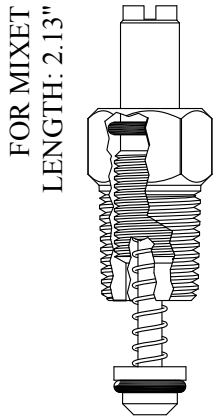

FOR MIXET
LENGTH: 2.13"

400731

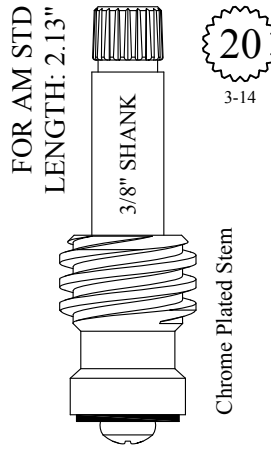

FOR AM STD
LENGTH: 2.13"

20
3-14

3/8" SHANK

Chrome Plated Stem

LF260031
LF260032

USES BARREL:
LF647021/LF647022

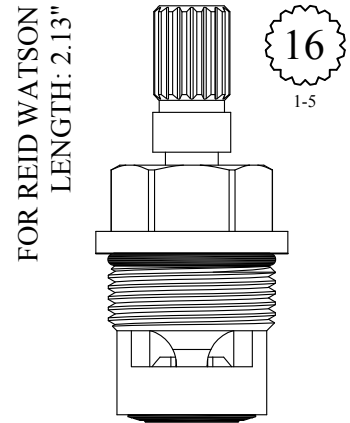

FOR REID WATSON
LENGTH: 2.13"

16
1-5

GASKET: 890180 O-RING INCLUDED
SEAL: 898510
DISC SET: 151380-PKG

LF459451
LF459452

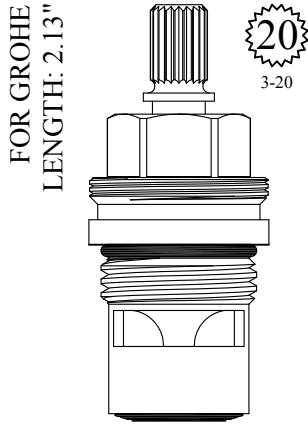

FOR GROHE
LENGTH: 2.13"

20
3-20

GASKET: 890170 O-RING INCLUDED
SEAL: 898510
DISC SET: 151380-PKG

LF459701
LF459702

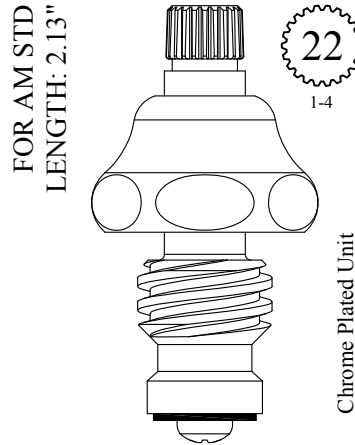

FOR AM STD
LENGTH: 2.13"

22
1-4

Chrome Plated Unit

LF460021
LF460022
LF260021 Stem Only
LF260022 Stem Only

SEAT USED: LF648360

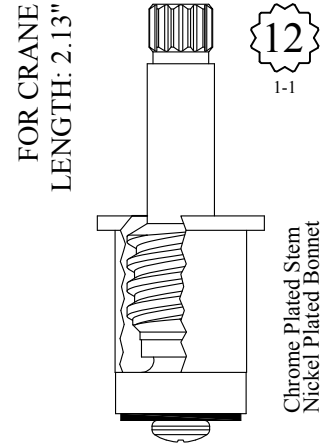
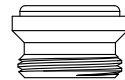

FOR CRANE
LENGTH: 2.13"

12
1-1

Chrome Plated Stem
Nickel Plated Bonnet

LF460041
LF460042

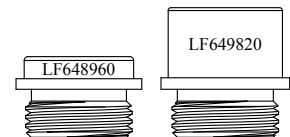

SEAT USED: LF648960 or LF649820

FOR CENTRAL
LENGTH: 2.13"

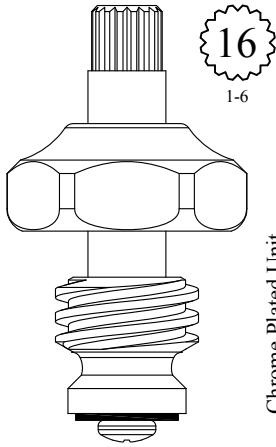

Chrome Plated Unit

LF460061
LF460062
LF260061 Stem Only
LF260062 Stem Only

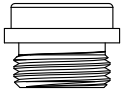

SEAT USED: LF648550

FOR STERLING FAUCET
LENGTH: 2.13"

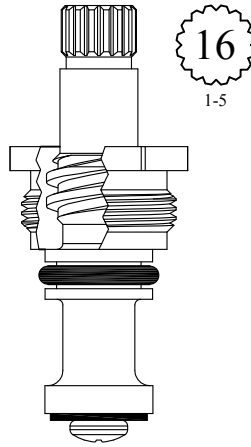

LF460101
LF460102

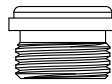

SEAT USED: LF648170

FOR KOHLER
LENGTH: 2.13"

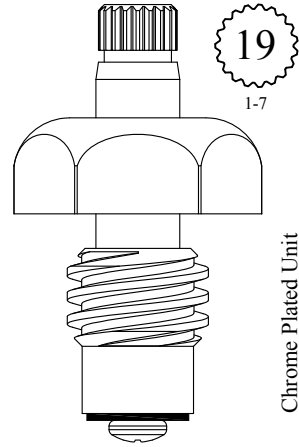

Chrome Plated Unit

LF460161
LF460162
LF260161 Stem Only
LF260162 Stem Only



SEAT USED: LF648730

FOR ACORN
LENGTH: 2.14"

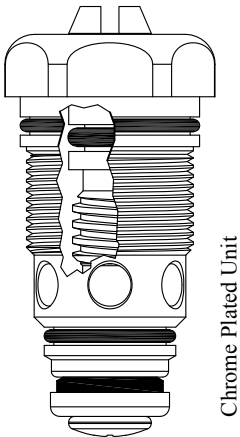

Chrome Plated Unit

461922

FOR AM BRASS
LENGTH: 2.14"

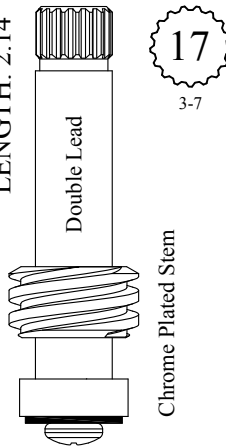

Chrome Plated Stem

LF260011
LF260012



SEAT USED: LF648410

FOR AM BRASS
LENGTH: 2.14"

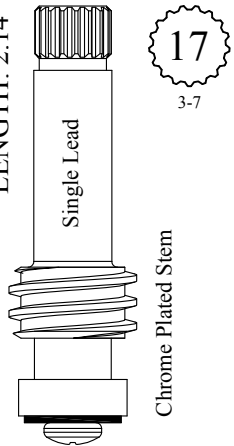

Chrome Plated Stem

LF260211
LF260212



SEAT USED: LF648410

FOR ELJER
LENGTH: 2.14"

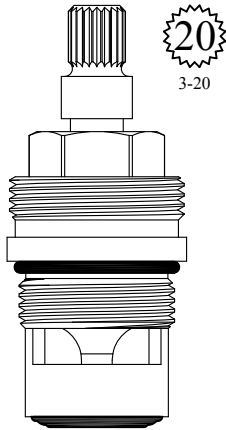

GASKET: 890170 O-RING INCLUDED
SEAL: 898510
DISC SET: 151380-PKG

LF459571
LF459572

FOR KINGSTON BRASS
LENGTH: 2.14"

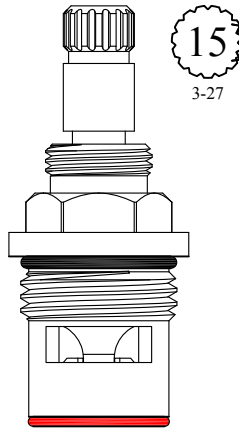

GASKET: 890170 O-RING INCLUDED
SEAL: 898580-R/B
DISC SET: 151380-PKG

LF459711
LF459712

Comes with handle screw:
899230

FOR KALLISTA
LENGTH: 2.14"

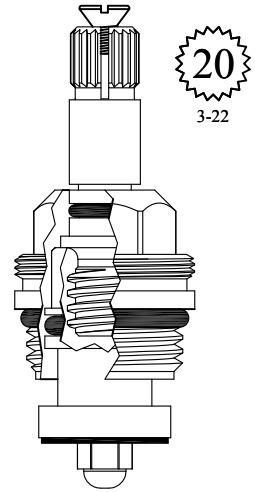

LF459801
LF459802

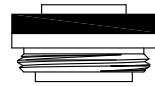

SEAT USED: LF648850-M

FOR MUELLER
LENGTH: 2.15"

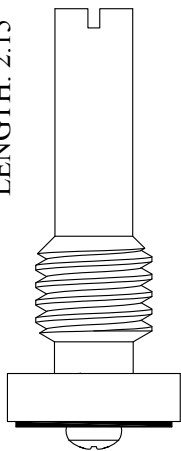

Chrome Plated Stem

201141

UNKNOWN
LENGTH: 2.15"

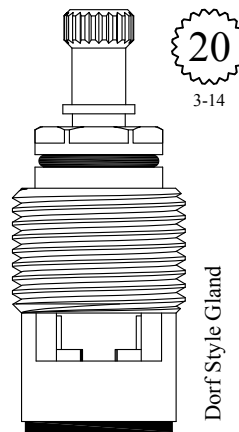

Dorf Style Gland

LF458981

FOR SAYCO
LENGTH: 2.15"

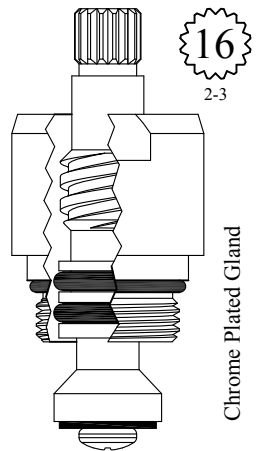

Chrome Plated Gland

GASKET: 890170 O-RING INCLUDED

LF459111
LF459112



SEAT USED: LF647450

FOR OTTONE & MELODA
LENGTH: 2.15"

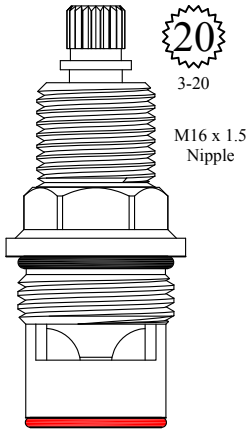

20
3-20

M16 x 1.5
Nipple

GASKET: 890170 O-RING INCLUDED
SEAL: 898580-R/B
DISC SET: 151380-PKG

LF460841
LF460842

FOR DORNBRACHT
LENGTH: 2.16"

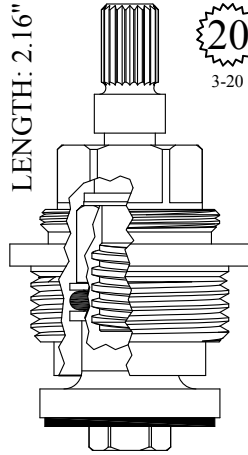

20
3-20

401082



SEAT USED: LF647120

FOR DELTA
LENGTH: 2.16"

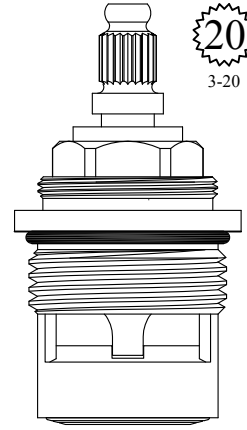

20
3-20

SEAL: 898520
DISC SET: 109850-PKG

401101
401102

FOR GERBER
LENGTH: 2.20"

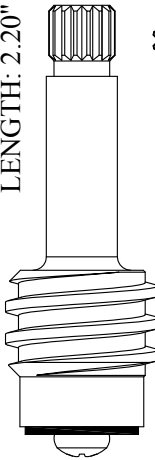

16
2-3

LF261111
LF261112

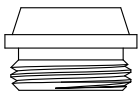

SEAT USED: LF649150

FOR ACORN
LENGTH: 2.16"

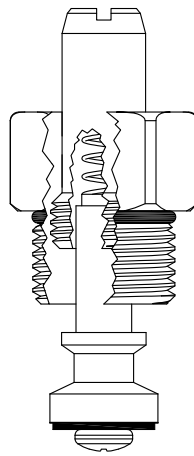

GASKET: 890160 O-RING INCLUDED

LF400571
LF200571 Stem Only

UNKNOWN
LENGTH: 2.16"

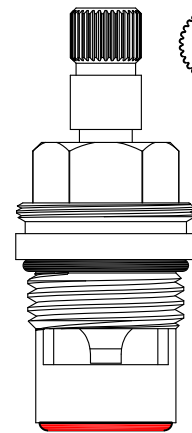

32
3-23

GASKET: 890170 O-RING INCLUDED
SEAL: 898570-R/B
DISC SET: 151380-PKG

LF459361
LF459362

FOR SAVOY
LENGTH: 2.16"

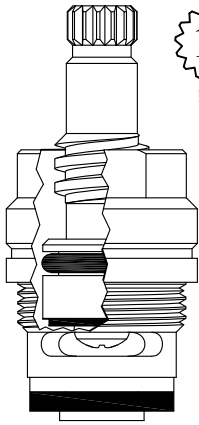

15
1-13

Chrome Plated Gland

Also available with monel seat LF648850-M
LF459631-M / LF459632-M

GASKET: 895150
SEAT INCLUDED: LF648850

LF459631
LF459632

FOR PRINCIPE
LENGTH: 2.16"

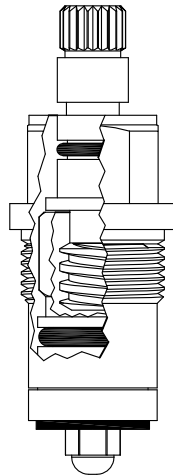

20
11/32
3-34

GASKET: 895100

LF459812

FOR BRIGGS
LENGTH: 2.16"

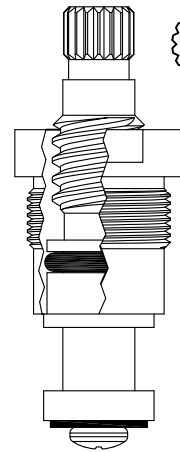

18
3-3

GASKET: 895100

LF461011
LF461012

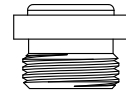

SEAT USED: LF648120

FOR AM STD
LENGTH: 2.16"

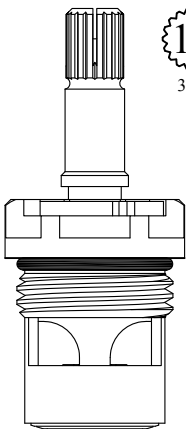

18
3-30

All Brass Unit

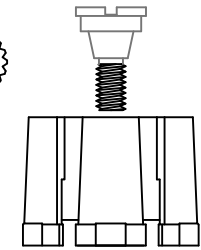

Available with Handle
Bushing and Screw
LF461721

GASKET: 890170 O-RING INCLUDED
SEAL: 898510-W
DISC SET: 151380-PKG

LF461701
LF461702

FOR SEPCO
LENGTH: 2.16"

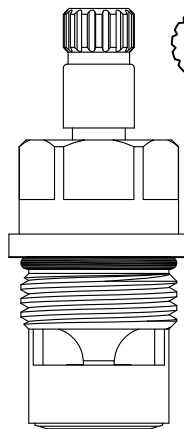

15
3-27

GASKET: 890170 O-RING INCLUDED
SEAL: 898510-W
DISC SET: 151380-PKG

LF462451
LF462452

FOR SAYCO
LENGTH 2.17"

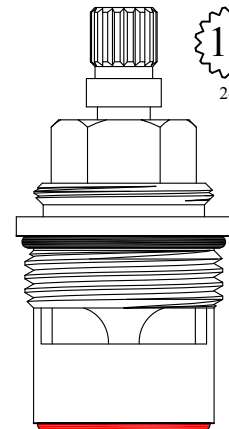

16
2-3

GASKET: 890210 O-RING INCLUDED
SEAL: 898610-R/B
DISC SET: 109850-PKG

401051
401052

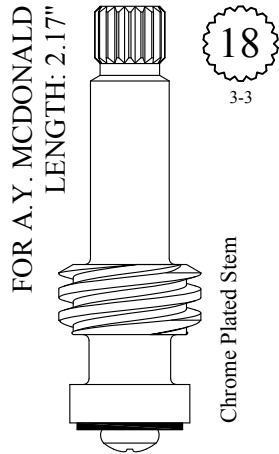

LF261161
LF261162

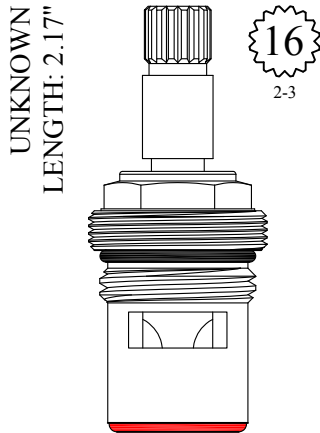

GASKET: 890170 O-RING INCLUDED
SEAL: 898570-R/B
DISC SET: 151380-PKG

LF459661
LF459662

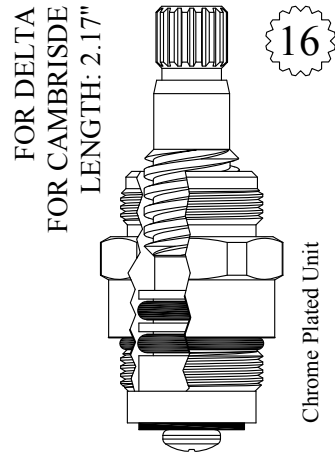

LF460291
LF460292

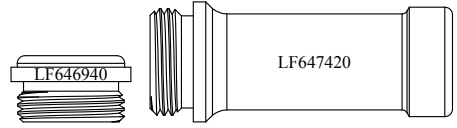

SEAT USED: LF646940 or LF647420

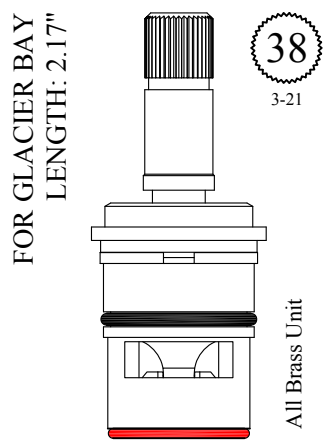

GASKET: 890170 O-RING INCLUDED
SEAL: 898580-R/B
DISC SET: 151380-PKG

LF460611
LF460612

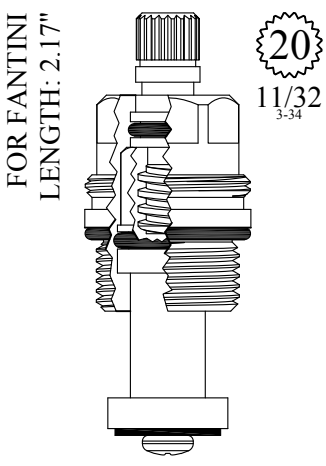

GASKET: 890170 O-RING INCLUDED

LF463332

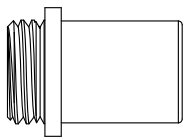

SEAT USED: LF647210

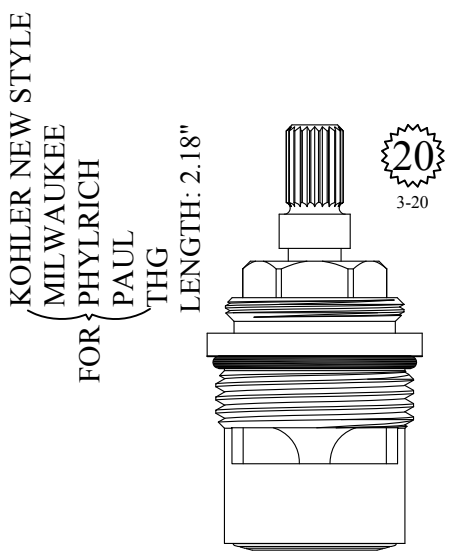

GASKET: 890210 O-RING INCLUDED
SEAL: 898520
DISC SET: 109850-PKG

401121
401122

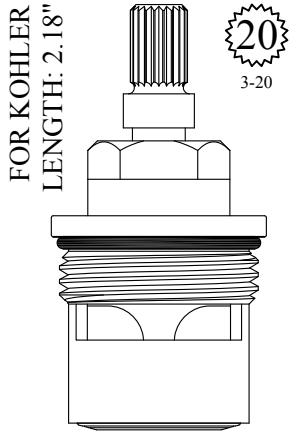

FOR KOHLER
LENGTH: 2.18"

20
3-20

GASKET: 890210 O-RING INCLUDED
SEAL: 898520
DISC SET: 109850-PKG

401271
401272

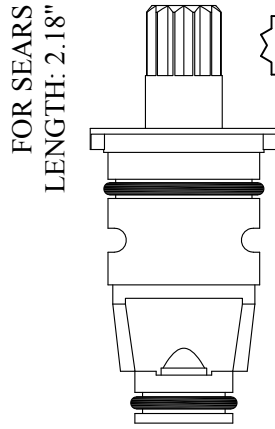

FOR SEARS
LENGTH: 2.18"

12
3-10

All Plastic Unit

459461 Red
459462 Blue

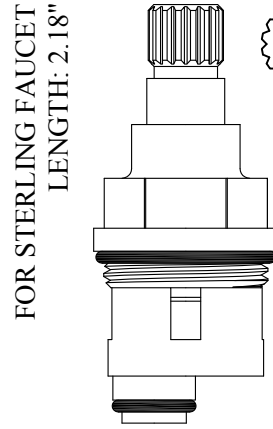

FOR STERLING FAUCET
LENGTH: 2.18"

16
1-5

Nickel Plated Gland

GASKET: 890180 O-RING INCLUDED

LF458181
LF458182

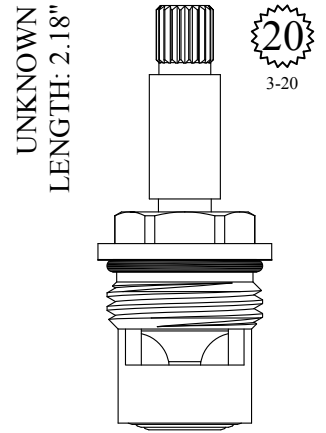

UNKNOWN
LENGTH: 2.18"

20
3-20

GASKET: 890170 O-RING INCLUDED
SEAL: 898500
DISC SET: 112530-PKG

LF459561
LF459562

Also available with cap nut
LF461171-N / LF461172-N

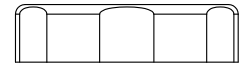

Replaces Midcor
Cartridge

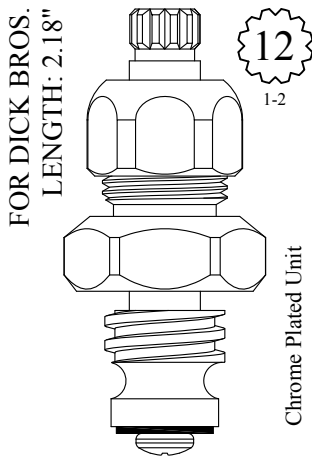

FOR DICK BROS.
LENGTH: 2.18"

12
1-2

Chrome Plated Unit

LF459901
LF259901 Stem Only

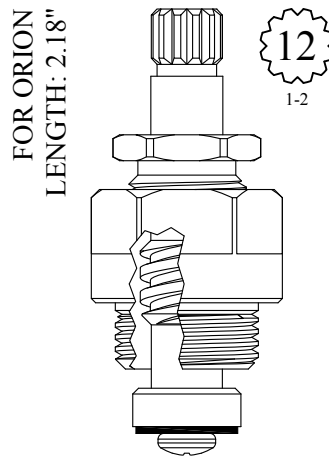

FOR ORION
LENGTH: 2.18"

12
1-2

GASKET: 895100

LF460601

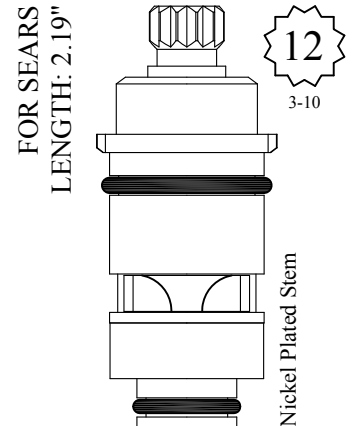

FOR SEARS
LENGTH: 2.19"

12
3-10

Nickel Plated Stem

DISC SET: 151380-PKG

LF461171
LF461172

FOR WATER SAVER
LENGTH: 2.18"

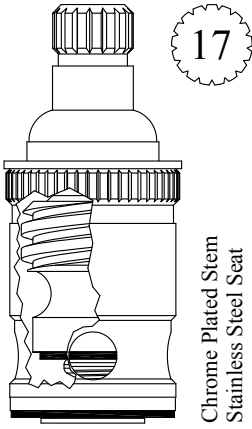

Chrome Plated Stem
Stainless Steel Seat

SEAT INCLUDED: LF648600

LF461301
LF461302

FOR WATER SAVER
LENGTH: 2.18"

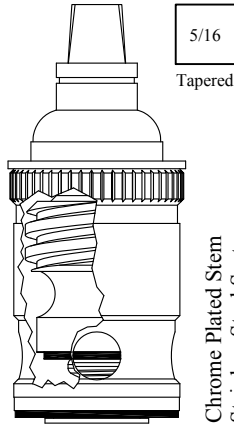

Chrome Plated Stem
Stainless Steel Seat

SEAT INCLUDED: LF648600

LF461311
LF461312

FOR WATER SAVER
LENGTH: 2.18"

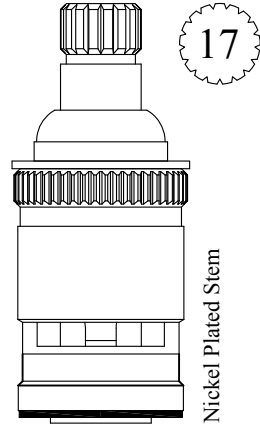

Nickel Plated Stem

DISC SET: 151380-PKG

LF461321
LF461321

FOR BRIGGS
LENGTH: 2.19"

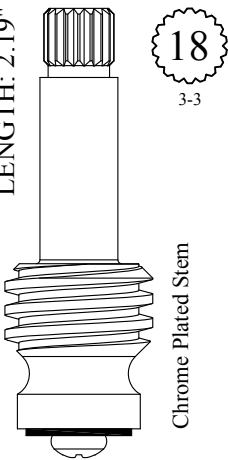

Chrome Plated Stem

201221



SEAT USED: LF649790

FOR DICK BROS.
LENGTH: 2.19"

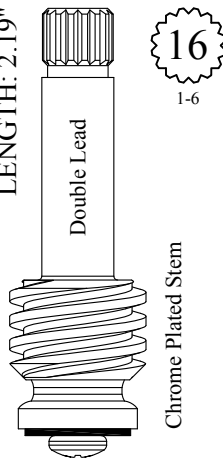

Chrome Plated Stem

LF258111
LF258112



SEAT USED: LF649760

FOR DICK BROS.
LENGTH: 2.19"

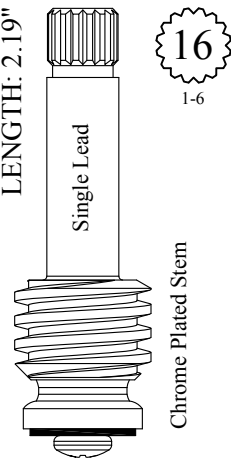

Chrome Plated Stem

LF261061
LF261062

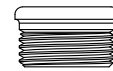

SEAT USED: LF649760

FOR AM BRASS
LENGTH: 2.19"

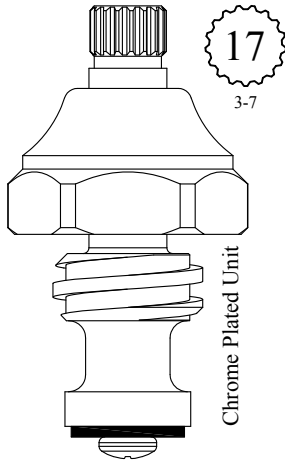

Chrome Plated Unit

LF460241
LF460242
LF260241 Stem Only
LF260242 Stem Only

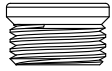

SEAT USED: LF648410

FOR SEARS
LENGTH: 2.19"

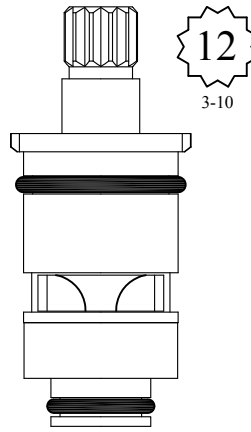

DISC SET: 151380-PKG

LF461071
LF461072

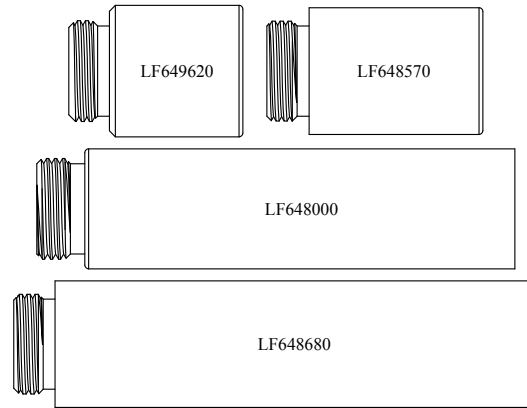

SEATS USED: LF648000, LF648570, LF648680 & LF649620

FOR SYSTEM
LENGTH: 2.19"

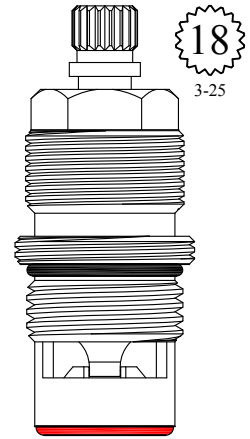

GASKET: 890170 O-RING INCLUDED
SEAL: 898570-R/B
DISC SET: 151380-PKG

LF460711
LF460712

Also available with cap nut

LF461171-N / LF461172-N

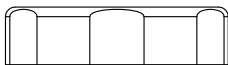

Replaces Midcor
Cartridge

FOR SEARS
LENGTH: 2.19"

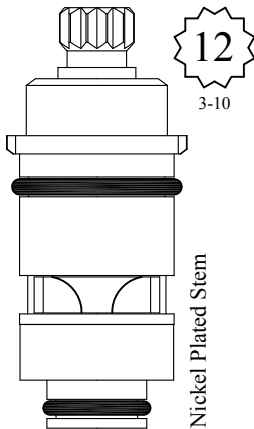

Nickel Plated Stem

DISC SET: 151380-PKG

LF461171
LF461172

LENGTH: 2.20"

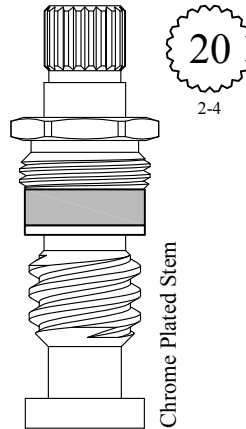

Chrome Plated Stem

401131
201131 Stem Only



SEAT USED: 648190

FOR DORNBRACHT
LENGTH: 2.20"

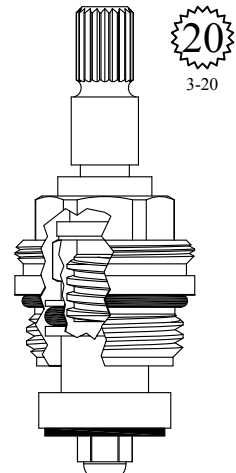

GASKET: 890170 O-RING INCLUDED

LF459512



SEAT USED: LF647110

Double Lead

FOR PRICE PFISTER
LENGTH: 2.20"

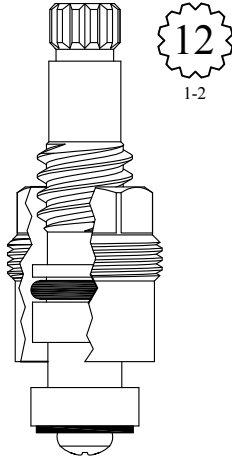

GASKET: 895060

LF461031
LF461032



SEAT USED: LF648270

Single Lead

FOR PRICE PFISTER
LENGTH: 2.20"

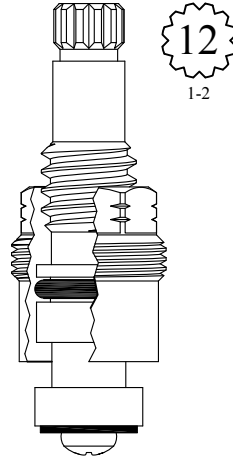

GASKET: 895060

LF461231

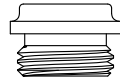

SEAT USED: LF648270

FOR CRANE
LENGTH: 2.20"

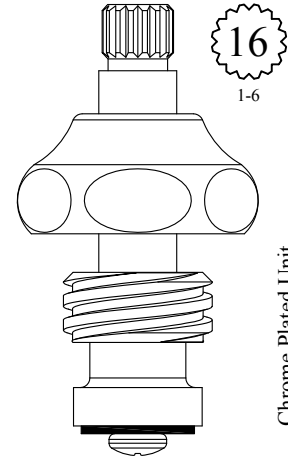

Chrome Plated Unit

LF461041

LF461042

LF261041 Stem Only

LF261042 Stem Only

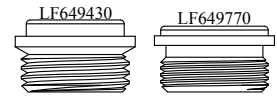

SEAT USED: LF649430 or LF649770

FOR ROHL
LENGTH: 2.21"

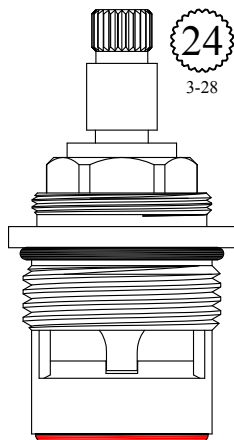

GASKET: 890210 O-RING INCLUDED
SEAL: 898610-R/B
DISC SET: 109850-PKG

401031
401032

FOR HAWS
LENGTH: 2.21"

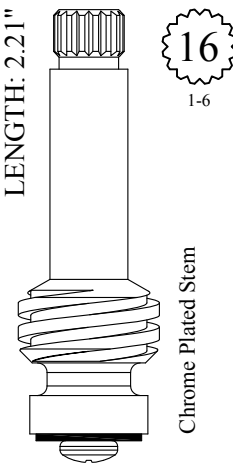

Chrome Plated Stem

LF262161

FOR JADO
LENGTH 2.22"

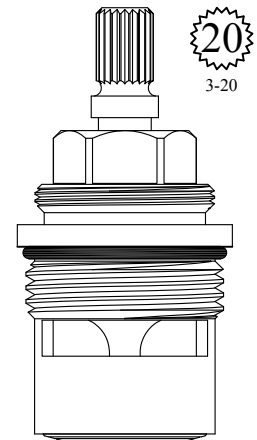

GASKET: 890210 O-RING INCLUDED
SEAL: 898520
DISC SET: 109850-PKG

401161
401162

FOR SEARS
LENGTH: 2.22"

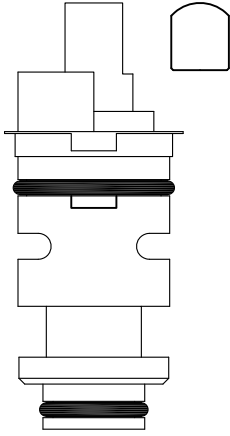

459621 Red
459622 Blue

FOR SEARS
LENGTH: 2.22"

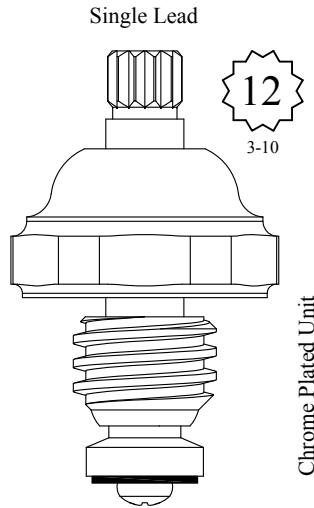

LF463021
LF263021 Stem Only



SEAT USED: LF648700

FOR SEARS
LENGTH: 2.22"

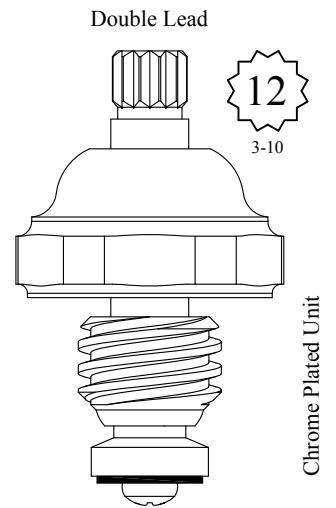

LF463031
LF463032
LF263031 Stem Only
LF263032 Stem Only



SEAT USED: LF648700

FOR DORNBRACHT
LENGTH: 2.52"

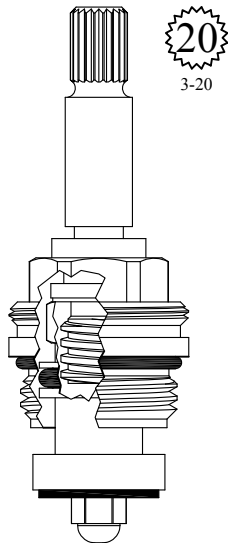

GASKET: 890170 O-RING INCLUDED

LF463872



SEAT USED: LF647110

FOR SIGN OF THE CRAB
LENGTH: 2.23"

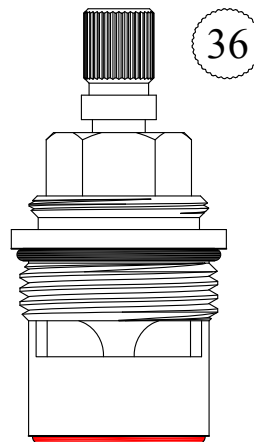

GASKET: 890210 O-RING INCLUDED
SEAL: 898610-R/B
DISC SET: 109850-PKG

400981
400982

Comes with handle screw: # 899230

FOR KALLISTA
LENGTH: 2.23"

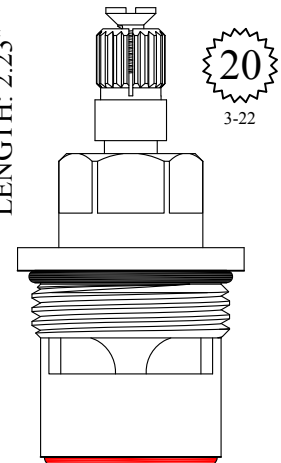

GASKET: 890210 O-RING INCLUDED
SEAL: 898610-R/B
DISC SET: 109850-PKG

401091
401092

FOR STERLING FAUCET
LENGTH: 2.23"

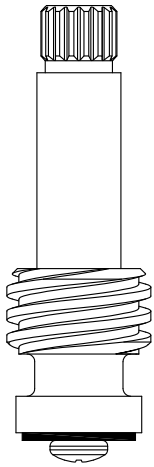

16
1-5

Chrome Plated Stem

LF261051
LF261052

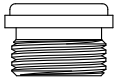

SEAT USED: LF648170

FOR KALLISTA
LENGTH: 2.23"

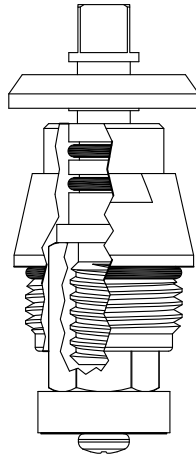

9/32

GASKET: 890170 O-RING INCLUDED

LF460652

FOR KALLISTA
LENGTH: 2.23"

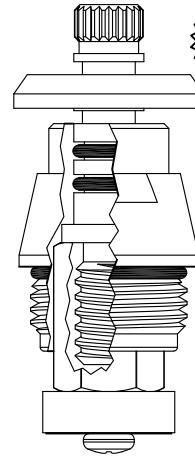

20
3-22

GASKET: 890170 O-RING INCLUDED

LF460672

FOR BRASSCRAFT
LENGTH: 2.23"

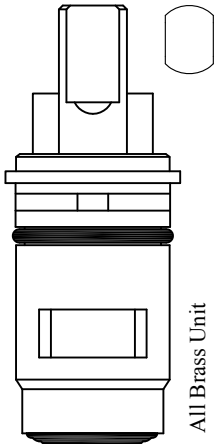

All Brass Unit

SEAL: 898510
DISC SET: 124290-PKG

LF460721

FOR T & S
LENGTH: 2.23"

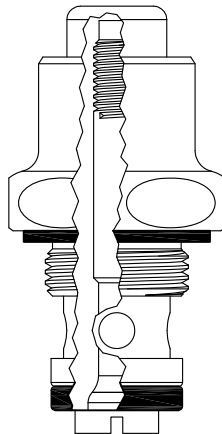

Chrome Plated Unit

GASKET: 895260 INCLUDED

LF462400

UNKNOWN
LENGTH: 2.24"

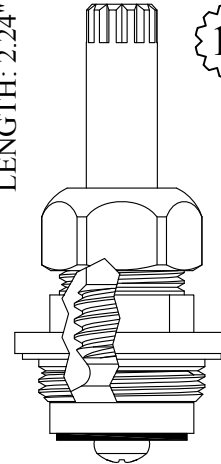

12
1-2

GASKET: 895400

191041

FOR LAWLER
LENGTH: 2.24"

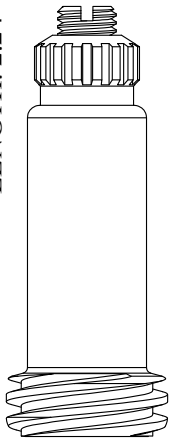

Chrome Plated Stem

201021

FOR STERLING FAUCET
LENGTH: 2.24"

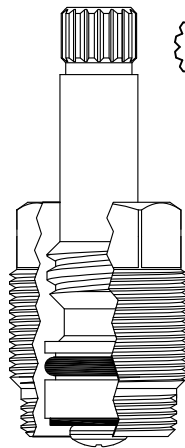

1-5

GASKET: 895160

401111
401112



SEAT USED: LF648170

FOR SPEAKMAN
LENGTH: 2.24"

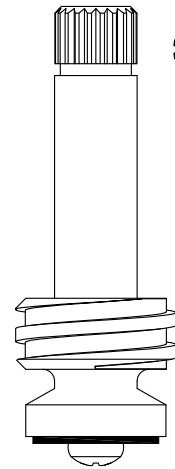

2-4

Chrome Plated Stem

LF263041
LF263042



SEAT USED: LF648930

UNKNOWN
LENGTH: 2.24"

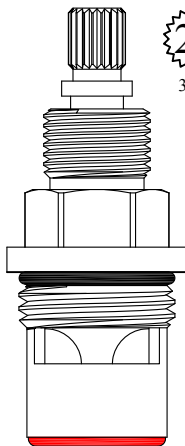

3-20

Chrome Plated Unit

GASKET: 890170 O-RING INCLUDED
SEAL: 898570-R/B
DISC SET: 151380-PKG

LF460341
LF460342

FOR NEWPORT
LENGTH: 2.24"

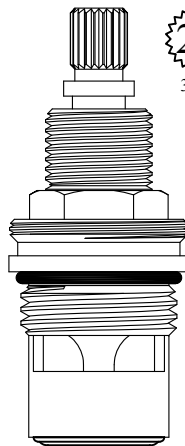

3-20

Chrome Plated Stem

GASKET: 890170 O-RING INCLUDED
SEAL: 898510-W
DISC SET: 151380-PKG

LF460361
LF460362

FOR ARMONIA
LENGTH: 2.24"

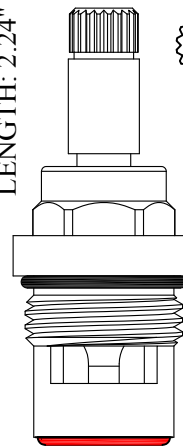

3-14

GASKET: 890170 O-RING INCLUDED
SEAL: 898570-R/B
DISC SET: 151380-PKG

LF461861
LF461862

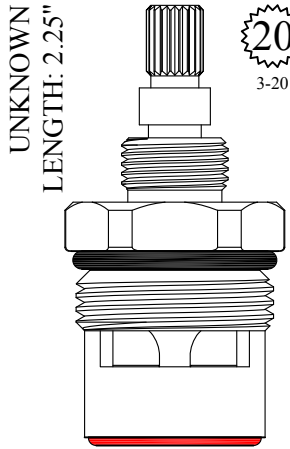

UNKNOWN
LENGTH: 2.25"

20
3-20

GASKET: 890170 O-RING INCLUDED
SEAL: 898610-R/B
DISC SET: 109850-PKG

401441
401442

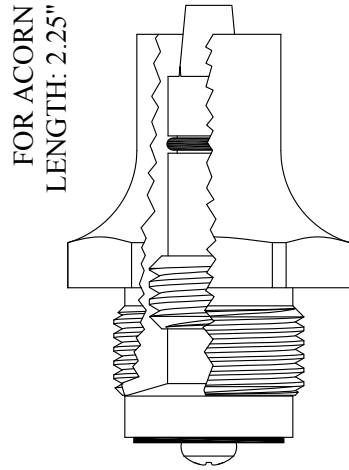

FOR ACORN
LENGTH: 2.25"

20
3-20

GASKET: 895570

483121

Chrome Plated Bonnet

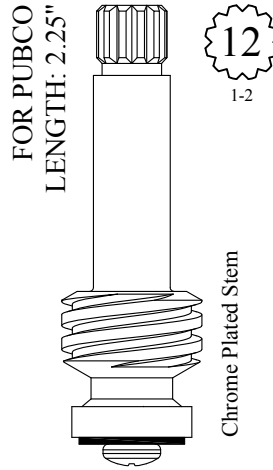

FOR PUBCO
LENGTH: 2.25"

12
1-2

Chrome Plated Stem

LF262041
LF262042

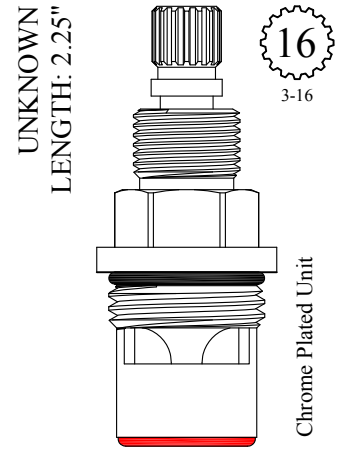

UNKNOWN
LENGTH: 2.25"

16
3-16

GASKET: 890170 O-RING INCLUDED
SEAL: 898570-R/B
DISC SET: 151380-PKG

LF461341
LF461342

Chrome Plated Unit

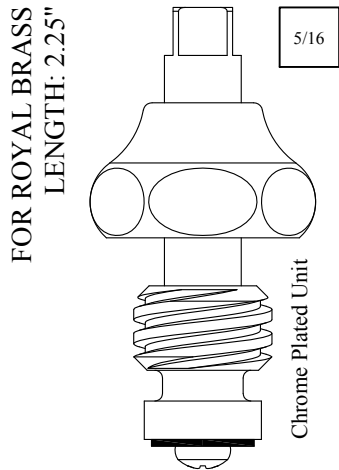

FOR ROYAL BRASS
LENGTH: 2.25"

5/16

Chrome Plated Unit

LF461831
LF461832
LF261831 Stem Only
LF261832 Stem Only



SEAT USED: LF648260

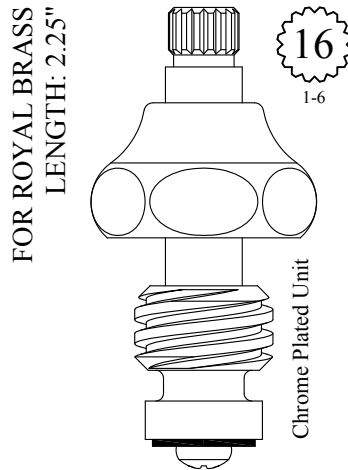

FOR ROYAL BRASS
LENGTH: 2.25"

16
1-6

Chrome Plated Unit

LF461841
LF461842
LF261841 Stem Only
LF261842 Stem Only



SEAT USED: LF648260

Also available with handle ABRF132601

LF462201-32601
LF462202-32601

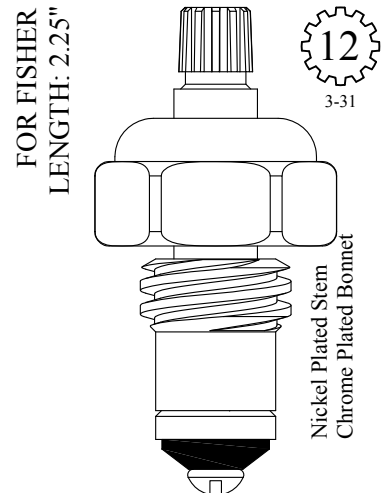

FOR FISHER
LENGTH: 2.25"

12
3-31

Nickel Plated Stem
Chrome Plated Bonnet

GASKET: INCLUDED

LF462201
LF462202
LF262201 Stem Only
LF262202 Stem Only

UNKNOWN
LENGTH: 2.25"

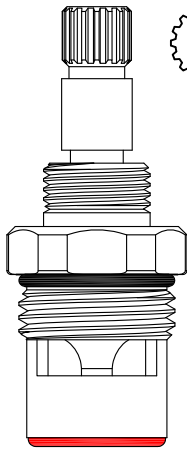

16
3-16

Chrome Plated Unit

GASKET: 890170 O-RING INCLUDED
SEAL: 898570-R/B
DISC SET: 151380-PKG

LF462311
LF462312

FOR WOLVERINE
LENGTH: 2.25"

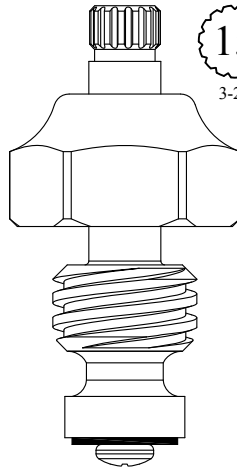

15
3-27

Chrome Plated Stem
Nickel Plated Bonnet

LF463081
LF463082
LF263081 Stem Only
LF263082 Stem Only

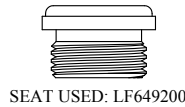

SEAT USED: LF649200

FOR AM STD
LENGTH: 2.25"

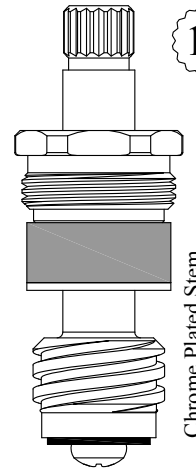

16

Chrome Plated Stem

LF461091
LF461092
LF261091 Stem Only
LF261092 Stem Only



SEAT USED: LF648350

Also available with handle ABRFI32601

LF462211-32601
LF462212-32601

FOR FISHER
LENGTH: 2.25"

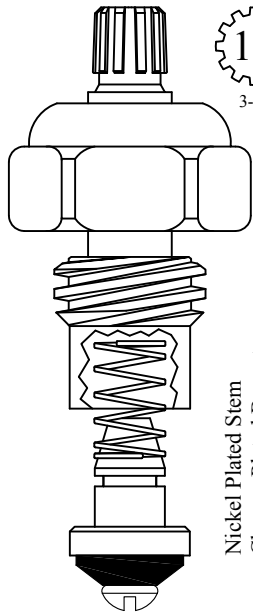

12
3-31

Nickel Plated Stem
Chrome Plated Bonnet

LF462211
LF462212
LF262211 Stem Only
LF262212 Stem Only

Also available with handle ABRFI32601

LF462031-32601
LF462032-32601

FOR FISHER
LENGTH: 2.26"

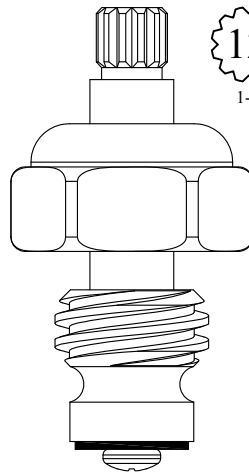

12
1-2

Nickel Plated Stem
Chrome Plated Bonnet

LF462031
LF462032
LF262031 Stem Only
LF262032 Stem Only

FOR MIXET
LENGTH 2.27"

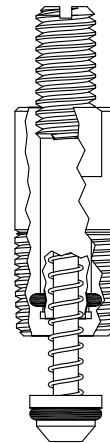

400901



SEAT USED: LF649380

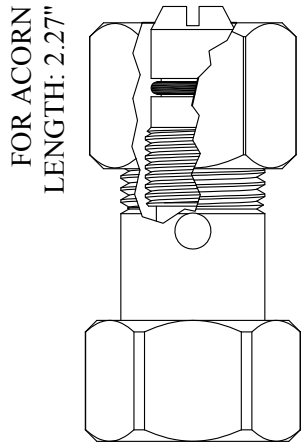

LF138921
LF136401 Stem Only

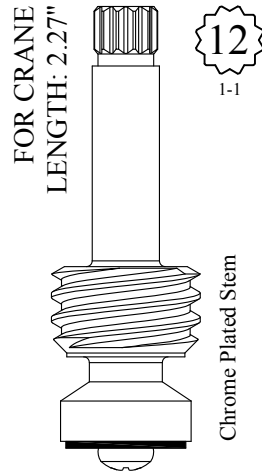

LF261151
LF261152

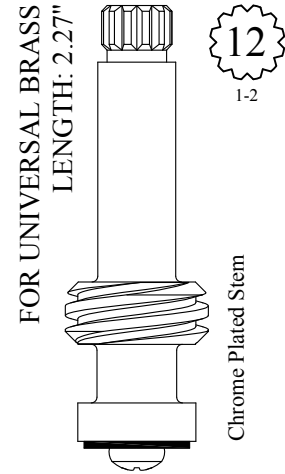

LF263061
LF263062

Packing Nut pictured for identification purposes only

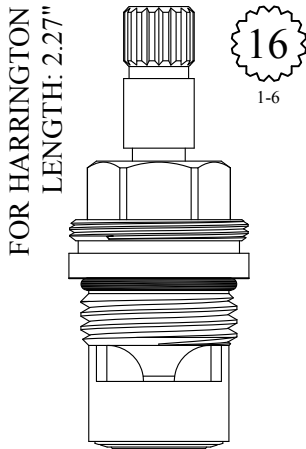

GASKET: 890170 O-RING INCLUDED
SEAL: 898510-W
DISC SET: 151380-PKG

LF462541
LF462542

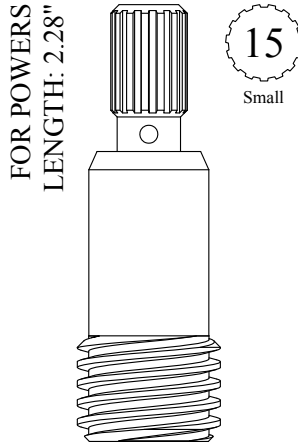

201181

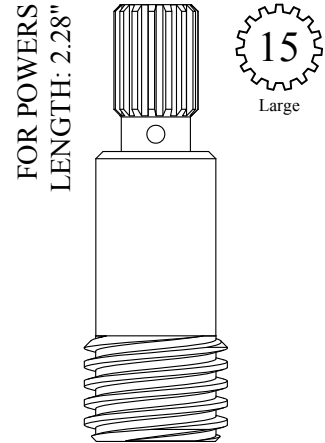

201201

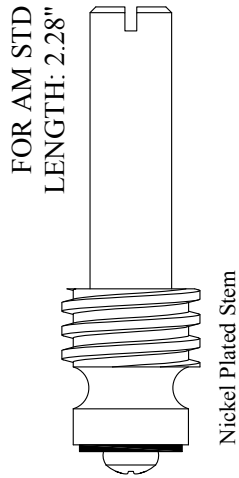

261131

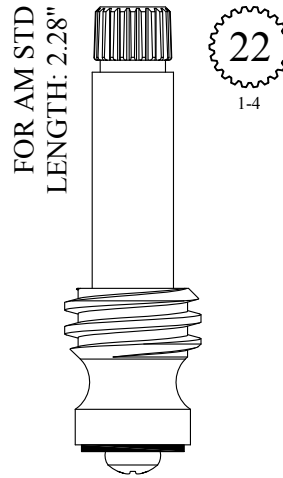

263281

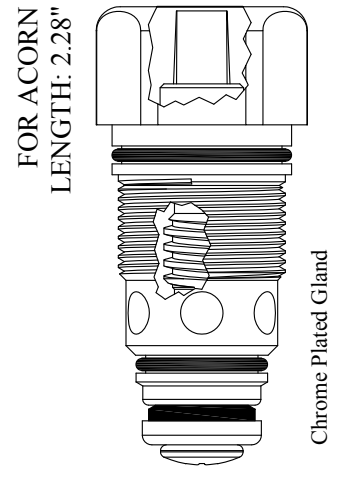

462702

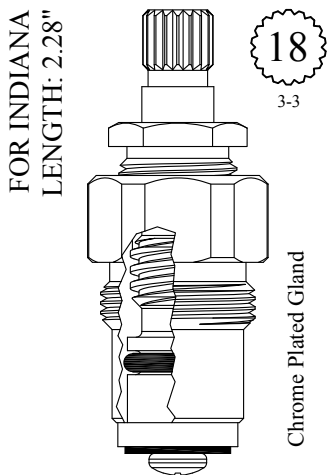

GASKET: 890170 O-RING INCLUDED

LF461951
LF461952

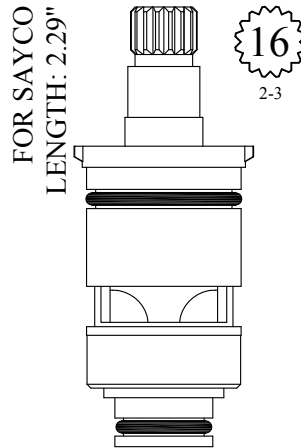

DISC SET: 151380-PKG

LF459611
LF459612

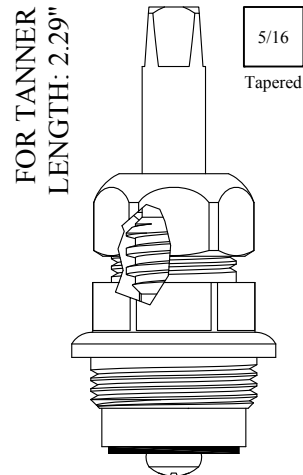

GASKET: 895400

462561

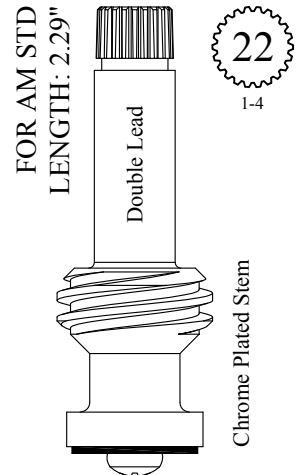

LF263231
LF263232

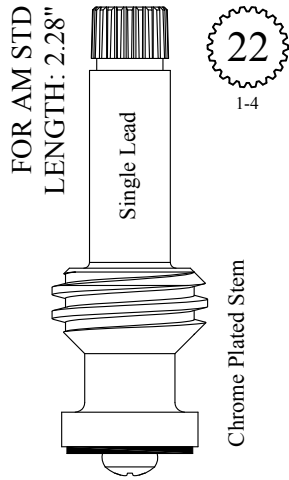

LF263241

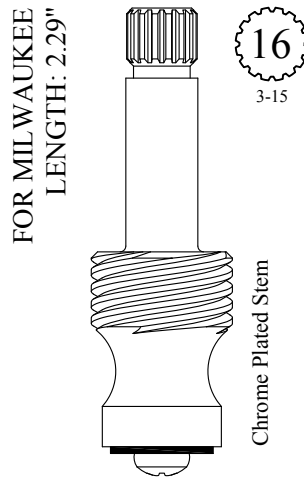

LF264231
LF264232

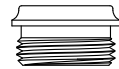

SEAT USED: LF649040

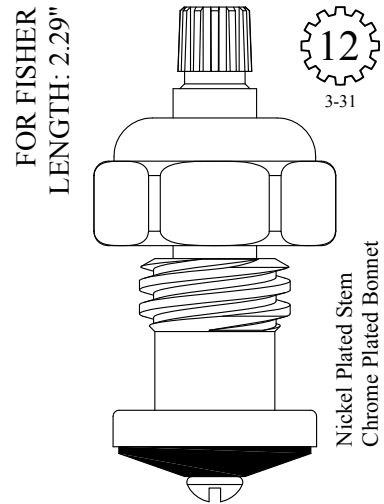

GASKET: INCLUDED

LF462221
LF462222
LF262221 Stem Only
LF262222 Stem Only

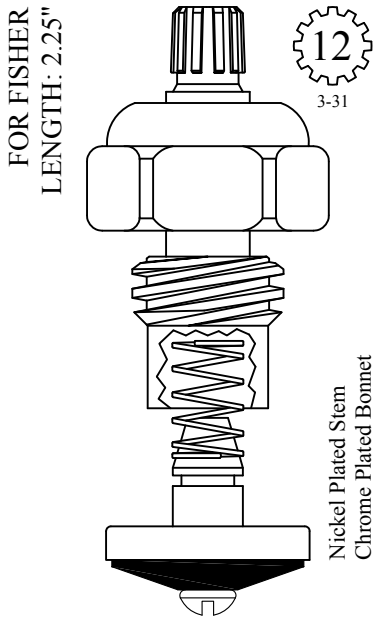

LF462231
LF462232
LF262231 Stem Only
LF262232 Stem Only

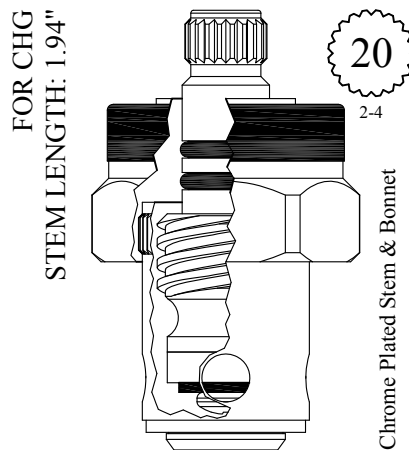

LF462571
LF462572

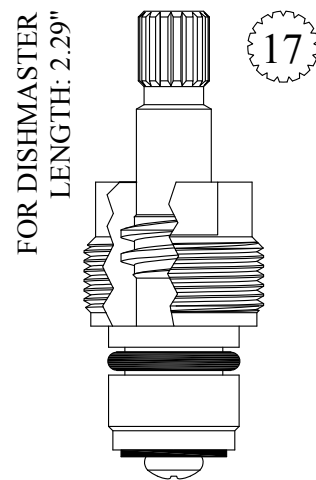

LF463051
LF463052



SEAT USED: LF649450

FOR ELJER
LENGTH: 2.29"

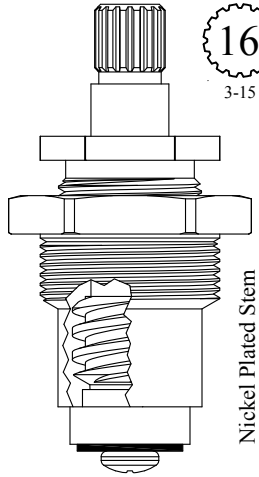

16
3-15

Nickel Plated Stem

GASKET: 895330

LF463071
LF463072
LF263071 Stem Only
LF263072 Stem Only



SEAT USED: LF648160

FOR ELJER
LENGTH: 2.29"

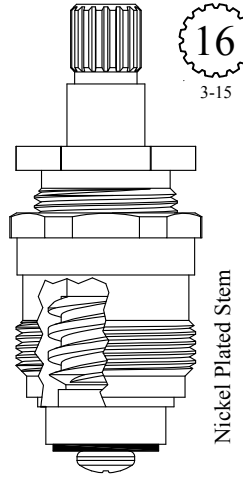

16
3-15

Nickel Plated Stem

GASKET: 895120

LF463171
LF463172
LF263071 Stem Only
LF263072 Stem Only

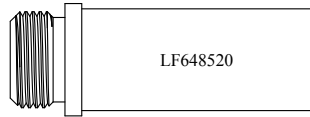
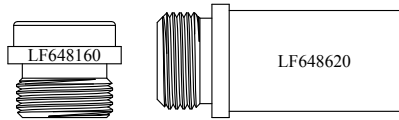

SEATS USED: LF648160, LF648520 & LF648620

FOR ELJER
LENGTH: 2.30"

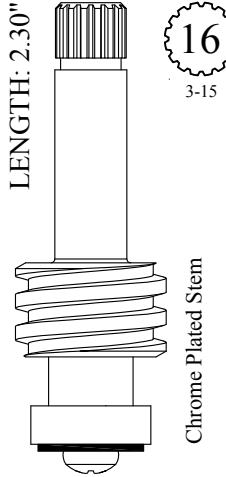

16
3-15

Chrome Plated Stem

LF260201
LF260202

FOR AM STD
LENGTH: 2.30"



LF261120

FOR MILWAUKEE
LENGTH: 2.29"

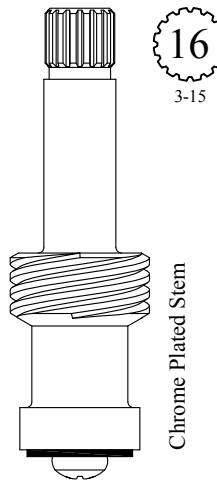

16
3-15

Chrome Plated Stem

LF263181
LF263182



SEAT USED: LF649040

FOR CENTRAL
LENGTH: 2.30"

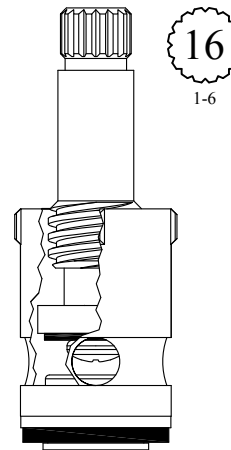

16
1-6

SEAT INCLUDED:
LF647850

LF462051
LF462052

FOR CENTRAL
LENGTH: 2.30"

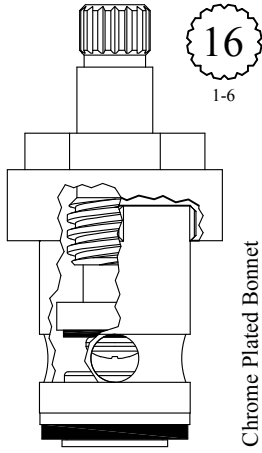

SEAT INCLUDED:
LF647850

LF462151
LF462152

UNKNOWN
LENGTH: 2.30"

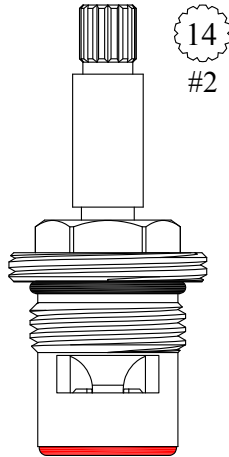

GASKET: 890170 O-RING INCLUDED
SEAL: 898570-R/B
DISC SET: 151380-PKG

LF462431
LF462432

FOR ALTMANS
LENGTH: 2.30"

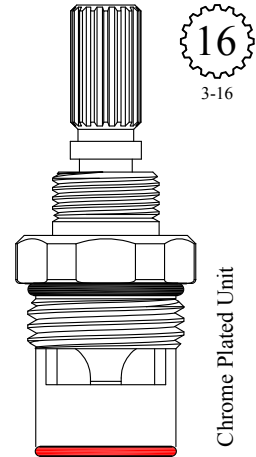

GASKET: 890170 O-RING INCLUDED
SEAL: 898580-R/B
DISC SET: 151380-PKG

LF462411
LF462412

UNKNOWN
LENGTH: 2.30"

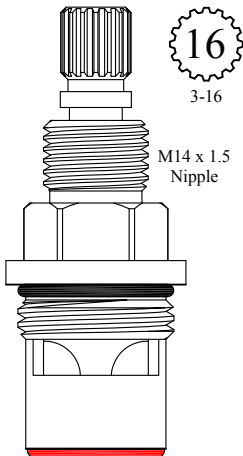

GASKET: 890170 O-RING INCLUDED
SEAL: 898570-R/B
DISC SET: 151380-PKG

LF462641
LF462642

FOR PEGASUS
LENGTH: 2.30"

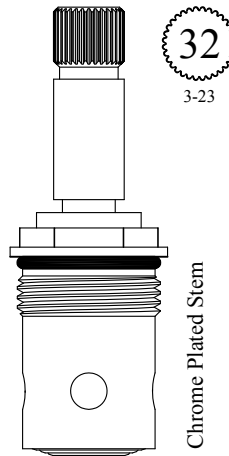

GASKET: 890160 O-RING INCLUDED
SEAL: 898500
DISC SET: 112530-PKG

LF462901
LF462902

FOR TANNER
LENGTH: 2.31"

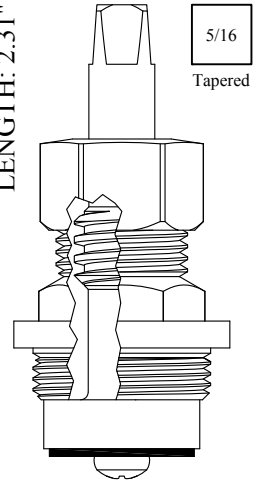

GASKET: 895370

468031

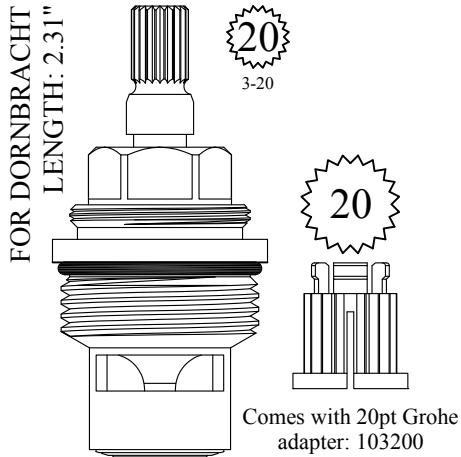

GASKET: 890210 O-RING INCLUDED
SEAL: 898510-W
DISC SET: 151380-PKG

401171
401172

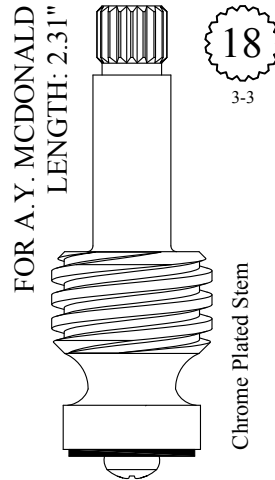

LF262341
LF262342

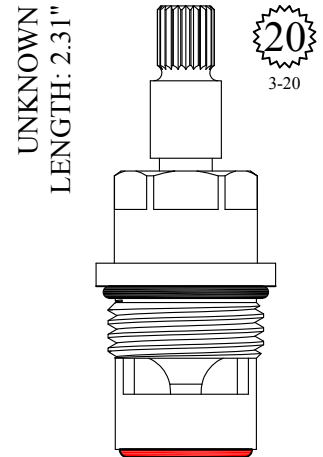

GASKET: 890170 O-RING INCLUDED
SEAL: 898570-R/B
DISC SET: 151380-PKG

LF461401
LF461402

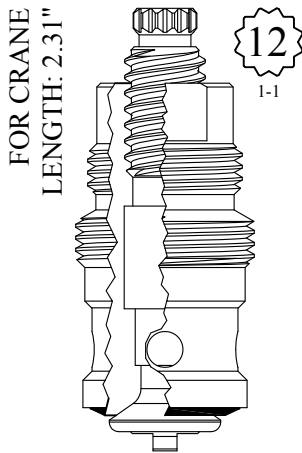

GASKET: 895250

LF462011
LF462012
LF262011 Stem Only
LF262012 Stem Only

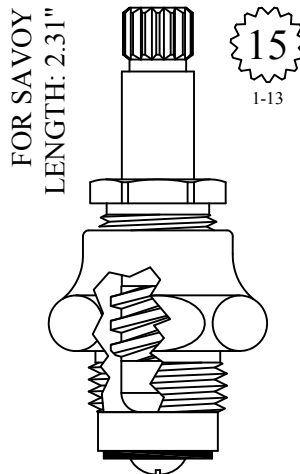

GASKET: 895100

LF462121

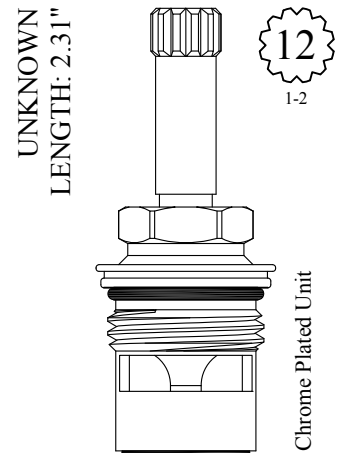

GASKET: 890170 O-RING INCLUDED
SEAL: 898510
DISC SET: 151380-PKG

LF462551
LF462552

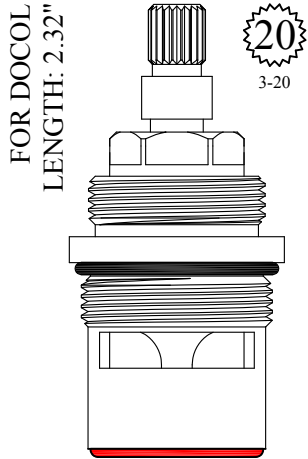

FOR DOCOL
LENGTH: 2.32"

20
3-20

GASKET: 890210 O-RING INCLUDED
SEAL: 898610
DISC SET: 109850-PKG

401041
401042

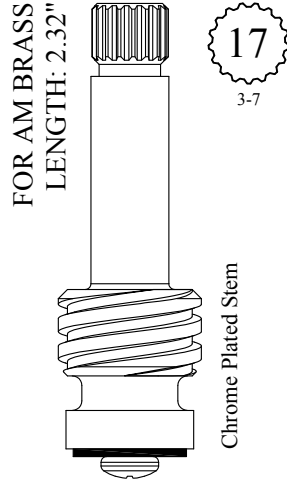

FOR AM BRASS
LENGTH: 2.32"

17
3-7

Chrome Plated Stem

LF262021
LF262022

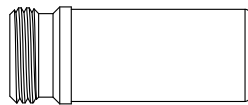

SEAT USED: LF649240

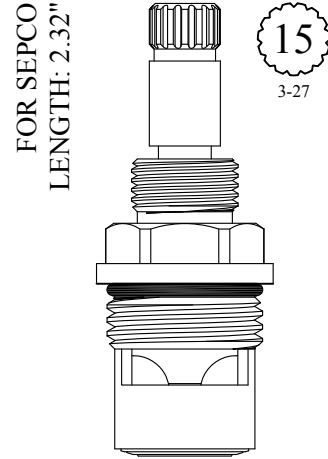

FOR SEPCO
LENGTH: 2.32"

15
3-27

GASKET: 890170 O-RING INCLUDED
SEAL: 898510-W
DISC SET: 151380-PKG

LF459721
LF459722

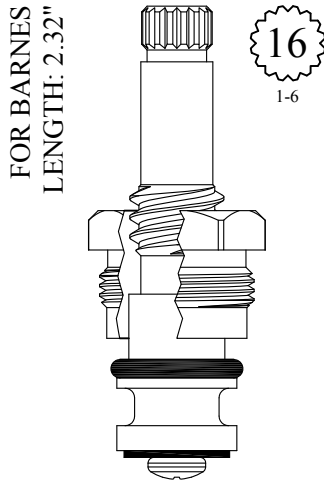

FOR BARNES
LENGTH: 2.32"

16
1-6

LF462061



SEAT USED: LF648350

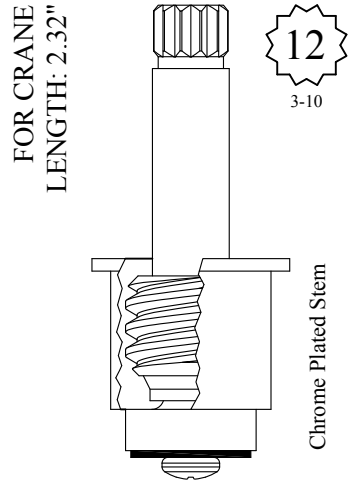

FOR CRANE
LENGTH: 2.32"

12
3-10

Chrome Plated Stem

LF462131
LF262131 Stem Only

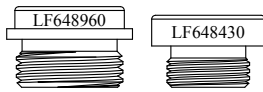

SEAT USED: LF648960 or LF648430

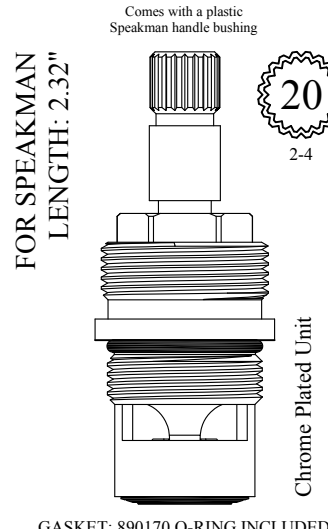

FOR SPEAKMAN
LENGTH: 2.32"

20
2-4

Comes with a plastic
Speakman handle bushing

Chrome Plated Unit

GASKET: 890170 O-RING INCLUDED
SEAL: 898510
DISC SET: 151380-PKG

LF462501
LF462502

FOR SPEAKMAN
LENGTH: 2.32"

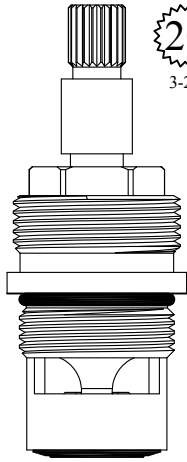

20
3-20

Chrome Plated Unit

GASKET: 890170 O-RING INCLUDED
SEAL: 898510
DISC SET: 151380-PKG

LF462511
LF462512

UNKNOWN
LENGTH: 2.33"

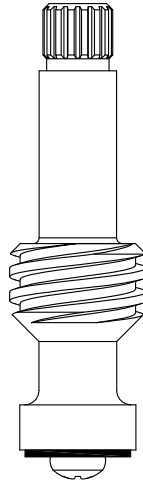

16
3-15

Chrome Plated Stem

201191
201192

FOR ADVANCED TABCO
LENGTH: 2.34"

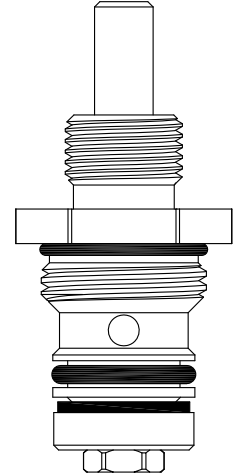

Chrome Plated Unit

GASKET: 890180 O-RING INCLUDED

LF464450
LF264450 Stem Only

FOR DISHMASTER
LENGTH: 2.34"

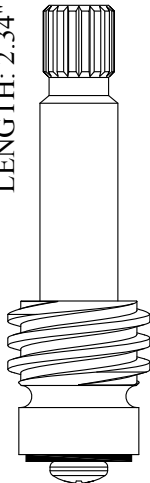

17

Chrome Plated Stem

LF263191
LF263192

FOR HARCRAFT
LENGTH: 2.34"

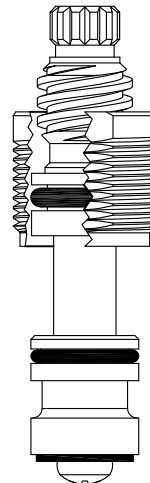

12
1-2

GASKET: 895040 INCLUDED

LF462091

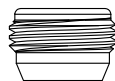

SEAT USED: LF648670

FOR KOHLER
LENGTH: 2.34"

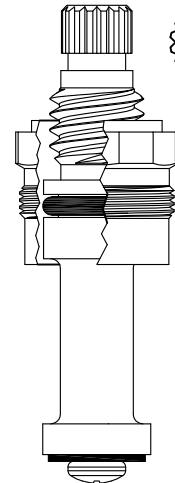

16
1-6

Nickel Plated Gland

GASKET: 895060

LF462101
LF462102

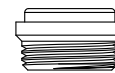

SEAT USED: LF648070

FOR KOHLER
LENGTH: 2.34"

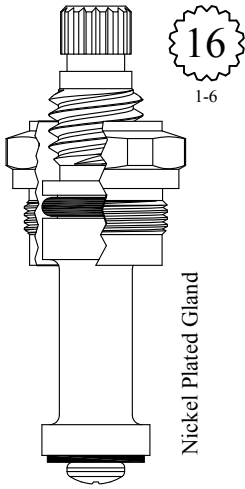

16
1-6

Nickel Plated Gland

GASKET: 895060

LF462141
LF462142



SEAT USED: LF648070

FOR DORNBRACHT
LENGTH: 2.34"

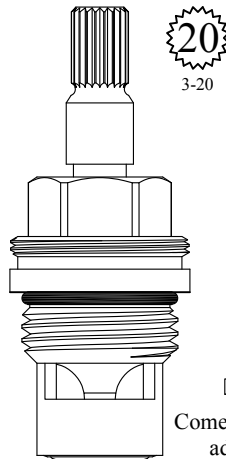

20
3-20

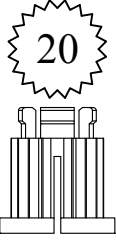

Comes with 20pt Grohe
adapter: 103200

GASKET: 890170 O-RING INCLUDED
SEAL: 898500
DISC SET: 112530-PKG

LF462601
LF462602

FOR TWYFORD BATHROOM
LENGTH: 2.35"

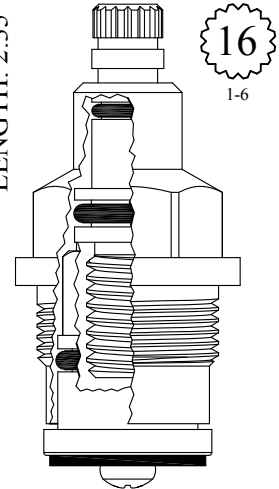

16
1-6

GASKET: 895370

401372

Supplied with
12pt. Broach

FOR CALIFORNIA BRASS
LENGTH: 2.33"

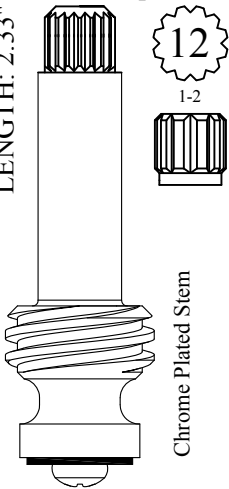

12
1-2

Chrome Plated Stem

LF263141
LF263142

UNKNOWN
LENGTH: 2.35"

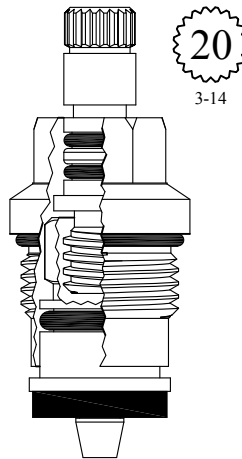

20
3-14

GASKET: 890180 O-RING INCLUDED

LF459482

FOR CRANE
LENGTH: 2.35"

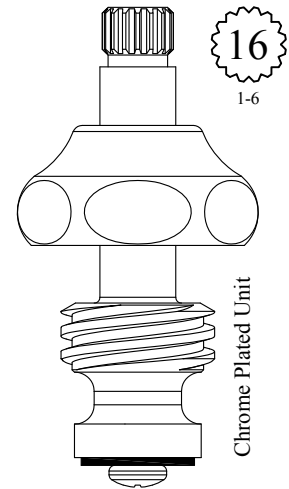

16
1-6

Chrome Plated Unit

LF461931
LF261931 Stem Only

FOR BURLINGTON
LENGTH: 2.35"

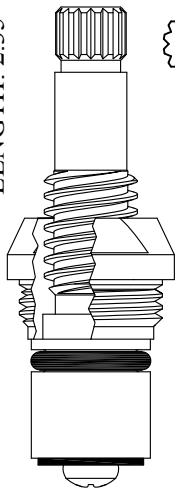

16
1-6

Nickel Plated Gland

LF462111
LF462112



SEAT USED: LF648700

FOR AM STD
STEM LENGTH: 2.36"

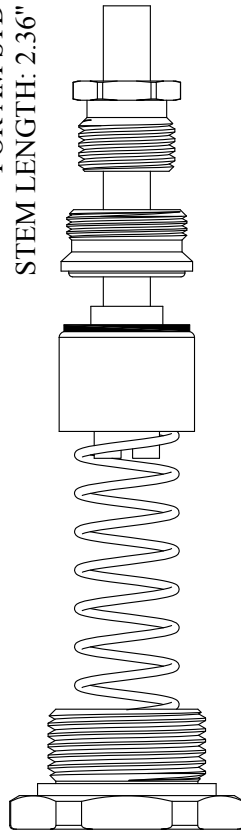

SEAT INCLUDED: LF649870

LF152150 Stem Only
LF124660 Repair Kit

FOR BARDES
LENGTH: 2.36"

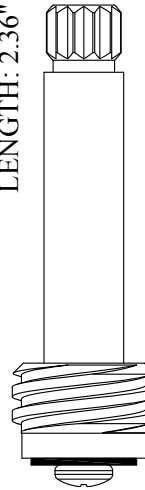

12
3-10

LF264241
LF264242

FOR PIEL
LENGTH 2.36"

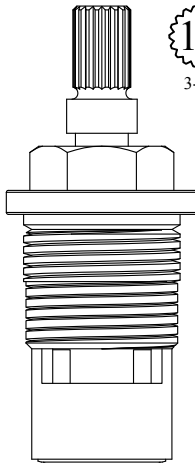

18
3-30

GASKET: 895150 INCLUDED
SEAL: 898510-W
DISC SET: 151380-PKG

LF462661
LF462662

FOR DELTA (CER-TECK)
FOR CAMBRIDGE
LENGTH: 2.36"

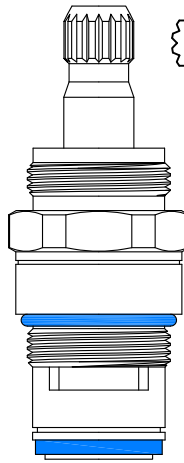

16
1-6

Chrome Plated Unit

LF462711
LF462712

FOR PERLICK
LENGTH: 2.36"

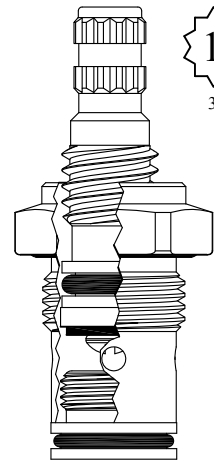

12
3-10

GASKET: 890180 O-RING INCLUDED

LF463351
LF463352

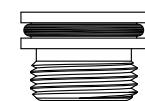

SEAT USED: LF663350

FOR SEARS
LENGTH: 2.37"

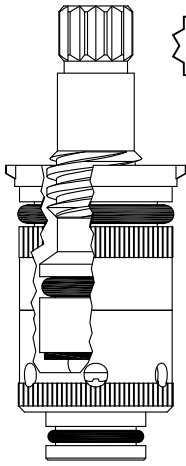

12
3-10

LF461081
LF461082

Also available less seat
LF461081-LS/ LF461082-LS

FOR SEARS
LENGTH: 2.37"

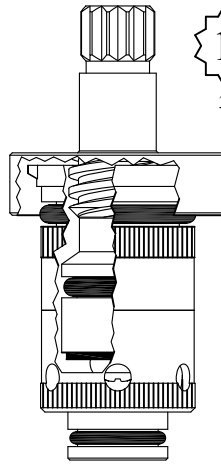

12
3-10

LF461181
LF461182

FOR SPRINGHOUSE
LENGTH: 2.37"

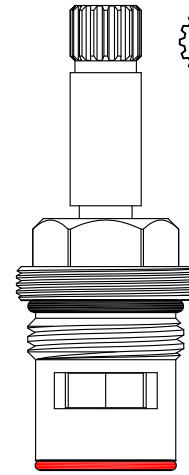

16
3-16

GASKET: 890170 O-RING INCLUDED
SEAL: 898580-R
DISC SET: 115520-PKG

LF462681
LF462682

FOR BRIGGS
LENGTH: 2.37"

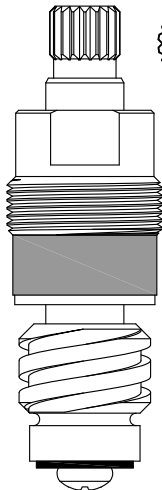

18
3-3

LF463111
LF463112

FOR ACORN
LENGTH: 2.37"

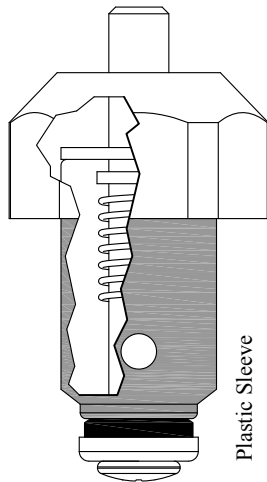

Plastic Sleeve

LF463270

Also available less bonnet
LF463260

FOR PIAZZA
LENGTH: 2.37"

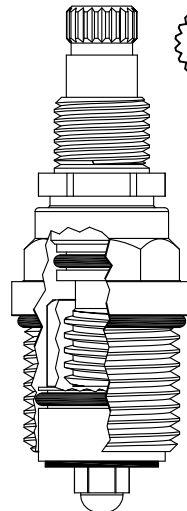

20
3-14

GASKET: 890180 O-RING INCLUDED

LF463702

UNKNOWN
LENGTH: 2.38"

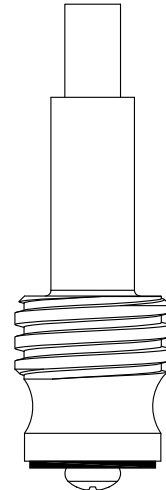

19/64

Chrome Plated Stem

201331



SEAT USED: LF648120

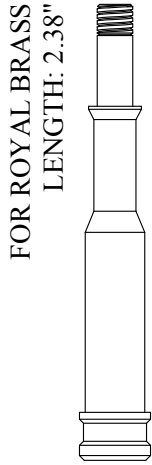

LF115960

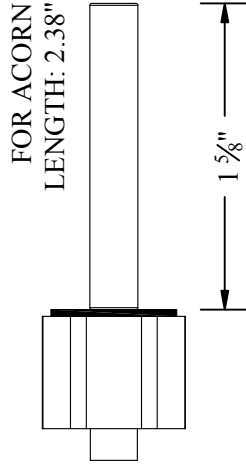

LF158310



SEAT USED: LF647560

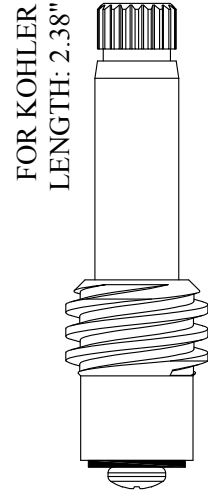

19
1-7

Chrome Plated Stem

LF263151
LF263152

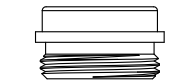

SEAT USED: LF647230

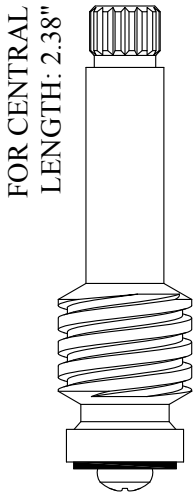

16
1-6

Chrome Plated Stem

LF263311
LF263312

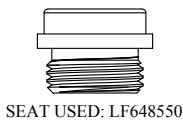

SEAT USED: LF648550

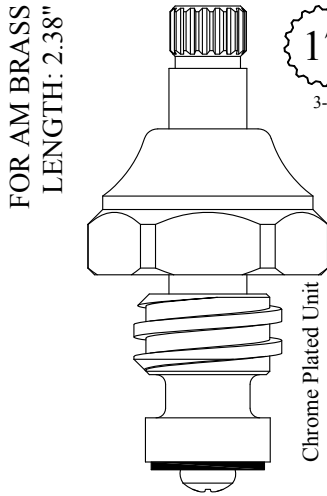

17
3-7

Chrome Plated Unit

LF464211
LF464212
LF264211 Stem Only
LF264212 Stem Only

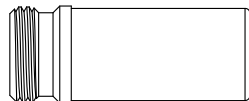

SEAT USED: LF649240

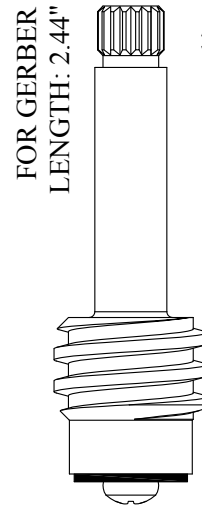

16
2-3

LF263121
LF263122

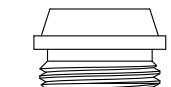

SEAT USED: LF649150

FOR UNION BRASS
LENGTH: 2.39"

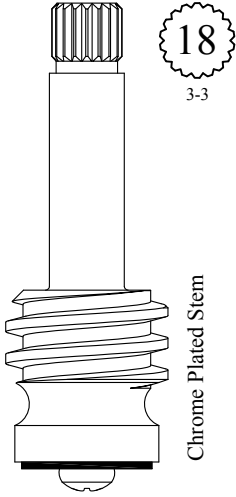

LF264191
LF264192

UNKNOWN
LENGTH: 2.39"

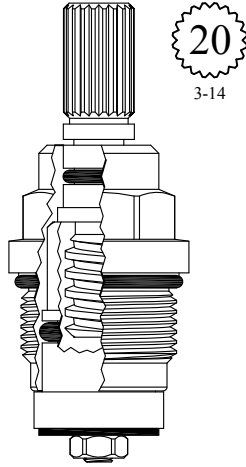

GASKET: 890180 O-RING INCLUDED

LF460272

FOR SAVOY
LENGTH: 2.39"

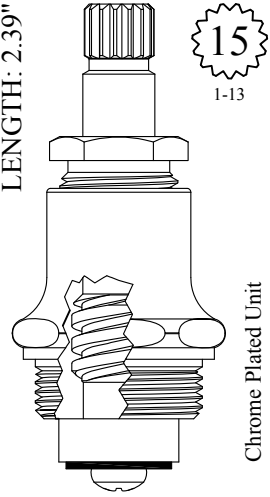

GASKET: 895400

LF462081
LF462082

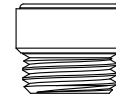

SEAT USED: LF649740

FOR CRANE
LENGTH: 2.39"

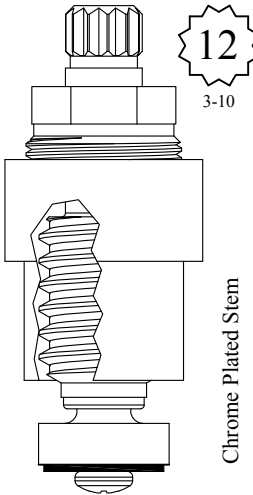

LF462611
LF462612



SEAT USED: LF649920

FOR DICK BROS.
LENGTH: 2.39"

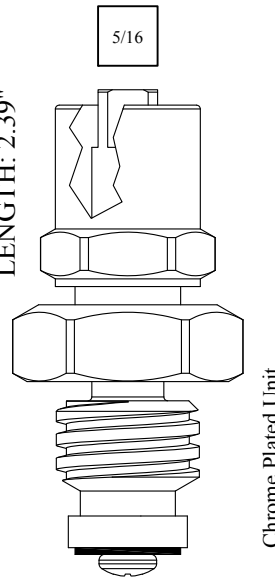

LF463091
LF263091 Stem Only

FOR MUELLER
LENGTH: 2.40"

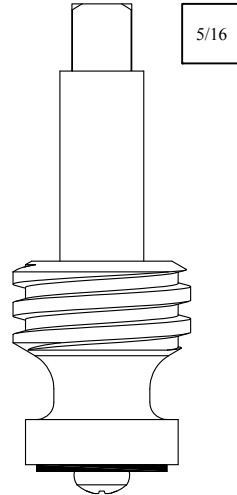

263341

FOR SHERLE WAGNER
LENGTH: 2.40"

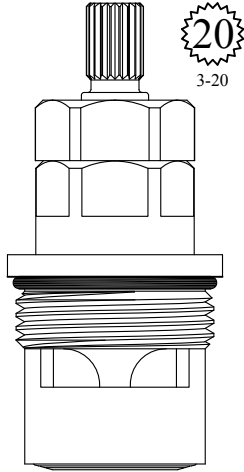

GASKET: 890210 O-RING INCLUDED
SEAL: 898520
DISC SET: 109850-PKG

401381
401382

FOR CENTRAL
LENGTH: 2.40"

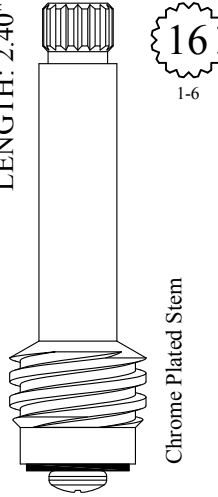

Chrome Plated Stem

LF263211
LF263211

FOR STERLING BRASS
LENGTH: 2.40"

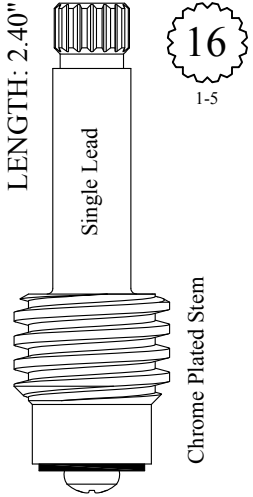

Chrome Plated Stem

LF263511



SEAT USED: LF648550

FOR STERLING BRASS
LENGTH: 2.40"

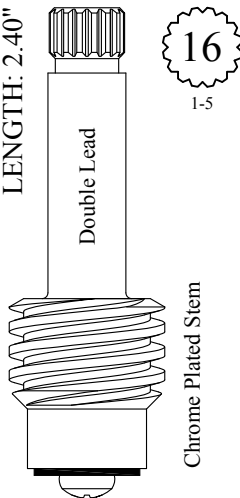

Chrome Plated Stem

LF263521
LF263522

FOR CRANE
LENGTH: 2.40"

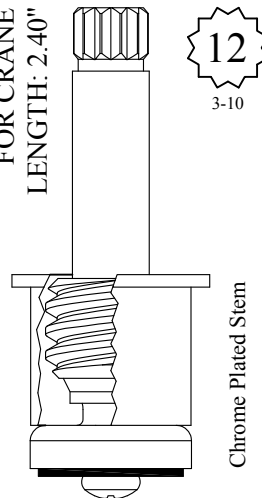

Chrome Plated Stem

LF462071
LF462072

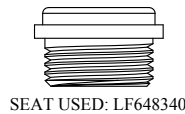

SEAT USED: LF648340

FOR ROYAL BRASS
LENGTH: 2.40"

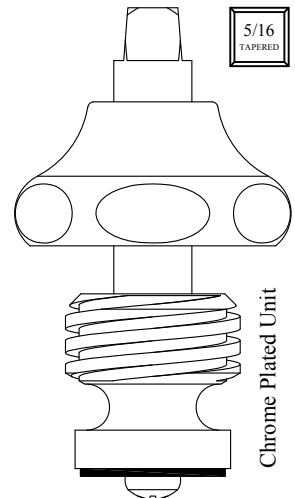

Chrome Plated Unit

LF463221
LF463222
LF263221 Stem Only
LF263222 Stem Only

Comes with handle screw:
899230

FOR ROYAL BRASS
LENGTH: 2.40"

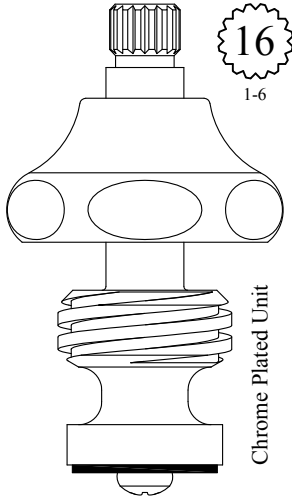

Chrome Plated Unit

LF463251
LF463252
LF263251 Stem Only
LF263252 Stem Only

FOR KALLISTA
LENGTH: 2.40"

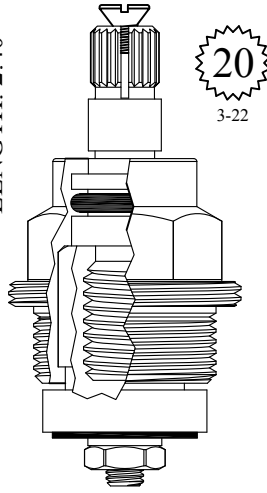

GASKET: 895350

LF463602

FOR HELVEX
LENGTH: 2.40"

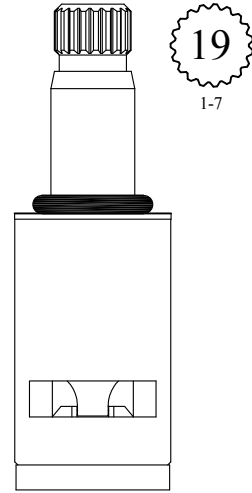

DISC SET: 151380-PKG

LF463801
LF463802

FOR BRIGGS
LENGTH: 2.41"

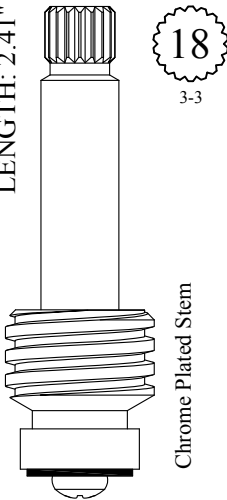

Chrome Plated Stem

201231

UNKNOWN
LENGTH: 2.41"

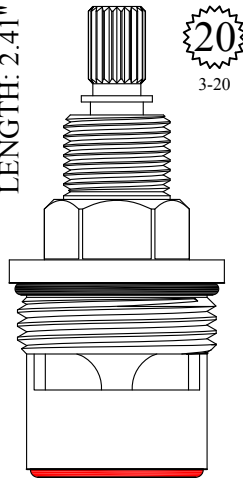

GASKET: 890210 INCLUDED
SEAL: 898610-R/B
DISC SET: 109850-PKG

400961
400962

UNKNOWN
LENGTH: 2.41"

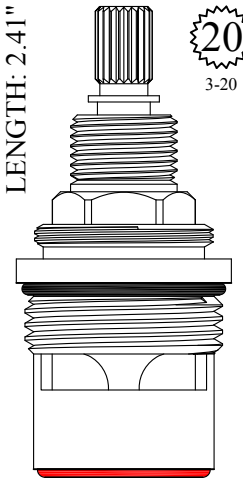

GASKET: 890210 INCLUDED
SEAL: 898610-R/B
DISC SET: 109850-PKG

400991
400992

FOR SHERLE WAGNER
LENGTH: 2.41"

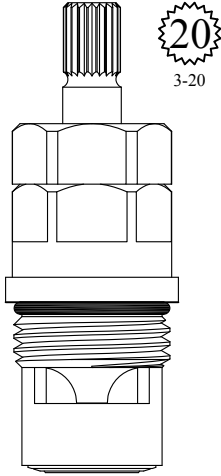

GASKET: 890170 O-RING INCLUDED
SEAL: 898510-W
DISC SET: 151380-PKG

LF462521
LF462522

FOR INDIANA
LENGTH: 2.41"

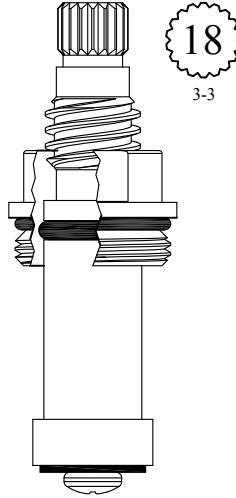

GASKET: 890170 O-RING INCLUDED

LF464131
LF464132

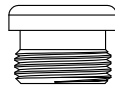

SEAT USED: LF648560

FOR AM STD
LENGTH: 2.42"

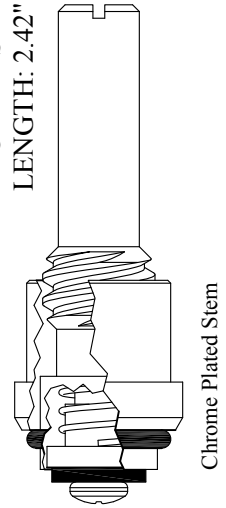

464221
264221 Stem Only

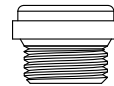

SEAT USED: LF648990

FOR CENTRAL
LENGTH: 2.42"

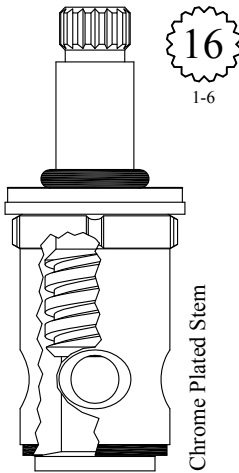

LF463201
LF463202

FOR CENTRAL
LENGTH: 2.42"

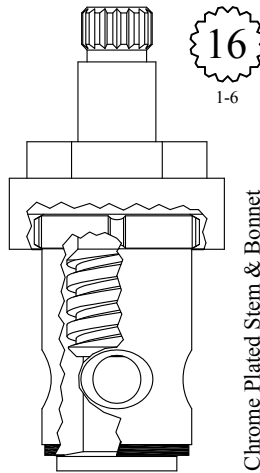

LF463211
LF463212

FOR AM STD
LENGTH: 2.42"

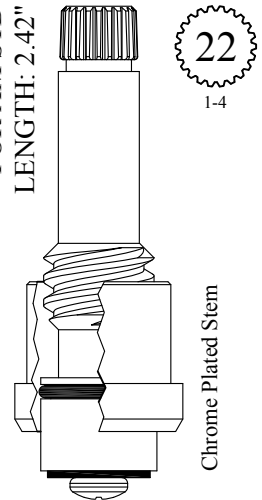

GASKET: 891130

LF464011
LF464012
LF264011 Stem Only
LF264012 Stem Only

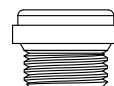

SEAT USED: LF648990

FOR SHERLE WAGNER
LENGTH: 2.43"

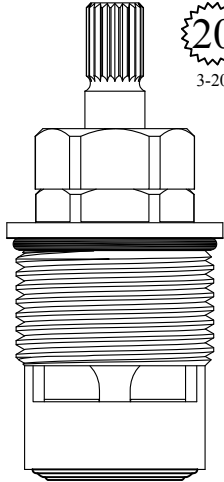

GASKET: 890210 O-RING INCLUDED
SEAL: 898520
DISC SET: 109850-PKG

401581
401582

FOR AM STD
LENGTH: 2.43"

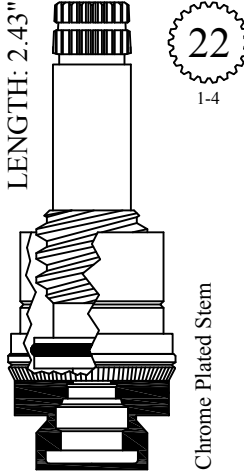

Chrome Plated Stem

LF463131
LF463132

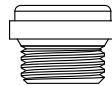

SEAT USED: LF648990

IMPORT
LENGTH: 2.43"

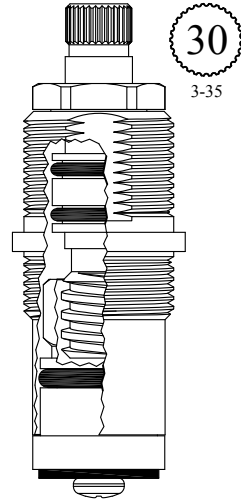

LF463302

UNKNOWN
LENGTH: 2.44"

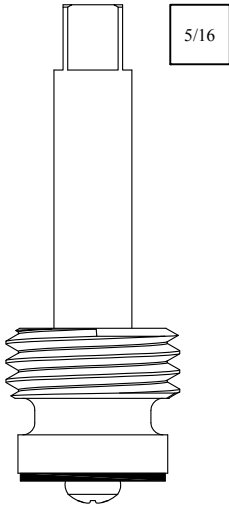

152981

FOR HARCRAFT
LENGTH: 2.44"

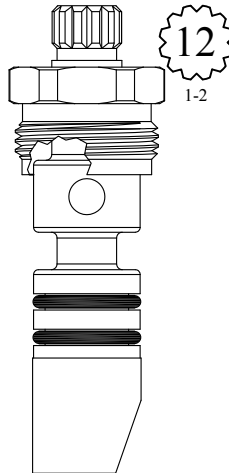

430040
230040 Stem Only

FOR ACORN
LENGTH: 2.44"

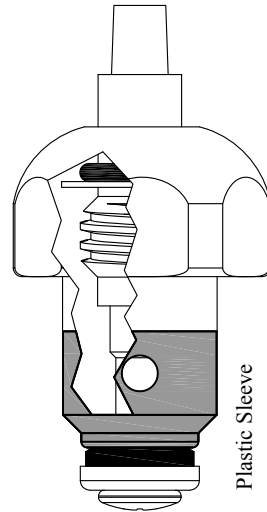

464552

Also available less bonnet

464542

Also available as a RH/LH Kit
LF463321-2
 Kit includes: (1) 263321, (1) 263322, (1) 604520
 Available: Stem Only
LF263321 / LF263322

FOR SEPCO
 LENGTH: 2.44"

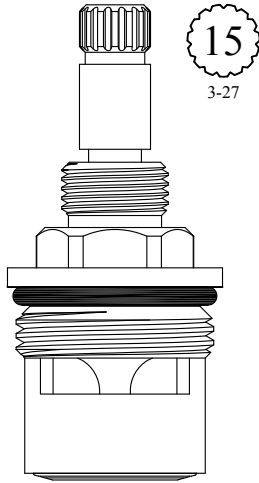

GASKET: 891180 O-RING INCLUDED
 SEAL: 898520
 DISC SET: 109850-PKG

401251
401252

FOR BRADLEY
 LENGTH: 2.44"

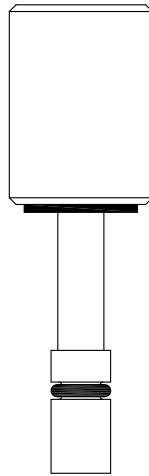

LF173770

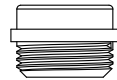

SEAT USED: LF647560

FOR WOLVERINE
 LENGTH: 2.44"

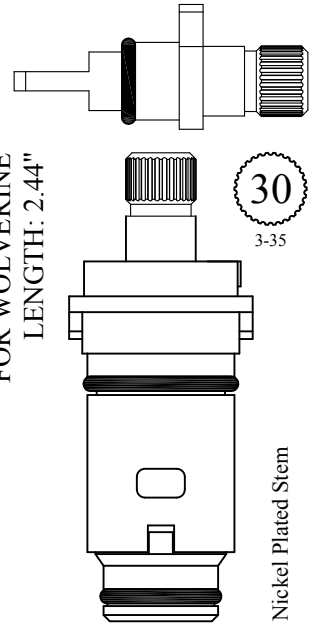

LF463321
LF463322

FOR WOLVERINE
 LENGTH: 2.44"

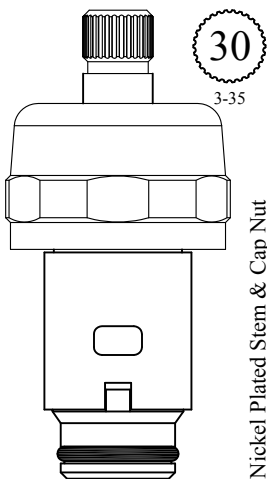

LF463321-N
LF463322-N

UNKNOWN
 LENGTH: 2.44"

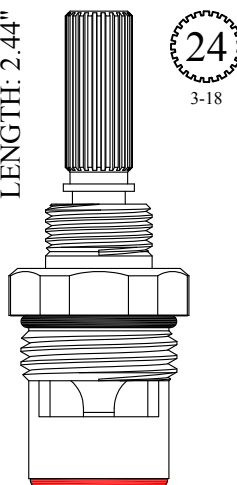

GASKET: 890170 O-RING INCLUDED
 SEAL: 898570-R/B
 DISC SET: 151380-PKG

LF463661
LF463662

FOR PRICE PFISTER
 LENGTH: 2.45"

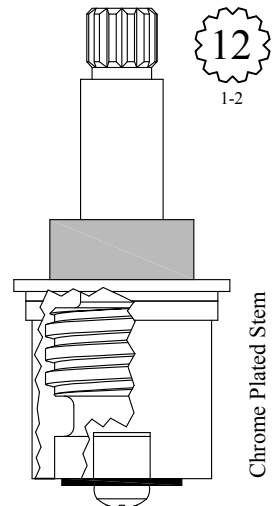

401321
201351 Stem Only

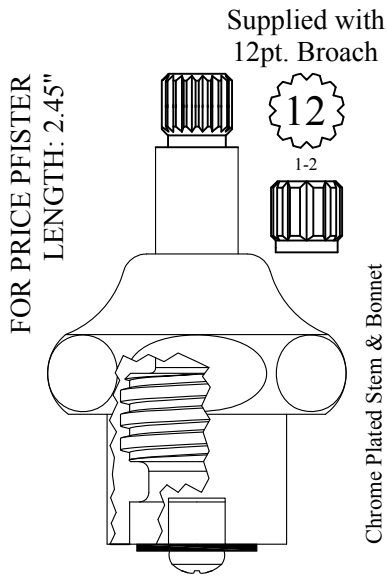

401351
201351 Stem Only

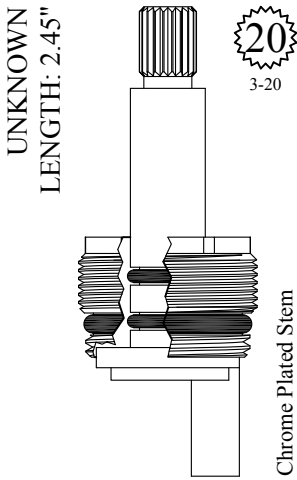

GASKET: 891150 O-RING INCLUDED

431100

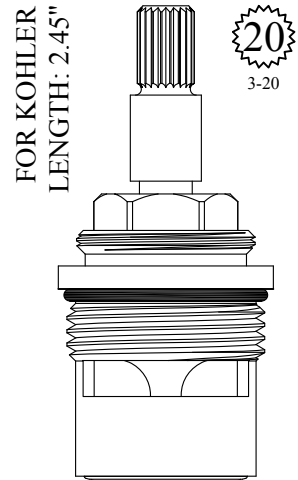

GASKET: 890210 O-RING INCLUDED
SEAL: 898520
DISC SET: 109850-PKG

401291
401292

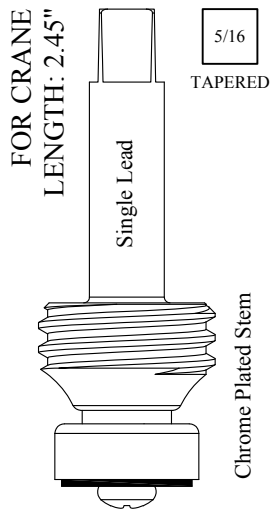

LF263401

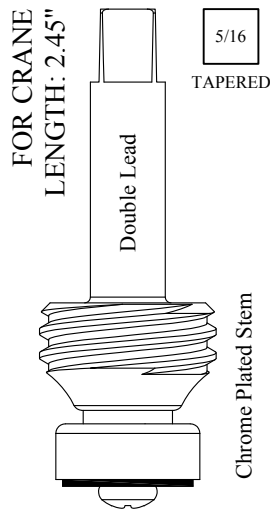
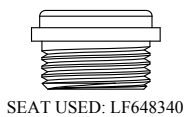

LF263411
LF263412

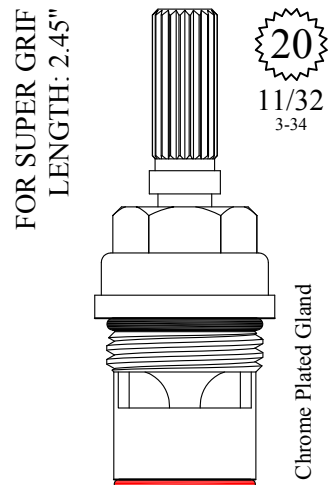
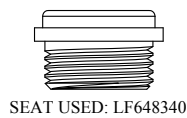

GASKET: 890170 O-RING INCLUDED
SEAL: 898580-R/B
DISC SET: 151380-PKG

LF463641
LF463642

FOR SPEAKMAN
LENGTH: 2.45"

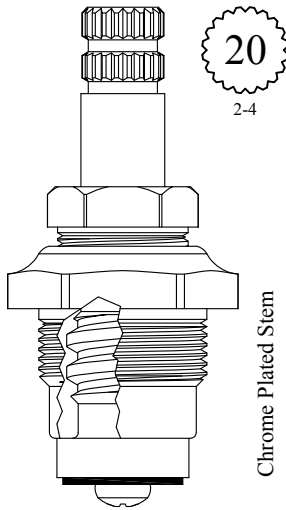

GASKET: 895400

LF463731
LF263731 Stem Only

FOR BRADLEY
LENGTH: 2.46"

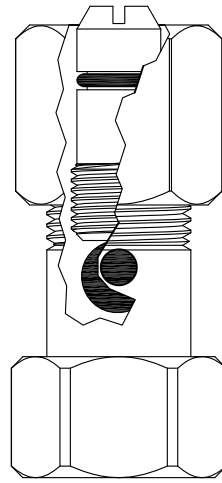

LF126480

FOR AM BRASS
LENGTH: 2.46"

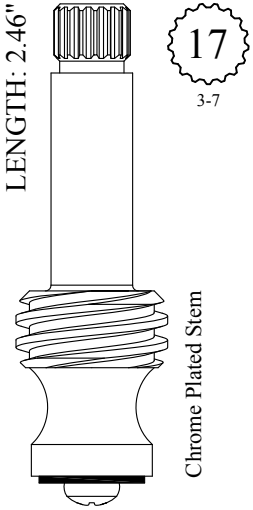

LF264271
LF264272

Also available as a RH/LH Kit

LF463361-2

Kit includes: (1) 263361, (1) 263362, (1) 604520

Available: Stem Only

LF263361 / LF263362

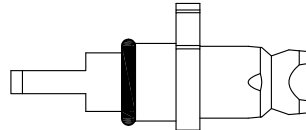

FOR SUPER GRIF
LENGTH 2.46"

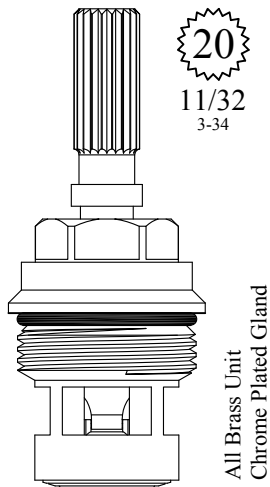

GASKET: 890190 O-RING INCLUDED
SEAL: 898510-W
DISC SET: 151380-PKG

LF463621
LF463622

FOR WOLVERINE
LENGTH: 2.47"

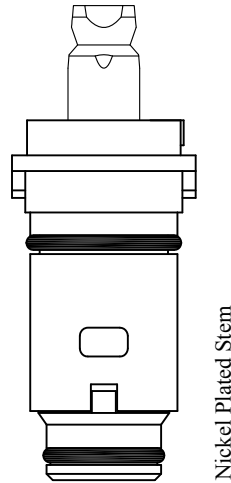

LF463361
LF463362

FOR SPEAKMAN
LENGTH: 2.48"

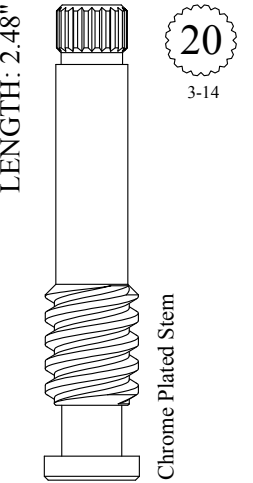

201301



SEAT USED: 648190

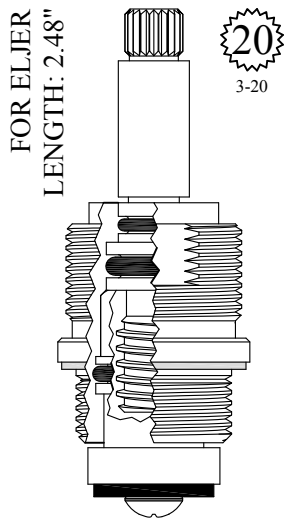

20
3-20

GASKET: 895160 INCLUDED

401342

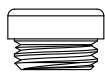

SEAT USED: LF647690

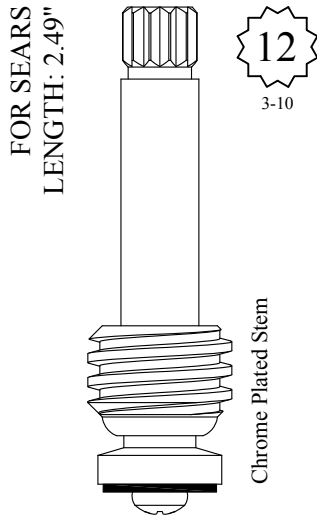

12
3-10

Chrome Plated Stem

201431



SEAT USED: LF648700

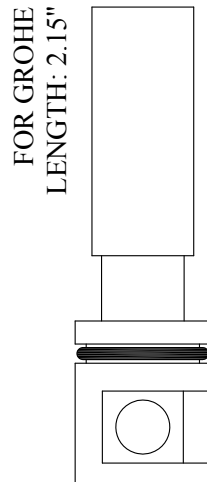

230650

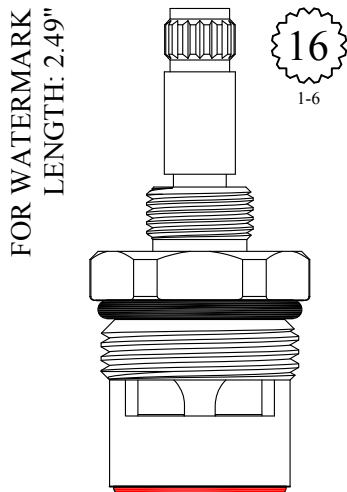

16
1-6

GASKET: 890170 O-RING INCLUDED
SEAL: 898610-R/B
DISC SET: 109850-PKG

401261
401262

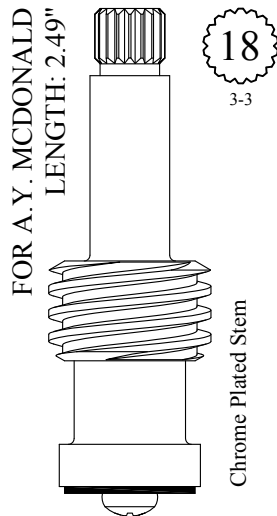

18
3-3

Chrome Plated Stem

LF264281
LF264282

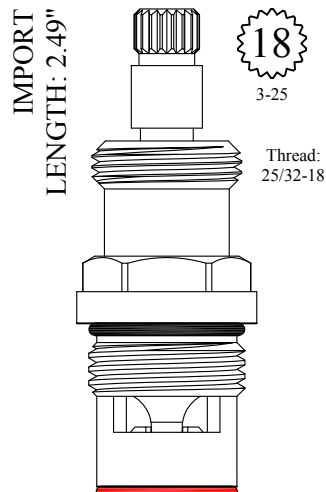

18
3-25

Thread:
25/32-18

GASKET: 890170 O-RING INCLUDED
SEAL: 898580-R/B
DISC SET: 151380-PKG

LF401361
LF401362

Individual items available
 Stem Ext. 29/32": #128350-PB
 & 128350-CP
 Ext. Adapt. Screw: #103310

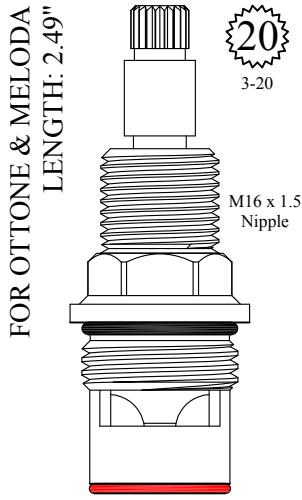

GASKET: 890170 O-RING INCLUDED
 SEAL: 898580-R/B
 DISC SET: 151380-PKG

LF462841
 LF462842

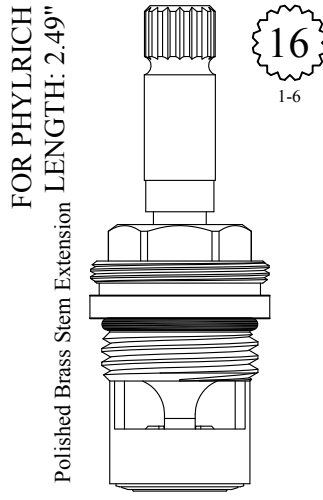

GASKET: 890170 O-RING INCLUDED
 SEAL: 898510-W
 DISC SET: 151380-PKG

LF463651
 LF463652

Also available with chrome plated stem extension
LF463651-CP / LF463652-CP

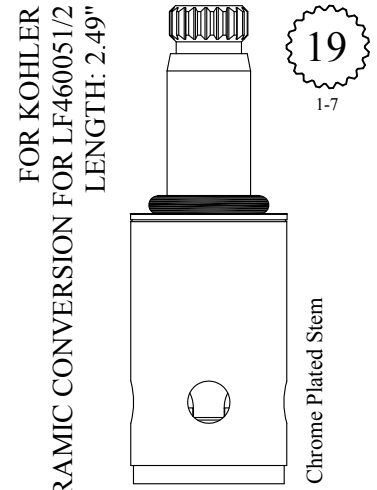

DISC SET: 151380-PKG

LF463811
 LF463812

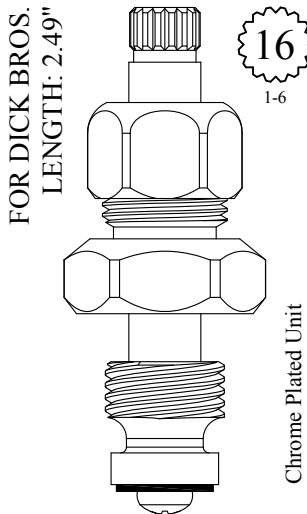

LF463841
 LF463842
 LF263841 Stem Only
 LF263842 Stem Only

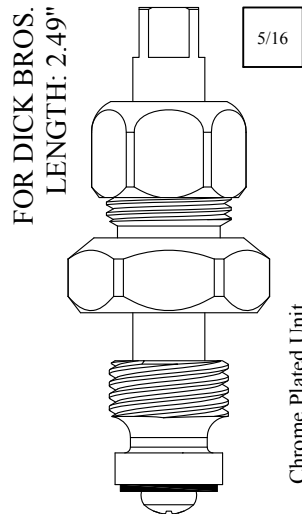

LF463851
 LF263851 Stem Only

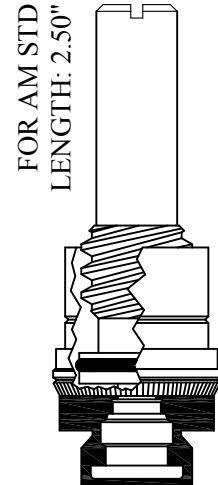

401551
 SEAT USED: LF648990

FOR SUPER GRIF
LENGTH: 2.50"

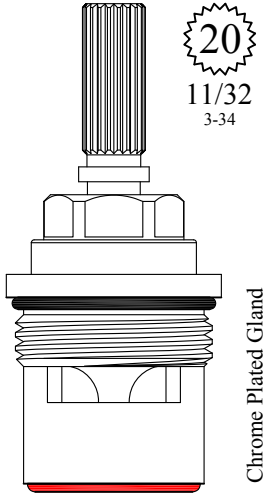

20
11/32
3-34

Chrome Plated Gland

GASKET: 890210 O-RING INCLUDED
SEAL: 898610-R/B
DISC SET: 109850-PKG

401281
401282

FOR BRIGGS
LENGTH: 2.50"

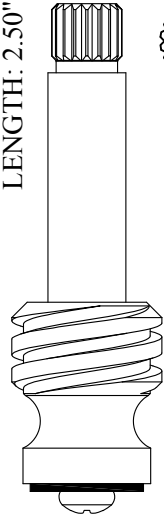

18
3-3

Chrome Plated Stem

LF263161
LF263162

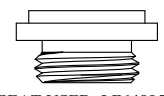

SEAT USED: LF648950

FOR SEARS
LENGTH: 2.50"

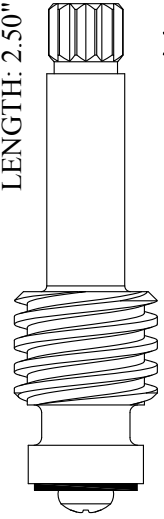

12
3-10

LF264111
LF264112



SEAT USED: LF648700

FOR AM BRASS
LENGTH: 2.50"

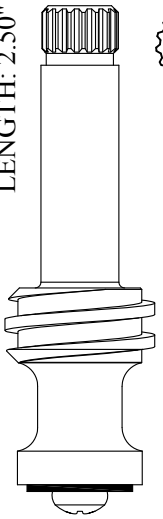

17
3-7

Chrome Plated Stem

LF264261



SEAT USED: LF648410

FOR AM STD
LENGTH: 2.50"

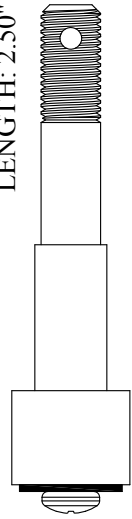

LF264300

FOR KOHLER
LENGTH: 2.50"

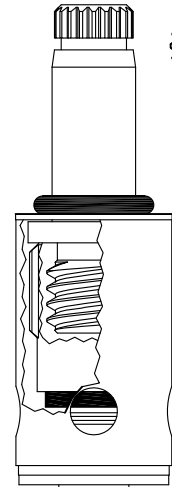

19
1-7

Chrome Plated Stem
Plastic Plunger

SEAT INCLUDED:
LF649460

LF460051
LF460052
LF260051 Stem Only
LF260052 Stem Only

Also available with
Brass Plunger

LF460051-B / LF460052-B

FOR KOHLER
LENGTH: 2.50"

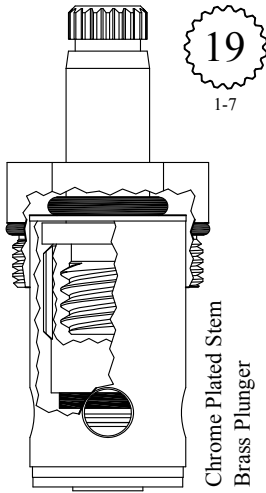

GASKET: 890210 O-RING INCLUDED
SEAT INCLUDED: LF649460

LF460251-B
LF460252-B
LF260051 Stem Only
LF260052 Stem Only

FOR KOHLER
LENGTH: 2.50"

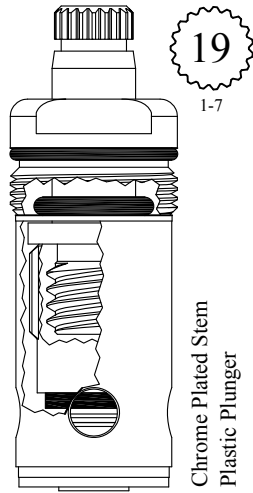

GASKET: 890180 O-RING INCLUDED
SEAT INCLUDED: LF649460

LF460261
LF460262
LF260051 Stem Only
LF260052 Stem Only

LF460261-B / LF460262-B

FOR BRIGGS
LENGTH: 2.50"

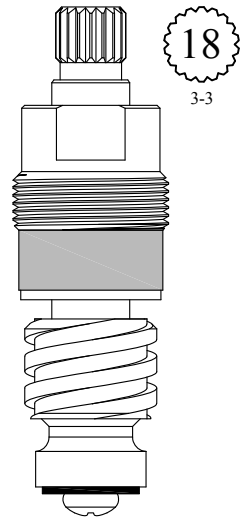

LF464031
LF464032
LF264031 Stem Only
LF264032 Stem Only

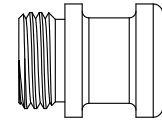

SEAT USED: LF648250

FOR SPEAKMAN
LENGTH: 2.51"

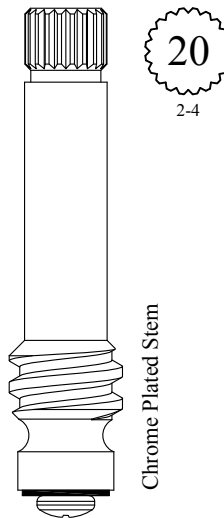

LF264081
LF264082



SEAT USED: LF648760

FOR AM STD
STEM LENGTH: 2.25"

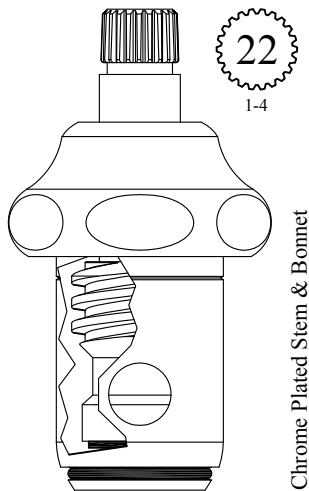

GASKET: 861020 INCLUDED

LF461021
LF461022
LF261021 Stem Only
LF261022 Stem Only

USES BARREL:
LF647021/LF647022

FOR HARDEN
LENGTH: 2.51"

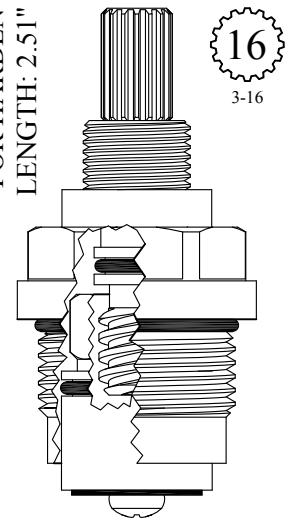

GASKET: 890210 O-RING INCLUDED

LF463901
LF463902

UNKNOWN
LENGTH: 2.52"

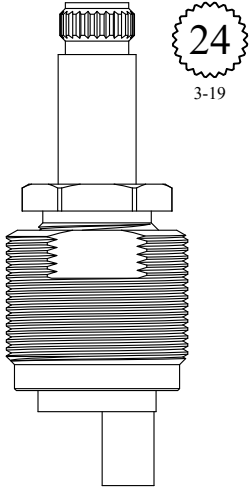

24
3-19

430680
230680 Stem Only

FOR DORNBRACHT
LENGTH: 2.52"

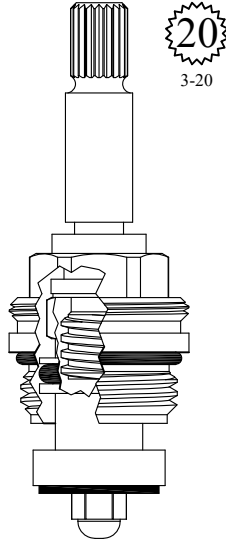

20
3-20

GASKET: 890170 O-RING INCLUDED

LF463872

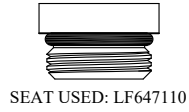

SEAT USED: LF647110

FOR SPEAKMAN
LENGTH: 2.52"



LF264430

FOR HARCRAFT
LENGTH: 2.52"

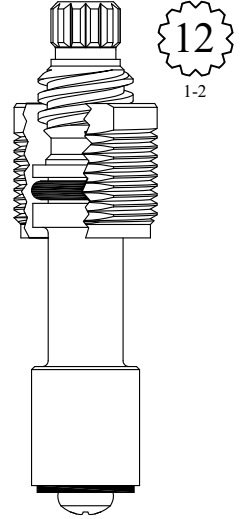

12
1-2

GASKET: 895040 INCLUDED

LF464021

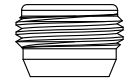

SEAT USED: LF648670

UNKNOWN
LENGTH: 2.52"

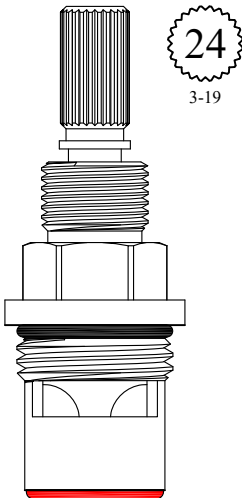

24
3-19

GASKET: 890170 O-RING INCLUDED
SEAL: 898570-R/B
DISC SET: 151380-PKG

LF464351
LF464352

UNKNOWN
LENGTH: 2.53"

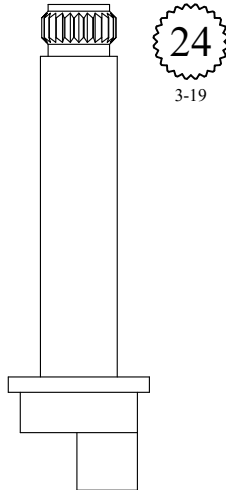

24
3-19

230890

FOR AM STD
LENGTH: 2.53"

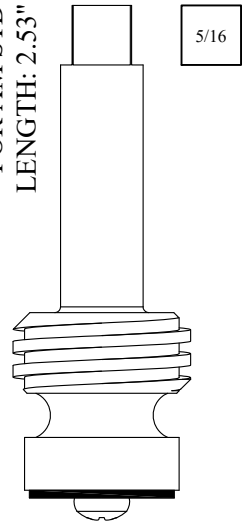

5/16

264851

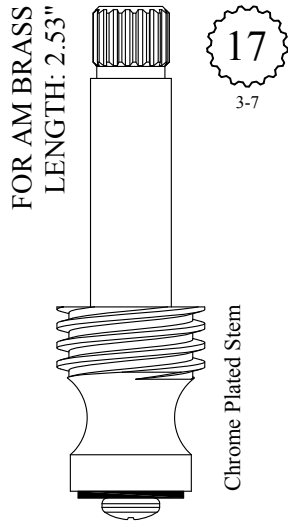

LF264291

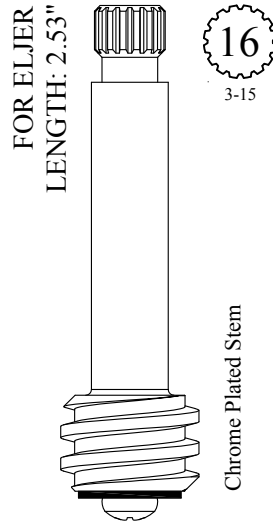

LF265171

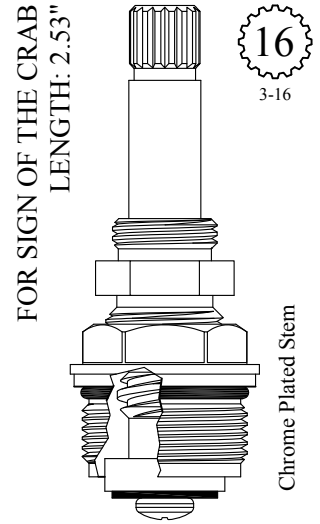

GASKET: 890180 O-RING INCLUDED

LF464151
LF464152

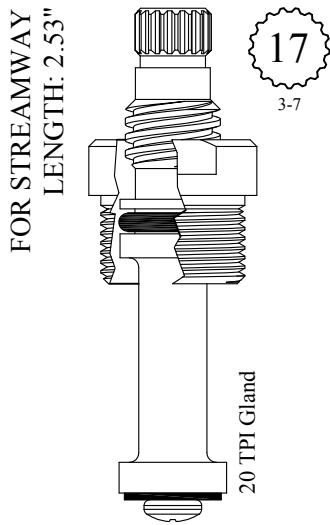

GASKET: 895100

LF464161
LF464162



SEAT USED: LF648040

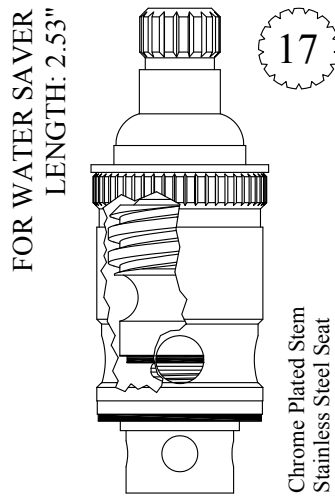

SEAT INCLUDED: LF649880

LF464041
LF464042

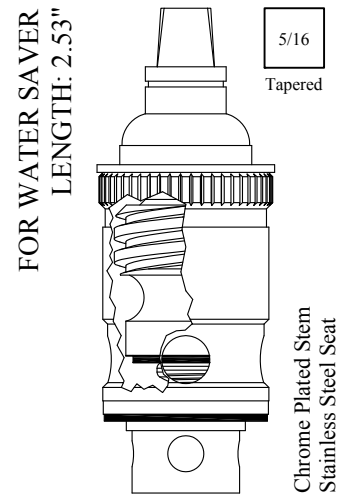

SEAT INCLUDED: LF649880

LF464441
LF464442

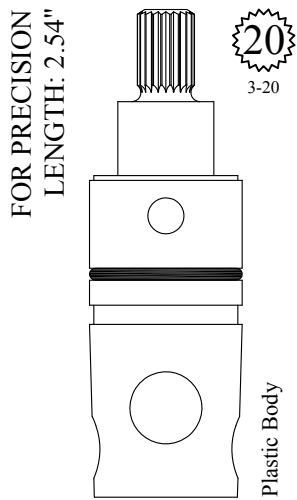

230670

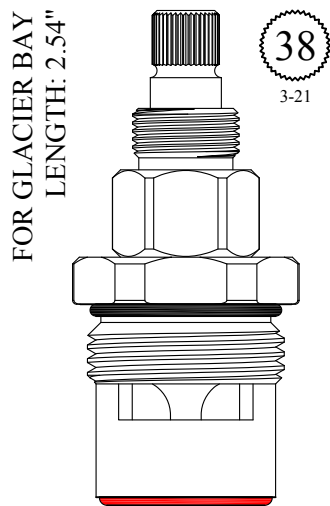

GASKET: 890200 O-RING INCLUDED
SEAL: 898610-R/B
DISC SET: 109850-PKG

401421
401422

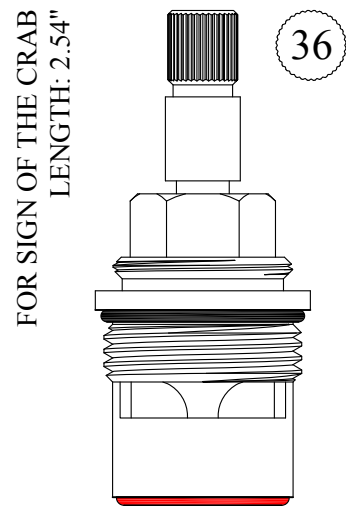

GASKET: 890210 O-RING INCLUDED
SEAL: 898610-R/B
DISC SET: 109850-PKG

401481
401482

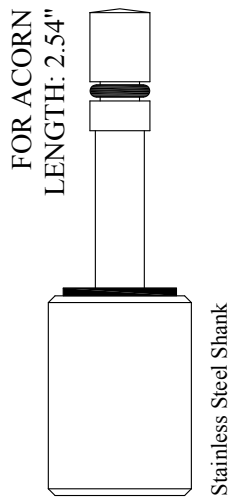

LF138990

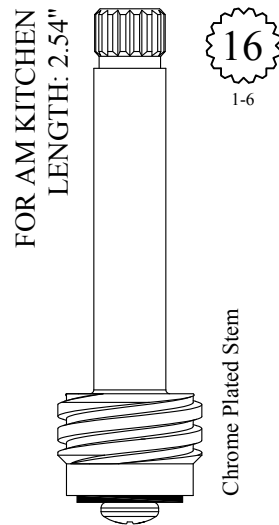

LF264091
LF264092

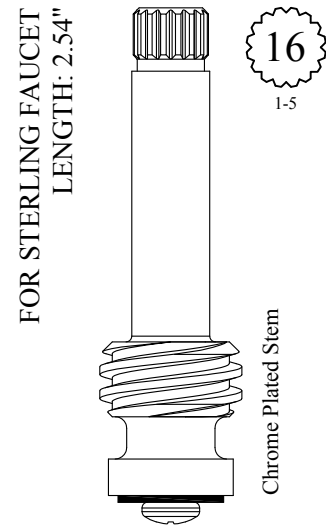
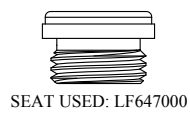

LF265011
LF265012



FOR SPEAKMAN
LENGTH: 2.54"

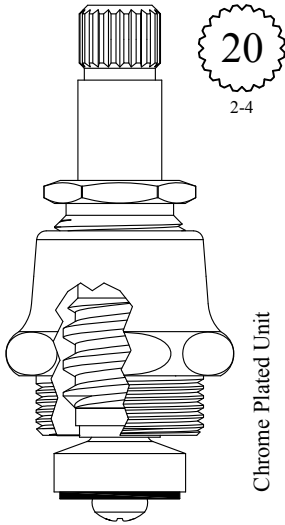

GASKET: 895180

LF464051
LF464052
LF264051 Stem Only
LF264052 Stem Only



SEAT USED: LF648930

FOR STREAMWAY
LENGTH: 2.54"

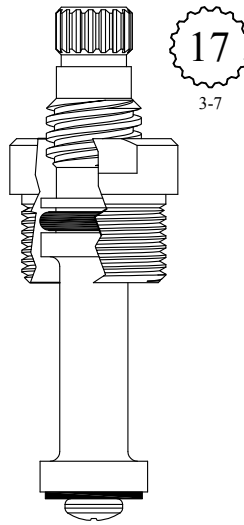

GASKET: 895100

LF464121
LF464122



SEAT USED: LF648040

FOR DONNER
LENGTH: 2.54"

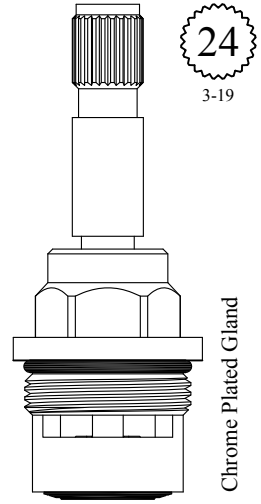

GASKET: 890180 O-RING INCLUDED
SEAL: 898510
DISC SET: 151380-PKG

LF464371
LF464372

FOR NIBCO
LENGTH: 2.55"

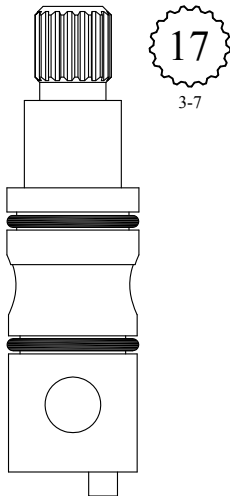

230730

FOR ARMONIA
LENGTH: 2.55"

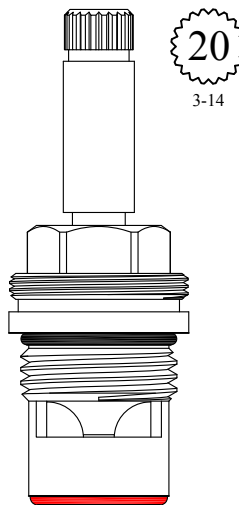

GASKET: 890170 O-RING INCLUDED
SEAL: 898570-R/B
DISC SET: 151380-PKG

LF462861
LF462862

FOR ARMONIA
LENGTH: 2.55"

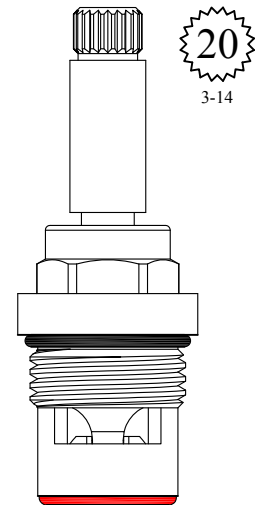

GASKET: 890170 O-RING INCLUDED
SEAL: 898570-R/B
DISC SET: 151380-PKG

LF462881
LF462882

FOR ARMONIA
LENGTH: 2.55"

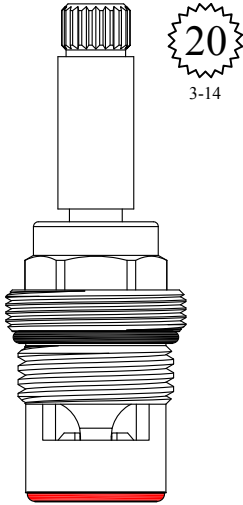

20
3-14

GASKET: 890170 O-RING INCLUDED
SEAL: 898570-R/B
DISC SET: 151380-PKG

LF462891
LF462892

FOR ROYAL BRASS
LENGTH: 2.55"

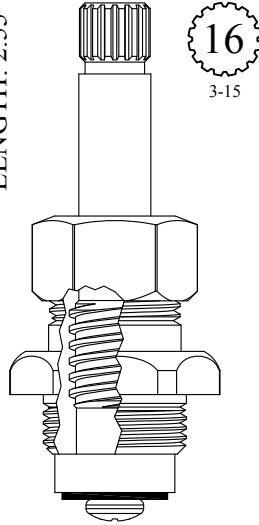

16
3-15

GASKET: 895100

LF463861

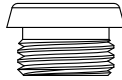

SEAT USED: LF648260

FOR AM BRASS
LENGTH: 2.55"

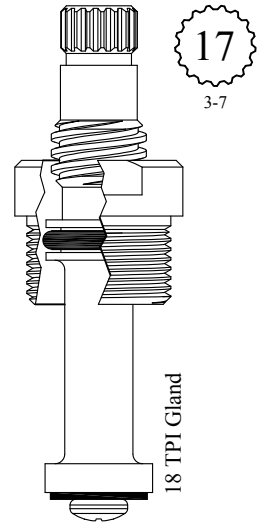

17
3-7

GASKET: 895100

LF463981
LF463982



SEAT USED: LF648140

FOR AM BRASS
LENGTH: 2.55"

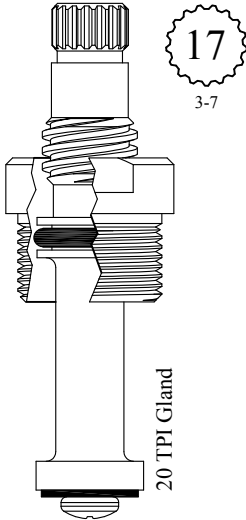

17
3-7

GASKET: 895100

LF464001
LF464002

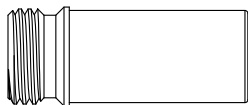

SEAT USED: LF648140

IMPORT
LENGTH: 2.55"

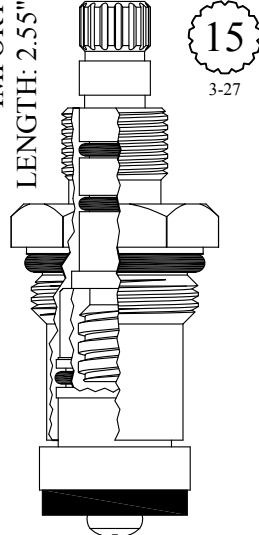

15
3-27

GASKET: 891160 INCLUDED

LF464391
LF464392

FOR GERBER
LENGTH: 2.56"

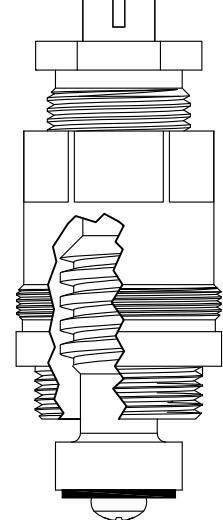

GASKET: 895400

401241
201241 Stem Only

FOR CENTRAL
LENGTH: 2.56"

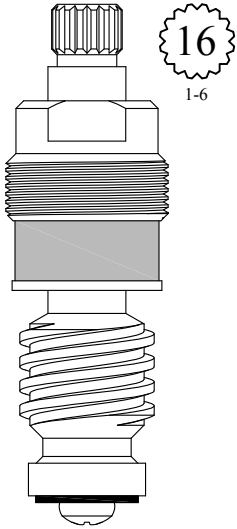

16
1-6

LF464101
LF464102
LF264101 Stem Only
LF264102 Stem Only



SEAT USED: LF648550

METERING

FOR WILLOUGHBY
LENGTH: 2.56"

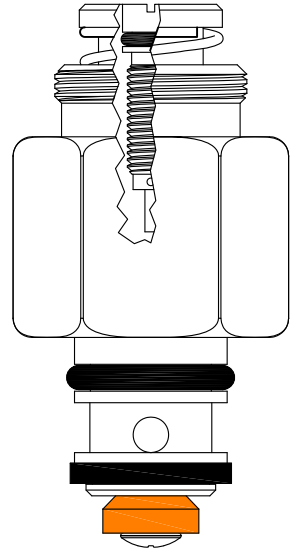

LF465480

FOR ACORN
LENGTH: 2.57"

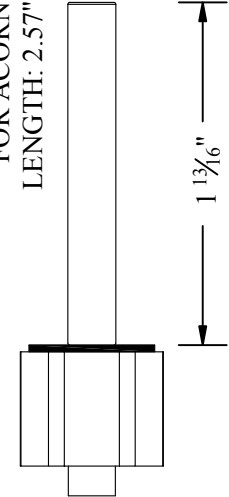

LF130680

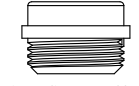

SEAT USED: LF647560

FOR MUELLER
LENGTH: 2.57"

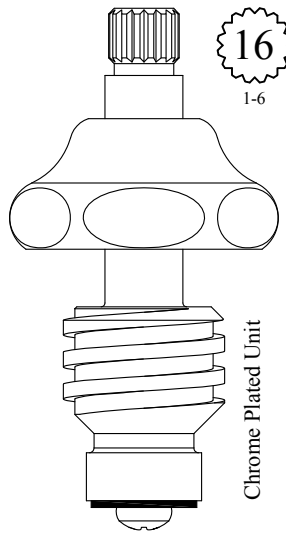

16
1-6

401401
201401 Stem Only

Chrome Plated Unit

FOR MUELLER
LENGTH: 2.57"

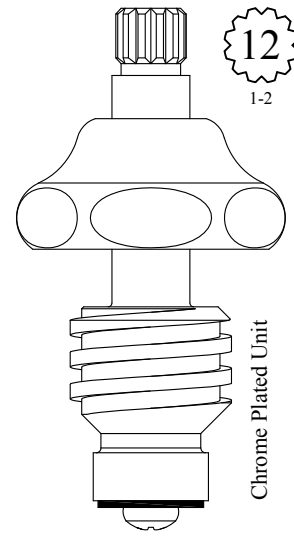

12
1-2

401451
201451 Stem Only

Chrome Plated Unit

FOR AM STD
LENGTH: 2.57"

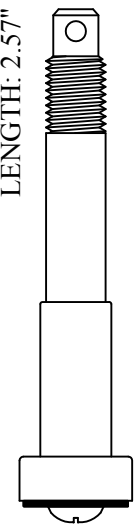

LF264250

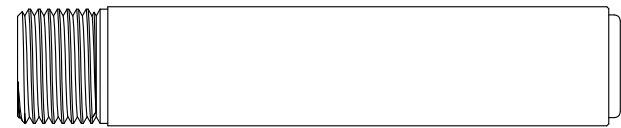

SEAT USED: LF649190

Individual items available
 Stem Ext.: #118760
 Esc Cap Nut: #124940

FOR MILWAUKEE
 LENGTH: 2.57

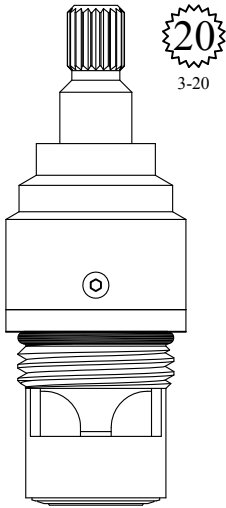

20
 3-20

GASKET: 890170 O-RING INCLUDED
 SEAL: 898510-W
 DISC SET: 151380-PKG

LF463941
 LF463942

FOR MICHIGAN BRASS
 LENGTH: 2.57

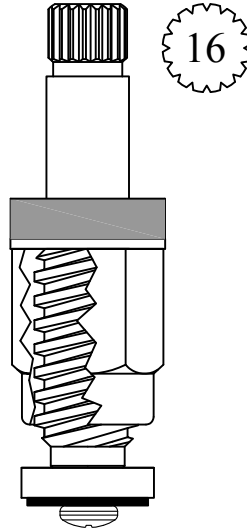

16

LF464141
 LF464142

FOR PRICE PFISTER
 LENGTH: 2.59"

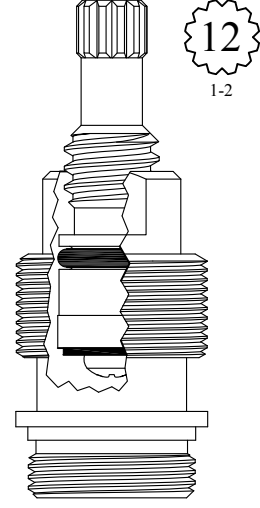

12
 1-2

GASKET: 895400

401311



SEAT USED: 648290

FOR MICHIGAN BRASS
 LENGTH: 2.59

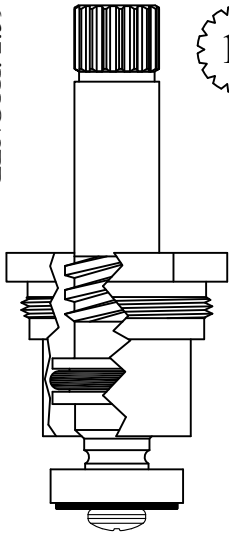

16

Chrome Plated Stem

LF465321
 LF465322

FOR MOEN
 LENGTH: 2.60"

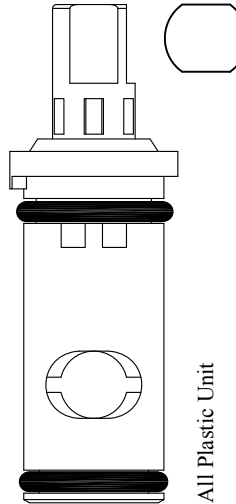

All Plastic Unit

464300

FOR KOHLER
 LENGTH: 2.60"

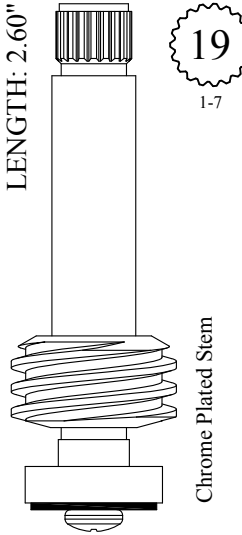

19
 1-7

Chrome Plated Stem

LF264321

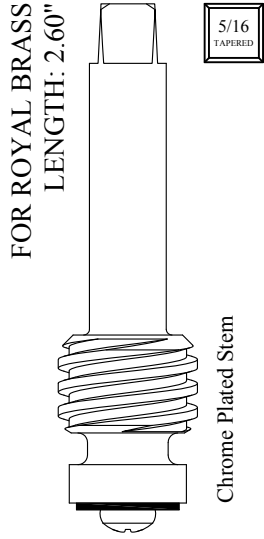

LF264411
LF264412

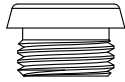

SEAT USED: LF648260

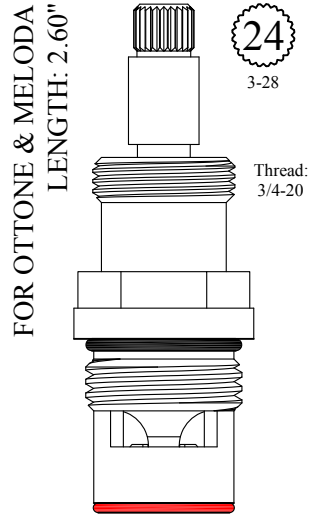

GASKET: 890170 O-RING INCLUDED
SEAL: 898580-R/B
DISC SET: 151380-PKG

LF401391
LF401392

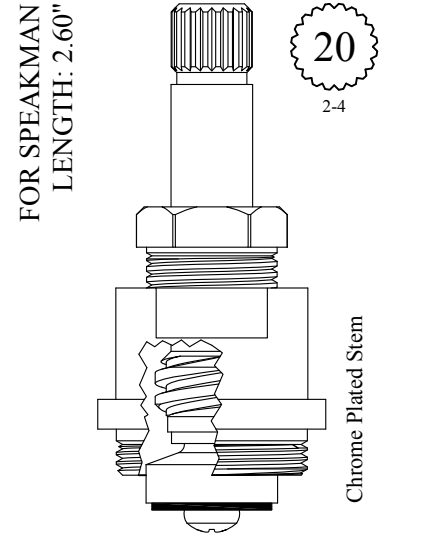

GASKET: 895550

LF464071
LF264071 Stem Only

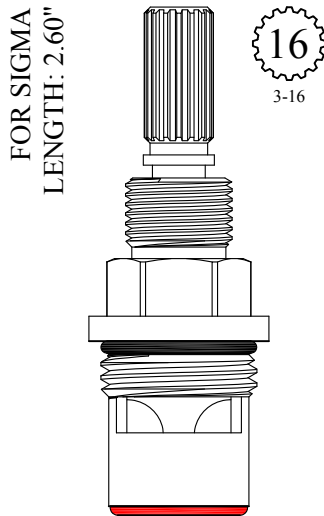

GASKET: 890170 O-RING INCLUDED
SEAL: 898570-R/B
DISC SET: 151380-PKG

LF464341
LF464342

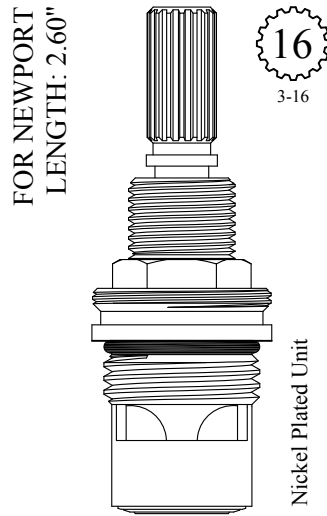

GASKET: 890170 O-RING INCLUDED
SEAL: 898510-W
DISC SET: 151380-PKG

LF464361
LF464362

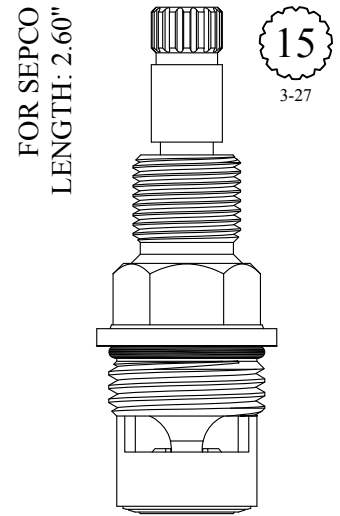

GASKET: 890170 O-RING INCLUDED
SEAL: 898510-W
DISC SET: 151380-PKG

LF464381
LF464382

FOR ROYAL BRASS
LENGTH: 2.60"

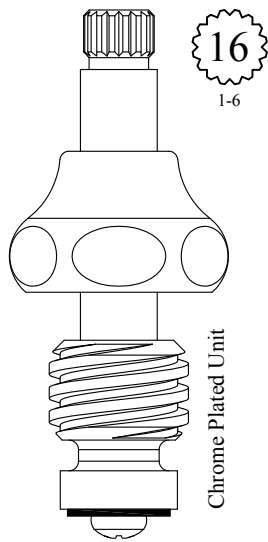

Chrome Plated Unit

LF464401
LF464402
LF264401 Stem Only
LF264402 Stem Only

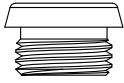

SEAT USED: LF648260

FOR REID WATSON
LENGTH: 2.60"

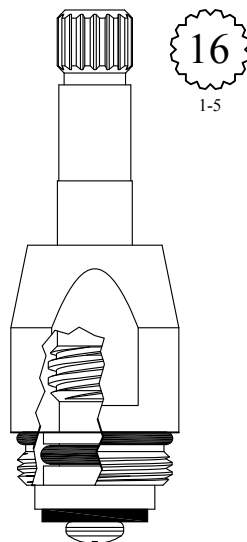

GASKET: 890170 O-RING INCLUDED

LF464501
LF464502

FOR SIGN OF THE CRAB
LENGTH: 2.60"

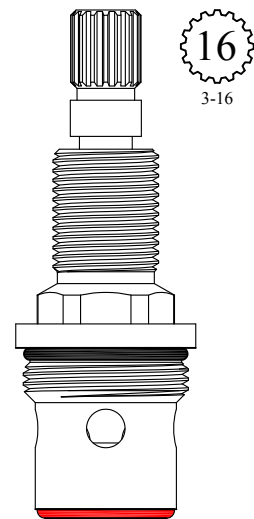

GASKET: 890170 O-RING INCLUDED
SEAL: 898570-R/B
DISC SET: 151380-PKG

LF464511
LF464512

FOR POWERS
LENGTH: 2.60"

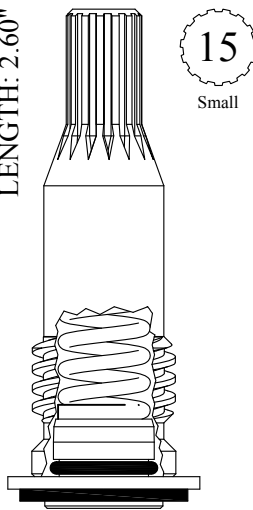

Small

201531

FOR FIAT
LENGTH: 2.61"

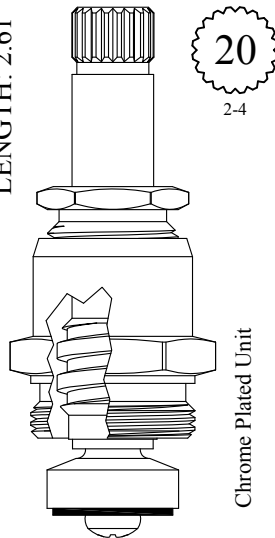

Chrome Plated Unit

GASKET: 895400

LF464201

FOR AM STD
LENGTH: 2.62"

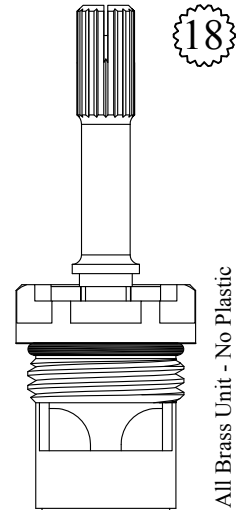

All Brass Unit - No Plastic

GASKET: 890170 O-RING INCLUDED
SEAL: 898510-W
DISC SET: 151380-PKG

401501
401502

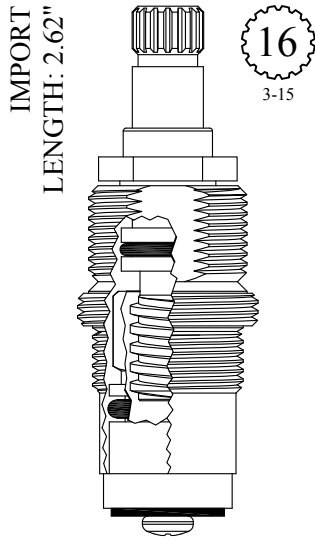

GASKET: 895140

LF464602

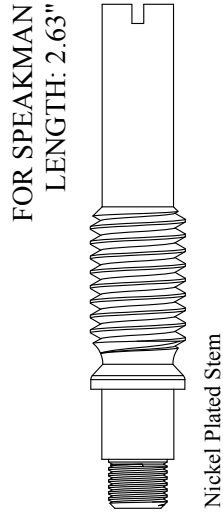

264331

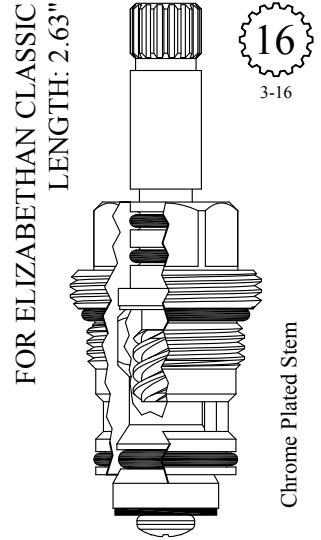

GASKET: 890180 O-RING INCLUDED

430881

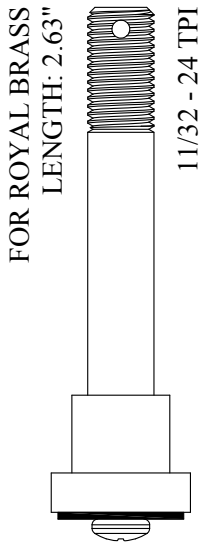

LF264700



SEAT USED: LF648260

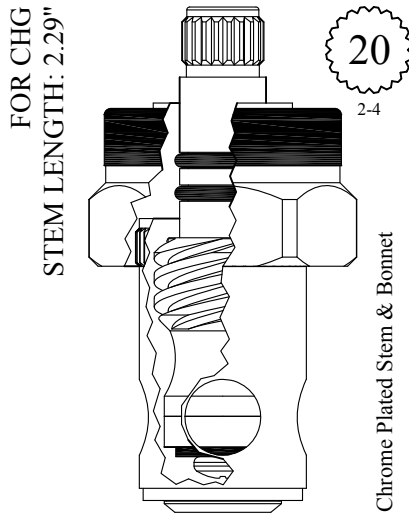

LF463921
LF463922

Individual items available
Stem Ext. 1-1/16": #105270-PB
& #105270-CP
Ext. Adap. Screw: #103310

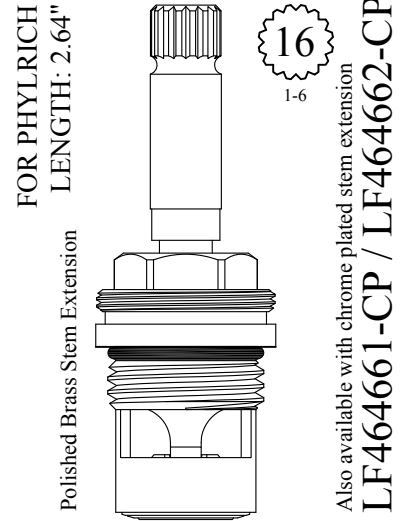

GASKET: 890170 O-RING INCLUDED
SEAL: 898510-W
DISC SET: 151380-PKG

LF464661
LF464662

Also available with chrome plated stem extension
LF464661-CP / LF464662-CP

SLOW COMPRESSION

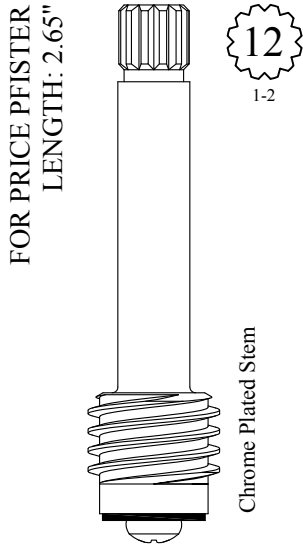

LF265031
LF265032

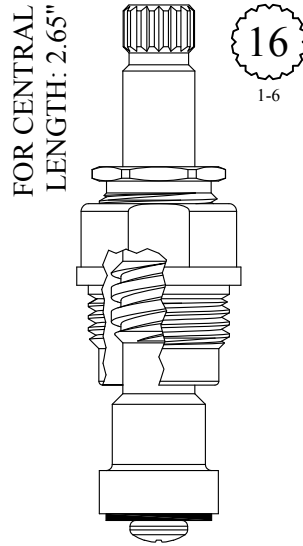

LF464801
LF464802

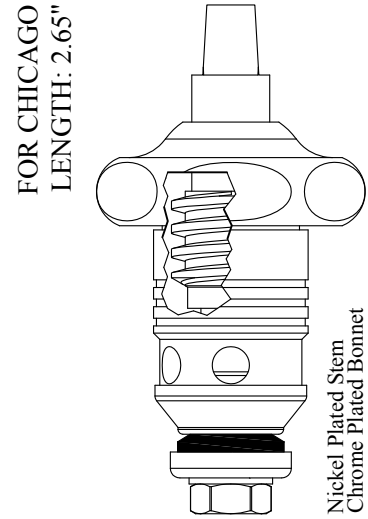

GASKET: 895200
SEAT INCLUDED: 648750

LF464991
LF464992

SLOW COMPRESSION

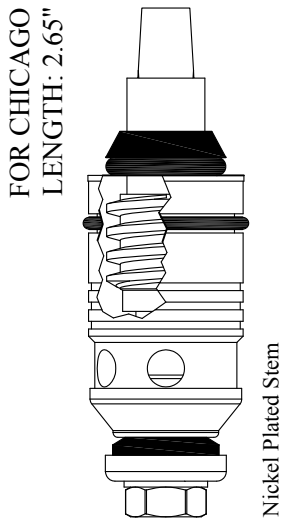

GASKET: 895200
SEAT INCLUDED: 648750

LF465001
LF465002

QUATURN

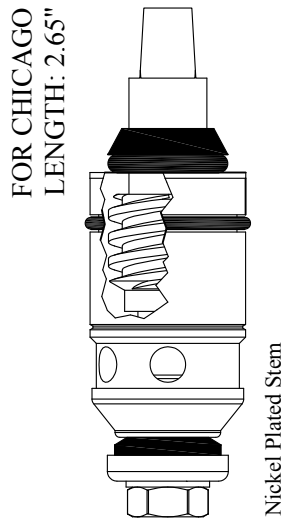

GASKET INCLUDED: 895200
SEAT INCLUDED: 648750

LF465041
LF465042

QUATURN

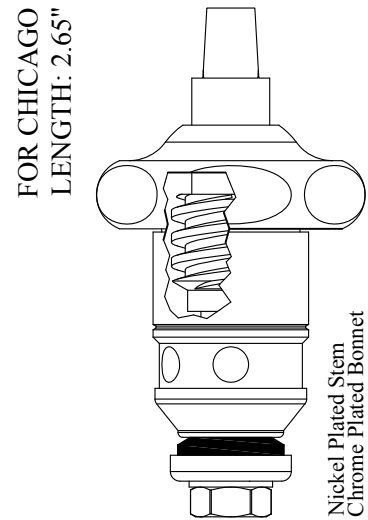

GASKET: 895200
SEAT INCLUDED: 648750

LF465051
LF465052

FOR PRICE PFISTER
LENGTH: 2.65"

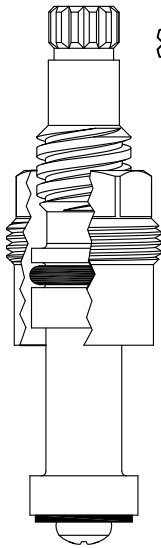

12
1-2

GASKET: 895060

LF465091
LF465092



SEAT USED: LF648270

NEW STYLE
QUARTURN

FOR CHICAGO
LENGTH: 2.65"

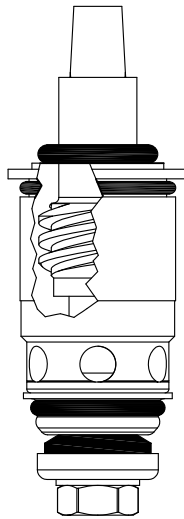

Nickel Plated Stem

GASKET: 895200
SEAT INCLUDED: 648750

LF465221
LF465222

SLOW COMPRESSION
CONTROL-A-FLOW

FOR CHICAGO
LENGTH: 2.65"

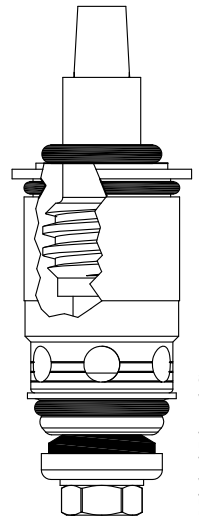

Nickel Plated Stem

GASKET: 895200
SEAT INCLUDED: 648750

LF465231
LF465232

QUARTURN
CONTROL-A-FLOW

FOR CHICAGO
LENGTH: 2.65"

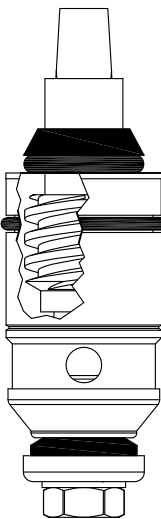

Nickel Plated Stem

GASKET: 895200
SEAT INCLUDED: 648750

LF465241
LF465242

NEW STYLE
SLOW COMPRESSION

FOR CHICAGO
LENGTH: 2.65"

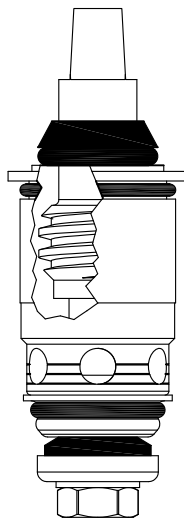

Nickel Plated Stem

GASKET: 895200
SEAT INCLUDED: 648750

LF465281
LF465282

NON-METERING

FOR WILLOUGHBY
LENGTH: 2.65"

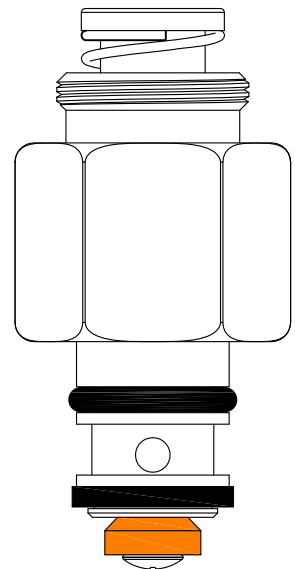

LF465470

FOR CENTRAL
LENGTH: 2.66"

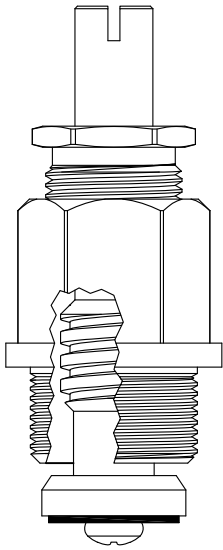

GASKET: 895400

401611
201611 Stem Only

FOR CENTRAL
LENGTH: 2.66"

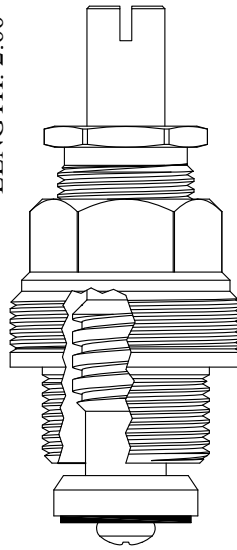

GASKET: 895400

401621
201611 Stem Only

FOR BROADWAY
LENGTH: 2.66"

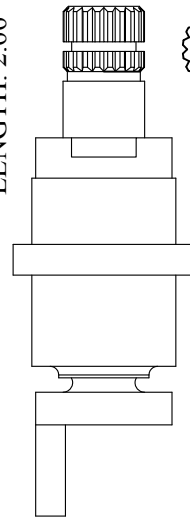

20
2-4

430540

FOR SIGN OF THE CRAB
LENGTH: 2.66"

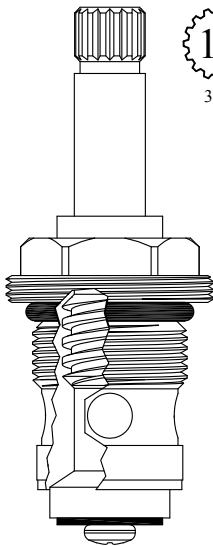

16
3-16

Chrome Plated Stem

GASKET: 891150 O-RING INCLUDED

430761

FOR CRANE
LENGTH: 2.66"

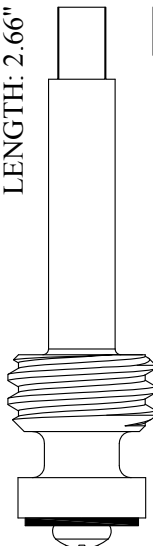

1/4

Chrome Plated Stem

LF264461

FOR CENTRAL
LENGTH: 2.66"

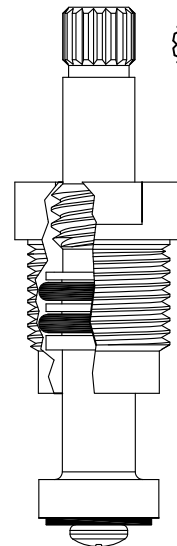

16
1-6

GASKET: 895100

LF464811
LF464812

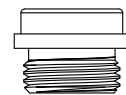

SEAT USED: LF648550

FOR RICHARD RHEEM
LENGTH: 2.66"

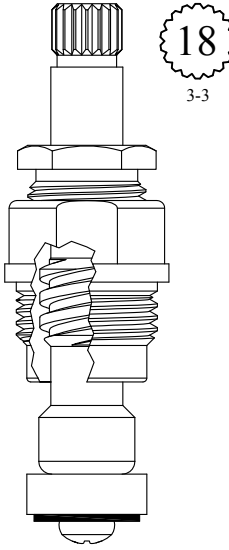

GASKET: 895100

LF465081
LF465082



FOR STERLING FAUCET
LENGTH: 2.67"

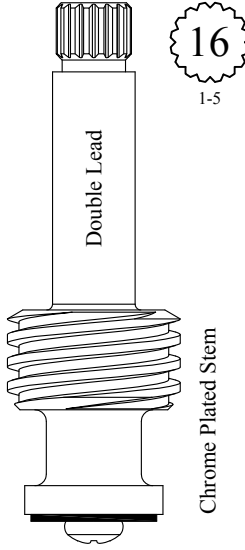

LF264861
LF264862

FOR CRANE
CERAMIC CONVERSION FOR DIAL-EZE
LENGTH: 2.67"

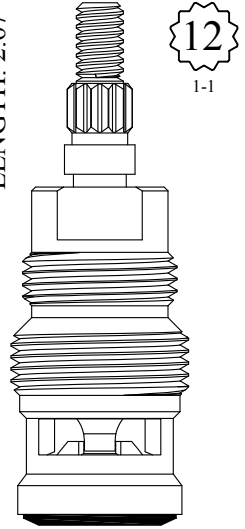

GASKET: 895250 INCLUDED
DISC SET: 151380-PKG

LF464311
LF464312

FOR T & S
LENGTH: 2.67"

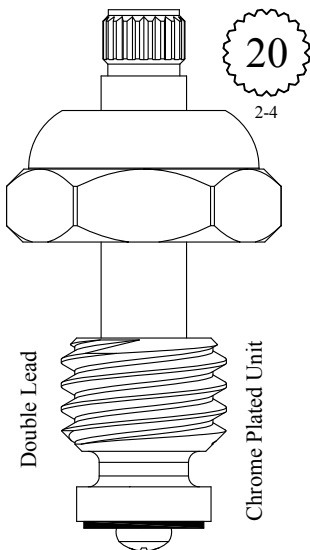

LF465021
LF465022
LF265021 Stem Only
LF265022 Stem Only

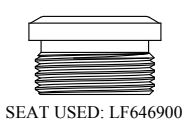

FOR RICHARD RHEEM
LENGTH: 2.67"

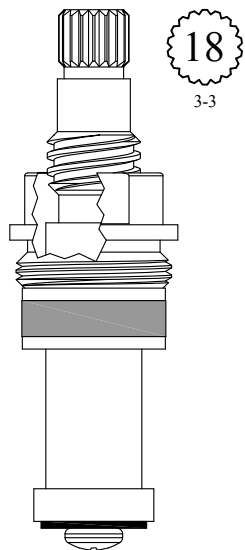

LF465111
LF465112



FOR T & S
LENGTH: 2.67"

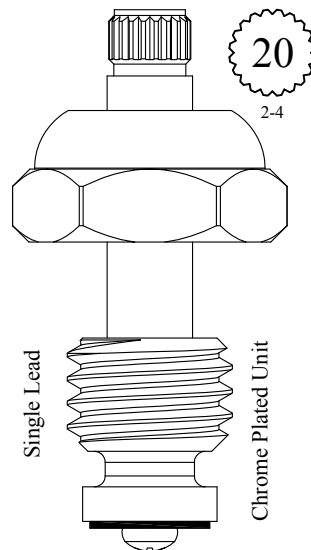

LF465181
LF265181 Stem Only

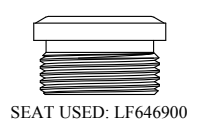

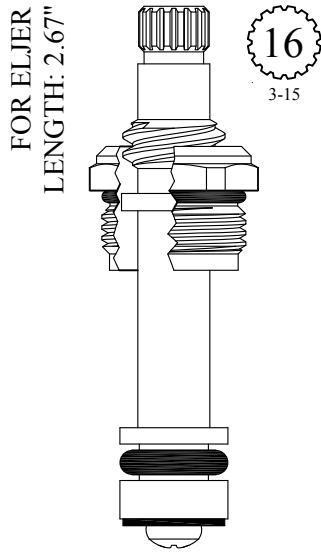

16
3-15

GASKET: 890160 O-RING INCLUDED

LF465381

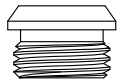

SEAT USED: LF648320

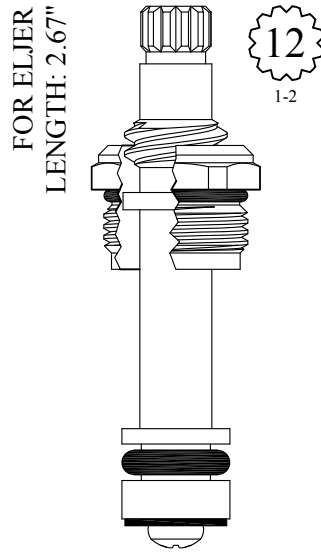

12
1-2

GASKET: 890160 O-RING INCLUDED

LF465391
LF465392



SEAT USED: LF648320

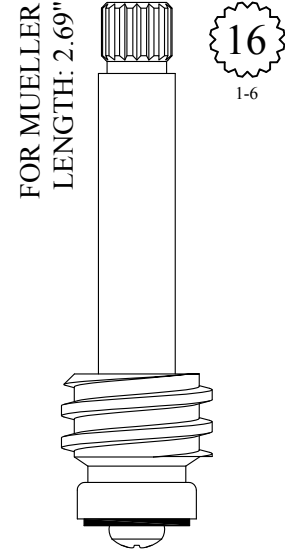

16
1-6

201411

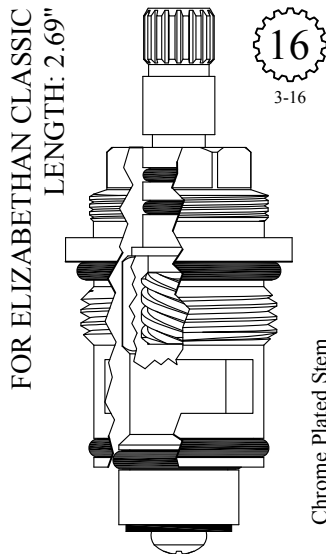

16
3-16

Chrome Plated Stem

GASKET: 890180 O-RING INCLUDED

431052

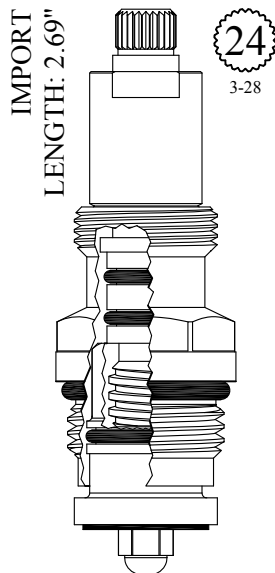

24
3-28

GASKET: 891150 INCLUDED

LF464712

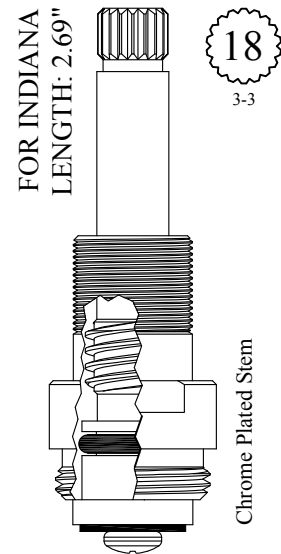

18
3-3

Chrome Plated Stem

GASKET: 895150

LF465061
LF465062

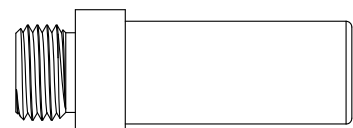

SEAT USED: LF649160

FOR WATTS
LENGTH: 2.70"

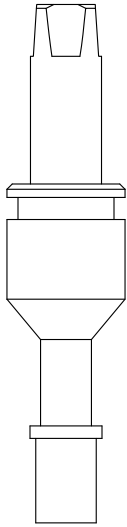

130990

FOR CHASE
LENGTH: 2.70"

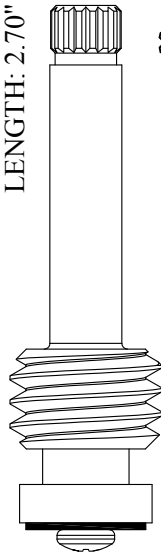

16
1-6

Chrome Plated Stem

LF264171

FOR BARBER WILSON
LENGTH: 2.70"

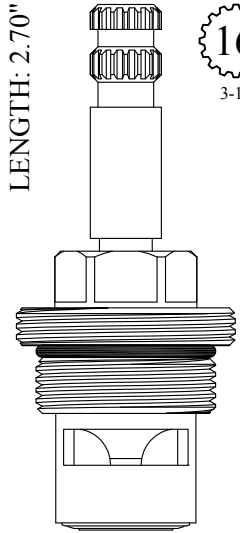

16
3-16

GASKET: 890190 O-RING INCLUDED
SEAL: 898510-W
DISC SET: 151380-PKG

LF464571
LF464572

FOR STERLING FAUCET
LENGTH: 2.71"

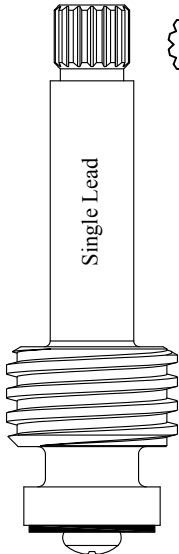

16
1-5

Single Lead

Chrome Plated Stem

LF264871
LF264872

FOR CRANE
LENGTH: 2.69"

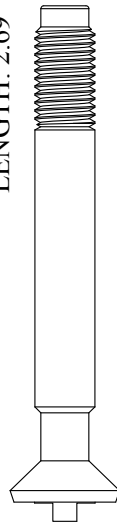

NO LONGER AVAILABLE, USE LF465150

LF265140

FOR AM STD
LENGTH: 2.71"

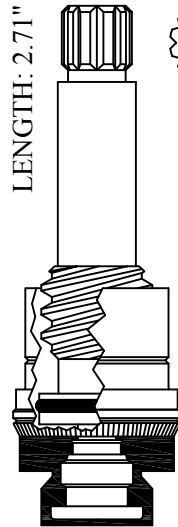

12
1-2

LF464901
LF464902

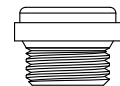

SEAT USED: LF648990

FOR DORNBRACHT
LENGTH: 2.72"

20
3-20

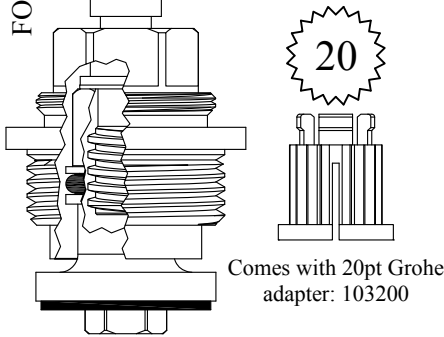

Comes with 20pt Grohe
adapter: 103200

GASKET: 895560

401762



SEAT USED: LF647120

UNKNOWN
LENGTH: 2.72"

16
3-16

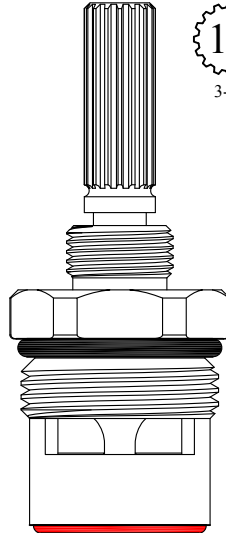

GASKET: 891180 O-RING INCLUDED
SEAL: 898610-R/B
DISC SET: 109850-PKG

401561
401562

IMPORT
LENGTH: 2.72"

24
3-18

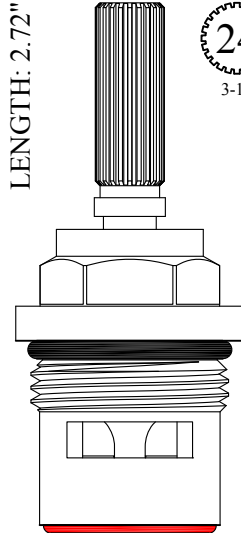

GASKET: 891180 O-RING INCLUDED
SEAL: 898610-R/B
DISC SET: 109850-PKG

401591
401592

Also available less gland
LF117621

FOR ACORN
LENGTH: 2.72"

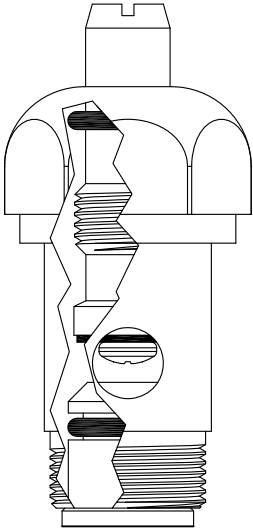

GASKET: 895400
SEAT INCLUDED: LF601780

LF401781
LF254071 Stem Only

FOR ELJER
LENGTH: 2.72"

16
3-15

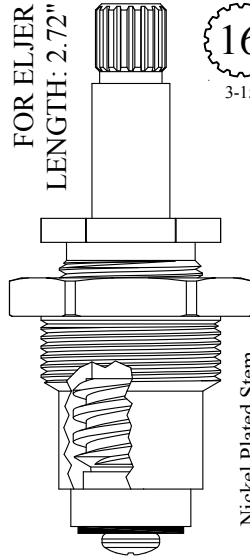

Nickel Plated Stem

GASKET: 895330

LF465071
LF465072
LF265071 Stem Only
LF265072 Stem Only



SEAT USED: LF648160

FOR ELJER
LENGTH: 2.72"

16
3-15

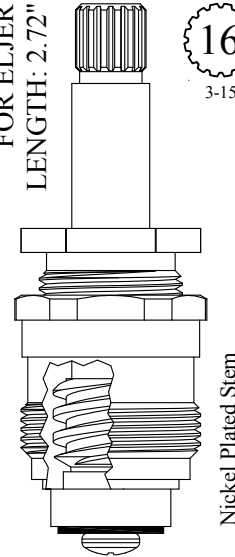

Nickel Plated Stem

GASKET: 895120

LF465571
LF465572
LF265071 Stem Only
LF265072 Stem Only



SEAT USED: LF648160

FOR ELJER
LENGTH: 2.73"

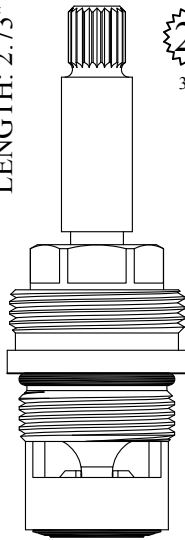

20
3-20

GASKET: 890170 O-RING INCLUDED
SEAL: 898510
DISC SET: 151380-PKG

LF464921
LF464922

FOR AM STD
LENGTH: 2.74"

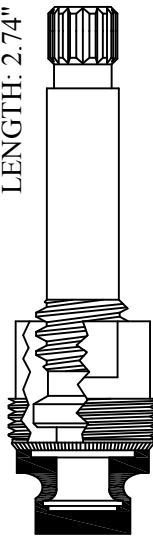

16

401631
401632

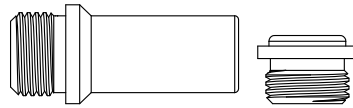

SEAT USED: LF647910 or LF649650

FOR SIGNATURE HARDWARE
LENGTH: 2.74"

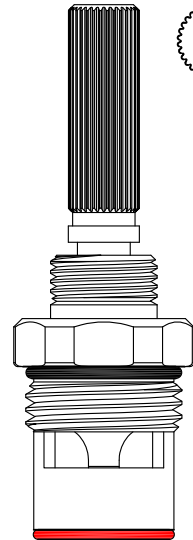

32
3-23

GASKET: 890170 O-RING INCLUDED
SEAL: 898570-R/B
DISC SET: 151380-PKG

LF464421
LF464422

FOR SEACREST
LENGTH: 2.68"

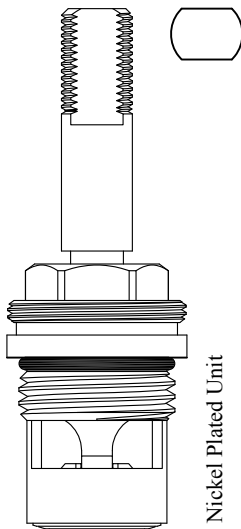

Nickel Plated Unit

GASKET: 890170 O-RING INCLUDED
SEAL: 898510-W
DISC SET: 151380-PKG

LF464611
LF464612

FOR ALTMANS
LENGTH 2.74"

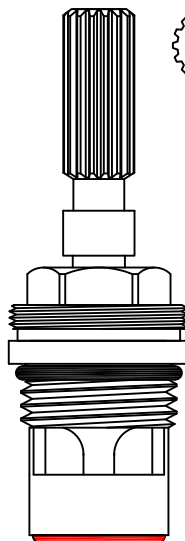

16
3-16

GASKET: 890170 O-RING INCLUDED
SEAL: 898570-R/B
DISC SET: 151380-PKG

LF464911
LF464912

FOR PRICE PFISTER
LENGTH: 2.74"

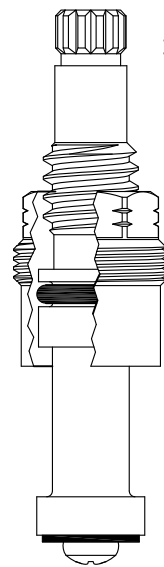

12
1-2

GASKET: 895060

LF465291

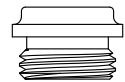

SEAT USED: LF648270

FOR DONNER
LENGTH: 2.75"

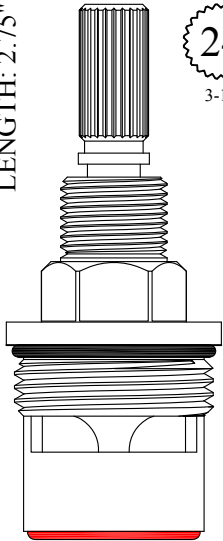

24
3-19

GASKET: 890210 O-RING INCLUDED
SEAL: 898610-R/B
DISC SET: 109850-PKG

401491
401492

FOR ALTMANS
LENGTH: 2.75"

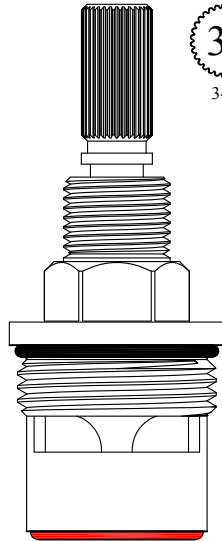

32
3-23

GASKET: 890210 O-RING INCLUDED
SEAL: 898610-R/B
DISC SET: 109850-PKG

401571
401572

FOR ALTMANS
LENGTH 2.75"

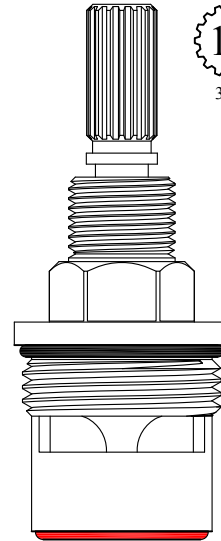

16
3-16

GASKET: 890210 O-RING INCLUDED
SEAL: 898610-R/B
DISC SET: 109850-PKG

401641
401642

FOR NEWPORT
LENGTH: 2.75"

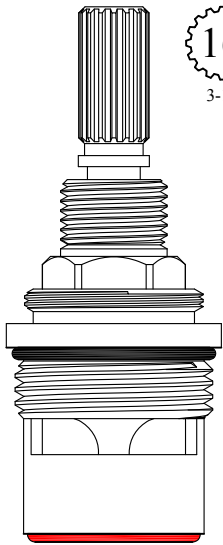

16
3-16

GASKET: 890210 O-RING INCLUDED
SEAL: 898610-R/B
DISC SET: 109850-PKG

401651
401652

Also available in a Chrome Plated Unit
401651-CP / 401652-CP

FOR BRIGGS
LENGTH: 2.75"

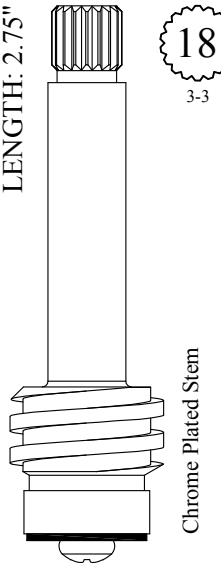

18
3-3

Chrome Plated Stem

LF265201

FOR ELJER
LENGTH: 2.75"

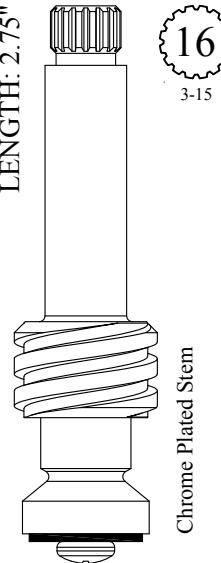

16
3-15

Chrome Plated Stem

LF265601
LF265602

FOR TANNER
LENGTH: 2.77"

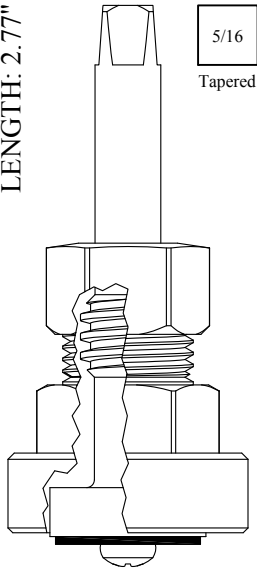

5/16
Tapered

GASKET: 894860 INCLUDED

465251

Extension Available
#135000

FOR KOHLER
LENGTH 2.77"

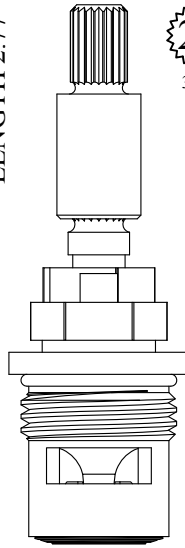

20
3-20

Nickel Plated Gland

GASKET: 890170 O-RING INCLUDED
SEAL: 898510
DISC SET: 151380-PKG

LF464941

CERAMIC 1/4 TURN

FOR CHICAGO
LENGTH: 2.77"

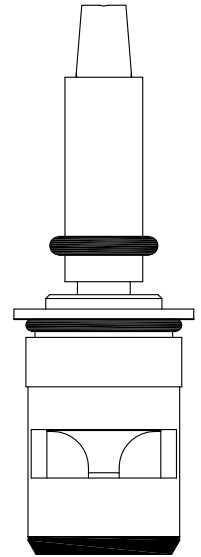

Nickel Plated Stem

GASKET: 890170 O-RING INCLUDED
SEAL: 898590
DISC SET: 151380-PKG

LF465461
LF465462

FOR AM STD
LENGTH: 2.78"

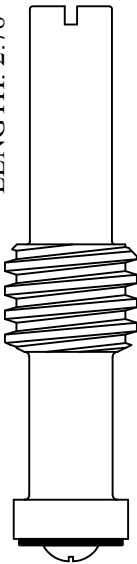

Chrome Plated Stem

201711

UNKNOWN
LENGTH: 2.78"

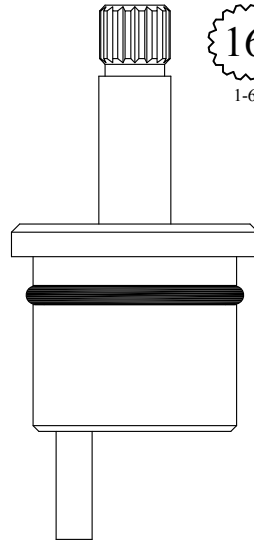

16
1-6

230860

FOR AM STD
LENGTH: 2.78"

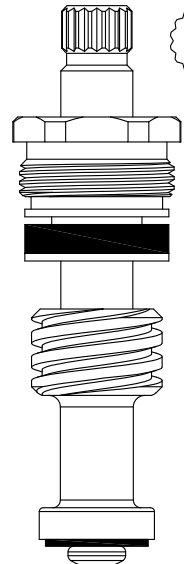

16

LF465101
LF465102
LF265101
LF265102

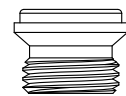

SEAT USED: LF648350

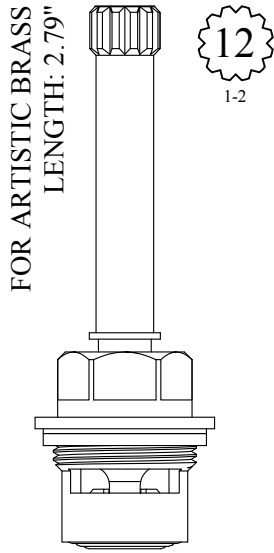

GASKET: 895100 INCLUDED
SEAL: 898500
DISC SET: 112530-PKG

401661
401662

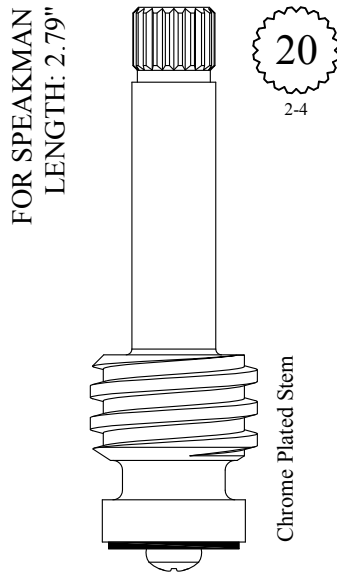

LF265421

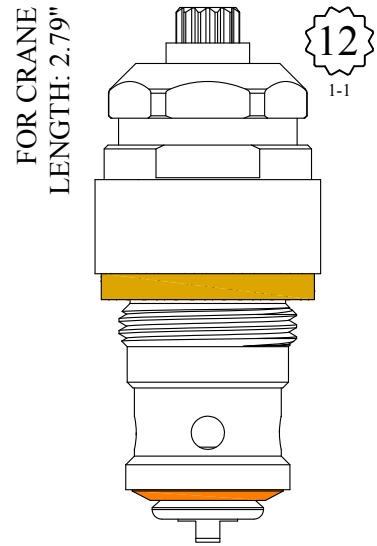

LF456090
LF256090 Stem Only

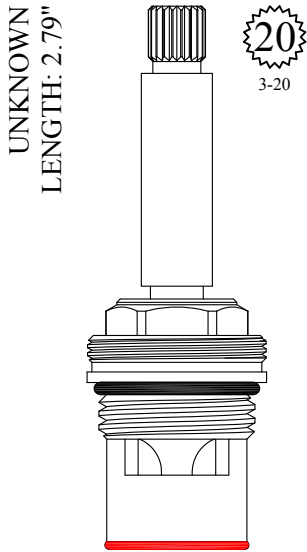

GASKET: 890170 O-RING INCLUDED
SEAL: 898580-R/B
DISC SET: 151380-PKG

LF465331
LF465332

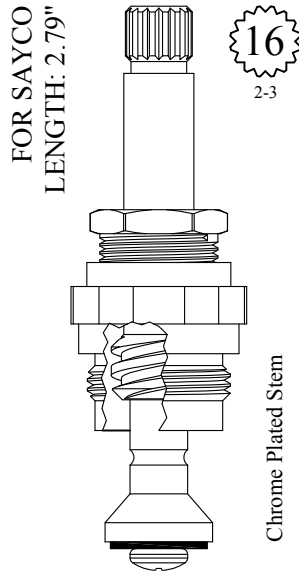

GASKET: 895100

LF466091
LF466092
LF266091 Stem Only
LF266092 Stem Only



SEAT USED: LF647450

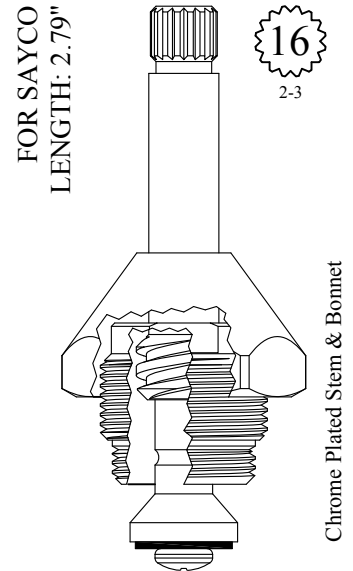

GASKET: 895100

LF466191
LF466192
LF266091 Stem Only
LF266092 Stem Only



SEAT USED: LF647450

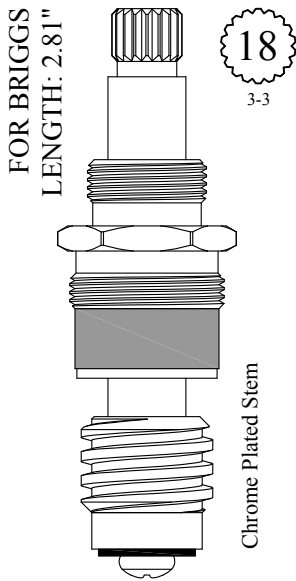

FOR BRIGGS
LENGTH: 2.81"

Chrome Plated Stem

LF465271
LF265271 Stem Only

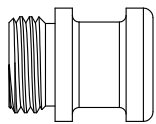

SEAT USED: LF648250

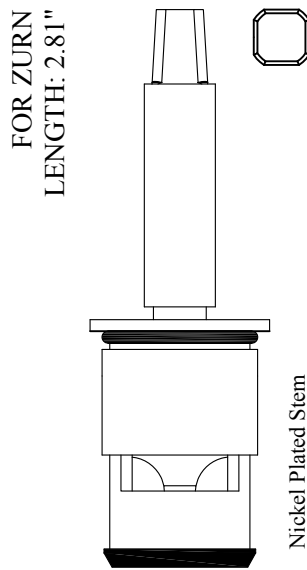

FOR ZURN
LENGTH: 2.81"

Nickel Plated Stem

SEAL: 898590
DISC SET: 151380-PKG

LF465441
LF465442

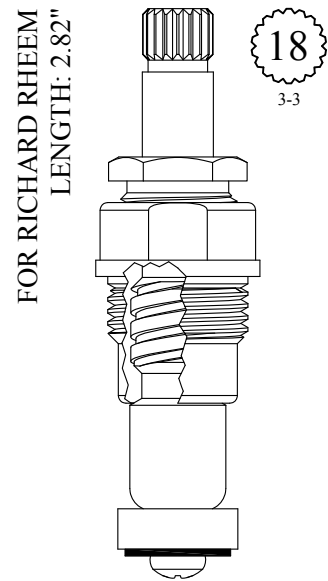

FOR RICHARD RHEEM
LENGTH: 2.82"

GASKET: 895100

LF465191
LF465192

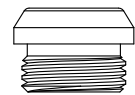

SEAT USED: LF648130

FOR T & S
LENGTH: 2.83"

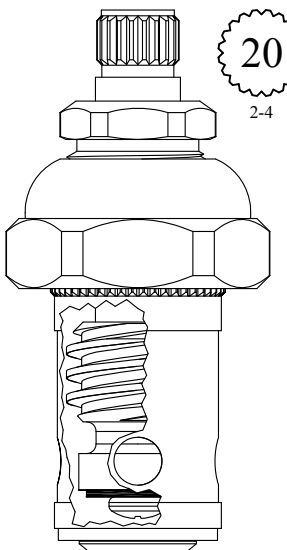

Chrome Plated Stem & Bonnet
Also available with handle ABRIS33410
LF453131-3341 / LF453132-3341

LF464061
LF464062
LF264061 Stem Only
LF264062 Stem Only

USES BARREL:
LF664061/LF664062

FOR T & S
LENGTH: 2.83"

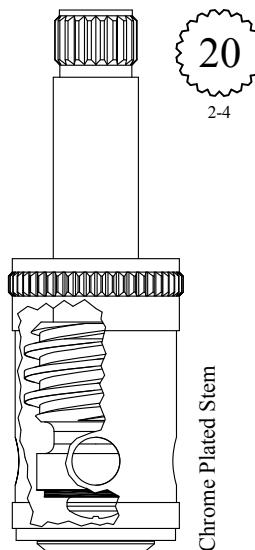

Chrome Plated Stem

LF464061-LB
LF464062-LB
LF264061 Stem Only
LF264062 Stem Only

USES BARREL:
LF664061/LF664062

IMPORT
LENGTH: 2.83"

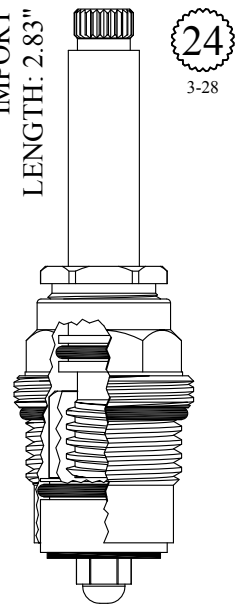

GASKET: 890180 INCLUDED

LF464962

Individual items available
 Stem Ext. 1-1/4": #105340-PB
 & 105340-CP
 Ext. Adap. Screw: #103310

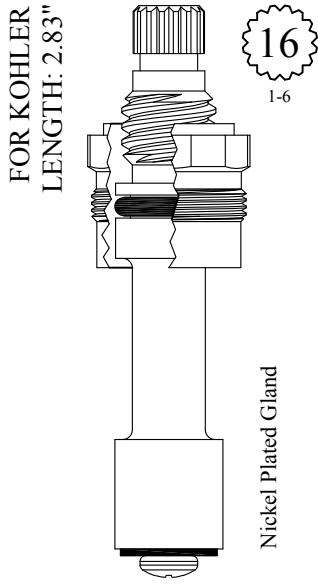

FOR KOHLER
 LENGTH: 2.83"

16
 1-6

Nickel Plated Gland

GASKET: 895060

LF465131
 LF465132

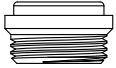

SEAT USED: LF648070

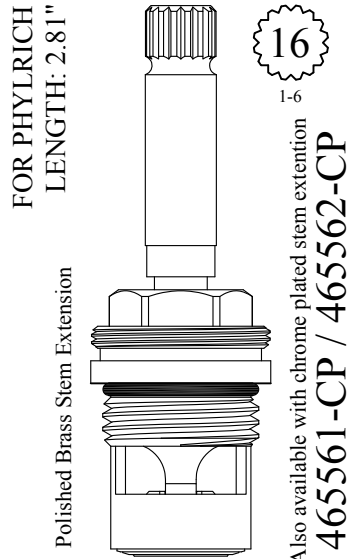

FOR PHYLRICH
 LENGTH: 2.81"

16
 1-6

Polished Brass Stem Extension

Also available with chrome plated stem extension
465561-CP / 465562-CP

GASKET: 890170 O-RING INCLUDED
 SEAL: 898510-W
 DISC SET: 151380-PKG

LF465561
 LF465562

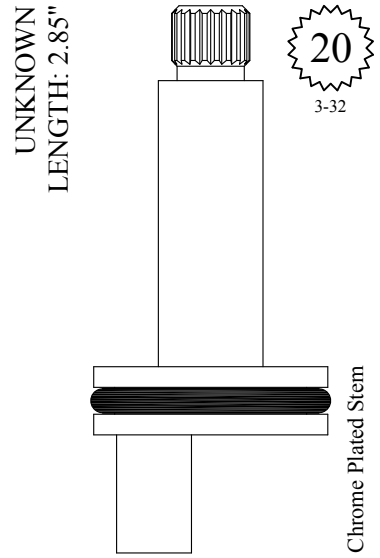

UNKNOWN
 LENGTH: 2.85"

20
 3-32

Chrome Plated Stem

231090

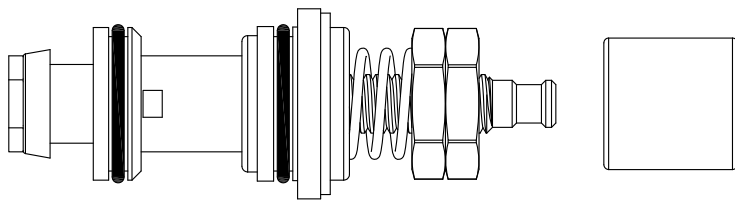

LF128000

FOR METCRAFT
 LENGTH: 2.85"

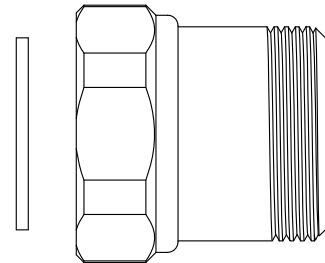

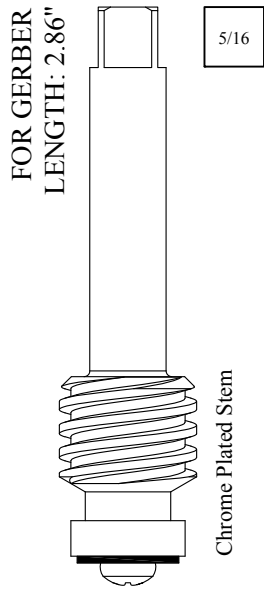

LF266211
LF266212

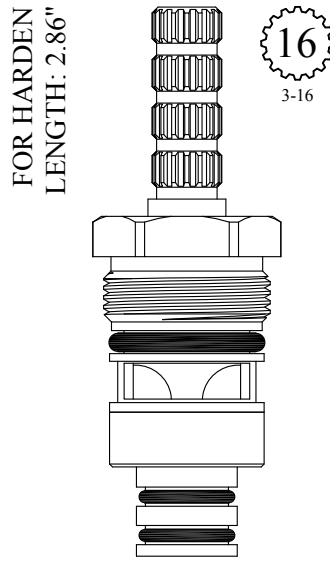

GASKET: 891140 O-RING INCLUDED
DISC SET: 151380-PKG

LF465401
LF465402

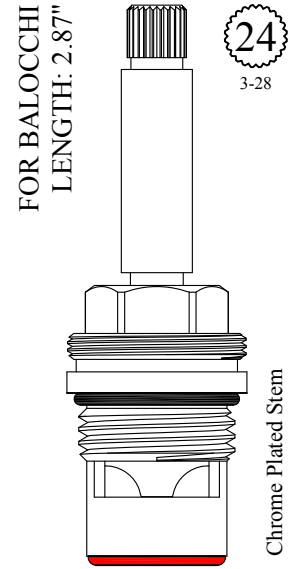

GASKET: 890170 O-RING INCLUDED
SEAL: 898570-R/B
DISC SET: 151380-PKG

LF465341
LF465342

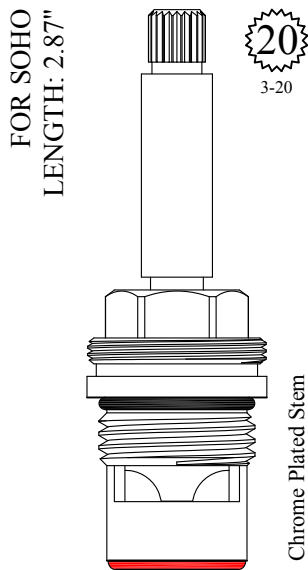

GASKET: 890170 O-RING INCLUDED
SEAL: 898570-R/B
DISC SET: 151380-PKG

LF465371
LF465372

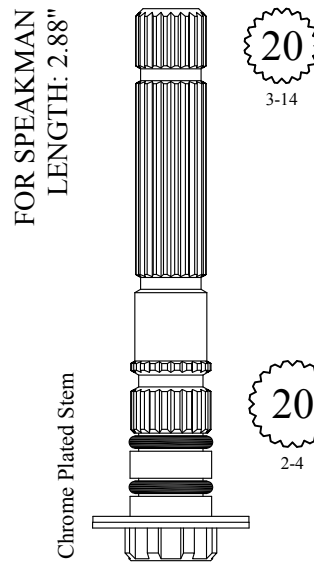

201510

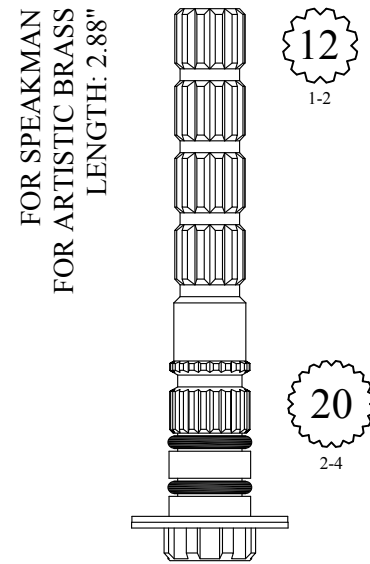

201540

FOR SPEAKMAN
LENGTH: 2.88"

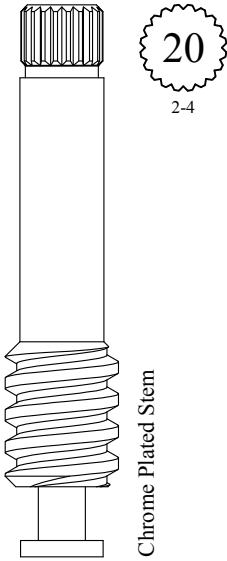

Chrome Plated Stem

201681

FOR AM STD
LENGTH: 2.88"

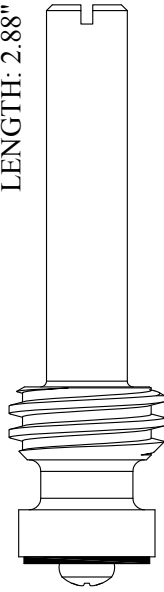

Chrome Plated Stem

265611

FOR DORNBRACHT
LENGTH: 2.88"

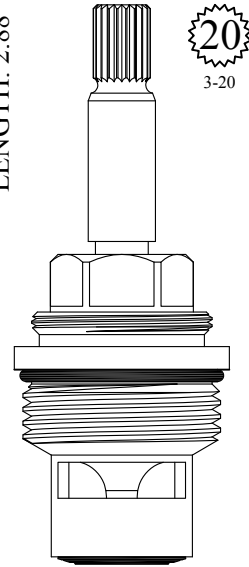

GASKET: 890210 O-RING INCLUDED
SEAL: 898510
DISC SET: 151380-PKG

401691
401692

FOR ACME
LENGTH: 2.88"

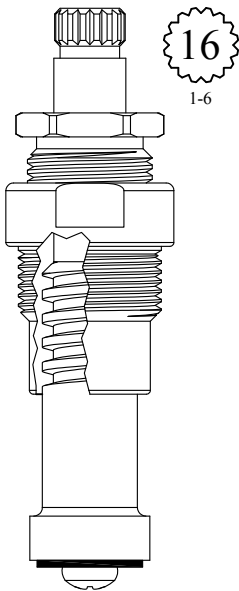

GASKET: 895100

LF465301
LF465302

FOR SOHO
LENGTH: 2.88"

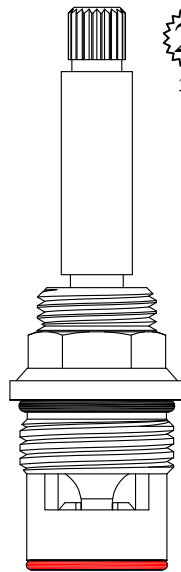

Chrome Plated Stem

GASKET: 890170 O-RING INCLUDED
SEAL: 898580-R/B
DISC SET: 151380-PKG

LF465351
LF465352

Also available with polished brass stem

LF465351-PB / LF465352-PB

Also available with polished nickel stem

LF465351-PN / LF465352-PN

FOR LIBERTY
LENGTH: 2.89"

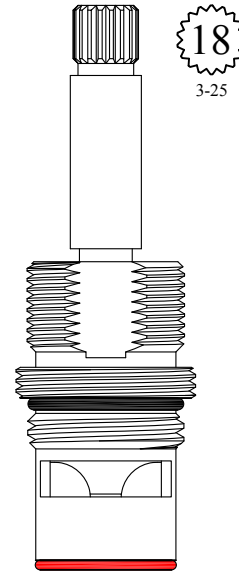

GASKET: 890170 O-RING INCLUDED
SEAL: 898570-R/B
DISC SET: 151380-PKG

LF465431
LF465432

FOR STERLING FAUCET
LENGTH: 2.89"

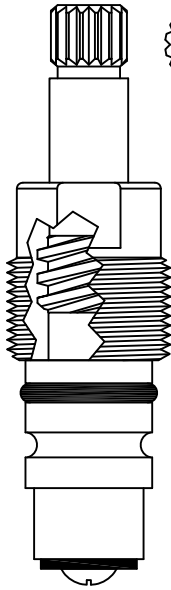

16
1-5

LF465621
LF465622

FOR LIBERTY
LENGTH: 2.89"

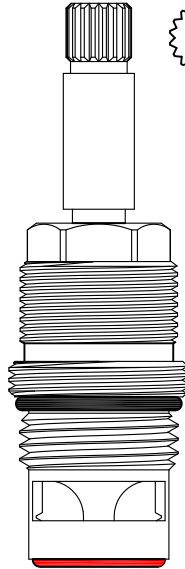

18
3-25

GASKET: 890170 O-RING INCLUDED
SEAL: 898570-R/B
DISC SET: 151380-PKG

LF465711
LF465712

FOR CRANE
LENGTH: 2.90"

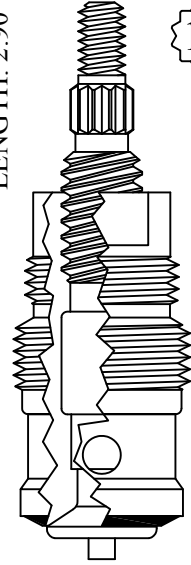

12
1-1

GASKET: 895250

LF465121
LF465122
LF265121 Stem Only
LF265122 Stem Only

FOR THG
LENGTH 2.90"

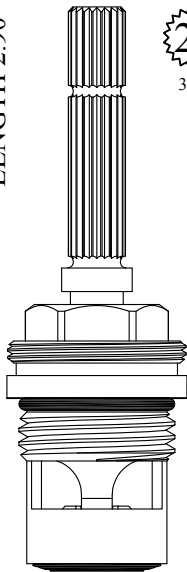

20
3-20

GASKET: 890170 O-RING INCLUDED
SEAL: 898510-W
DISC SET: 151380-PKG

LF465581
LF465582

FOR CHG
STEM LENGTH: 2.56"

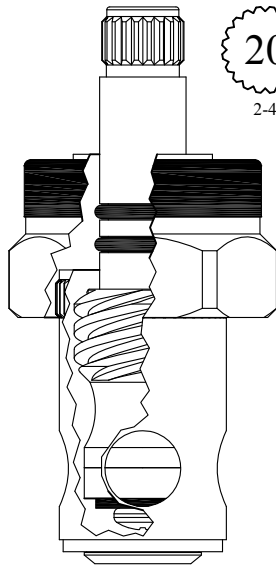

20
2-4

Chrome Plated Stem & Bonnet

LF466481
LF466482

UNKNOWN
LENGTH: 2.91"

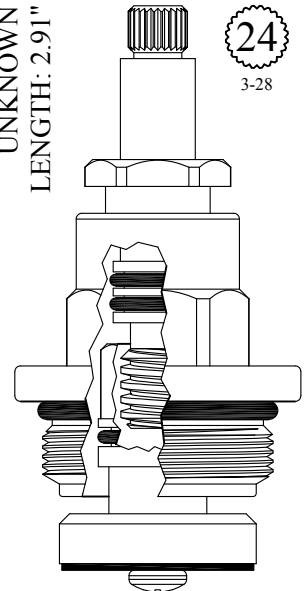

24
3-28

GASKET: 891210 O-RING INCLUDED

401922

Chrome Plated Unit

FOR HELVIX
LENGTH: 2.48"

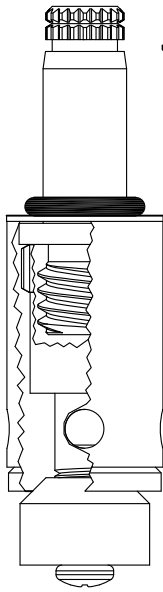

19
1-7

Chrome Plated Stem

430992

FOR ROHL
LENGTH: 2.91"

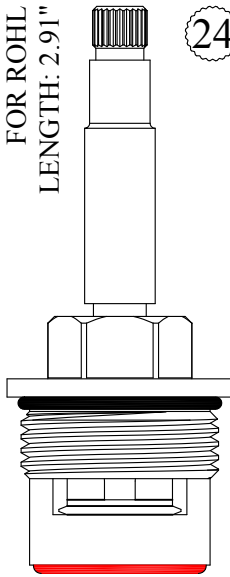

24

GASKET: 890210 O-RING INCLUDED
SEAL: 898610-R/B
DISC SET: 109850-PKG

401601
401602

Extension Available
#135000

FOR KOHLER
LENGTH: 2.91"

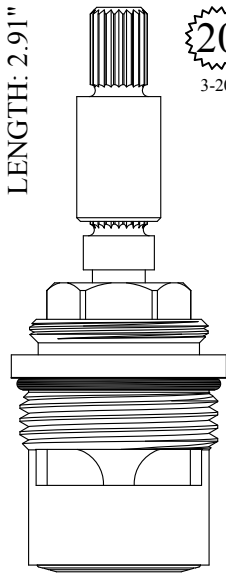

20
3-20

GASKET: 890210 O-RING INCLUDED
SEAL: 898520
DISC SET: 109850-PKG

401671
401672

FOR FEDERAL HUBER
LENGTH: 2.91"

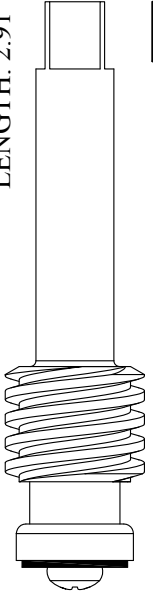

5/16

Chrome Plated Stem

LF266021
LF266022

FOR AM STD
LENGTH: 2.92"

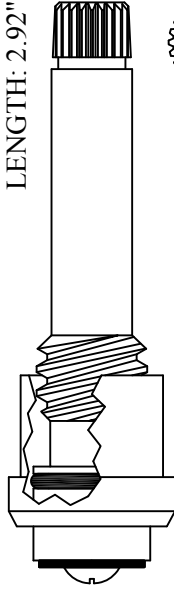

22
1-4

Chrome Plated Stem

GASKET: 891130

LF466041
LF466042

FOR CRANE
LENGTH: 2.92"

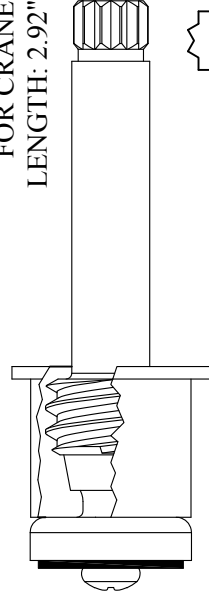

12
3-10

Chrome Plated Stem

LF466051
LF466052

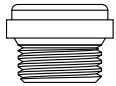

SEAT USED: LF648990

FOR AM STD
LENGTH: 2.92"

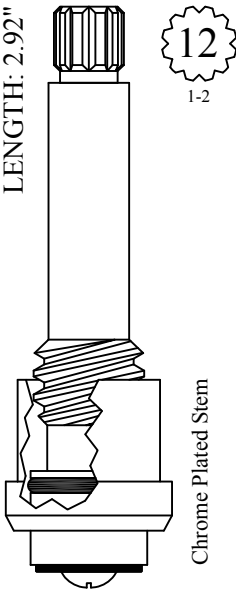

Chrome Plated Stem

GASKET: 891130

LF466141
LF466142

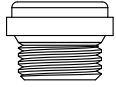

SEAT USED: LF648990

FOR ELJER
LENGTH: 2.93"

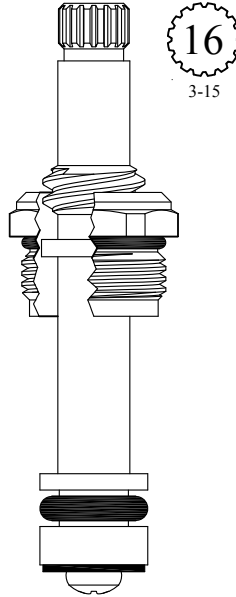

GASKET: 890160 O-RING INCLUDED

LF465801
LF465802

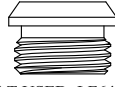

SEAT USED: LF648320

FOR SPEAKMAN
LENGTH: 2.94"

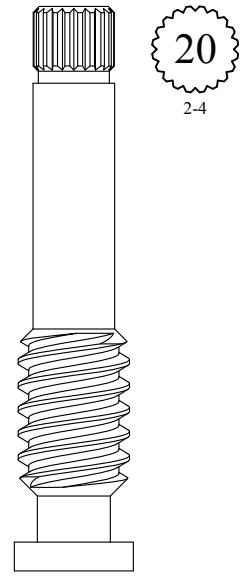

201701

IMPORT
LENGTH: 2.94"

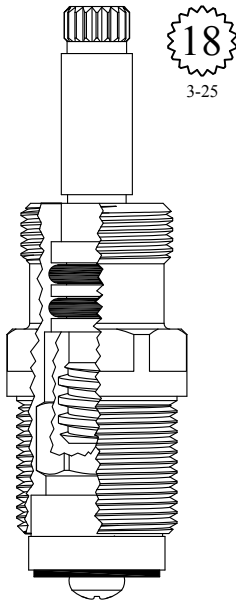

401722

IMPORT
LENGTH: 2.94"

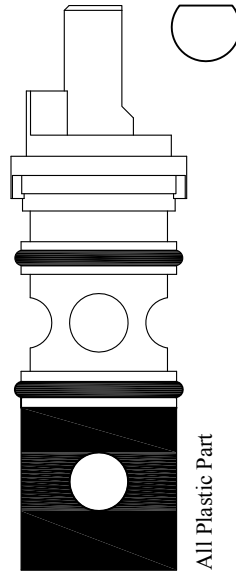

430160

FOR AM STD
LENGTH: 2.94"

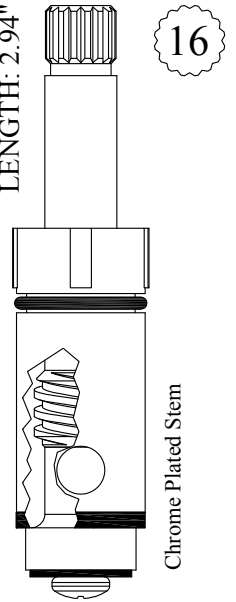

430442

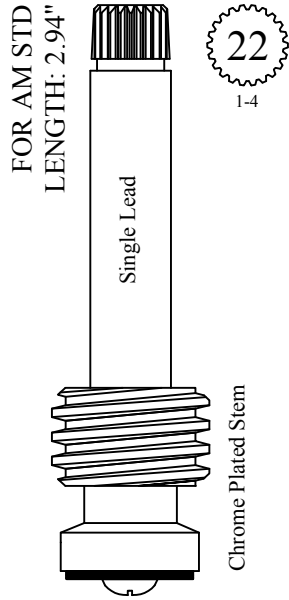

LF266031
USES BARREL:
LF647031

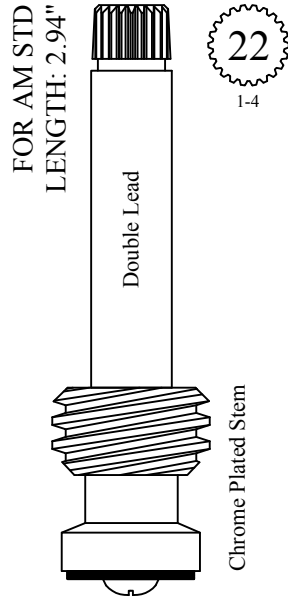

LF266151
LF266152
USES BARREL:
LF647041/LF647042

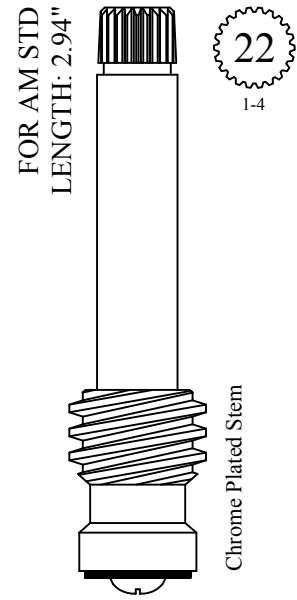

LF266171
LF266172

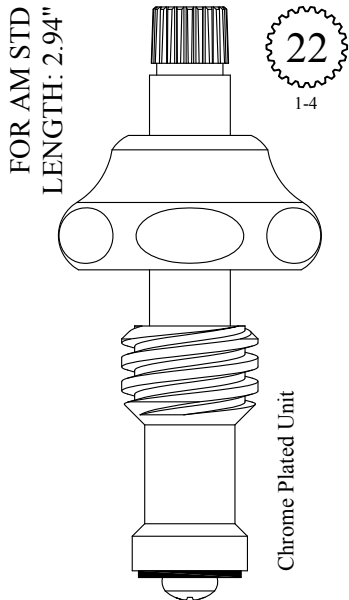

LF466081
LF266081 Stem Only

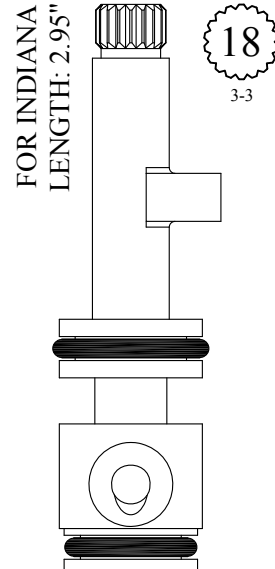

230030

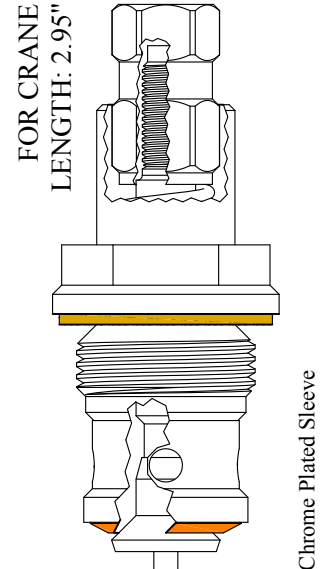

GASKET: 895250 INCLUDED

LF465150
LF265150 Stem Only

FOR CRANE
LENGTH: 2.95"

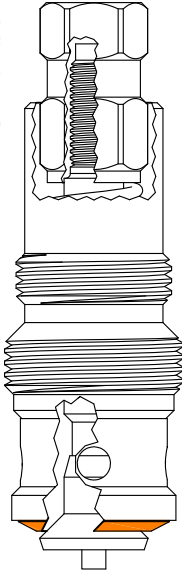

GASKET: 895250 INCLUDED

LF465160
LF265150 Stem Only

FOR KRONIN BY VIOLA
LENGTH: 2.94"

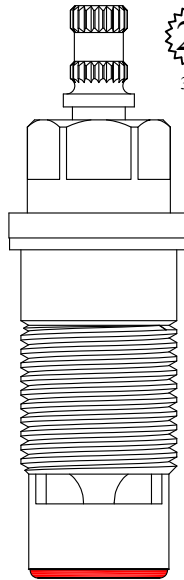

20
3-20

GASKET: 895150 INCLUDED
SEAL: 898570-R/B
DISC SET: 151380-PKG

LF466251
LF466252

FOR PHYLRICH
LENGTH: 2.96"

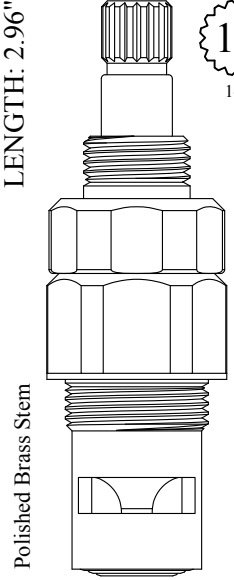

16
1-6

GASKET: 895270 INCLUDED
SEAL: 898500
DISC SET: 112530-PKG

LF466201
LF466202

Also available with Polished Chrome Stem

LF466201-CP / LF466202-CP

FOR DORF
LENGTH: 2.97"

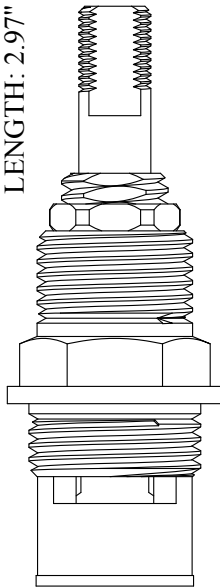

GASKET: 895370 INCLUDED
DISC SET: 124290-PKG

LF465941
LF465942

Also available with Chrome Plated Stem
LF465941-CP / LF465942-CP

FOR AM STD
LENGTH: 2.97"

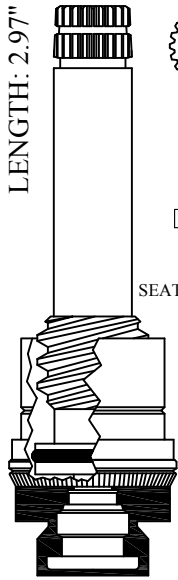

22
1-4

SEAT USED: LF648990

Chrome Plated Stem

LF466011
LF466012

Also available with locknut:
LF466011-N / LF466012-N

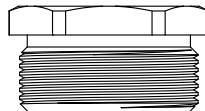

FOR STERLING FAUCET
LENGTH: 2.97"

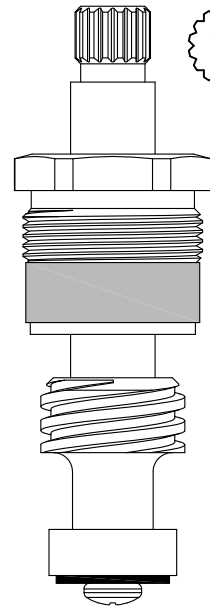

16
1-5

LF466061
LF466062

LF266061 Stem Only

LF266062 Stem Only



SEAT USED: LF648170

FOR SPEAKMAN
LENGTH: 2.97"

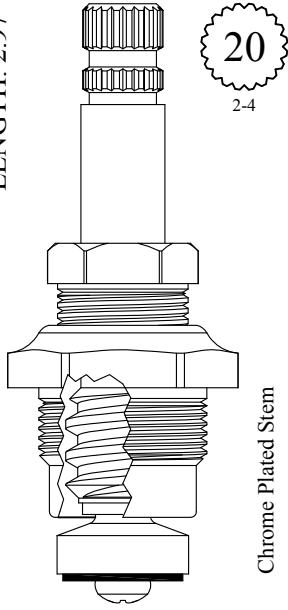

GASKET: 895400

LF467171
LF467172
LF267171 Stem Only
LF267172 Stem Only

FOR BRADLEY
LENGTH: 2.98"

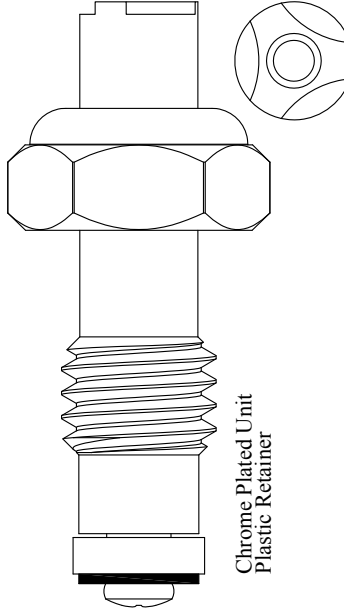

401731
201731 Stem Only

FOR HARCRAFT
LENGTH: 2.98"

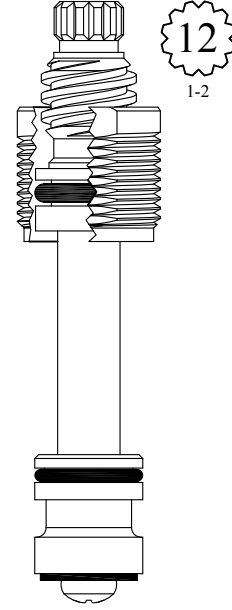

GASKET: 895040 INCLUDED

LF465411



SEAT USED: LF648670

FOR AUBURN BRASS
LENGTH: 2.98"

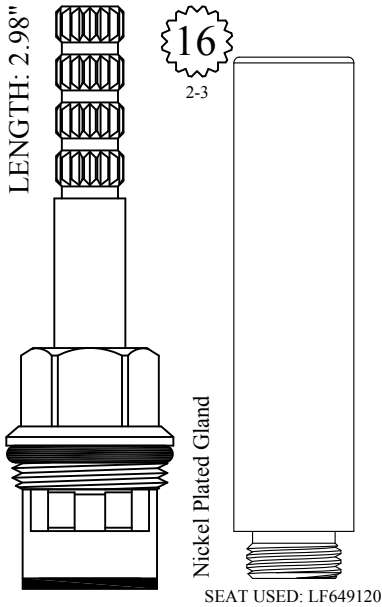

GASKET: 890160 O-RING INCLUDED
DISC SET: 151380-PKG

LF465451
LF465452

FOR STERLING FAUCET
LENGTH: 2.98"

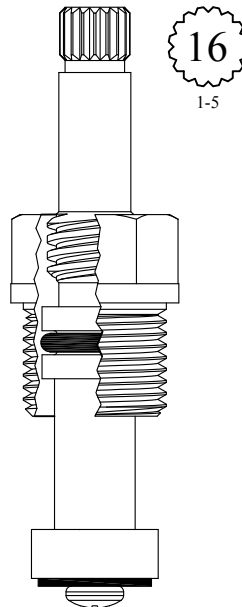

GASKET: 895100

LF465631
LF465632

UNKNOWN
LENGTH: 2.98"

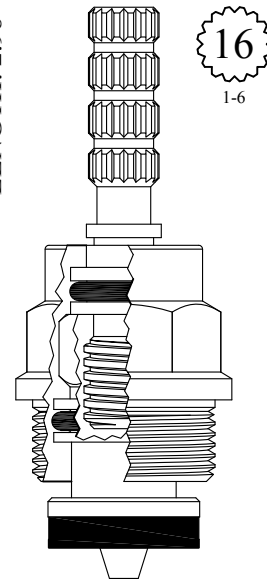

GASKET: 895330

LF465702

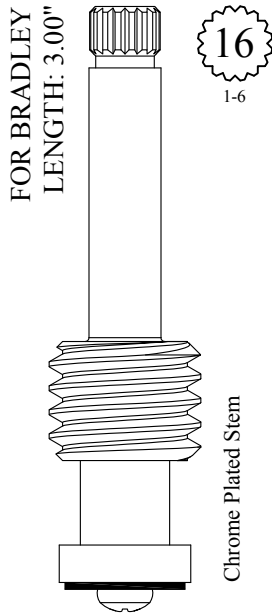

201841

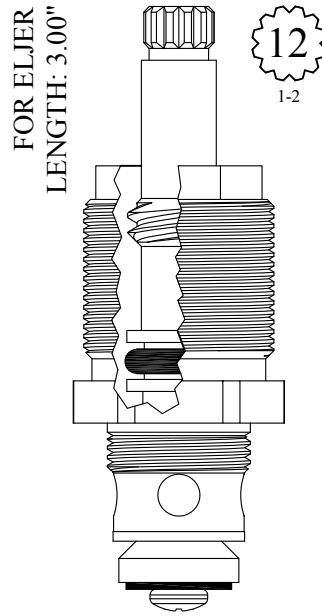

GASKET: 895100

430271

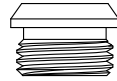

SEAT USED: LF648320

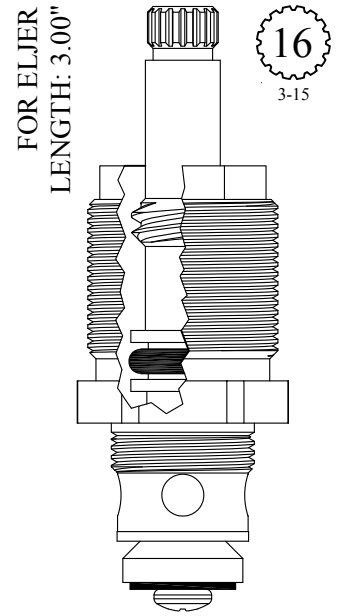

GASKET: 895100

430281

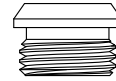

SEAT USED: LF648320

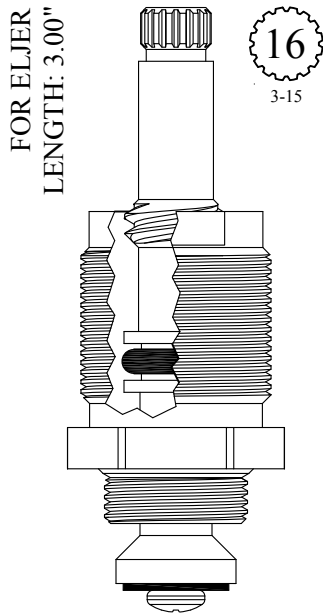

GASKET: 895100

401741

401742

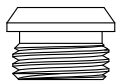

SEAT USED: LF648320

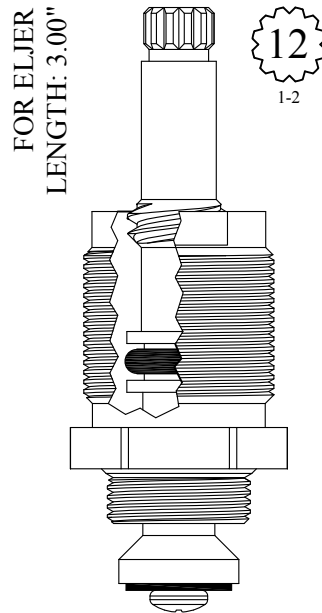

GASKET: 895100

401791

401792

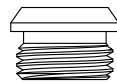

SEAT USED: LF648320

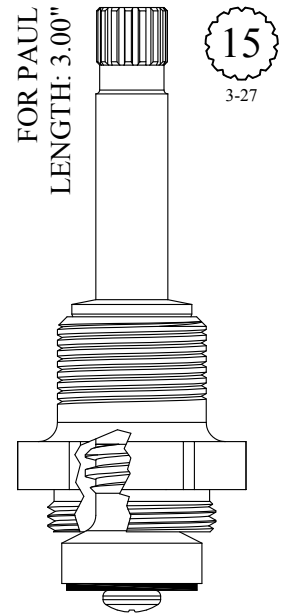

GASKET: 895400

401861

401862

201861 Stem Only

201862 Stem Only

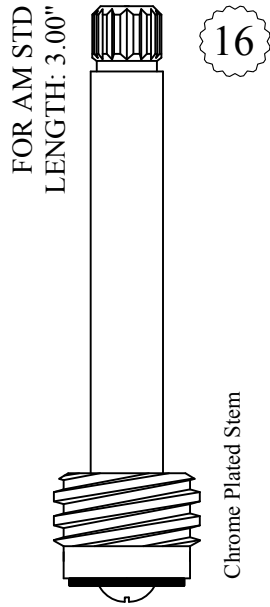

LF266071
LF266072

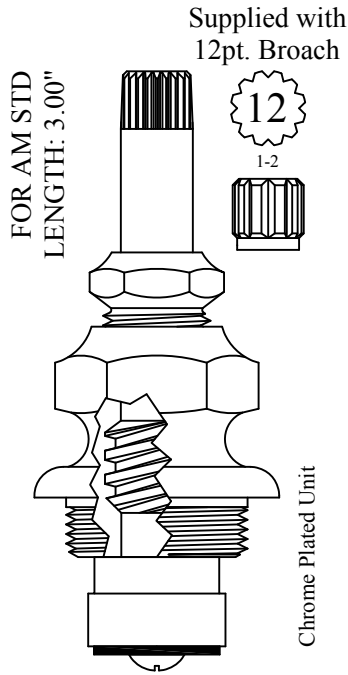

LF466301

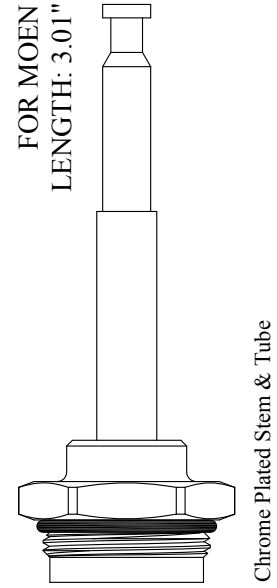

GASKET: 890190 O-RING INCLUDED
430450

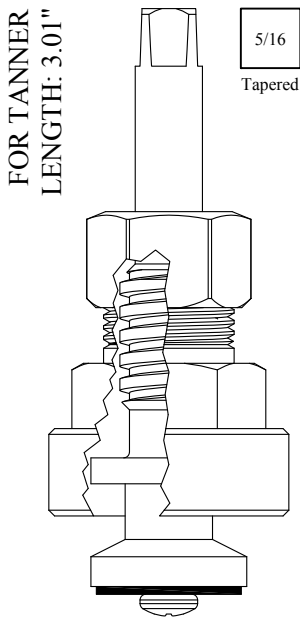

GASKET: 894860 INCLUDED
466341

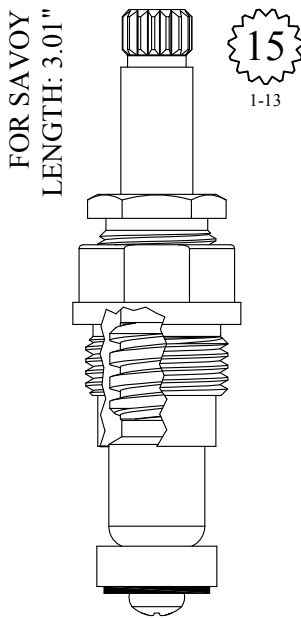

GASKET: 895100
LF465211
LF465212

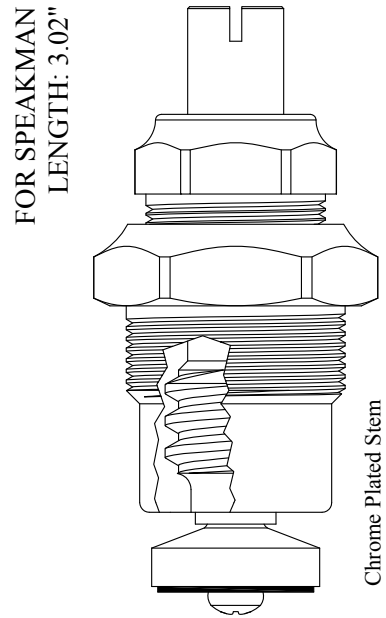

GASKET: 895450
402071
202071 Stem Only

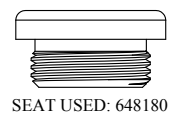

FOR PRICE PFISTER
LENGTH: 3.00"

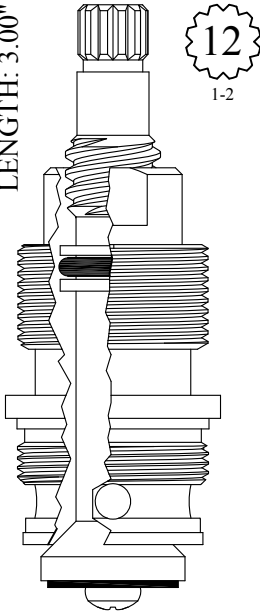

12
1-2

GASKET: 895550

430071-NS



SEAT USED: 648370

FOR PRICE PFISTER
LENGTH: 3.02"

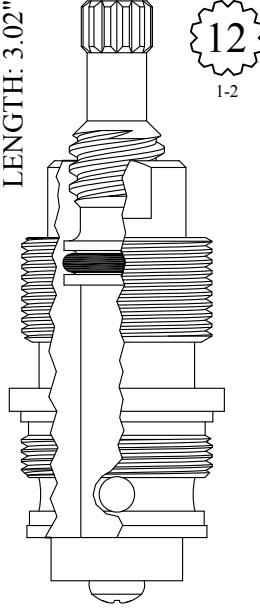

12
1-2

GASKET: 895550

430071



SEAT USED: 648370

FOR MICHIGAN BRASS
LENGTH: 3.03"

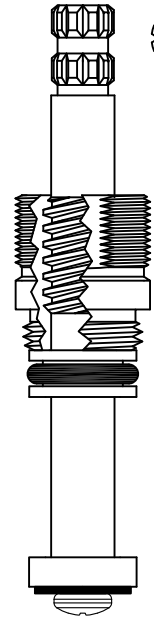

12
3-5

LF466101
LF466102



SEAT USED: LF648210

FOR STERLING FAUCET
LENGTH: 3.03"

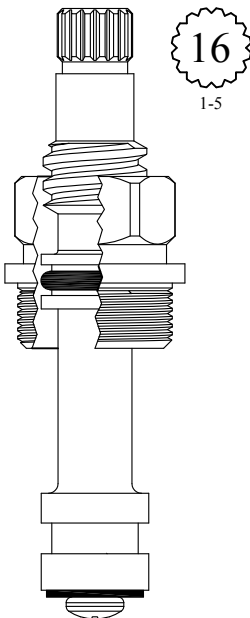

16
1-5

GASKET: 895160

LF466111
LF466112



SEAT USED: LF648170

FOR REID WATSON
LENGTH: 3.04"

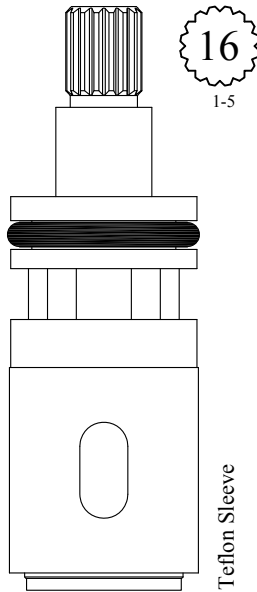

16
1-5

Teflon Sleeve

230470

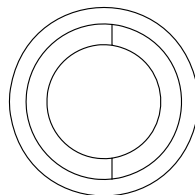

FOR T & S
LENGTH: 3.04"

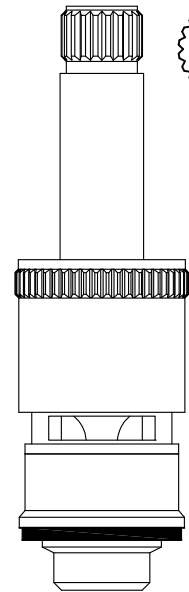

20
2-4

Nickel Plated Stem

SEAL: 898510
DISC SET: 151380-PKG

LF466401
LF466402

FOR PRICE PFISTER
LENGTH: 3.04"

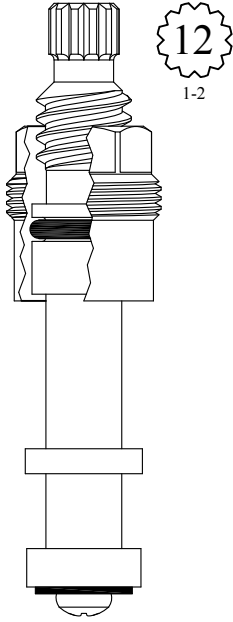

GASKET: 895060

LF467051
LF467052



SEAT USED: LF648270

FOR POWERS
LENGTH: 3.05"

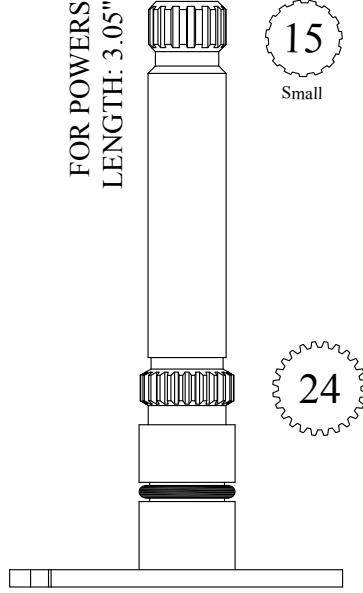

Chrome Plated Stem

201870

FOR KOHLER
LENGTH: 3.05"

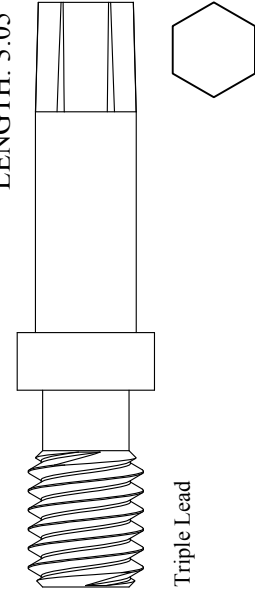

Triple Lead

202171

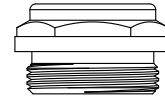

SEAT USED: 647220

FOR ARMONIA
LENGTH: 3.23"

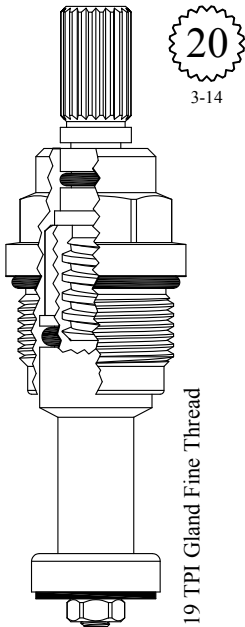

GASKET: 890180 O-RING INCLUDED

401822

FOR PRICE PFISTER
LENGTH: 3.05"

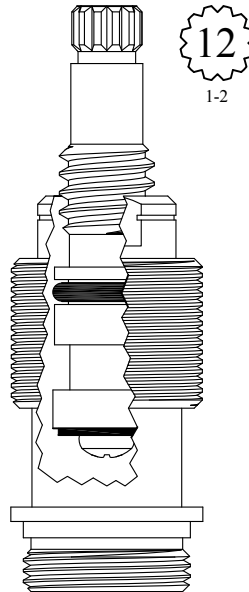

GASKET: 895400

402311

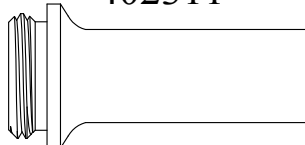

SEAT USED: 648290

FOR BARNES
LENGTH: 3.05"

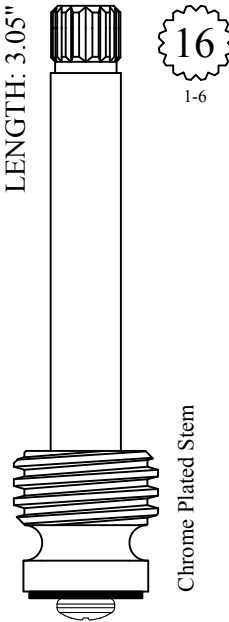

LF266121
LF266122

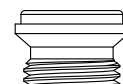

SEAT USED: LF648350

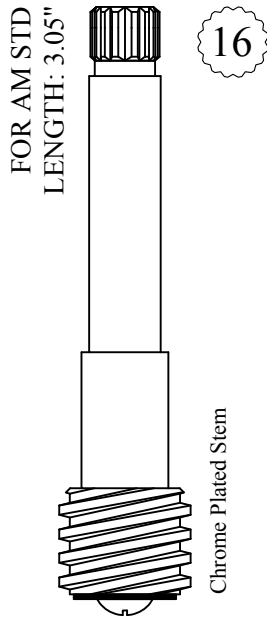

LF267021
LF267022

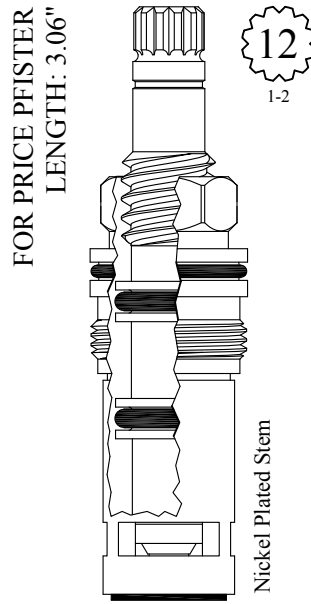

LF467301
LF467302

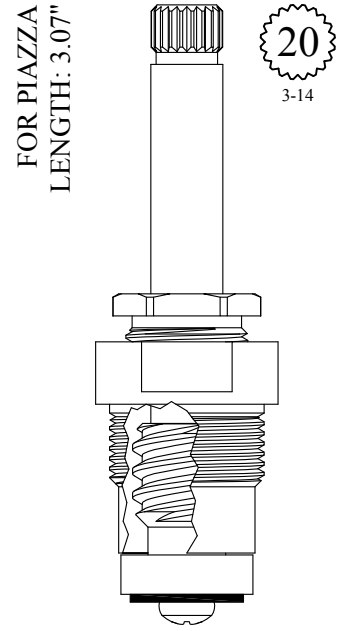

GASKET: 895150

401811

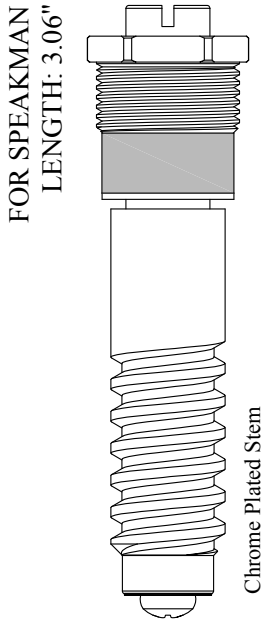

401901
201901 Stem Only

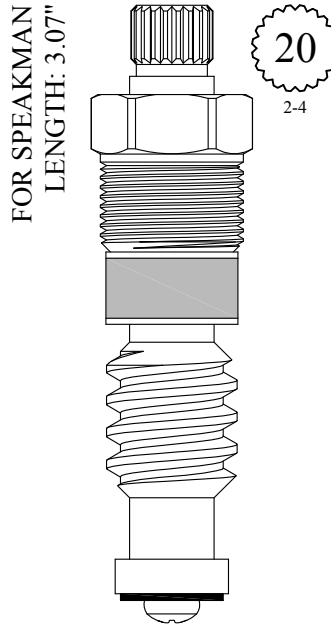

402201
202201 Stem Only

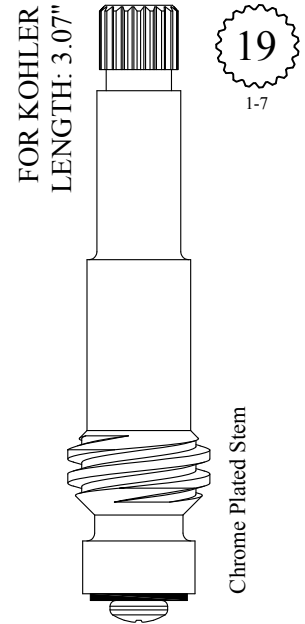

LF265651
LF265652



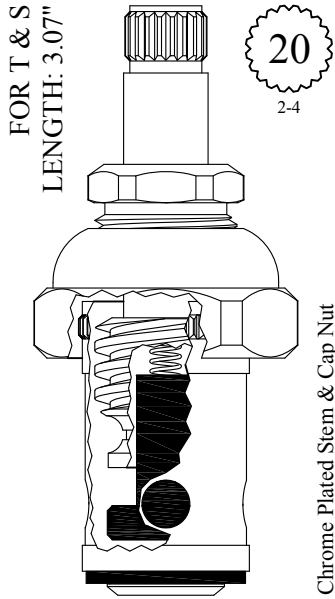

LF464181
LF464182
LF264181 Stem W/ Spring
LF264182 & Retainer
LF118481 Stem Only
LF118482

USES BARREL:
LF664061/LF664062

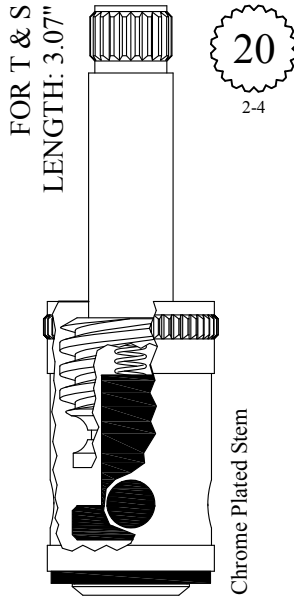

LF464181-LB
LF464182-LB
LF264181 Stem W/ Spring
LF264182 & Retainer

USES BARREL:
LF664061/LF664062

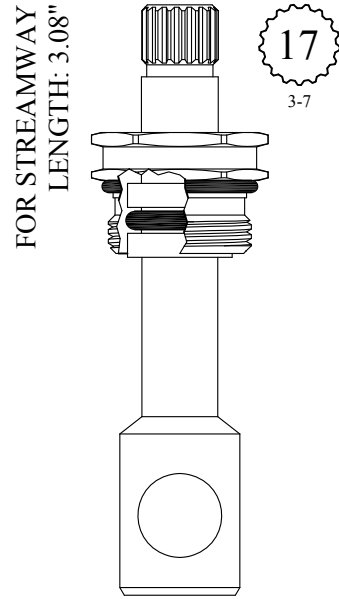

GASKET: 890170 O-RING INCLUDED

430050
230050 Stem Only

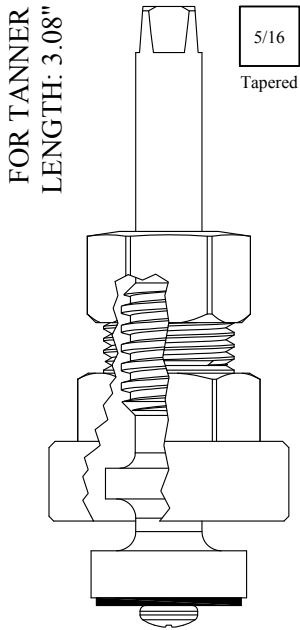

GASKET: 894860 INCLUDED

466371

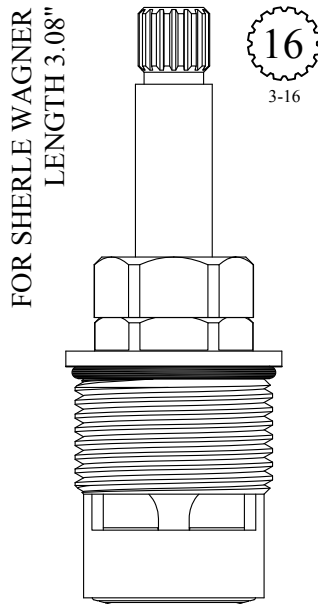

GASKET: 890210 O-RING INCLUDED
SEAL: 898520
DISC SET: 109850-PKG

401881
401882

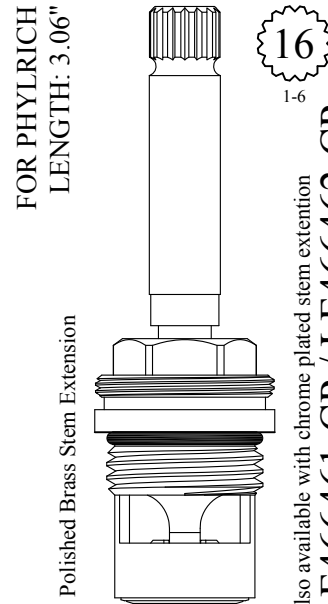

GASKET: 890170 O-RING INCLUDED
SEAL: 898510-W
DISC SET: 151380-PKG

LF466461
LF466462

Individual items available
Stem Ext. 1-1/2": #121860-PB
& 121860-CP
Ext. Adap. Screw: #103310

Also available with chrome plated stem extension
LF466461-CP / LF466462-CP

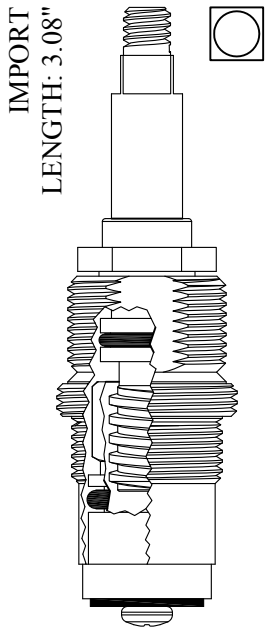

IMPORT
LENGTH: 3.08"

GASKET: 895160

LF466532

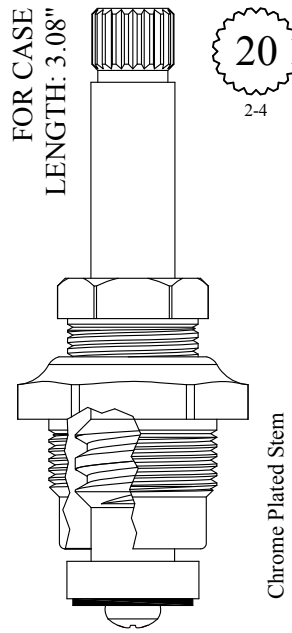

FOR CASE
LENGTH: 3.08"

2-4

GASKET: 895290

LF467401
LF467402
LF267401 Stem Only
LF267402 Stem Only

Chrome Plated Stem

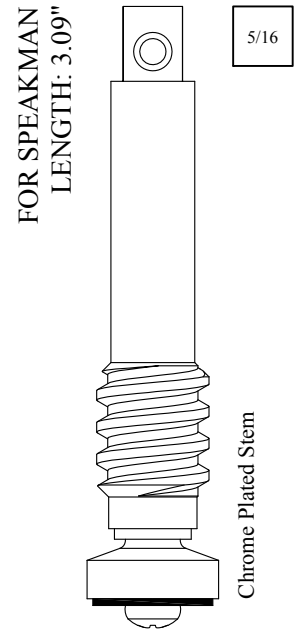

FOR SPEAKMAN
LENGTH: 3.09"

5/16

Chrome Plated Stem

LF267521

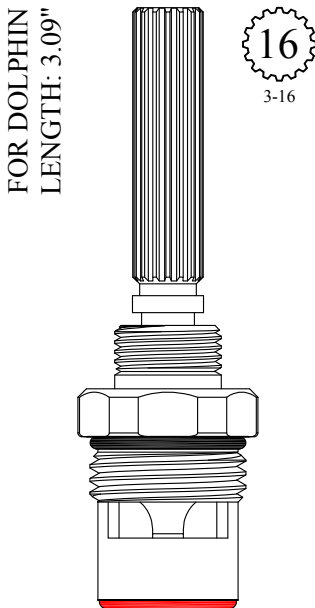

FOR DOLPHIN
LENGTH: 3.09"

3-16

GASKET: 890170 O-RING INCLUDED
SEAL: 898570-R/B
DISC SET: 151380-PKG

LF466421
LF466422

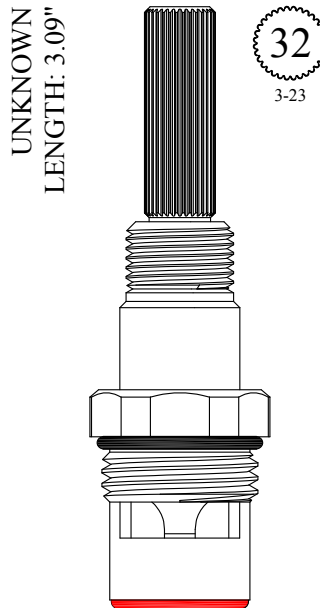

UNKNOWN
LENGTH: 3.09"

3-23

GASKET: 890170 O-RING INCLUDED
SEAL: 898570-R/B
DISC SET: 151380-PKG

LF466441
LF466442

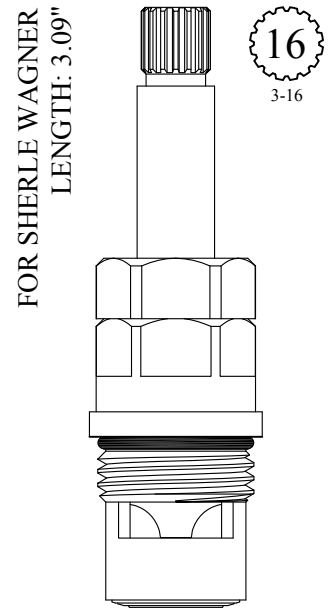

FOR SHERLE WAGNER
LENGTH: 3.09"

3-16

GASKET: 890170 O-RING INCLUDED
SEAL: 898510-W
DISC SET: 151380-PKG

LF466521
LF466522

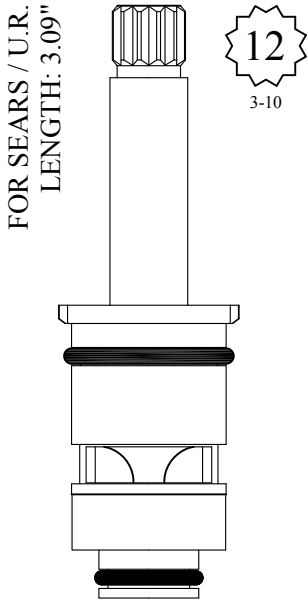

DISC SET: 151380-PKG

LF467031
LF467032

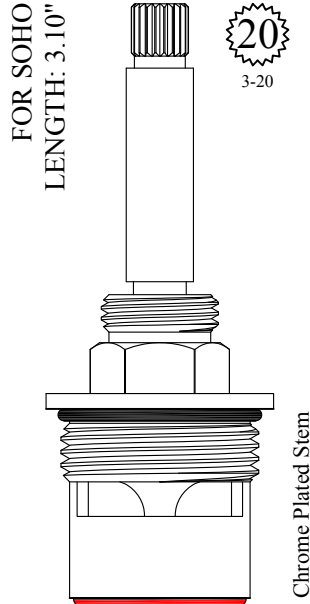

GASKET: 890170 O-RING INCLUDED
SEAL: 898610-R/B
DISC SET: 109850-PKG

402351
402352

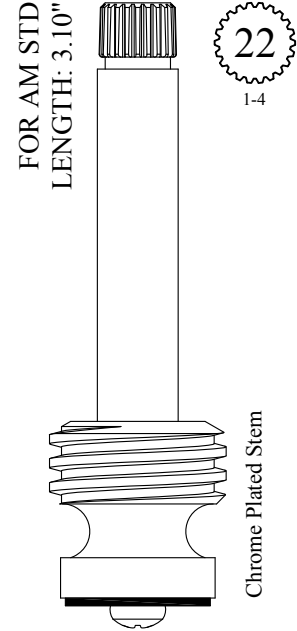

LF266381
LF266382

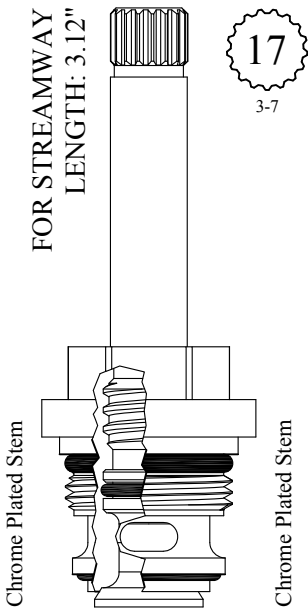

GASKET: 891150 O-RING INCLUDED

401832

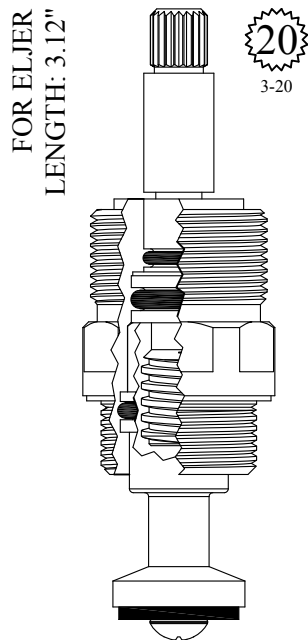

GASKET: 895160 INCLUDED

402012

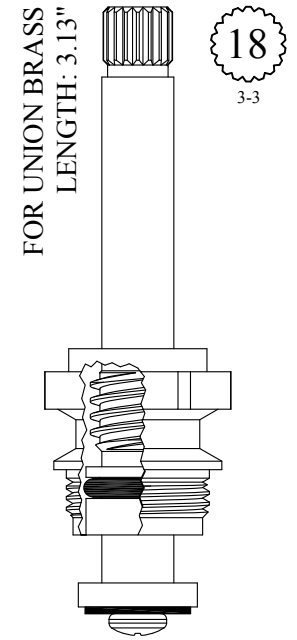

GASKET: 895100

402001
402002

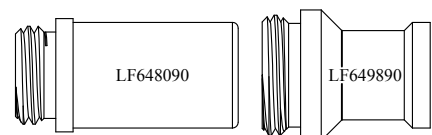

SEATS USED: LF648090 or LF649890

Also available less bonnet
LF466490

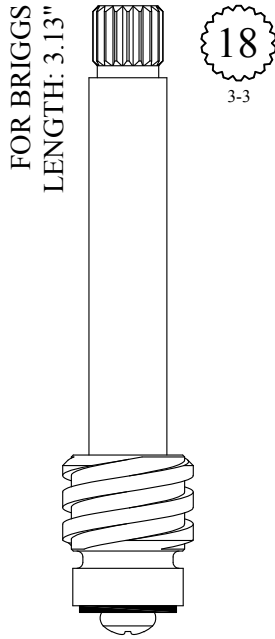

LF267061
LF267062

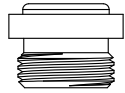

SEAT USED: LF648120

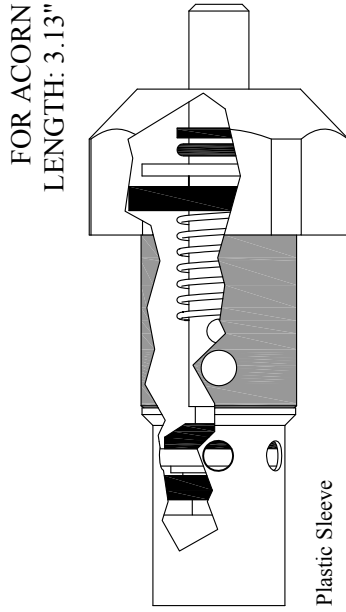

LF466500

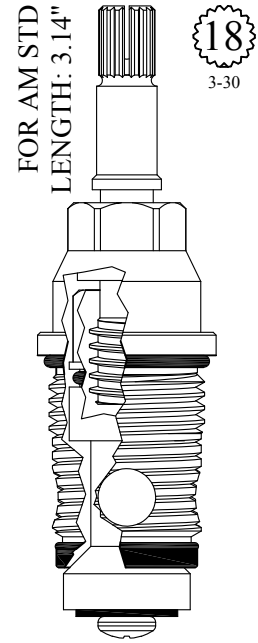

GASKET: 890170 O-RING INCLUDED

430022

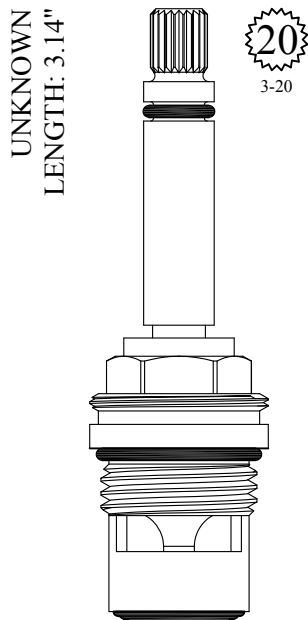

GASKET: 890170 O-RING INCLUDED
 SEAL: 898510
 DISC SET: 151380-PKG

LF466921
LF466922

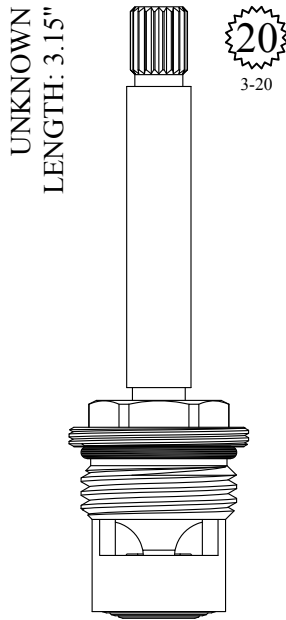

GASKET: 890170 O-RING INCLUDED
 SEAL: 898500
 DISC SET: 151380-PKG

LF467381
LF467382

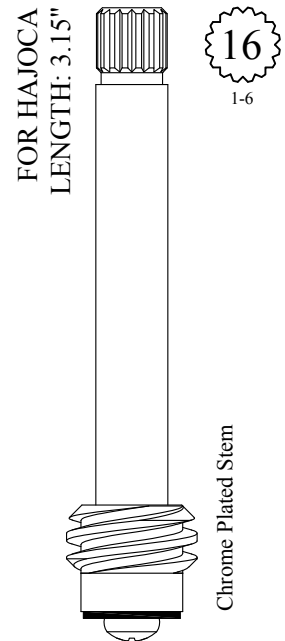

LF266511

FOR PRICE PFISTER
LENGTH: 3.15"

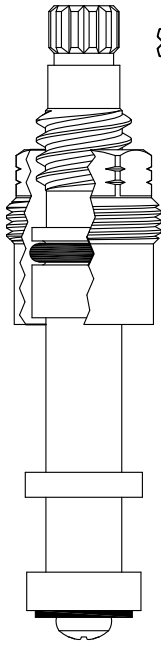

12
1-2

GASKET: 895060

LF467251

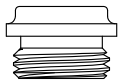

SEAT USED: LF648270

FOR TANNER
LENGTH: 3.16"

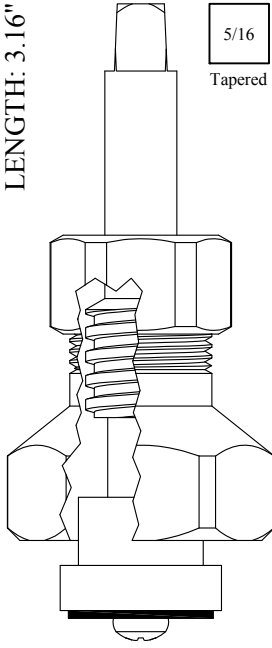

5/16
Tapered

GASKET: 895540

466601

FOR CENTRAL
LENGTH: 3.17"

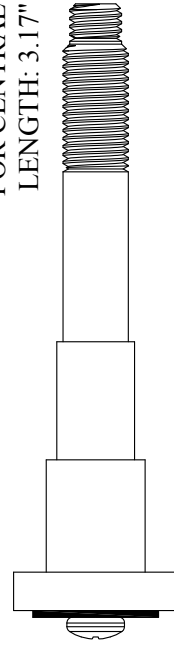

LF267150



SEAT USED: LF648790

FOR T & S
LENGTH: 3.17"

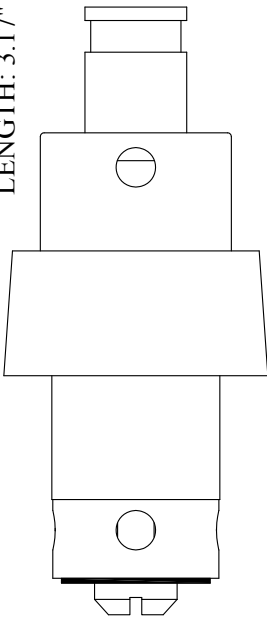

Chrome Plated Unit w/ Button

LF467210

FOR T & S
LENGTH: 3.18"

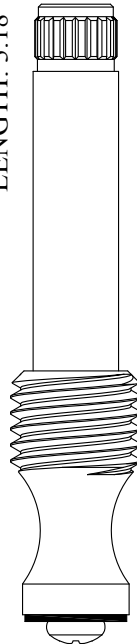

20
2-4

Chrome Plated Stem

LF268401

FOR REID WATSON
LENGTH: 3.19"

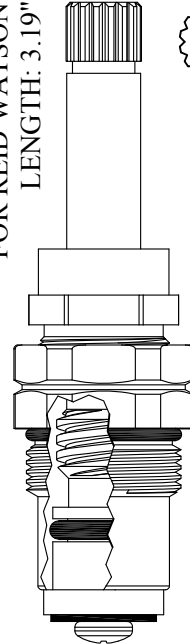

16
1-5

GASKET: 890170 O-RING INCLUDED

LF466701
LF466702

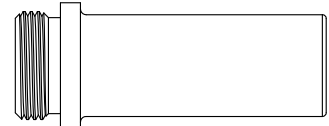

SEAT USED: LF649410

FOR JAMECO
LENGTH: 3.20"

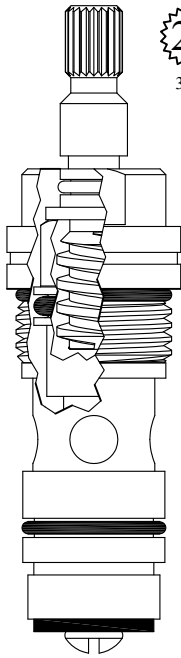

GASKET: 890170 O-RING INCLUDED

430392

FOR PRICE PFISTER
LENGTH: 3.22"

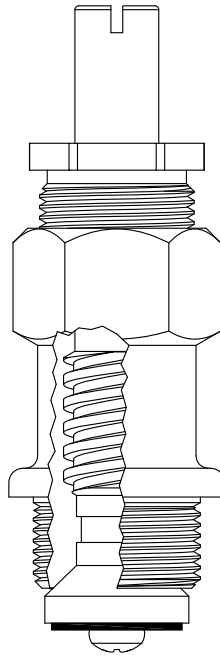

GASKET: 895400

402621

202621 Stem Only

FOR PRICE PFISTER
LENGTH: 3.22"

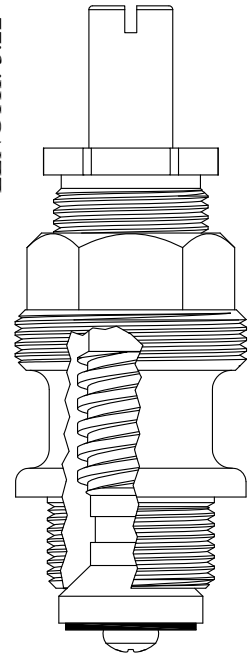

GASKET: 895400

402671

202621 Stem Only

FOR SPEAKMAN
LENGTH: 3.22"

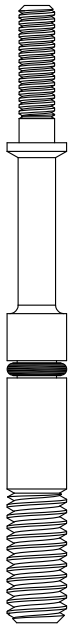

LF267140

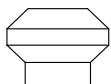

SEAT USED: 649110

FOR SPEAKMAN
LENGTH: 3.23"

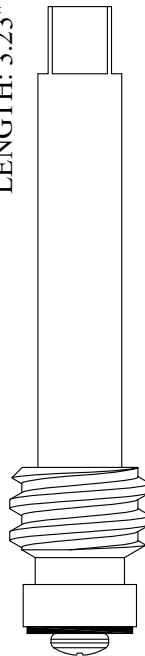

Chrome Plated Stem

LF267201

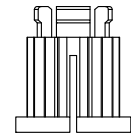

Comes with 20pt Grohe
adapter: 103200

FOR DORNBRACHT
LENGTH: 3.24"

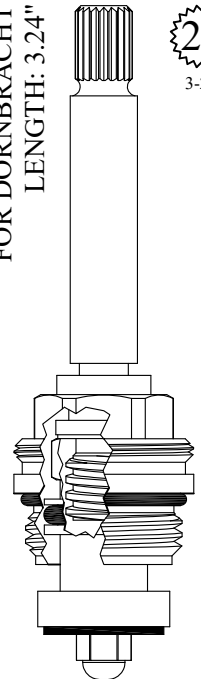

GASKET: 890170 O-RING INCLUDED

402242



SEAT USED: LF647110

FOR ACORN
LENGTH: 3.24"

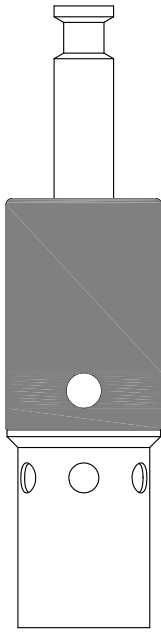

Plastic Sleeve

468490

FOR ILLINOIS
LENGTH: 3.24"

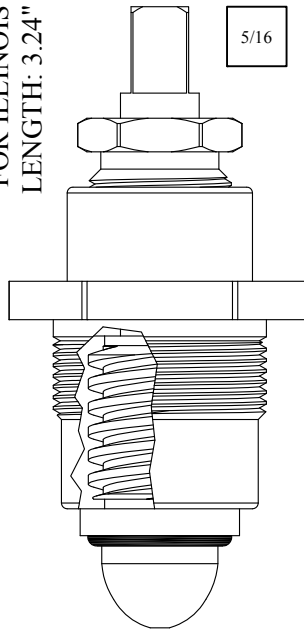

483421

UNKNOWN
LENGTH: 3.25"

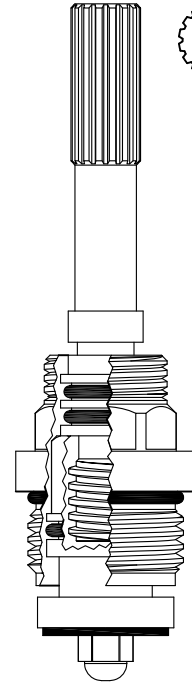

GASKET: 890170 O-RING INCLUDED

402472

FOR BRIGGS
LENGTH: 3.25"

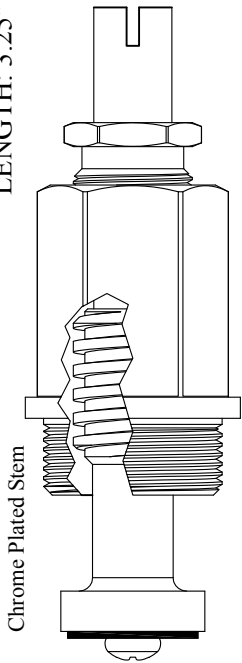

Chrome Plated Stem

GASKET: 895370

402611

202611 Stem Only

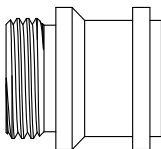

SEAT USED: 648630

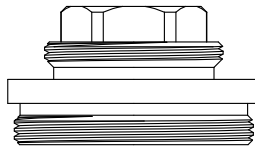

FOR I. W. INDUSTRIES
LENGTH: 3.26"

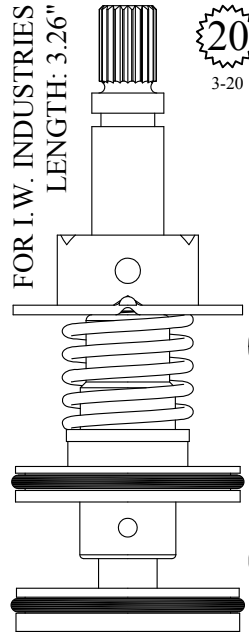

5-Port

4-Port

430560 4-Port

230560 Stem Only

430570 5-Port

230570 Stem Only

FOR AM STD
LENGTH: 3.26"

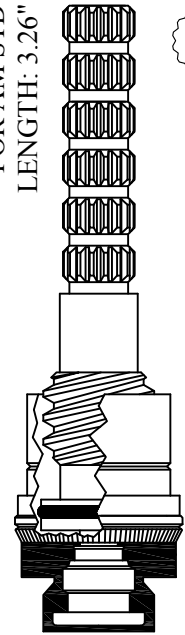

402321

402322

202321 Stem Only

202322 Stem Only

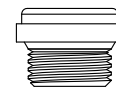

SEAT USED: LF648990

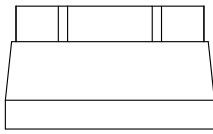

Cap Nut
702510
available

FOR UNION BRASS
LENGTH: 3.26"

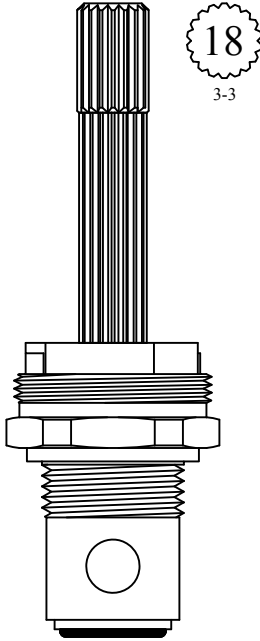

18
3-3

GASKET: 895100
SEAL: 898510
DISC SET: 151380-PKG

402511
402512

FOR ELIZABETHAN CLASSIC
LENGTH: 3.27"

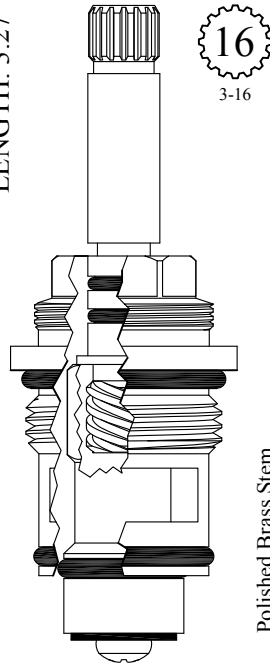

16
3-16

Polished Brass Stem

GASKET: 890180 O-RING INCLUDED

431552

FOR HARDEN
LENGTH: 3.27"

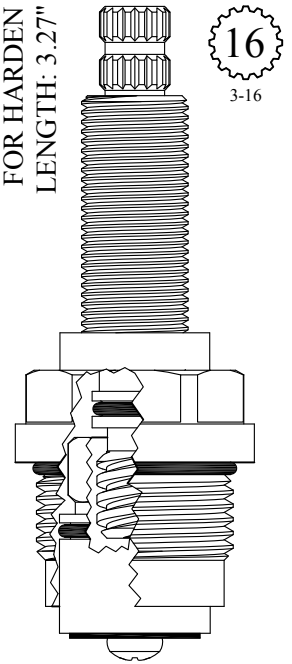

16
3-16

GASKET: 890210 O-RING INCLUDED

402421
402422

FOR BRIGGS
LENGTH: 3.27"

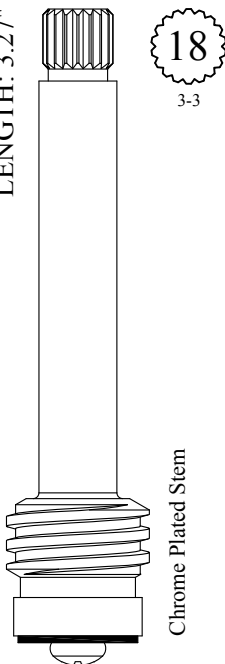

18
3-3

Chrome Plated Stem

LF267121

FOR SPEAKMAN
LENGTH: 3.27"

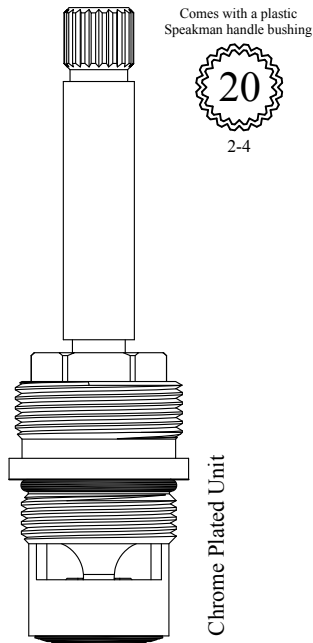

Comes with a plastic
Speakman handle bushing
20
2-4

Chrome Plated Unit

GASKET: 890170 O-RING INCLUDED
SEAL: 898510
DISC SET: 151380-PKG

LF466901
LF466902

FOR SPEAKMAN
LENGTH: 3.27"

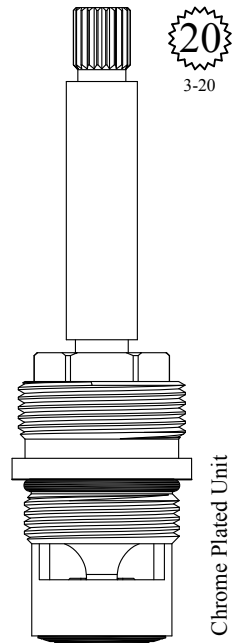

20
3-20

Chrome Plated Unit

GASKET: 890170 O-RING INCLUDED
SEAL: 898510
DISC SET: 151380-PKG

LF466911
LF466912

FOR BURLINGTON
LENGTH: 3.27"

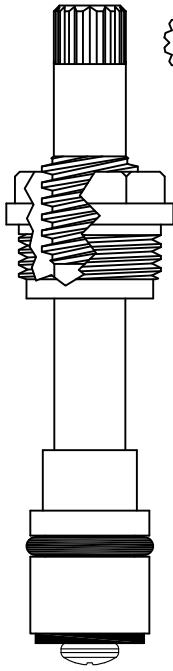

16
1-6

GASKET: 895100

LF467071
LF467072



SEAT USED: LF648700

FOR AM STD
CERAMIC CONVERSION FOR
COLONY S/V UNIT (SHORT)
LENGTH: 3.28"

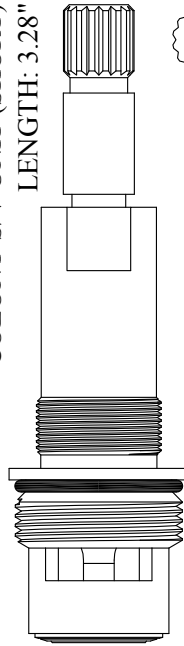

16

GASKET: 890180 O-RING INCLUDED
SEAL: 898510
DISC SET: 151380-PKG

402441

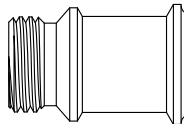

SEAT USED: 646960

FOR STERLING FAUCET
LENGTH: 3.29"

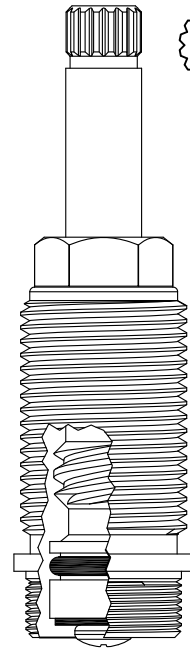

16
1-5

GASKET: 895150

402411

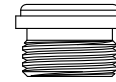

SEAT USED: LF648170

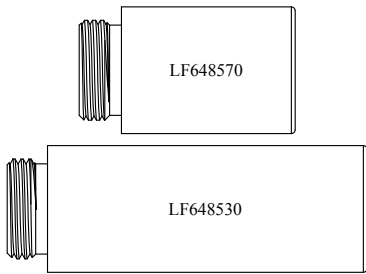

SEAT USED: LF648530 or LF648570

FOR SEARS
LENGTH: 3.29"

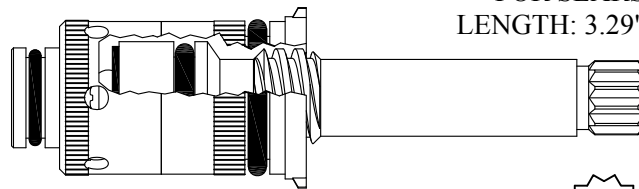

LF467041/ LF467042

12
3-10

IMPORT
LENGTH: 3.31"

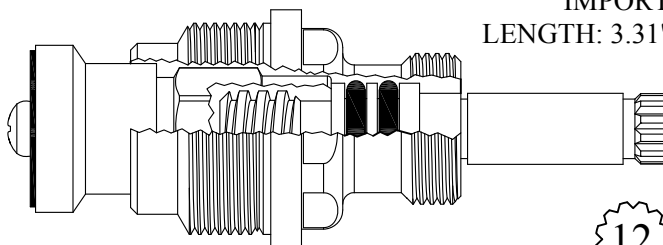

402522
GASKET: 895450

12
1-2

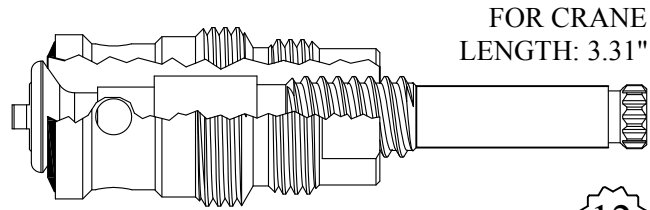

FOR CRANE
LENGTH: 3.31"

12

1-1

402431/ 402432

GASKET: 895250



FOR SPEAKMAN
LENGTH: 3.31"

Chrome Plated Stem

20

2-4

LF267661

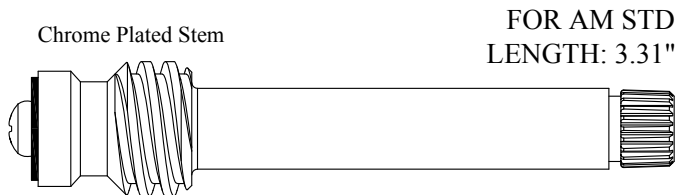

FOR AM STD
LENGTH: 3.31"

Chrome Plated Stem

22

1-4

LF268041/ LF268042

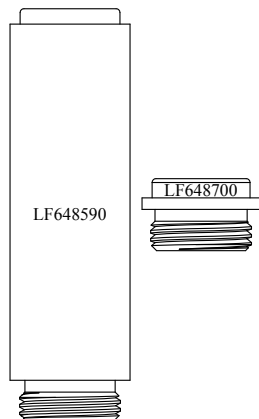

SEAT USED: LF648700 or LF648590

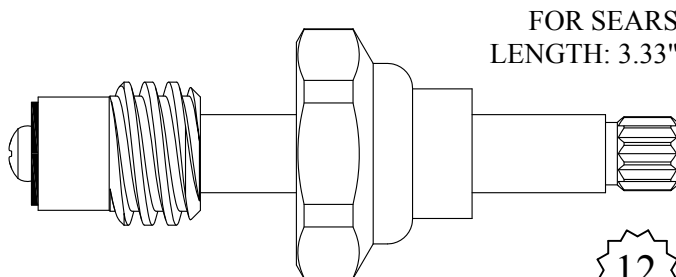

FOR SEARS
LENGTH: 3.33"

12

3-10

402701/ 402702
202701/ 202702 Stem Only



Chrome Plated Stem

FOR SEARS
LENGTH: 3.33"

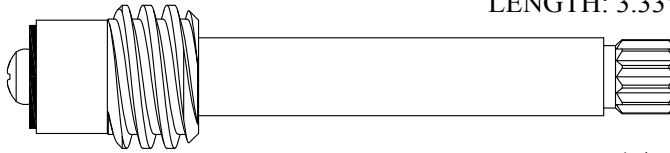

LF268011/ LF268012



Chrome Plated Unit

FOR KOHLER
LENGTH: 3.33"

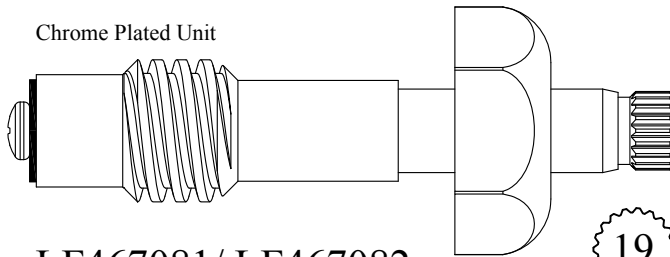

LF467081/ LF467082
LF267081/ LF267082

Stem Only



FOR SHERLE WAGNER
LENGTH: 3.33"

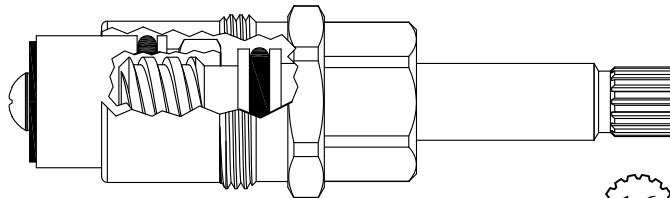

LF467501/ LF467502

GASKET: 895100



Polished Brass Stem

FOR PHYLRICH
LENGTH: 3.33"

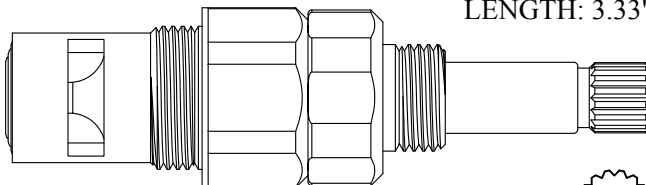

LF468101/ LF468102

GASKET: 895270 INCLUDED
SEAL: 898500
DISC SET: 112530-PKG



Also available with chrome plated stem
LF468101-CP/ LF468102-CP

Plastic Retainer
Chrome Plated Stem

FOR BRADLEY
LENGTH: 3.34"

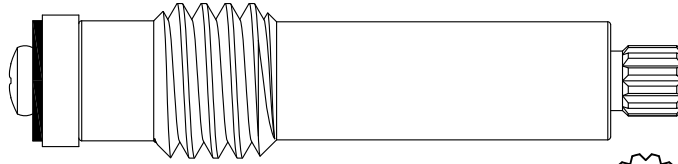

201771

12
1-2

IMPORT
LENGTH: 3.34"

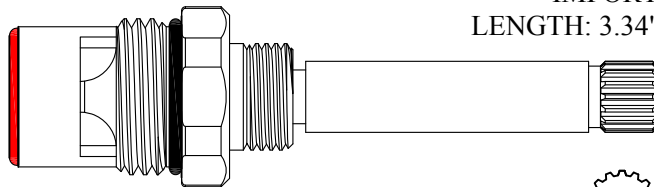

LF402681/ LF402682

GASKET: 890170 O-RING INCLUDED
SEAL: 898570-R/B
DISC SET: 151380-PKG

16
3-16

Chrome Plated Stem

UNKNOWN
LENGTH: 3.34"

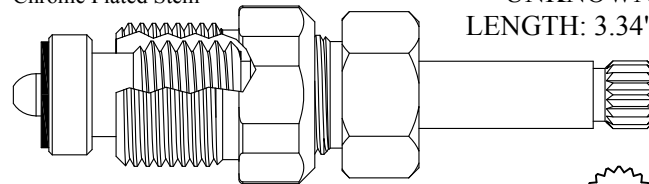

LF466811

GASKET: 895100

18
3-25

FOR AM STD
LENGTH: 3.34"

Chrome Plated Stem

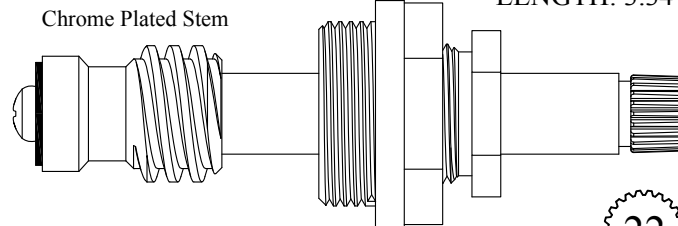

LF468261/ LF468262

LF268061/ LF268062 Stem Only

GASKET: 818010

22
1-4

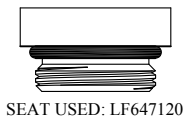

SEAT USED: LF647120

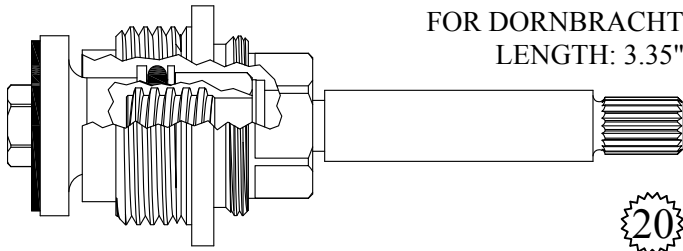

FOR DORNBRACHT
LENGTH: 3.35"

402752



3-20

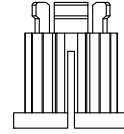

Comes with 20pt Grohe
adapter: 103200

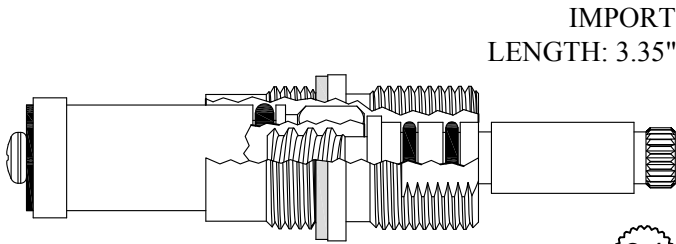

IMPORT
LENGTH: 3.35"

LF466822

GASKET: 895100



3-28

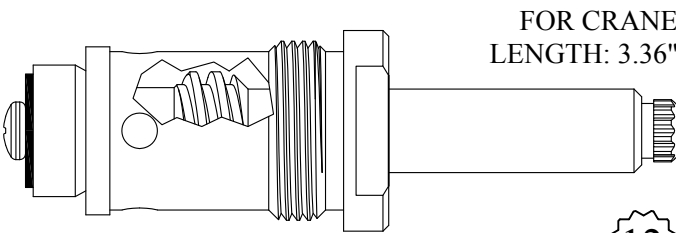

FOR CRANE
LENGTH: 3.36"

430631



1-1



SEAT USED: LF648350

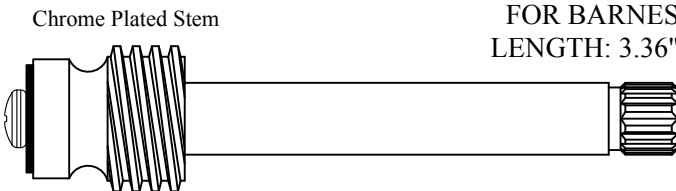

Chrome Plated Stem

FOR BARNES
LENGTH: 3.36"

LF269121/ LF269122



1-6

Nickel Plated Stem

FOR CHICAGO
LENGTH: 3.36"

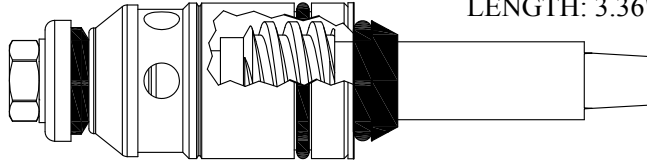

LF467091/ LF467092 QUATURN

GASKET: 895200
SEAT INCLUDED: 648750

Nickel Plated Stem

FOR CHICAGO
LENGTH: 3.36"

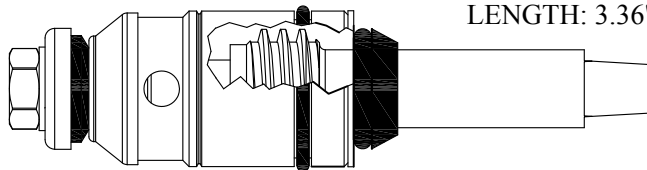

LF467101/ LF467102 SLOW COMPRESSION

GASKET: 895200
SEAT INCLUDED: 648750

Chrome Plated Stem

FOR ELJER
LENGTH: 3.36"

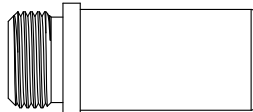

SEAT USED: LF648620

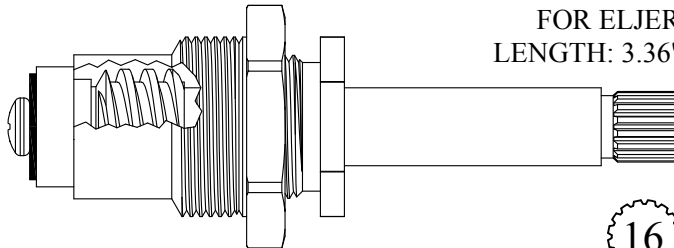

Also available with polished brass stem

LF467111-PB
LF467111-PB
LF267111-PB Stem Only
LF267111-PB Stem Only



LF467111/ LF467112
LF267111/ LF267112 Stem Only

GASKET: 895330

Chrome Plated Stem

FOR SHERLE WAGNER
LENGTH: 3.36"

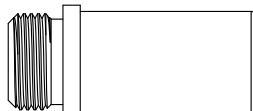

SEAT USED: LF648620

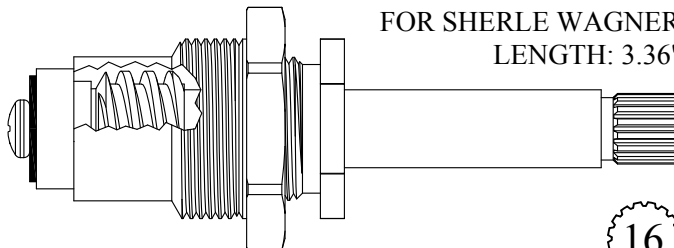

LF467111-PB/ LF467112-PB

GASKET: 895330

Nickel Plated Stem
Chrome Plated Bonnet

FOR CHICAGO
LENGTH: 3.36"

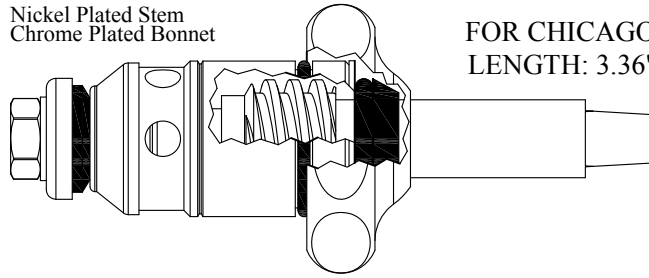

LF467191/ LF467192 QUATURN

GASKET: 895200
SEAT INCLUDED: 648750

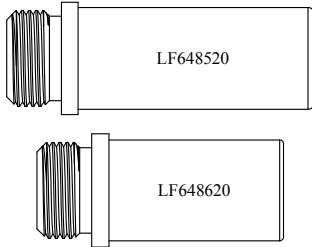

SEAT USED: LF648520 or LF648620

Chrome Plated Stem

FOR ELJER
LENGTH: 3.36"

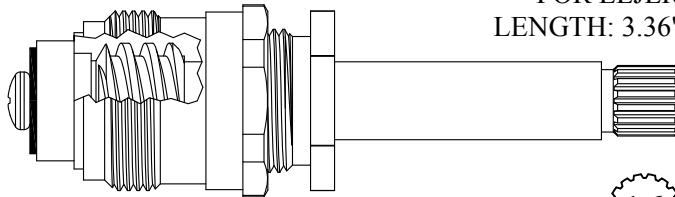

LF467611/ LF467612
LF267111/ LF267112 Stem Only

GASKET: 895120



Also available with polished brass stem

LF467611-PB
LF467611-PB
LF267611-PB Stem Only
LF267611-PB Stem Only

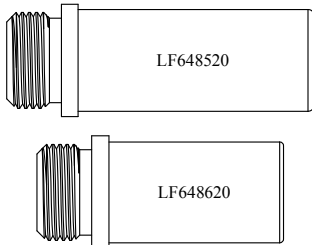

SEAT USED: LF648520 or LF648620

Chrome Plated Stem

FOR SHERLE WAGNER
LENGTH: 3.36"

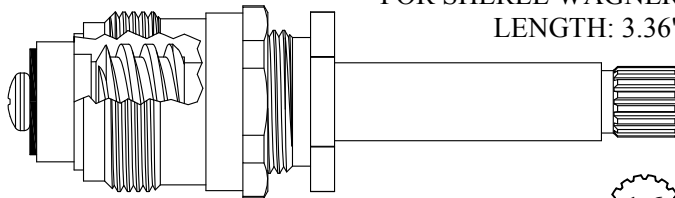

LF467611-PB/ LF467612-PB

GASKET: 895120



FOR POWERS
LENGTH: 3.37"

Chrome Plated Stem



117520



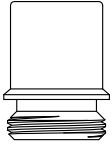

SEAT USED: LF649500

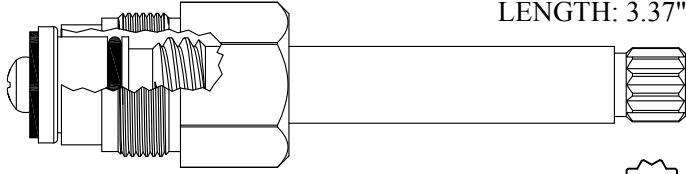

FOR MILWAUKEE
LENGTH: 3.37"

402591

GASKET: 199930

12

1-1

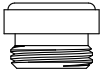

SEAT USED: LF648760

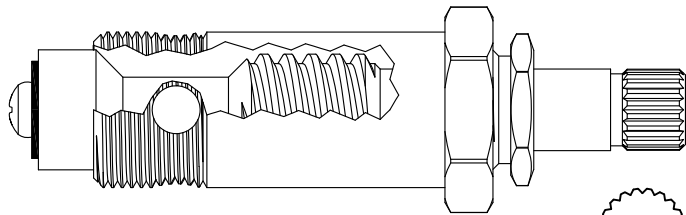

FOR SPEAKMAN
LENGTH: 3.37"

430111

230111 Stem Only

GASKET: 895160

20

2-4

Polished Brass Stem

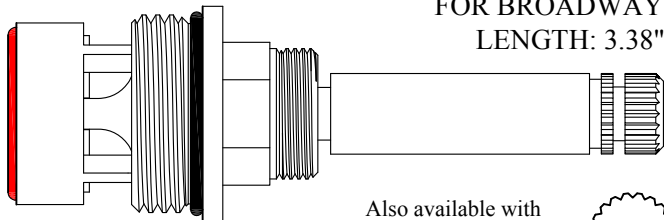

FOR BROADWAY
LENGTH: 3.38"

402651/ 402652

GASKET: 890210 O-RING INCLUDED

SEAL: 898610-R/B

DISC SET: 109850-PKG

Also available with
polished chrome stem

402651-CP

402652-CP

20

2-4

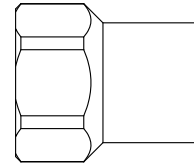

Escutcheon Nut
302740
available

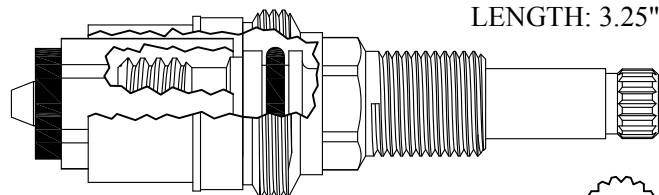

FOR LABONGE
LENGTH: 3.25"

LF466712

16

1-6

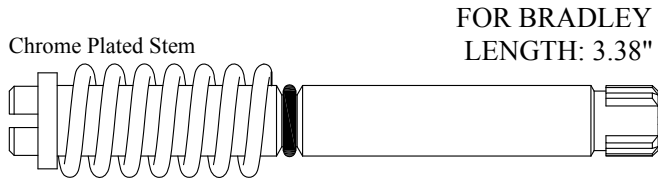

202690

Special 12pt Broach w/
2 splines missing on each
side to make an 8pt Broach

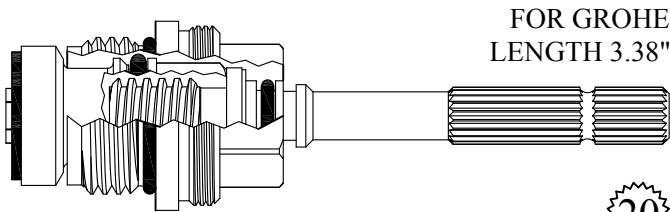

402642

GASKET: 890170 O-RING INCLUDED



3-20

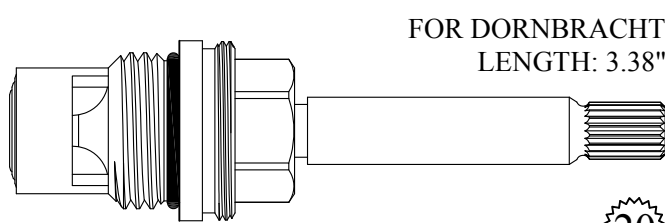

402601/ 402602

GASKET: 890170 O-RING INCLUDED
SEAL: 898500
DISC SET: 112530-PKG



3-20

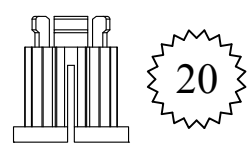

Comes with 20pt Grohe
adapter: 103200

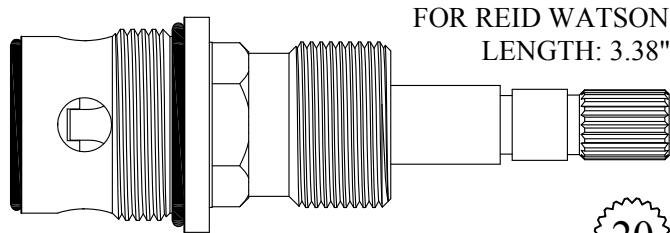

402661/ 402662

GASKET: 890210 O-RING INCLUDED
SEAL: 898530
DISC SET: 109850-PKG



3-14

19TPI Gland Fine Thread

FOR ARMONIA
LENGTH: 3.52"

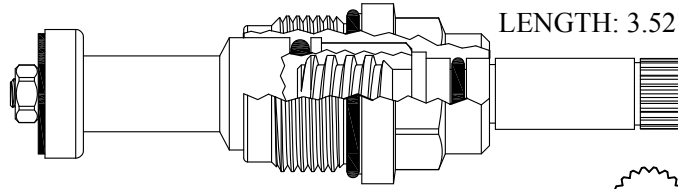

402532

GASKET: 890180 O-RING INCLUDED

20

3-14

14 TPI Gland Coarse Thread

FOR ARMONIA
LENGTH: 3.52"

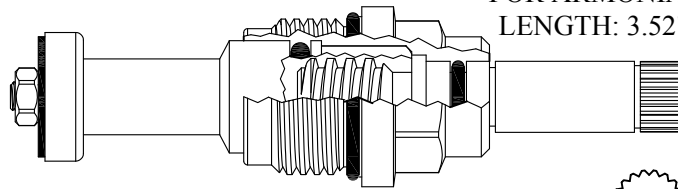

402542

GASKET: 890180 O-RING INCLUDED

20

3-14

FOR AM STD
LENGTH: 3.39"

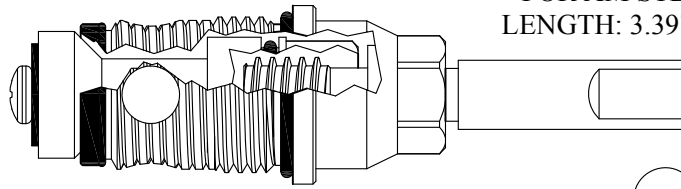

430662



Chrome Plated Stem

FOR CRANE
LENGTH: 3.39"

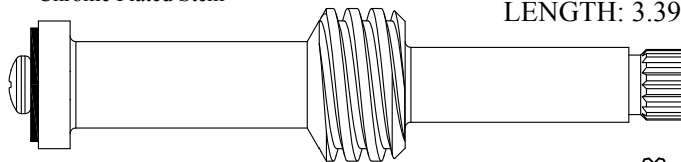

LF268091/ LF268092

16

1-6

Nickel Plated Stem

FOR CHICAGO
LENGTH: 3.39"

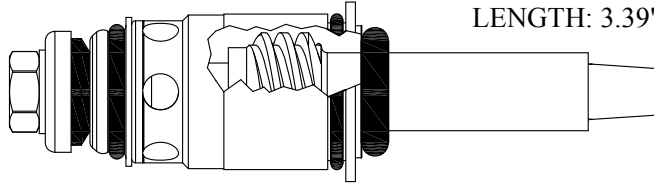

LF467131/ LF467132

NEW STYLE
QUATURN

GASKET: 895200
SEAT INCLUDED: 648750

Nickel Plated Stem

FOR CHICAGO
LENGTH: 3.39"

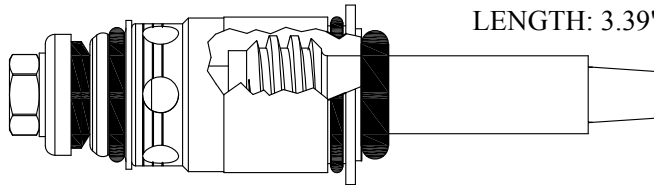

LF467221/ LF467222

NEW STYLE
SLOW COMPRESSION

GASKET: 895200
SEAT INCLUDED: 648750

FOR SPEAKMAN
LENGTH: 3.40"

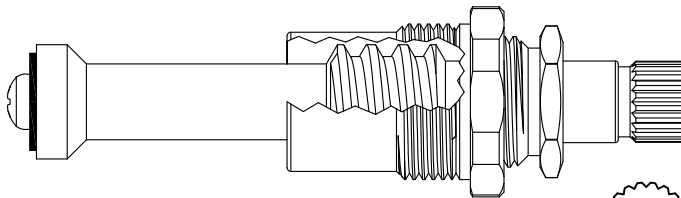

LF468501
LF268501 Stem Only

20
2-4



SEAT USED: LF648760

UNKNOWN
LENGTH: 3.41"

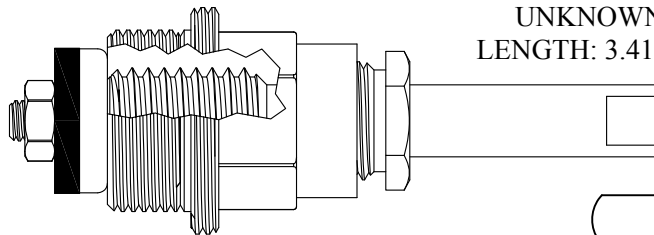

401751
GASKET: 895330



SEAT USED: 648800

Chrome Plated Stem

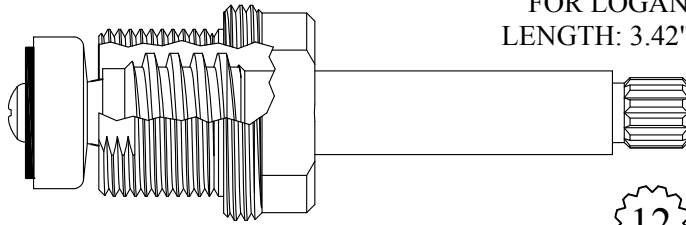

FOR LOGAN
LENGTH: 3.42"

402811
202811 Stem Only
GASKET: 895400



1-2

Chrome Plated Unit

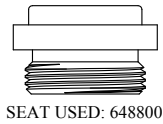

SEAT USED: 648800

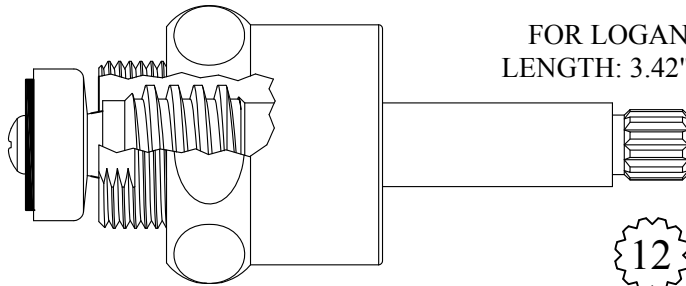

FOR LOGAN
LENGTH: 3.42"

402811-N
202811 Stem Only
GASKET: 895400 INCLUDED



1-2

FOR AM STD
LENGTH: 3.42"

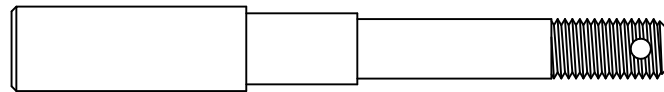

LF268300



SEAT USED: LF648040

20 TPI Gland

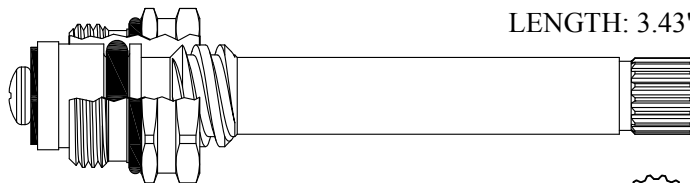

FOR STREAMWAY
LENGTH: 3.43"

402721
GASKET: 895100



3-7

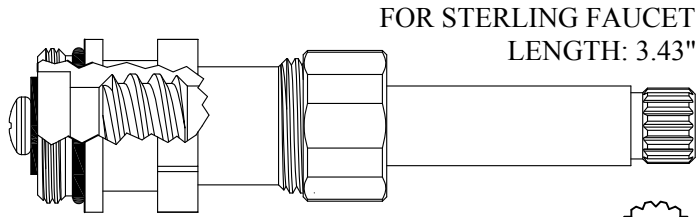

402821
GASKET: 890170 O-RING INCLUDED

16
1-5

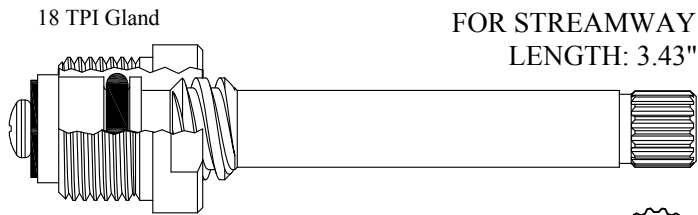
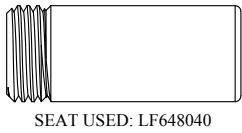

402711/ 402712
GASKET: 895100

17
3-7

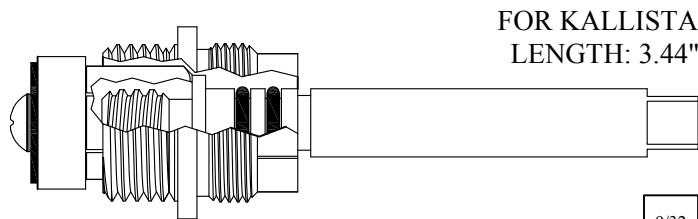

402762
GASKET: 895160

9/32

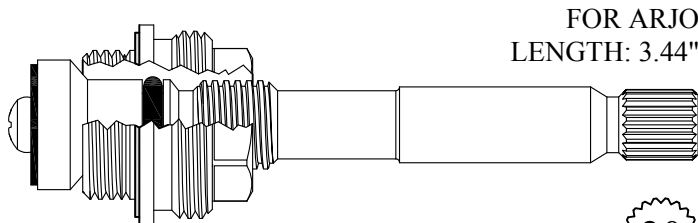

403071

20
3-14

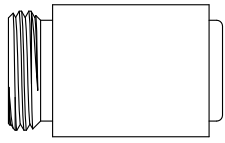

SEAT USED: LF649140

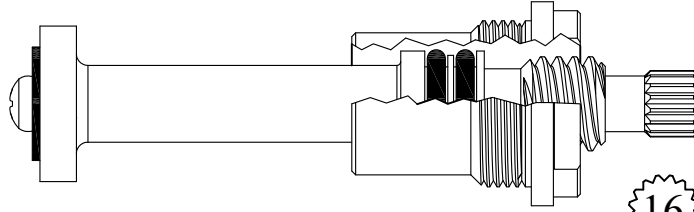

FOR GERBER
LENGTH: 3.44"

402771/ 402772

GASKET: 895180

16
2-3

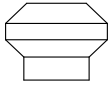

SEAT USED: 649110

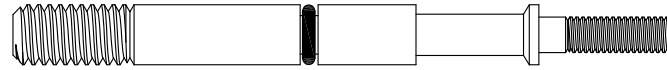

FOR SPEAKMAN
LENGTH: 3.44"

LF267900

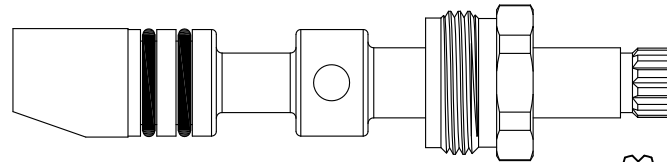

FOR HARCRAFT
LENGTH: 3.45"

430140
230140 Stem Only

12
1-2

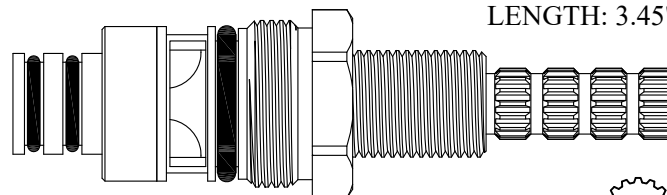

FOR HARDEN
LENGTH: 3.45"

LF468201/ LF468202

GASKET: 891140 O-RING INCLUDED
DISC SET: 151380-PKG

16
3-16

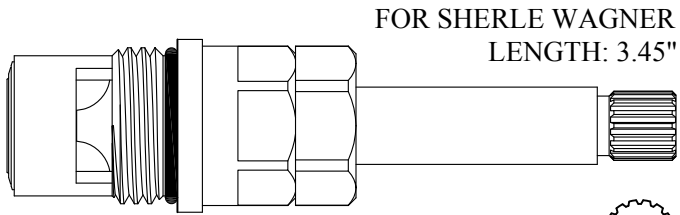

FOR SHERLE WAGNER
LENGTH: 3.45"

16
3-16

LF468521/ LF468522

GASKET: 890170 O-RING INCLUDED
SEAL: 898510-W
DISC SET: 151380-PKG

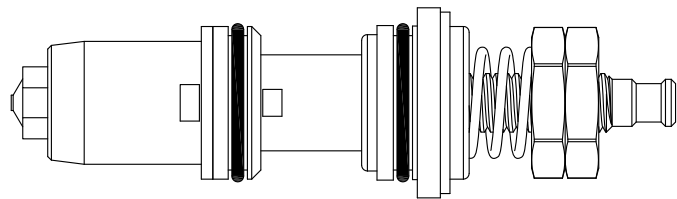

FOR METCRAFT
LENGTH: 3.46"

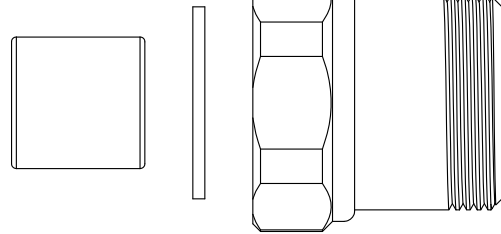

LF114090
LF114020 Cartridge Only

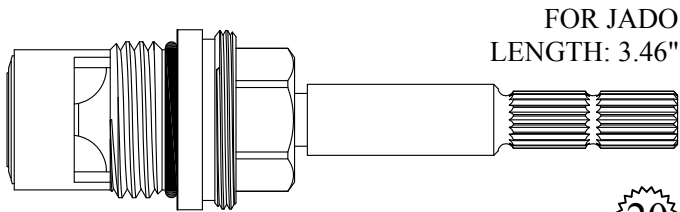

FOR JADO
LENGTH: 3.46"

20
3-20

402841/ 402842

GASKET: 890170 O-RING INCLUDED
SEAL: 898510-W
DISC SET: 151380-PKG

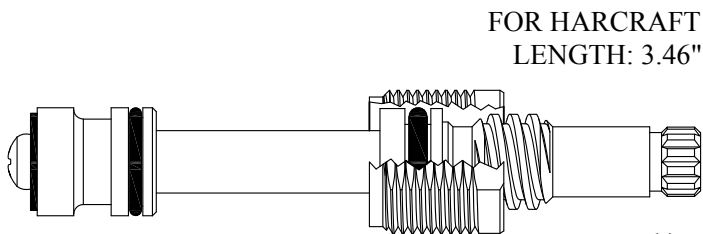

FOR HARCRAFT
LENGTH: 3.46"

12
1-2

LF466131
LF266131 Stem Only

GASKET: 895040 INCLUDED



SEAT USED: LF648670

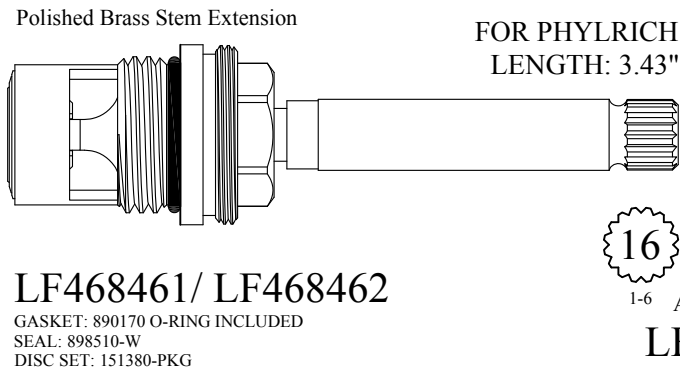
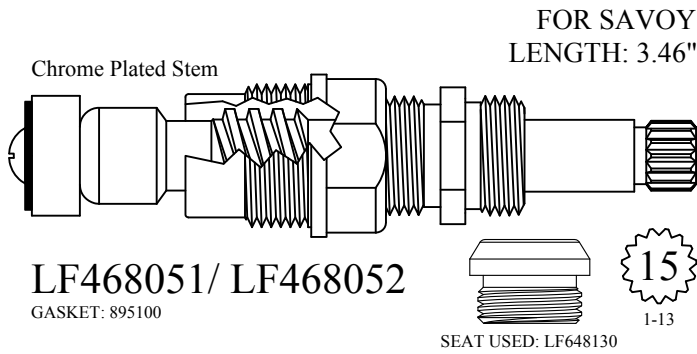

Individual items available
Stem Ext. 1 7/8": #102890-PB
& 102890-CP
Ext. Adap. Screw: #103310

Also available with chrome plated stem extension
LF468461-CP/ LF468462-CP

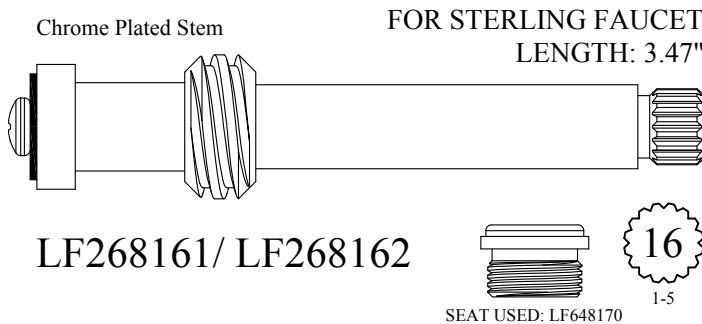
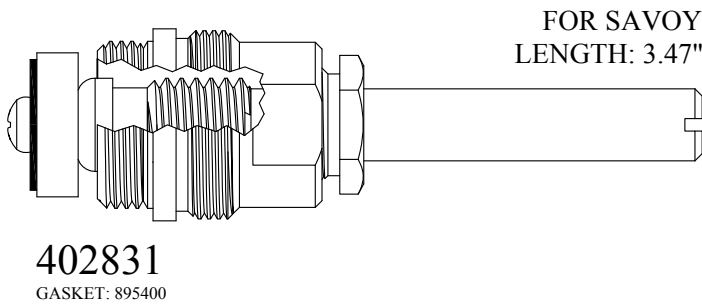

Polished Brass Stem

FOR BROADWAY
LENGTH: 3.47"

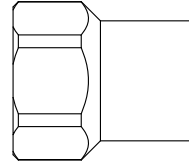
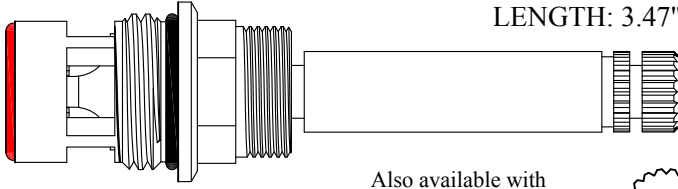

Escutcheon Nut
302740
available

LF402741

LF402742

GASKET: 890170 O-RING INCLUDED
SEAL: 898570-R/B
DISC SET: 151380-PKG

Also available with
polished chrome stem
LF402741-CP
LF402742-CP

20
2-4

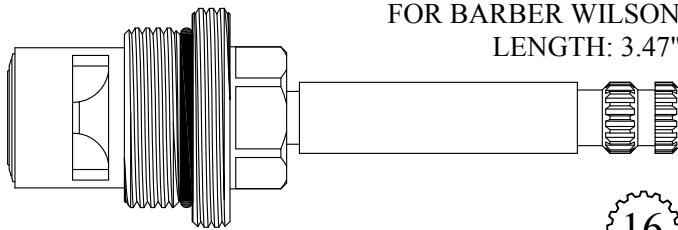

FOR BARBER WILSON
LENGTH: 3.47"

LF468571/ LF468572

GASKET: 890190 O-RING INCLUDED
SEAL: 898510-W
DISC SET: 151380-PKG

16
3-16

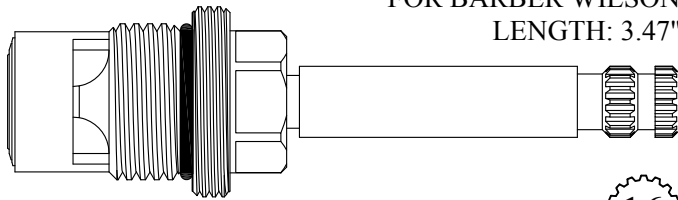

FOR BARBER WILSON
LENGTH: 3.47"

LF468581/ LF468582

GASKET: 890170 O-RING INCLUDED
SEAL: 898510-W
DISC SET: 151380-PKG

16
3-16

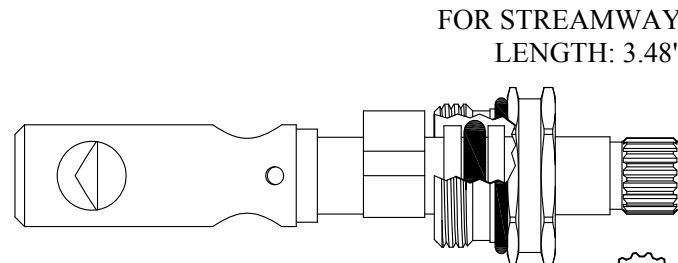

FOR STREAMWAY
LENGTH: 3.48"

430060

230060 Stem Only

GASKET: 890170 O-RING INCLUDED

17
3-7

FOR STREAMWAY
LENGTH: 3.48"

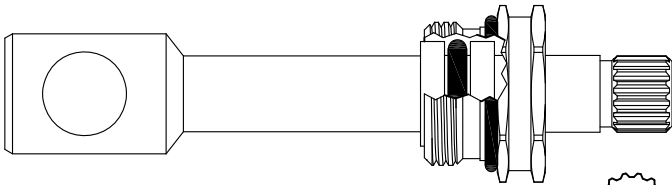

430080
230080 Stem Only
GASKET: 890170 O-RING INCLUDED

17
3-7

FOR FEDERAL HUBER
LENGTH: 3.50"

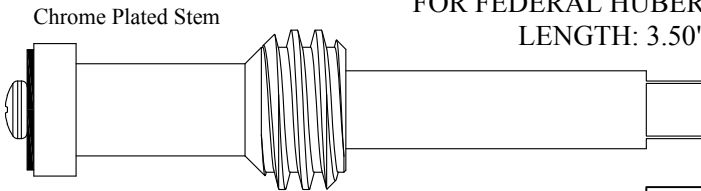

202801

5/16

FOR FEDERAL HUBER
LENGTH: 3.50"

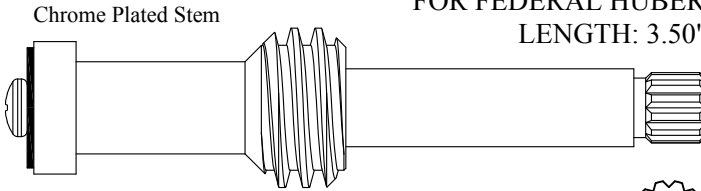

202851

12
1-2

FOR FEDERAL HUBER
LENGTH: 3.50"

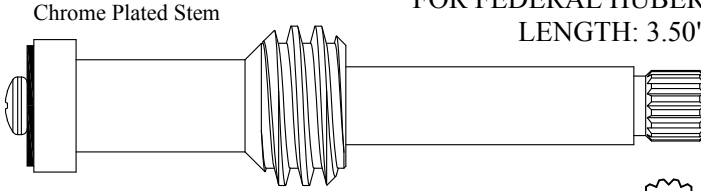

202871

16
1-6

Chrome Plated Stem

FOR CRANE
LENGTH: 3.48"

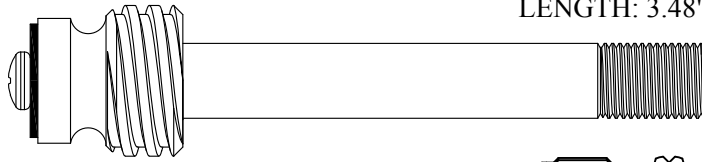

LF267161

Supplied with
12pt. Broach



12

1-2

Chrome Plated Stem

FOR SAVOY
LENGTH: 3.49"

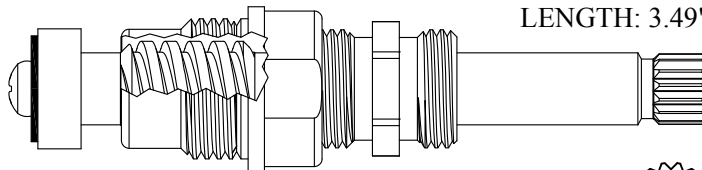

LF468021/ LF468022

GASKET: 895100

15

1-13

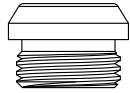

SEAT USED: LF648130

FOR KOHLER
LENGTH: 3.50"

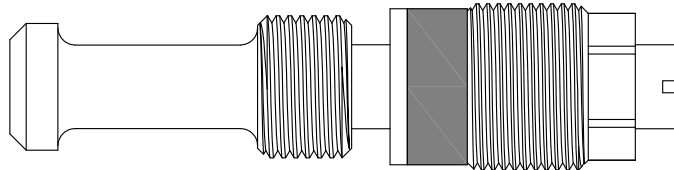

402991

202991 Stem Only

FOR AUBURN BRASS
LENGTH: 3.51"

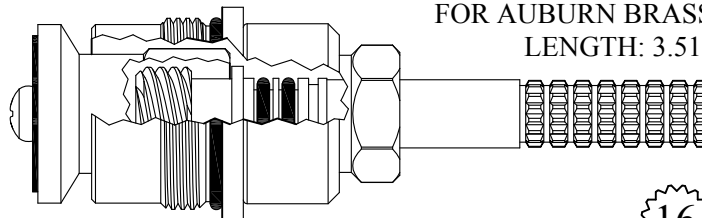

403021/ 403022

GASKET: 890200 O-RING INCLUDED

16

2-3

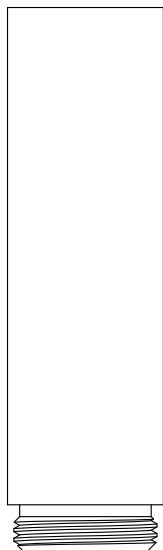

SEAT USED: 647740

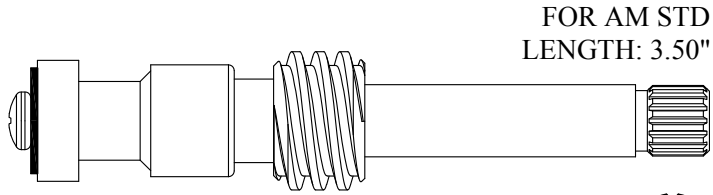

FOR AM STD
LENGTH: 3.50"

LF268121

12
1-2

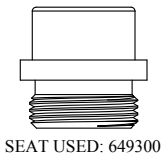

SEAT USED: 649300

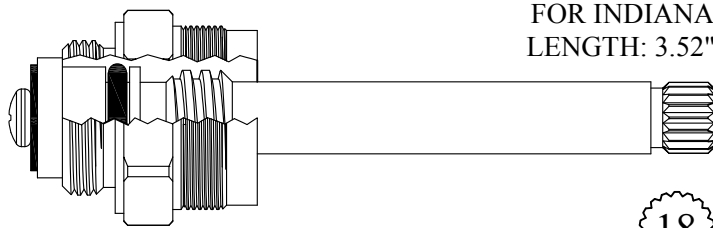

FOR INDIANA
LENGTH: 3.52"

402901/ 402902

GASKET: 895150

18
3-3



SEAT USED: LF648350

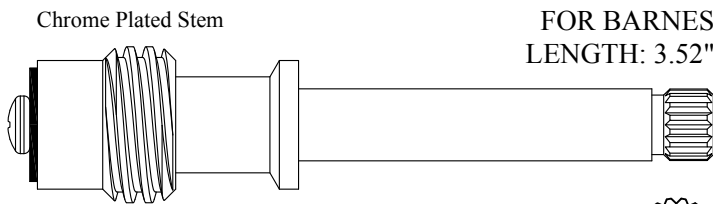

Chrome Plated Stem

FOR BARNES
LENGTH: 3.52"

LF268001/ LF268002

16
1-6

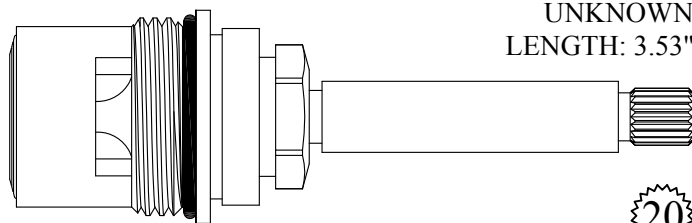

UNKNOWN
LENGTH: 3.53"

402571/ 402572

GASKET: 890210 O-RING INCLUDED
SEAL: 898520
DISC SET: 109850-PKG

20
3-20

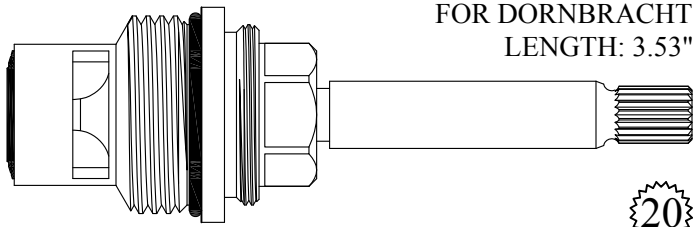

FOR DORNBRACHT
LENGTH: 3.53"

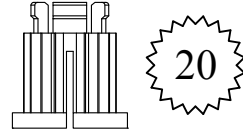

20

Comes with 20pt Grohe
adapter: 103200

20
3-20

402861/ 402862

GASKET: 890210 O-RING INCLUDED
SEAL: 898510
DISC SET: 151380-PKG

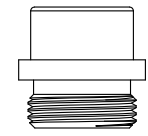

SEAT USED: 649300

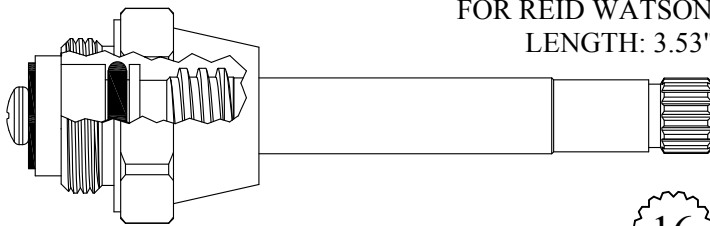

FOR REID WATSON
LENGTH: 3.53"

16
1-5

402921/ 402922

GASKET: 895150

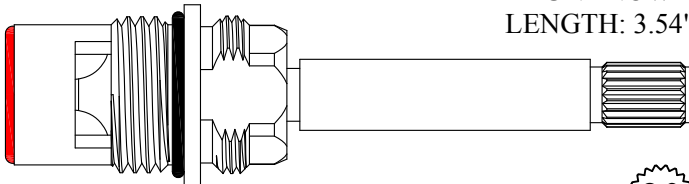

UNKNOWN
LENGTH: 3.54"

20
11/32
(Not European)
3-34

LF468221/ LF468222

GASKET: 890170 O-RING INCLUDED
SEAL: 898570-R/B
DISC SET: 151380-PKG

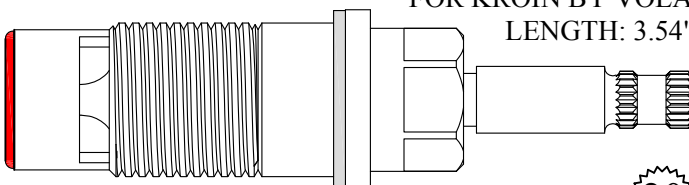

FOR KROIN BY VOLA
LENGTH: 3.54"

20
3-20

LF468251/ LF468252

GASKET: 895150 INCLUDED
SEAL: 898570-R/B
DISC SET: 151380-PKG

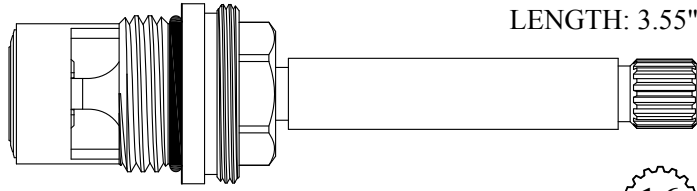

FOR PAUL
LENGTH: 3.55"

16
3-16

402931/ 402932

GASKET: 890170 O-RING INCLUDED
SEAL: 898510-W
DISC SET: 151380-PKG

Chrome Plated Cap Nut

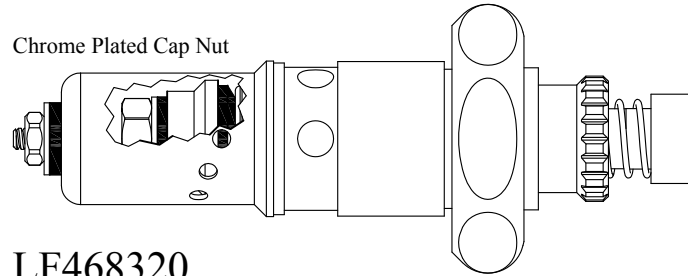

FOR CHICAGO
LENGTH: 3.55"

LF468320

Chrome Plated Stem

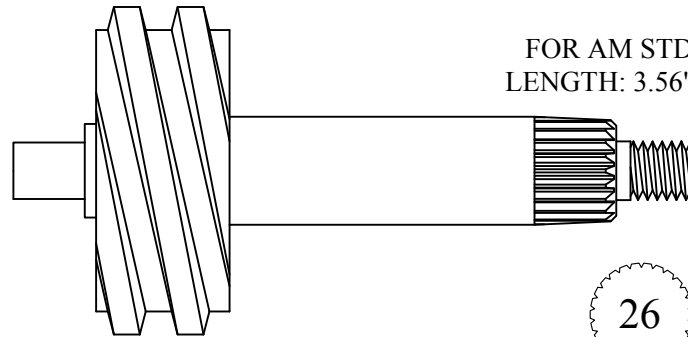

FOR AM STD
LENGTH: 3.56"

26

203131

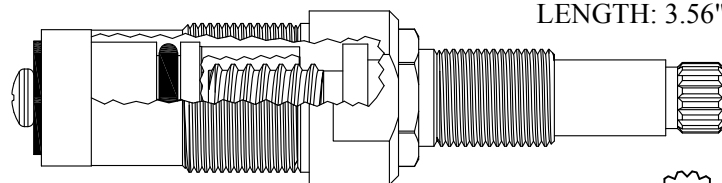

UNKNOWN
LENGTH: 3.56"

16
1-6

402782

GASKET: 895140



SEAT USED: LF649040

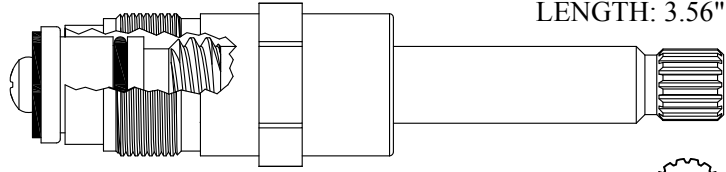

FOR MILWAUKEE
LENGTH: 3.56"

403001
203001 Stem Only
GASKET: 199930

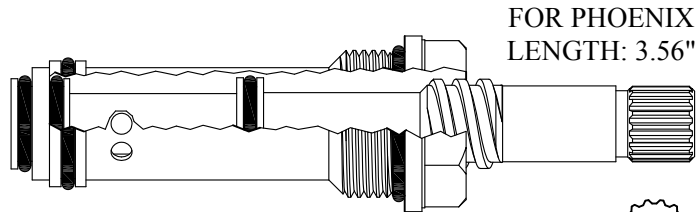

FOR PHOENIX
LENGTH: 3.56"

430771
GASKET: 890170 O-RING INCLUDED



SEAT USED: LF649760

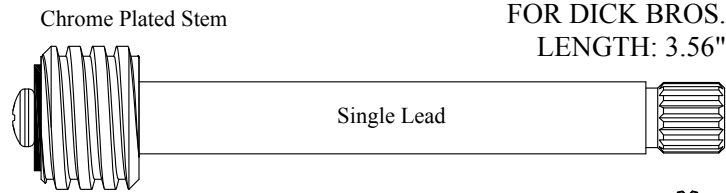

Chrome Plated Stem
FOR DICK BROS.
LENGTH: 3.56"

Single Lead

LF268211/ LF268212



SEAT USED: LF649760

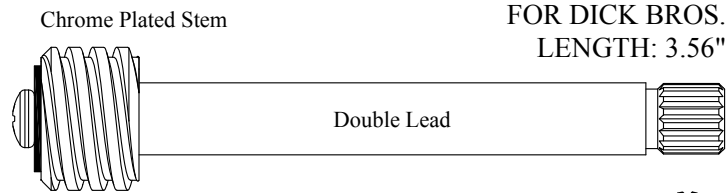

Chrome Plated Stem
FOR DICK BROS.
LENGTH: 3.56"

Double Lead

LF269031/ LF269032



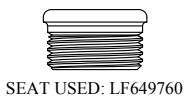

SEAT USED: LF649760

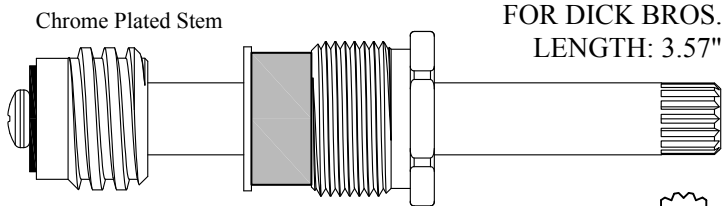

FOR DICK BROS.
LENGTH: 3.57"

403011/ 403012
203011/ 203012 Stem Only

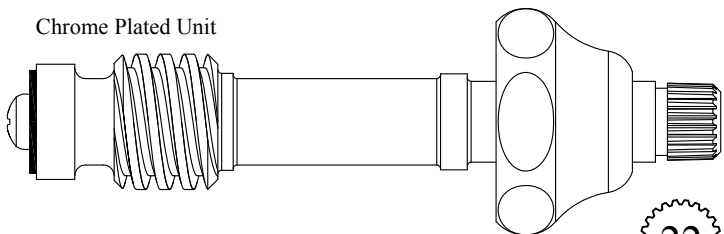

FOR AM STD
LENGTH: 3.57"

LF468071/ LF468072
LF268071/ LF268072 Stem Only

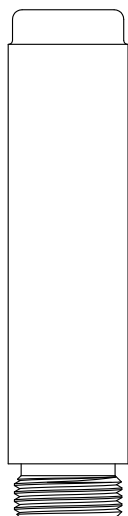

SEAT USED: 647440

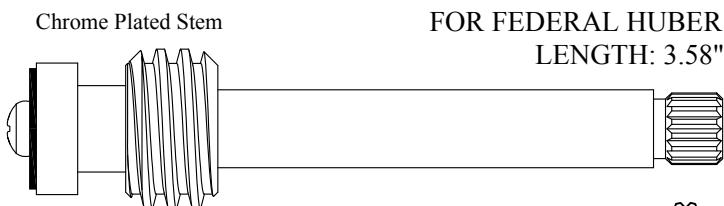

FOR FEDERAL HUBER
LENGTH: 3.58"

203101

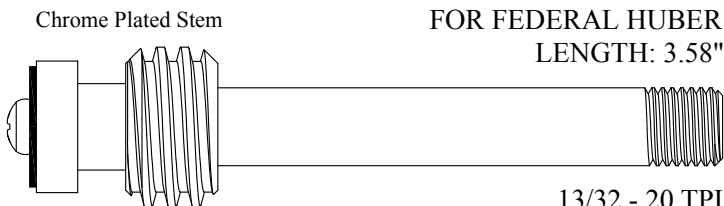

FOR FEDERAL HUBER
LENGTH: 3.58"

203111

13/32 - 20 TPI

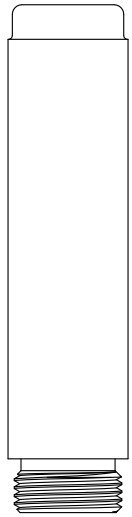

SEAT USED: 647440

Chrome Plated Stem

FOR FEDERAL HUBER
LENGTH: 3.58"

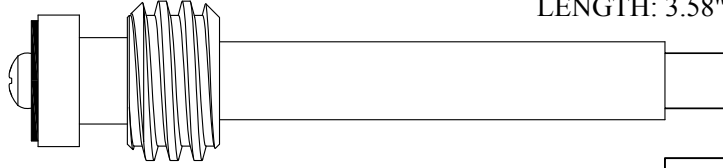

203141

5/16

Chrome Plated Stem

FOR FEDERAL HUBER
LENGTH: 3.58"

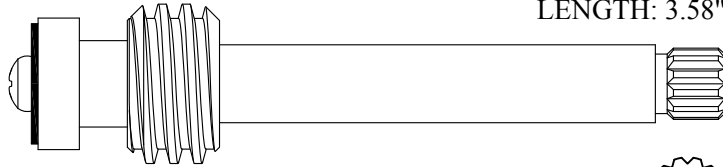

203151

12
1-2

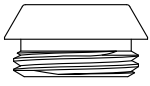

SEAT USED: 648370

FOR PRICE PFISTER
LENGTH: 3.58"

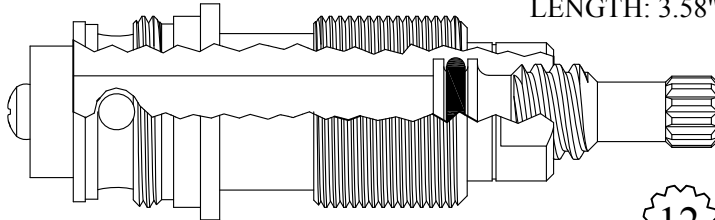

430091

GASKET: 895550

12
1-2

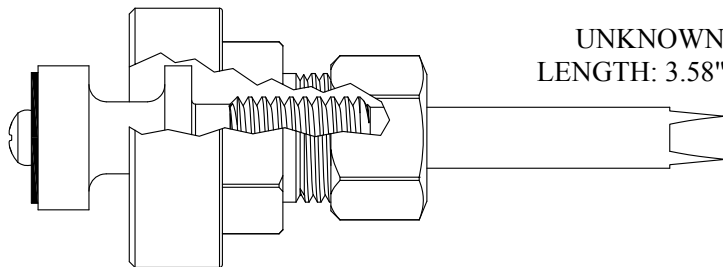

UNKNOWN
LENGTH: 3.58"

468231

GASKET: 894970 INCLUDED

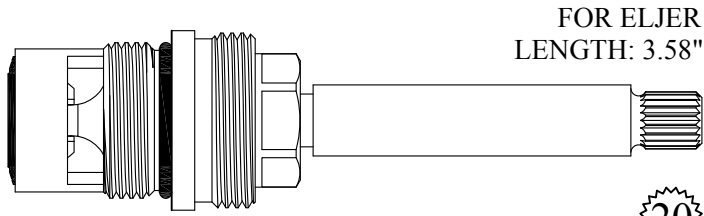

FOR ELJER
LENGTH: 3.58"

20
3-20

402911/ 402912

GASKET: 890170 O-RING INCLUDED
SEAL: 898510
DISC SET: 151380-PKG

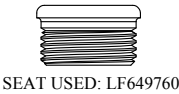

SEAT USED: LF649760



Chrome Plated Stem

FOR DICK BROS.
LENGTH: 3.58"

16
1-6

LF269091/ LF269092

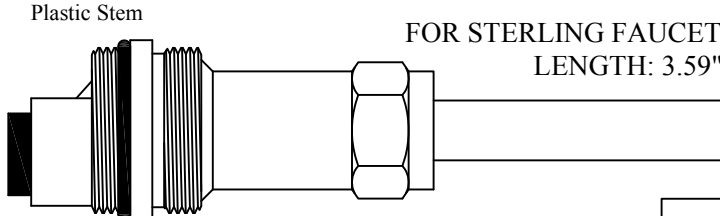

Plastic Stem

FOR STERLING FAUCET
LENGTH: 3.59"

5/16

403220
203220 Stem Only

GASKET: 890190 O-RING INCLUDED

FOR GERBER
FOR DANFOSS
FOR TEMPRESS
FOR DORNBRACHT
LENGTH: 3.59"

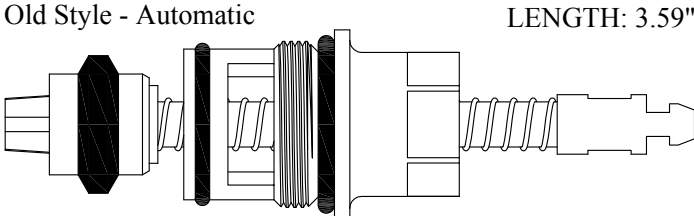

Old Style - Automatic

430790

GASKET: 894120 O-RING INCLUDED

Chrome Plated Unit

FOR SPEAKMAN
LENGTH: 3.59"

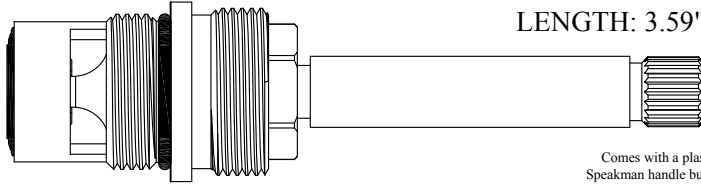

Comes with a plastic
Speakman handle bushing

402951/ 402952

GASKET: 890170 O-RING INCLUDED
SEAL: 898510
DISC SET: 151380-PKG



2-4

Chrome Plated Unit

FOR SPEAKMAN
LENGTH: 3.59"

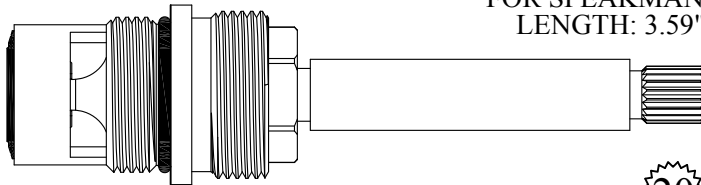

3-20

402961/ 402962

GASKET: 890170 O-RING INCLUDED
SEAL: 898510
DISC SET: 151380-PKG

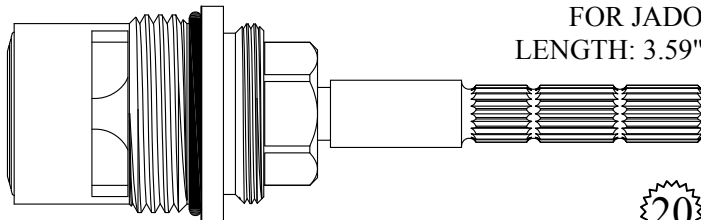

FOR JADO
LENGTH: 3.59"



3-20

402971/ 402972

GASKET: 890210 O-RING INCLUDED
SEAL: 898520
DISC SET: 109850-PKG

FOR AM STD
LENGTH: 3.59"



LF268310

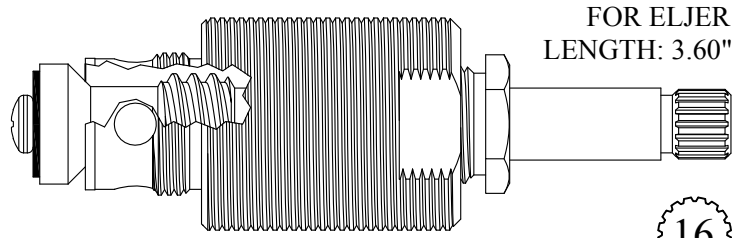

430131
GASKET: 895100

16
3-15

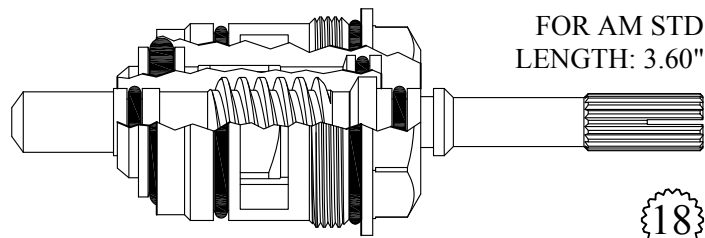

431681
GASKET: 890210 O-RING INCLUDED

18
3-30

USES BARREL:
LF647021/LF647022

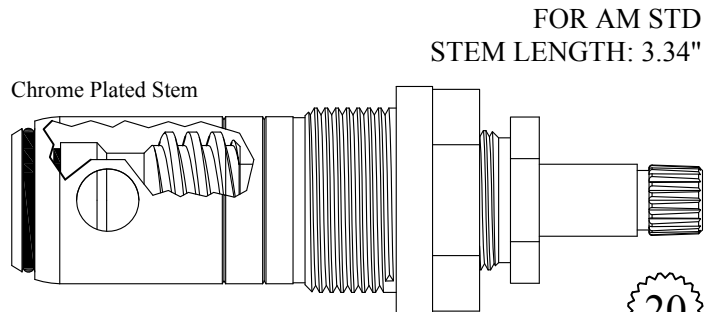

LF468701/ LF468702
LF268701/ LF268702 Stem Only
GASKET: 818010

20
3-14

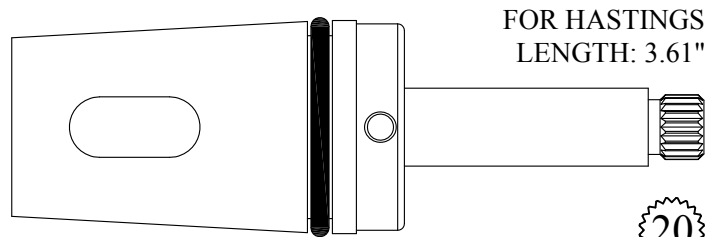

230580

20
11/32
3-34

USES BARREL:
LF647021/LF647022

FOR AM STD
STEM LENGTH: 3.34"

Chrome Plated Stem

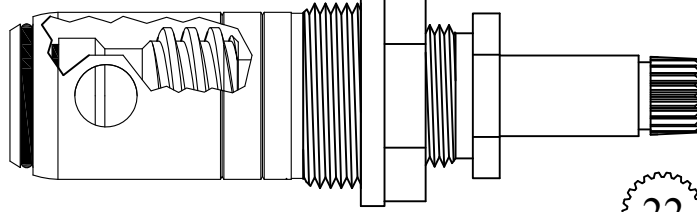

LF468061/ LF468062
LF268061/ LF268062 Stem Only
GASKET: 818010

FOR AM STD
LENGTH: 3.34"

Chrome Plated Stem

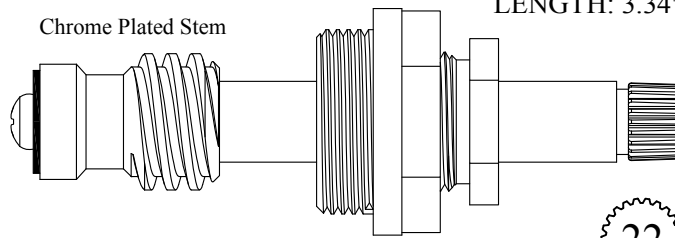

LF468261/ LF468262
LF268061/ LF268062 Stem Only

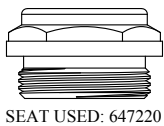

SEAT USED: 647220

FOR KOHLER
LENGTH: 3.62"

Triple Lead

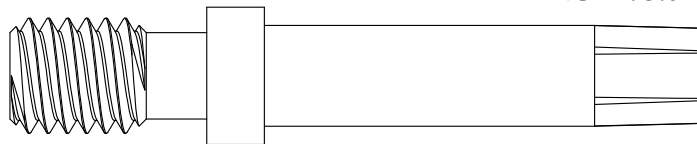

202941

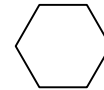

FOR CRANE
LENGTH: 3.66"

Chrome Plated Bonnet

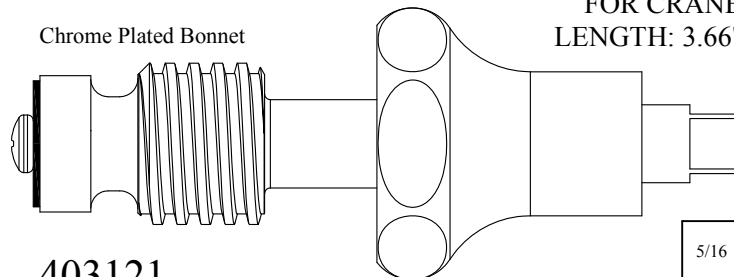

403121
203121 Stem Only



SEAT USED: LF649930

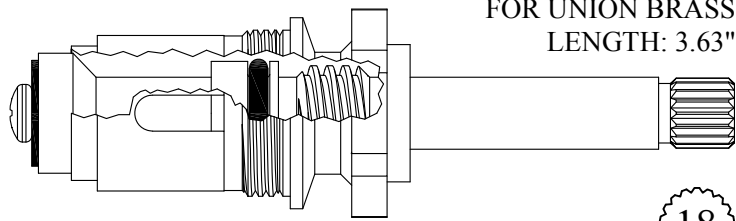

FOR UNION BRASS
LENGTH: 3.63"

430151
GASKET: 895400

18
3-3



SEAT USED: LF648550

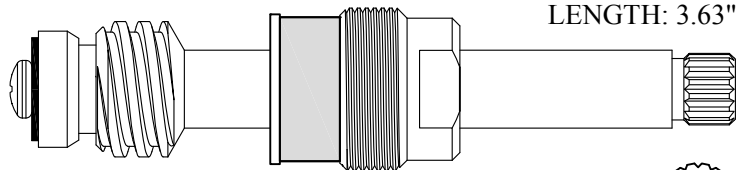

FOR CENTRAL
LENGTH: 3.63"

LF469021/ LF469022
LF269021/ LF269022 Stem Only

16
1-6

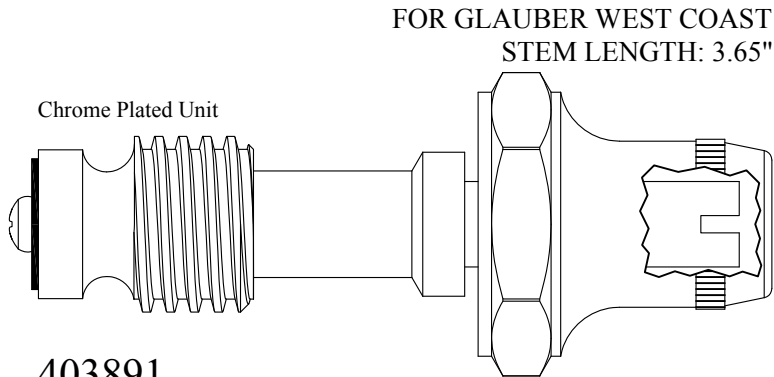

FOR GLAUBER WEST COAST
STEM LENGTH: 3.65"

Chrome Plated Unit

403891
203891 Stem Only



SEAT USED: LF647690

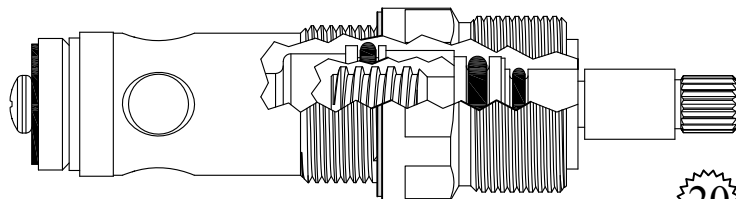

FOR ELJER
LENGTH: 3.65"

430192
GASKET: 895160 INCLUDED

20
3-20

FOR ACORN
LENGTH: 3.65"

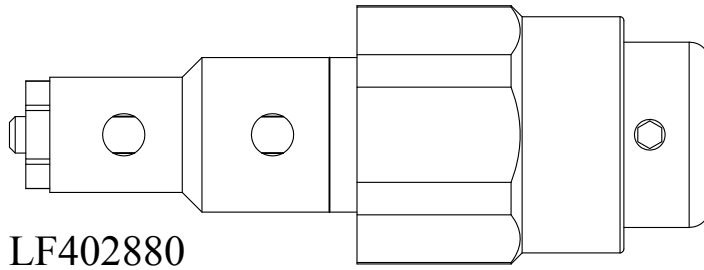

LF402880

Chrome Plated Stem

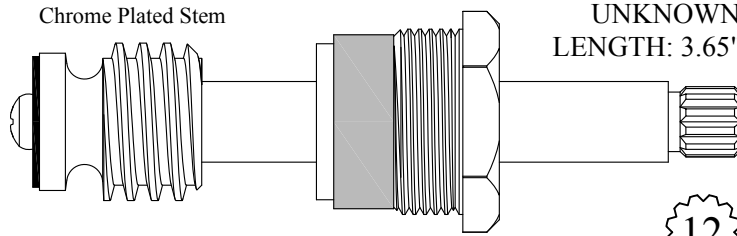

UNKNOWN
LENGTH: 3.65"

LF469221

LF269221 Stem Only

12
1-2

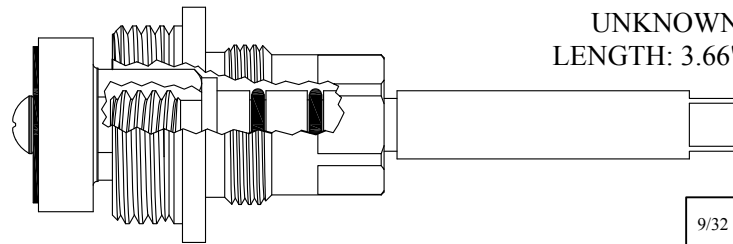

UNKNOWN
LENGTH: 3.66"

403062

GASKET: 895560

9/32

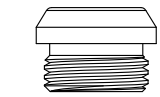

SEAT USED: LF648130

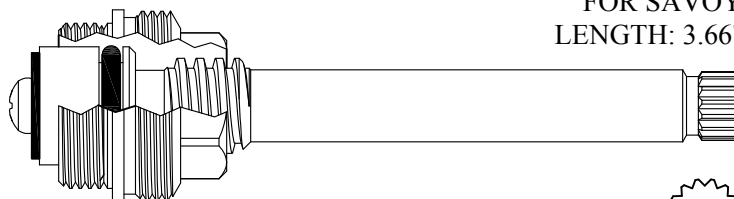

FOR SAVOY
LENGTH: 3.66"

403321

GASKET: 895400

15
1-13

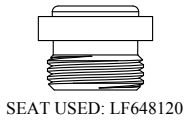

Chrome Plated Stem

FOR BRIGGS
LENGTH: 3.66"

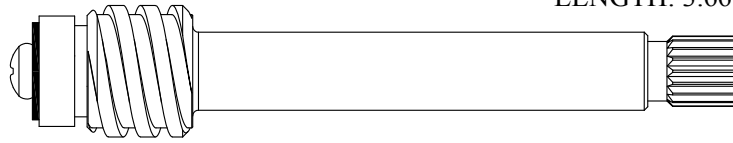

LF269151/ LF269152

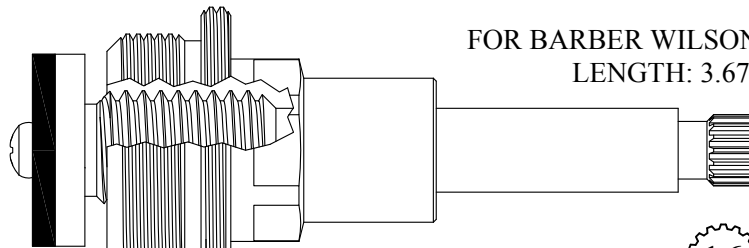

FOR BARBER WILSON
LENGTH: 3.67"

404541



Chrome Plated Stem

FOR SPEAKMAN
LENGTH: 3.69"

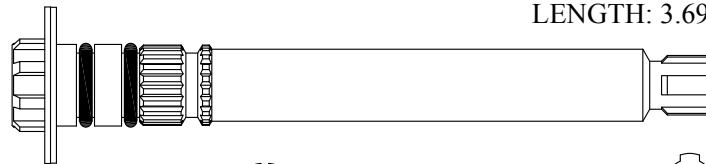

202980

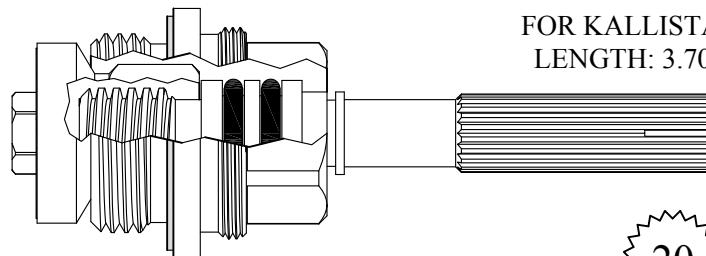

FOR KALLISTA
LENGTH: 3.70"

402792

GASKET: 895440



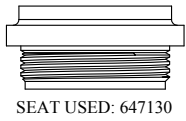

SEAT USED: 647130

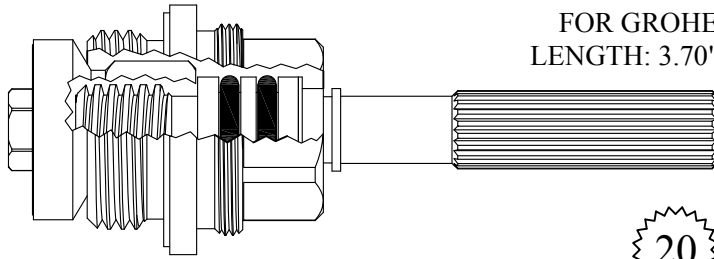

FOR GROHE
LENGTH: 3.70"

402892

GASKET: 895440 INCLUDED

20
3-32

FOR CRANE
LENGTH: 3.71"



SEAT USED: LF648340

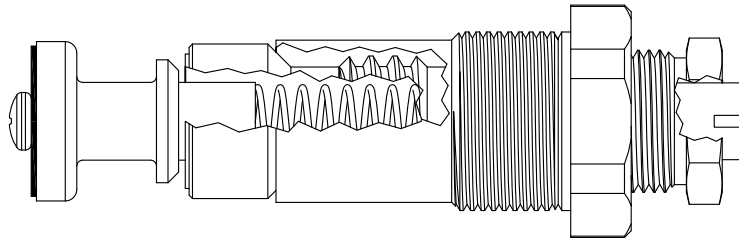

402731

202731 Stem Only

GASKET: 895370

FOR ARTISTIC BRASS
LENGTH: 3.73"

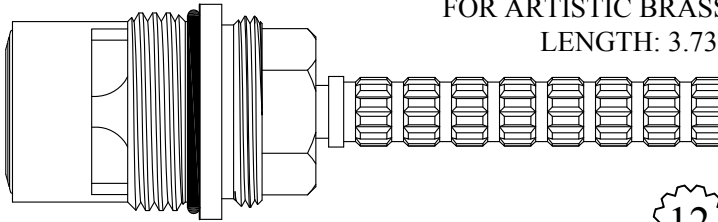

403041/ 403042

GASKET: 890210 O-RING INCLUDED

SEAL: 898520

DISC SET: 109850-PKG

12
1-2

FOR CIFIAL
LENGTH: 3.74"

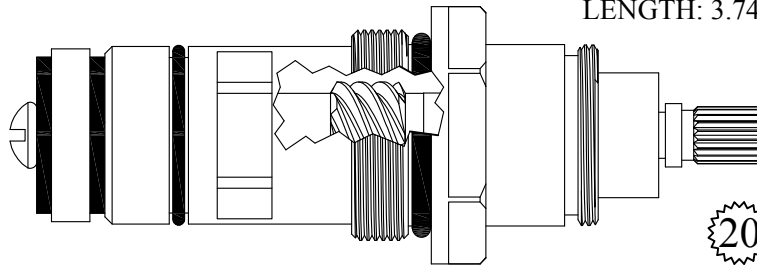

430871

GASKET: 891180 O-RING INCLUDED

20
3-20

Chrome Plated Stem

FOR BRIGGS
LENGTH: 3.74"

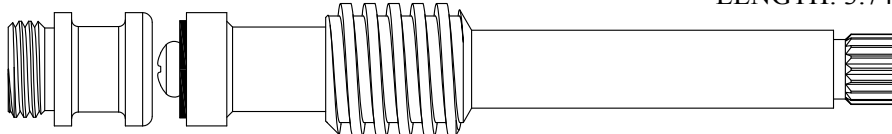

SEAT USED: LF648250

LF269141

18
3-3

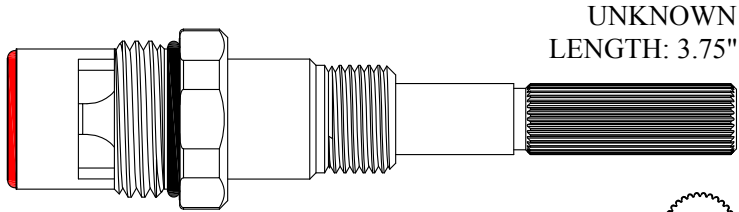

UNKNOWN
LENGTH: 3.75"

LF468441/ LF468442

GASKET: 890170 O-RING INCLUDED
SEAL: 898570-R/B
DISC SET: 151380-PKG

32
3-23

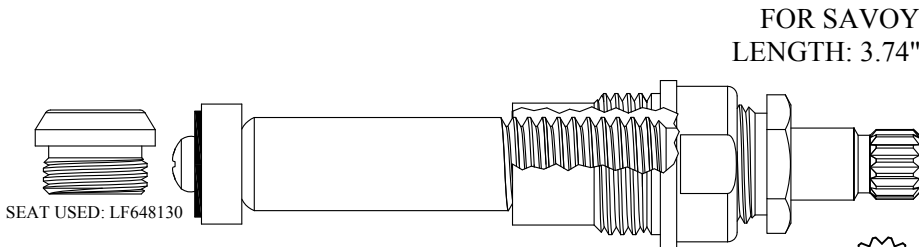

FOR SAVOY
LENGTH: 3.74"

SEAT USED: LF648130

LF468801/ LF468802

GASKET: 895100

15
1-13

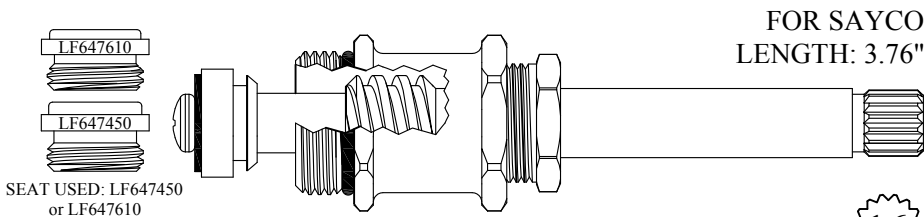

FOR SAYCO
LENGTH: 3.76"

SEAT USED: LF647450
or LF647610

403031

203031 Stem Only

GASKET: 890160 O-RING INCLUDED

16
2-3

New Style - Manual

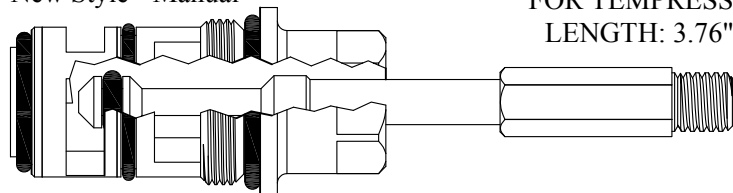

FOR ROHL
FOR GERBER
FOR DANFOSS
FOR TEMPRESS
LENGTH: 3.76"

430850

GASKET: 894120 O-RING INCLUDED

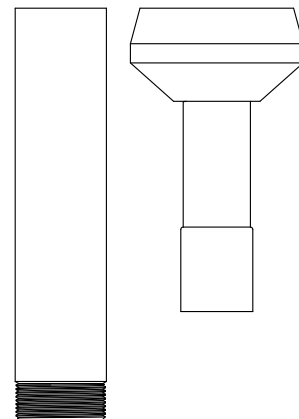

Chrome plated handle
& sleeve available
128540

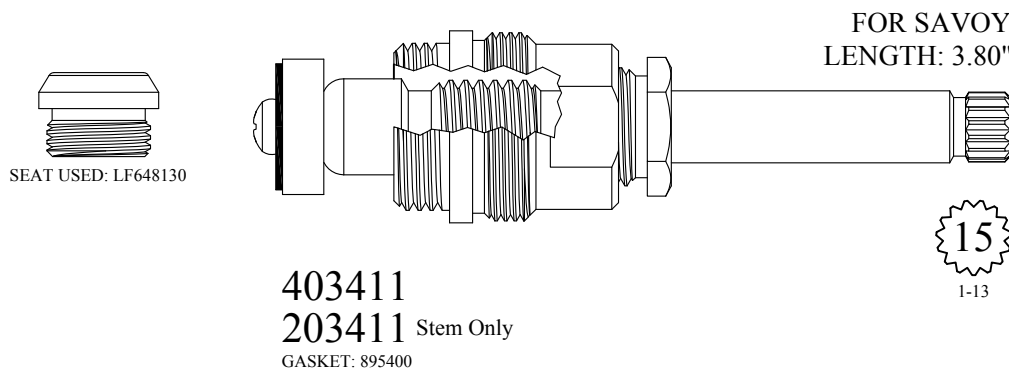
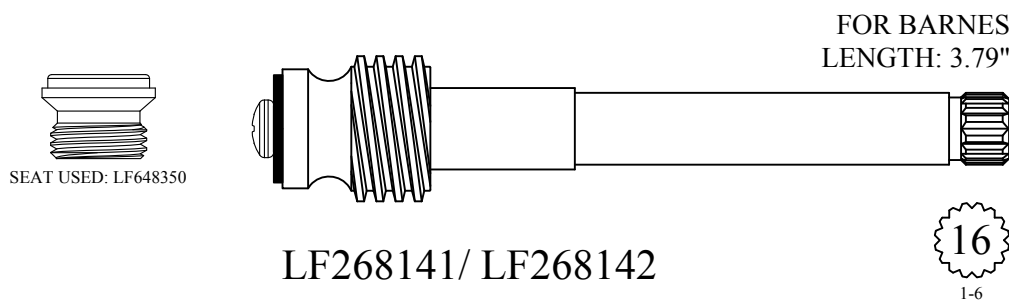
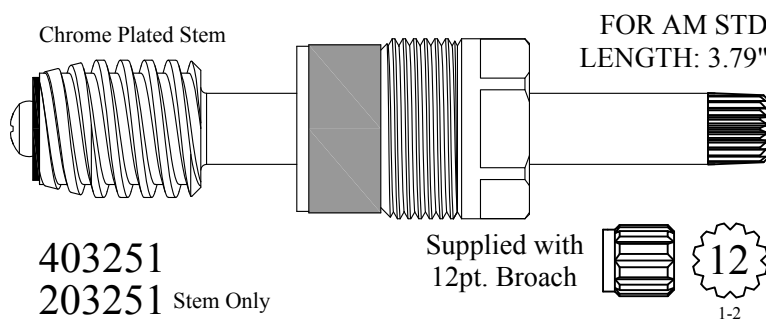
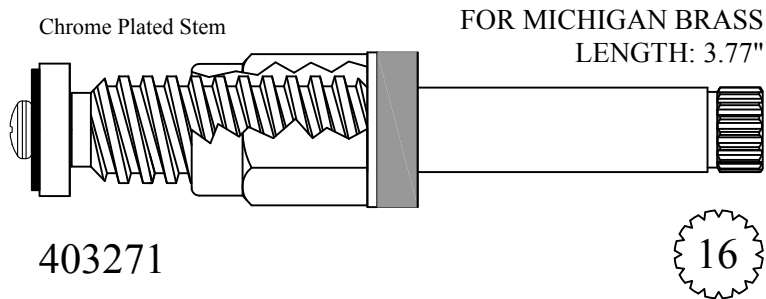

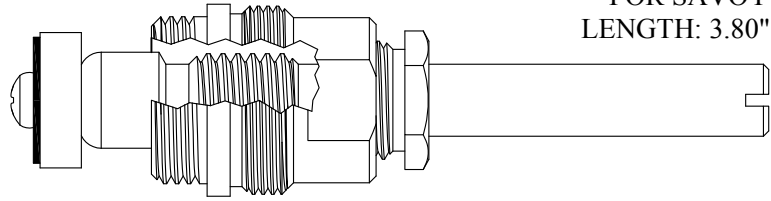

403561
GASKET: 895400

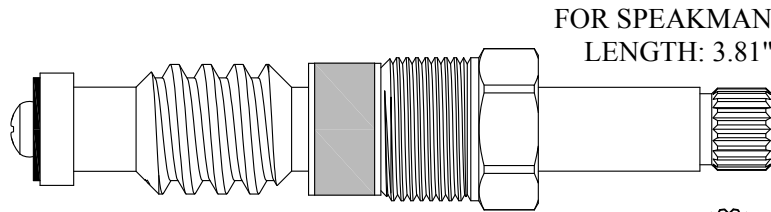

403301
203301 Stem Only

20
2-4

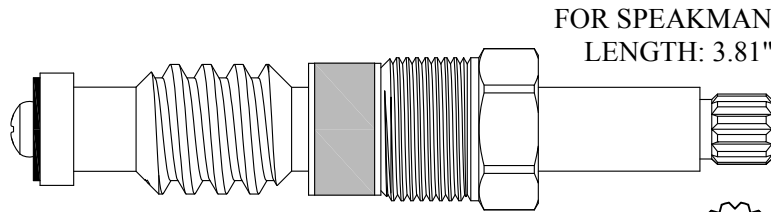

403351
203351 Stem Only

12
1-2

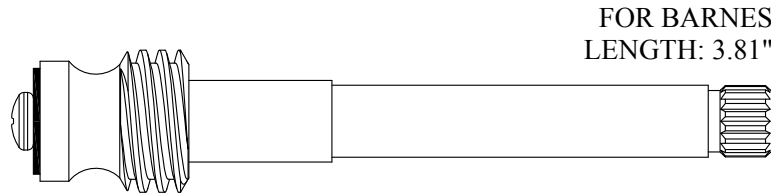

LF269061/ LF269062

16
1-6

UNKNOWN
LENGTH: 3.81"



LF403461/ LF403462

GASKET: 890170 O-RING INCLUDED
SEAL: 898580-R/B
DISC SET: 151380-PKG

14
5/16

FOR AM STD
STEM LENGTH: 3.56"

Chrome Plated Stem

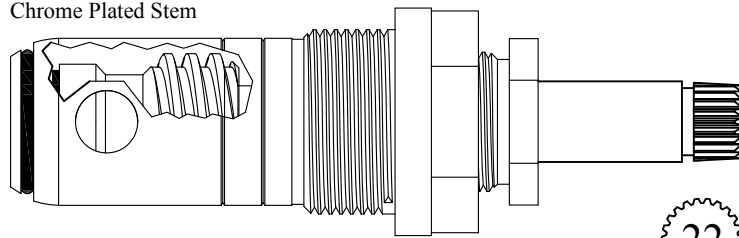

USES BARREL:
LF647021/LF647022

LF468081/ LF468082
LF268081/ LF268082 Stem Only
GASKET: 818010

22
1-4

FOR ELJER
LENGTH: 3.82"

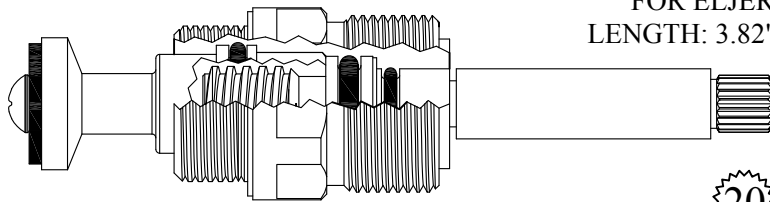

SEAT USED: LF647690

403232
GASKET: 895160 INCLUDED

20
3-20

FOR SPEAKMAN
LENGTH: 3.82"

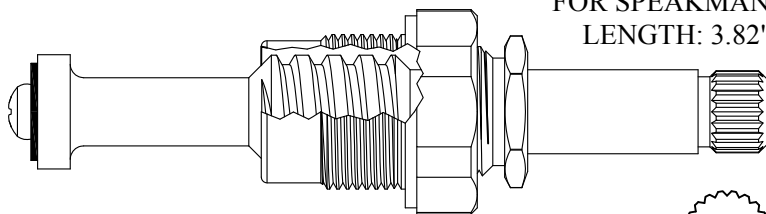

SEAT USED: LF648760

403241
203241 Stem Only
GASKET: 895160

20
2-4

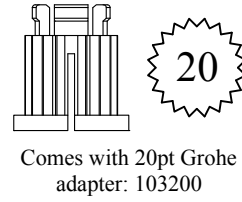
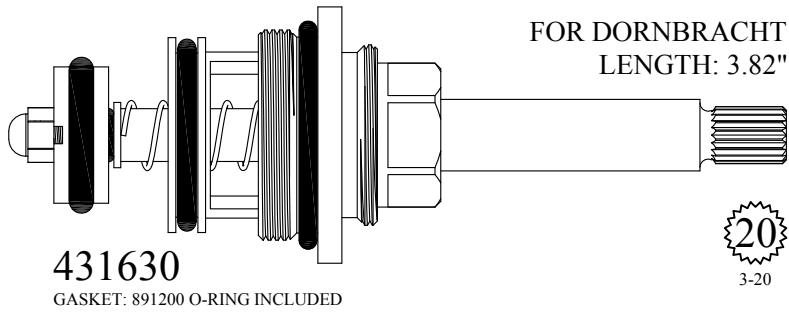

Comes with 20pt Grohe adapter: 103200

20
3-20

431630
GASKET: 891200 O-RING INCLUDED

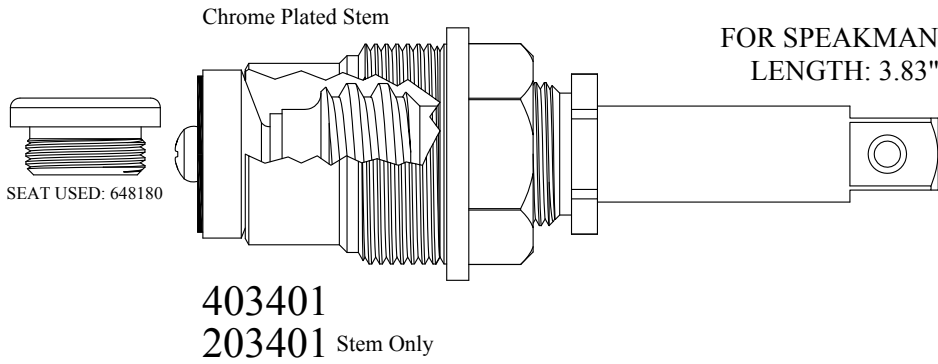

403401
203401 Stem Only

SEAT USED: 648180

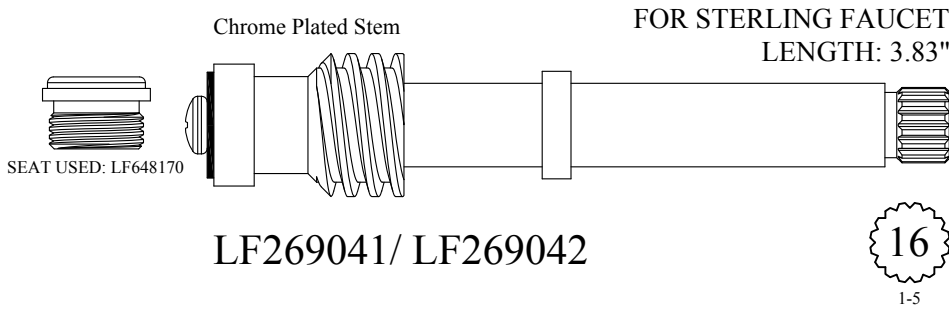

LF269041/ LF269042

SEAT USED: LF648170

16
1-5

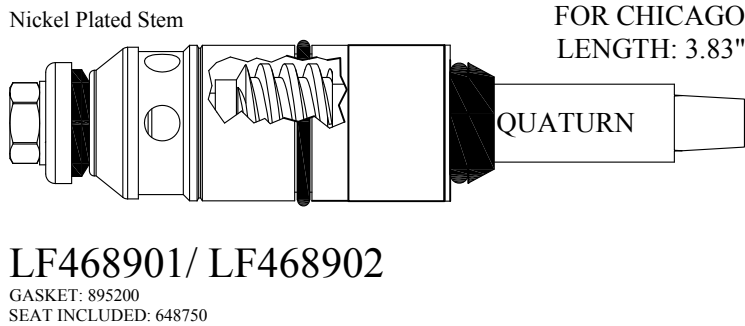

LF468901/ LF468902
GASKET: 895200
SEAT INCLUDED: 648750

FOR AM STD
LENGTH: 3.83"

Chrome Plated Stem

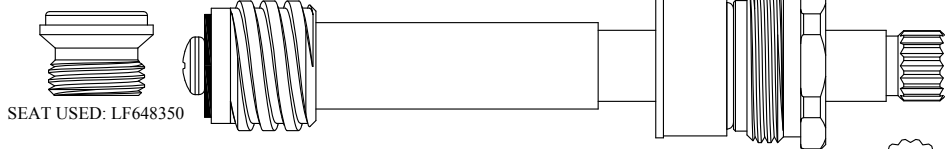

SEAT USED: LF648350

LF469071/ LF469072
LF269071/ LF269072 Stem Only

16

FOR MICHIGAN BRASS
LENGTH: 3.86"

24 TPI Gland
Chrome Plated Gland

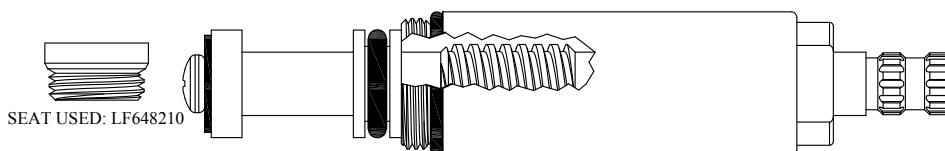

SEAT USED: LF648210

403421/ 403422
GASKET: 890160 O-RING INCLUDED

12
3-5

FOR WOLVERINE
LENGTH: 3.86"

20 TPI Gland
Chrome Plated Gland

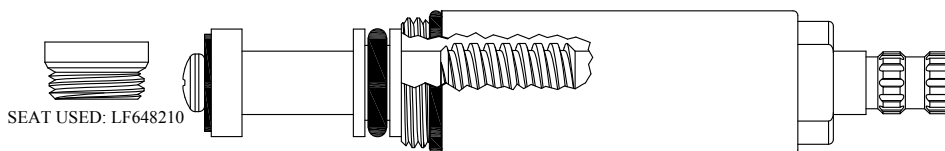

SEAT USED: LF648210

403541/ 403542
GASKET: 890160 O-RING INCLUDED

12
3-5

FOR AM STD
LENGTH: 3.87"

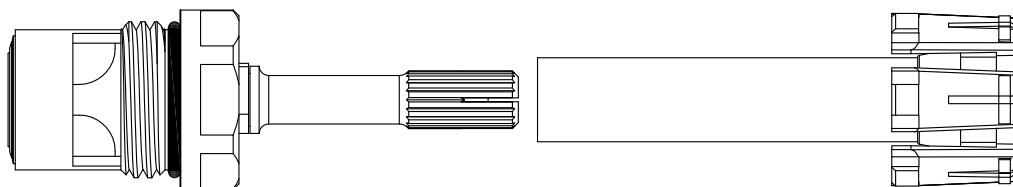

406101
GASKET: 890170 O-RING INCLUDED
SEAL: 898510-W
DISC SET: 151380-PKG

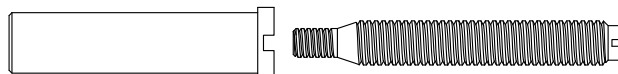



Chrome Plated Stem

FOR KOHLER
LENGTH: 3.87"

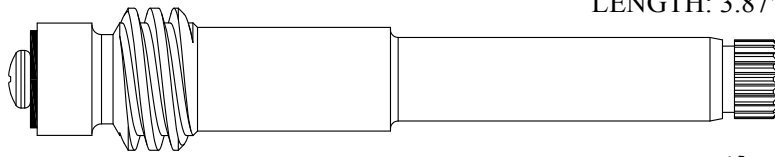

LF269081/ LF269082



Chrome Plated Stem

FOR SPEAKMAN
LENGTH: 3.88"



203470



FOR PHOENIX
LENGTH: 3.88"

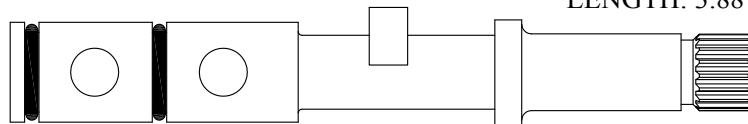

230370



Chrome Plated Stem

FOR MILWAUKEE
LENGTH: 3.88"

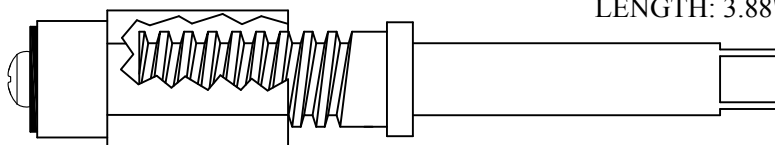

402632
202632 Stem Only



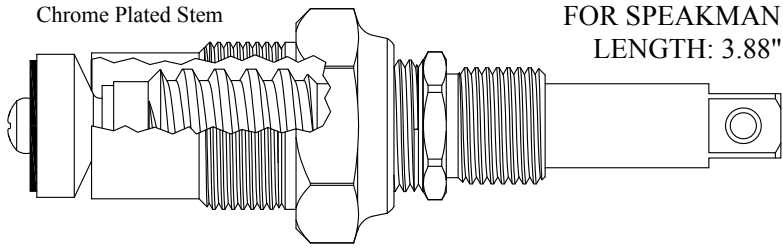

403531
203531 Stem Only
GASKET: 895400

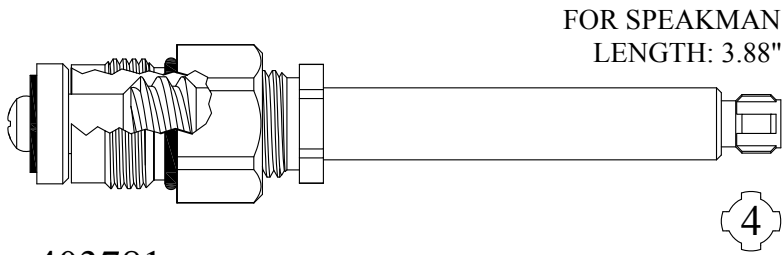

403781
GASKET: 890150 O-RING INCLUDED

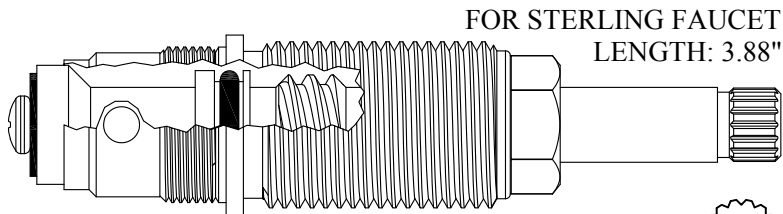

430181
GASKET: 895150

1-5



LF269161/ LF269162

3-7

Chrome Plated Stem

FOR HARCRAFT
LENGTH: 3.88"

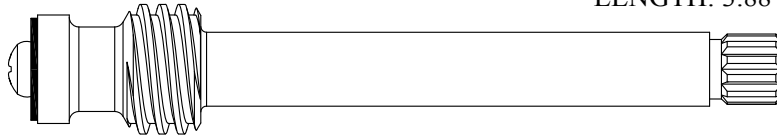

LF270011/ LF270012

12
1-2

CERAMIC CONVERSION FOR AM STD COLONY (LONG)
LENGTH: 3.90"

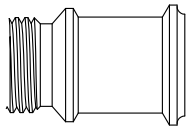

SEAT INCLUDED: 646960

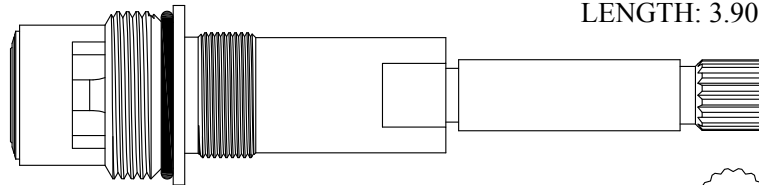

403481

GASKET: 890180 O-RING INCLUDED
SEAL: 898510-W
DISC SET: 151380-PKG

16

Chrome Plated Stem

FOR SPHINX
LENGTH: 3.90"

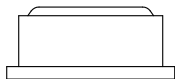

SEAT USED: LF649520

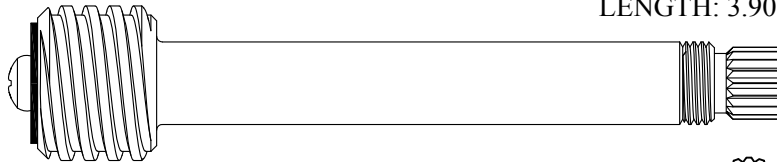

202221/ 202222

18
3-3

Chrome Plated Stem

FOR SPHINX
LENGTH: 3.90"

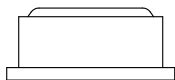

SEAT USED: LF649520

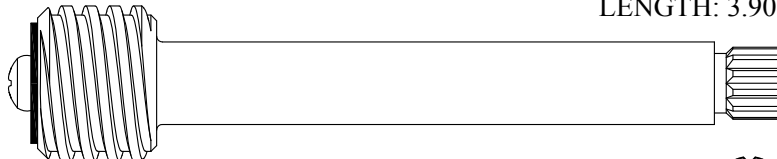

202271/ 202272

12
1-2

FOR KOHLER
LENGTH: 3.91"

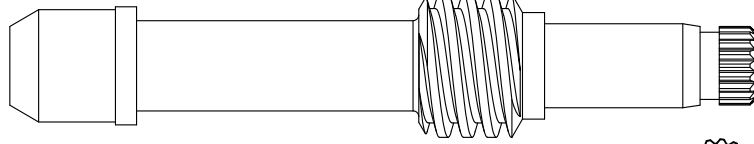

231151

19

1-7

FOR STERLING FAUCET
LENGTH: 3.91"



SEAT USED: LF648170

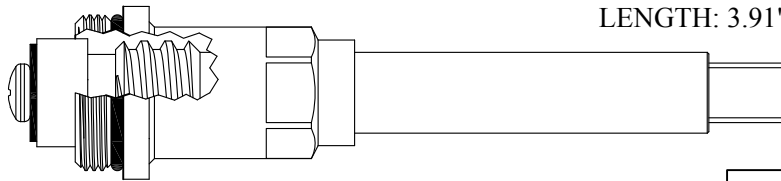

5/16

403931/ 403932

GASKET: 890170 O-RING INCLUDED

FOR UNION BRASS
LENGTH: 3.91"

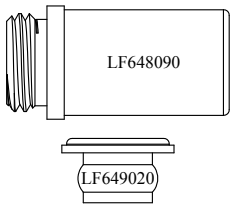

SEATS USED: LF648090 or LF649020

Chrome Plated Stem

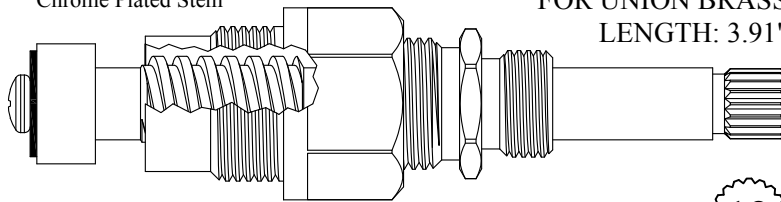

18

3-3

LF469051/ LF469052

LF269051/ LF269052 Stem Only

GASKET: 895150

FOR STERLING FAUCET
LENGTH: 3.92"



SEAT USED: LF648170

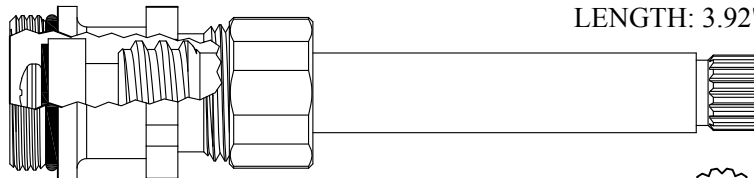

16

1-5

403331

GASKET: 890170 O-RING INCLUDED

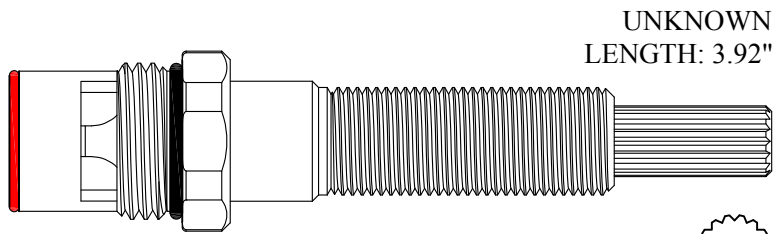

UNKNOWN
LENGTH: 3.92"

403631/ 403632
GASKET: 890170 O-RING INCLUDED
SEAL: 898580-R/B
DISC SET: 151380-PKG

16
1-6

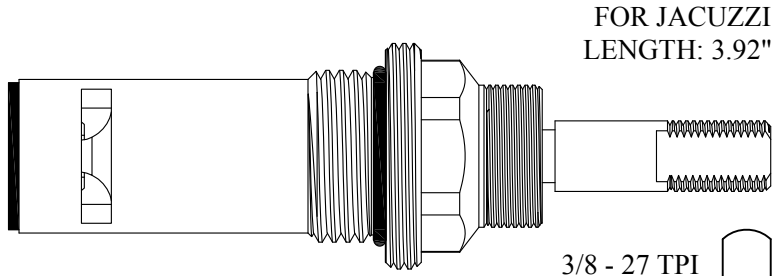

FOR JACUZZI
LENGTH: 3.92"

403821/ 403822
GASKET: 890190 O-RING INCLUDED
SEAL: 898550
DISC SET: 151380-PKG

3/8 - 27 TPI

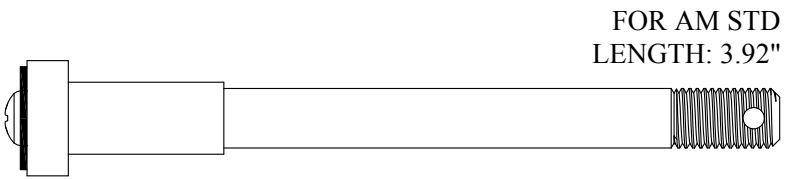

FOR AM STD
LENGTH: 3.92"

LF270030

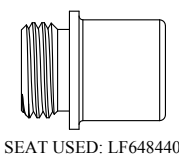

SEAT USED: LF648440

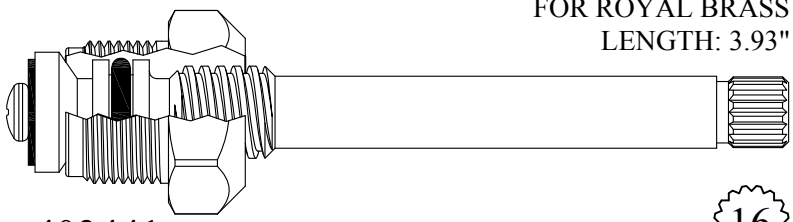

FOR ROYAL BRASS
LENGTH: 3.93"

403441
GASKET: 895100

16
1-6

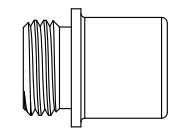

SEAT USED: LF648440



FOR ROYAL BRASS
LENGTH: 3.93"

403521

GASKET: 890160 O-RING INCLUDED

16
1-6

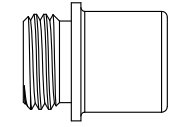

SEAT USED: LF648440

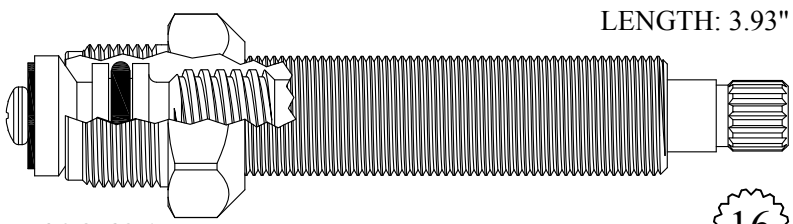

FOR ROYAL BRASS
LENGTH: 3.93"

403621

GASKET: 895100

16
1-6

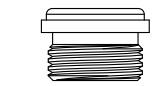

SEAT USED: LF648170

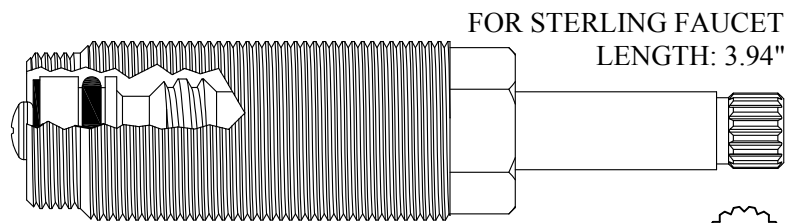

FOR STERLING FAUCET
LENGTH: 3.94"

403511/ 403512

GASKET: 895150

16
1-5



SEAT USED: 647190

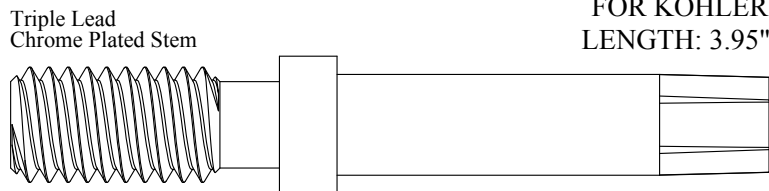

Triple Lead
Chrome Plated Stem

FOR KOHLER
LENGTH: 3.95"

203211

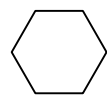

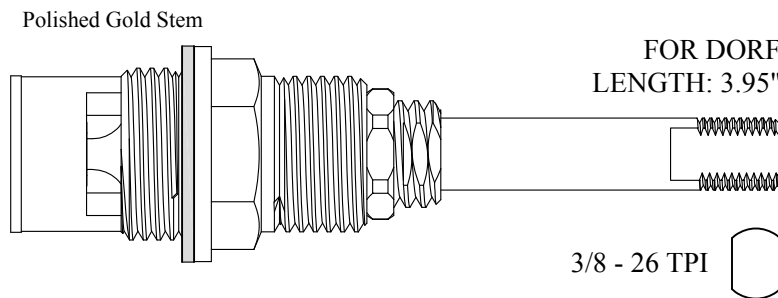
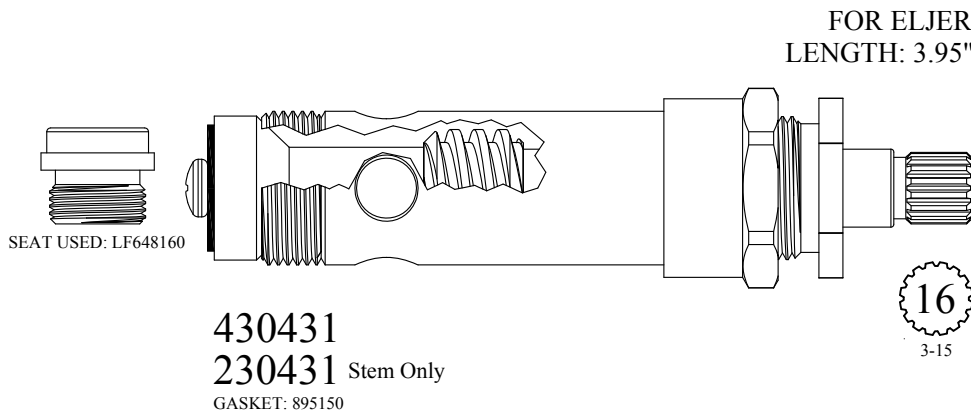
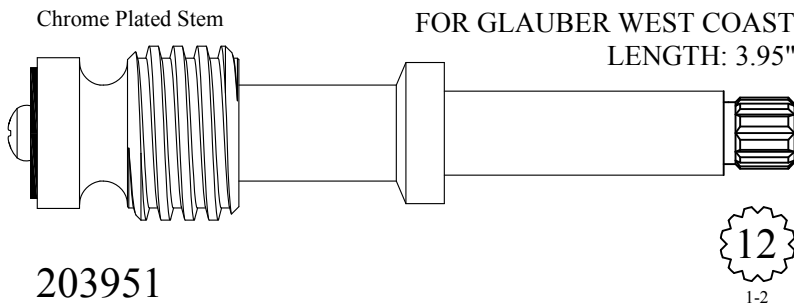
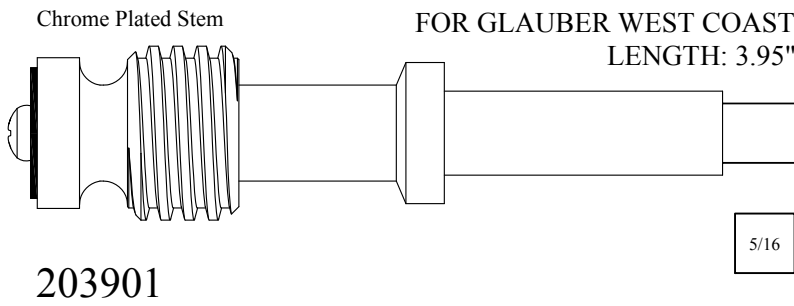

LF469301/ LF469302
DISC SET: 151380-PKG
GASKET: 895370 INCLUDED

Also available with a Polished Chrome Plated Stem
LF469301-CP / LF469302-CP

Polished Gold Stem

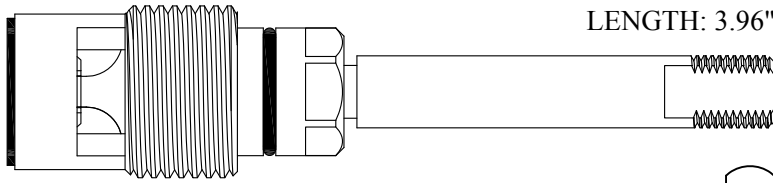

FOR DORF
LENGTH: 3.96"

3/8 - 26 TPI

Nut Also available

369500

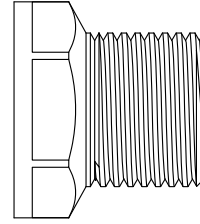

LF469501/ LF469502

DISC SET: 151380-PKG
GASKET: 895370

Also available with a Polished Chrome Plated Stem
LF469501-CP / LF469502-CP

FOR PRICE PFISTER
LENGTH: 3.97"

Chrome Plated Unit

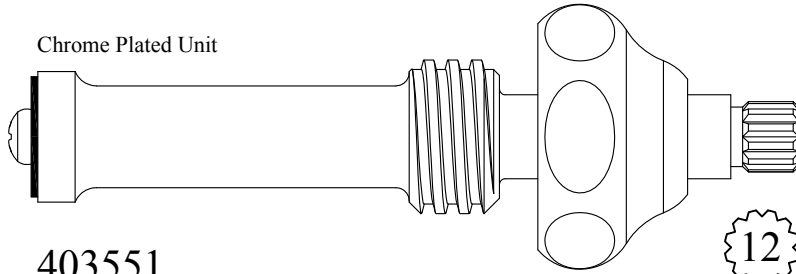

403551

203551 Stem Only



1-2

FOR STERLING FAUCET
LENGTH: 3.98"



SEAT USED: LF648170

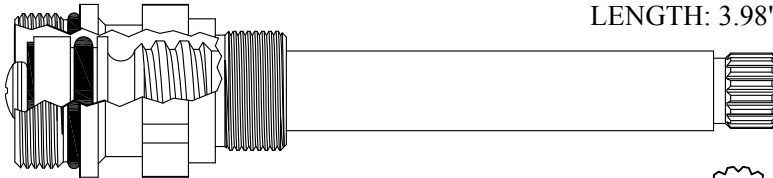

403921

GASKET: 890170 O-RING INCLUDED



1-5

Chrome Plated Stem

FOR ELJER
LENGTH: 3.98"

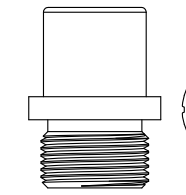

SEAT USED: LF649640

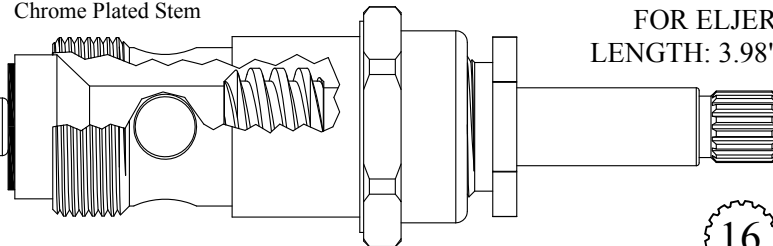

430251

230251 Stem Only

GASKET: 895320



3-15



SEAT USED: LF648410

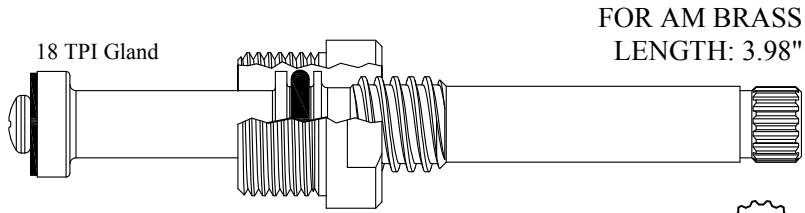

18 TPI Gland

FOR AM BRASS
LENGTH: 3.98"

403601 / 403602

GASKET: 895100



SEAT USED: LF648410

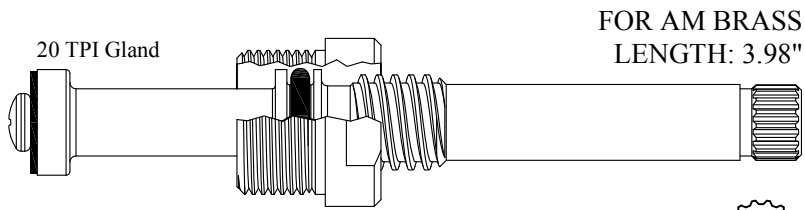

20 TPI Gland

FOR AM BRASS
LENGTH: 3.98"

403611/ 403612

GASKET: 895100



SEAT USED: LF649010

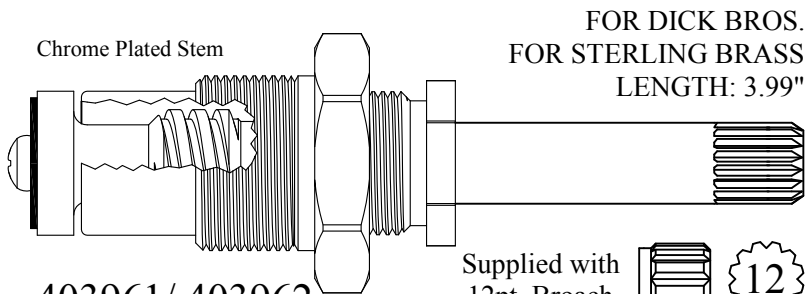

Chrome Plated Stem

FOR DICK BROS.
FOR STERLING BRASS
LENGTH: 3.99"

403961/ 403962
203961/ 203962 Stem Only

GASKET: 895370

Supplied with
12pt. Broach

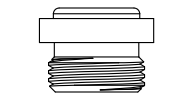

SEAT USED: LF648120

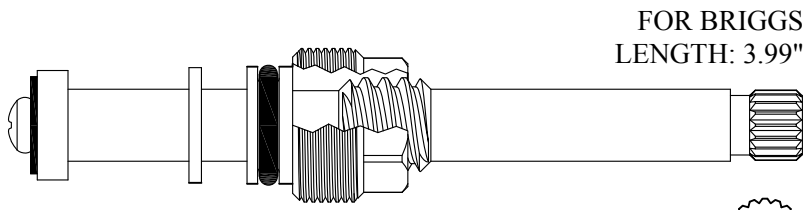

FOR BRIGGS
LENGTH: 3.99"

404111/ 404112



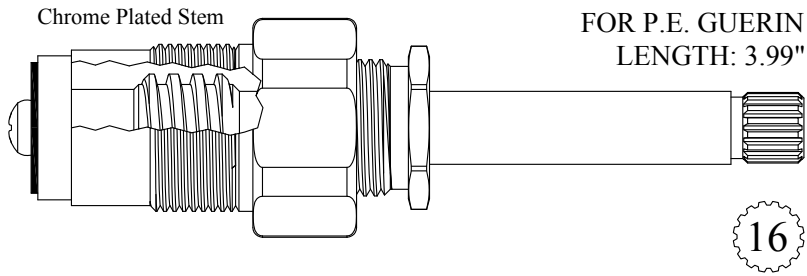

404421/ 404422
GASKET: 895400

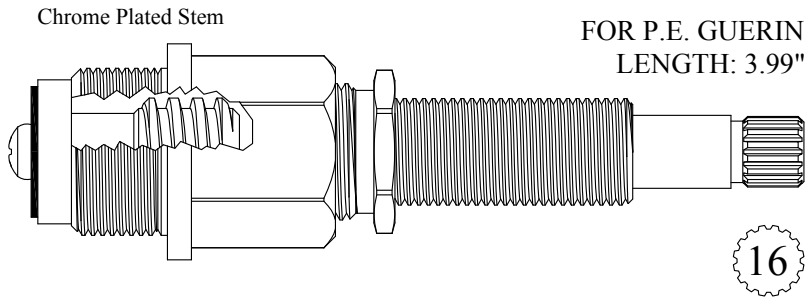

404431/ 404432
GASKET: 895400

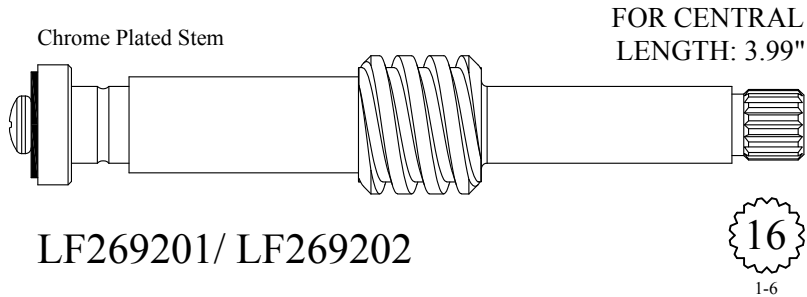

LF269201/ LF269202

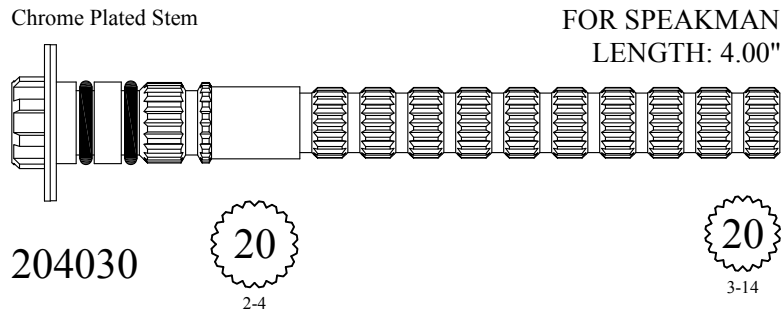

204030

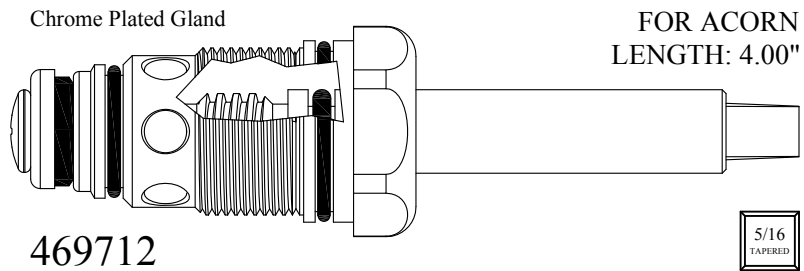
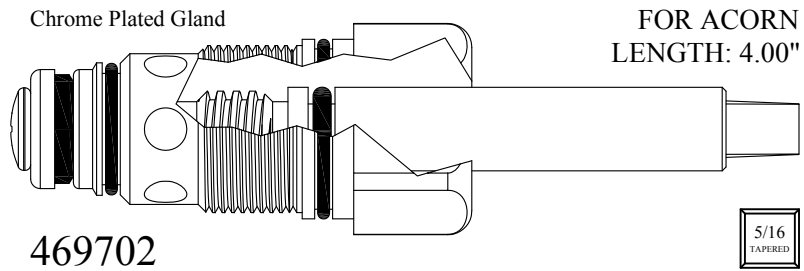
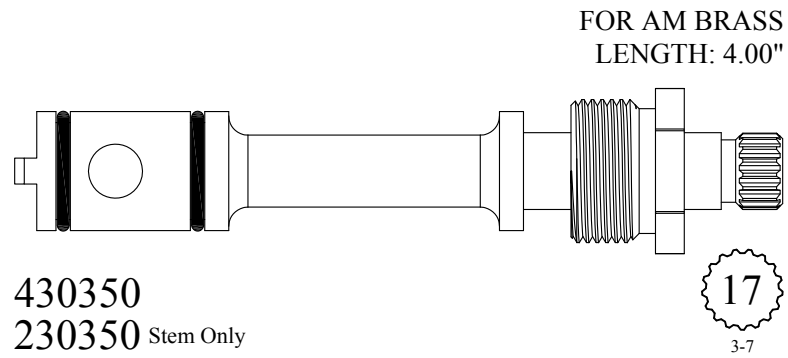
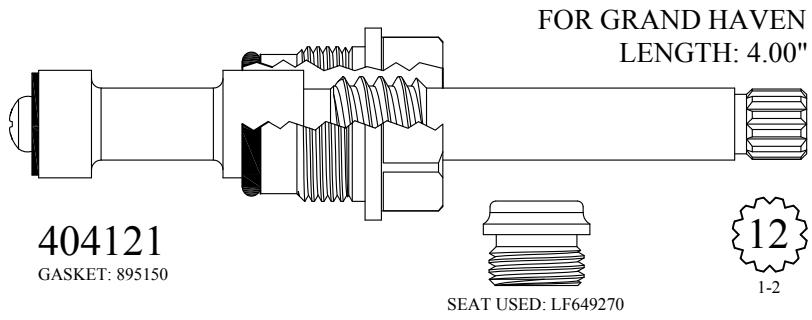

Chrome Plated Stem

FOR DWYER
LENGTH: 4.00"

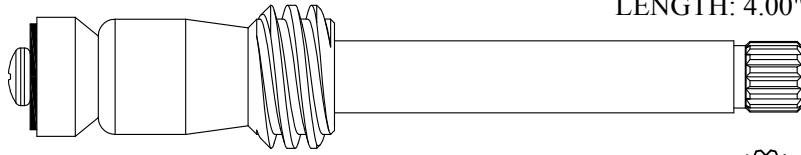

LF270041/ LF270042

16
1-6

Chrome Plated Stem

FOR AM BRASS
LENGTH: 4.00"



SEAT USED: LF649240

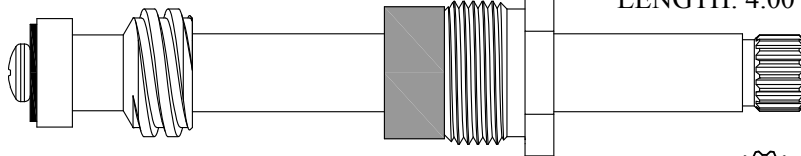

LF470021/ LF470022
LF270021/ LF270022 Stem Only

17
3-7

UNKNOWN
LENGTH: 4.01"

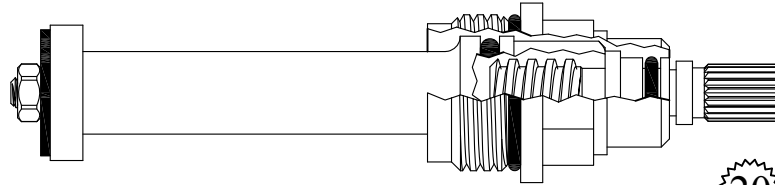

426812
GASKET: 890170 O-RING INCLUDED

20
3-20

Chrome Plated Stem & Tube

FOR MOEN
LENGTH: 4.01"

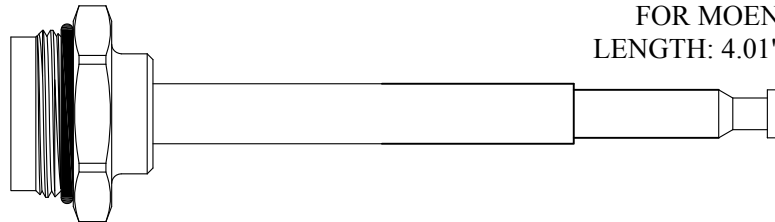

430460
GASKET: 890190 O-RING INCLUDED

SEAT USED: LF649640

Chrome Plated Stem

FOR ELJER
LENGTH: 4.01"

16
3-15

Also available with polished brass stem

404001/ 404002
204001/ 204002 Stem Only

404001-PB/ 404002-PB
204001-PB/ 204002-PB Stem Only

GASKET: 895330

SEAT USED: LF648620

Chrome Plated Stem

FOR ELJER
LENGTH: 4.01"

16
3-15

Also available with polished brass stem

404021/ 404022
204001/ 204002 Stem Only

404021-PB/ 404022-PB
204001-PB/ 204002-PB Stem Only

GASKET: 895120

SEAT USED: 648510
or LF648120

LF648120

648510

FOR BRIGGS
LENGTH: 4.02"

18
3-3

404101/ 404102

GASKET: 895150

SEAT USED: LF648760

FOR SPEAKMAN
LENGTH: 4.035"

20
2-4

430121
230121 Stem Only

GASKET: 895160

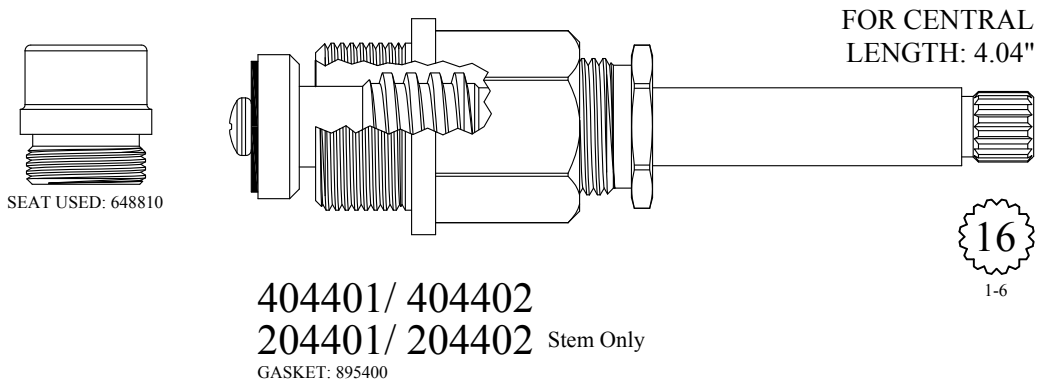
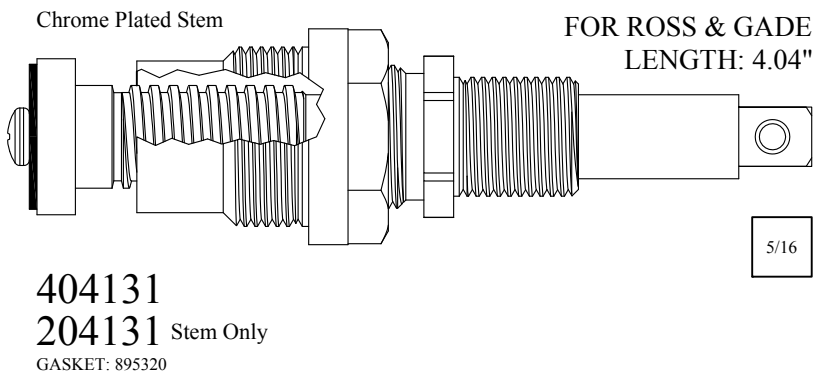
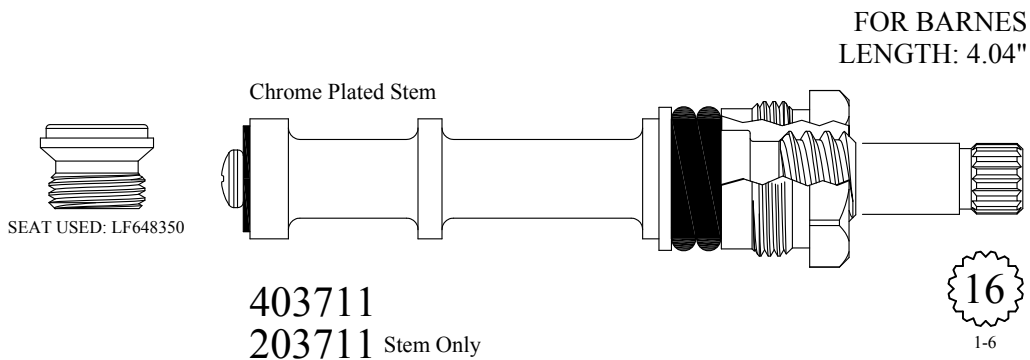
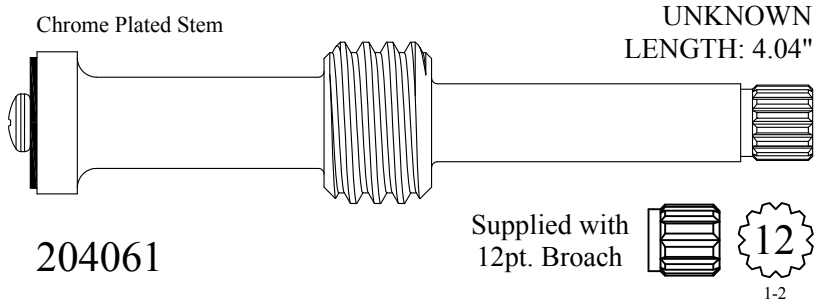

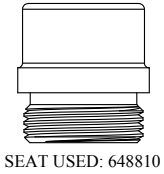

SEAT USED: 648810

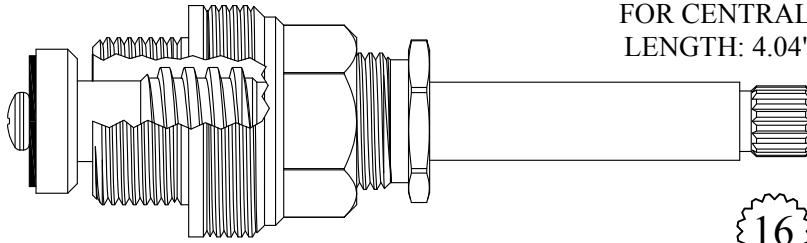

FOR CENTRAL
LENGTH: 4.04"

16
1-6

404411/ 404412
204401/ 204402 Stem Only
GASKET: 895400

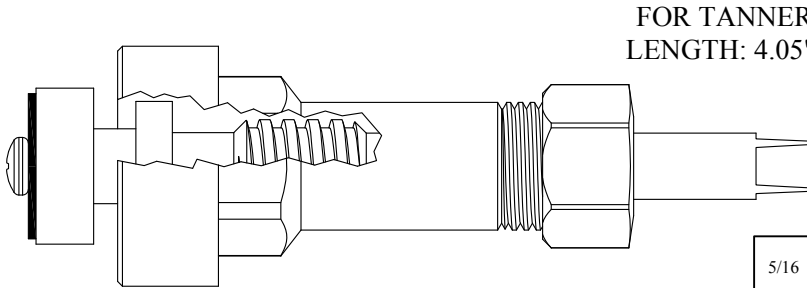

FOR TANNER
LENGTH: 4.05"

5/16
Tapered

470811
GASKET: 894860 INCLUDED



SEAT USED: LF648930

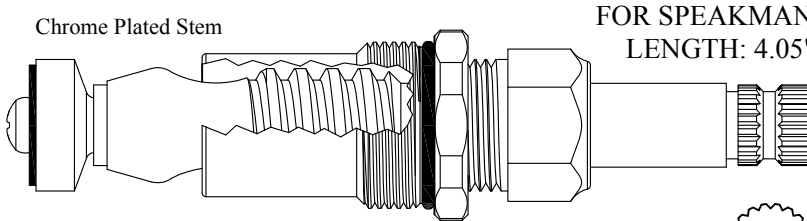

FOR SPEAKMAN
LENGTH: 4.05"

20
2-4

LF470101/ LF470102
LF270101/ LF270102 Stem Only
GASKET: 890180 O-RING INCLUDED



SEAT USED: LF648960

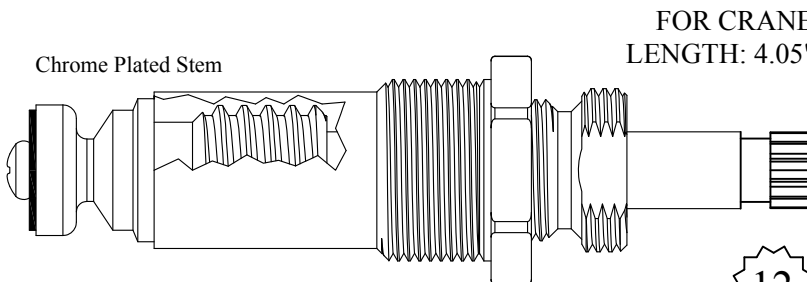

FOR CRANE
LENGTH: 4.05"

12
3-10

LF470211
GASKET: 895320



SEAT USED: LF648960

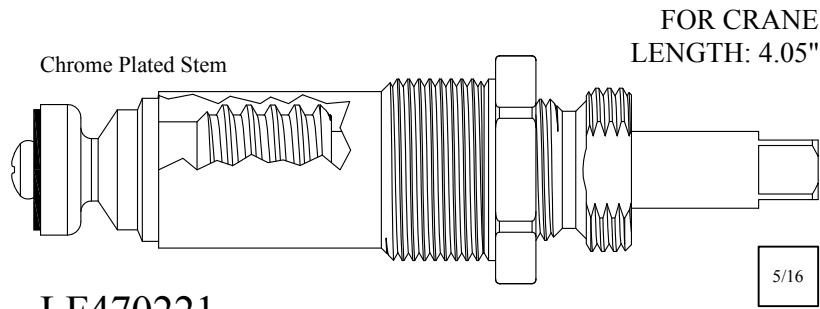

LF470221

GASKET: 895320

FOR CRANE
LENGTH: 4.05"

5/16



SEAT USED: LF648320

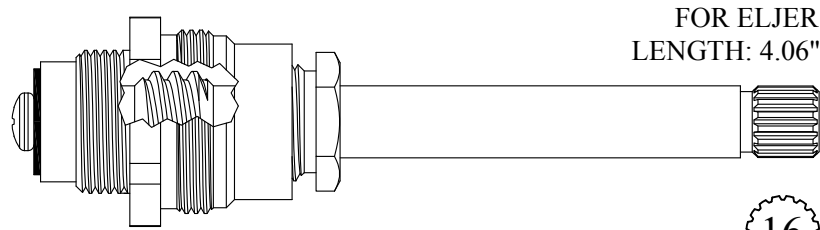

404211

204221 Stem Only

GASKET: 895100

FOR ELJER
LENGTH: 4.06"

16
3-15

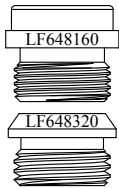

SEAT USED: LF648320 or LF648160

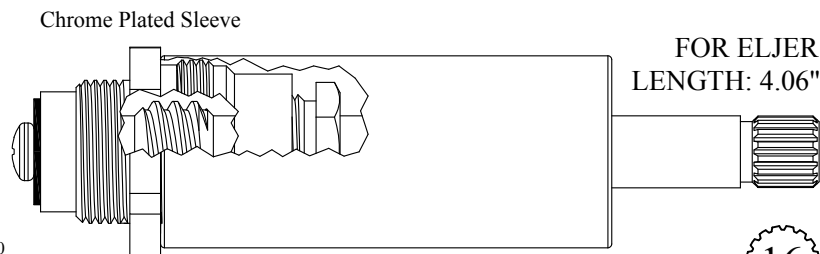

404221/ 404222

204221/ 204222 Stem Only

GASKET: 895100

FOR ELJER
LENGTH: 4.06"

16
3-15

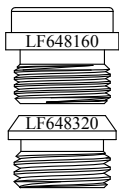

SEAT USED: LF648320 or LF648160

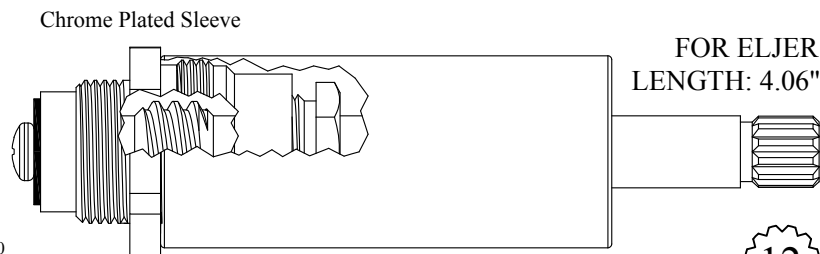

404241/ 404242

204241/ 204242 Stem Only

GASKET: 895100

FOR ELJER
LENGTH: 4.06"

12
1-2

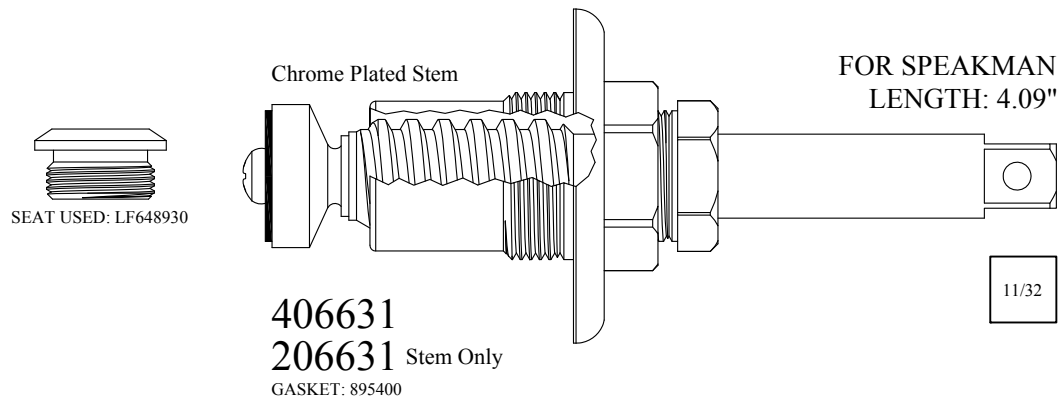
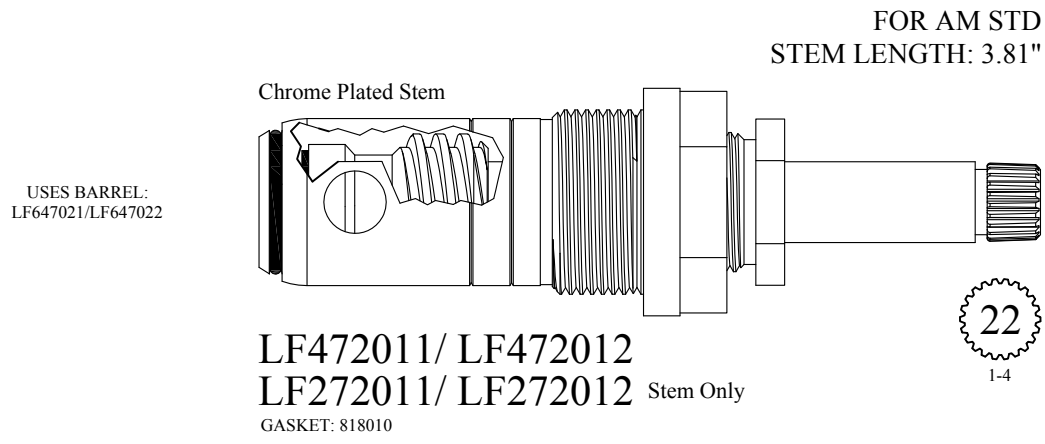
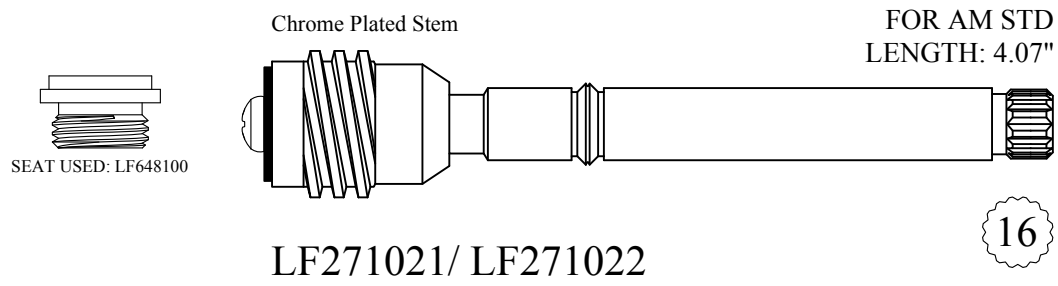
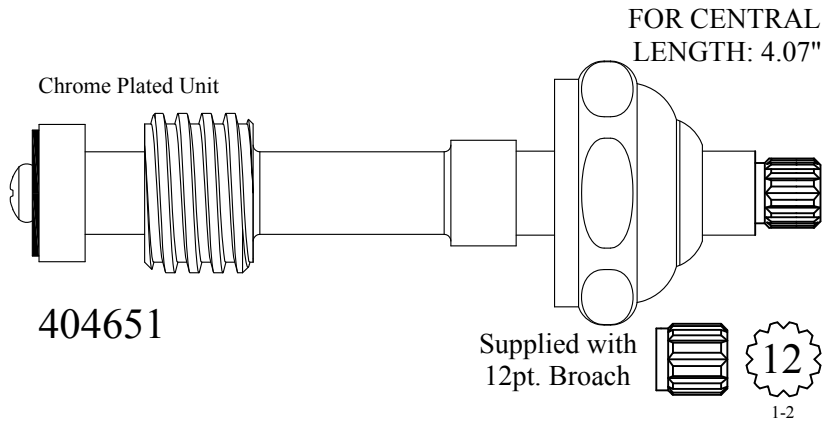

Old Style - Automatic with Brass Link

FOR ROHL
FOR GERBER
FOR DANFOSS
FOR TEMPRESS
LENGTH: 4.09"

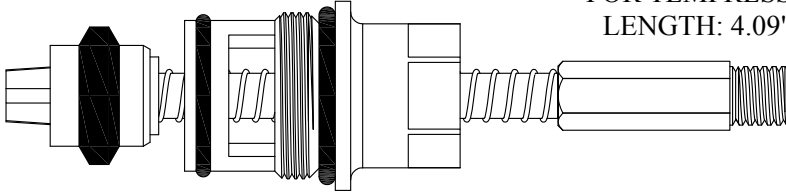

431130

GASKET: 894120 O-RING INCLUDED

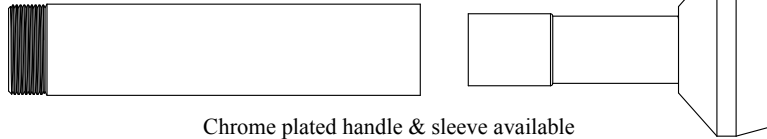

Chrome plated handle & sleeve available

128540

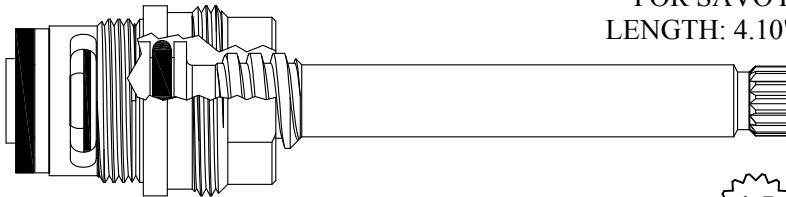

FOR SAVOY
LENGTH: 4.10"

403341

GASKET: 895400
SEAT INCLUDED: LF648850

Also available with monel seat 648850-M

403341-M

15
1-13

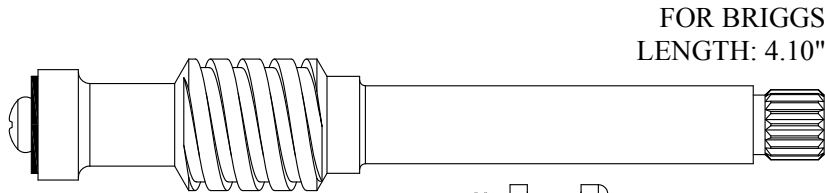

FOR BRIGGS
LENGTH: 4.10"

LF271011/ LF271012

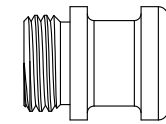

SEAT USED: LF648250

18
3-3

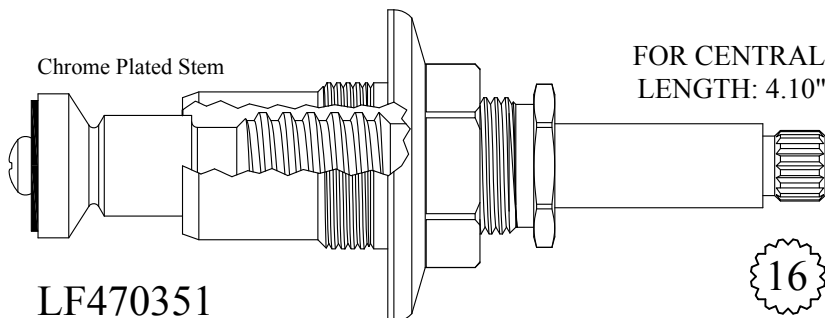

Chrome Plated Stem

FOR CENTRAL
LENGTH: 4.10"

LF470351

GASKET: 895410

16
1-6

Chrome Plated Push Button

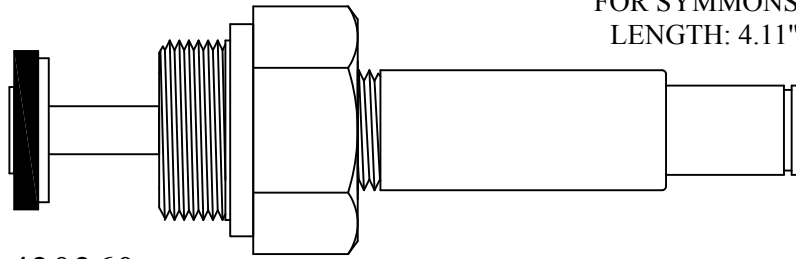

FOR SYMMONS
LENGTH: 4.11"

430360

GASKET: 895350 INCLUDED

FOR MUELLER
LENGTH: 4.12"

Chrome Plated Unit

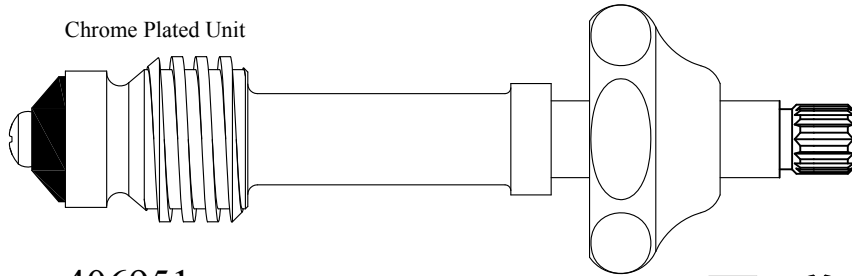

406951

206951 Stem Only

Supplied with
12pt. Broach

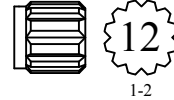

1-2

Chrome Plated Stem



SEAT USED: LF649430

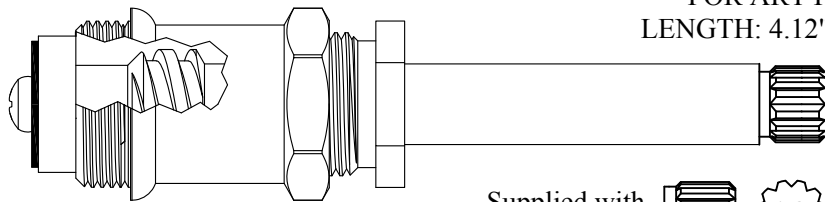

FOR ART F
LENGTH: 4.12"

Supplied with
12pt. Broach

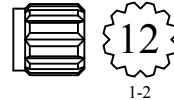

1-2

404661/ 404662

204661/ 204662 Stem Only

GASKET: 895400

Chrome Plated Stem

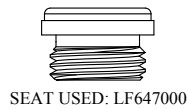

SEAT USED: LF647000

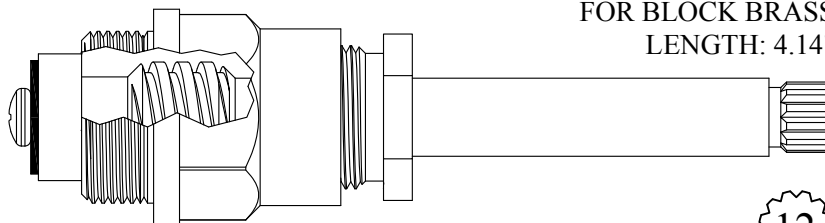

FOR BLOCK BRASS
LENGTH: 4.14"



1-2

404751/ 404752

204751/ 204752 Stem Only

GASKET: 895290

Chrome Plated Stem

FOR SPEAKMAN
LENGTH: 4.14"

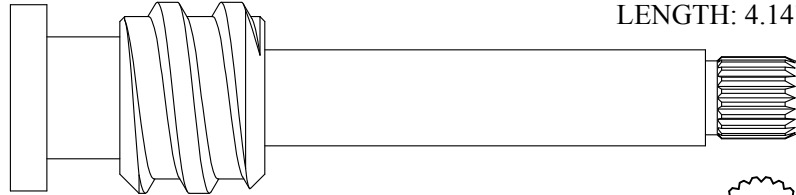

204511

20
2-4

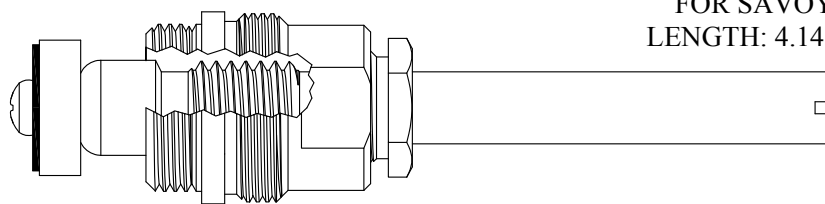

FOR SAVOY
LENGTH: 4.14"

405521

GASKET: 895400

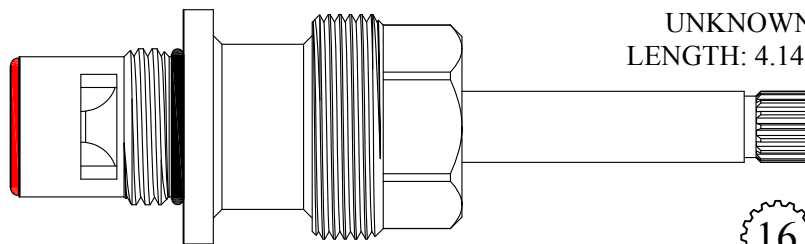

UNKNOWN
LENGTH: 4.14"

404301/ 404302

GASKET: 890170 O-RING INCLUDED
SEAL: 898580-R/B
DISC SET: 151380-PKG

16
3-16

Chrome Plated Stem

FOR BLOCK BRASS
LENGTH: 4.14"

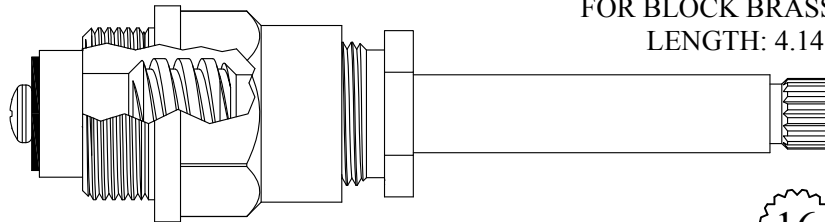

404701/ 404702

204701/ 204702 Stem Only

GASKET: 895290

16
1-6

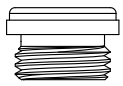

SEAT USED: LF647000

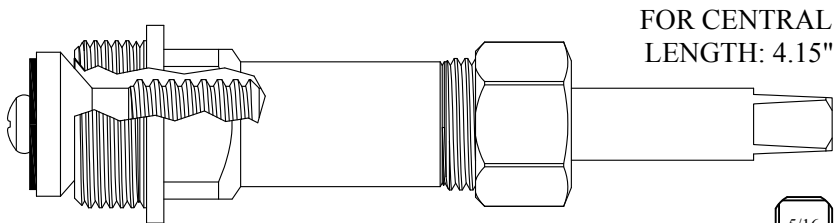

470771

GASKET: 895400

5/16

TAPERED



SEAT USED: LF648260

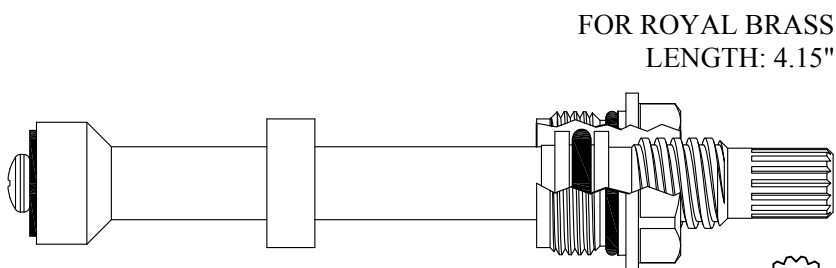

LF470301/ LF470302

GASKET: 890160 O-RING INCLUDED

16

1-6

CERAMIN CONVERSION FOR BROADWAY COMPRESSION
LENGTH: 4.16"

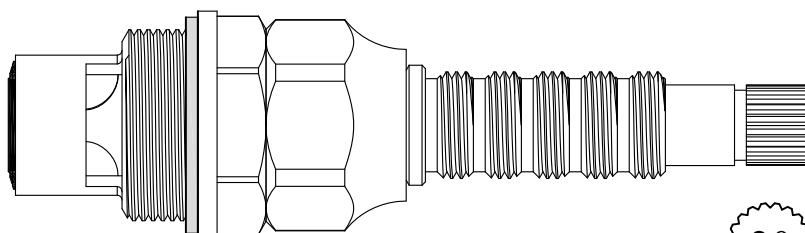

404621

GASKET INCLUDED: 895550

SEAL: 898510

DISC SET: 151380-PKG

20

2-4



SEAT USED: LF648130

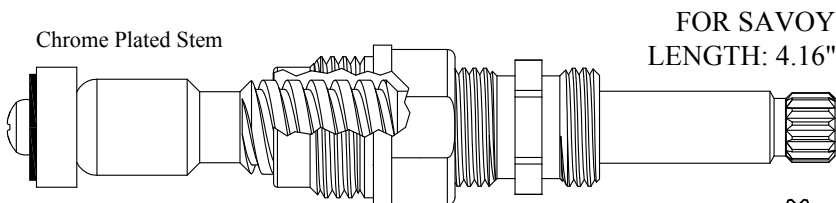

LF469011/ LF469012

LF269011/ LF269012 Stem Only

GASKET: 895100

15

1-13

FOR BRIGGS
LENGTH: 4.17"

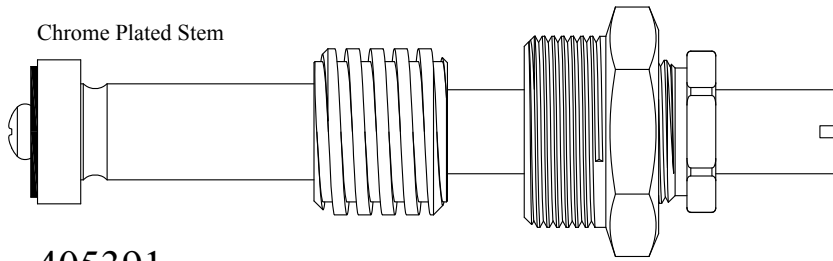

405391
205391 Stem Only
GASKET: 895340

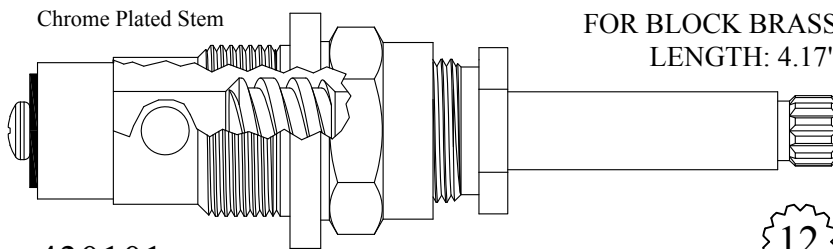

FOR BLOCK BRASS
LENGTH: 4.17"

430101
230101 Stem Only
GASKET: 895290

12
1-2

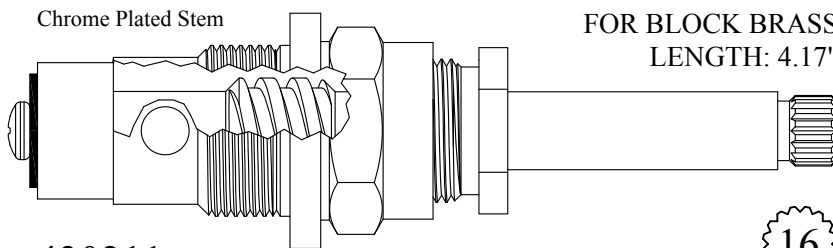

FOR BLOCK BRASS
LENGTH: 4.17"

430211
230211 Stem Only
GASKET: 895290

16
1-6

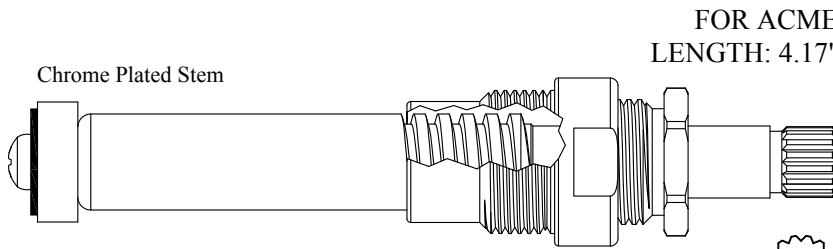

FOR ACME
LENGTH: 4.17"

LF469801
LF269801 Stem Only
GASKET: 895100

16
1-6

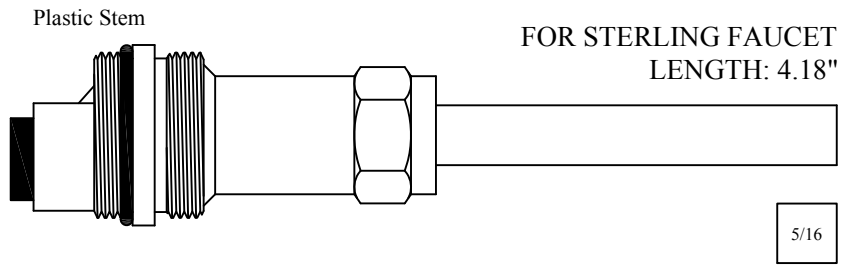

404810
204810 Stem Only
 GASKET: 890190 O-RING INCLUDED

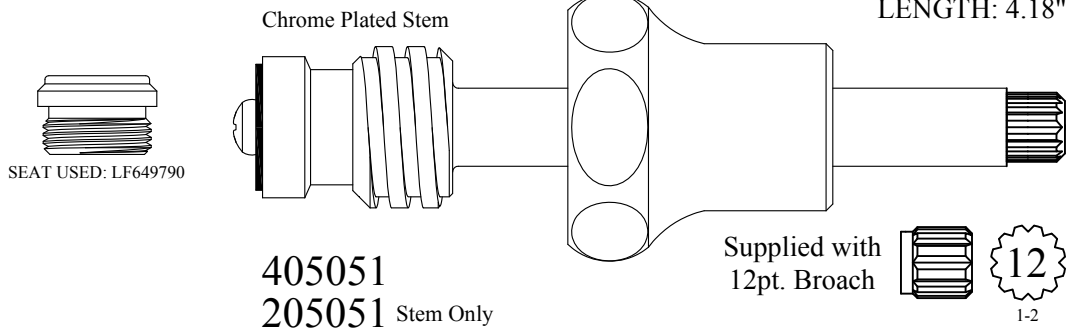

405051
205051 Stem Only

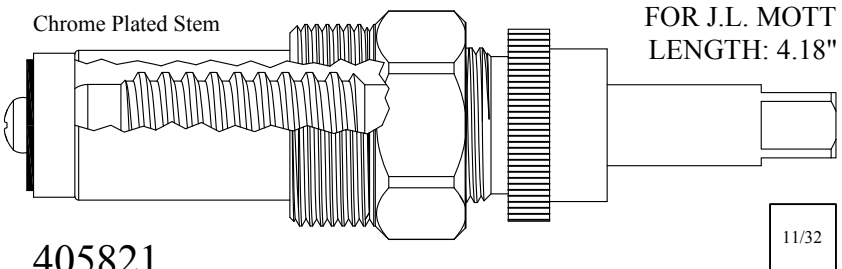

405821
205821 Stem Only
 GASKET: 895160

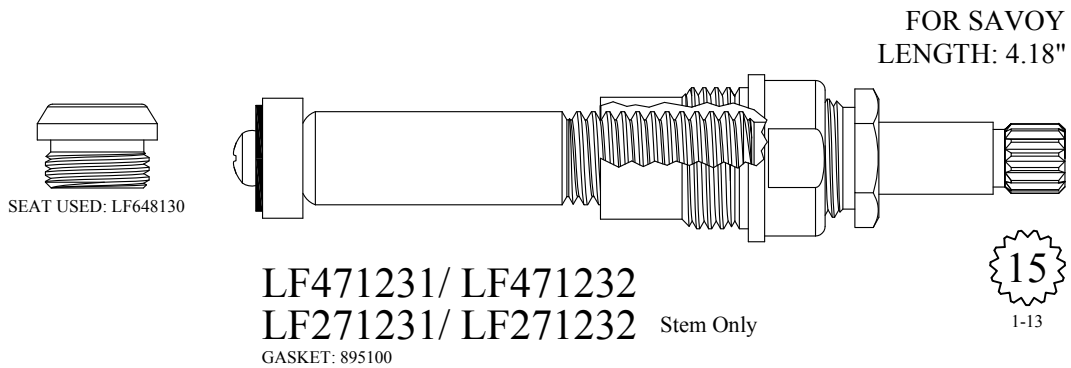

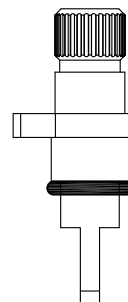
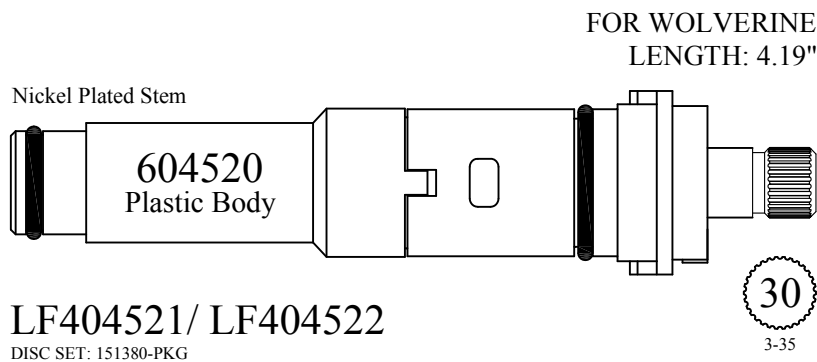
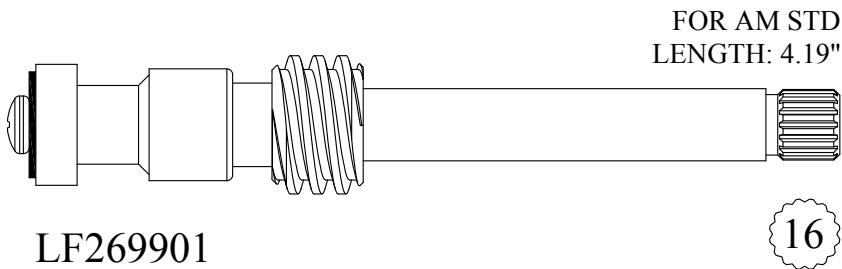
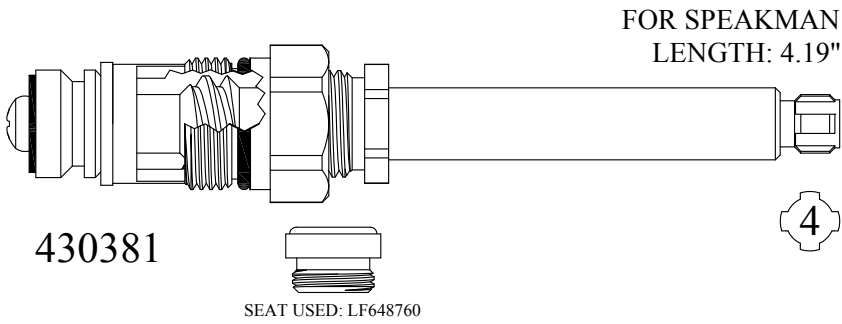
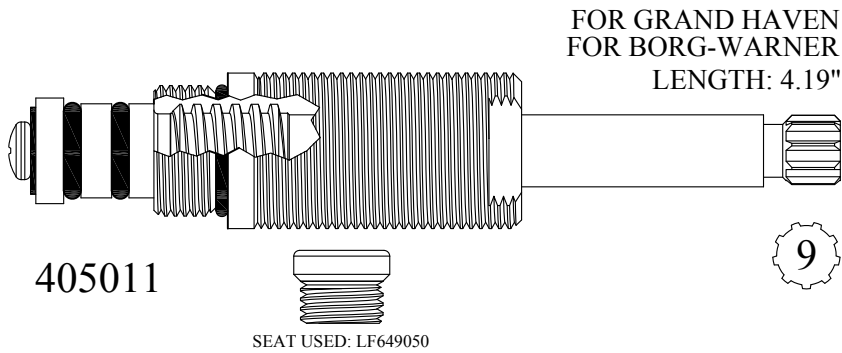

Available: Stem Only
LF263321
LF263322
 Also available as
 a RH/LH Kit
LF404521-2
 Kit includes:
 (1) 263321
 (1) 263322
 (1) 604520

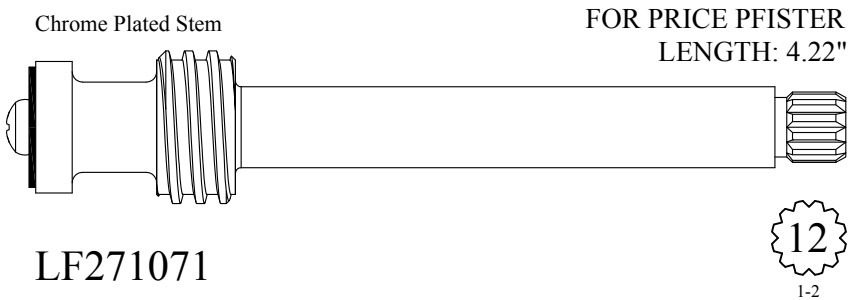
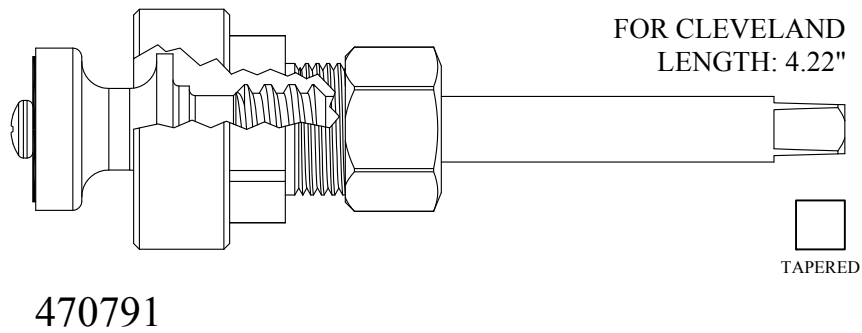
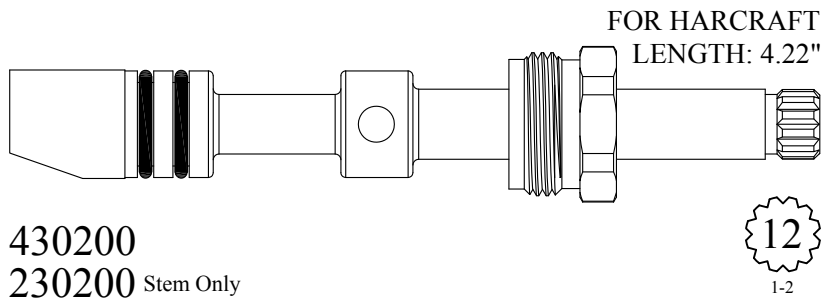
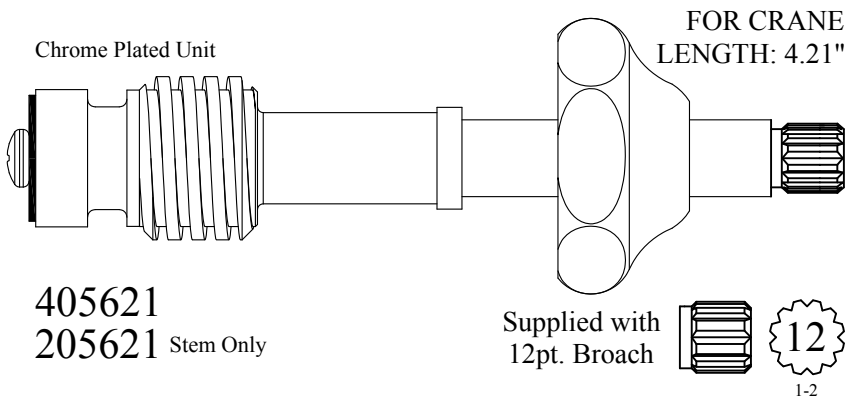

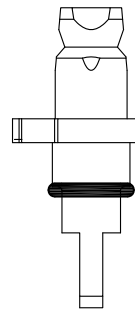
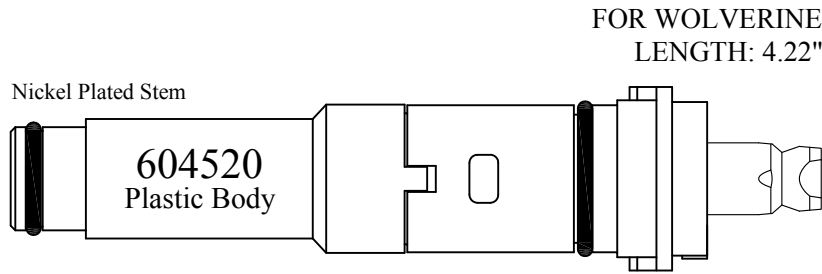

Available: Stem Only
LF263361
LF263362

Also available as
 a RH/LH Kit
LF404531-2

Kit includes:
 (1) 263361
 (1) 263362
 (1) 604520

LF404531/ LF404532
 DISC SET: 151380-PKG

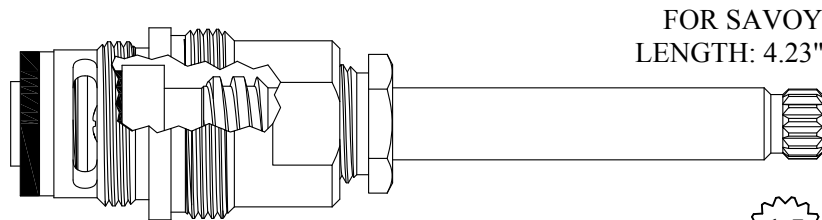

15
 1-13

403311 Also available with monel seat LF648850-M
 GASKET: 895400SEAT
 INCLUDED: LF648850

403311-M

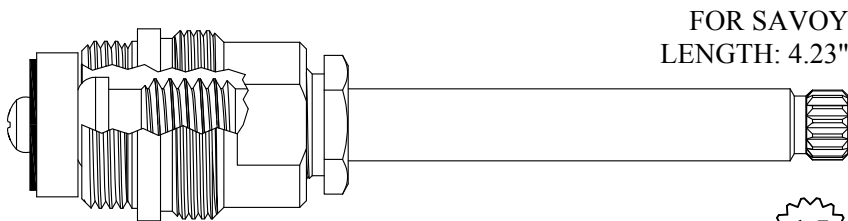

15
 1-13

405631
205631 Stem Only
 GASKET: 895400

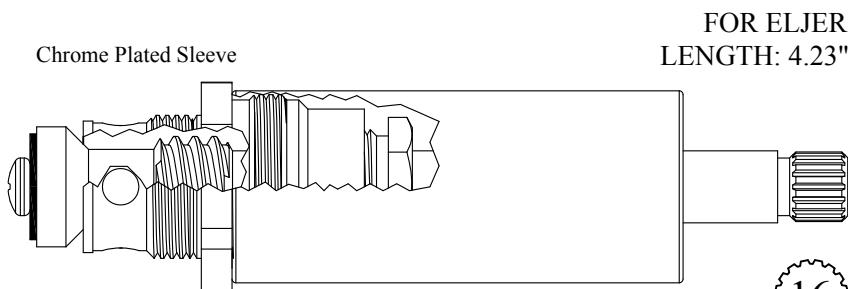

16
 3-15

430221
230221 Stem Only
 GASKET: 895100

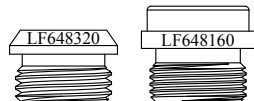

SEAT USED: LF648320 or LF648160

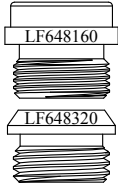

SEAT USED: LF648320 or LF648160

Chrome Plated Sleeve

FOR ELJER
LENGTH: 4.23"

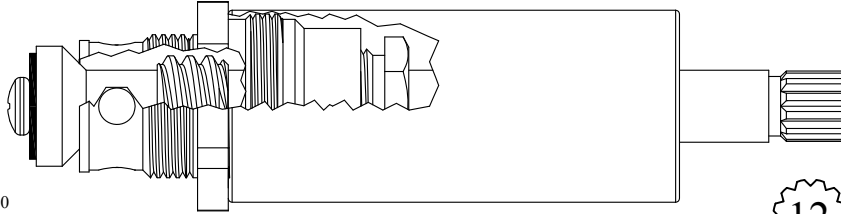

430341
230341 Stem Only
GASKET: 895100



1-2

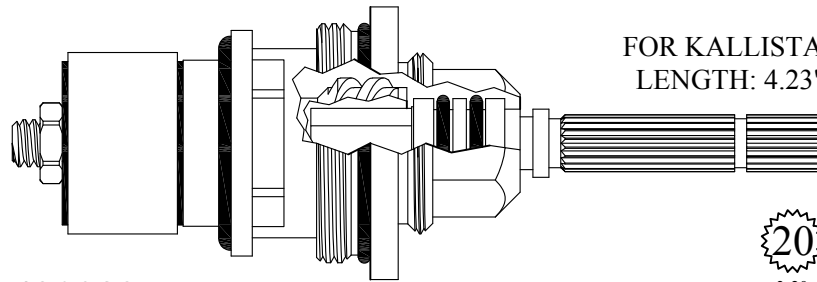

FOR KALLISTA
LENGTH: 4.23"

430982
GASKET: 890210 O-RING INCLUDED



3-20



SEAT USED: LF649050

FOR BORG-WARNER
LENGTH: 4.23"

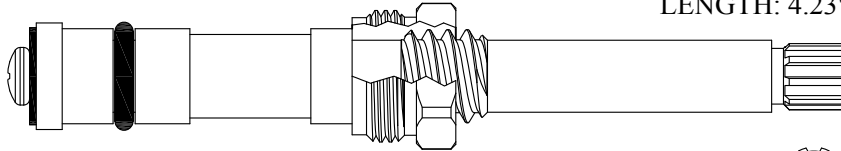

LF470801



SEAT USED: 648370

FOR PRICE PFISTER
LENGTH: 4.24"

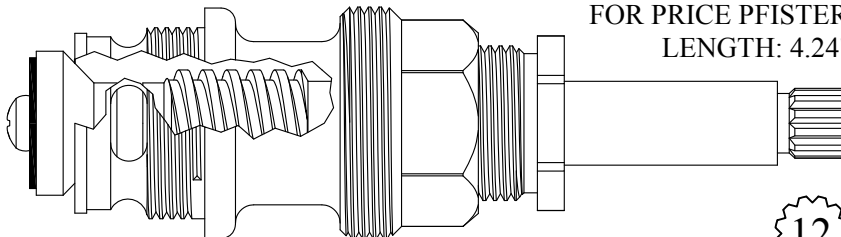

430301
230301 Stem Only
GASKET: 895550



1-2

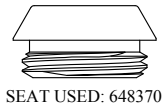

SEAT USED: 648370

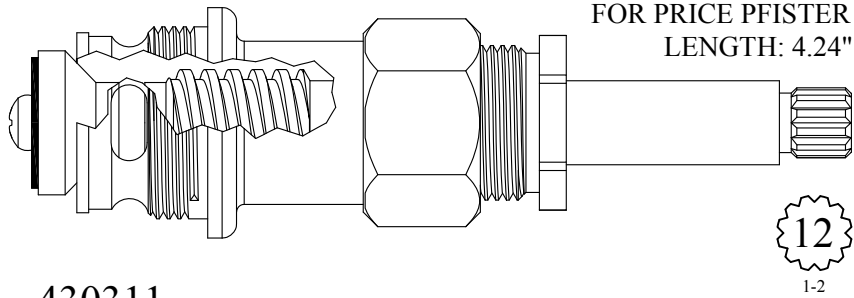

FOR PRICE PFISTER
LENGTH: 4.24"

430311
230301 Stem Only
GASKET: 895550



1-2

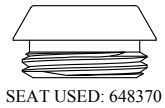

SEAT USED: 648370

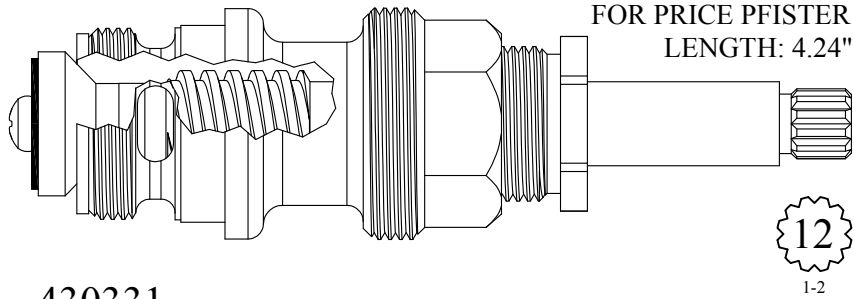

FOR PRICE PFISTER
LENGTH: 4.24"

430331
230301 Stem Only
GASKET: 895560



1-2

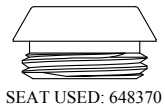

SEAT USED: 648370

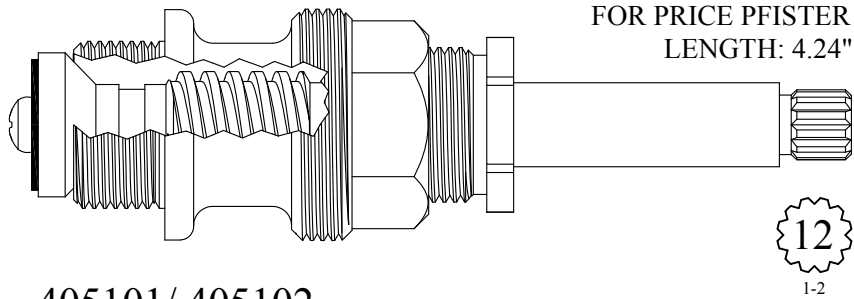

FOR PRICE PFISTER
LENGTH: 4.24"

405101/ 405102
205101/ 205102 Stem Only
GASKET: 895400



1-2

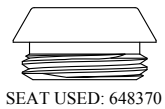

SEAT USED: 648370

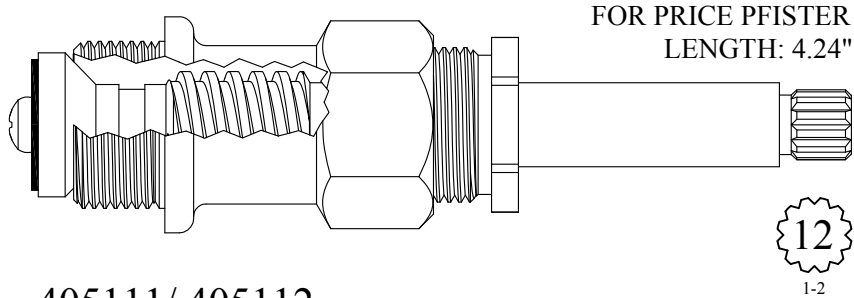

FOR PRICE PFISTER
LENGTH: 4.24"

405111/ 405112
205101/ 205102 Stem Only
GASKET: 895400



1-2

CERAMIC CONVERSION FOR KOHLER TREND
 LENGHT: 4.24"

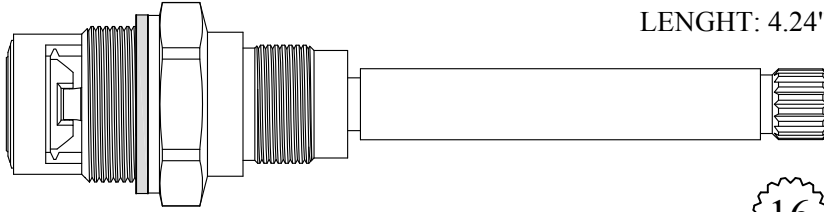

16
 1-6

404821/ 404822

GASKET: 895150 INCLUDED
 SEAL: 898510-W
 DISC SET: 151380-PKG

Chrome Plated Stem / Plastic Plunger

FOR KOHLER
 LENGTH: 4.24"

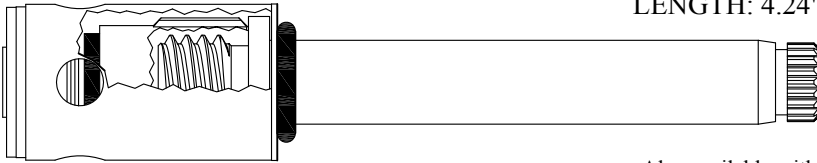

19
 1-7

LF470701/ LF470702
 LF270701/ LF270702 Stem Only
 SEAT INCLUDED: LF649460

Also available with Brass Plunger
 LF470701-B / LF470702-B

Also available with Brass Plunger &
 Polished Gold stem

LF470701-PG / LF470702-PG
 LF270701-PG / LF270702-PG Stem Only

Chrome Plated Stem / Plastic Plunger

FOR KOHLER
 LENGTH: 4.24"

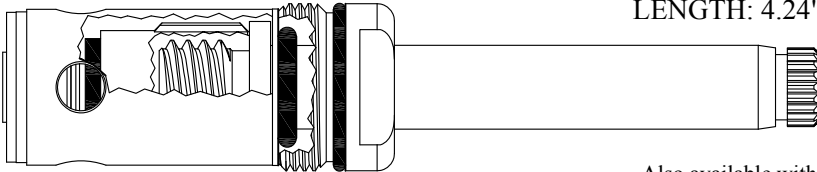

19
 1-7

LF470711/ LF470712
 LF270701/ LF270702 Stem Only
 GASKET: 890180 O-RING INCLUDED
 SEAT INCLUDED: LF649460

Also available with Brass Plunger
 LF470711-B / LF470712-B

Also available with Brass Plunger &
 Polished Gold stem

LF470711-PG / LF470712-PG
 LF270701-PG / LF270702-PG Stem Only

Chrome Plated Stem / Plastic Plunger

FOR KOHLER
 LENGTH: 4.24"

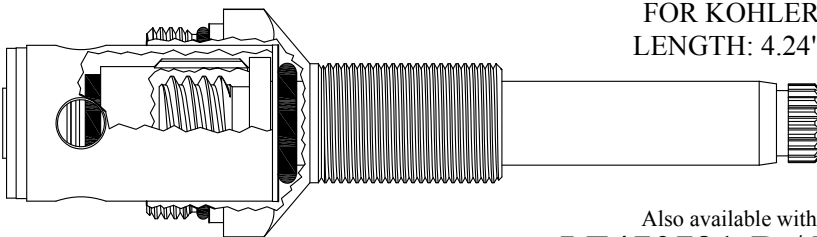

19
 1-7

LF470721/ LF470722
 LF270701/ LF270702 Stem Only
 GASKET: 890200 O-RING INCLUDED
 SEAT INCLUDED: LF649460

Also available with Brass Plunger
 LF470721-B / LF470722-B

Also available with Brass Plunger &
 Polished Gold stem

LF470721-PG / LF470722-PG
 LF270701-PG / LF270702-PG Stem Only

Chrome Plated Escutcheon Tube #111460

FOR KOHLER
LENGTH: 4.25"



SEAT USED: LF648070

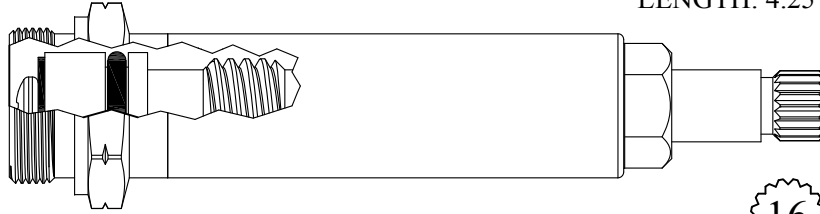

16
1-6

404201/ 404202
204201/ 204202 Stem Only
GASKET: 895150

Plastic Escutcheon Nipple #119040

FOR KOHLER
LENGTH: 4.25"



SEAT USED: LF648070

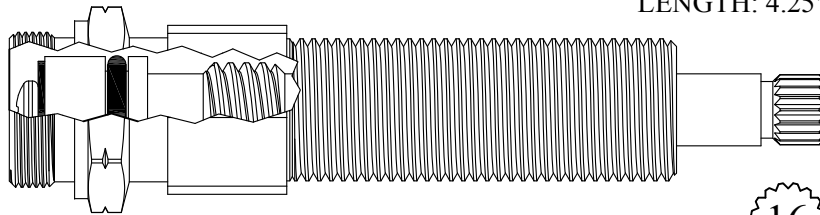

16
1-6

404231/ 404232
204201/ 204202 Stem Only
GASKET: 895150

Chrome Plated Escutcheon Tube #111460

FOR KOHLER
LENGTH: 4.25"



SEAT USED: LF648070

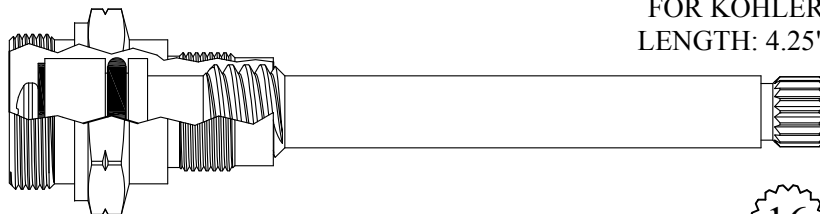

16
1-6

404331/ 404332
204201/ 204202 Stem Only
GASKET: 895150

CERAMIC CONVERSION FOR KOHLER LF470701/2
Chrome Plated Stem
LENGTH: 4.25"

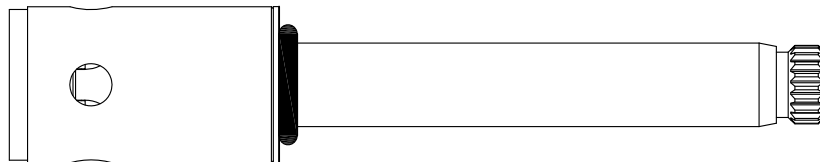

19
1-7

LF470741/ LF470742
DISC SET: 151380-PKG

Also available with a Polished Gold Stem
LF470741-PG / LF470742-PG



FOR SAYCO
LENGTH: 4.25"

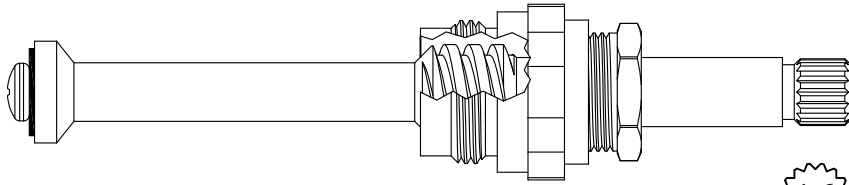

LF470951/ LF470952
LF270951/ LF270952 Stem Only
GASKET: 895100



Chrome Plated Stem

FOR AM STD
LENGTH: 4.26"

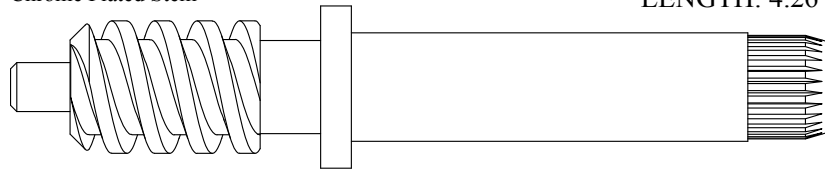

205731



Chrome Plated Stem

FOR PACIFIC
LENGTH: 4.26"

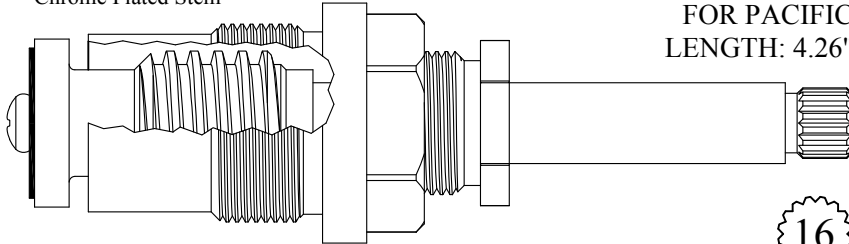

405921
205921 Stem Only
GASKET: 895540



USES BARREL:
LF647021/LF647022

FOR AM STD
STEM LENGTH: 4.00"

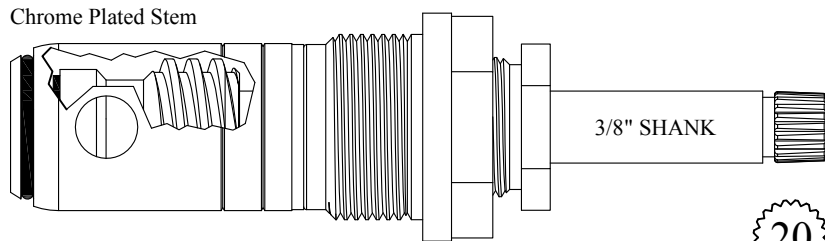

LF470201/ LF470202
LF270201/ LF270202 Stem Only
GASKET: 818010



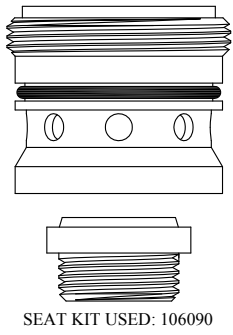

205511 Stem Only
GASKET: 895500 INCLUDED

FOR ZURN
FOR SYMMONS
LENGTH: 4.27"



Symmons Small

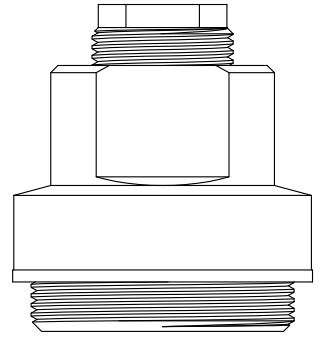

Also available with
bonnet assembly
#105671
405511



405811
205811 Stem Only
GASKET: 895100

FOR BURLINGTON
LENGTH: 4.27"



1-6

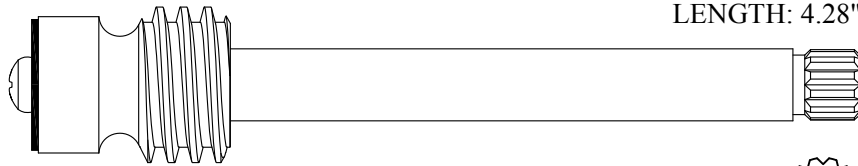

205661

FOR AM STD
LENGTH: 4.28"



1-2

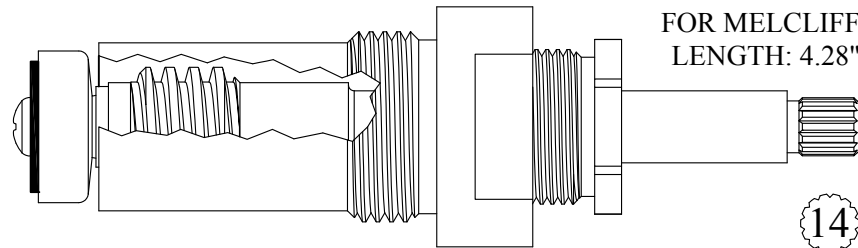

405311
205311 Stem Only
GASKET: 895550

FOR MELCLIFF
LENGTH: 4.28"



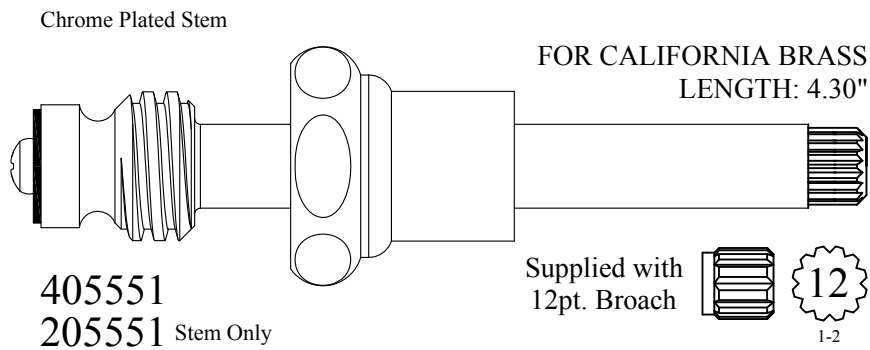
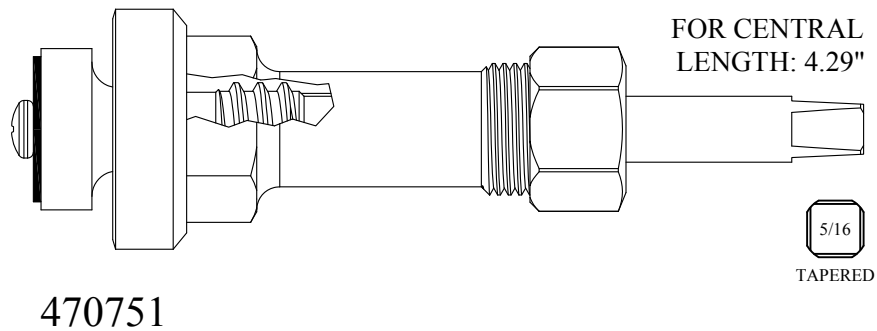
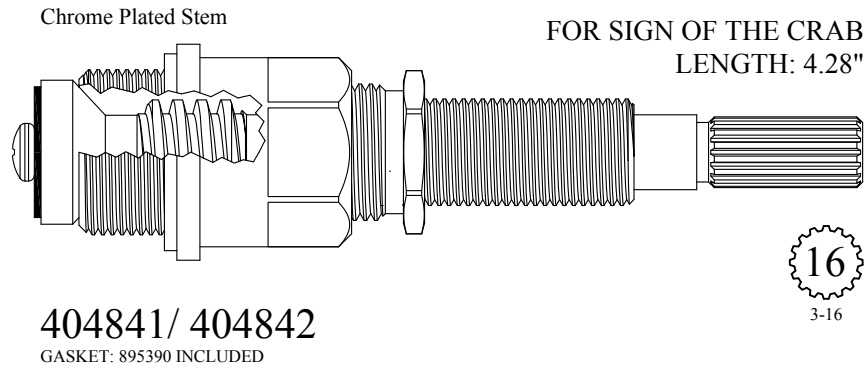
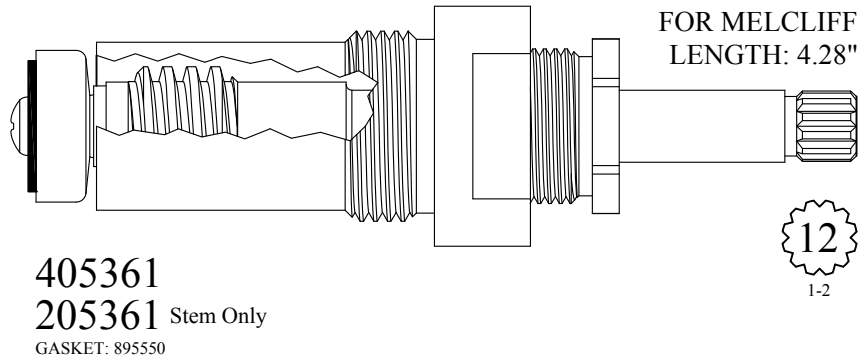

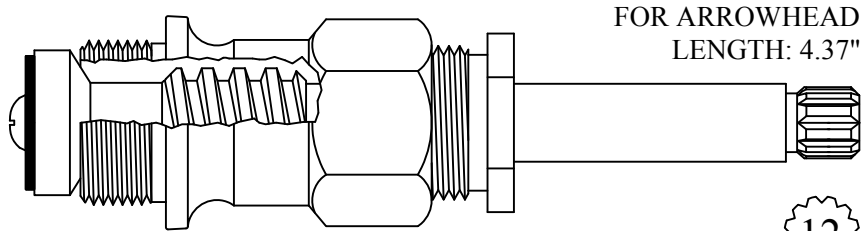

FOR ARROWHEAD
LENGTH: 4.37"

12
1-2

406411 Not Available, Use 415501
LENGTH: 5.15"

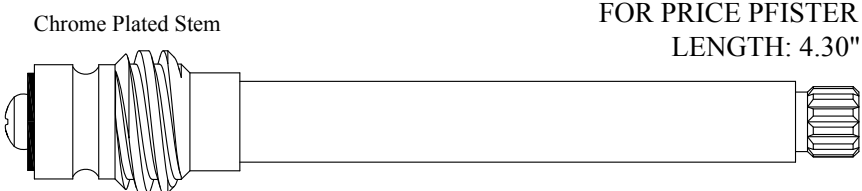

Chrome Plated Stem

FOR PRICE PFISTER
LENGTH: 4.30"

LF272031/ LF272032



SEAT USED: LF648270

12
1-2

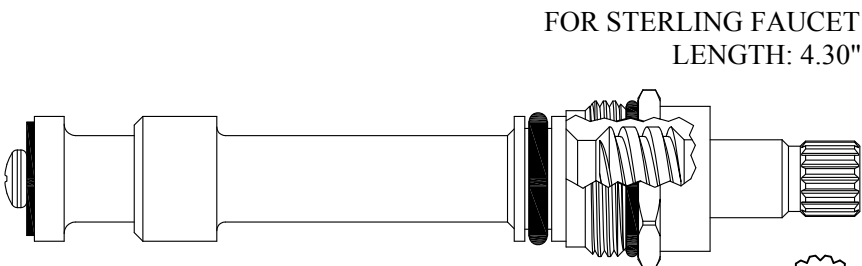

FOR STERLING FAUCET
LENGTH: 4.30"



SEAT USED: LF648170

LF471001/ LF471002

GASKET: 890170 O-RING INCLUDED

16
1-5

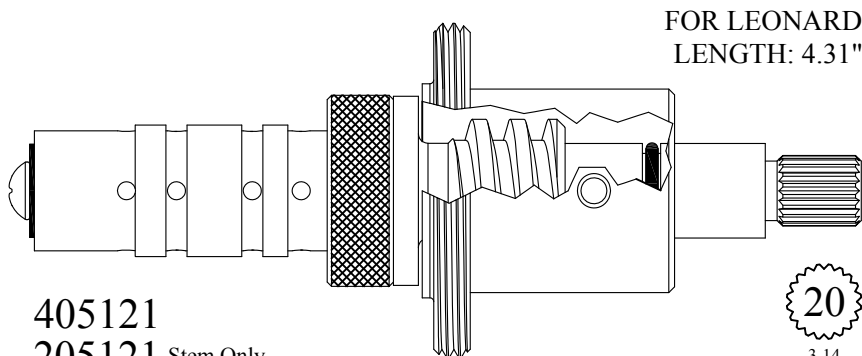

FOR LEONARD
LENGTH: 4.31"

405121
205121 Stem Only

20
3-14

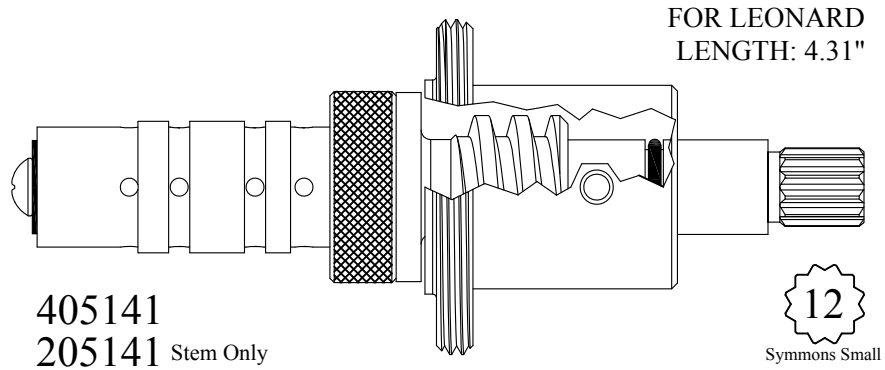

405141
205141 Stem Only

12
Symmons Small

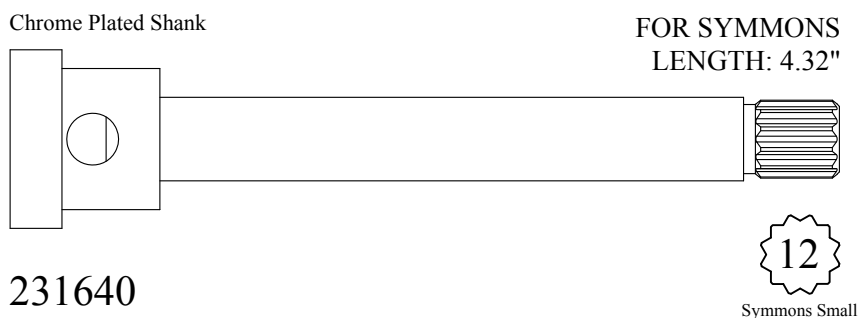

231640

12
Symmons Small

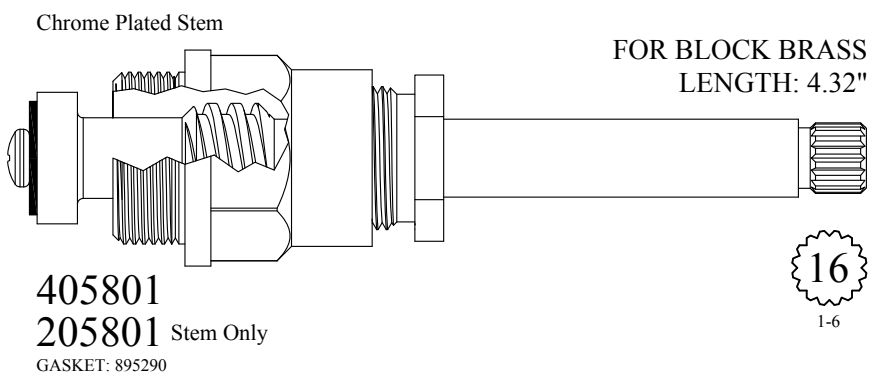
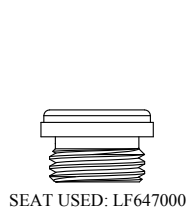

405801
205801 Stem Only
GASKET: 895290

16
1-6

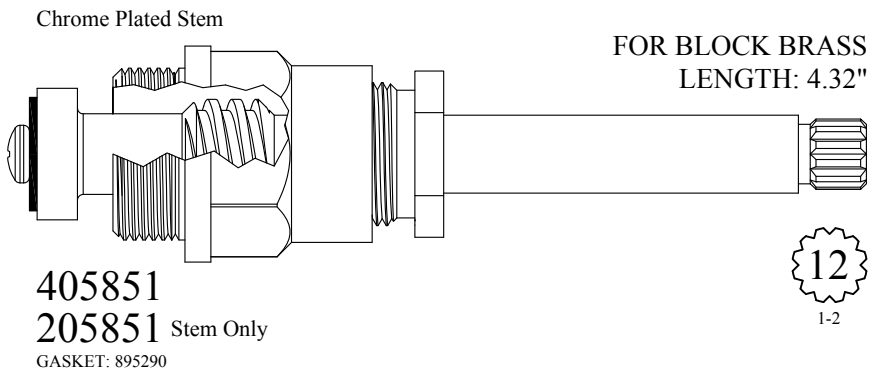
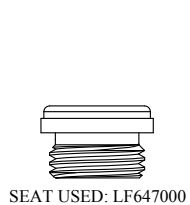

405851
205851 Stem Only
GASKET: 895290

12
1-2

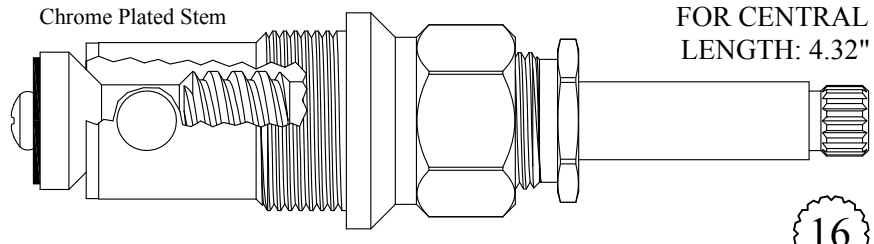

430401
230401 Stem Only
GASKET: 895370

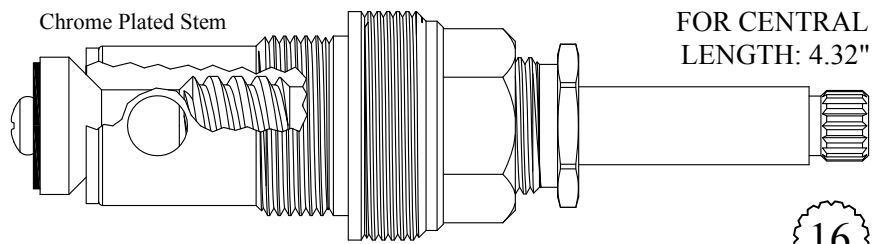

430411
230401 Stem Only
GASKET: 895370



Chrome Plated Shank & Pkg Nut

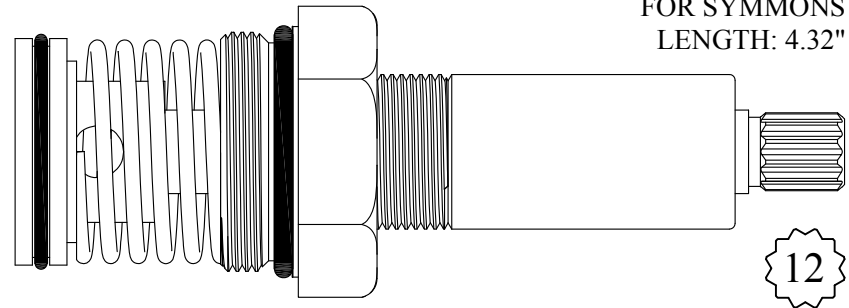

431160
231160 Stem Only
GASKET: 891220 O-RING INCLUDED



Chrome Plated Shank & Pkg Nut

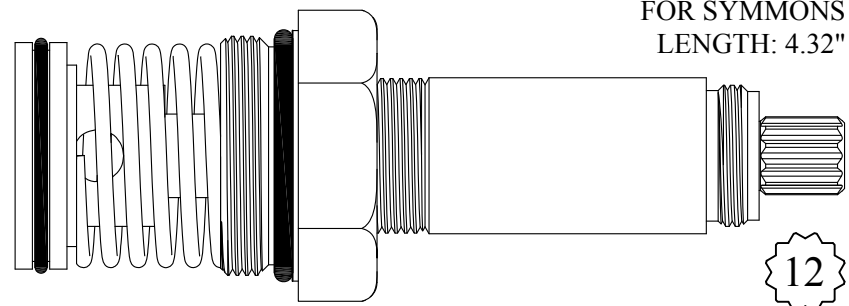

431170
231160 Stem Only
GASKET: 891220 O-RING INCLUDED



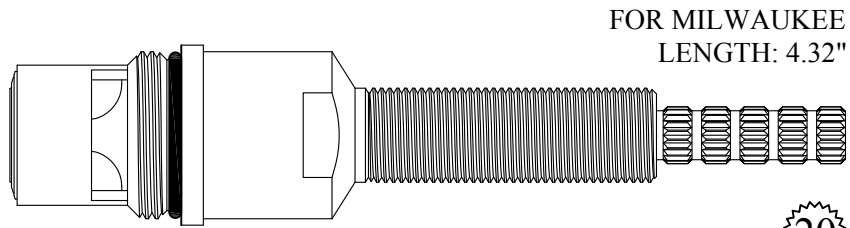

405191/ 405192

GASKET: 890170 O-RING INCLUDED
 SEAL: 898510-W
 DISC SET: 151380-PKG

20
 3-20

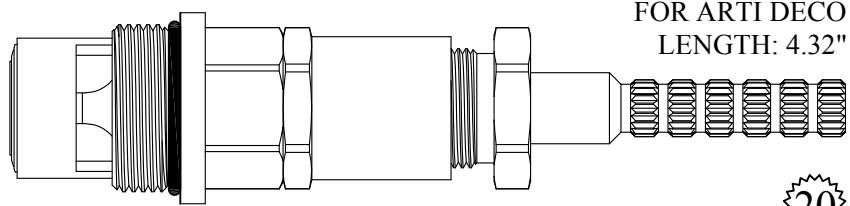

405221/ 405222

GASKET: 890170 O-RING INCLUDED
 SEAL: 898510-W
 DISC SET: 151380-PKG

20
 3-20

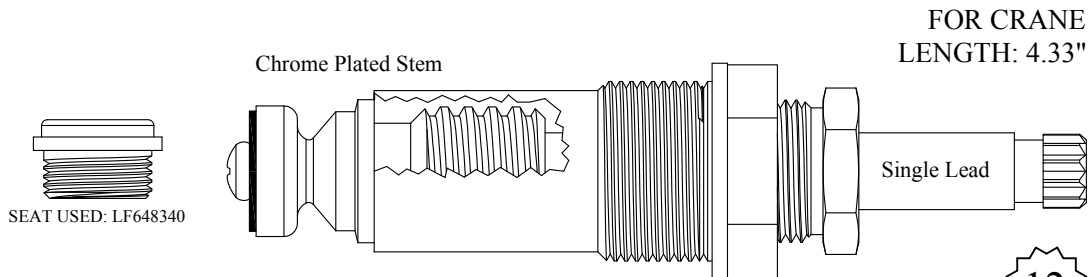

LF471041
LF271041 Stem Only

GASKET: 895370

12
 3-10

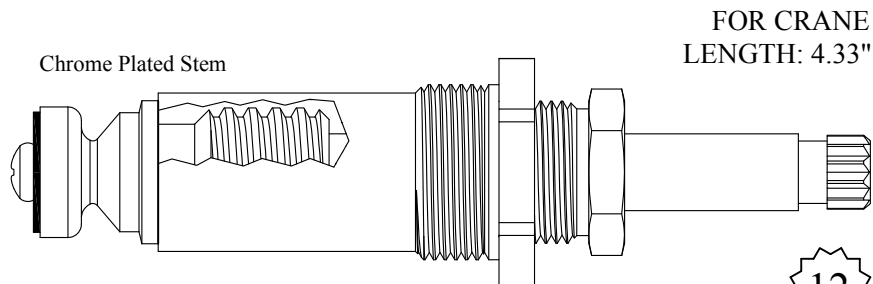

Not Available, Use LF471041

12
 3-10

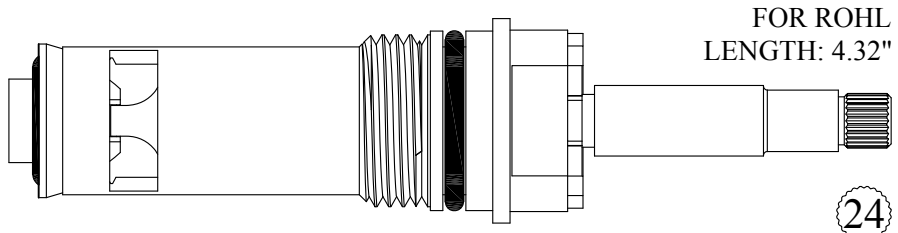

FOR ROHL
LENGTH: 4.32"

LF471401
SEAL: 898550
DISC SET: 151380-PKG

24



SEAT USED: LF648960

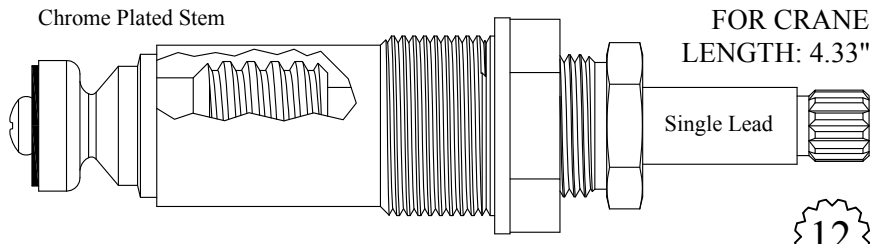

FOR CRANE
LENGTH: 4.33"

LF471121
LF271121 Stem Only
GASKET: 895370

12
1-2



SEAT USED: LF648960

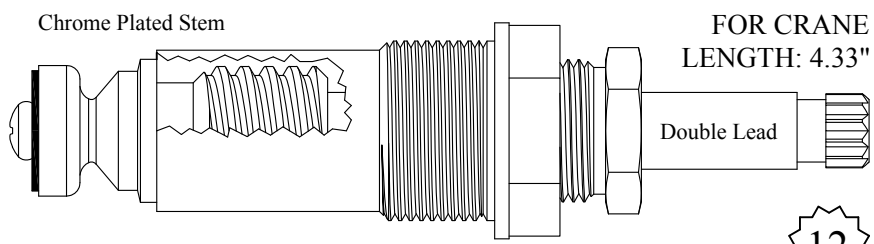

FOR CRANE
LENGTH: 4.33"

LF471141/ LF471142
LF271141/ LF271142 Stem Only
GASKET: 895370

12
3-10

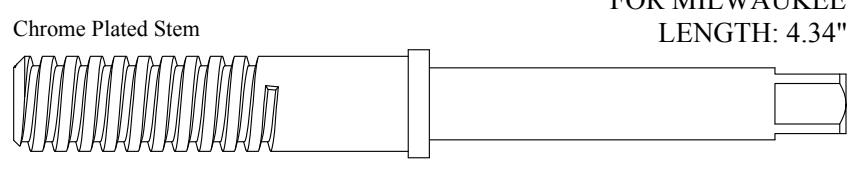

FOR MILWAUKEE
LENGTH: 4.34"

205212

5/16

Quadruple Lead
Chrome Plated Stem

FOR KOHLER
LENGTH: 4.34"

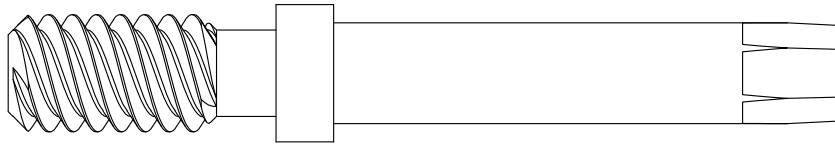

206161

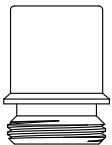
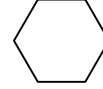

SEAT USED: LF649500

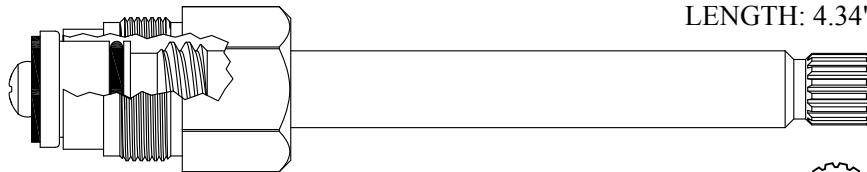

FOR MILWAUKEE
LENGTH: 4.34"

404901

GASKET: 199930

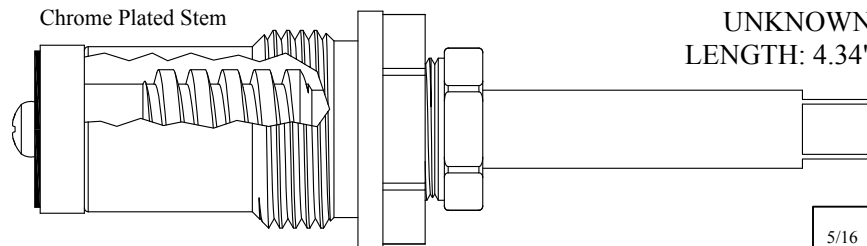

Chrome Plated Stem

UNKNOWN
LENGTH: 4.34"

405321

205321 Stem Only

GASKET: 895560

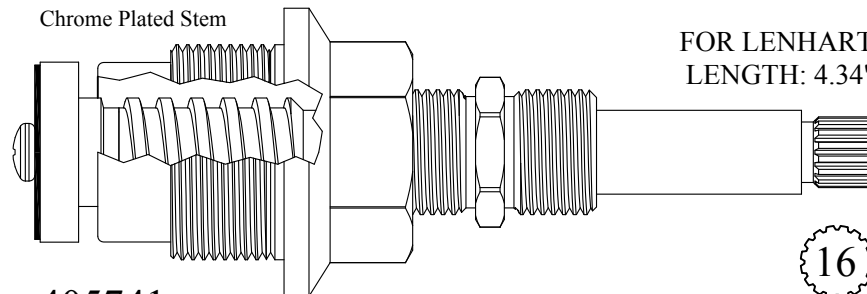

Chrome Plated Stem

FOR LENHART
LENGTH: 4.34"

405741

GASKET: 895450



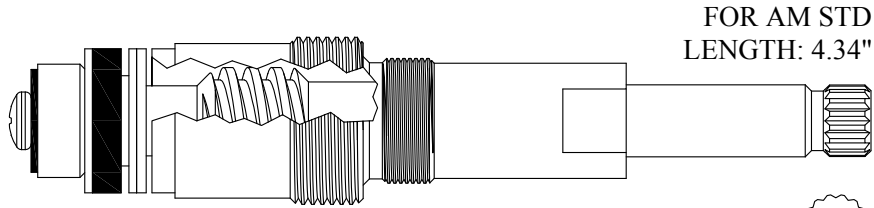

405701/ 405702
WAVE WASHER: 897110

16

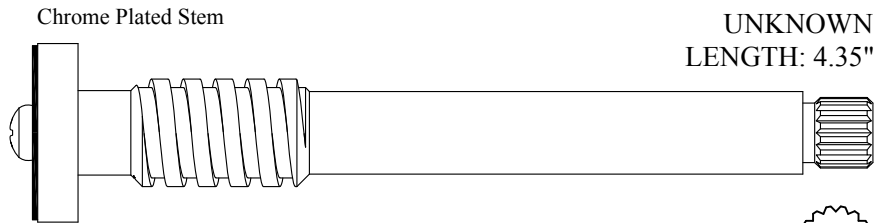

206211

16
1-6

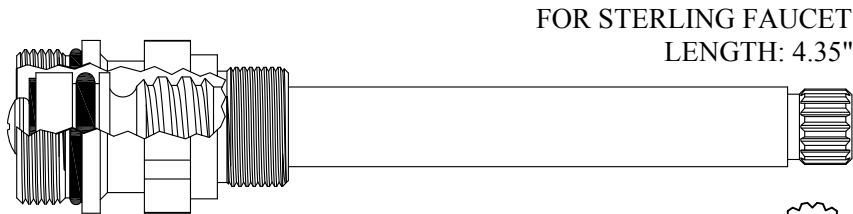

405181
GASKET: 890170 O-RING INCLUDED

16
1-5

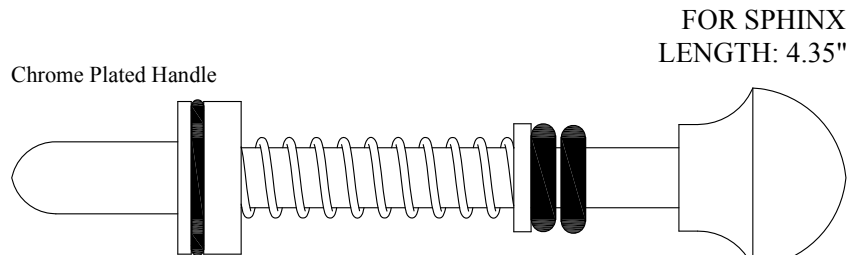

430240

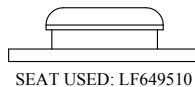

SEAT USED: LF647690

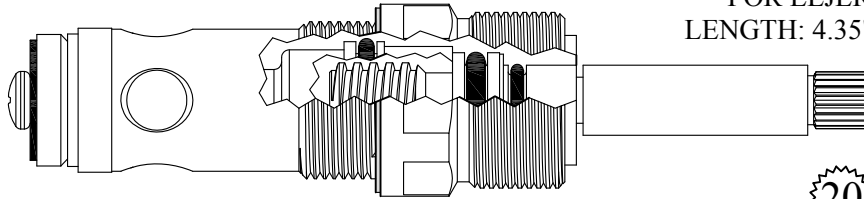

FOR ELJER
LENGTH: 4.35"

430552

GASKET INCLUDED: 895160



SEAT USED: LF648230

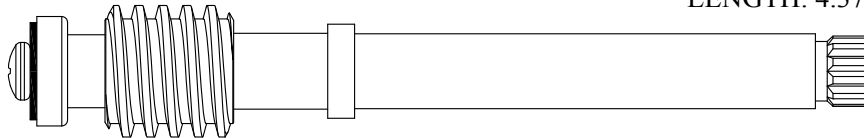

FOR ARROWHEAD
LENGTH: 4.37"

LF271101



SEAT USED: LF648170

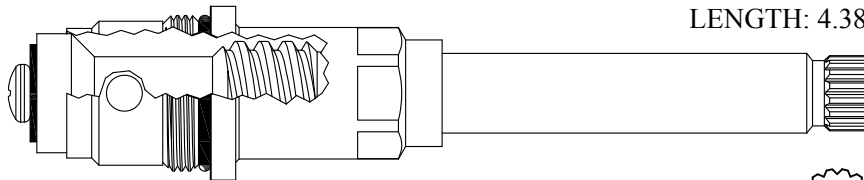

FOR STERLING FAUCET
LENGTH: 4.38"

430231

GASKET: 890170 O-RING INCLUDED



SEAT USED: LF648170

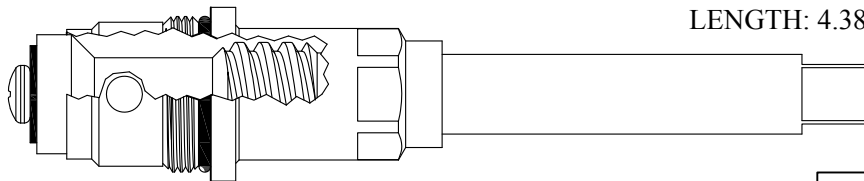

FOR STERLING FAUCET
LENGTH: 4.38"

430261

GASKET: 890170 O-RING INCLUDED



SEAT USED: LF648170

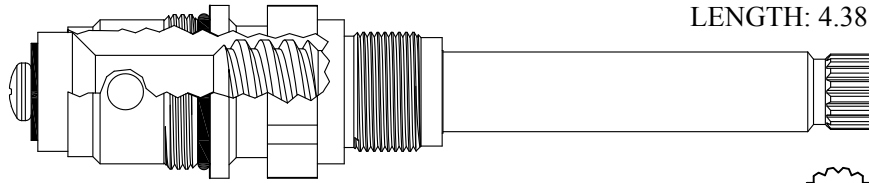
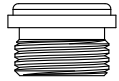

FOR STERLING FAUCET
LENGTH: 4.38"

430291

GASKET: 890170 O-RING INCLUDED



SEAT USED: LF648170

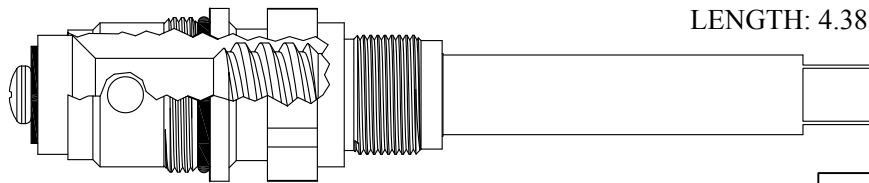
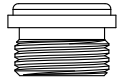

FOR STERLING FAUCET
LENGTH: 4.38"

430421

GASKET: 890170 O-RING INCLUDED



SEAT USED: LF649050

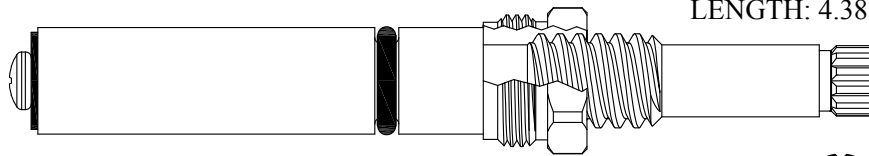

FOR BORG-WARNER
LENGTH: 4.38"

406311/ 406312



Chrome Plated Stem

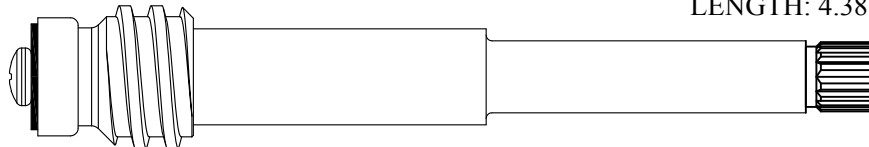

FOR MUELLER
LENGTH: 4.38"

LF271061

Supplied with
12pt. Broach



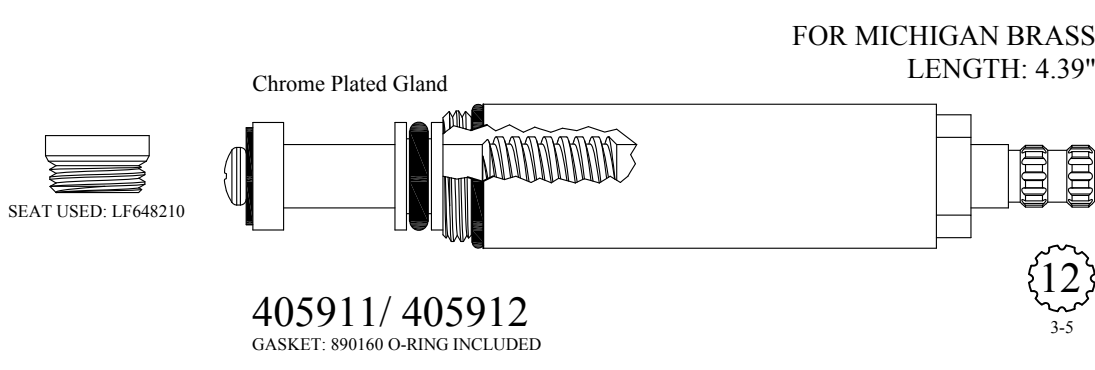
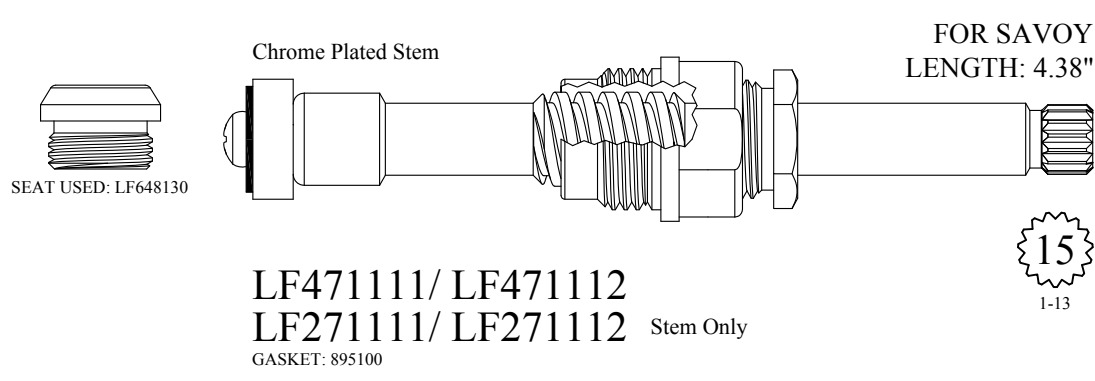
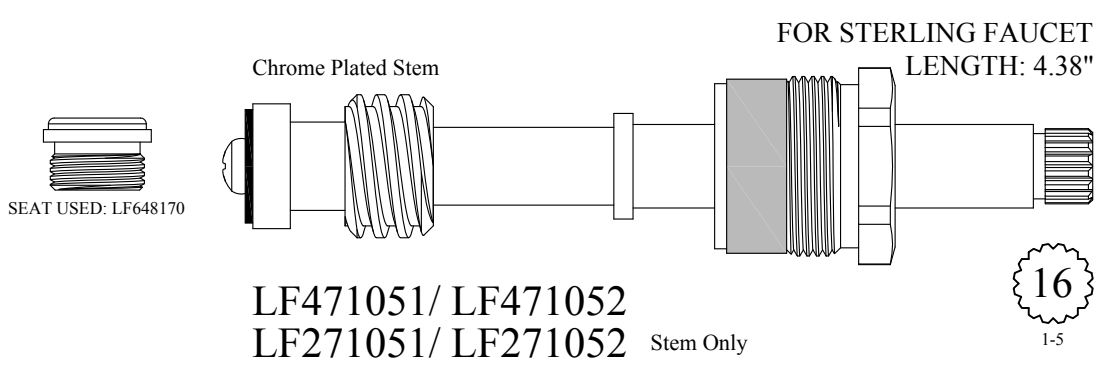

FOR KOHLER
LENGTH: 4.39"

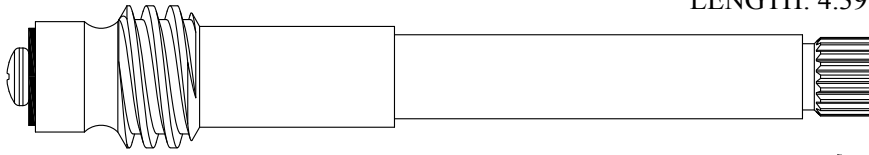

LF273361/ LF273362

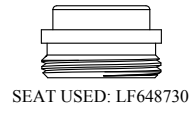

19
1-7

Chrome Plated Stem

UNKNOWN
LENGTH: 4.40"

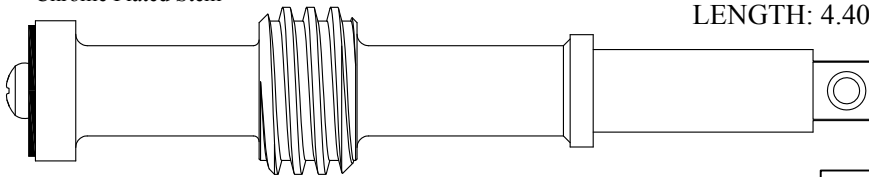

205831

5/16

FOR HARCRAFT
LENGTH: 4.40"



SEAT USED: LF648670

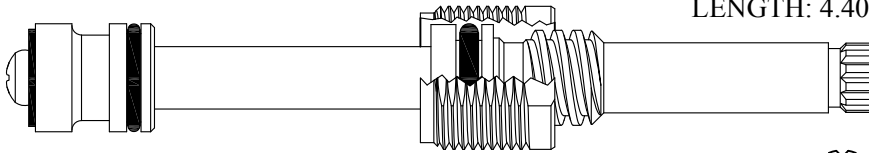

406001

GASKET: 895040 INCLUDED

12
1-2

FOR FEDERAL HUBER
LENGTH: 4.40"

Chrome Plated Stem

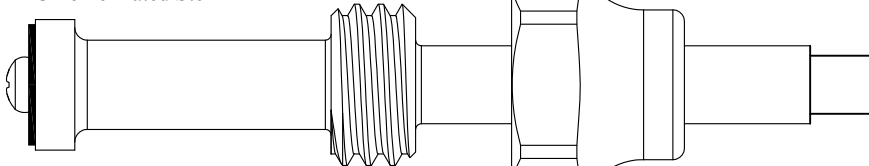

406351

206351 Stem Only

Supplied with
12pt. Broach



12
1-2

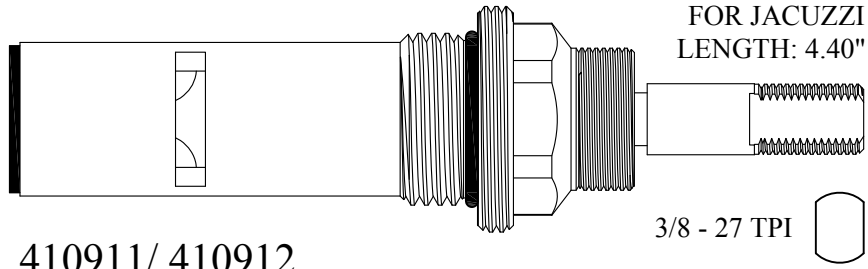

410911/ 410912

GASKET: 890190 O-RING INCLUDED
 SEAL: 898550
 DISC SET: 151380-PKG

3/8 - 27 TPI



SEAT USED: LF649200

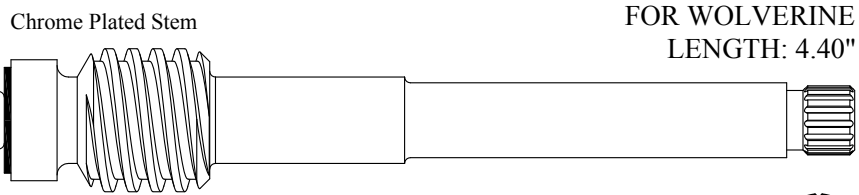

LF271081/ LF271082

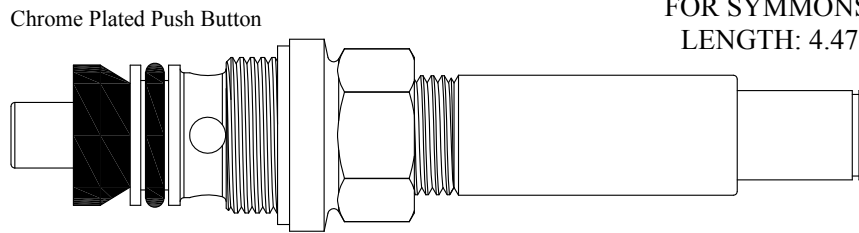

430720

GASKET: 895150 INCLUDED

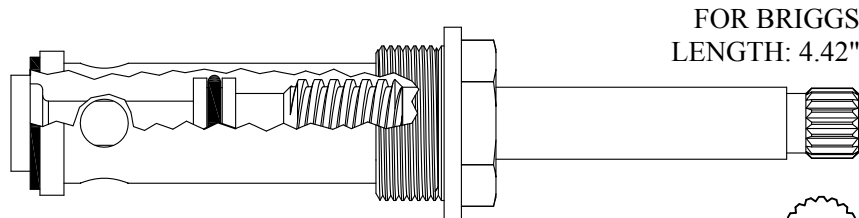

405902

GASKET: 895150



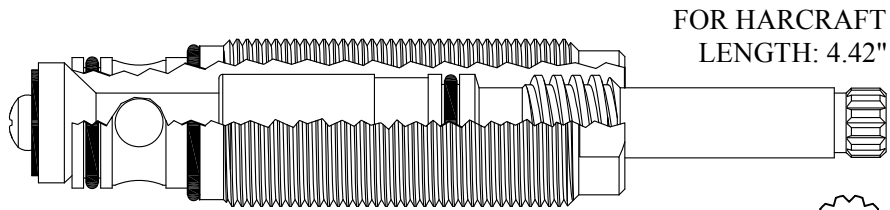

430501
203501 Stem Only

GASKET: 890170 O-RING INCLUDED

12
1-2

FOR AM STD
LENGTH: 4.44"



SEAT USED: LF648220

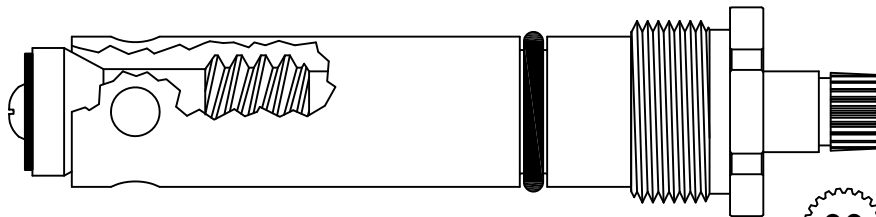

430602
230602 Stem Only

22
1-4

Chrome Plated Stem

FOR BARNES
LENGTH: 4.44"



SEAT USED: LF648350

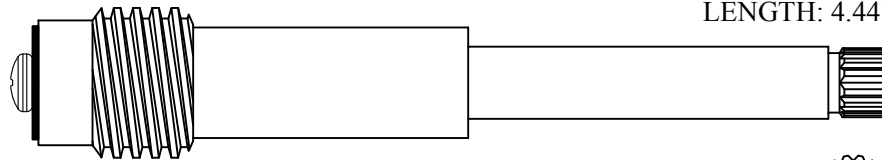

LF271031/ LF271032

16
1-6

Chrome Plated Stem

FOR AM STD
LENGTH: 4.44"



SEAT USED: LF648100

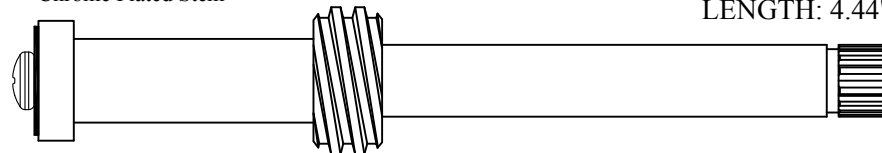

LF274041/ LF274042

16

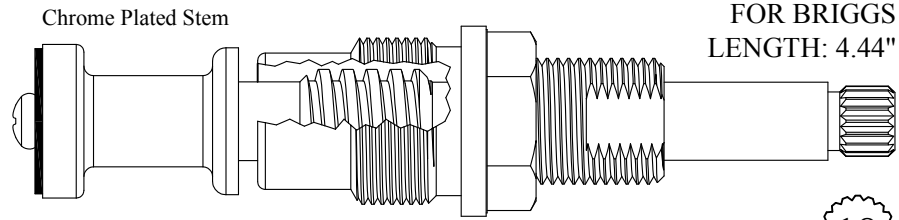

Chrome Plated Stem

FOR BRIGGS
LENGTH: 4.44"

LF471501
LF271501 Stem Only
GASKET: 895180

18
3-3

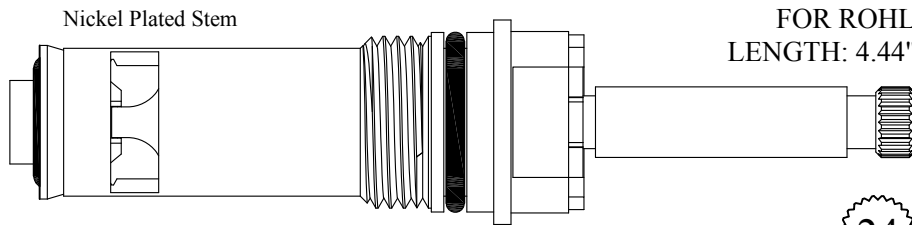

Nickel Plated Stem

FOR ROHL
LENGTH: 4.44"

LF471601/ LF471602
SEAL: 898550
DISC SET: 151380-PKG

24
3-19

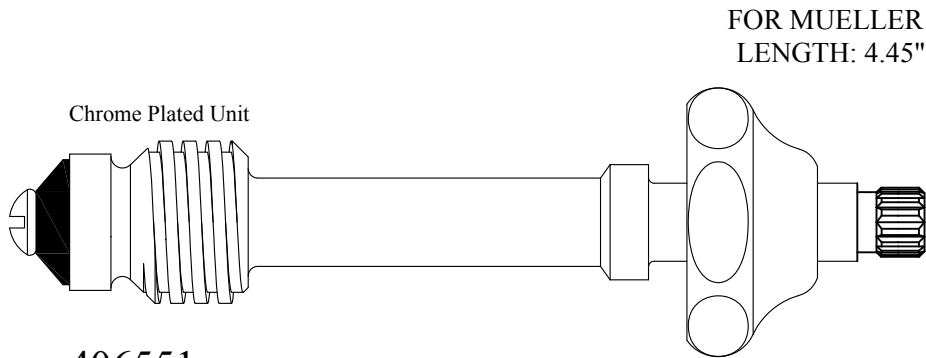

Chrome Plated Unit

FOR MUELLER
LENGTH: 4.45"

406551
206551 Stem Only

Supplied with
12pt. Broach

12
1-2

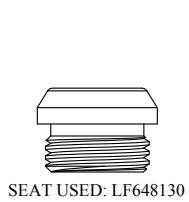

SEAT USED: LF648130

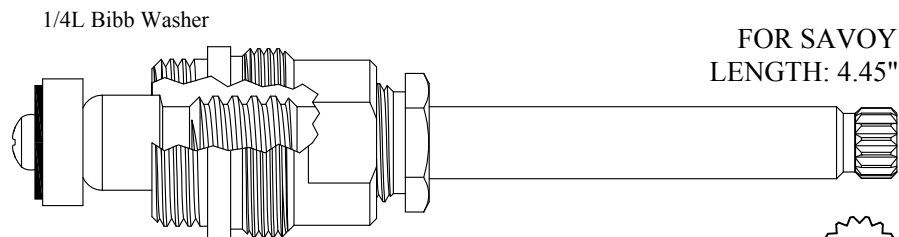

1/4L Bibb Washer

FOR SAVOY
LENGTH: 4.45"

406711
206711 Stem Only
GASKET: 895400

15
1-13

Chrome Plated Stem

FOR PAUL
LENGTH: 4.45"



406731/ 406732

GASKET: 890170 O-RING INCLUDED
SEAL: 898510-W
DISC SET: 151380-PKG



3-16

Chrome Plated Stem

FOR HARCRAFT
LENGTH: 4.45"

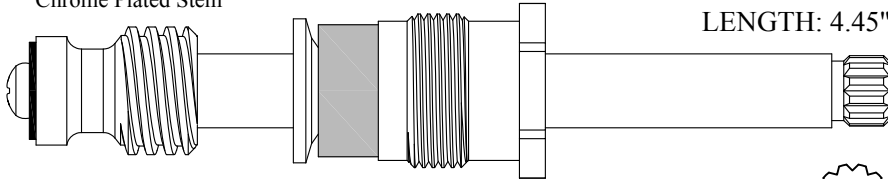

LF473021/ LF473022

LF273021/ LF273022 Stem Only



1-2

FOR MILWAUKEE
LENGTH: 4.46"

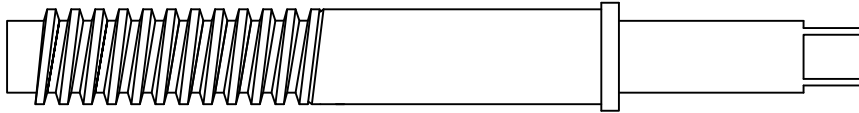

207512



5/16

One Piece Brass Stem

FOR PRICE PFISTER
LENGTH: 4.46"

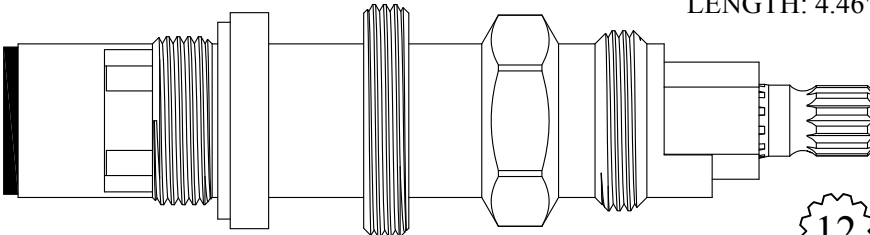

405411

GASKET: 895390 INCLUDED
SEAL: 898550
DISC SET: 151380-PKG



1-2



You can use the 647390 seat
to convert the old Beau Art
body to accept the 405411
ceramic cartridge

FOR PRICE PFISTER
LENGTH: 4.46"

One Piece Brass Stem

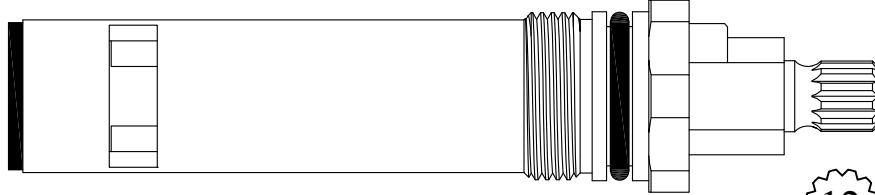

405421

SEAL: 898550
DISC SET: 124290-PKG



3/8M Bibb Washer

FOR SAVOY
LENGTH: 4.45"

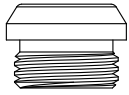

SEAT USED: LF648130

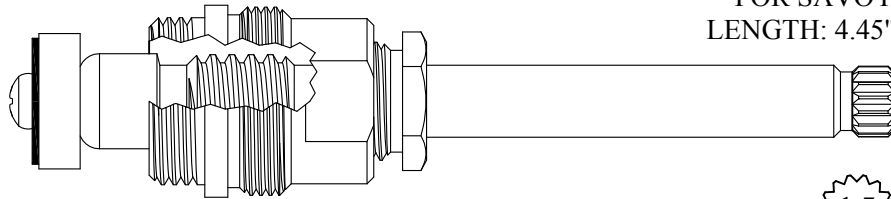

406701

206701 Stem Only
GASKET: 895400



Chrome Plated Stem & Tube

FOR MOEN
LENGTH: 5.01"

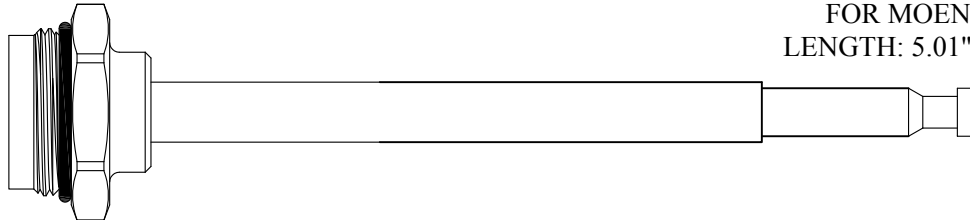

430490

GASKET: 890190 O-RING INCLUDED

FOR REID WATSON
LENGTH: 4.47"

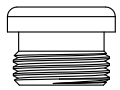

SEAT USED: LF648560

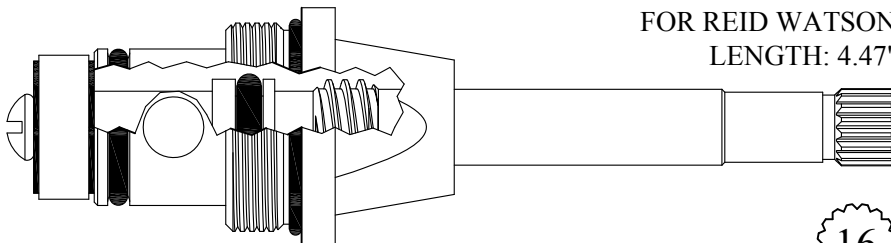

430531

GASKET: 890220 O-RING INCLUDED



FOR ORION
LENGTH: 4.47"

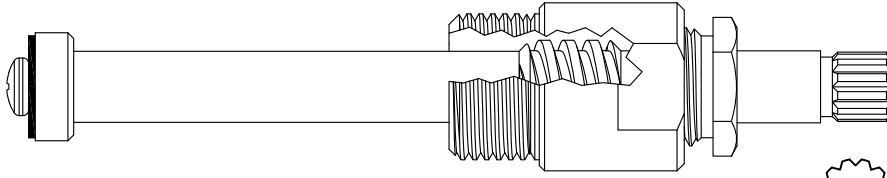

LF473101

12
1-2

FOR AM STD
LENGTH: 4.48"

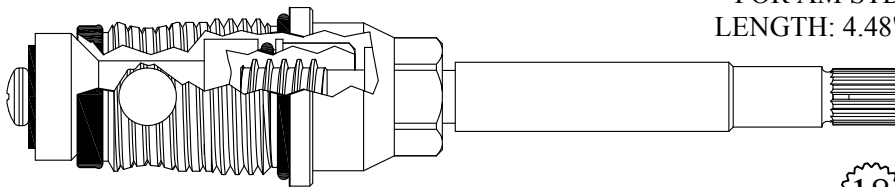

430692
GASKET: 890170

18
3-30



SEAT USED: LF648560

FOR INDIANA
LENGTH: 4.49"

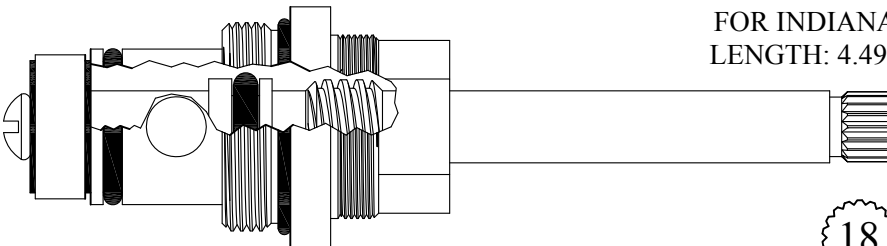

430511

18
3-3

FOR STREAMWAY
LENGTH: 4.49"

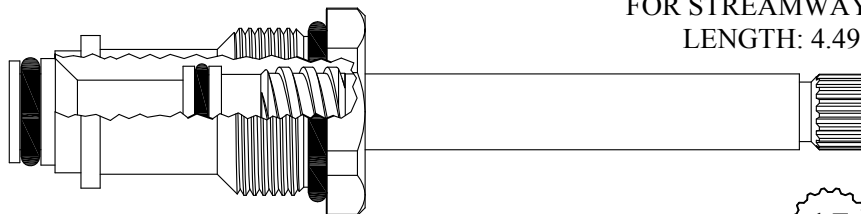

430521
GASKET: 891160 O-RING INCLUDED

17
3-7

Plastic Sleeve

FOR ACORN
LENGTH: 4.49"

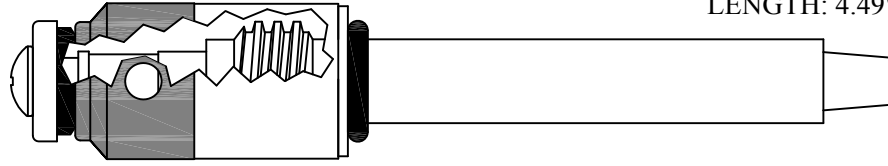

470052
270052 Stem Only

FOR CENTRAL
LENGTH: 4.50"

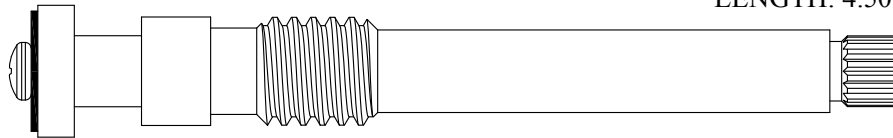

207221

16
1-6

FOR BRADLEY
LENGTH: 4.50"

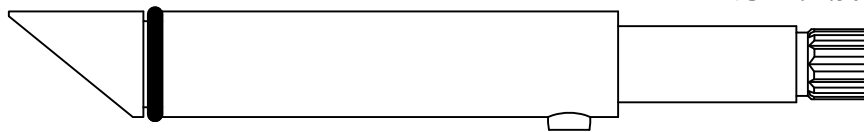

230620

12
3-10

FOR SAYCO
LENGTH: 4.50"

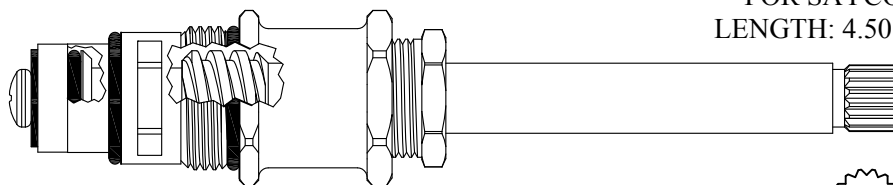

430701
230701 Stem Only (Includes Cage)
GASKET: 890160 O-RING INCLUDED

16
2-3

LF647610
LF647450
SEAT USED: LF647450
or LF647610

LF647610

LF647450

SEAT USED: LF647450
or LF647610

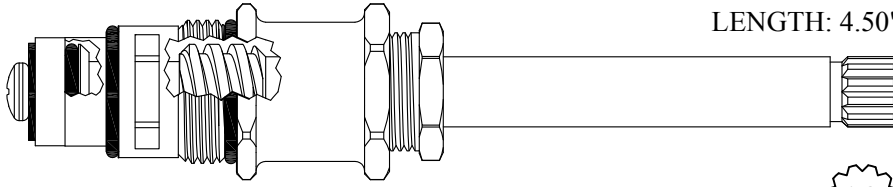

FOR SAYCO
LENGTH: 4.50"

430751
207251 Stem Only

GASKET: 890160 O-RING INCLUDED

12
1-2

LF647610

LF647450

SEAT USED: LF647450
or LF647610

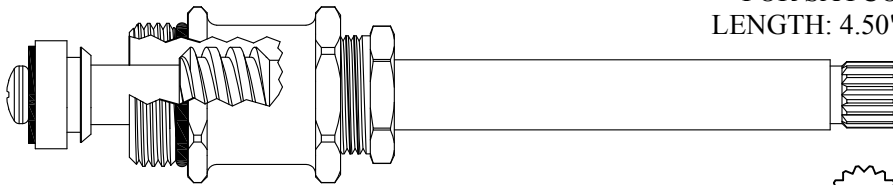

FOR SAYCO
LENGTH: 4.50"

407201/ 407202
207201/ 207202 Stem Only

GASKET: 890160 O-RING INCLUDED

16
2-3

LF647610

LF647450

SEAT USED: LF647450
or LF647610

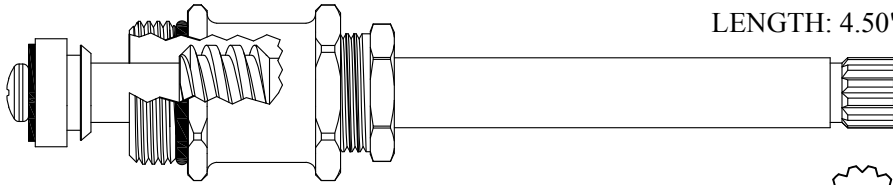

FOR SAYCO
LENGTH: 4.50"

407251/ 407252
207251/ 207252 Stem Only

GASKET: 890160 O-RING INCLUDED

12
1-2

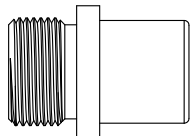

SEAT USED: LF649640

Chrome Plated Stem

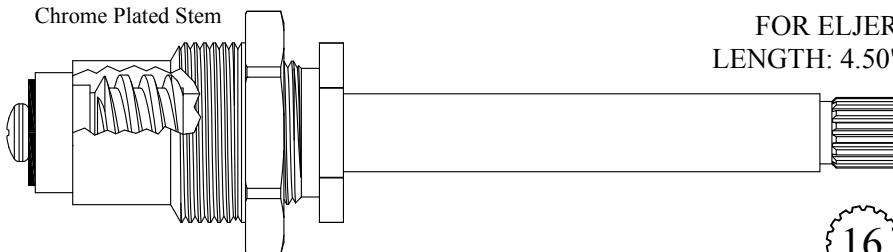

FOR ELJER
LENGTH: 4.50"

411211/ 411212
211211/ 211212 Stem Only

GASKET: 895330

16
3-15

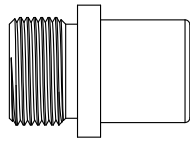

SEAT USED: LF649640

Chrome Plated Stem

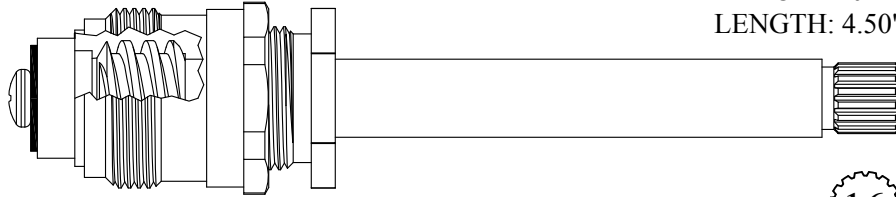

FOR ELJER
LENGTH: 4.50"

16
3-15

411231/ 411232
211211/ 211212 Stem Only
GASKET: 895120



SEAT USED: LF648200 or LF649770

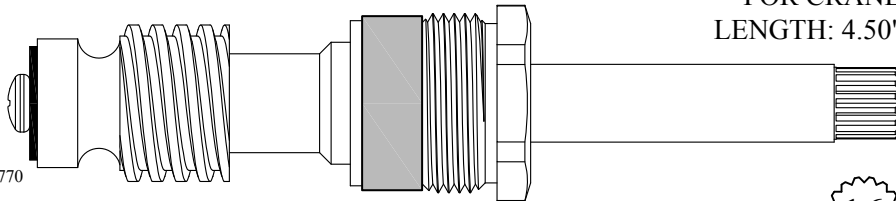

FOR CRANE
LENGTH: 4.50"

16
1-6

LF473031/ LF473032
LF273031/ LF273032 Stem Only

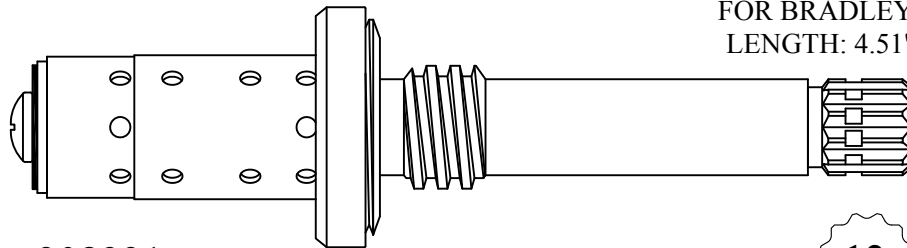

FOR BRADLEY
LENGTH: 4.51"

12

208331

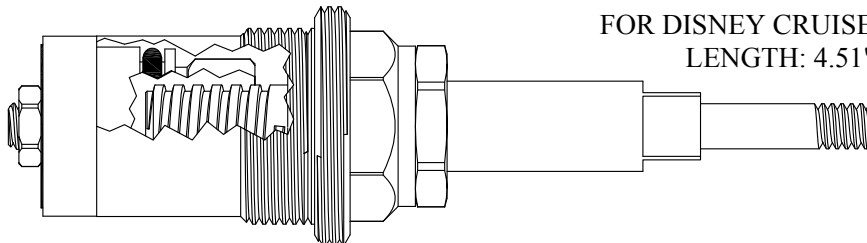

FOR DISNEY CRUISE
LENGTH: 4.51"

405722
GASKET: 895560

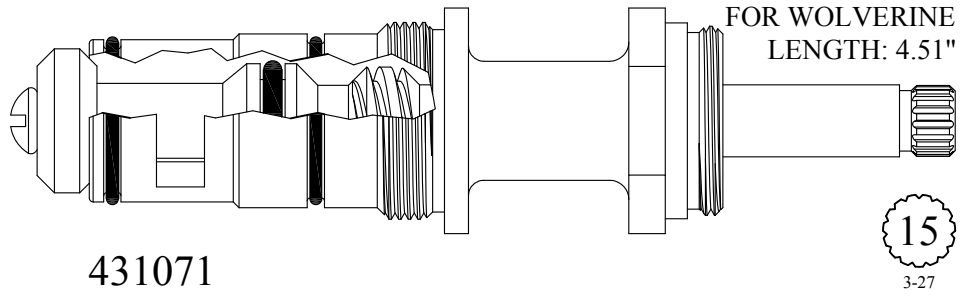

431071

15
3-27

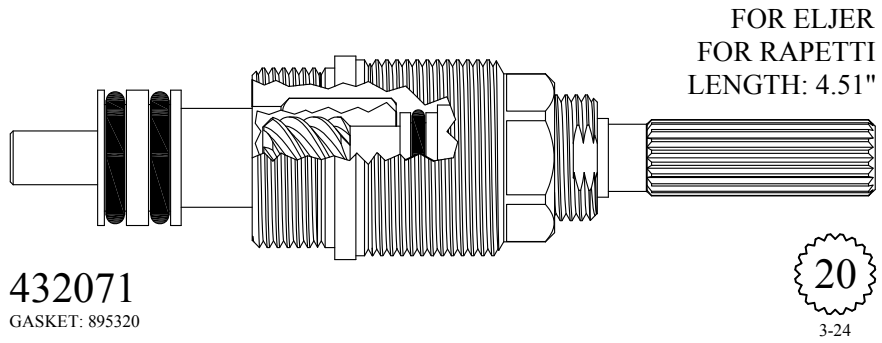

432071
GASKET: 895320

20
3-24

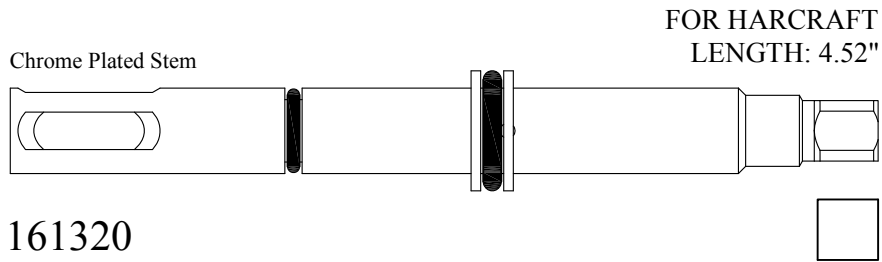

161320

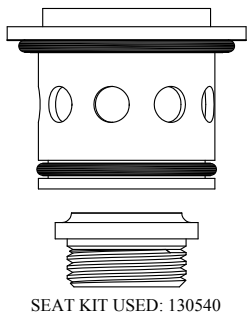

SEAT KIT USED: 130540

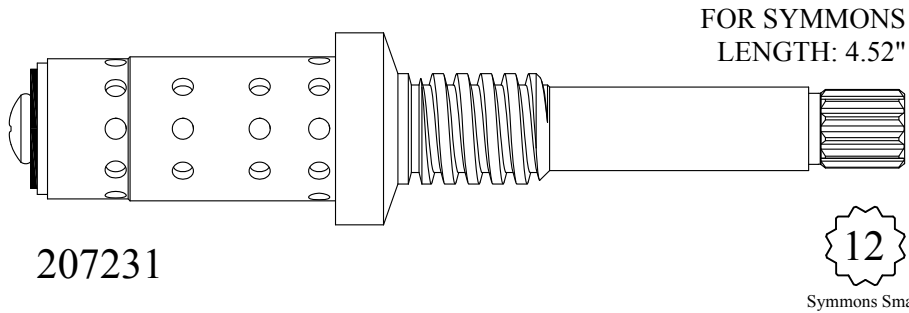

207231

12
Symmons Small

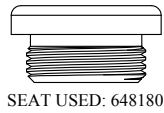

Chrome Plated Stem

FOR SPEAKMAN
LENGTH: 4.52"

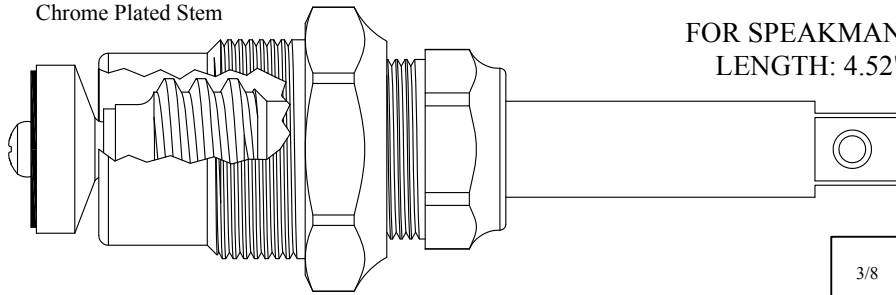

3/8

407011

207011 Stem Only

GASKET: 895450

FOR GLAUBER WEST COAST
LENGTH: 4.52"

Chrome Plated Unit

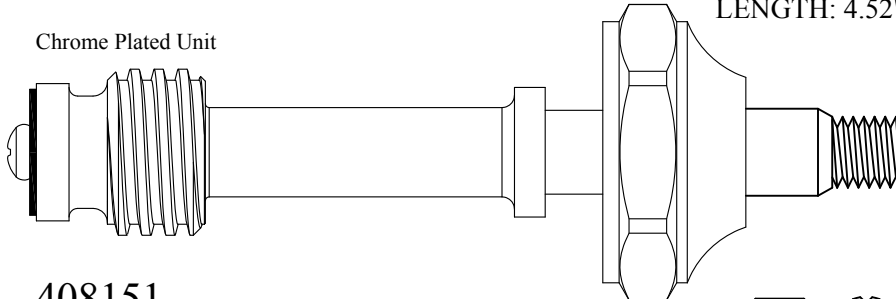

408151

208151 Stem Only

Supplied with
12pt. Broach

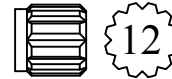

12
1-2

UNKNOWN
LENGTH: 4.52"

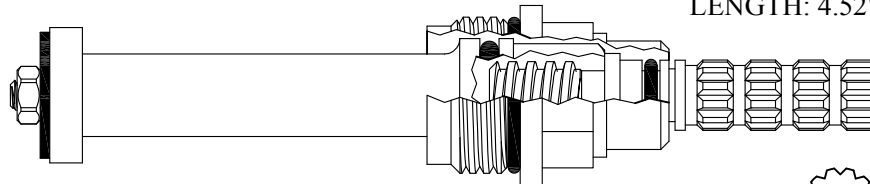

426862

GASKET: 890170 O-RING INCLUDED

12
1-2



Chrome Plated Stem

FOR ARROWHEAD
LENGTH: 4.52"

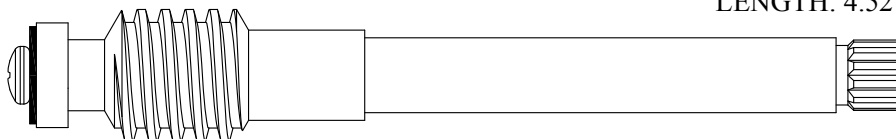

LF274201

12
1-2

SEAT USED: LF648130

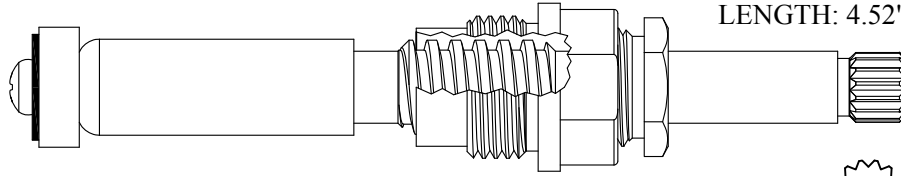
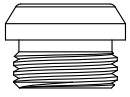

FOR SAVOY
LENGTH: 4.52"

LF471301
LF471301 Stem Only
GASKET: 895100



1-13

Chrome Plated Stem

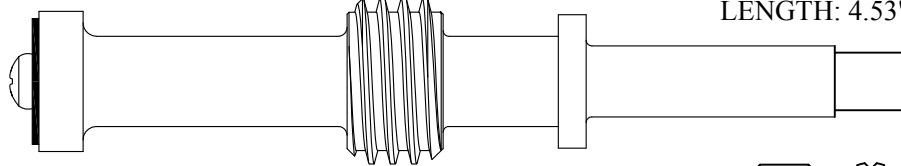

UNKNOWN
LENGTH: 4.53"

206851

Supplied with
12pt. Broach



1-2

Chrome Plated Stem

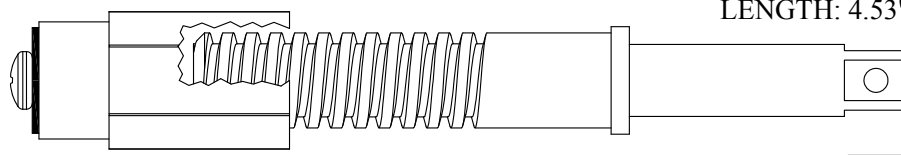

FOR MILWAUKEE
LENGTH: 4.53"

403432
203432 Stem Only



5/16

SEAT USED: LF648930

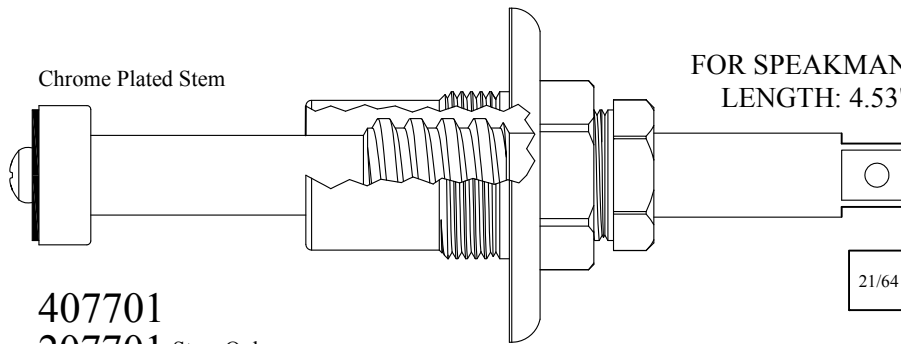

FOR SPEAKMAN
LENGTH: 4.53"

407701
207701 Stem Only
GASKET: 895400



21/64

SEAT USED: LF648930

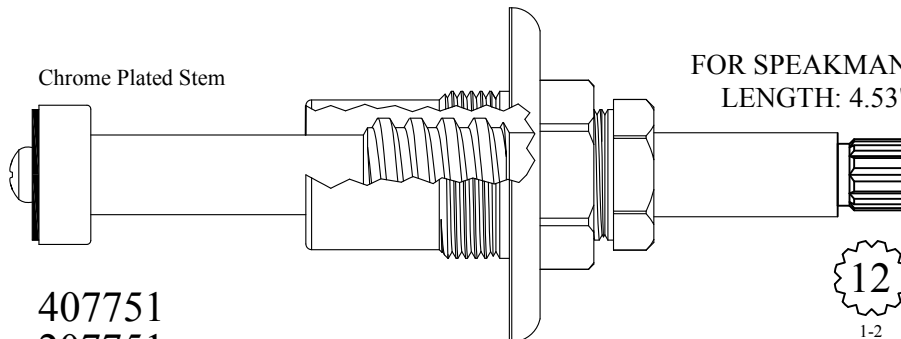

FOR SPEAKMAN
LENGTH: 4.53"

407751
207751 Stem Only
GASKET: 895400



1-2

SEAT USED: LF648170

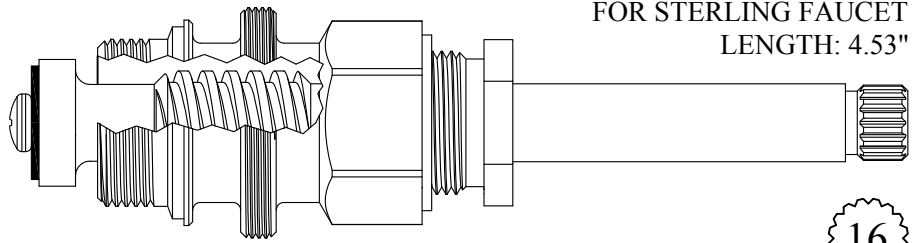

FOR STERLING FAUCET
LENGTH: 4.53"

16
1-5

407301/ 407302
207301/ 207302 Stem Only
GASKET: 895400

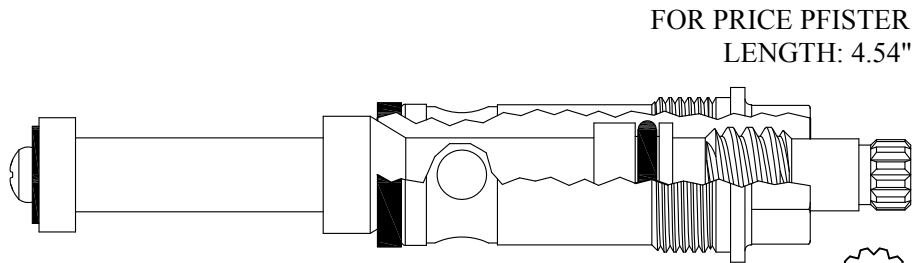

FOR PRICE PFISTER
LENGTH: 4.54"

12
1-2

430821
GASKET: 895150

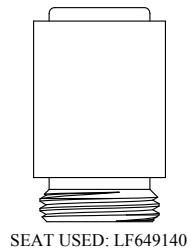

SEAT USED: LF649140

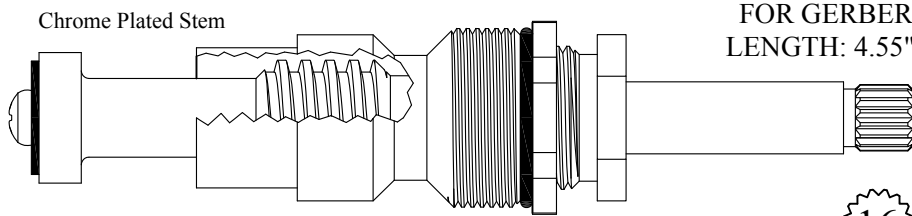

Chrome Plated Stem

FOR GERBER
LENGTH: 4.55"

16
2-3

LF477021/ LF477022
LF277021/ LF277022 Stem Only
GASKET: 890190 O-RING INCLUDED



SEAT USED: LF648170

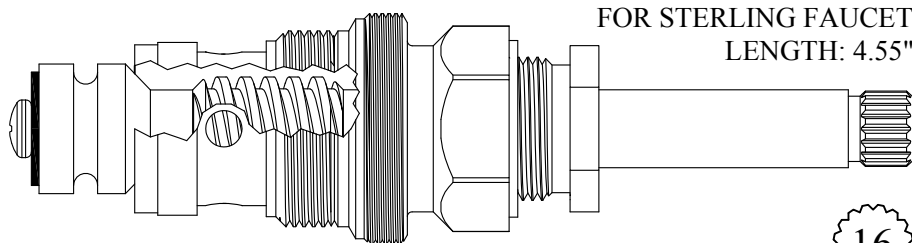

FOR STERLING FAUCET
LENGTH: 4.55"

16
1-5

430801
230801 Stem Only
GASKET: 895560

FOR ELJER
LENGTH: 4.55"

Chrome Plated Sleeve



SEAT USED: LF648320
or LF648160

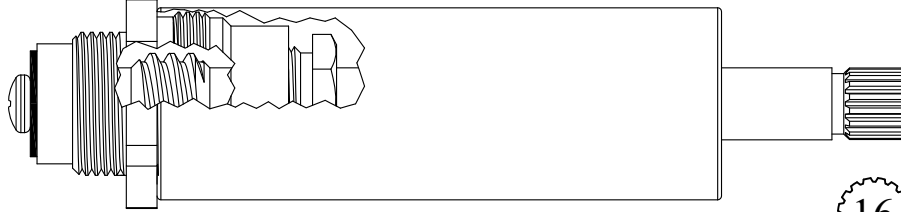

407801/ 407802
207801/ 207802 Stem Only
GASKET: 895100

FOR ELJER
LENGTH: 4.55"

Chrome Plated Gland

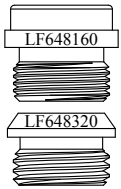

SEAT USED: LF648320
or LF648160

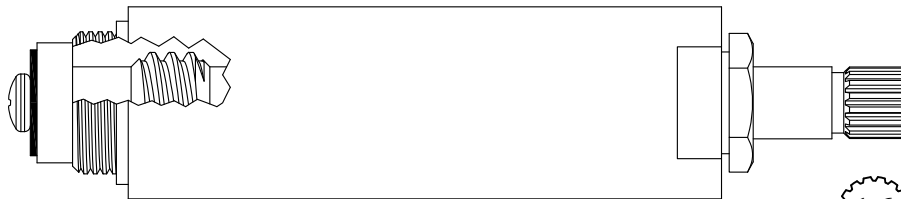

407821/ 407822
207801/ 207802 Stem Only
GASKET: 895100

FOR ELJER
LENGTH: 4.55"

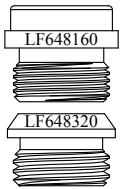

SEAT USED: LF648320
or LF648160

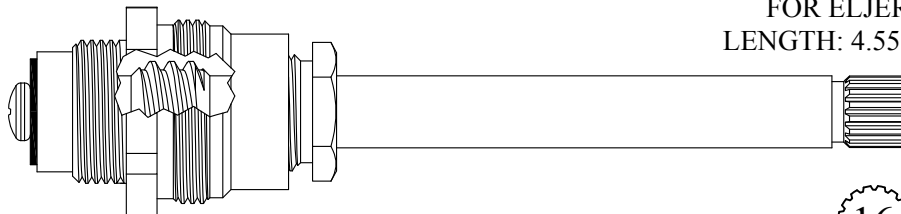

407831/ 407832
207801/ 207802 Stem Only
GASKET: 895100

FOR ELJER
LENGTH: 4.55"

Chrome Plated Sleeve

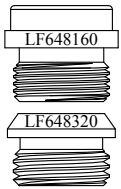

SEAT USED: LF648320
or LF648160

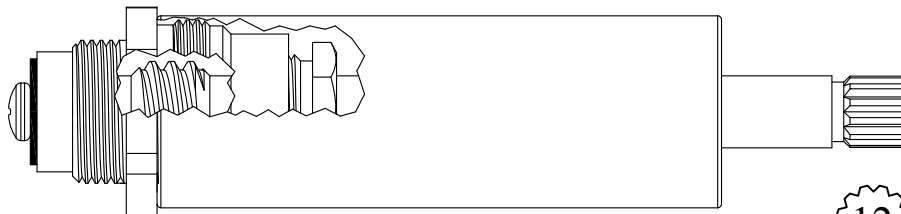

407851/ 407852
207851/ 207852 Stem Only
GASKET: 895100

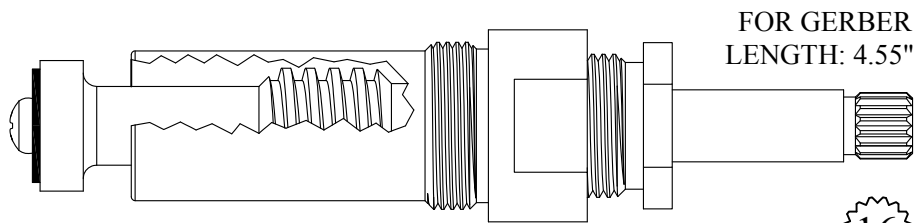
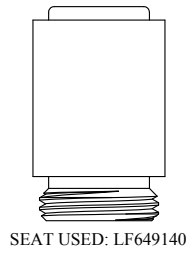

16
2-3

LF473041/ LF473042
LF273041/ LF273042 Stem Only
GASKET: 895180

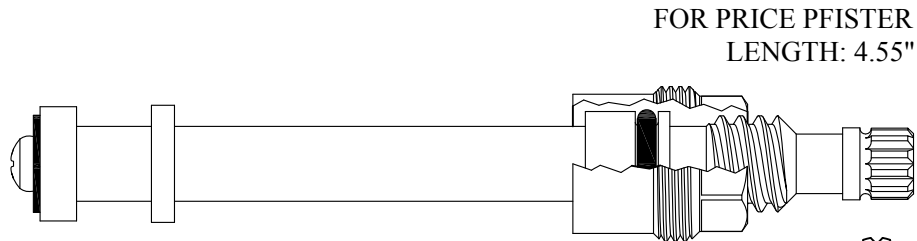

12
1-2

LF474011/ LF474012
GASKET: 895060

All Brass Stem - No Plastic

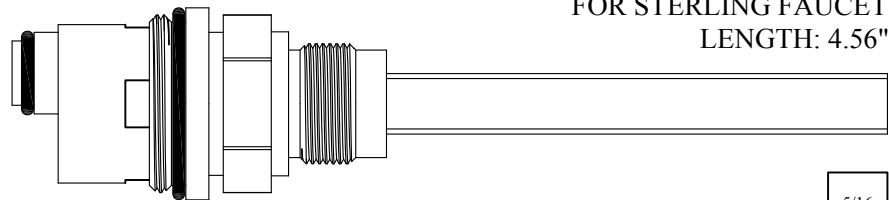

5/16

406741/ 406742
GASKET: 890190 O-RING INCLUDED

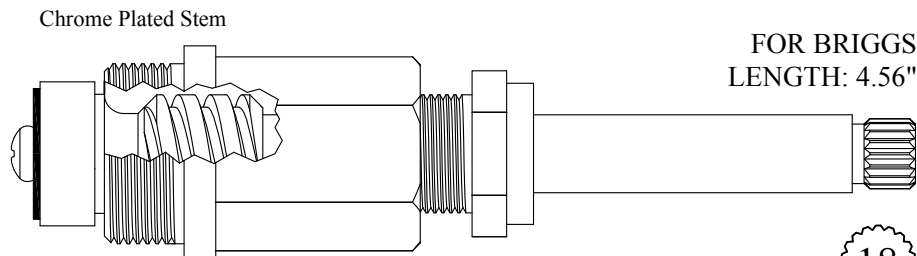
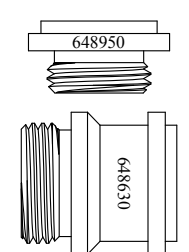

18
3-3

407501/ 407502
207501/ 207502 Stem Only
GASKET: 895370

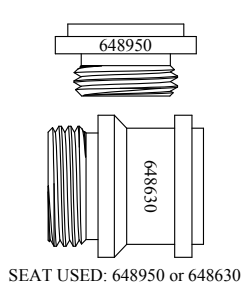

Chrome Plated Unit

FOR BRIGGS
LENGTH: 4.56"

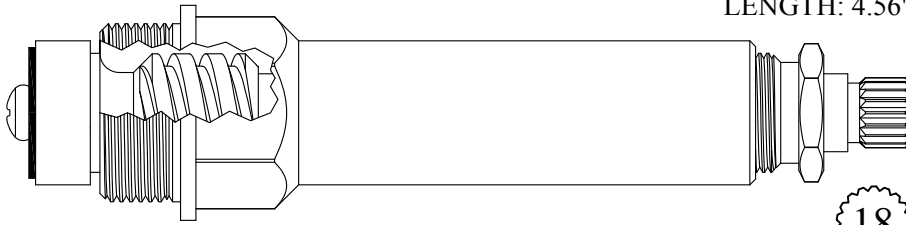

407521/ 407522
207501/ 207502 Stem Only
GASKET: 895370

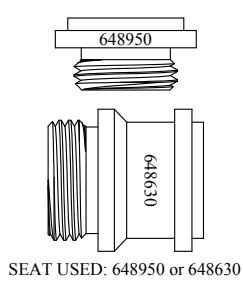

Chrome Plated Stem

FOR BRIGGS
LENGTH: 4.56"

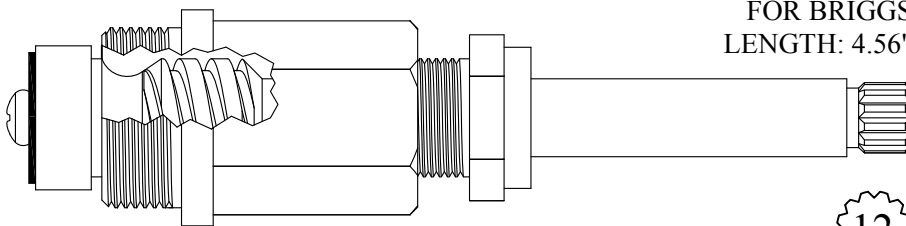

407551/ 407552
207551/ 207552 Stem Only
GASKET: 895370

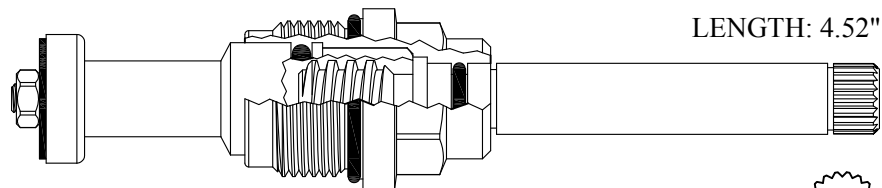

LENGTH: 4.52"



405942
GASKET: 890180 O-RING INCLUDED

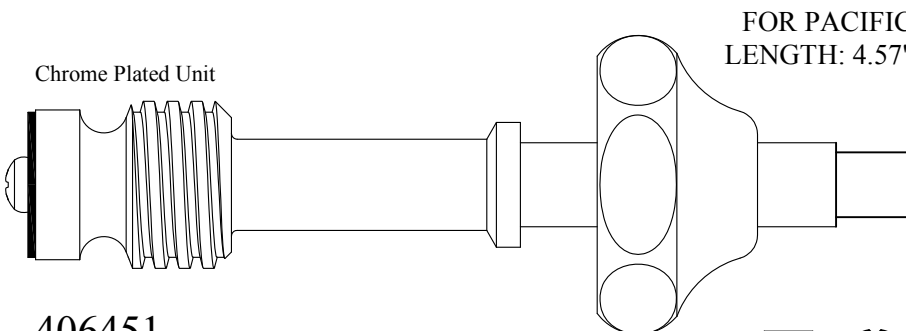

Chrome Plated Unit

FOR PACIFIC
LENGTH: 4.57"

406451
206451 Stem Only

Supplied with
12pt. Broach

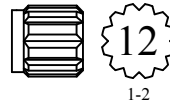



SEAT USED: LF648170

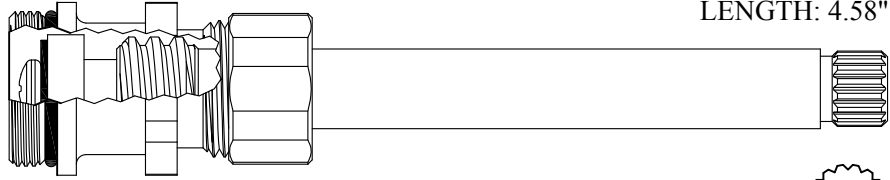

FOR STERLING FAUCET
LENGTH: 4.58"

405841

GASKET: 890170 O-RING INCLUDED

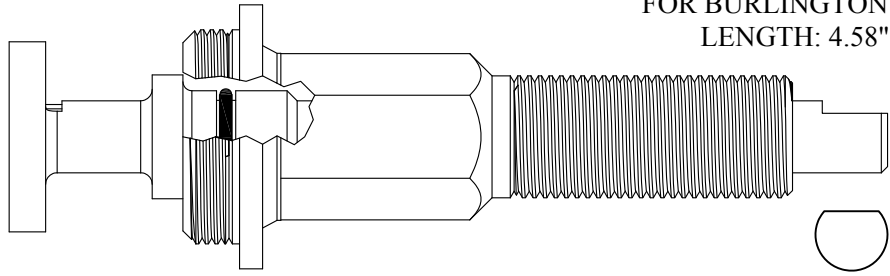

FOR BURLINGTON
LENGTH: 4.58"

430710

230710 Stem Only

GASKET: 894620

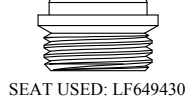

SEAT USED: LF649430

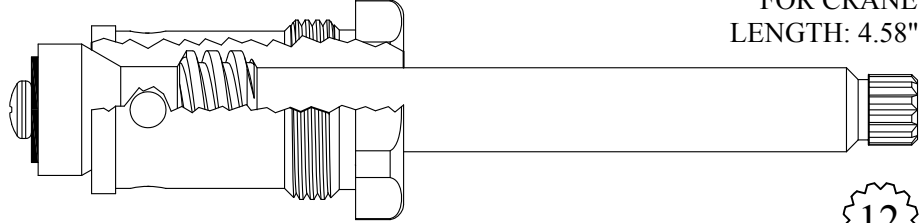

FOR CRANE
LENGTH: 4.58"

430901

230901 Stem Only

GASKET: 895320

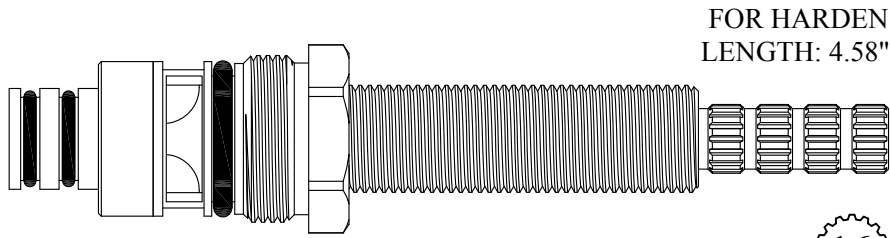

FOR HARDEN
LENGTH: 4.58"

408011/ 408012

GASKET: 891140 O-RING INCLUDED
DISC SET: 151380-PKG



Chrome Plated Stem

FOR HARCRAFT
LENGTH: 4.58"

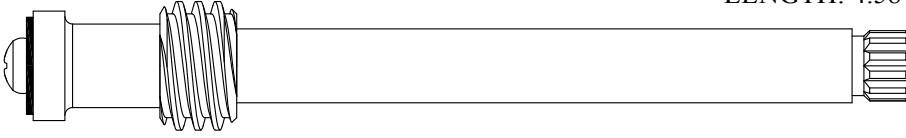

LF274031/ LF274032



FOR PRICE PFISTER
LENGTH: 4.59"

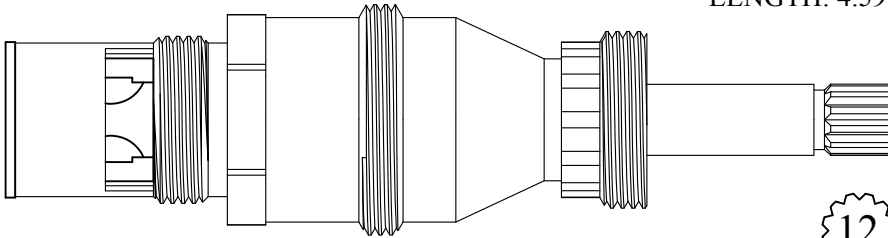

405441

GASKET: 895390 INCLUDED
DISC SET: 124290-PKG



FOR EAST RIVER
LENGTH: 4.59"

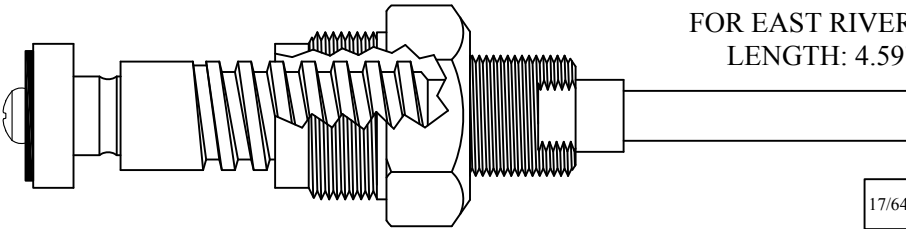

408711

208711 Stem Only

GASKET: 895150

17/64

Chrome Plated Stem

FOR LOGAN
LENGTH: 4.59"

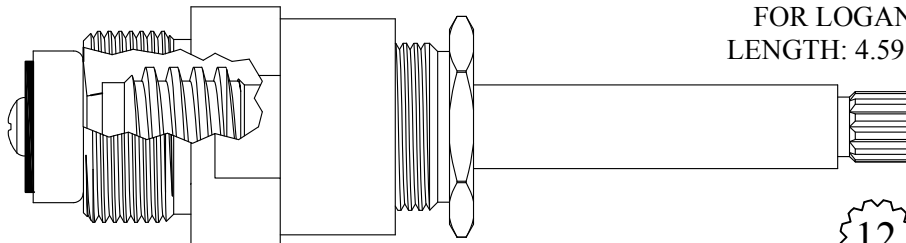

410011

210011 Stem Only

GASKET: 895430



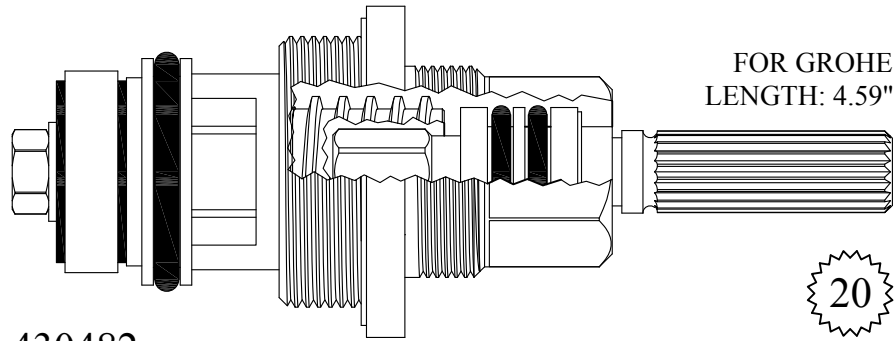

430482
GASKET: 895520 INCLUDED

20
3-32

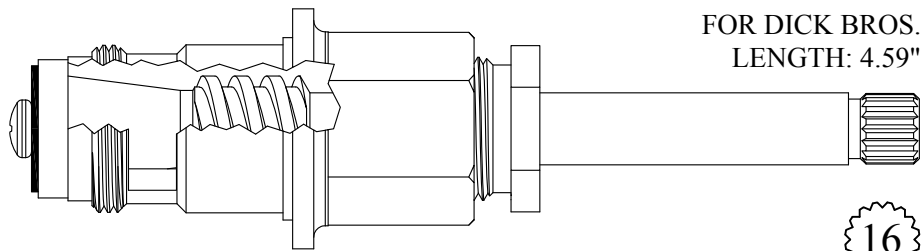

430611
230611 Stem Only
GASKET: 895350

16
1-6

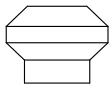

SEAT USED: 649110

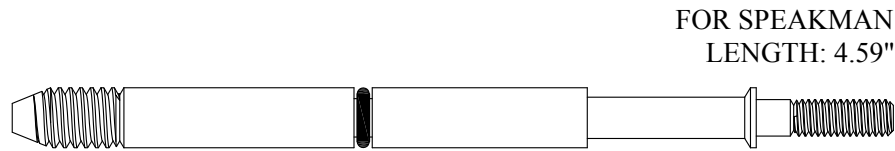

LF274070

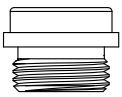

SEAT USED: LF648550

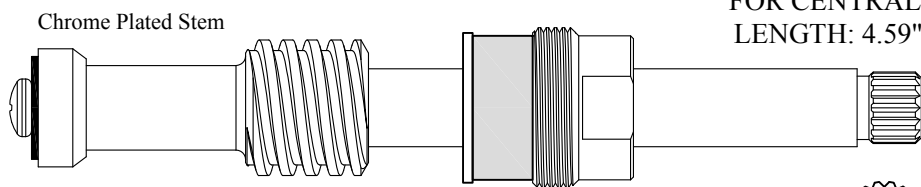

LF474021/ LF474022
LF274021/ LF274022 Stem Only

16
1-6

SEAT USED: LF648930

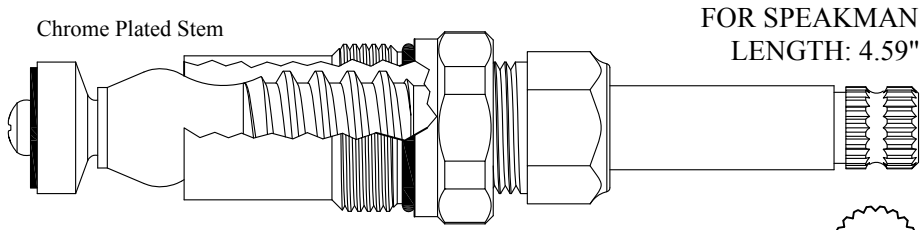

FOR SPEAKMAN
LENGTH: 4.59"

LF475011/ LF475012
LF275011/ LF275012 Stem Only
GASKET: 890180 O-RING INCLUDED

20
2-4

SEAT USED: LF649430

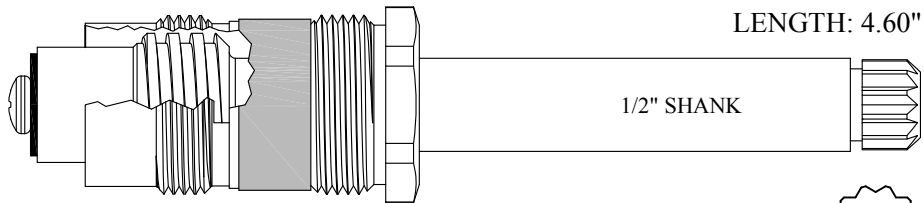

FOR CRANE
LENGTH: 4.60"

408001
208001 Stem Only

12

SEAT USED: LF649430

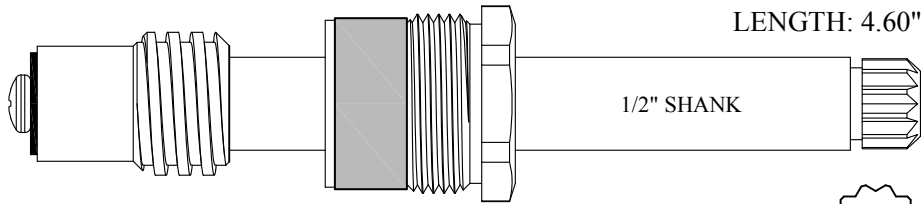

FOR CRANE
LENGTH: 4.60"

408021
208001 Stem Only

12

Chrome Plated Stem

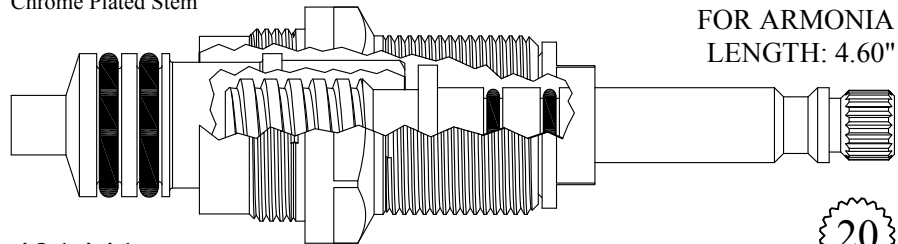

FOR ARMONIA
LENGTH: 4.60"

431441
GASKET: 895570 INCLUDED

20
3-14

SEAT USED: LF649430

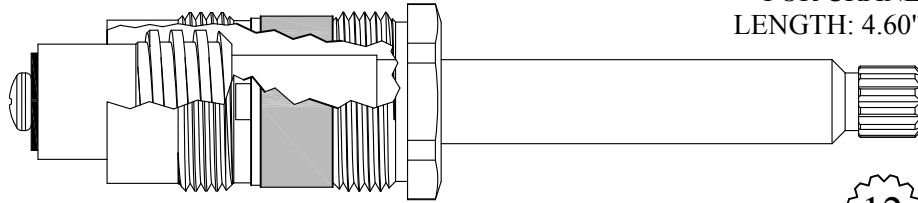

FOR CRANE
LENGTH: 4.60"

408301/ 408302
208301/ 208302 Stem Only

12
1-2

SEAT USED: LF649430

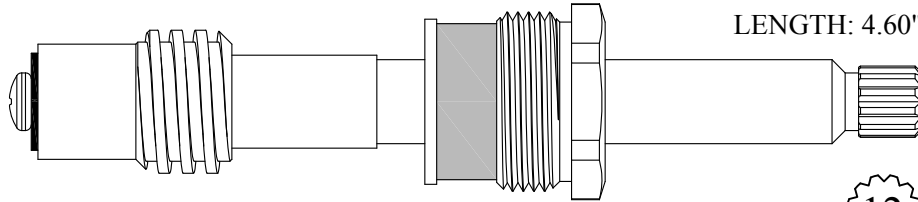

LENGTH: 4.60"

LF408321/ LF408322
LF208301/ LF208302 Stem Only } For Lavatory

12
1-2

SEAT USED: LF649430

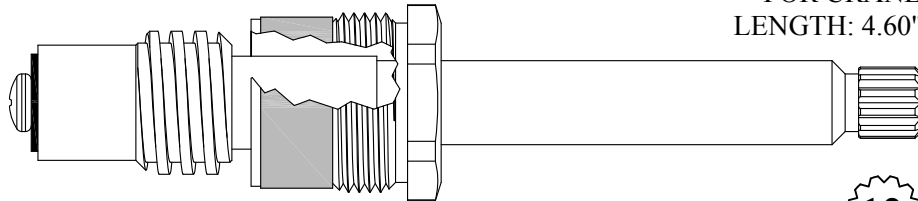

FOR CRANE
LENGTH: 4.60"

408321/ 408322
208301/ 208302 Stem Only } For Shower

12
1-2

SEAT USED: LF647450

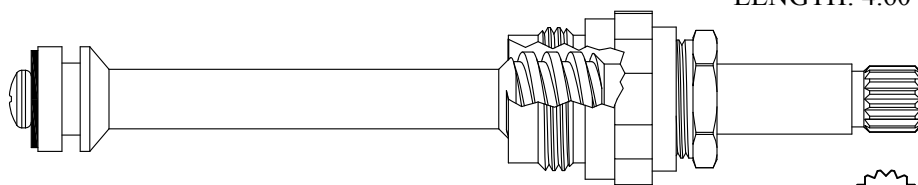

FOR SAYCO
LENGTH: 4.60"

LF474051/ LF474052
LF274051/ LF274052 Stem Only
GASKET: 895100

16
2-3

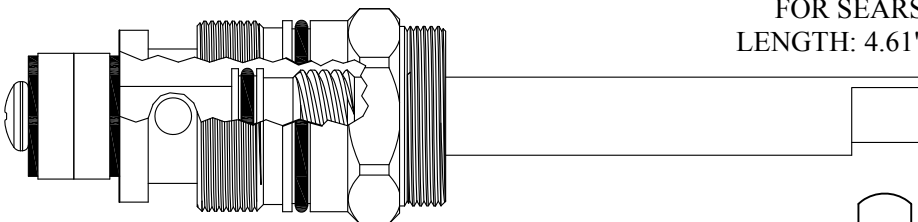

FOR SEARS
LENGTH: 4.61"

430911
230961 Stem Only



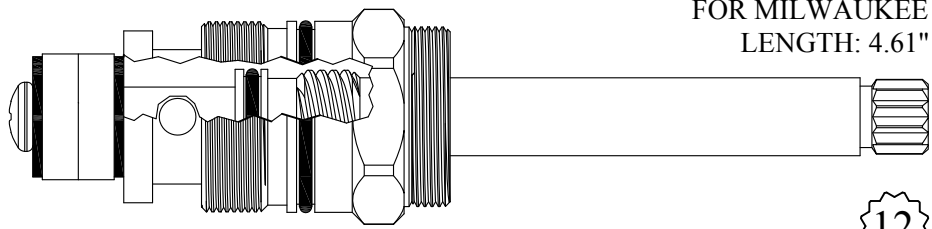

FOR MILWAUKEE
LENGTH: 4.61"

12
1-1

430951

GASKET: 890200 O-RING INCLUDED

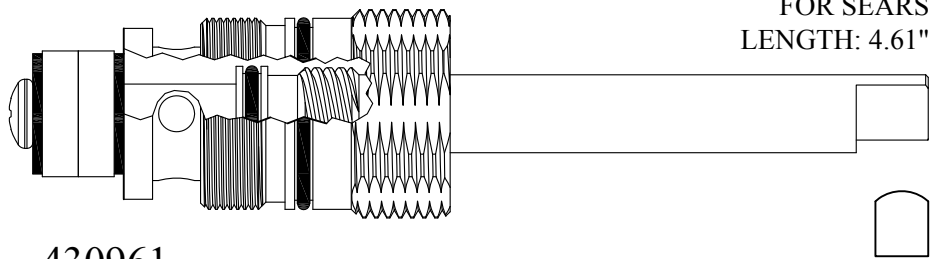

FOR SEARS
LENGTH: 4.61"

430961

230961 Stem Only

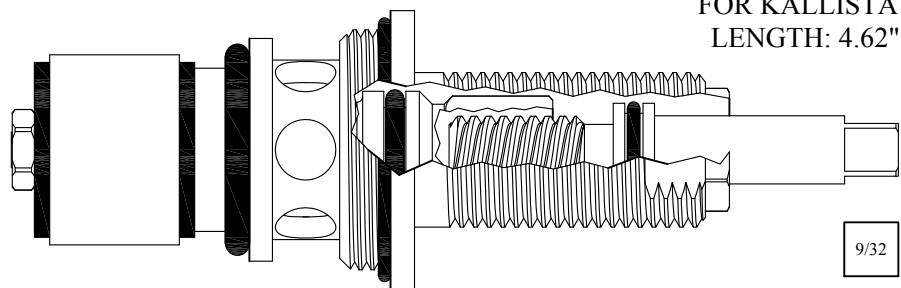

FOR KALLISTA
LENGTH: 4.62"

9/32

430642

GASKET: 890240 O-RING INCLUDED

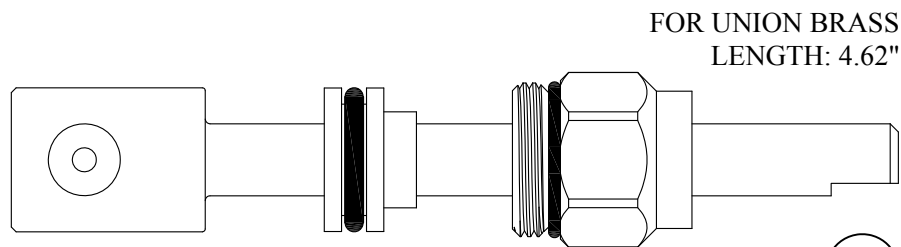

FOR UNION BRASS
LENGTH: 4.62"

430920

230920 Stem Only

GASKET: 890170 O-RING INCLUDED

Chrome Plated Push Button

FOR SYMMONS
LENGTH: 4.63"

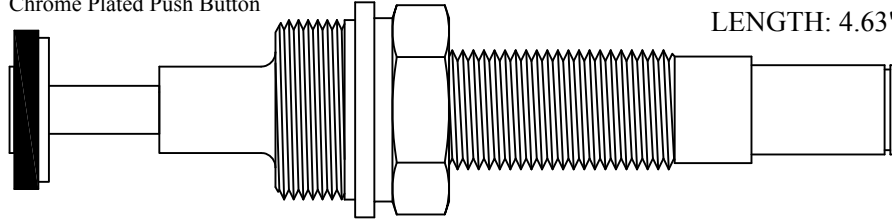

430830

GASKET: 895350 INCLUDED

SEAT USED: LF649200

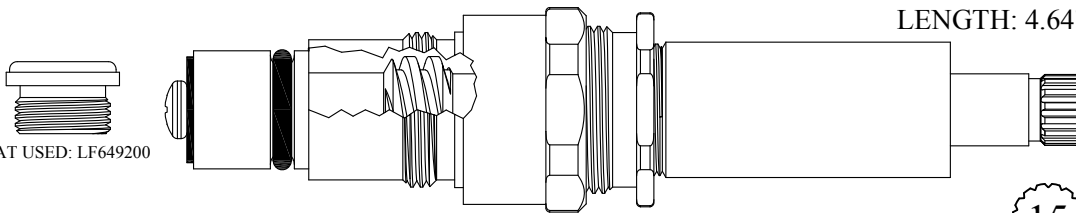

LENGTH: 4.64"

407901

GASKET: 895150

15

3-27

FOR ORION
LENGTH: 4.64"

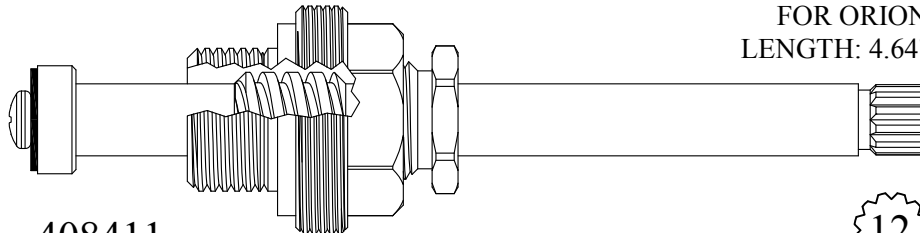

408411

GASKET: 895100

12

1-2

FOR HARDEN
LENGTH: 4.64"

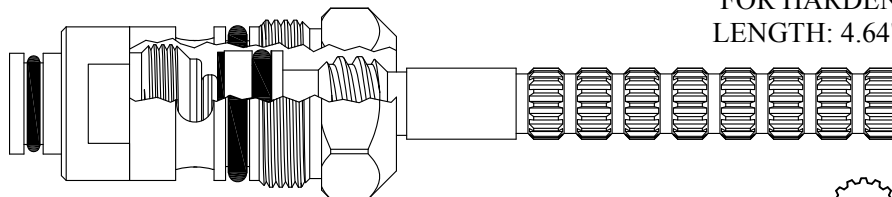

408031/ 408032

GASKET: 891140 O-RING INCLUDED

16

3-16

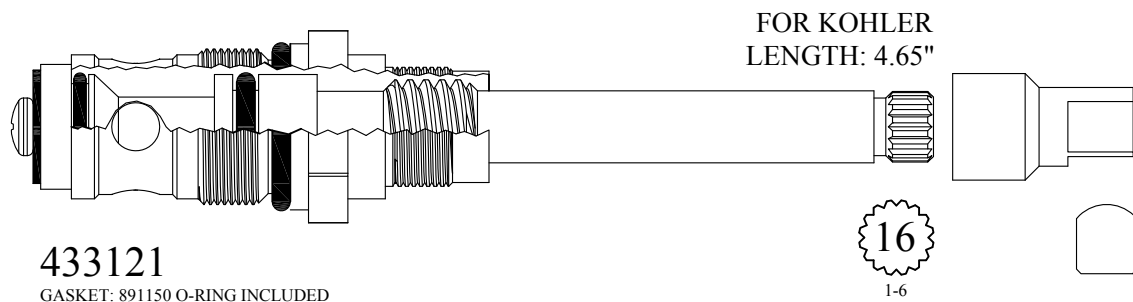
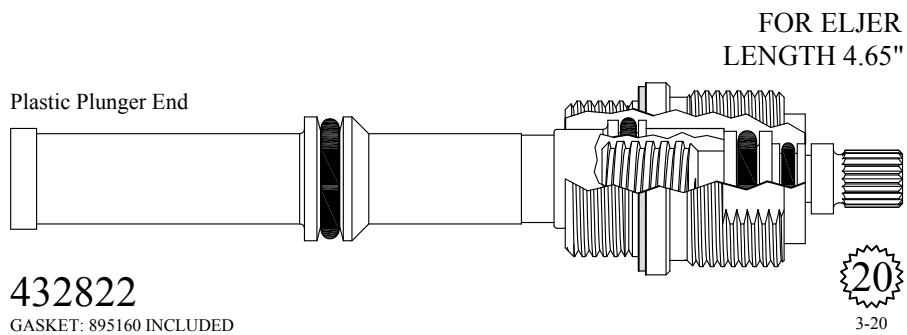
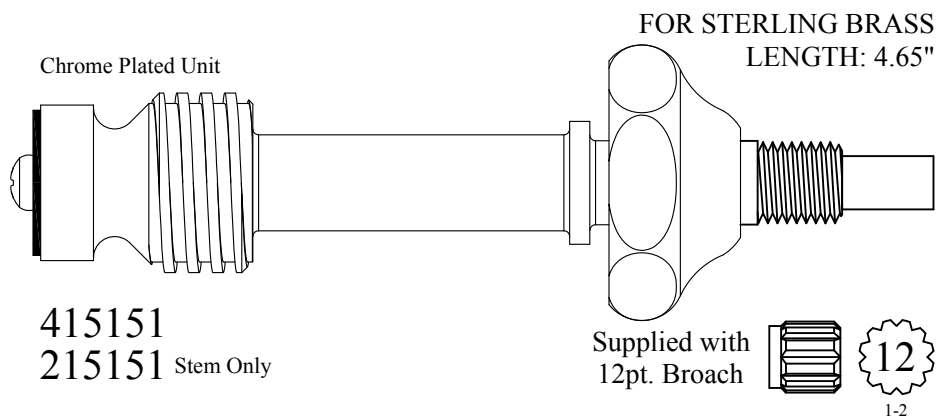
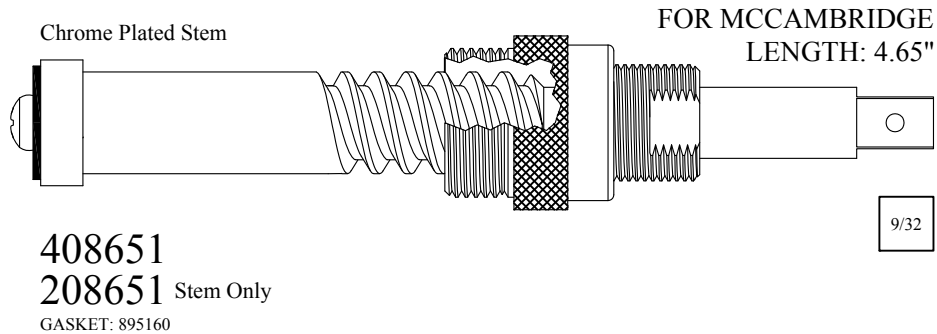

Also available with seat LF648070

433121-S



1/2 Turn Ceramic
Polished Gold Stem

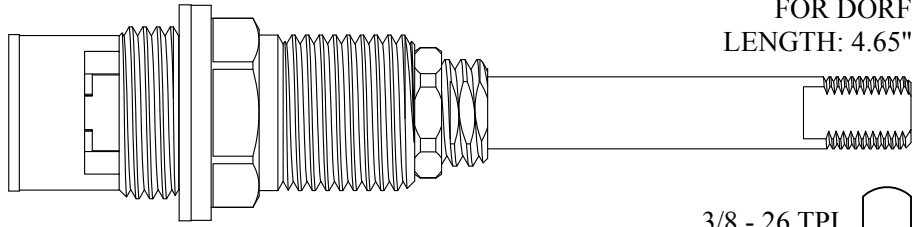

FOR DORF
LENGTH: 4.65"

3/8 - 26 TPI



407941/ 407942

DISC SET: 124290-PKG
GASKET: 895370 INCLUDED

Also available with a Polished Chrome Plated Stem

407941-CP / 407942-CP

FOR CRANE
LENGTH: 4.67"

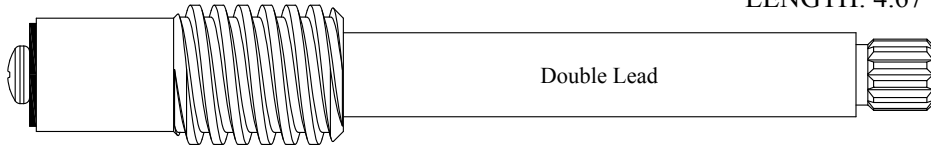

Double Lead

231031



1-2

FOR CRANE
LENGTH: 4.67"



SEAT USED: LF649430

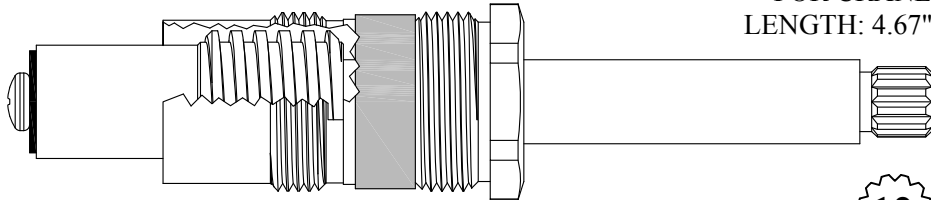

408201

208201 Stem Only



1-2

FOR CRANE
LENGTH: 4.67"



SEAT USED: LF649430

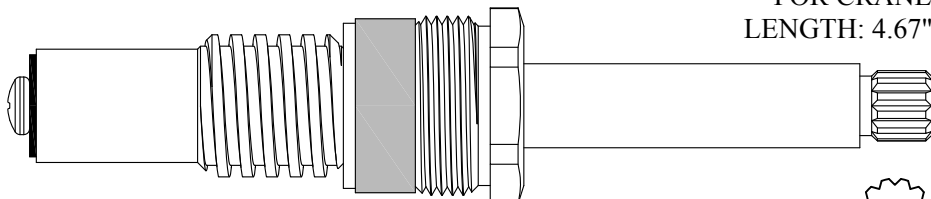

408211

208201 Stem Only

GASKET: INCLUDED



1-2

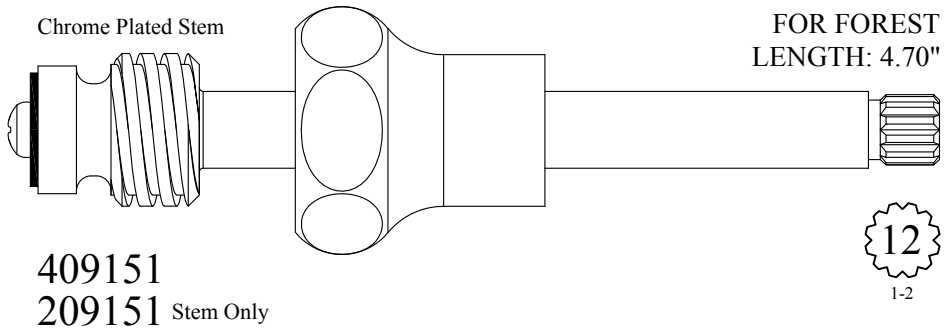

409151
209151 Stem Only

12
1-2

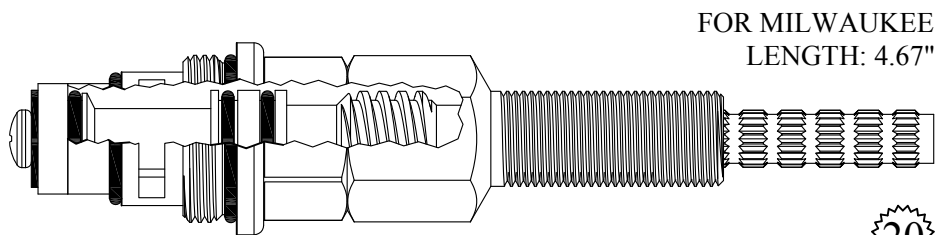

430931
GASKET: 890180 O-RING INCLUDED

20
3-20

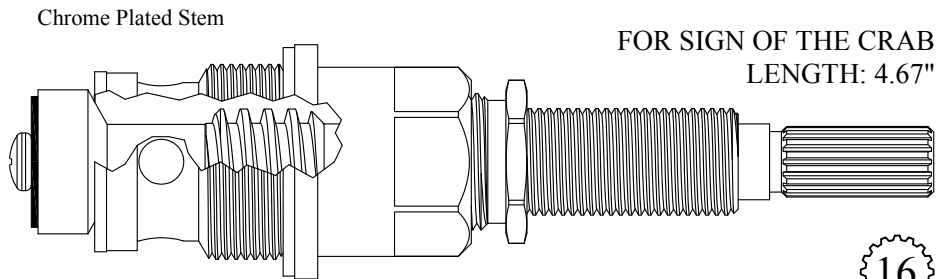

430971
GASKET: 895570 INCLUDED

16
3-16

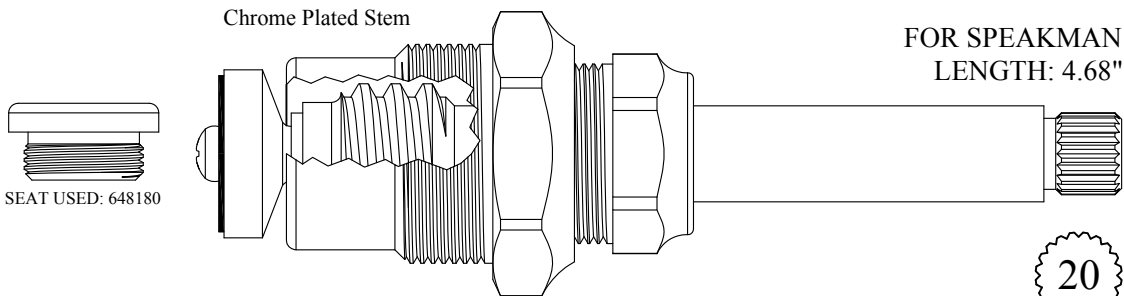

408801
208801 Stem Only
GASKET: 895450

20
2-4

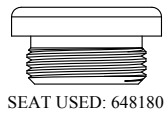

Chrome Plated Stem

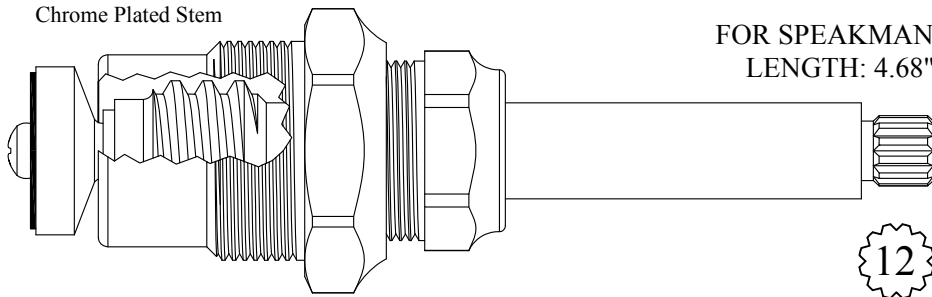

FOR SPEAKMAN
LENGTH: 4.68"

12
1-2

408851

208851 Stem Only

GASKET: 895450

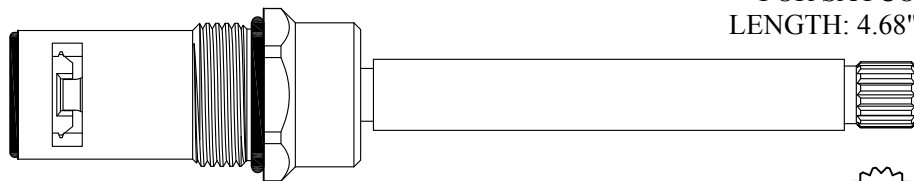

FOR SAYCO
LENGTH: 4.68"

16
2-3

408611/ 408612

GASKET: 890170 O-RING INCLUDED

SEAL: 898510

DISC SET: 151380-PKG



Chrome Plated Stem

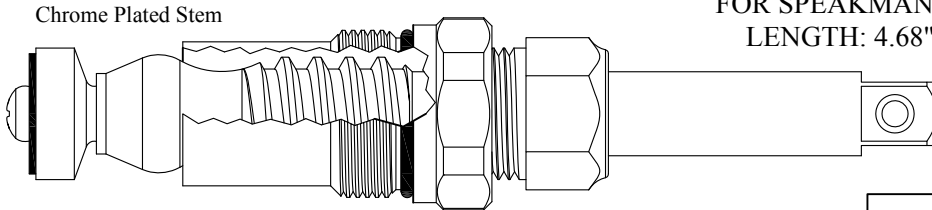

FOR SPEAKMAN
LENGTH: 4.68"

11/32

LF475111/ LF475112

LF275111/ LF275112 Stem Only

GASKET: 890180 O-RING INCLUDED

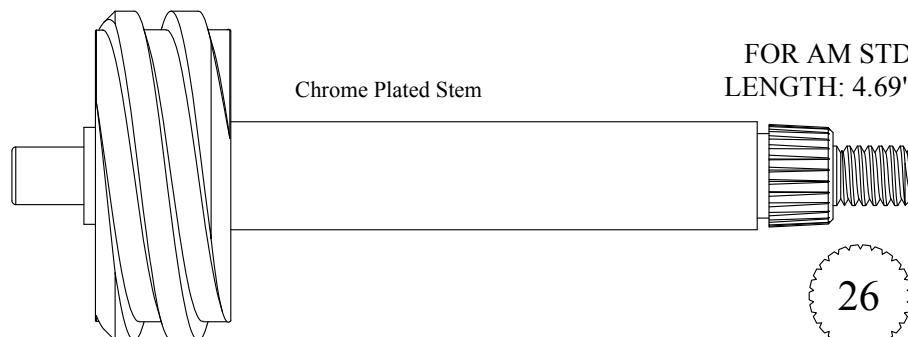

Chrome Plated Stem

FOR AM STD
LENGTH: 4.69"

26

208811

FOR PRICE PFISTER
LENGTH: 4.69"

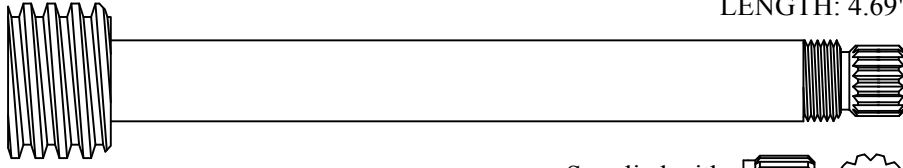

208971

Supplied with
12pt. Broach



FOR BRIGGS
LENGTH: 4.69"

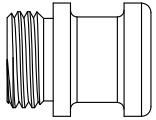

SEAT USED: LF648250

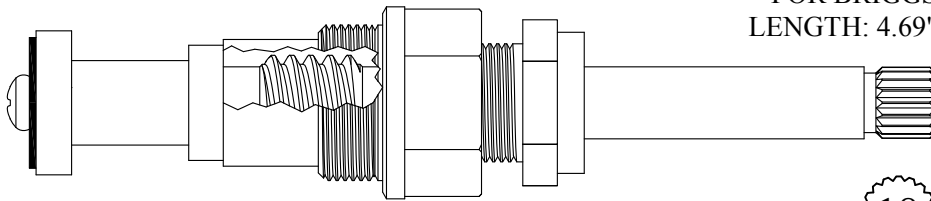

408701

GASKET: 895150



FOR BRIGGS
LENGTH: 4.69"

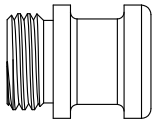

SEAT USED: LF648250

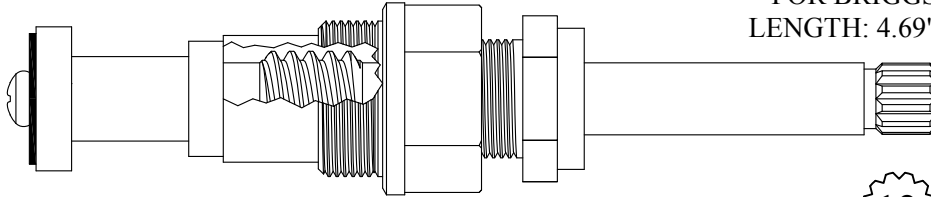

408751

GASKET: 895150



FOR AM STD
LENGTH: 4.69"

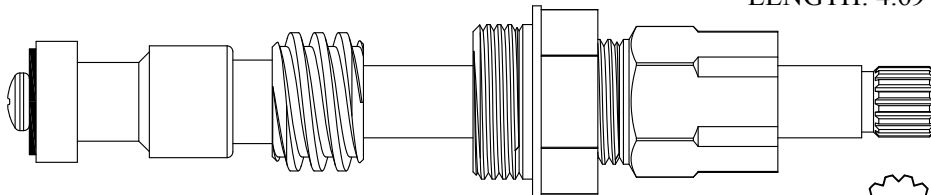

LF475201
LF275201 Stem Only



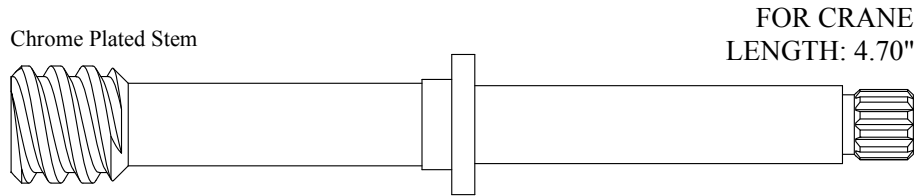

208961

12
1-2

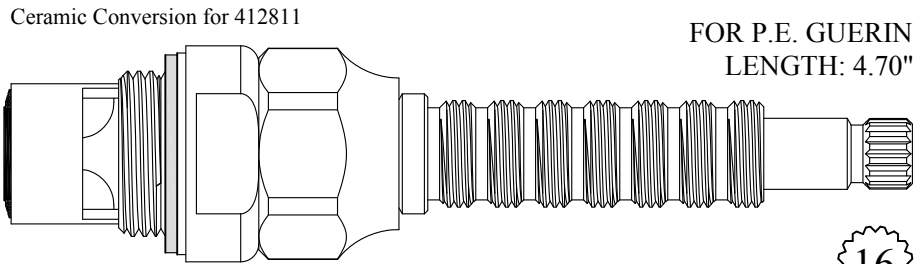

407991

GASKET: 895400 INCLUDED
SEAL: 898510
DISC SET: 151380-PKG

16
1-6

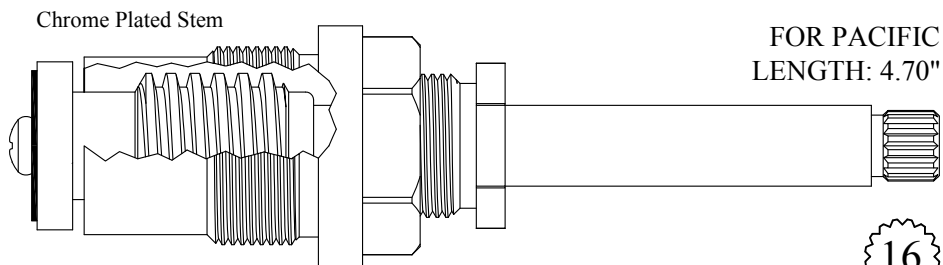

413321

213321 Stem Only

GASKET: 895540

16
1-6



404831/ 404832

GASKET: 890160 O-RING INCLUDED
DISC SET: 151380-PKG

16
2-3

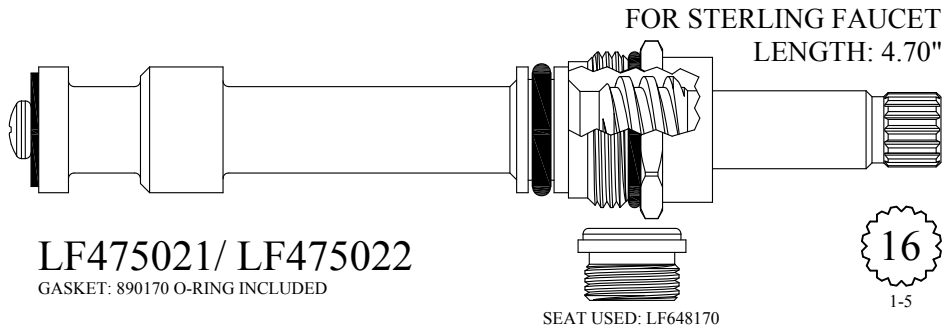

LF475021/ LF475022
 GASKET: 890170 O-RING INCLUDED

16
 1-5

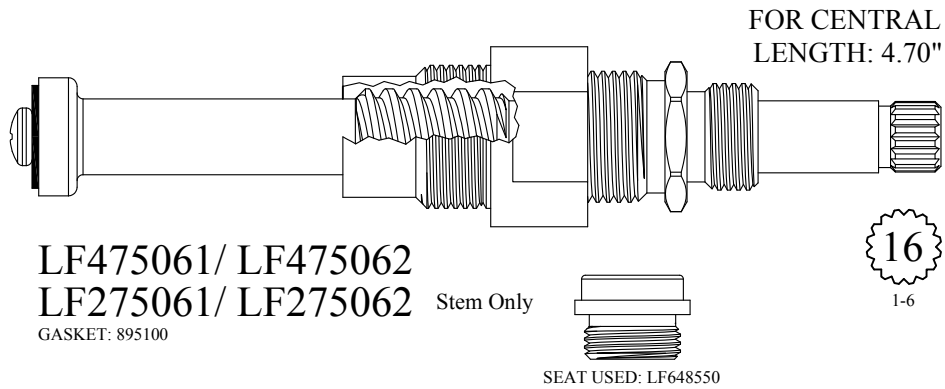

LF475061/ LF475062
LF275061/ LF275062 Stem Only
 GASKET: 895100

16
 1-6

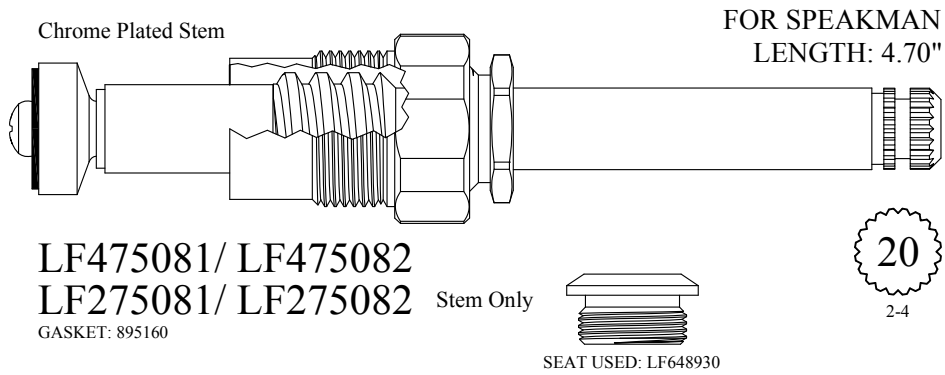

Chrome Plated Stem
LF475081/ LF475082
LF275081/ LF275082 Stem Only
 GASKET: 895160

20
 2-4

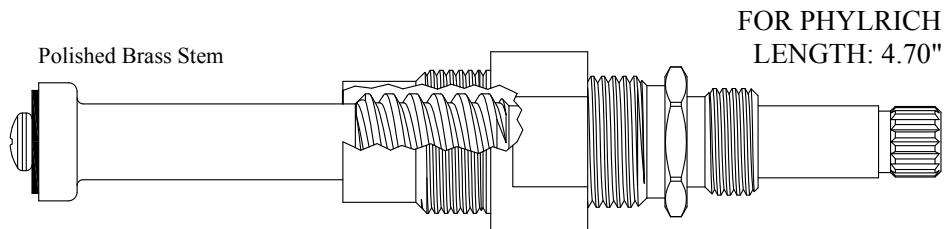

Polished Brass Stem
LF475091/ LF475092
LF275091/ LF275092 Stem Only
 GASKET: 895100

16
 1-6



Also available with chrome plated stem
LF475091-CP/ LF475092-CP
LF275091-CP/ LF275092-CP Stem Only



SEAT USED: LF648930

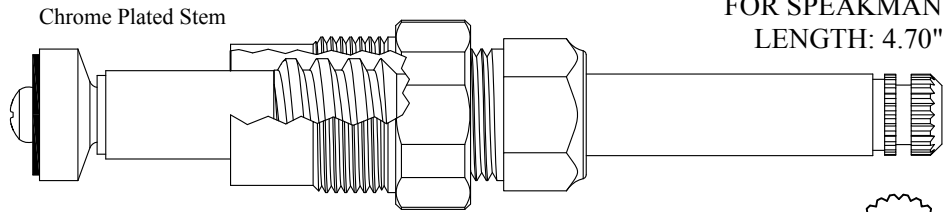

LF475121/ LF475122
 LF275081/ LF275082 Stem Only
 GASKET: 895160

20
 2-4

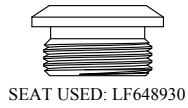

SEAT USED: LF648930

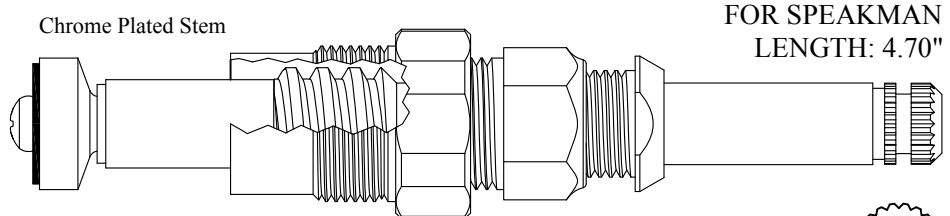

LF475131/ LF475132
 LF275081/ LF275082 Stem Only
 GASKET: 895160

20
 2-4

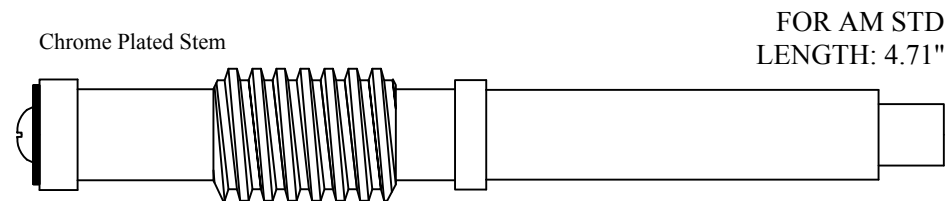

208951

Supplied with
 12pt. Broach



12
 1-2

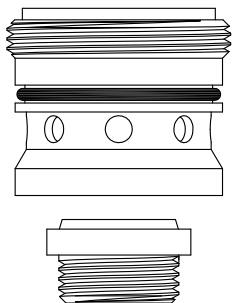

SEAT KIT USED: 106090

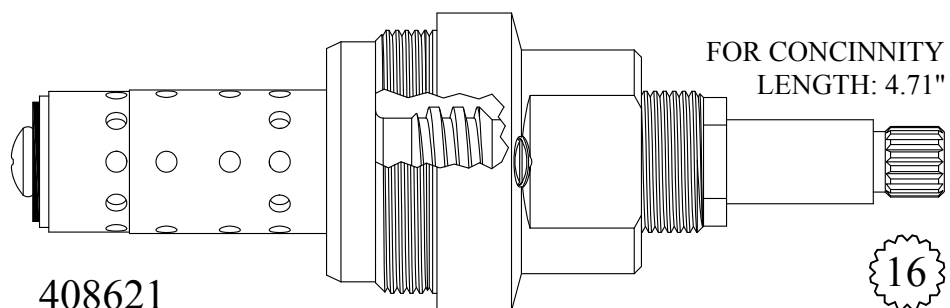

408621
 208621 Stem Only
 GASKET INCLUDED: 895500

16
 1-6

FOR AM STD
LENGTH: 4.71"

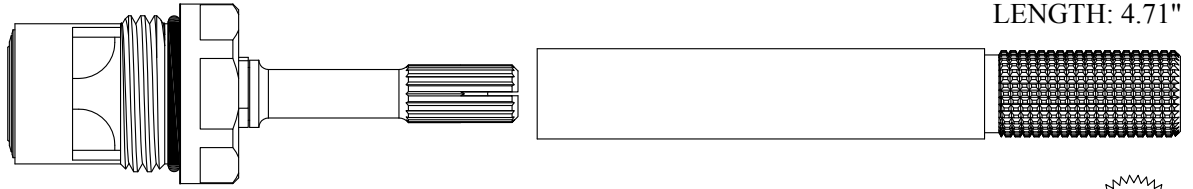

419211
SEAL: 898510-W
DISC SET: 151380-PKG

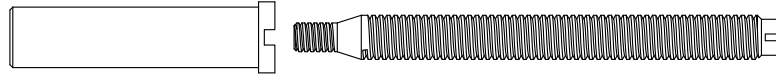

34

FOR ELJER
LENGTH: 4.72"

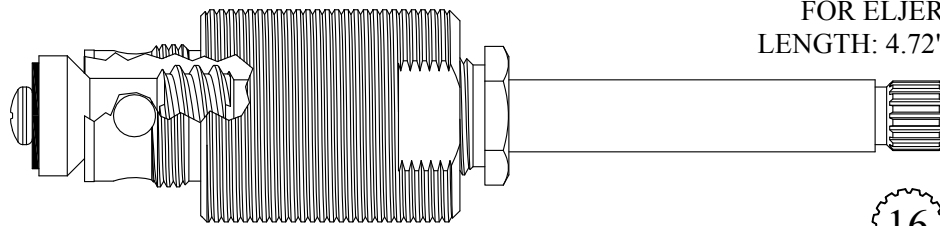

430321
231001 Stem Only
GASKET: 895100

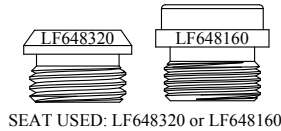

16
3-15

SEAT USED: LF648320 or LF648160

FOR ELJER
LENGTH: 4.72"

Chrome Plated Sleeve

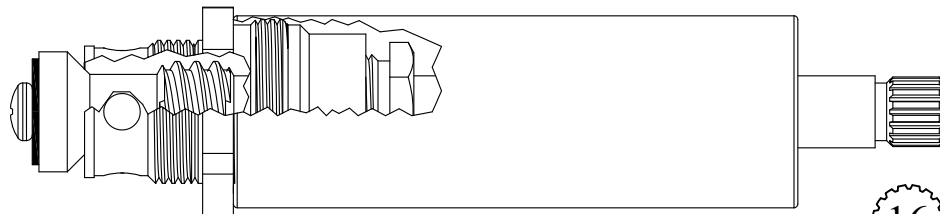

431001
231001 Stem Only
GASKET: 895100

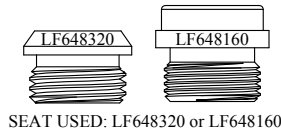

16
3-15

SEAT USED: LF648320 or LF648160

FOR ELJER
LENGTH: 4.72"

Chrome Plated Gland



431021
231001 Stem Only
GASKET: 895100

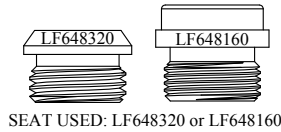

16
3-15

SEAT USED: LF648320 or LF648160

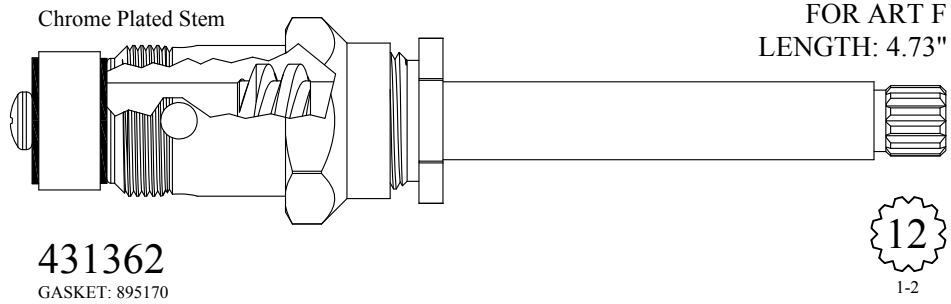

431362
GASKET: 895170

12
1-2

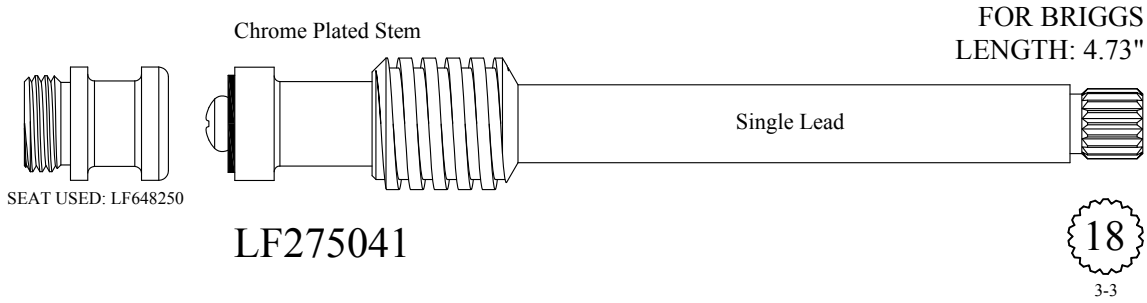

SEAT USED: LF648250

LF275041

18
3-3

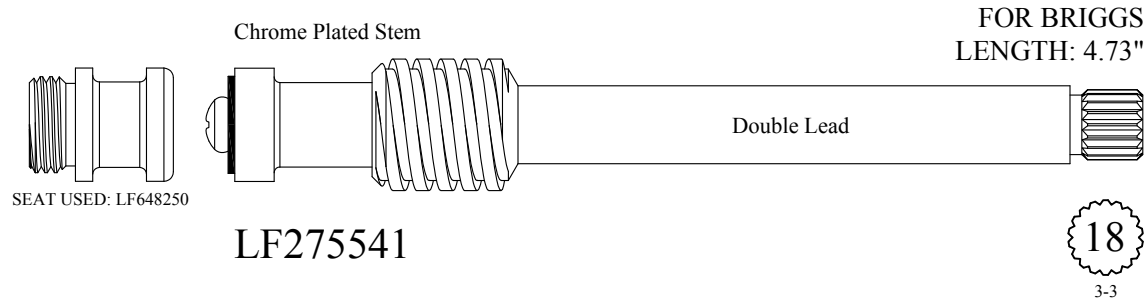

SEAT USED: LF648250

LF275541

18
3-3

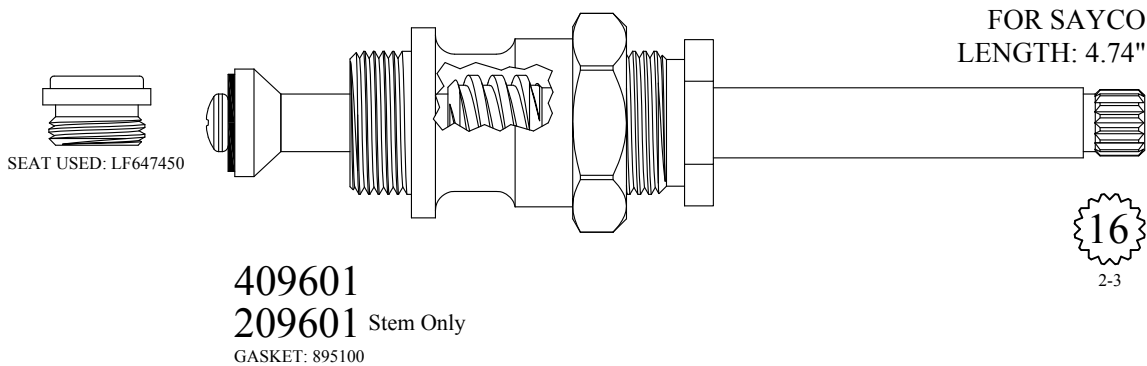

SEAT USED: LF647450

409601
209601 Stem Only
GASKET: 895100

16
2-3

SEAT USED: LF647450

Chrome Plated Stem

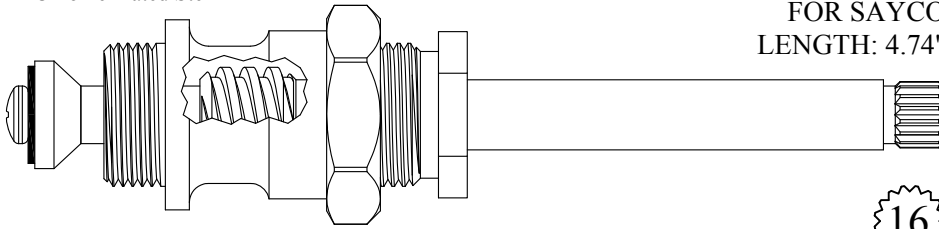

FOR SAYCO
LENGTH: 4.74"

16
2-3

409611
209611 Stem Only
GASKET: 895100

Plastic Escutcheon Nipple

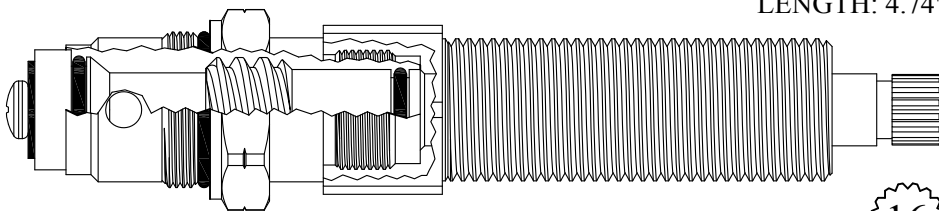

FOR KOHLER
LENGTH: 4.74"

16
1-6

430941
GASKET: 890170 O-RING INCLUDED

FOR UNION BRASS
LENGTH: 4.74"

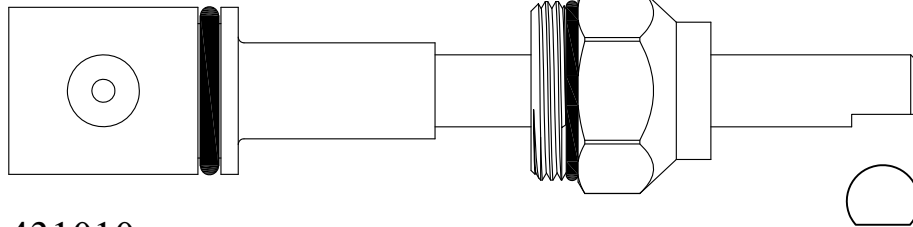

431010
231010 Stem Only
GASKET: 890190 O-RING INCLUDED

FOR UNION BRASS
LENGTH: 4.74"

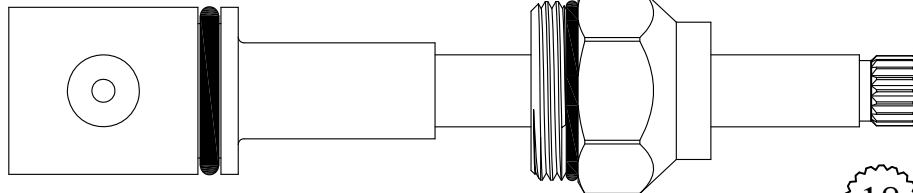

431060
GASKET: 890190 O-RING INCLUDED

18
3-3

Chrome Plated Stem

FOR CRANE
LENGTH: 4.75"



212511



Chrome Plated Stem

FOR SAYCO
LENGTH: 4.75"

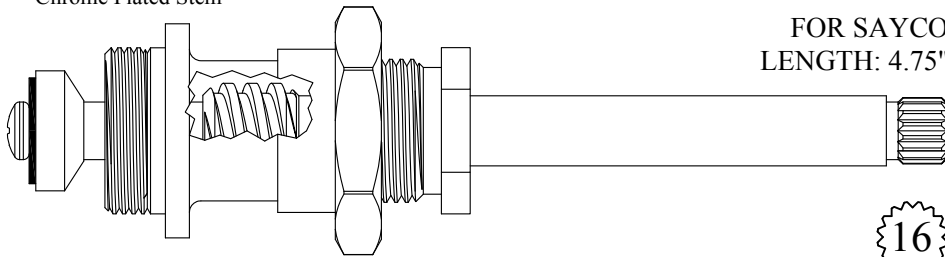
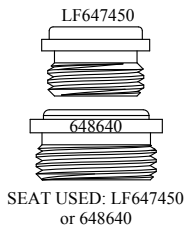

409801
209801 Stem Only
GASKET: 895400



FOR KALLISTA
LENGTH: 4.75"

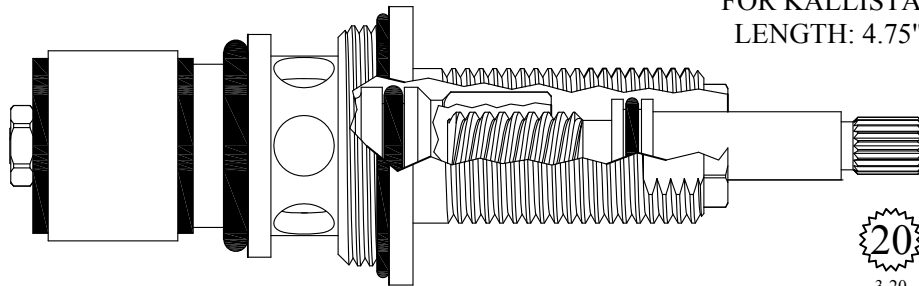

430782
GASKET: 890240 O-RING INCLUDED



Chrome Plated Stem

FOR KOHLER
LENGTH: 4.75"

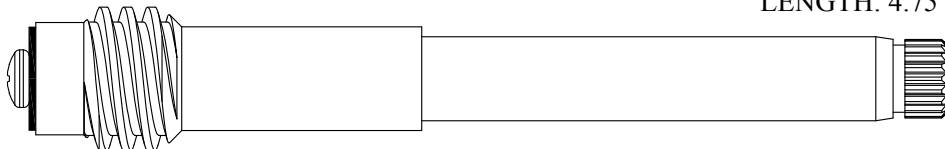
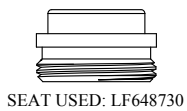

LF276011/ LF276012



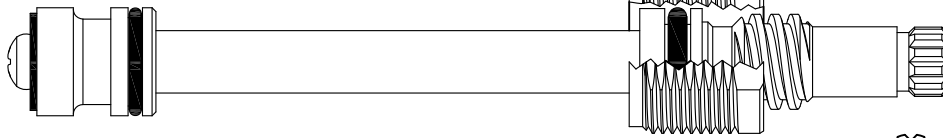

FOR HARCRAFT
LENGTH: 4.75"

LF475071

GASKET: 895040 INCLUDED



Chrome Plated Stem

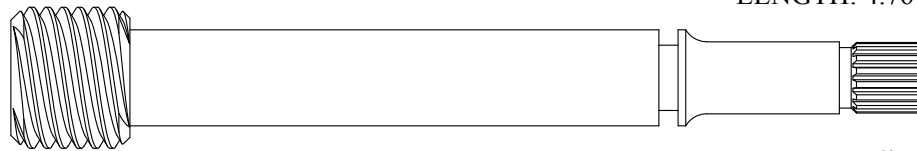

FOR MILWAUKEE
LENGTH: 4.76"

231331

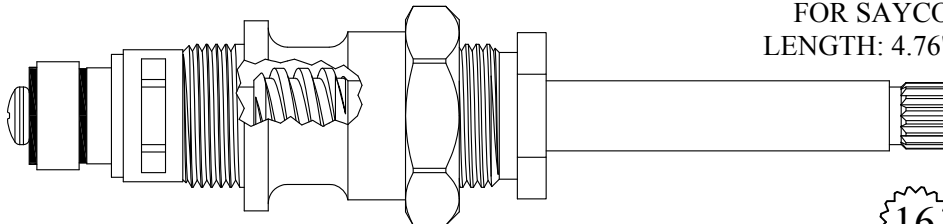

FOR SAYCO
LENGTH: 4.76"

431201

231201 Stem Only

GASKET: 895100

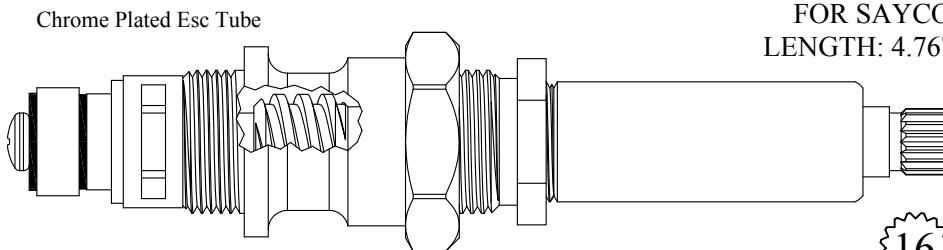

FOR SAYCO
LENGTH: 4.76"

431221

231201 Stem Only

GASKET: 895100



SEAT USED: LF647450

Chrome Plated Stem

FOR SAYCO
LENGTH: 4.76"

16
2-3

431341
231341 Stem Only
GASKET: 895100

FOR WATERWORKS
LENGTH: 4.76"

20
3-20

409941/ 409942
GASKET: 890210 O-RING INCLUDED
SEAL: 898520
DISC SET: 109850-PKG

FOR WATERWORKS
LENGTH: 4.76"

20
3-20

409941-EN/ 409942-EN Escutcheon Nipple available separately
127350
GASKET: 890210 O-RING INCLUDED
SEAL: 898520
DISC SET: 109850-PKG

SEAT USED: LF647450
or 648640

Chrome Plated Stem

FOR SAYCO
LENGTH: 4.77"

16
2-3

431401
231401 Stem Only
GASKET: 895400

Stem also available less cage
231401-1

FOR SPEAKMAN
LENGTH: 4.77"

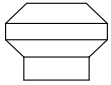

SEAT USED: 649110



LF275900

FOR BEAR BRAND
LENGTH: 4.78"

Chrome Plated Unit

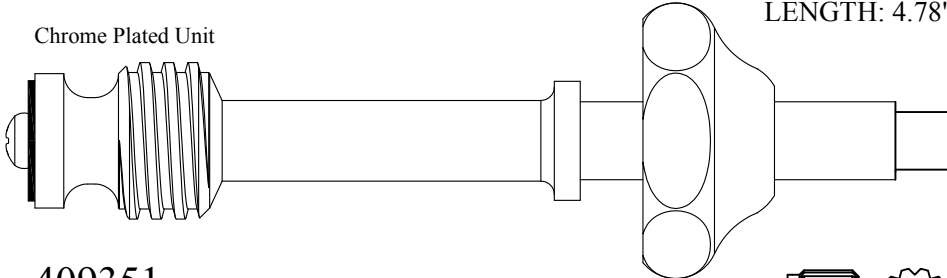

409351
209351 Stem Only

Supplied with
12pt. Broach

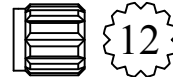

12

1-2

Chrome Plated Stem
18 TPI Gland

FOR UNION BRASS
LENGTH: 4.78"

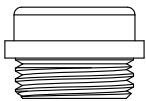

SEAT USED: LF649930

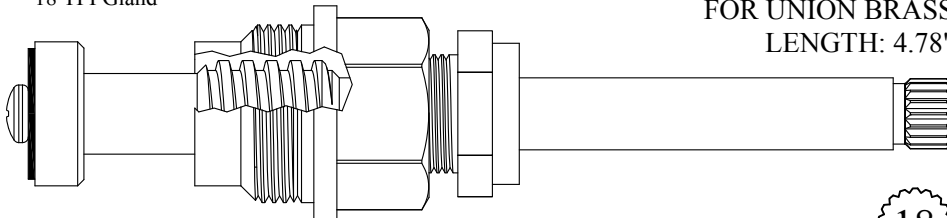

409701
209701 Stem Only
GASKET: 895370

18

3-3

Chrome Plated Stem
20 TPI Gland

FOR UNION BRASS
LENGTH: 4.78"



SEAT USED: LF649930

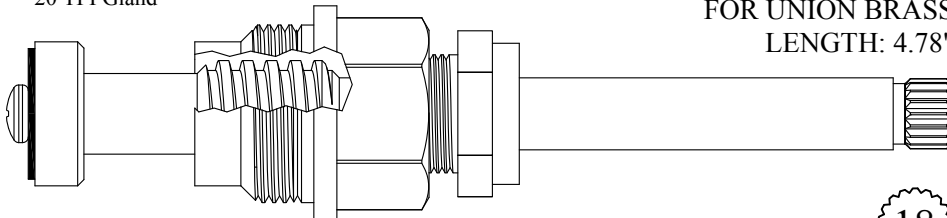

409711
209701 Stem Only
GASKET: 895370

18

3-3



SEAT USED: LF648760

Chrome Plated Stem

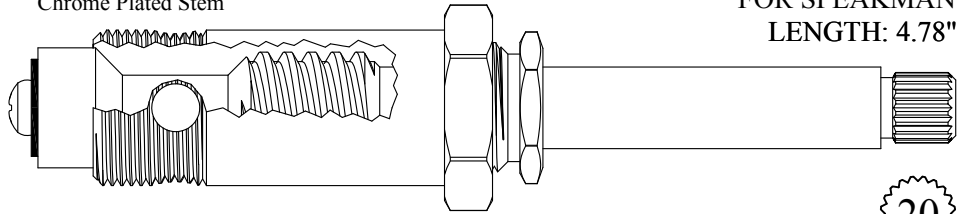

FOR SPEAKMAN
LENGTH: 4.78"

431141
231141 Stem Only



SEAT USED: LF648760

Chrome Plated Stem

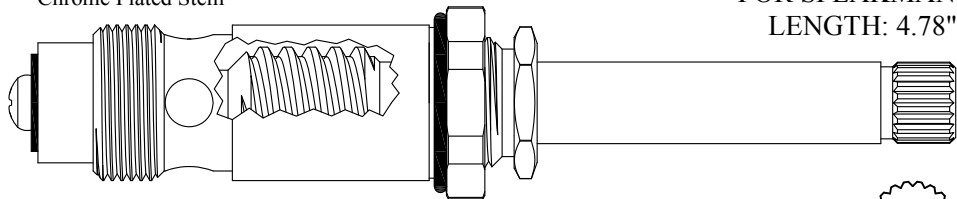

FOR SPEAKMAN
LENGTH: 4.78"

431191
231191 Stem Only
GASKET: 890180 O-RING INCLUDED

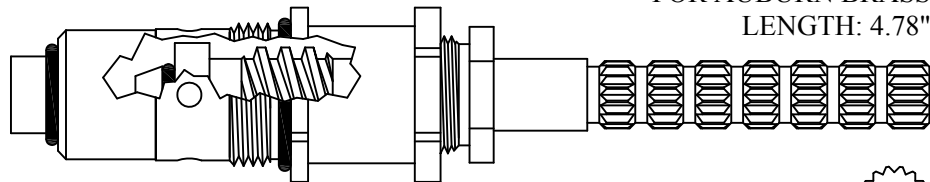

FOR AUBURN BRASS
LENGTH: 4.78"

409921/ 409922
GASKET: 890160 O-RING INCLUDED



Chrome Plated Stem

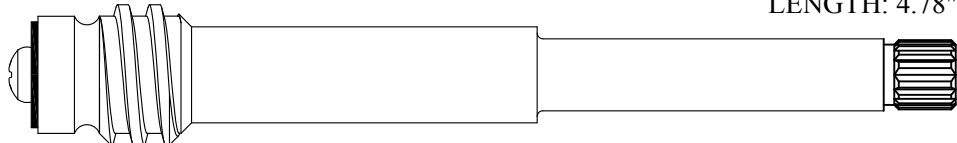

FOR MUELLER
LENGTH: 4.78"

LF274061

Supplied with
12pt. Broach



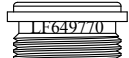
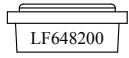

SEAT USED:
LF648200
or LF649770

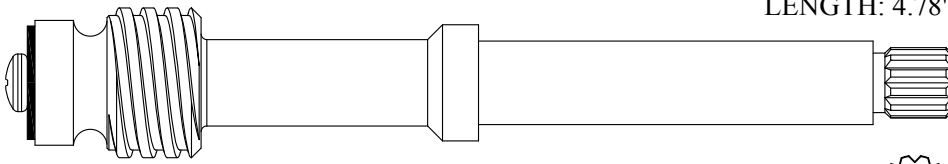

FOR CRANE
LENGTH: 4.78"

LF275031/ LF275032

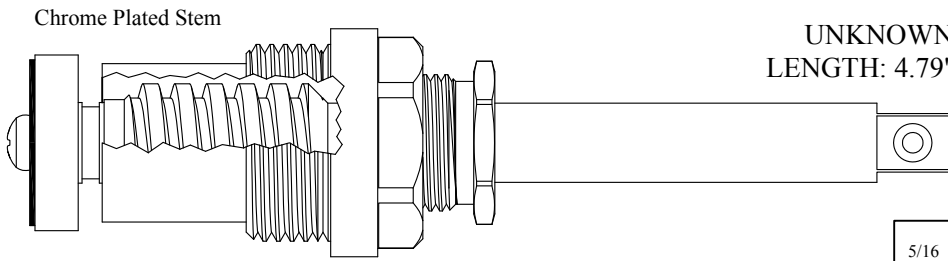

Chrome Plated Stem

UNKNOWN
LENGTH: 4.79"

406931
206931 Stem Only
GASKET: 895560

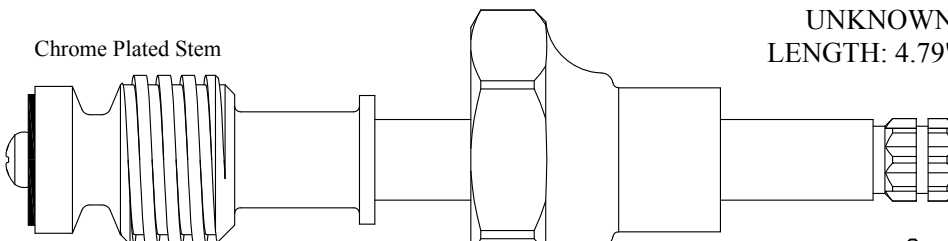

Chrome Plated Stem

UNKNOWN
LENGTH: 4.79"

414521
214521 Stem Only

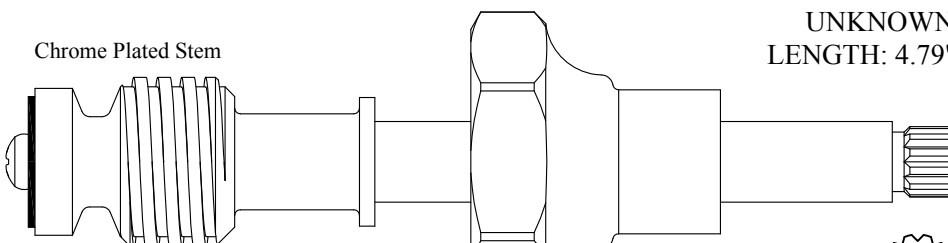

Chrome Plated Stem

UNKNOWN
LENGTH: 4.79"

414571
214571 Stem Only



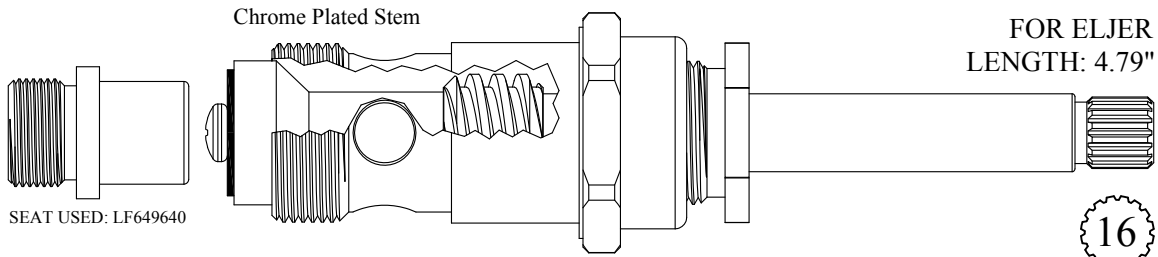

SEAT USED: LF649640

Chrome Plated Stem

FOR ELJER
LENGTH: 4.79"

16
3-15

431301
231301 Stem Only
GASKET: 895320

Also available with
Polished Brass stem
431301-PB
231301-PB Stem Only

12
1-2

Also available with 12pt broach
431351
231351 Stem Only

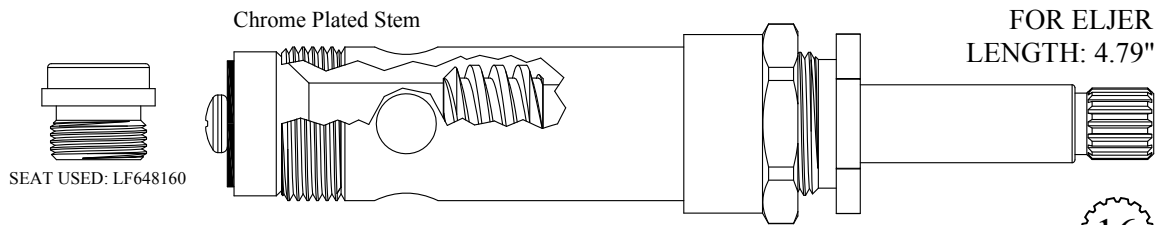

SEAT USED: LF648160

Chrome Plated Stem

FOR ELJER
LENGTH: 4.79"

16
3-15

431321
231301 Stem Only
GASKET: 895150

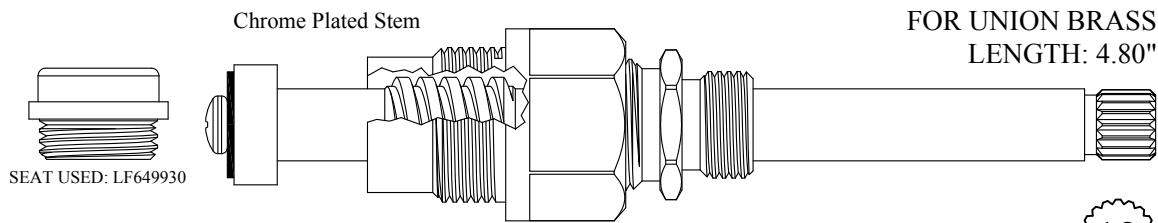

SEAT USED: LF649930

Chrome Plated Stem

FOR UNION BRASS
LENGTH: 4.80"

18
3-3

409811/ 409812
209811/ 209812 Stem Only
GASKET: 895150

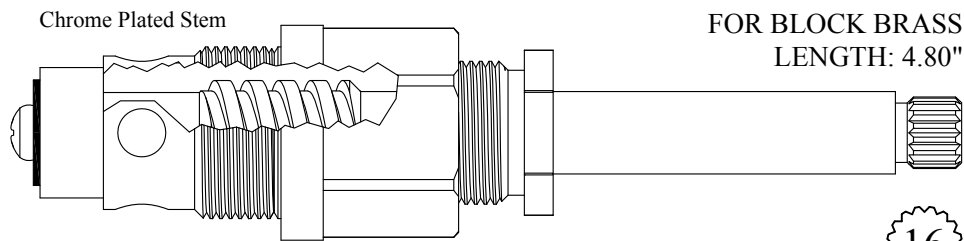

Chrome Plated Stem

FOR BLOCK BRASS
LENGTH: 4.80"

16
1-6

431041
231041 Stem Only
GASKET: 895290

FOR STREAMWAY
LENGTH: 4.80"

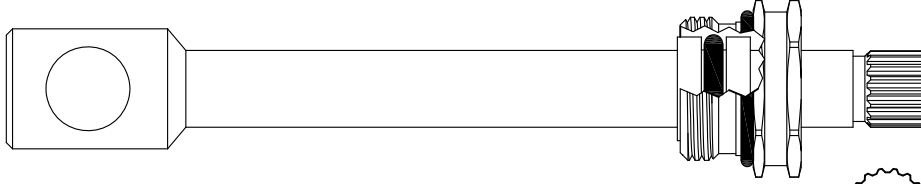

431310
231310 Stem Only
GASKET: 890170 O-RING INCLUDED

17
3-7

FOR WOLVERINE
LENGTH: 4.80"

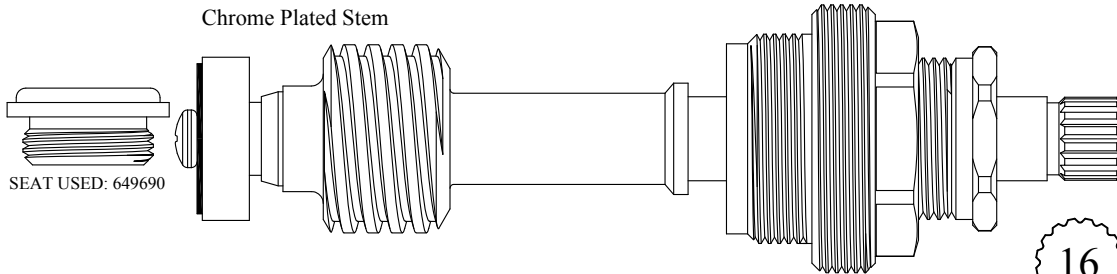

SEAT USED: 649690

410101/ 410102
210101/ 210102 Stem Only
GASKET: 895450

16
3-26

FOR WOLVERINE
LENGTH: 4.80"

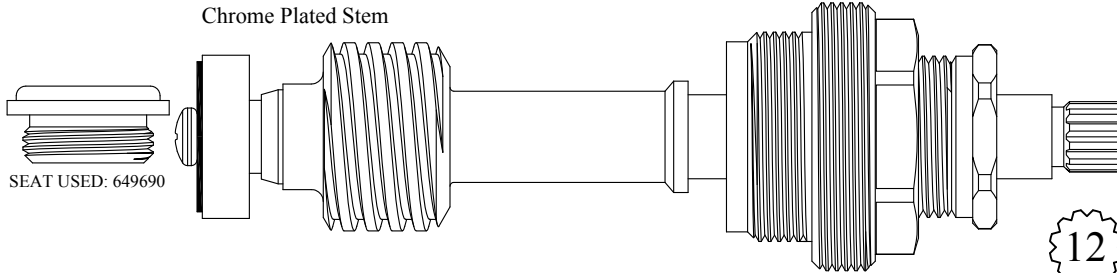

SEAT USED: 649690

410151/ 410152
210151/ 210152 Stem Only
GASKET: 895450

12
1-2

FOR DICK BROS.
LENGTH: 4.81"

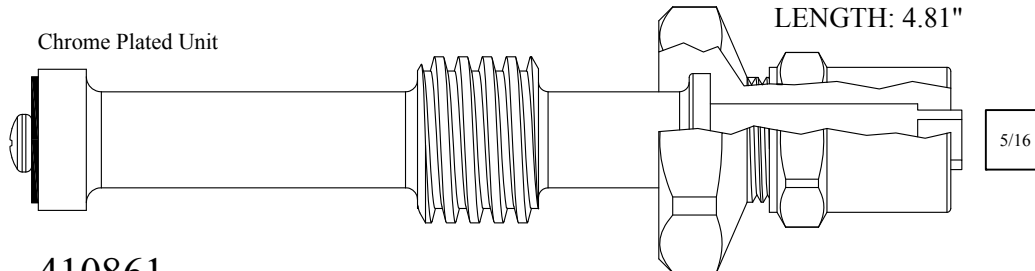

5/16

410861
210861 Stem Only
GASKET: 895400 INCLUDED

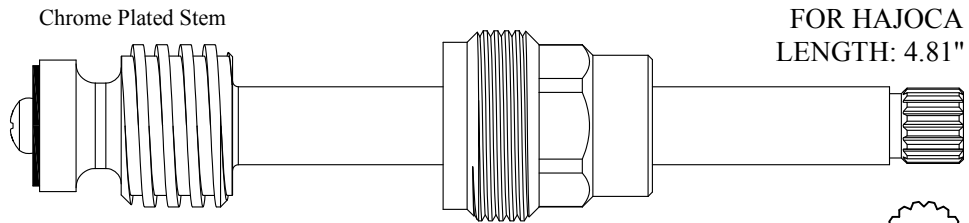

Chrome Plated Stem

FOR HAJOCA
LENGTH: 4.81"

415321
215321 Stem Only

16
1-5

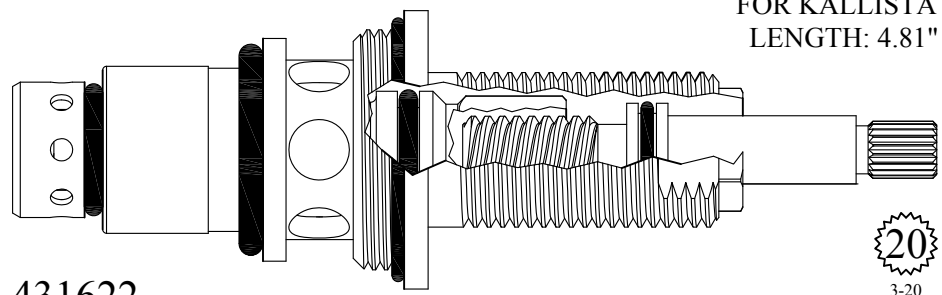

FOR KALLISTA
LENGTH: 4.81"

431622
GASKET: 890240 O-RING INCLUDED

20
3-20

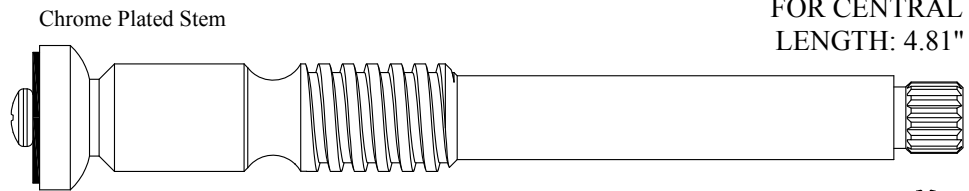

Chrome Plated Stem

FOR CENTRAL
LENGTH: 4.81"

LF276101

16
1-6

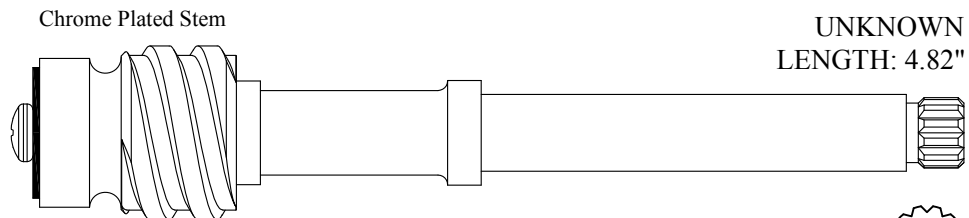

Chrome Plated Stem

UNKNOWN
LENGTH: 4.82"

209451

12
1-2

USES BARREL:
LF647021/LF647022

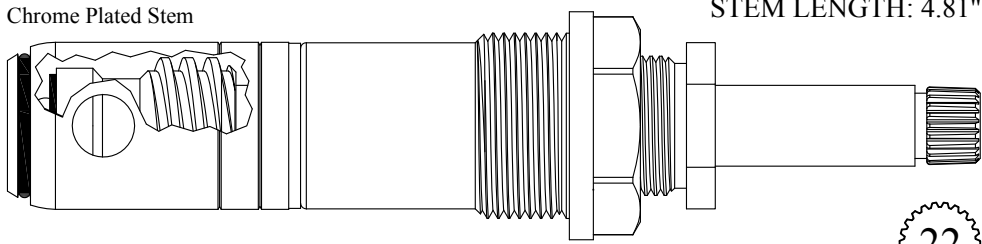

LF476031/ LF476032
LF276031/ LF276032 Stem Only **LF476231/ LF476232**
GASKET: 818010

Also available less barrel



USES BARREL:
LF647021/LF647022

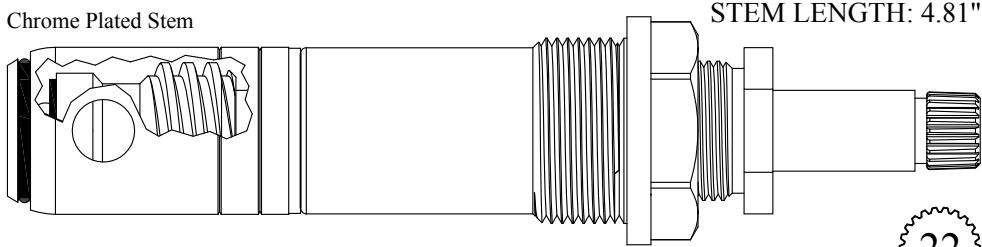

LF476041/ LF476042
LF276031/ LF276032 Stem Only **LF476241/ LF476242**
GASKET: 818010

Also available less barrel



USES BARREL:
LF647021/LF647022

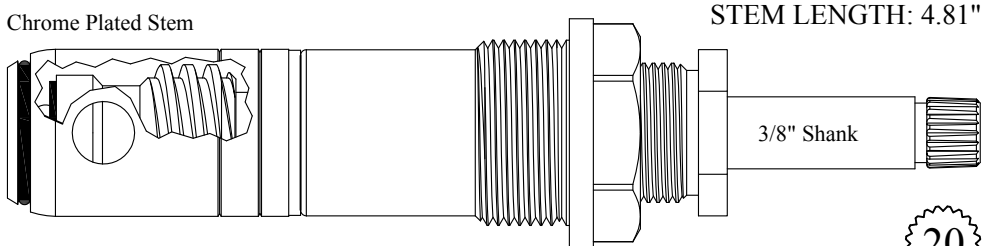

LF476131/ LF476132
LF276131/ LF276132 Stem Only **LF476331/ LF476332**
GASKET: 818010

Also available less barrel



USES BARREL:
LF647021/LF647022

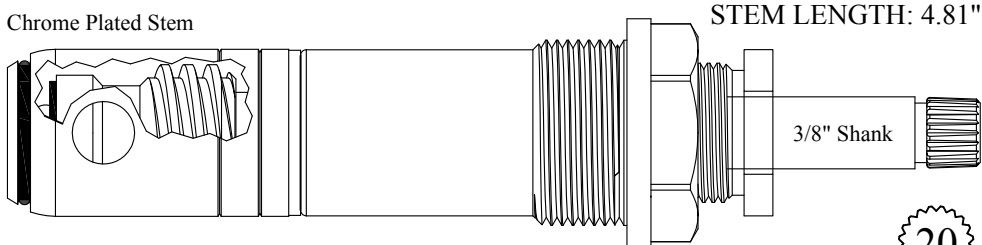

LF476141/ LF476142
LF276131/ LF276132 Stem Only **LF476341/ LF476342**
GASKET: 818010

Also available less barrel



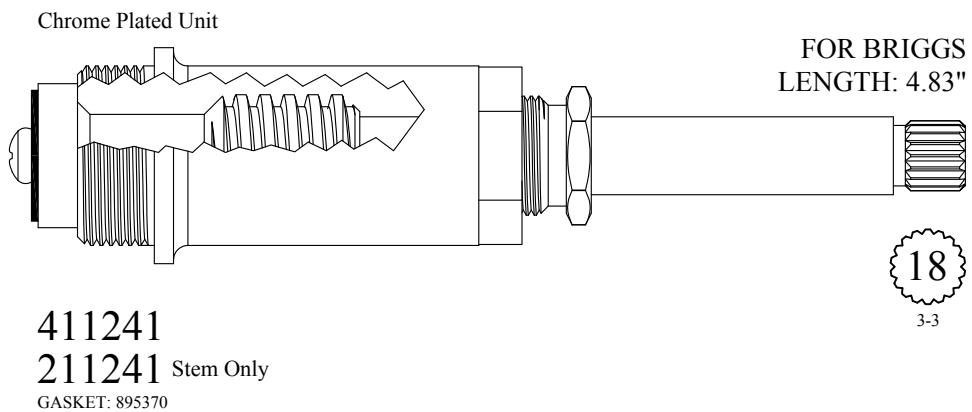
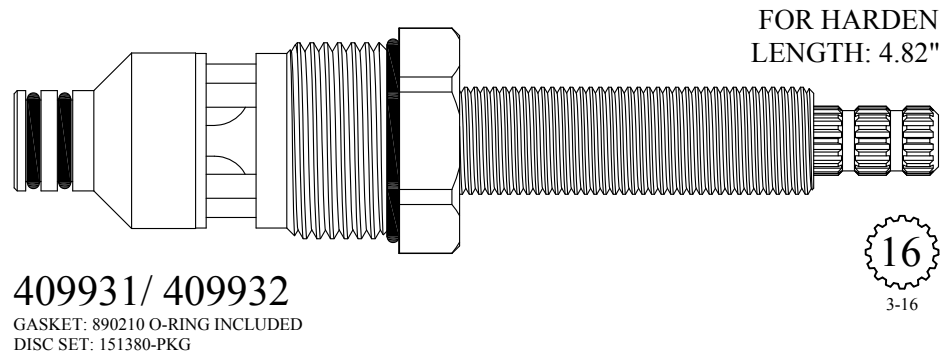
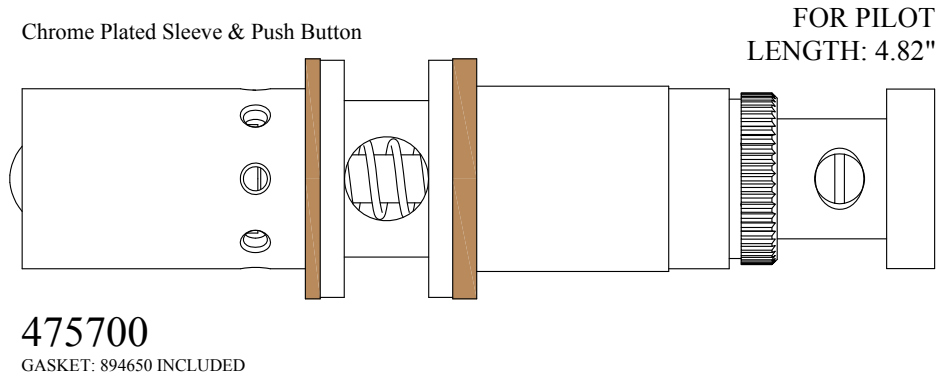
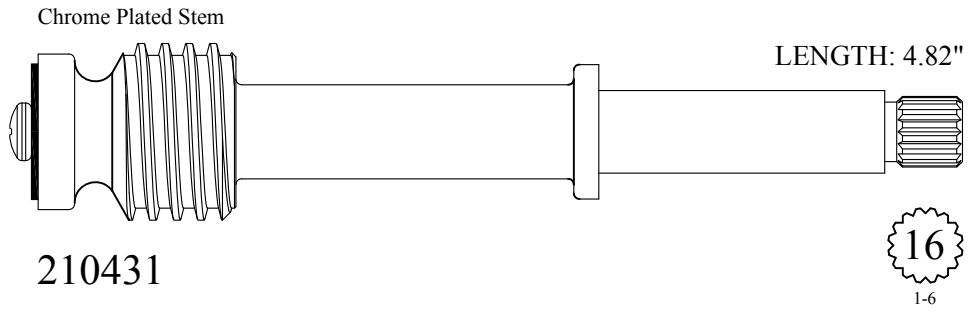

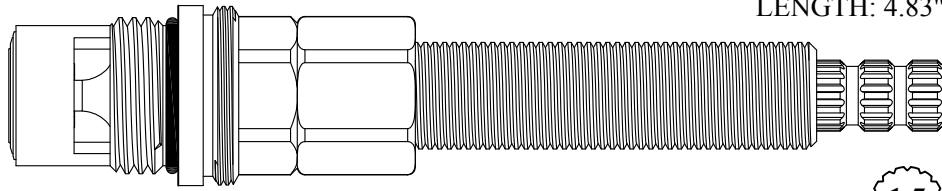

FOR SEPCO
LENGTH: 4.83"

410031/ 410032

GASKET: 890170 O-RING INCLUDED
SEAL: 898510-W
DISC SET: 151380-PKG

15
3-27

Polished Brass Stem Extension

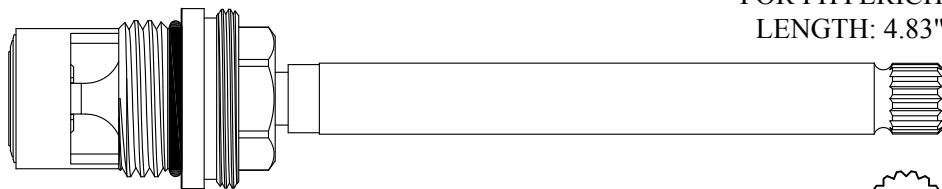

FOR PHYLRICH
LENGTH: 4.83"

Individual items available
Stem Ext. 3.25": #132150-PB
& 132150-CP
Ext. Adap. Screw: #103310

410061/ 410062

GASKET: 890170 O-RING INCLUDED
SEAL: 898510-W
DISC SET: 151380-PKG

Also available with chrome plated stem
410061-CP/ 410062-CP

16
1-6

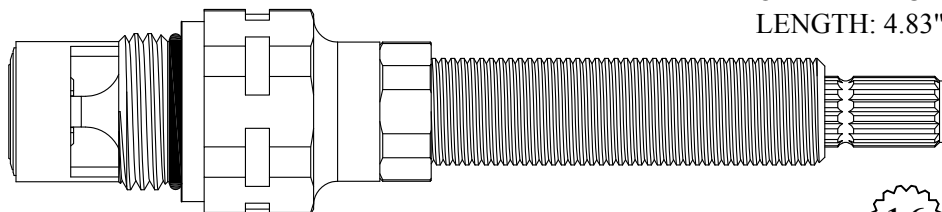

FOR PHYLRICH
LENGTH: 4.83"

Individual items available
Stem Ext. 3.25": #102960
Ext. Adap. Screw: #103310

410081/ 410082

GASKET: 890170 O-RING INCLUDED
SEAL: 898510-W
DISC SET: 151380-PKG

16
1-6

Chrome Plated Stem

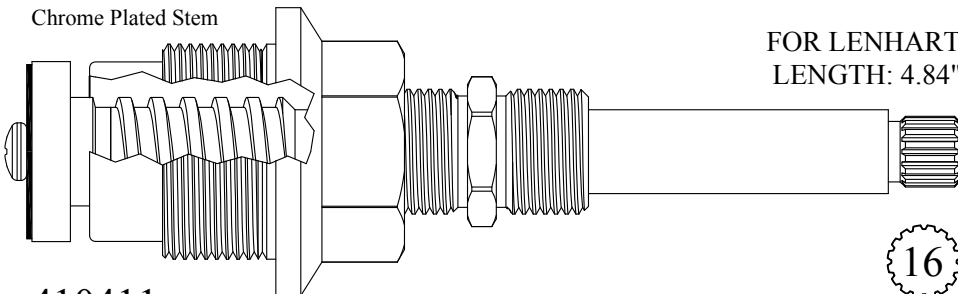

FOR LENHART
LENGTH: 4.84"

410411

210411 Stem Only

GASKET: 895450

16
3-15

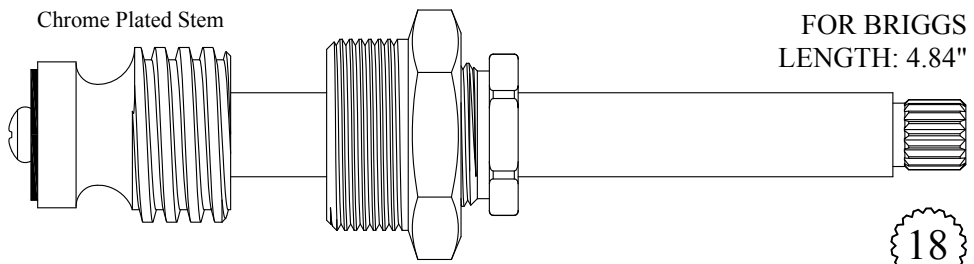

410901
210901 Stem Only
GASKET: 895340

18
3-3

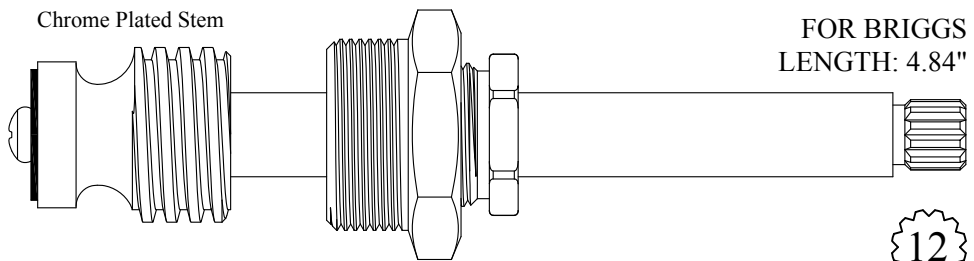

410951
210951 Stem Only
GASKET: 895340

12
1-2

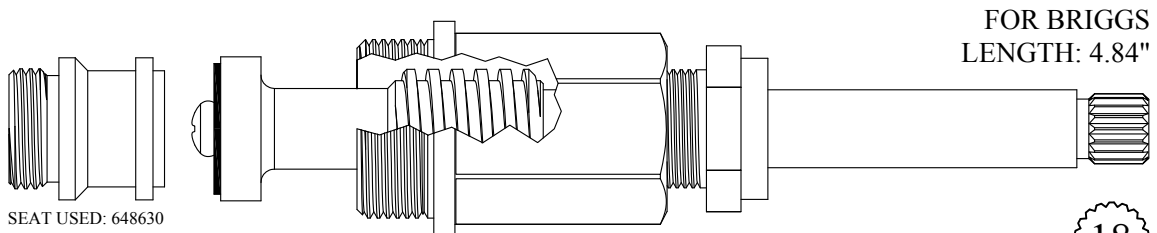

411201
211201 Stem Only
GASKET: 895370

18
3-3

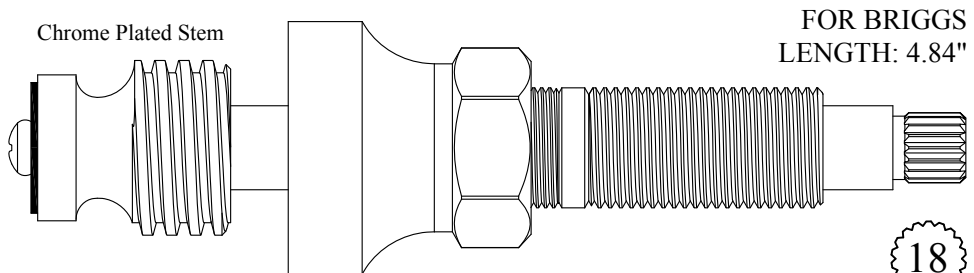

412101
210901 Stem Only

18
3-3

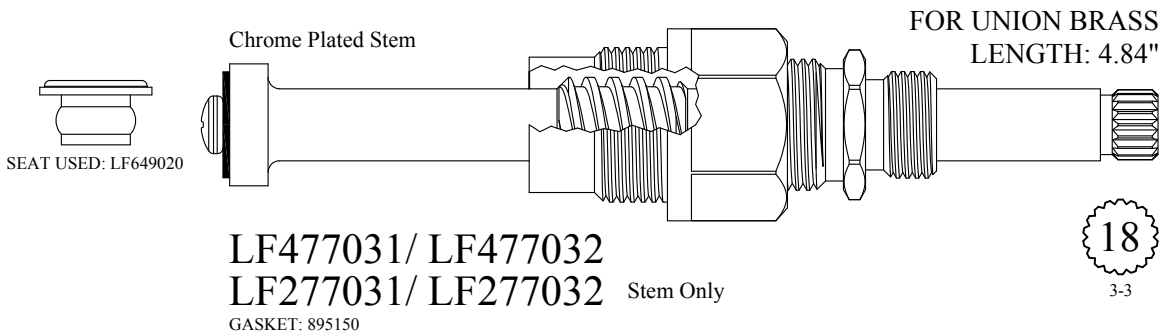
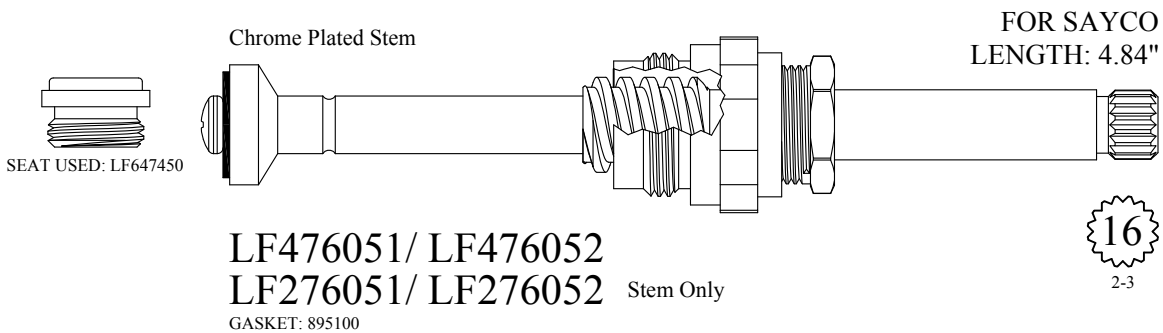
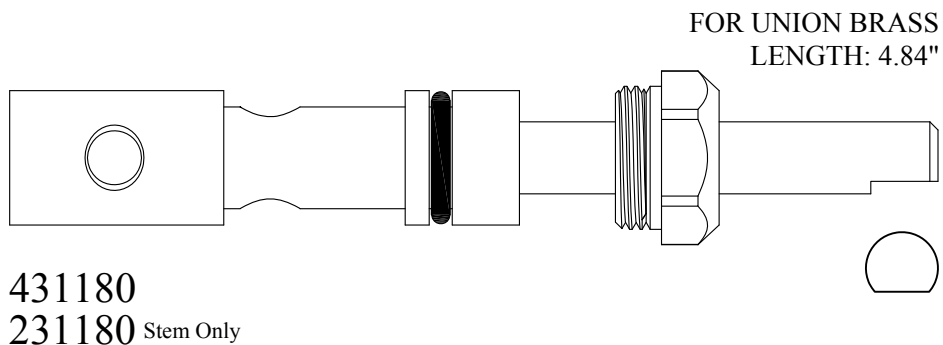
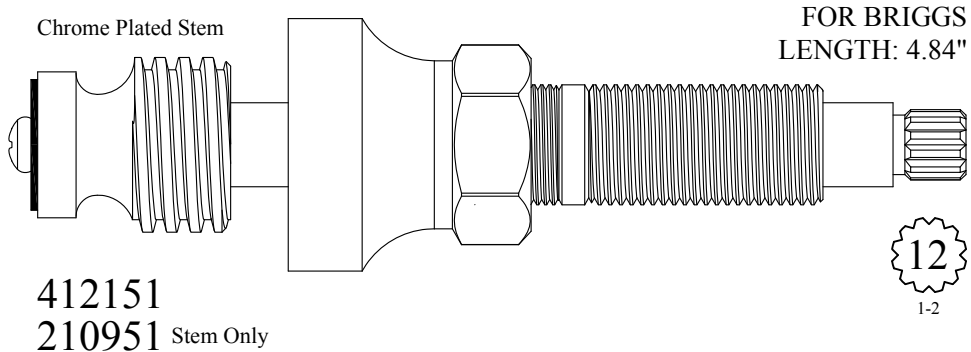

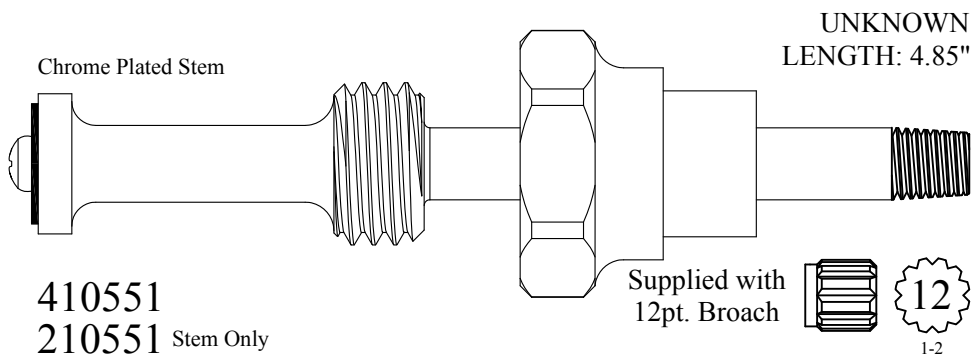
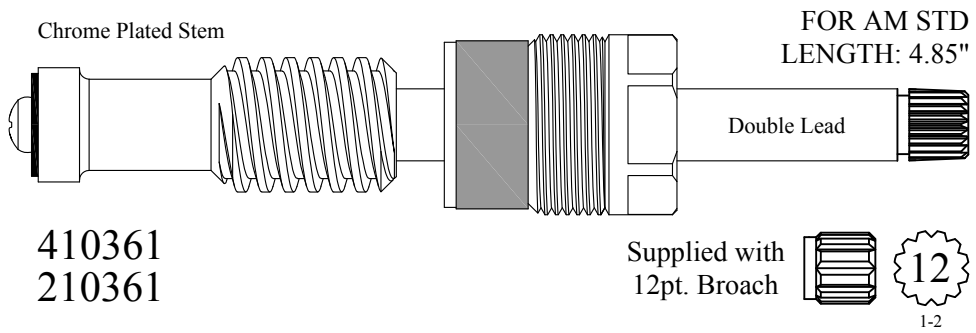
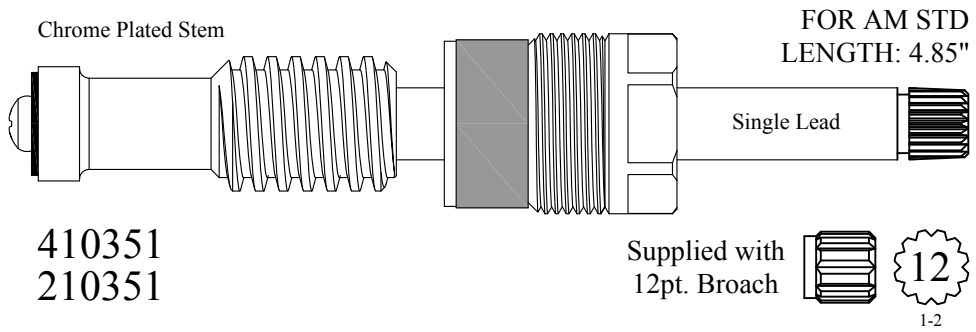
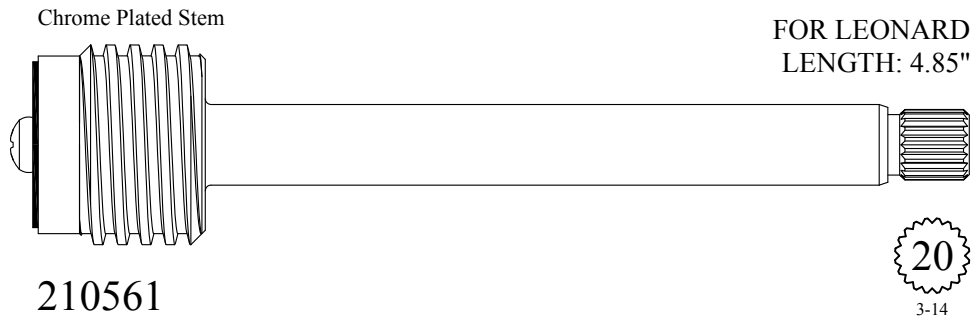

Comes with handle screw:
899230

FOR KALLISTA
LENGTH: 4.85"

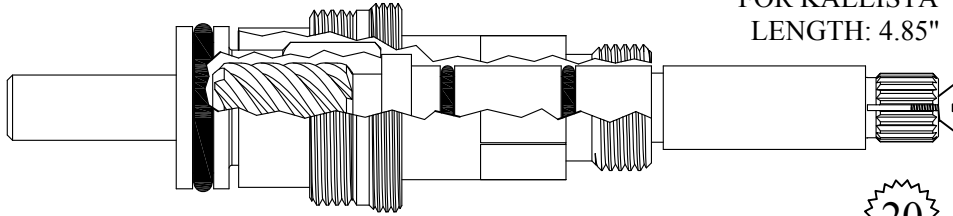

434201



Nickel Plated Stem

FOR PRICE PFISTER
LENGTH: 4.85"



LF477201/ LF477202



Stainless Steel Shank

FOR ACORN
LENGTH: 4.86"

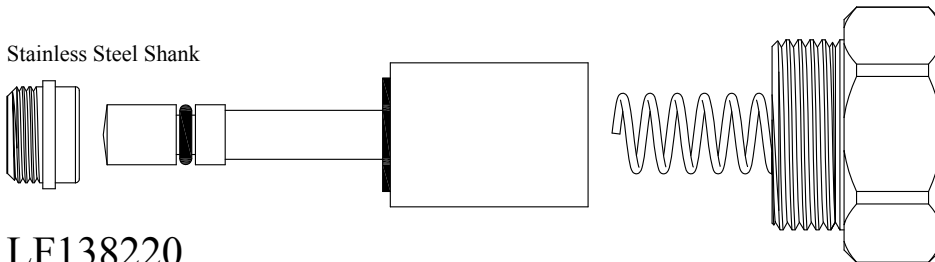

LF138220

GASKET INCLUDED: 895550
SEAT INCLUDED: LF647560

Chrome Plated Unit

FOR BRIGGS
LENGTH: 4.86"

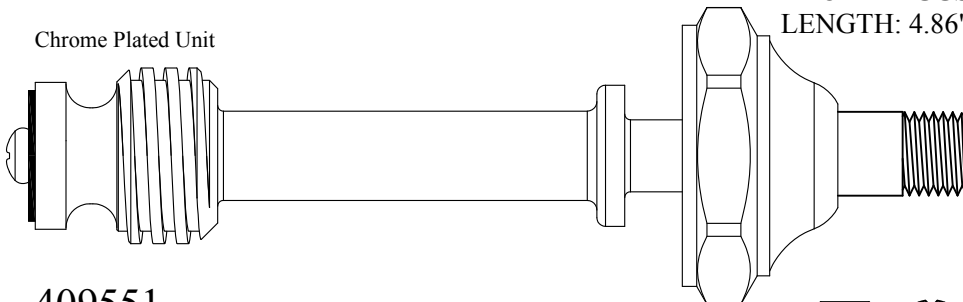

409551
209551 Stem Only

Supplied with
12pt. Broach

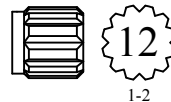

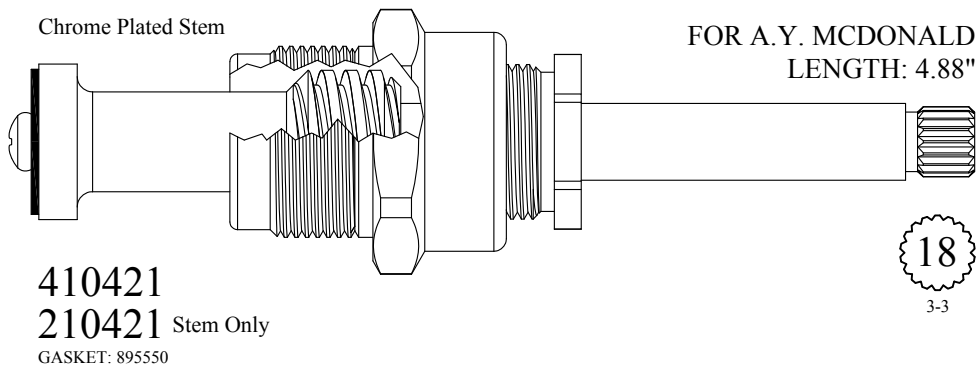
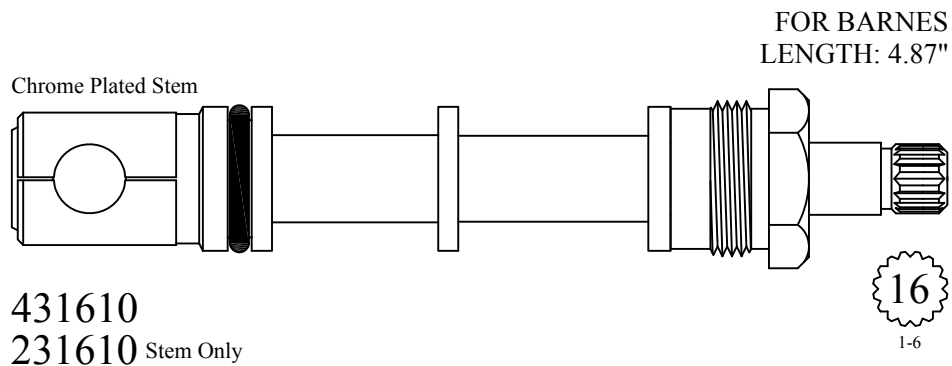
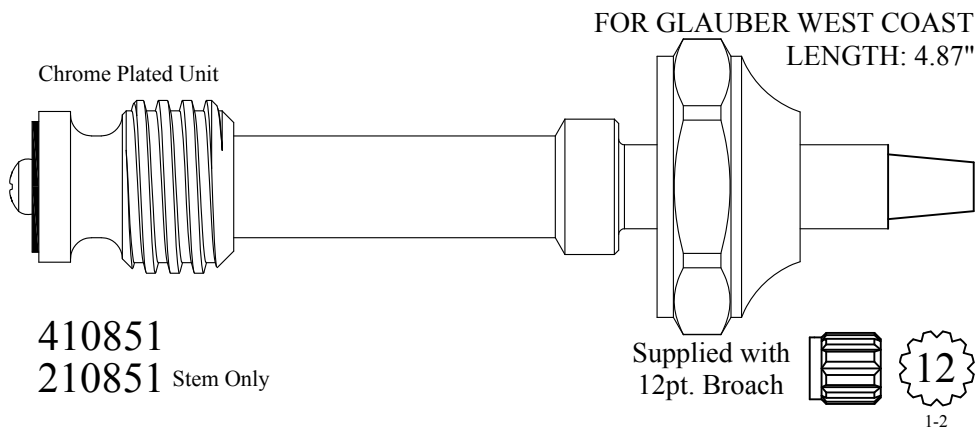
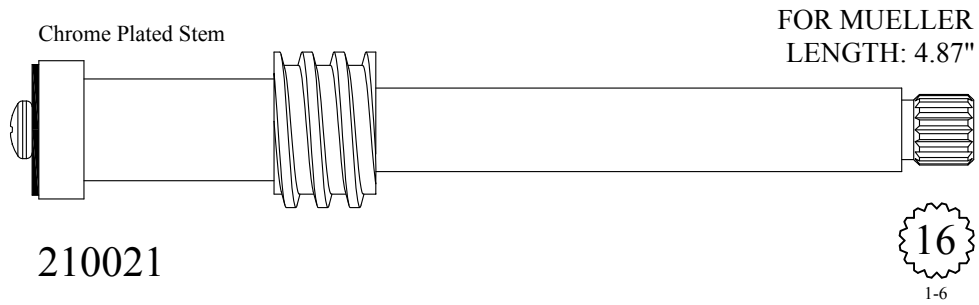

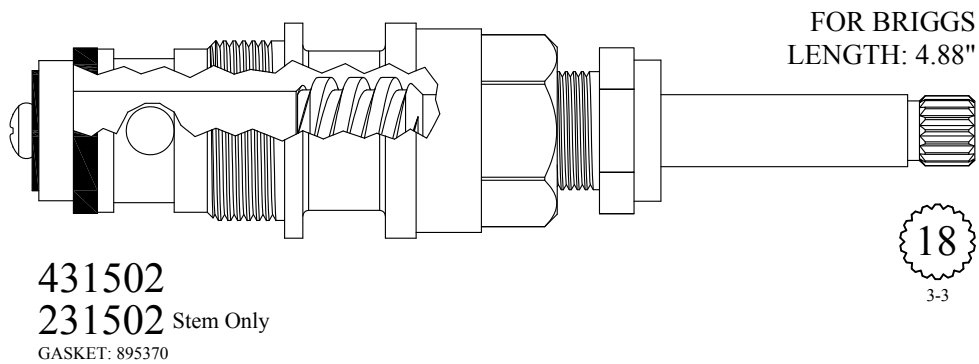
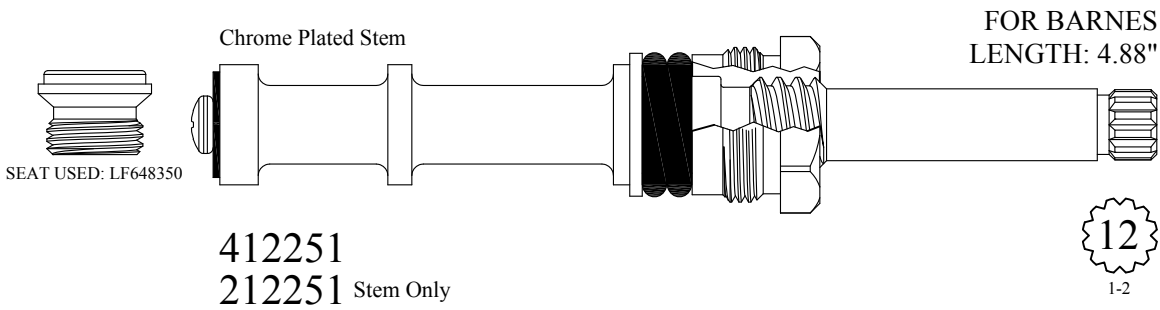
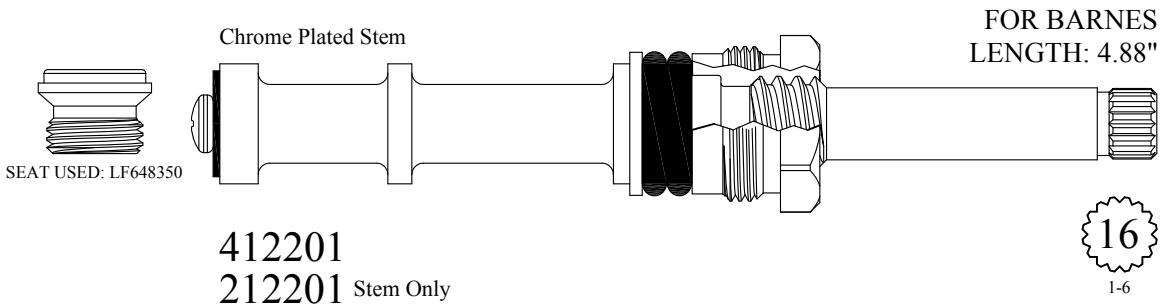
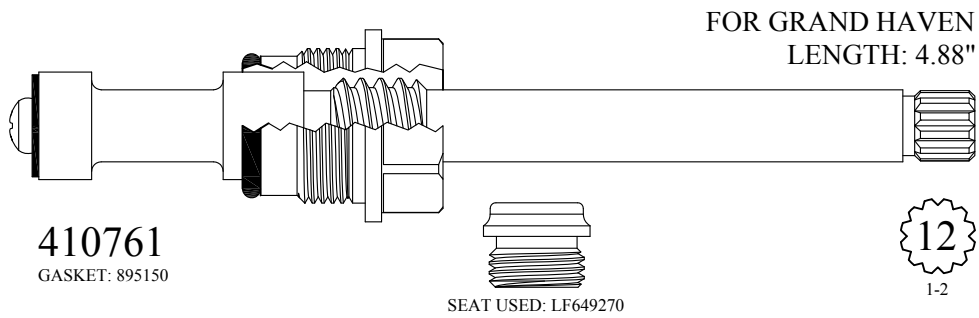

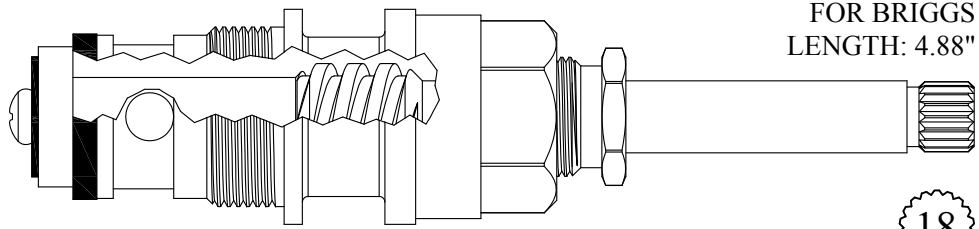

FOR BRIGGS
LENGTH: 4.88"

18
3-3

431512
231502 Stem Only
GASKET: 895370

FOR HOT & COLD STEM USE PRICE PFISTER 405111/405112

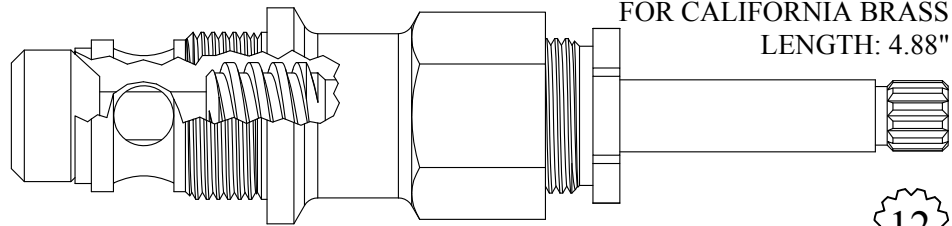

FOR CALIFORNIA BRASS
LENGTH: 4.88"

12
1-2

431701
231701 Stem Only
GASKET: 895400

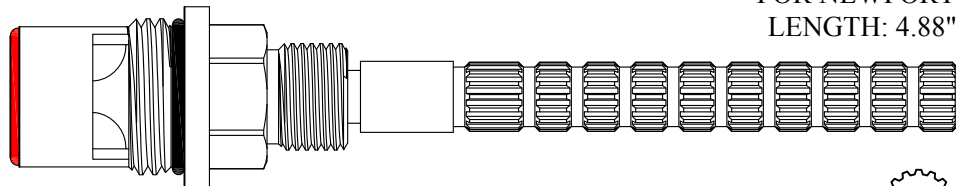

FOR NEWPORT
LENGTH: 4.88"

16
3-16

411221/ 411222
GASKET: 890170 O-RING INCLUDED
SEAL: 898570-R/B
DISC SET: 151380-PKG

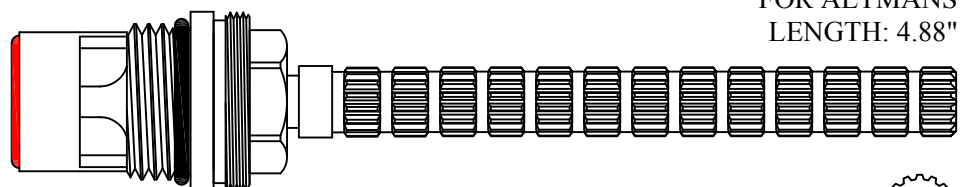

FOR ALTMANS
LENGTH: 4.88"

16
3-16

417311/ 417312
GASKET: 890170 O-RING INCLUDED
SEAL: 898570-R/B
DISC SET: 151380-PKG

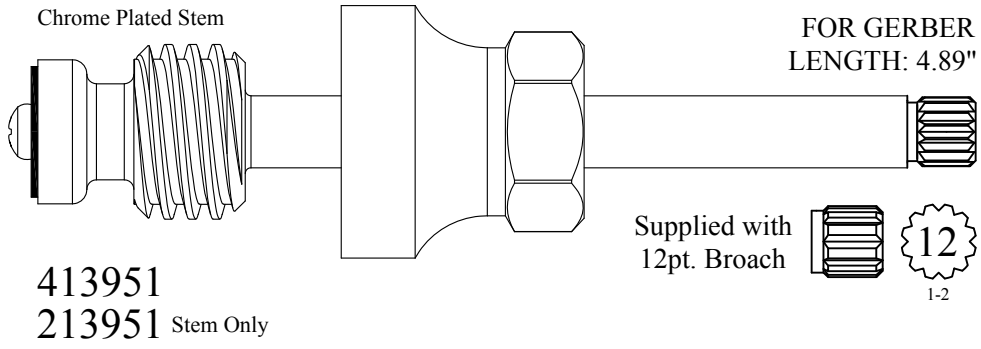

413951
213951 Stem Only

Supplied with
12pt. Broach  12
1-2

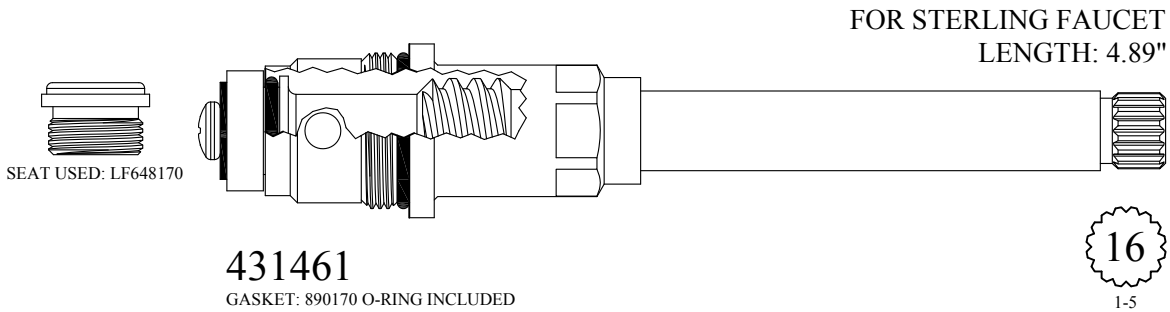

431461
GASKET: 890170 O-RING INCLUDED

16
1-5

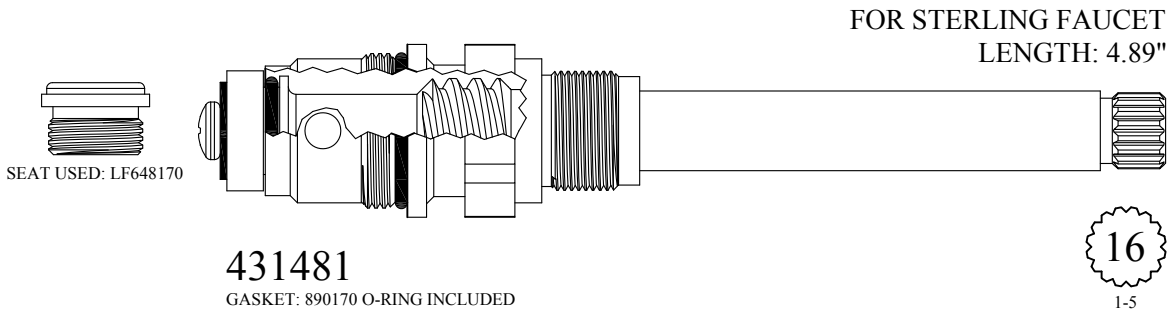

431481
GASKET: 890170 O-RING INCLUDED

16
1-5

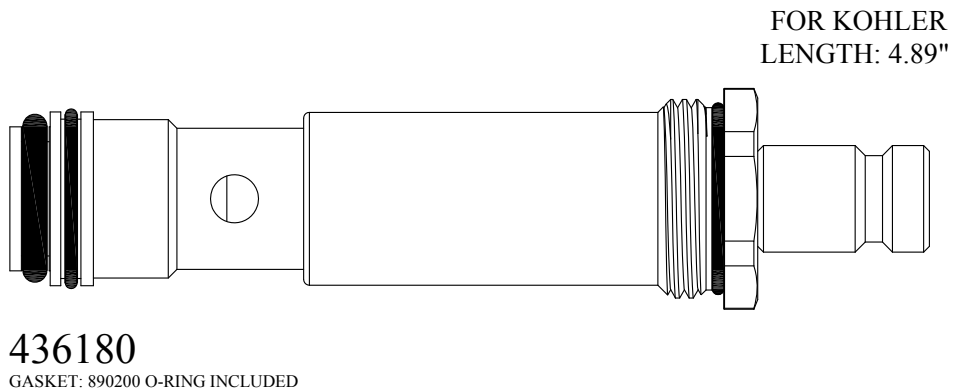

436180
GASKET: 890200 O-RING INCLUDED



SEAT USED: LF649760

Chrome Plated Stem

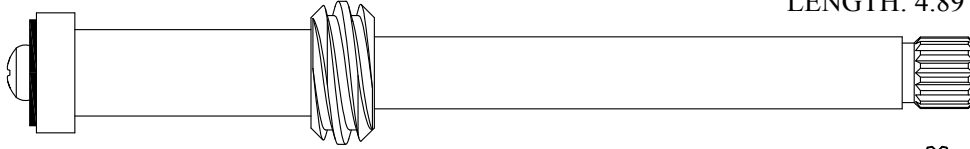

FOR DICK BROS.
LENGTH: 4.89"

LF276311/ LF276312



231530

Chrome Plated Stem

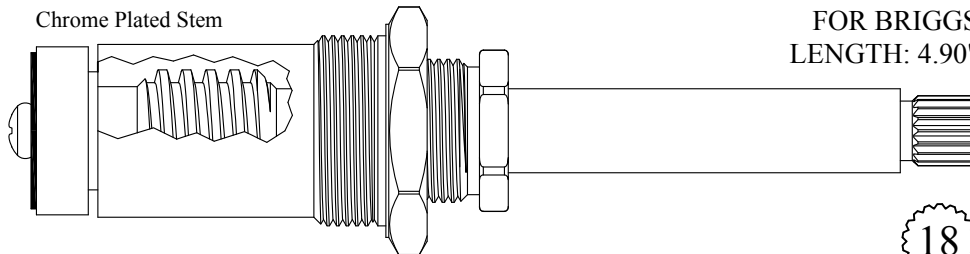

FOR BRADLEY
LENGTH: 4.90"

411401
211401 Stem Only
GASKET: 895340

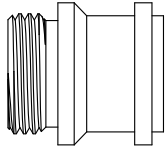

SEAT USED: 648630

Chrome Plated Stem

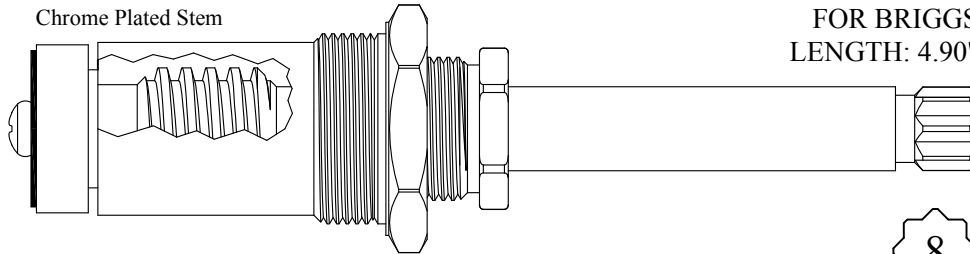

FOR BRIGGS
LENGTH: 4.90"

411411
211411 Stem Only
GASKET: 895340



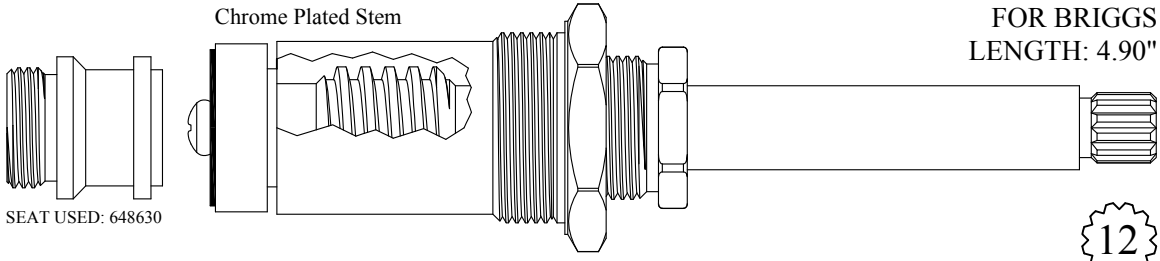

411451
211451 Stem Only
 GASKET: 895340

12
 1-2

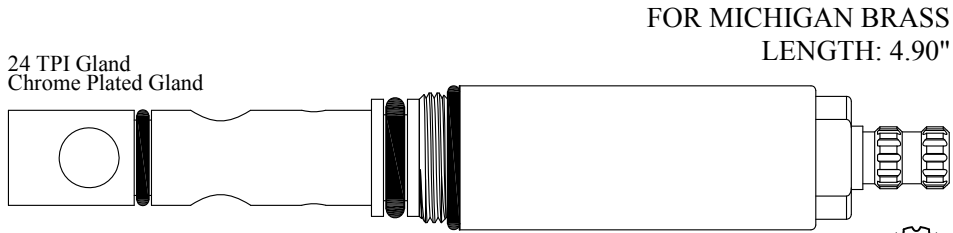

431210
 GASKET: 890160 O-RING INCLUDED

12
 3-5

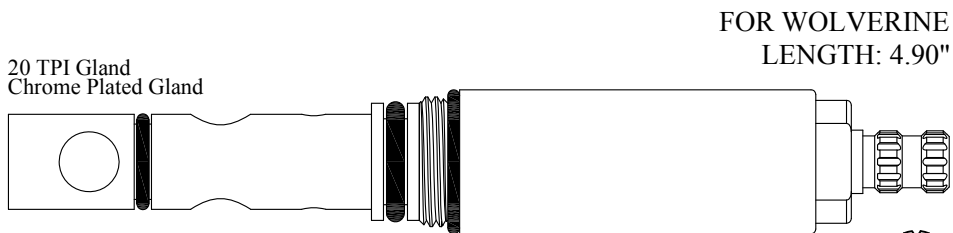

431240
 GASKET: 890160 O-RING INCLUDED

12
 3-5

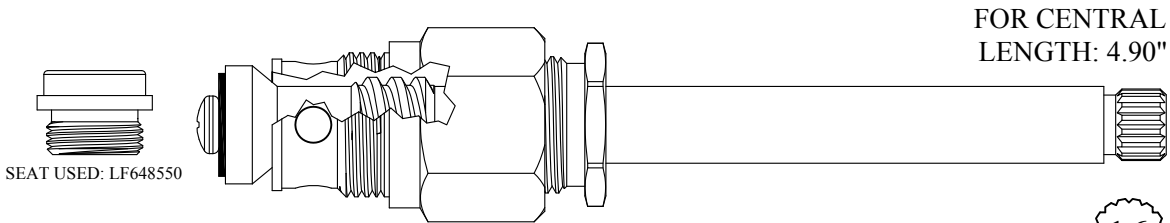

431921
211011 Stem Only
 GASKET: 895100

16
 1-6

SEAT USED: LF648550

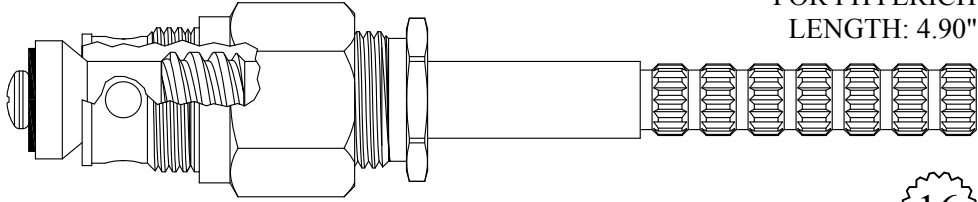

FOR PHYLRICH
LENGTH: 4.90"

16
1-6

431941
GASKET: 895100

Chrome Plated Stem

CERAMIC CONVERSION FOR KOHLER 407001/2
LENGTH: 4.90"

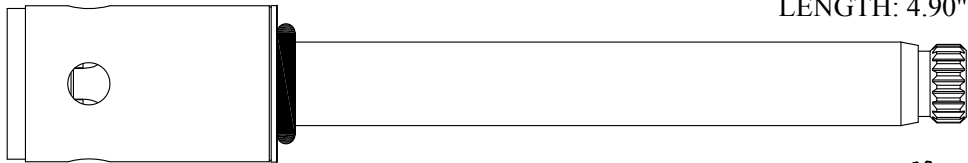

Also available with gold plated stem

407041/ 407042 407041-PG/ 407042-PG
DISC SET: 151380-PKG

19
1-7

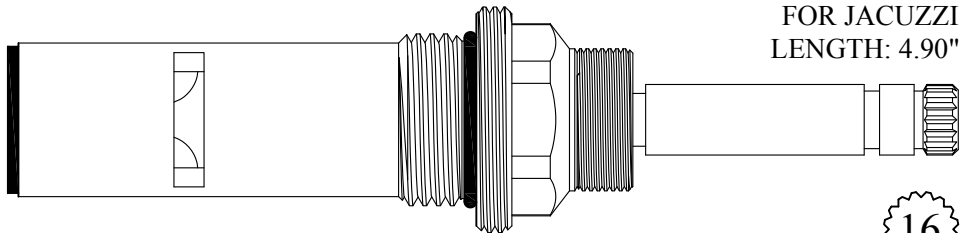

FOR JACUZZI
LENGTH: 4.90"

16
1-6

410921/ 410922
GASKET: 890190 O-RING INCLUDED
SEAL: 898550
DISC SET: 151380-PKG

SEAT USED: LF648550

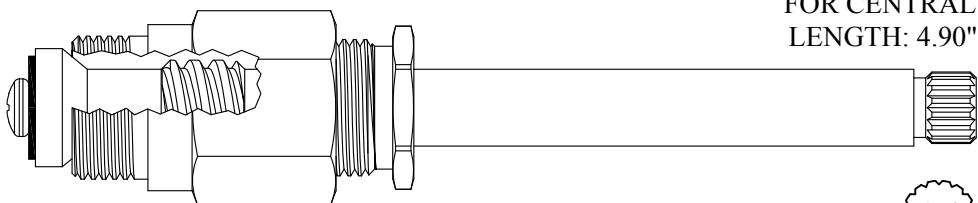

FOR CENTRAL
LENGTH: 4.90"

16
1-6

411011/ 411012
211011/ 211012 Stem Only
GASKET: 895100

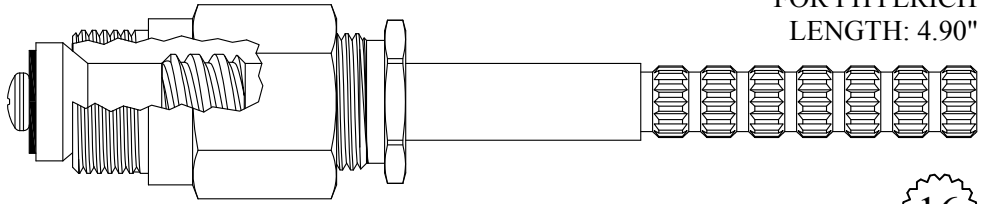

FOR PHYLRICH
LENGTH: 4.90"

16
1-6

411031/ 411032
GASKET: 895100

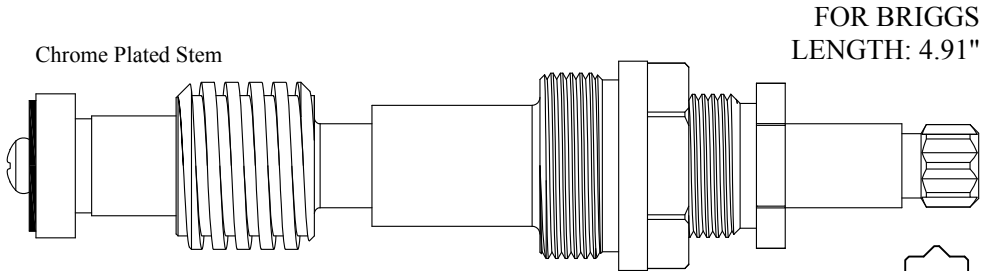

FOR BRIGGS
LENGTH: 4.91"

8

411901
211901 Stem Only
GASKET: 895330

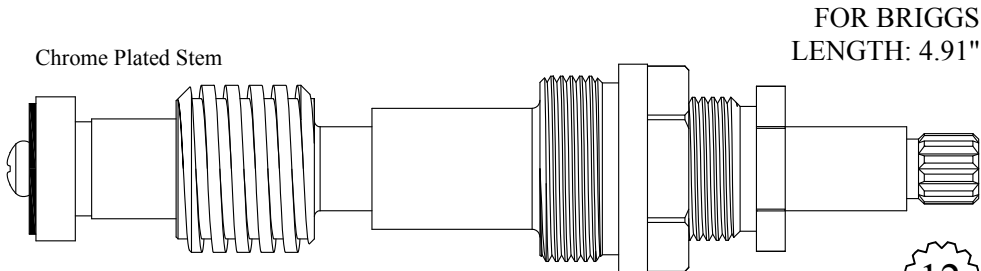

FOR BRIGGS
LENGTH: 4.91"

12
1-2

411951
211951 Stem Only
GASKET: 895330

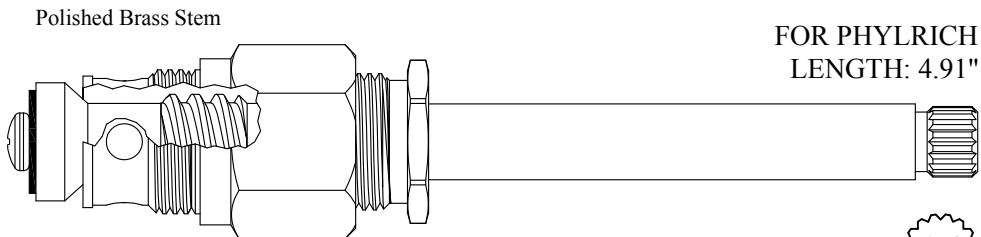

FOR PHYLRICH
LENGTH: 4.91"

16
1-6

431951
GASKET: 895100

Also available with chrome plated stem
431951-CP

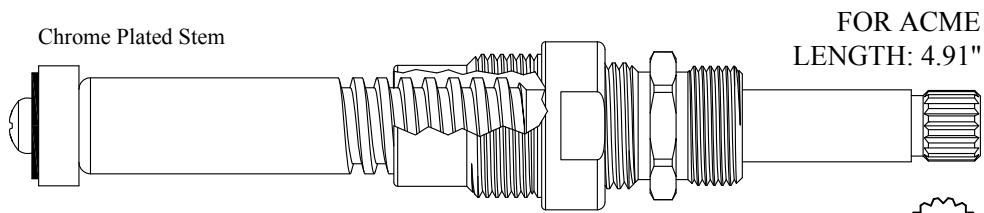

LF475001
LF275001 Stem Only
 GASKET: 895100

16
1-6

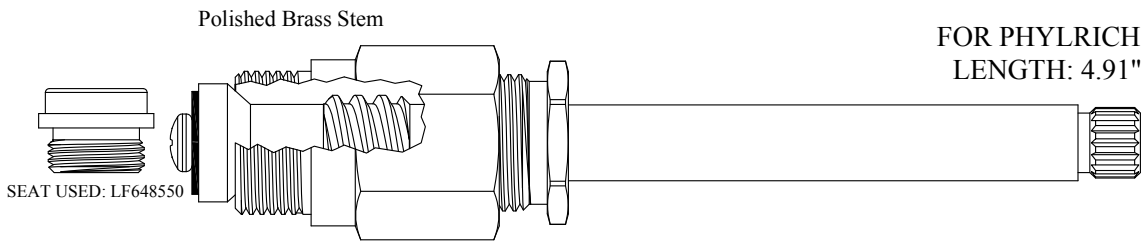

411041/ 411042
211041/ 211042 Stem Only
 GASKET: 895100

Also available with chrome plated stem
411041-CP/ 411042-CP
211041-CP/ 211042-CP Stem Only

16
1-6

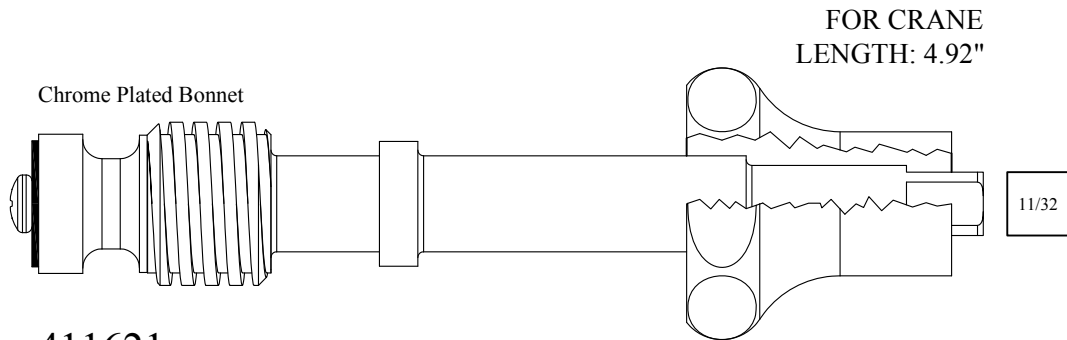

411621
211621 Stem Only

11/32

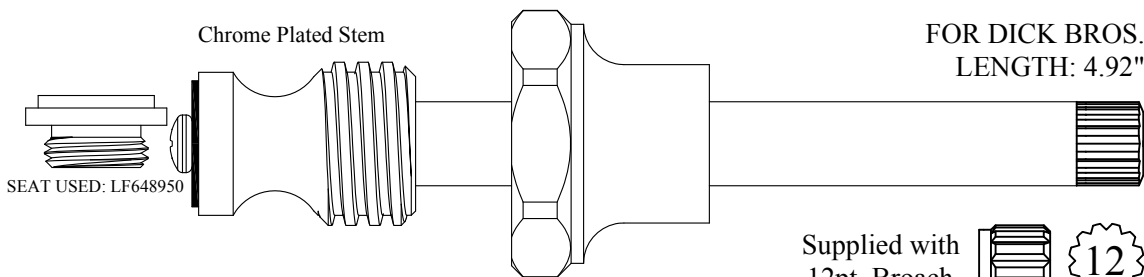

412051
212051 Stem Only

Supplied with
 12pt. Broach  12
 1-2

SEAT USED: 647650

Chrome Plated Stem

FOR BRIGGS
LENGTH: 4.92"

18

3-3

414201
214201 Stem Only

SEAT USED: 647650

Chrome Plated Stem

FOR BRIGGS
LENGTH: 4.92"

12

1-2

414251
214251 Stem Only

SEAT USED: LF648930

Chrome Plated Stem

FOR SPEAKMAN
LENGTH: 4.92"

20

2-4

LF475101/ LF475102
LF275101/ LF275102 Stem Only

GASKET: 890180 O-RING INCLUDED

Chrome Plated Unit

FOR PUBCO
LENGTH: 4.93"

Supplied with
12pt. Broach

12

1-2

411151
211151 Stem Only

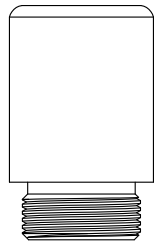

SEAT USED: 648920

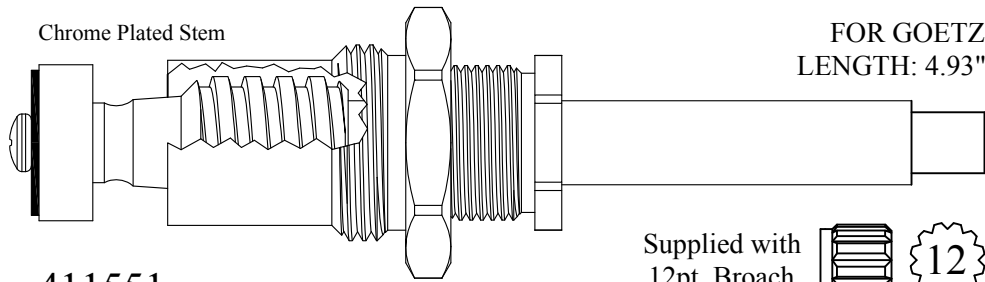

Chrome Plated Stem

FOR GOETZ
LENGTH: 4.93"

411551
211551 Stem Only
GASKET: 895560

Supplied with
12pt. Broach



1-2

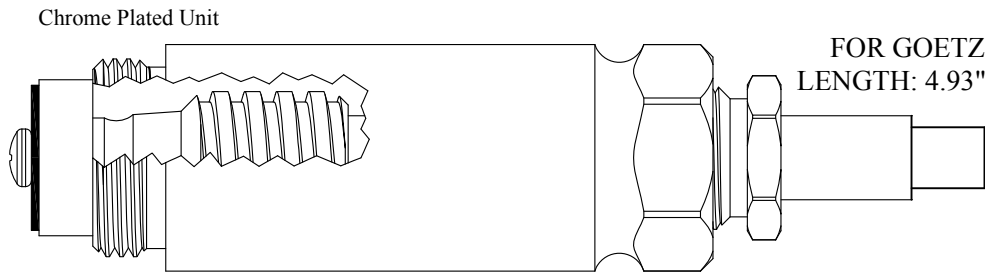

Chrome Plated Unit

FOR GOETZ
LENGTH: 4.93"

411561
211551 Stem Only
GASKET: 895560

Supplied with
12pt. Broach



1-2

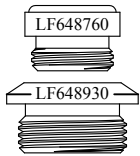

SEAT USED: LF648930
or LF648760

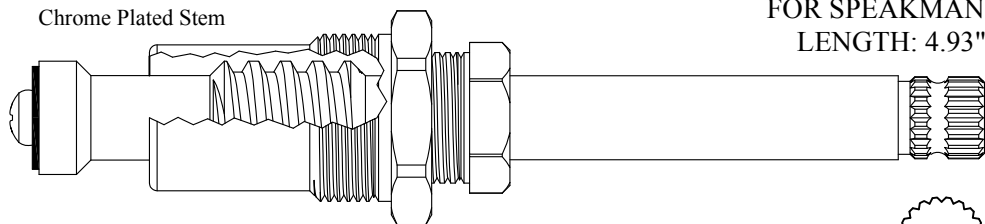

Chrome Plated Stem

FOR SPEAKMAN
LENGTH: 4.93"

411701
211701 Stem Only
GASKET: 895180



2-4

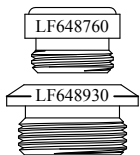

SEAT USED: LF648930
or LF648760

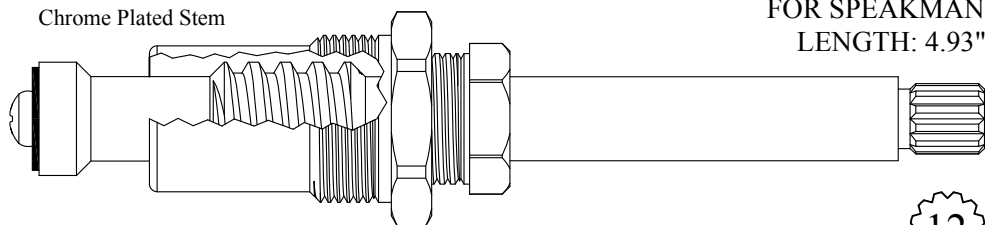

Chrome Plated Stem

FOR SPEAKMAN
LENGTH: 4.93"

411751
211751 Stem Only
GASKET: 895180



1-2

FOR STERLING FAUCET
LENGTH: 4.93"

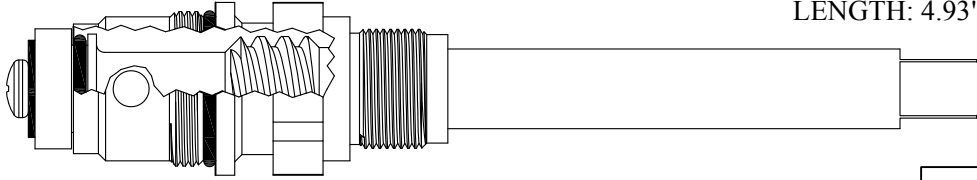

431471

GASKET: 890170 O-RING INCLUDED

5/16

FOR AM STD
LENGTH: 4.93"

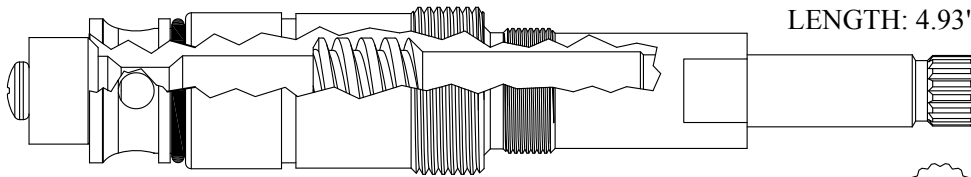

431601

INCLUDES WAVE WASHER: 897110

16

Chrome Plated Stem

FOR HARCRAFT
LENGTH: 4.93"

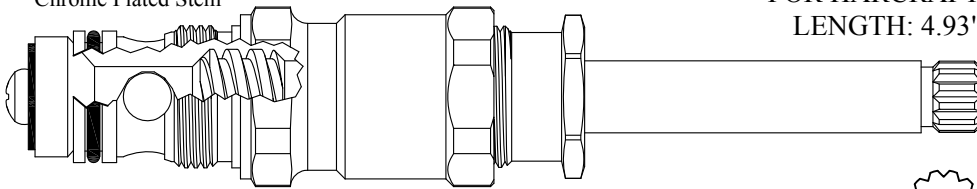

431801

231801 Stem Only

GASKET: 895100

12
1-2

Chrome Plated Stem

FOR HARCRAFT
LENGTH: 4.93"

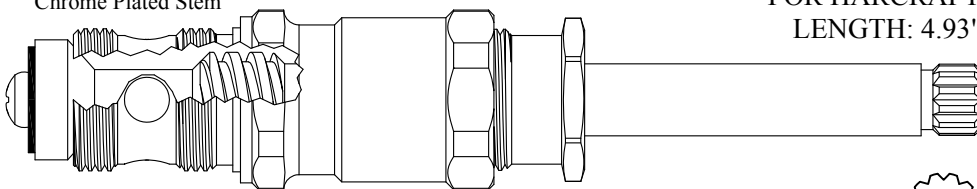

431811

231801 Stem Only

GASKET: 895100

12
1-2

SEAT USED: LF649430

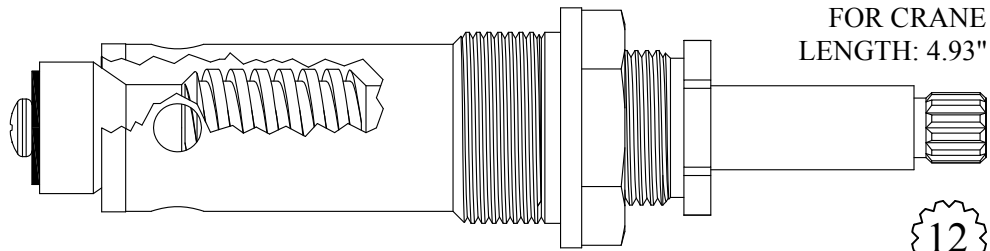

431901
231901 Stem Only
GASKET: 895550

12
1-2

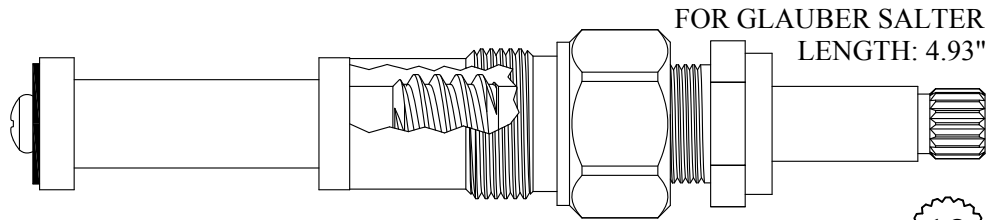

LF476501
LF276501 Stem Only

18
3-3

Chrome Plated Unit

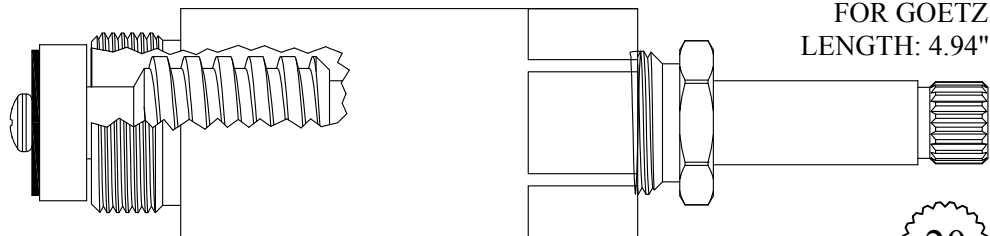

412211
212211 Stem Only
GASKET: 895370

20
2-4

Chrome Plated Unit

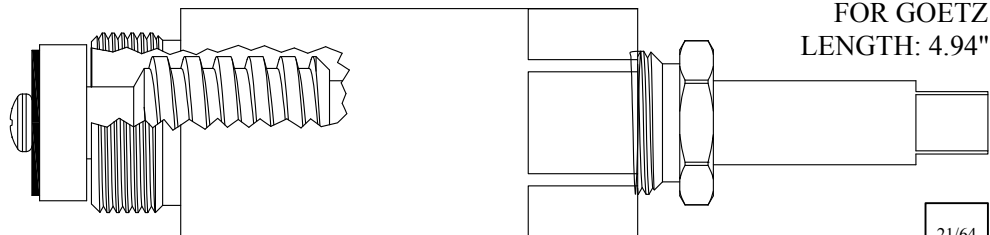

412221
212221 Stem Only
GASKET: 895370

21/64

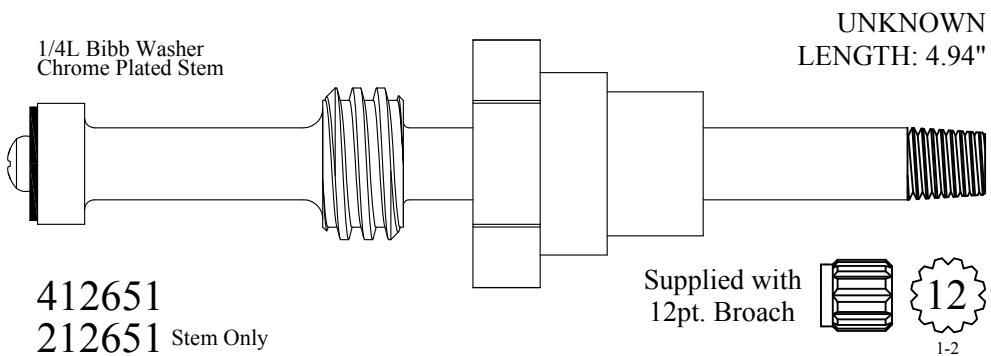
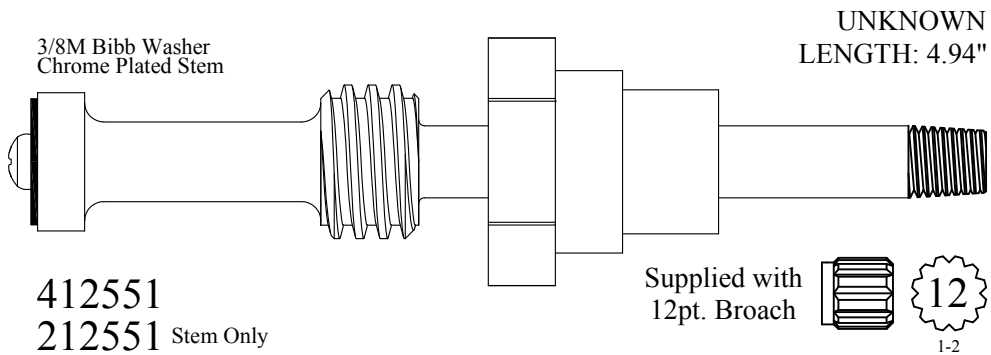
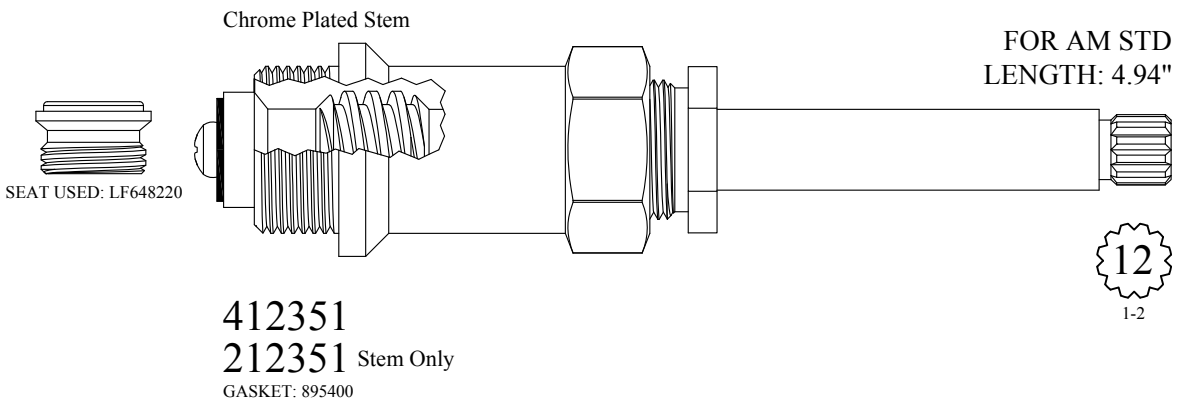
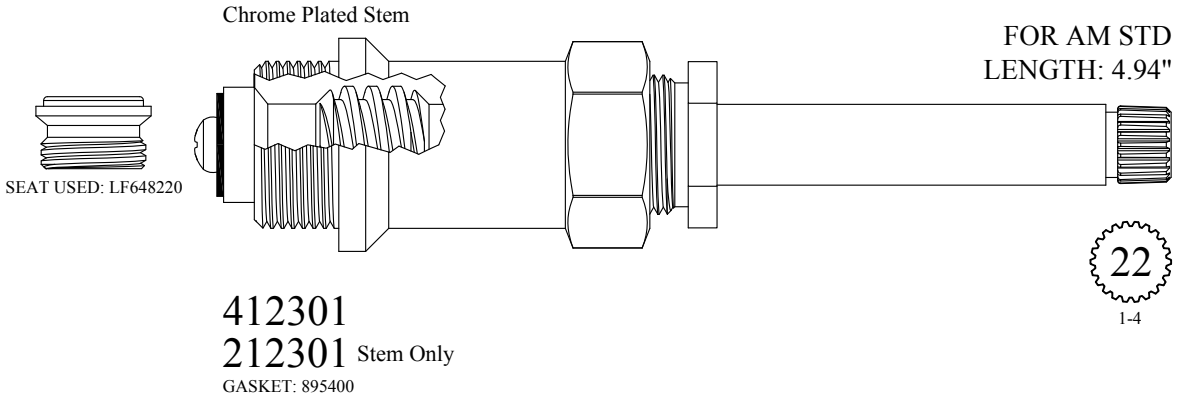



Chrome Plated Stem

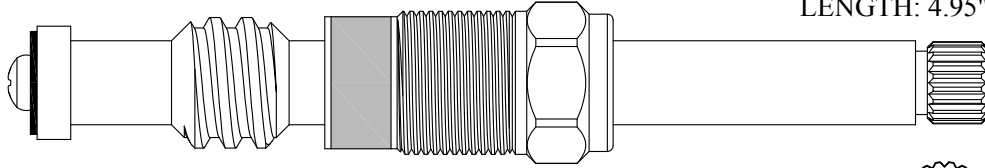

FOR SPEAKMAN
LENGTH: 4.95"

412701
212701 Stem Only



Chrome Plated Stem

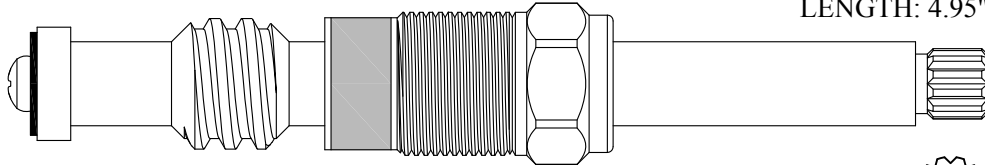

FOR SPEAKMAN
LENGTH: 4.95"

412751
212751 Stem Only

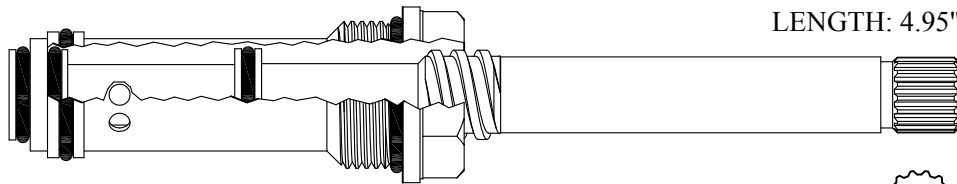

FOR PHOENIX
FOR STREAMWAY
LENGTH: 4.95"

431821
GASKET: 890170 O-RING INCLUDED

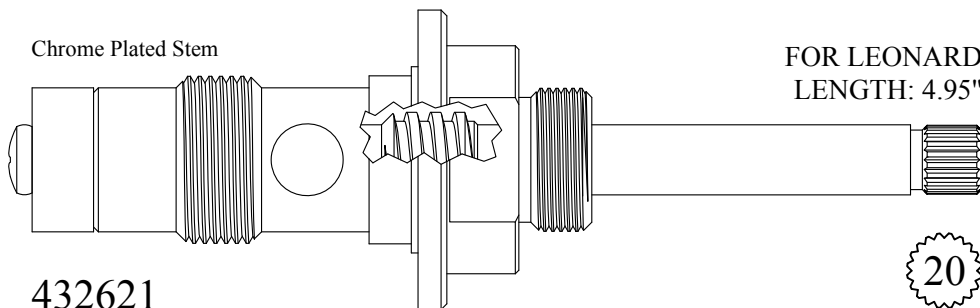

Chrome Plated Stem

FOR LEONARD
LENGTH: 4.95"

432621
GASKET: 895550





SEAT USED: 648970

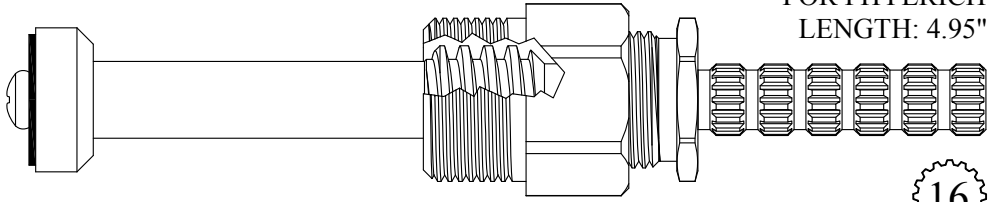

FOR PHYLRICH
LENGTH: 4.95"

415641/ 415642

GASKET: 895400



3-16

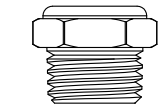

SEAT USED: LF648390

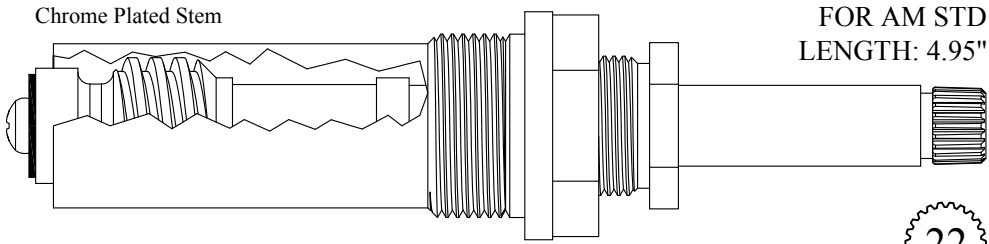

Chrome Plated Stem

FOR AM STD
LENGTH: 4.95"

LF478011/ LF478012

LF278011/ LF278012 Stem Only



1-4



SEAT USED: LF648130

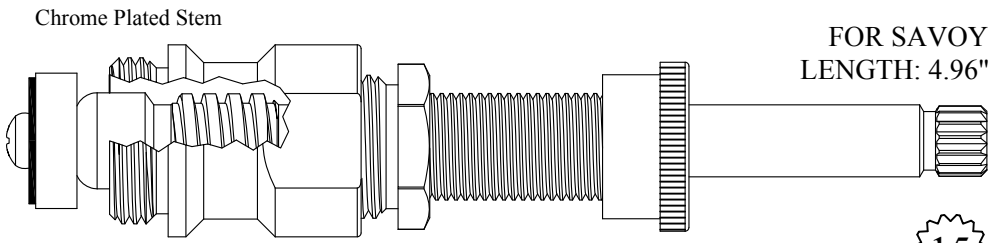

Chrome Plated Stem

FOR SAVOY
LENGTH: 4.96"

412711

212801 Stem Only

GASKET: 895400



1-13



SEAT USED: LF648130

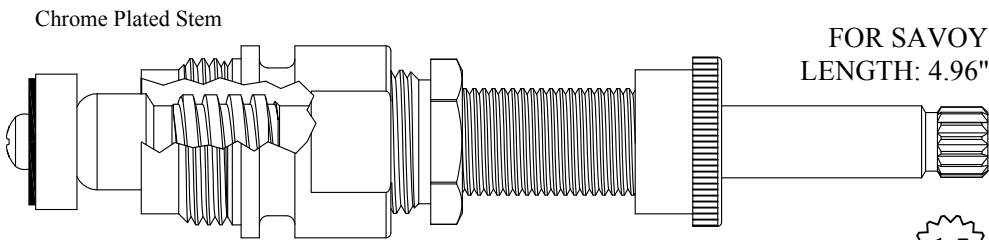

Chrome Plated Stem

FOR SAVOY
LENGTH: 4.96"

412721

212801 Stem Only

GASKET: 895400



1-13

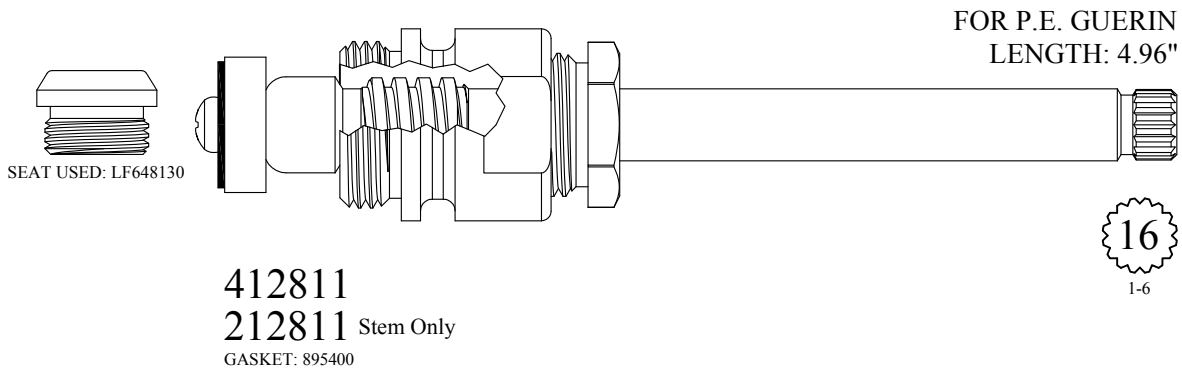
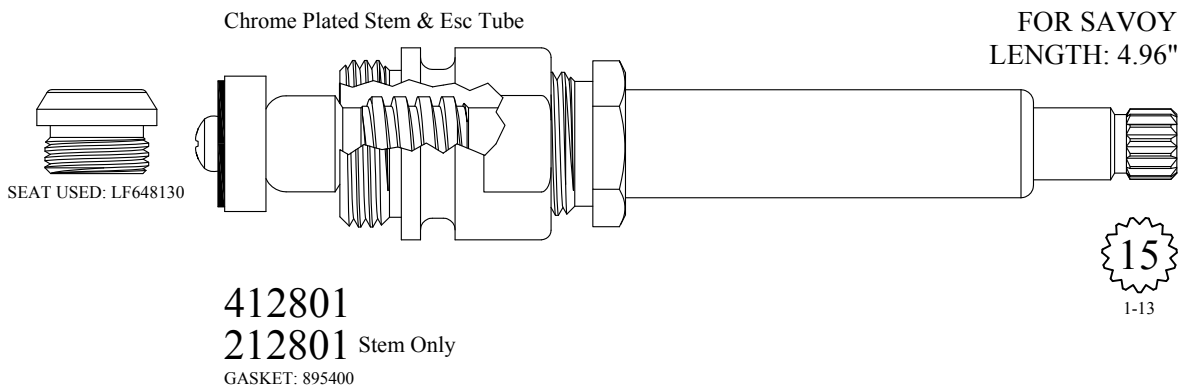
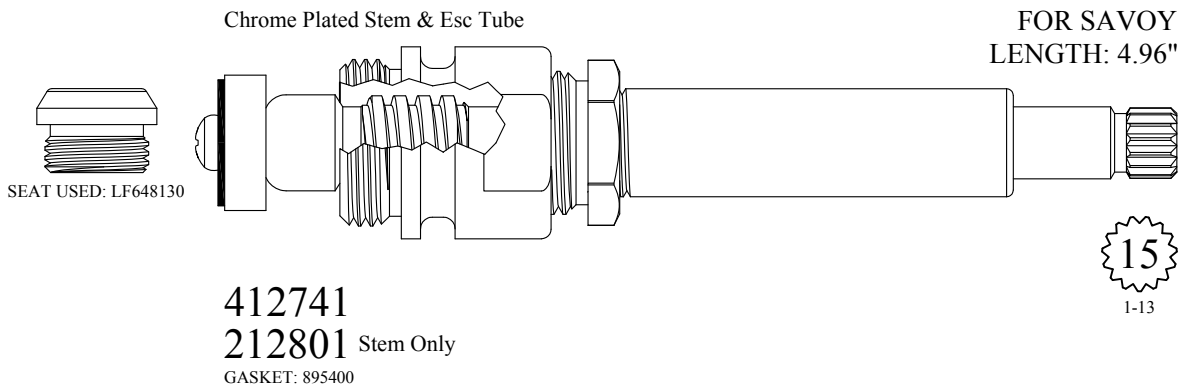
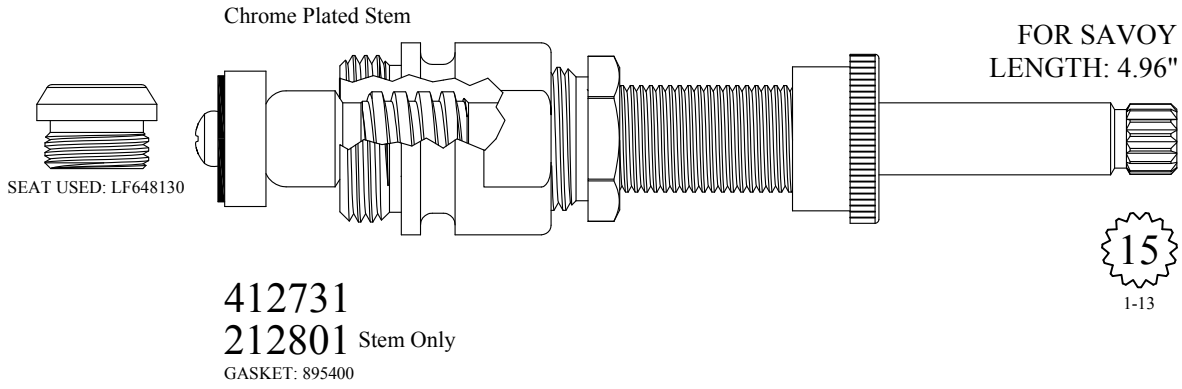

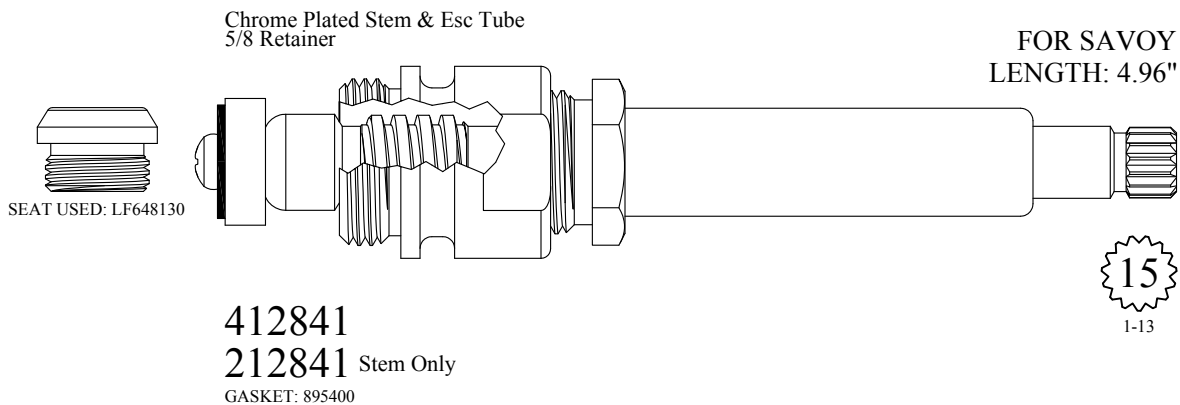
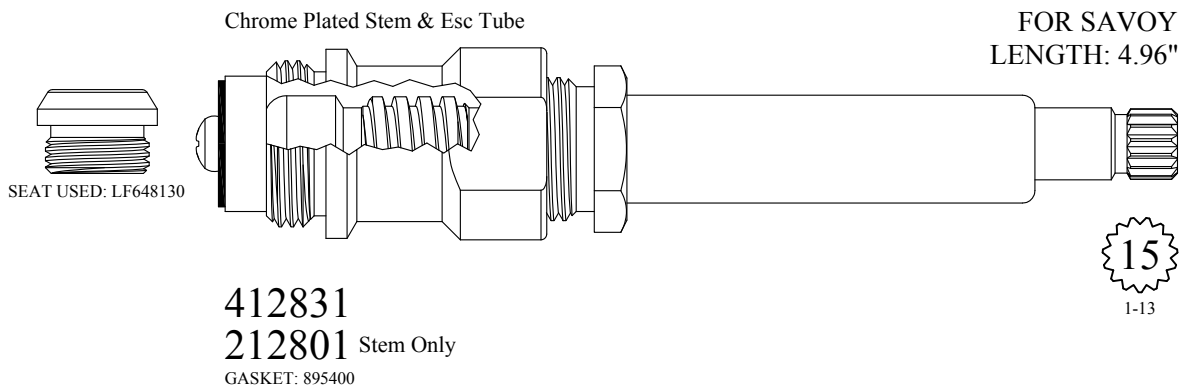
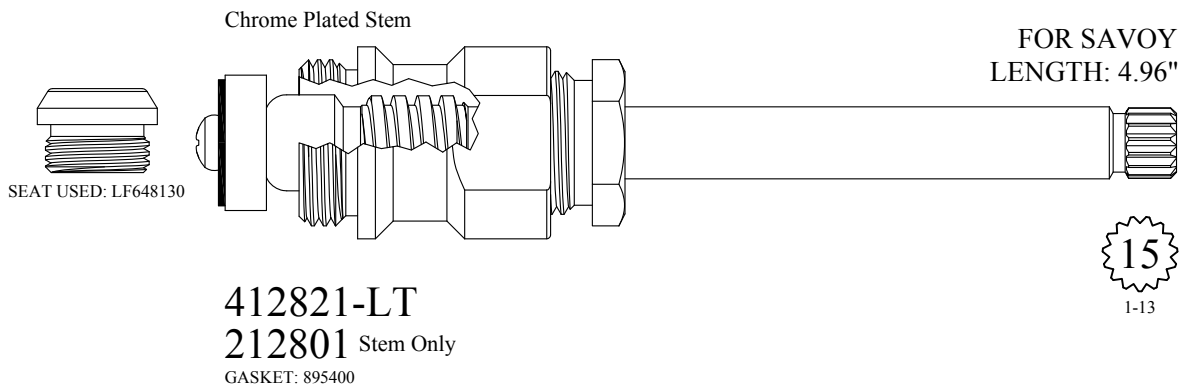
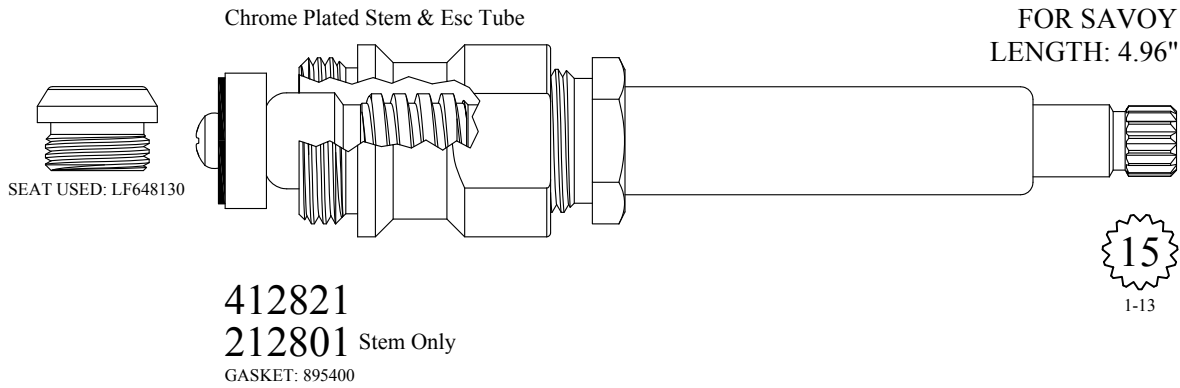

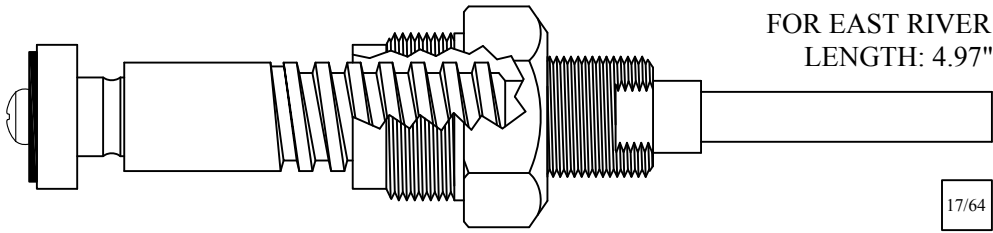

413111
213111 Stem Only
 GASKET: 895150

17/64

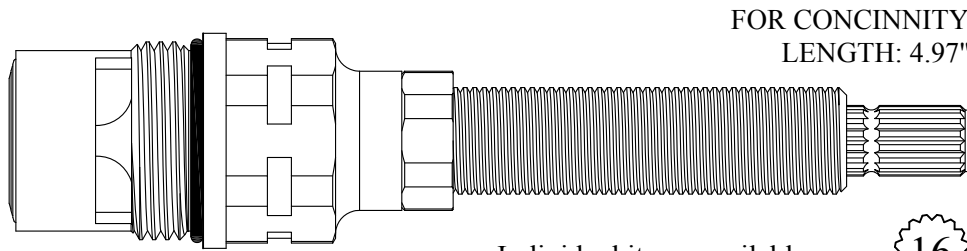

412031/ 412032
 GASKET: 890210 O-RING INCLUDED
 SEAL: 898520
 DISC SET: 109850-PKG

Individual items available
 Stem Ext. 3-1/4": #102960
 Ext. Adap. Screw: #103310

16
 1-6

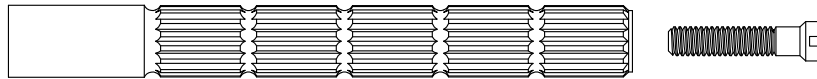

Polished Brass Stem Extension



412041/ 412042
 GASKET: 890210 O-RING INCLUDED
 SEAL: 898520
 DISC SET: 109850-PKG

Also available with chrome plated stem
412041-CP/ 412042-CP

16
 1-6

Individual items available
 Stem Ext. 3.25": #132150
 & 132150-CP
 Ext. Adap. Screw: #103310

Chrome Plated Stem & Esc Tube

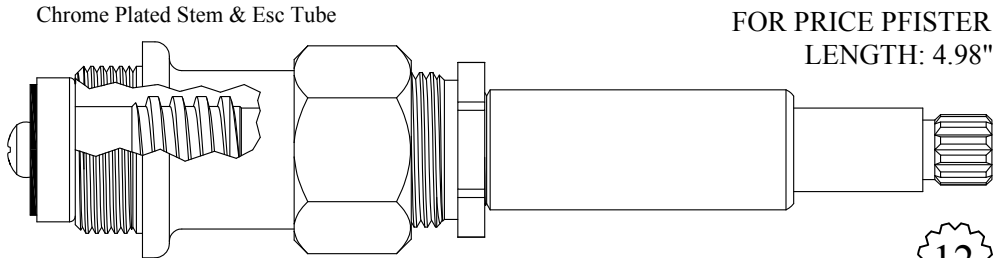

412901
 GASKET: 895400

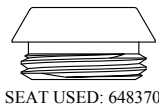

SEAT USED: 648370

12
 1-2

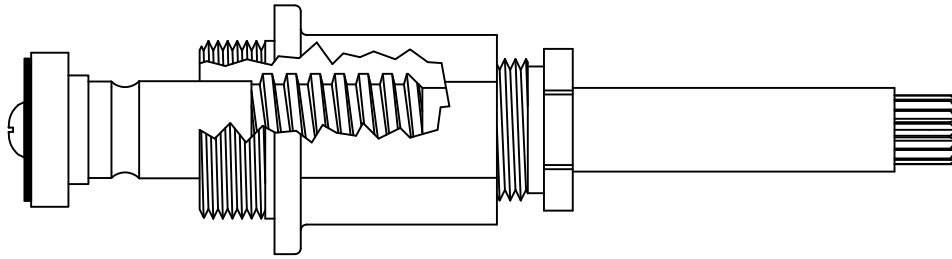

Old Style, Use 413601

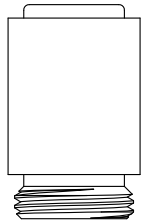

SEAT USED: LF649140

Chrome Plated Stem

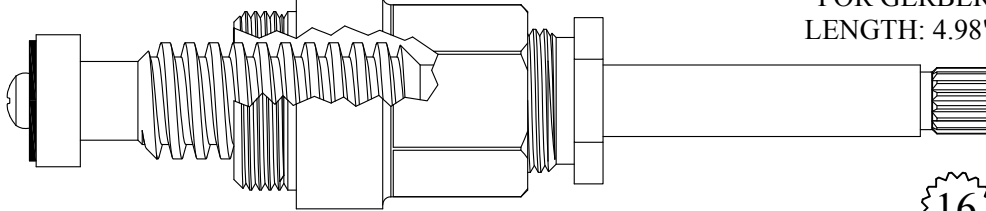

FOR GERBER
LENGTH: 4.98"

16
2-3

413601
213601 Stem Only
GASKET: 895370

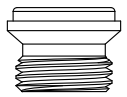

SEAT USED: LF648350

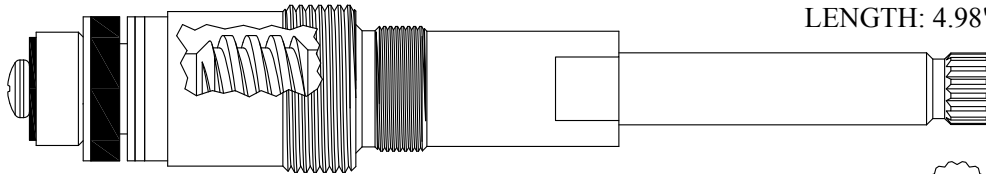

FOR AM STD
LENGTH: 4.98"

16

414401/ 414402
214401/ 214402 Stem Only
WAVE WASHER: 897110

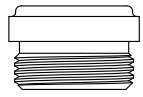

SEAT USED: 648970

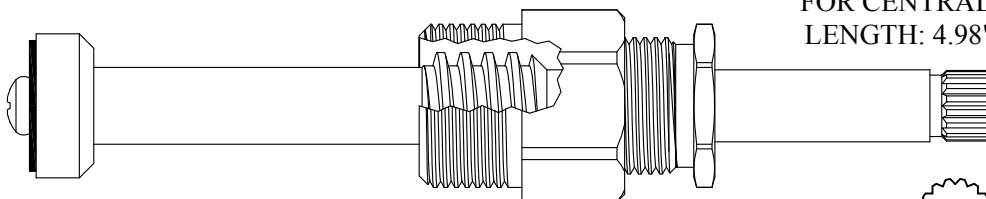

FOR CENTRAL
LENGTH: 4.98"

16
1-6

415541/ 415542
215541/ 215542 Stem Only
GASKET: 895400

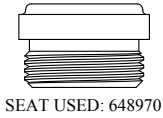

SEAT USED: 648970

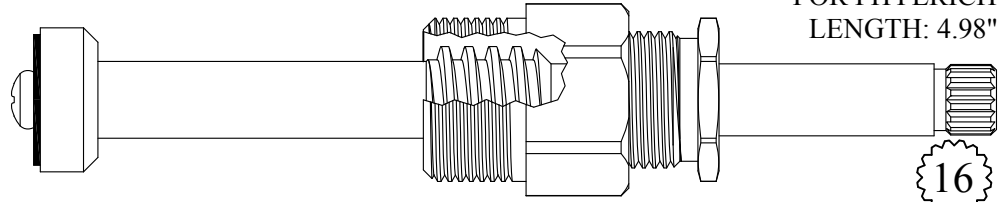

FOR PHYLRICH
LENGTH: 4.98"

16
1-6

415541-CP/ 415542-CP
215541-CP/ 215542-CP Stem Only
GASKET: 895400

Also available with Polished Brass stem
415541-PB/ 415542-PB
215541-PB/ 215542-PB Stem Only

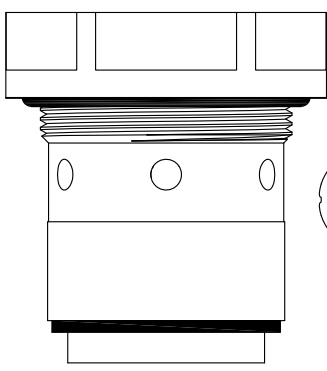

SEAT USED: 647640

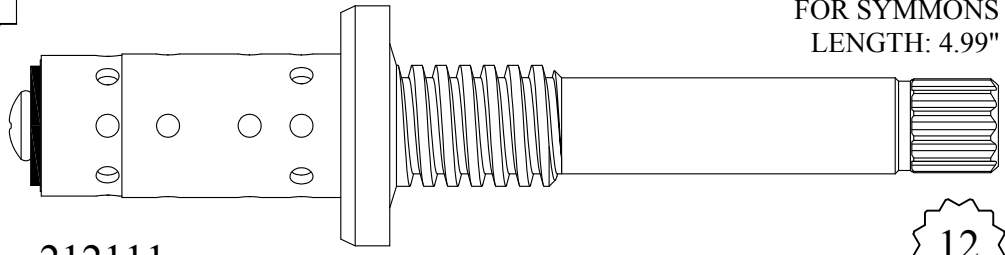

FOR SYMMONS
LENGTH: 4.99"

12
Symmons Large

212111
GASKET: 895490 INCLUDED

Chrome Plated Stem

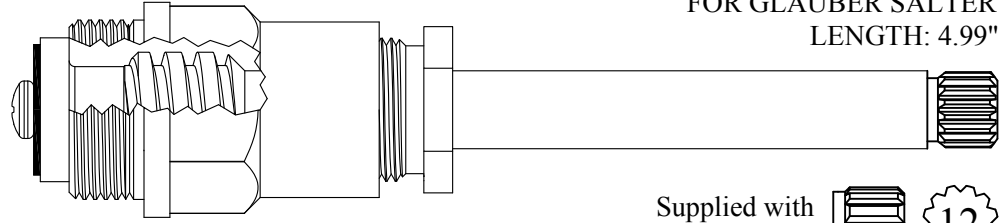

FOR GLAUBER SALTER
LENGTH: 4.99"

Supplied with
12pt. Broach  12
1-2

412451
212451 Stem Only
GASKET: 895370

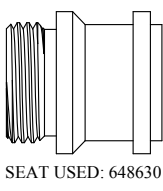

SEAT USED: 648630

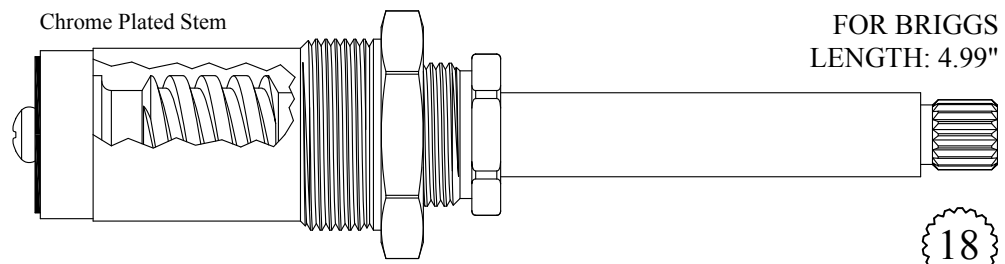

FOR BRIGGS
LENGTH: 4.99"

18
3-3

413001/ 413002
213001/ 213002 Stem Only
GASKET: 895340

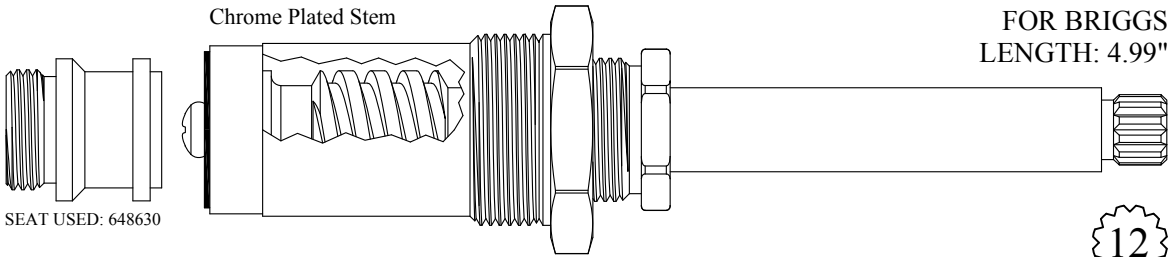

SEAT USED: 648630

Chrome Plated Stem

FOR BRIGGS
LENGTH: 4.99"

413051/ 413052
213051/ 213052 Stem Only

12
1-2

GASKET: 895340

Chrome Plated Stem

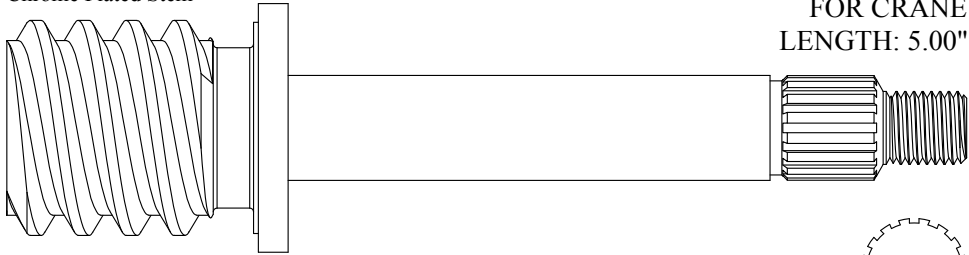

FOR CRANE
LENGTH: 5.00"

212581

16

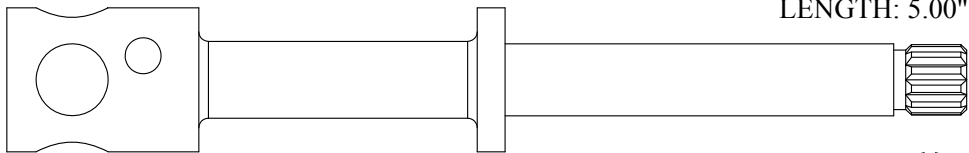

FOR GRAND HAVEN
LENGTH: 5.00"

232220

12
1-2

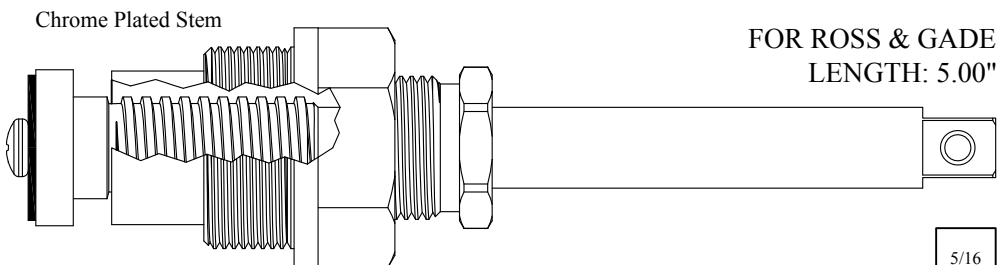

Chrome Plated Stem

FOR ROSS & GADE
LENGTH: 5.00"

412241
212241 Stem Only

GASKET: 895430

5/16

Chrome Plated Unit

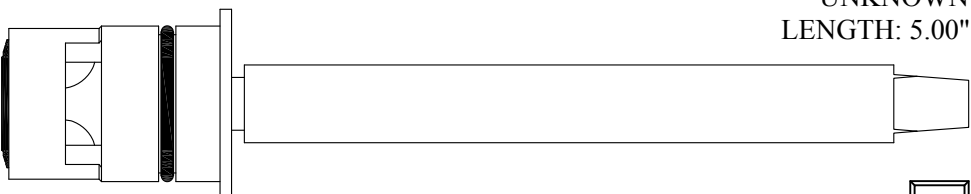

UNKNOWN
LENGTH: 5.00"

412641/ 412642

SEAL: 898510
DISC SET: 151380-PKG

5/16
TAPERED

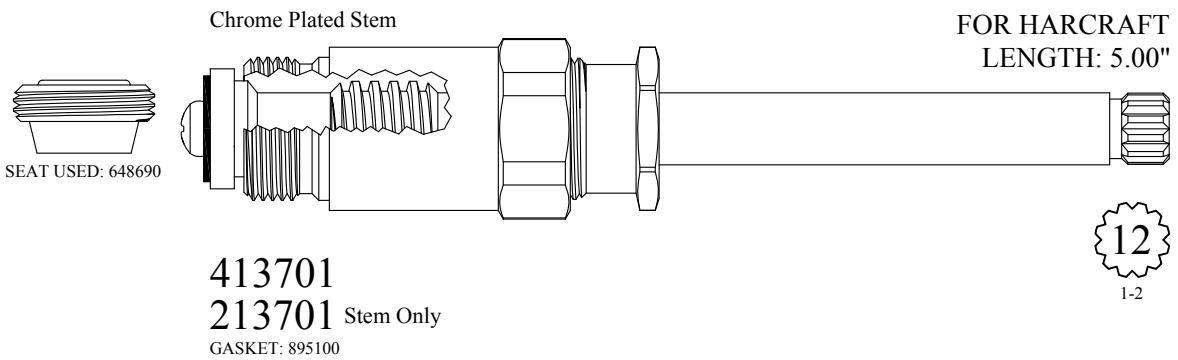
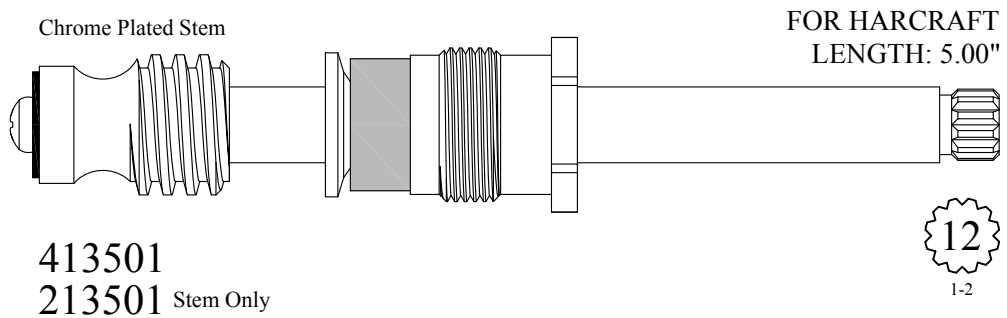
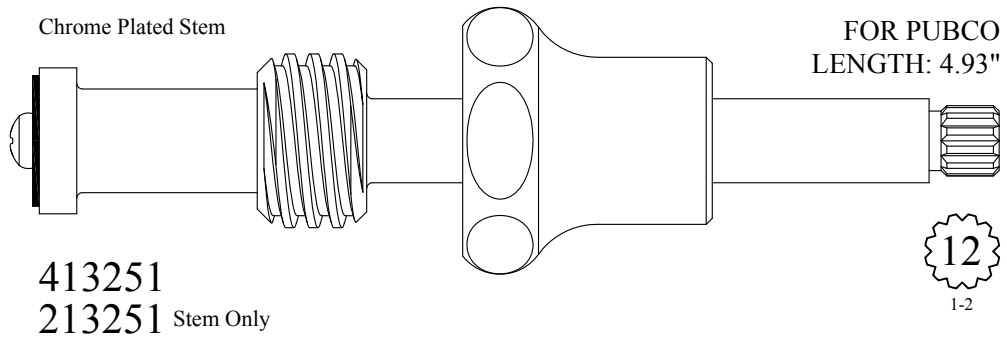
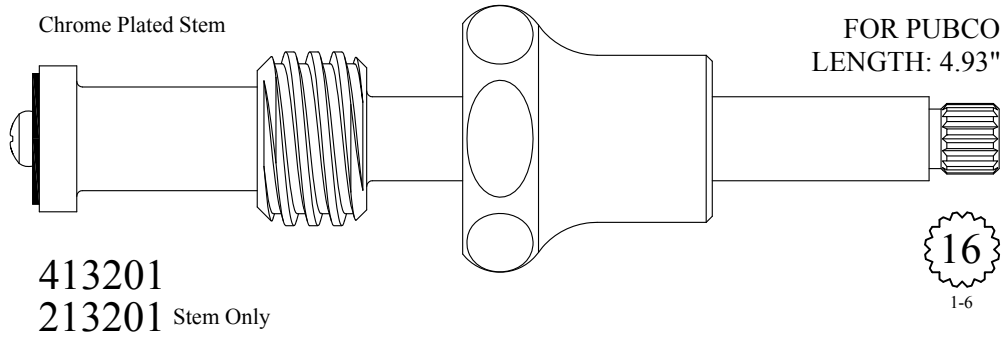

FOR STERLING BRASS
FOR DICK BROS.
LENGTH: 5.00"

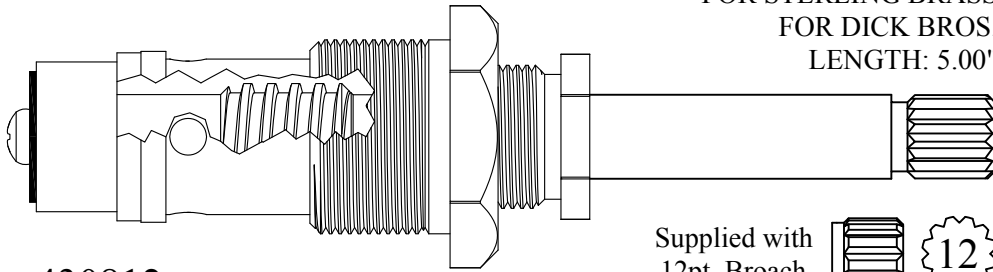

430812
230812 Stem Only
GASKET: 895560

Supplied with
12pt. Broach  12
1-2

Chrome Plated Stem

FOR SPEAKMAN
LENGTH: 5.00"



SEAT USED: LF648930

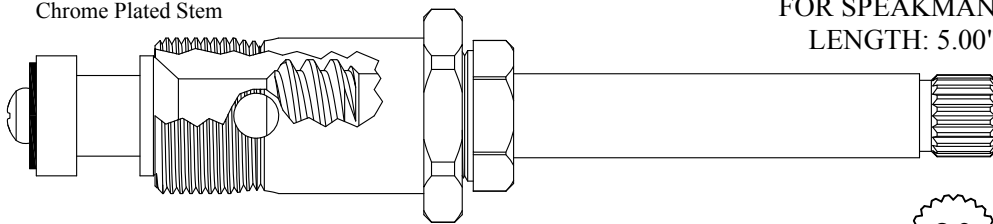

431911
231911 Stem Only
GASKET: 895160

20
2-4

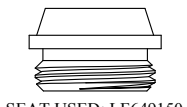

SEAT USED: LF649150

FOR GERBER
LENGTH: 5.00"

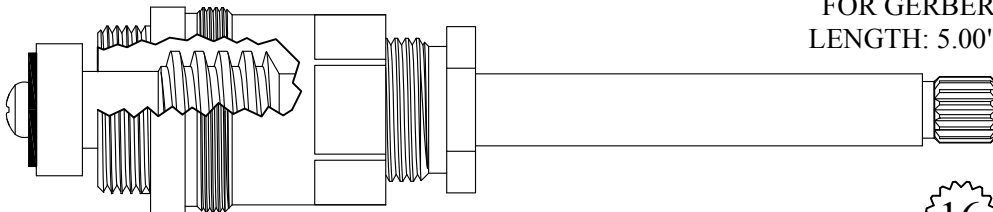

413311/ 413312
213311/ 213312 Stem Only
GASKET: 895400

Also available with chrome plated stem
413311-CP/ 413312-CP
213311-CP/ 213312-CP Stem Only

16
2-3

Chrome Plated Stem

FOR ELJER
LENGTH: 5.00"

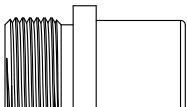

SEAT USED: LF649640



415511/ 415512
215511/ 215512 Stem Only
GASKET: 895330

16
3-15

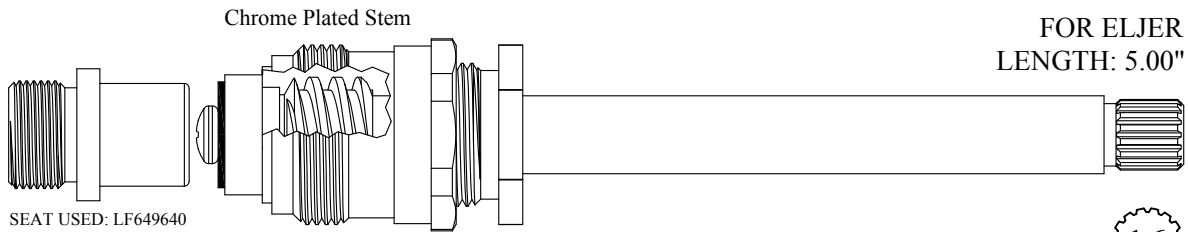

SEAT USED: LF649640

415531/ 415532
 215511/ 215512 Stem Only
 GASKET: 895120

16
 3-15

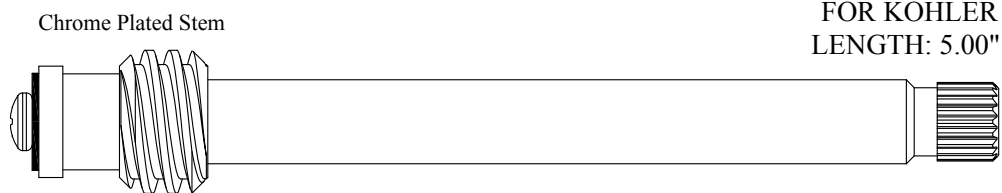

LF277051/ LF277052

19
 1-7

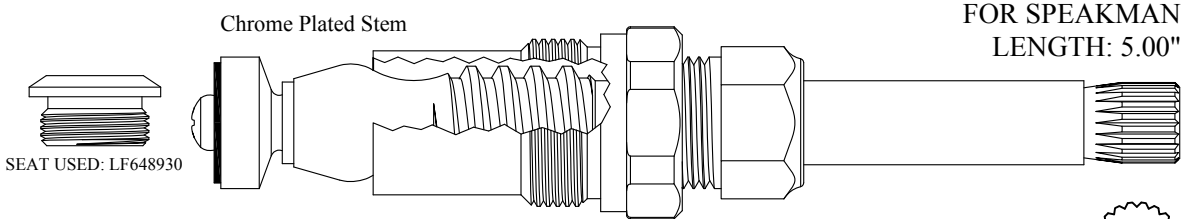

SEAT USED: LF648930

LF476021/ LF476022
 LF276021/ LF276022 Stem Only

20
 2-4

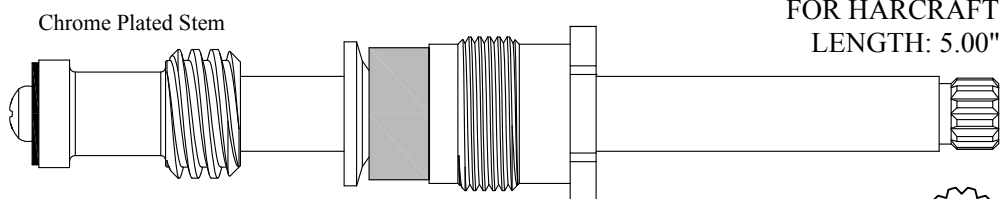

LF480011/ LF480012
 LF280011/ LF280012 Stem Only

12
 1-2

Chrome Plated Stem & Tube

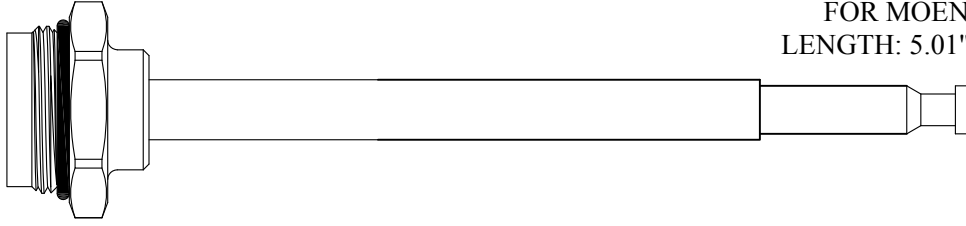

FOR MOEN
LENGTH: 5.01"

430590

GASKET: 890190 O-RING INCLUDED

Chrome Plated Stem

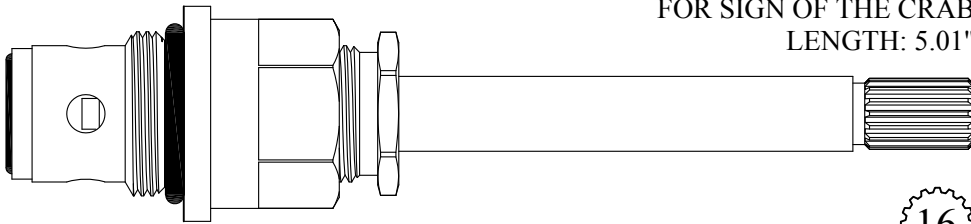

FOR SIGN OF THE CRAB
LENGTH: 5.01"

414911/ 414912

GASKET: 891160 O-RING INCLUDED
DISC SET: 112530-PKG

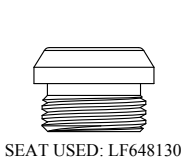

SEAT USED: LF648130

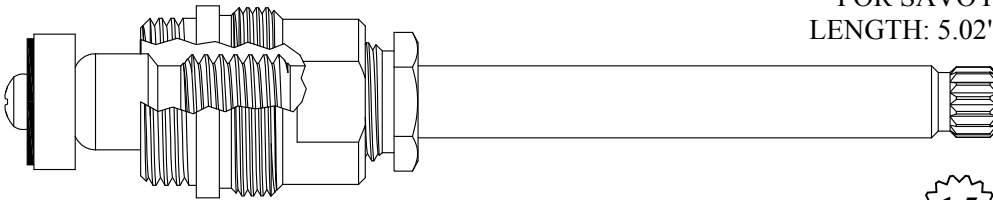

FOR SAVOY
LENGTH: 5.02"

413211

213211 Stem Only

GASKET: 895400

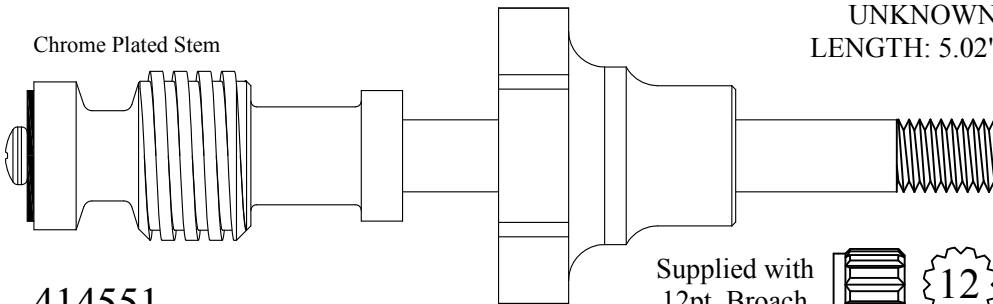

Chrome Plated Stem

UNKNOWN
LENGTH: 5.02"

414551

214551 Stem Only

Supplied with
12pt. Broach



SEAT USED: 648810

Chrome Plated Stem

FOR CENTRAL
LENGTH: 5.02"

16
1-6

415901
215901 Stem Only
GASKET: 895570

SEAT USED: 648810

Chrome Plated Stem

FOR CENTRAL
LENGTH: 5.02"

12
1-2

415951
215951 Stem Only
GASKET: 895570

SEAT USED: LF649790

Chrome Plated Stem

FOR MUELLER
LENGTH: 5.03"

16
1-6

414801
214801 Stem Only

SEAT USED: LF649790

Chrome Plated Stem

FOR MUELLER
LENGTH: 5.03"

12
1-2

414851
214851 Stem Only

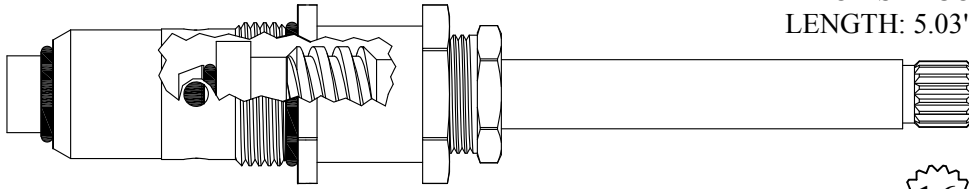

FOR SAYCO
LENGTH: 5.03"

409911/ 409912

GASKET: 890160 O-RING INCLUDED
SEAT INCLUDED: 609910

16

2-3

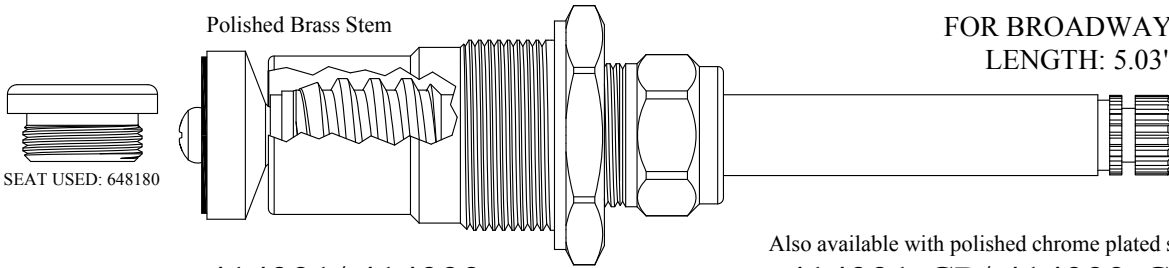

Polished Brass Stem

FOR BROADWAY
LENGTH: 5.03"

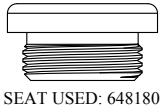

SEAT USED: 648180

20

2-4

414321/ 414322

214321/ 214322 Stem Only

GASKET: 895570

Also available with polished chrome plated stem

414321-CP/ 414322-CP

214321-CP/ 214322-CP Stem Only

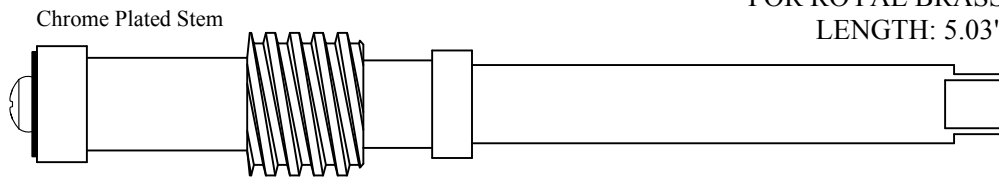

Chrome Plated Stem

FOR ROYAL BRASS
LENGTH: 5.03"

LF279011

5/16



SEAT USED: LF648130

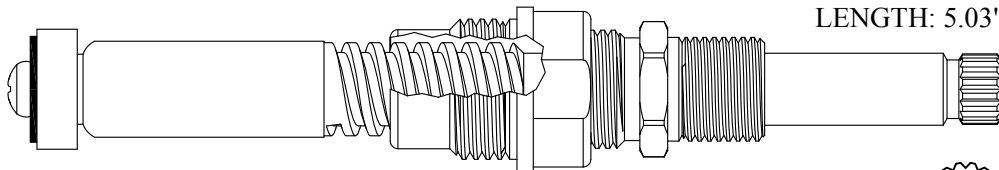

FOR P.E. GUERIN
LENGTH: 5.03"

LF478701/ LF478702

GASKET: 895100

16

1-6

Chrome Plated Stem / Brass Plunger

FOR KOHLER
LENGTH: 5.04"

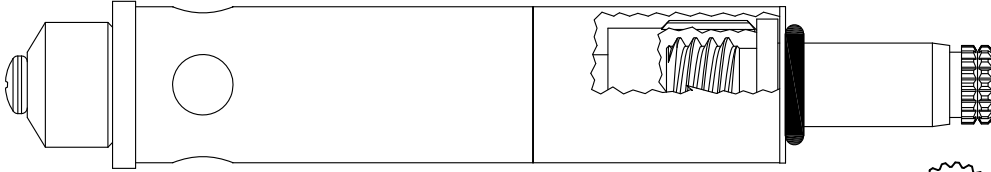

431412



Chrome Plated Stem / Brass Plunger

FOR KOHLER
LENGTH: 5.04"

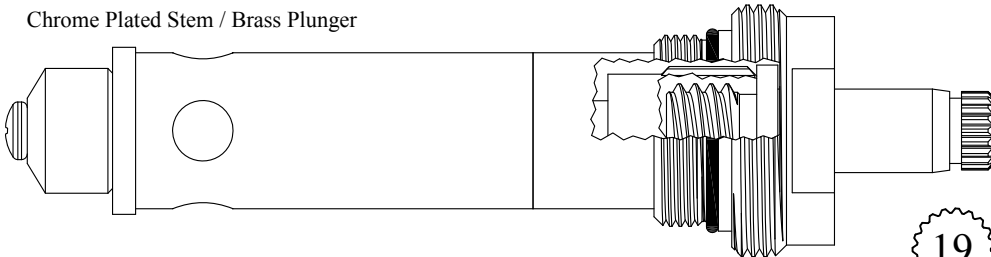

431422

GASKET: 890210 O-RING INCLUDED



Chrome Plated Stem / Plastic Plunger

FOR KOHLER
LENGTH: 5.04"

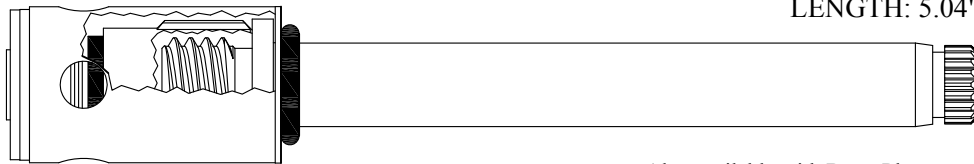

407001/ 407002

207001/ 207002 Stem Only

SEAT: LF649460 INCLUDED

Also available with Brass Plunger
407001-B / 407002-B

Also available with Brass Plunger &
Polished Gold stem
407001-PG / 407002-PG



Chrome Plated Stem / Plastic Plunger

FOR KOHLER
LENGTH: 5.04"

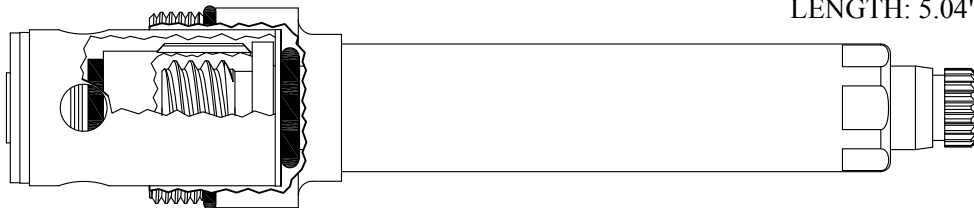

407021/ 407022

207001/ 207002 Stem Only

GASKET: 890210 O-RING INCLUDED
SEAT: LF649460 INCLUDED

Also available with Brass Plunger
407021-B / 407022-B



Chrome Plated Stem / Plastic Plunger

FOR KOHLER
LENGTH: 5.04"

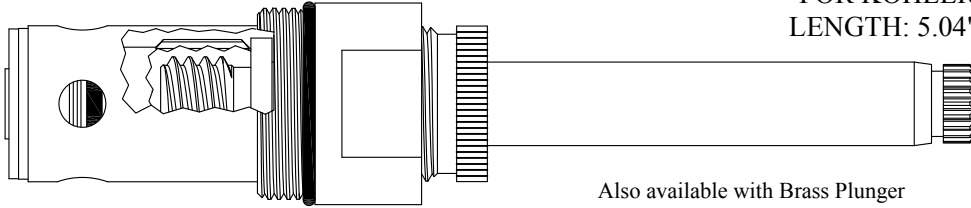

19
1-7

407031/ 407032
207001/ 207002 Stem Only

GASKET: 890210 O-RING INCLUDED
SEAT: LF649460 INCLUDED

Also available with Brass Plunger
407031-B / 407032-B

Also available with Brass Plunger &
Polished Gold stem

407031-PG / 407032-PG



Not Available, Use 414421 / 414422

FOR SAYCO
LENGTH: 5.04"



16
2-3

414421/ 414422

DISC SET: 151380-PKG

FOR REID WATSON
LENGTH: 5.04"



SEAT USED: LF648130

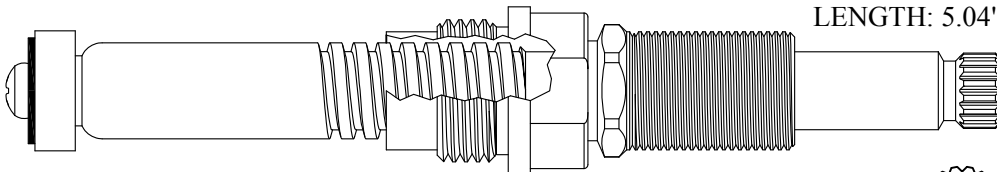

16
1-5

LF478711/ LF478712

GASKET: 895100

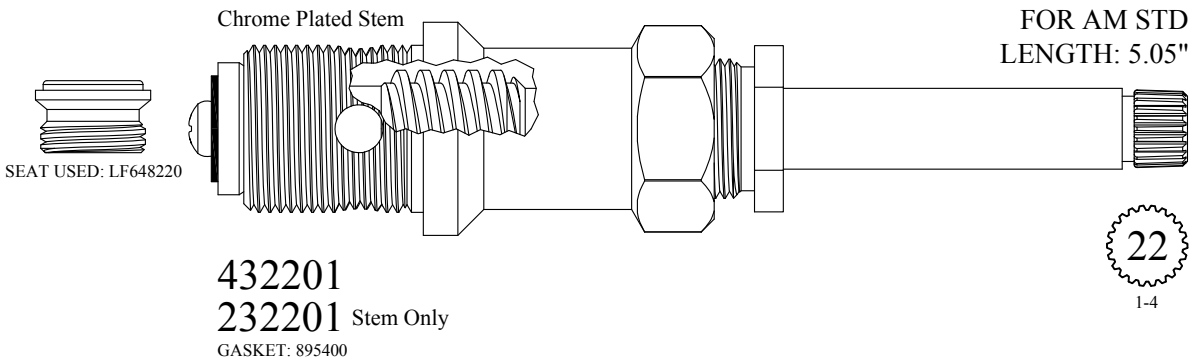
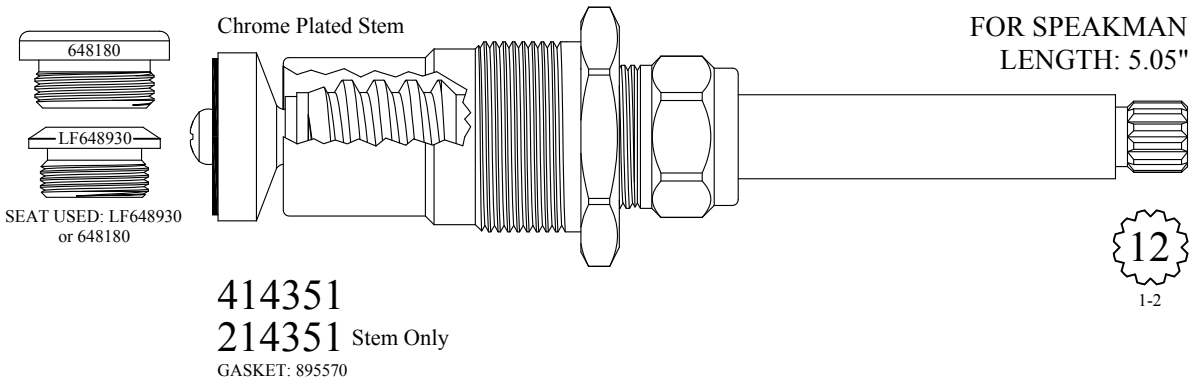
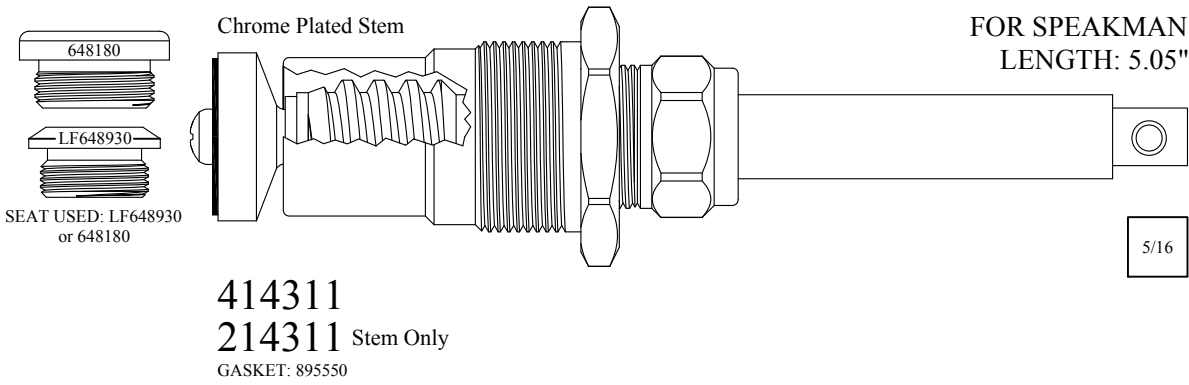
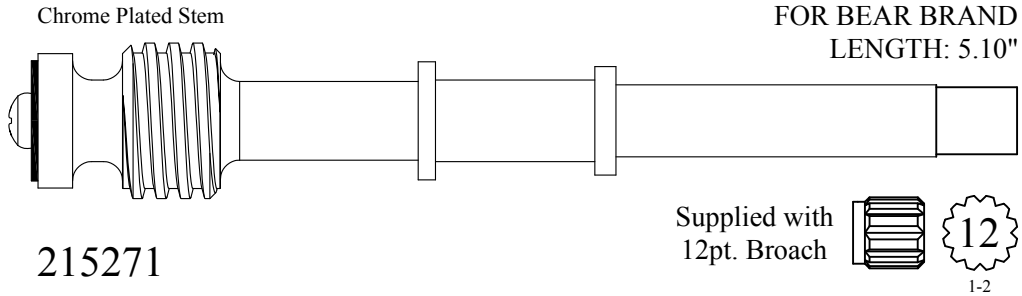

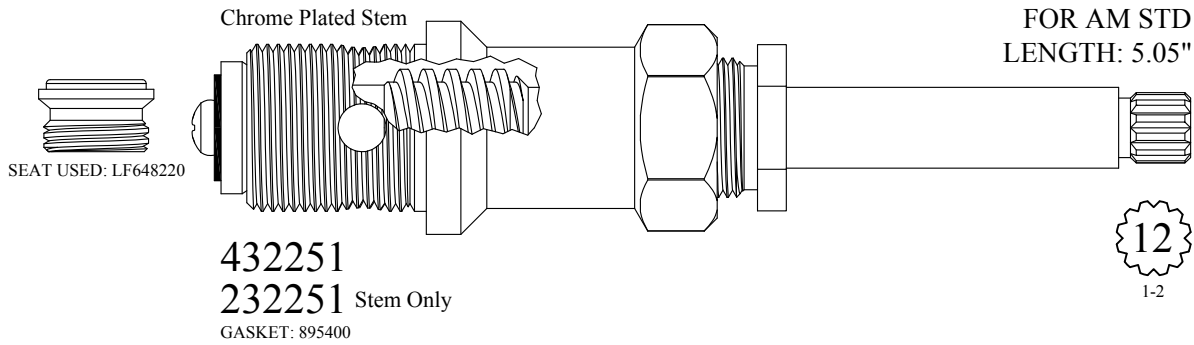

432251
 232251 Stem Only
 GASKET: 895400

12
 1-2

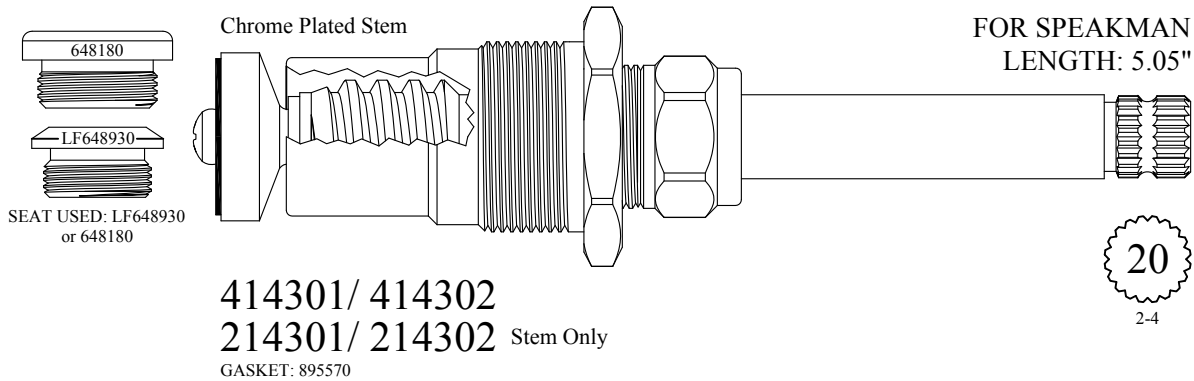

414301/ 414302
 214301/ 214302 Stem Only
 GASKET: 895570

20
 2-4

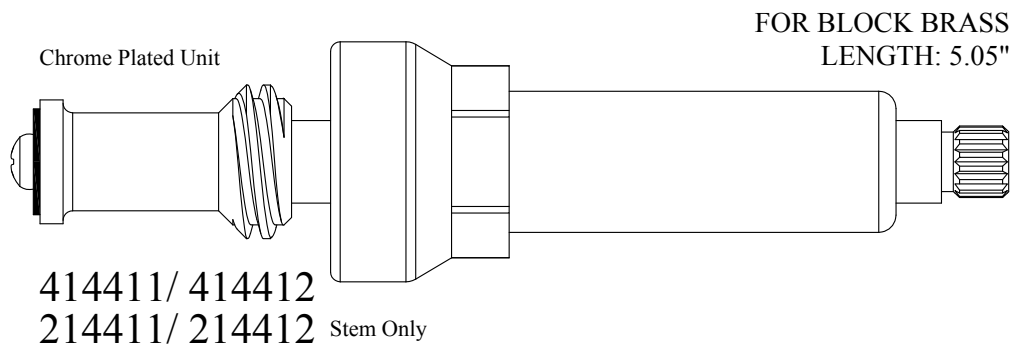

414411/ 414412
 214411/ 214412 Stem Only

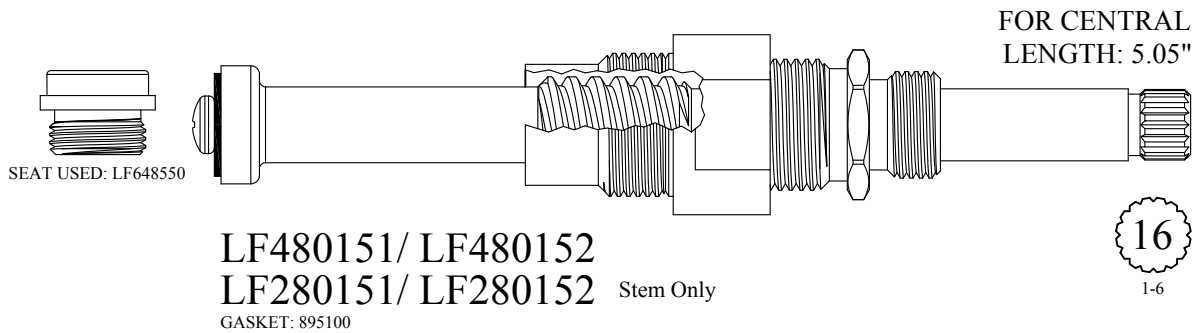

LF480151/ LF480152
 LF280151/ LF280152 Stem Only
 GASKET: 895100

16
 1-6

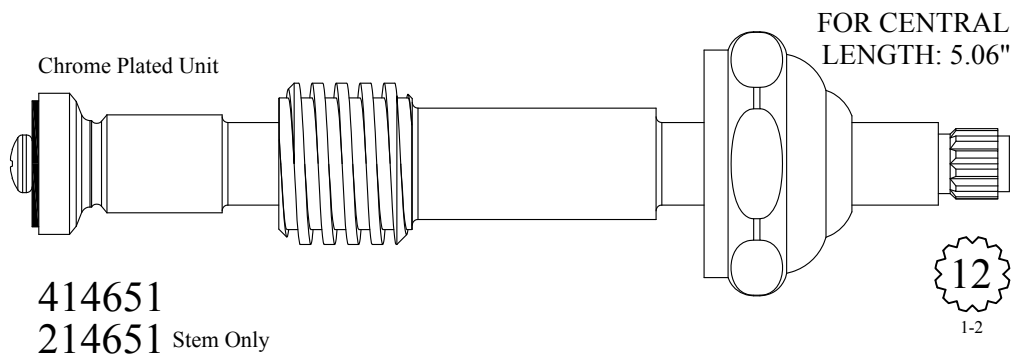
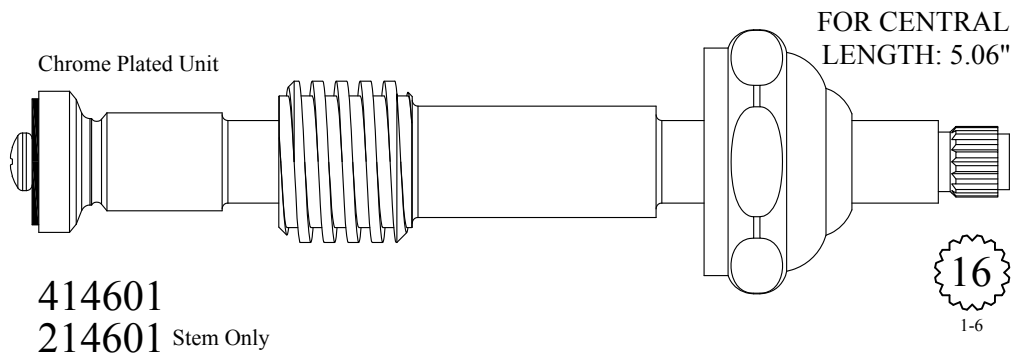
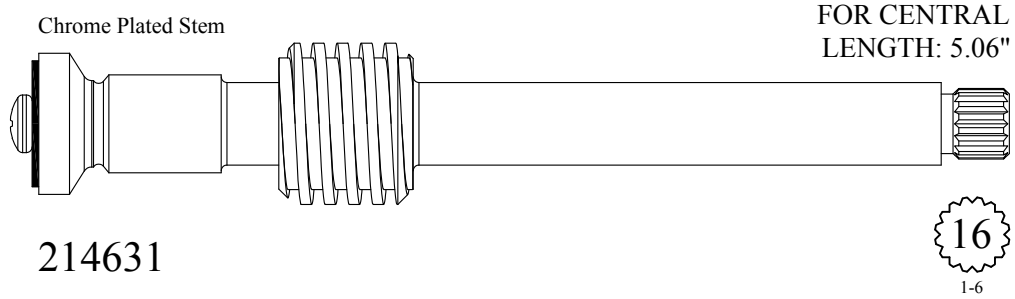
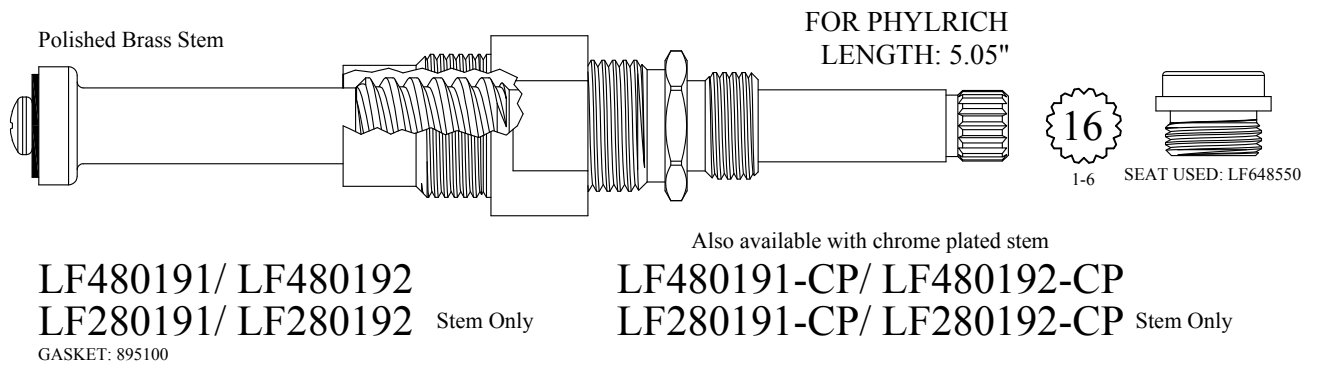

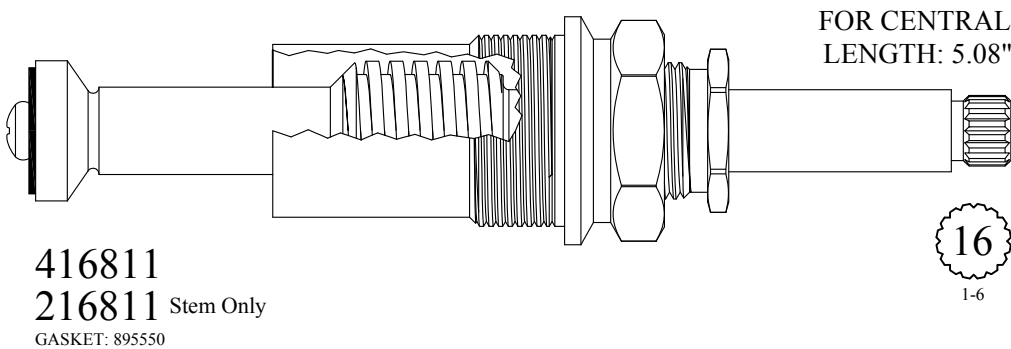
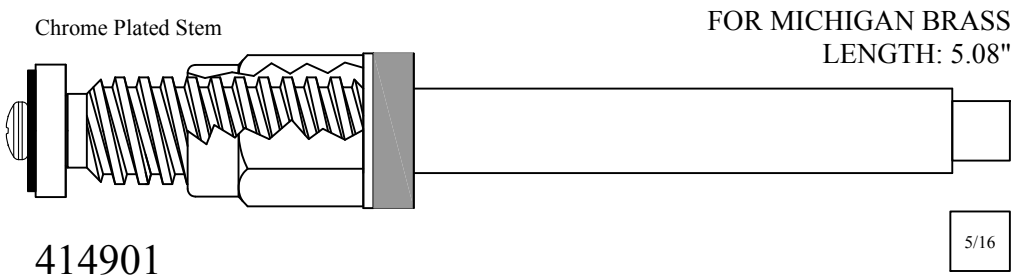
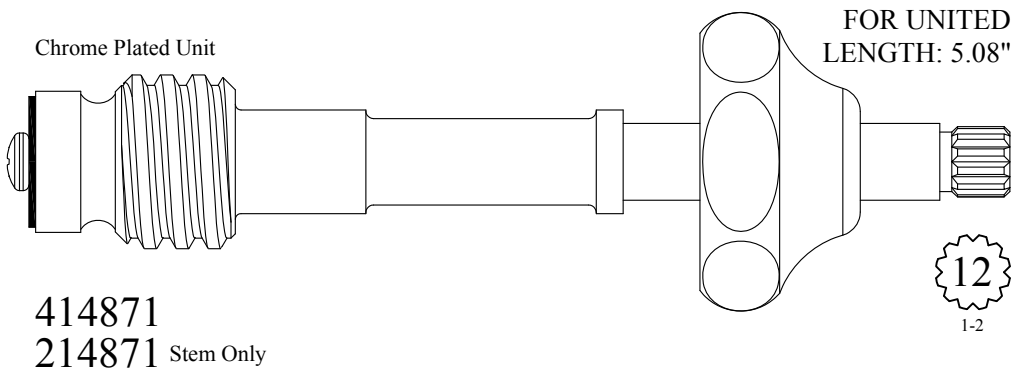
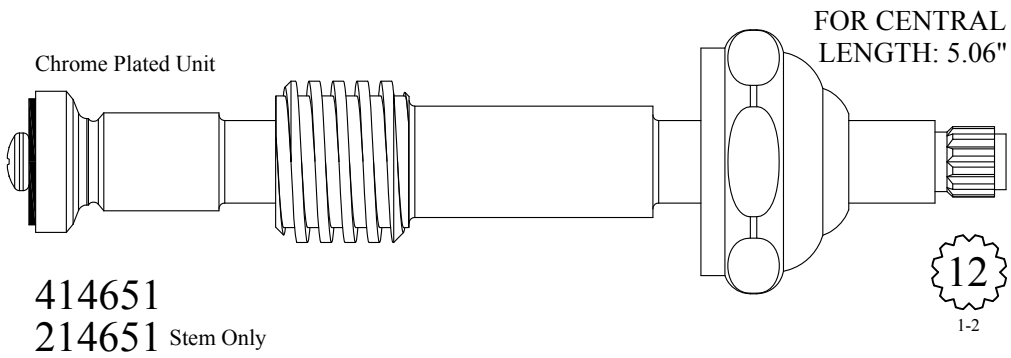

Plastic Escutcheon Nipple

FOR KOHLER
LENGTH: 5.08"

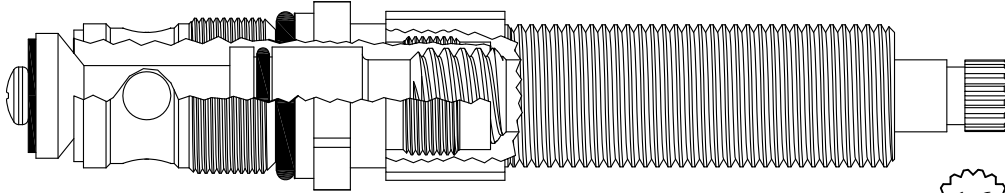

433171

GASKET: 891150 O-RING INCLUDED

16
1-6

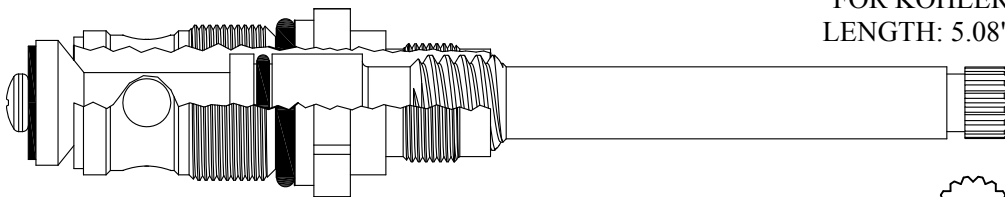

FOR KOHLER
LENGTH: 5.08"

433181

GASKET: 891150 O-RING INCLUDED

16
1-6

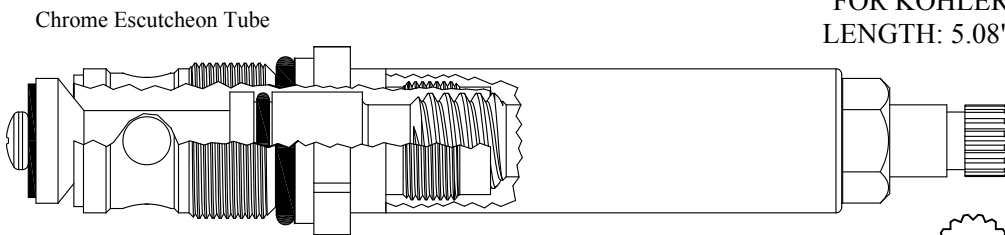

FOR KOHLER
LENGTH: 5.08"

433191

GASKET: 891150 O-RING INCLUDED

16
1-6

Chrome Plated Stem

FOR PRICE PFISTER
LENGTH: 5.09"

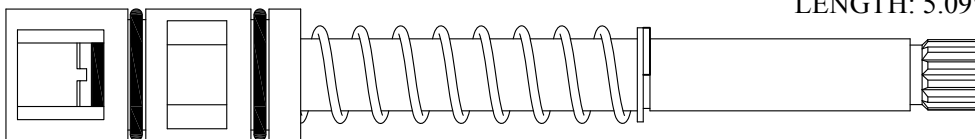

236260

12
1-2

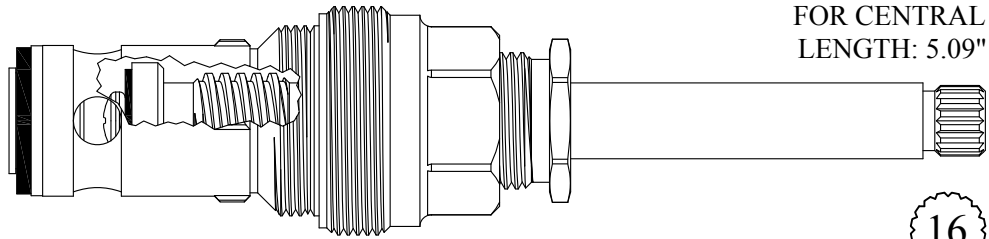

414821
 GASKET: 895340
 SEAT INCLUDED: 647850

16
 1-6

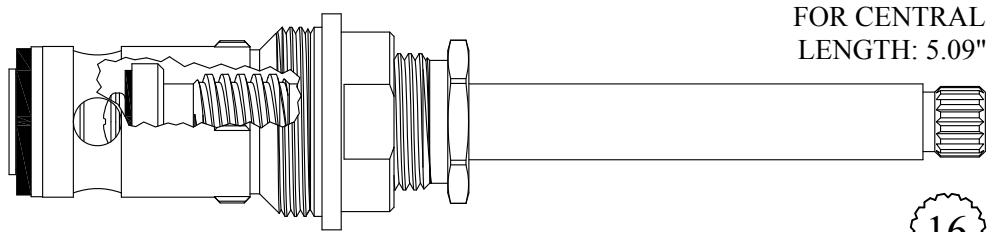

414811/ 414812
 GASKET: 895340
 SEAT INCLUDED: 647850

16
 1-6

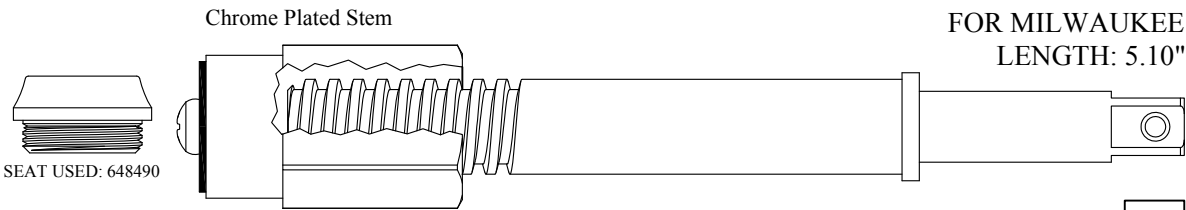

SEAT USED: 648490

408502
208502 Stem Only
 GASKET: 894960 INCLUDED

5/16

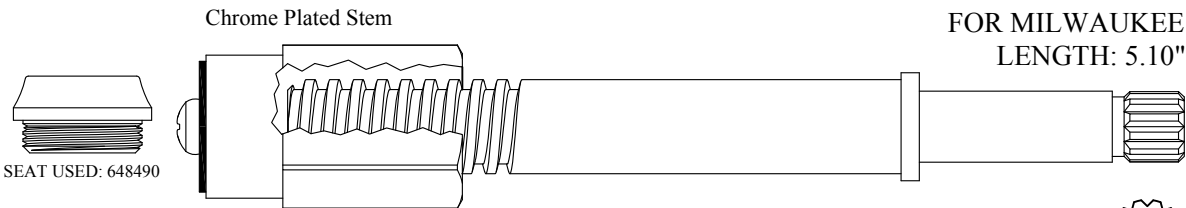

SEAT USED: 648490

408552
208552 Stem Only
 GASKET: 894960 INCLUDED

12
 1-2

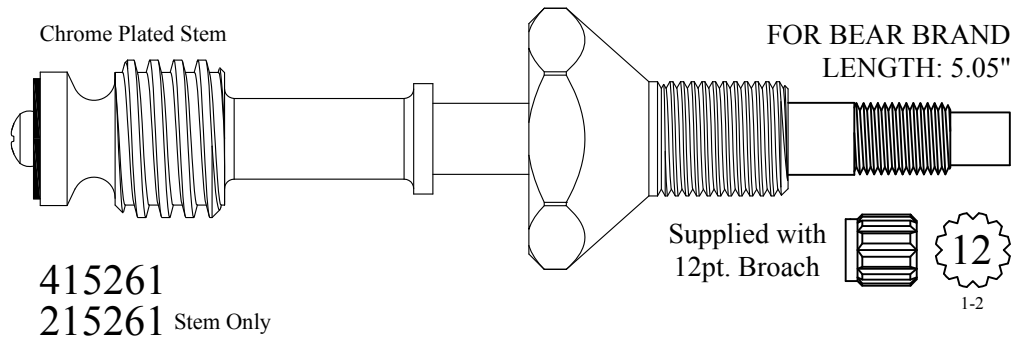

415261
215261 Stem Only

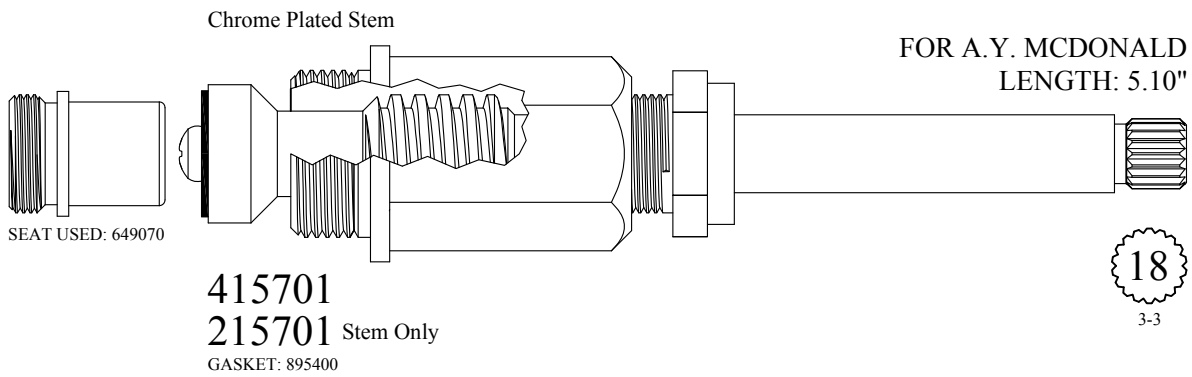

415701
215701 Stem Only
GASKET: 895400

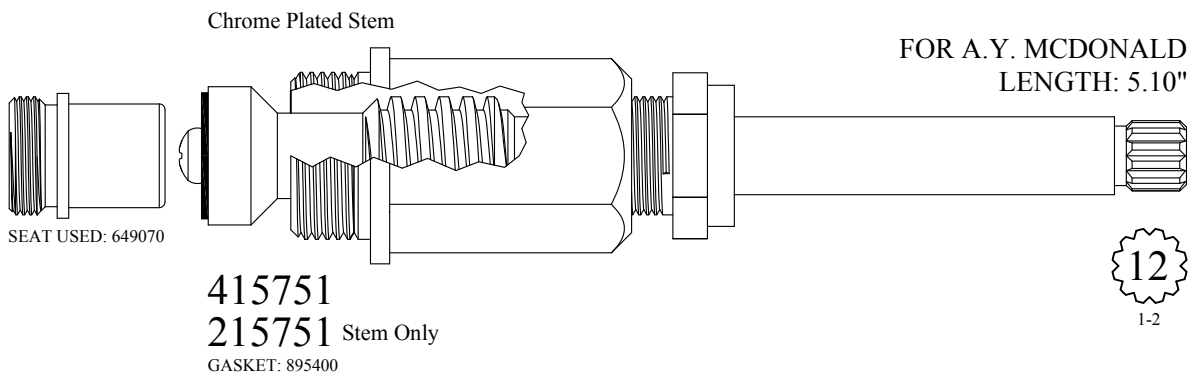

415751
215751 Stem Only
GASKET: 895400

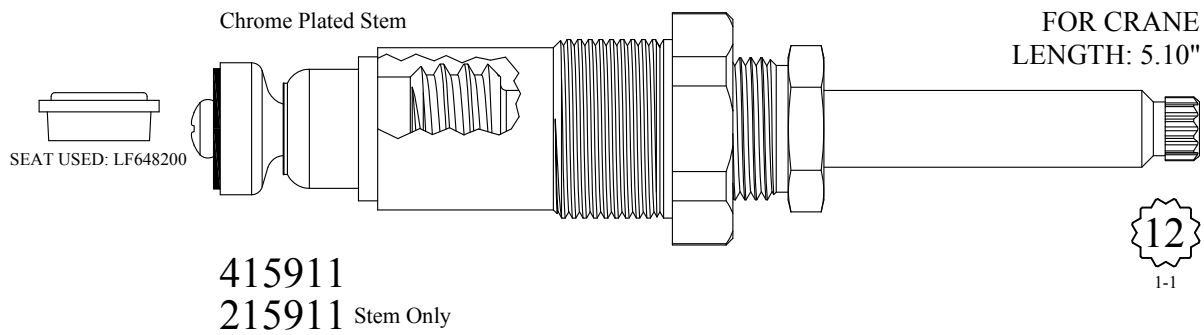

415911
215911 Stem Only

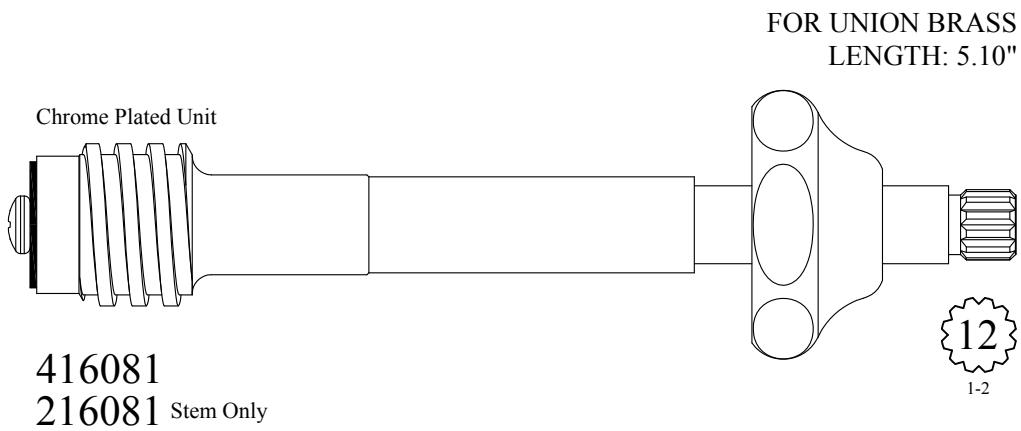
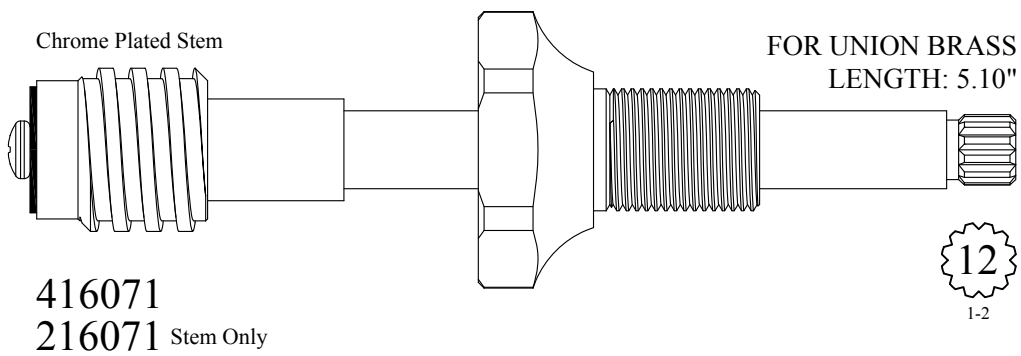
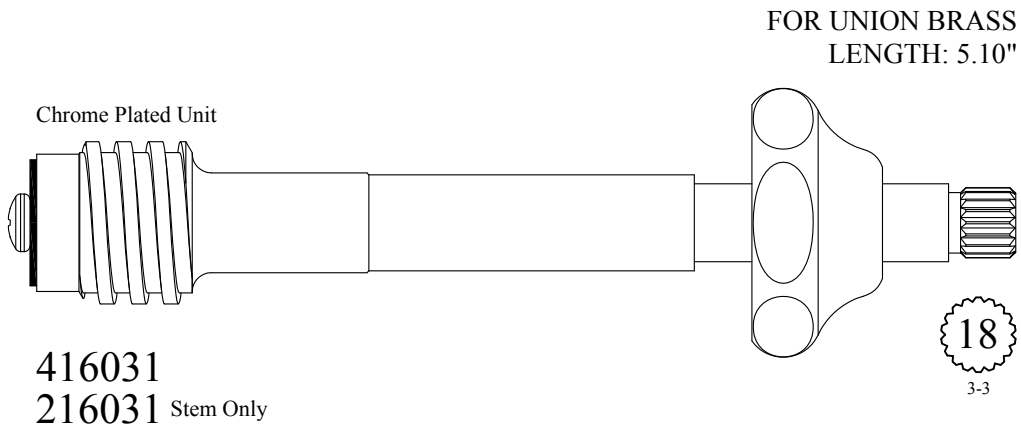
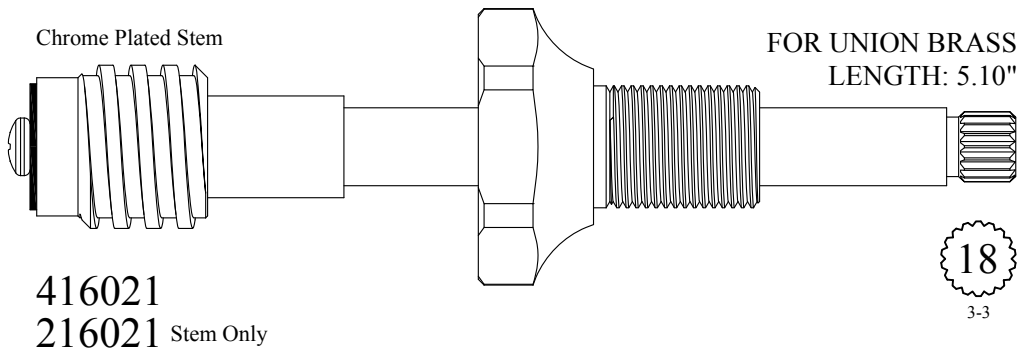

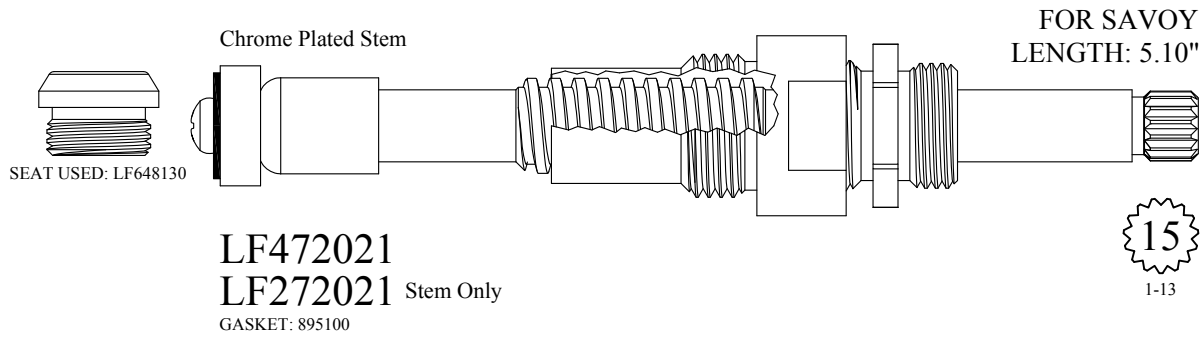

LF472021
LF272021 Stem Only
 GASKET: 895100

15
1-13

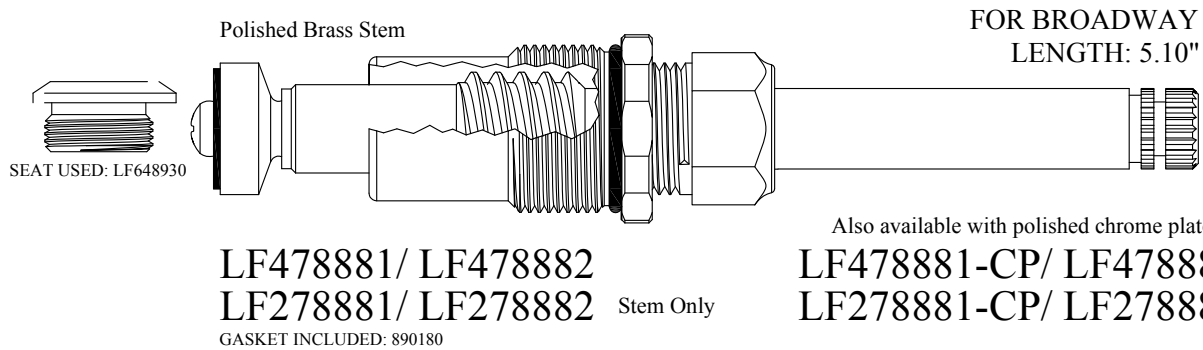

LF478881/ LF478882
LF278881/ LF278882 Stem Only
 GASKET INCLUDED: 890180

Also available with polished chrome plated stem
LF478881-CP/ LF478882-CP
LF278881-CP/ LF278882-CP Stem Only

20
2-4

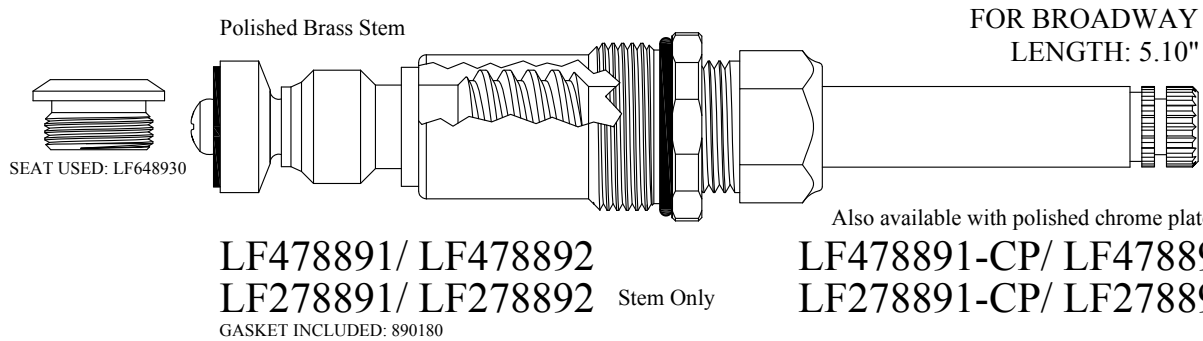

LF478891/ LF478892
LF278891/ LF278892 Stem Only
 GASKET INCLUDED: 890180

Also available with polished chrome plated stem
LF478891-CP/ LF478892-CP
LF278891-CP/ LF278892-CP Stem Only

20
2-4

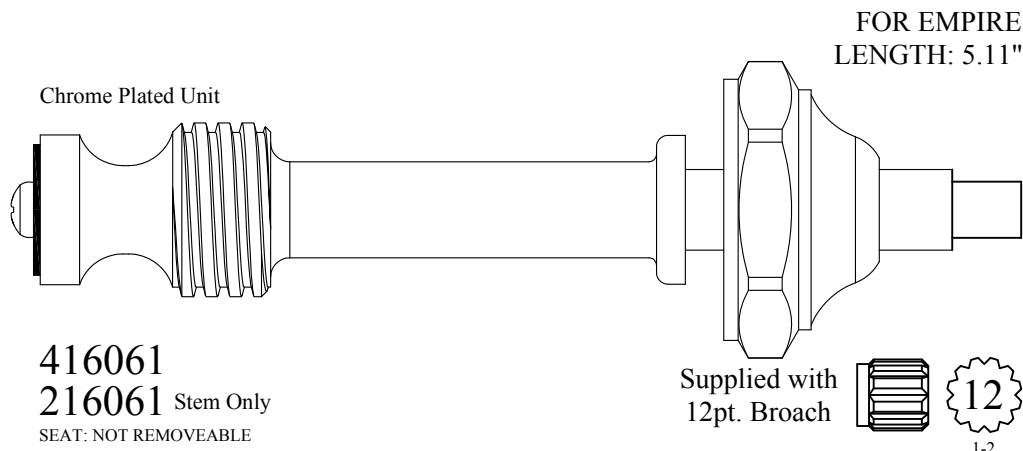

416061
216061 Stem Only
 SEAT: NOT REMOVEABLE

Supplied with
 12pt. Broach  12
1-2

Chrome Plated Gland & Push Button

FOR SYMMONS
LENGTH: 5.12"

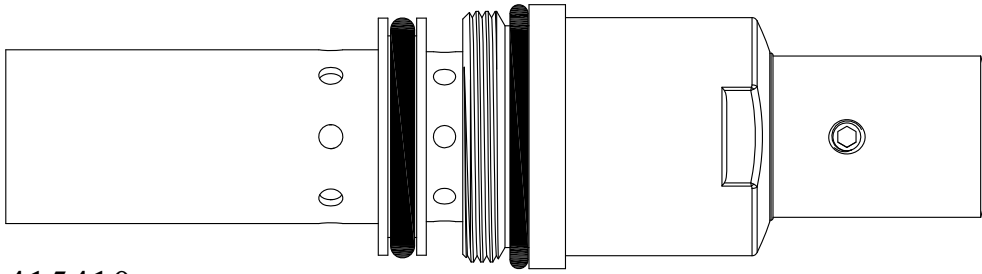

415410

432411
232411 Stem Only
GASKET: 895400

FOR SAVOY
LENGTH: 5.12"

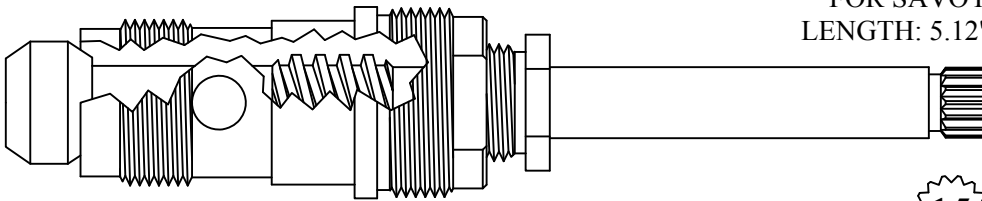

15
1-13

Chrome Plated Stem

FOR BRIGGS
LENGTH: 5.12"

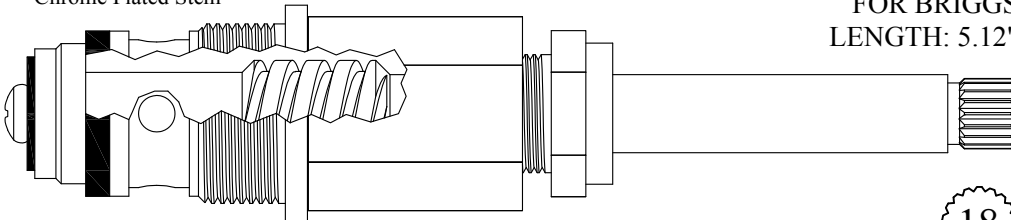

433502
233502 Stem Only
GASKET: 895370

18
3-3

Chrome Plated Unit

FOR BRIGGS
LENGTH: 5.12"

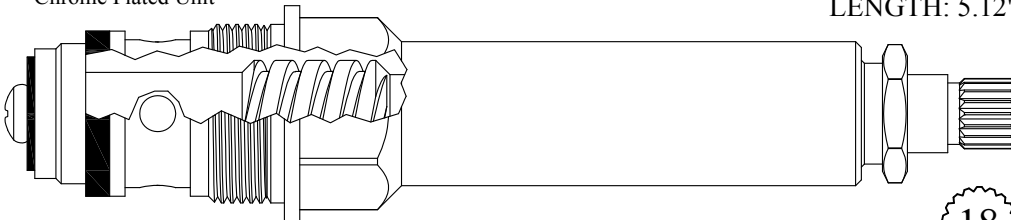

433512
233502 Stem Only
GASKET: 895370

18
3-3

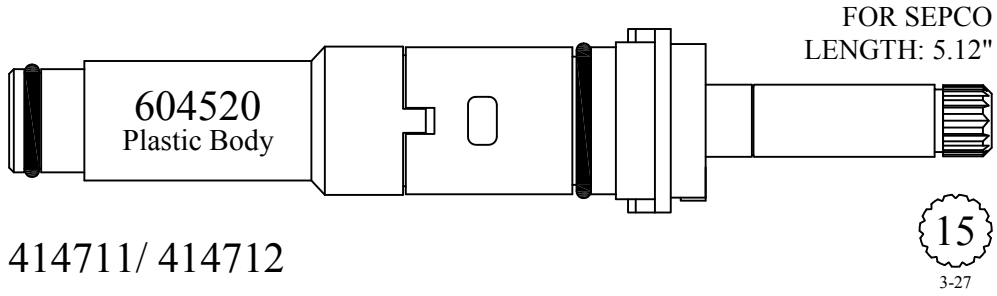

414711/ 414712

15
3-27

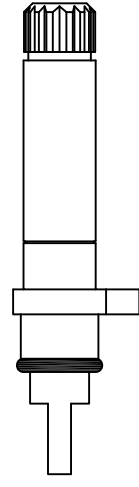

Available: Stem Only
214711 / 214712

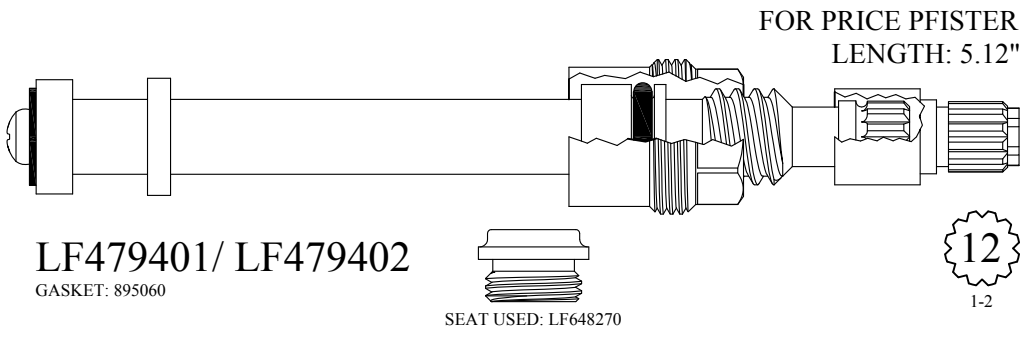

LF479401/ LF479402
GASKET: 895060



12
1-2

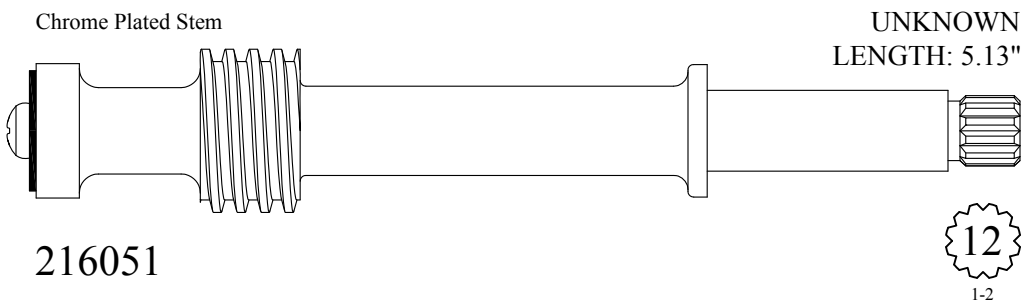

216051

12
1-2

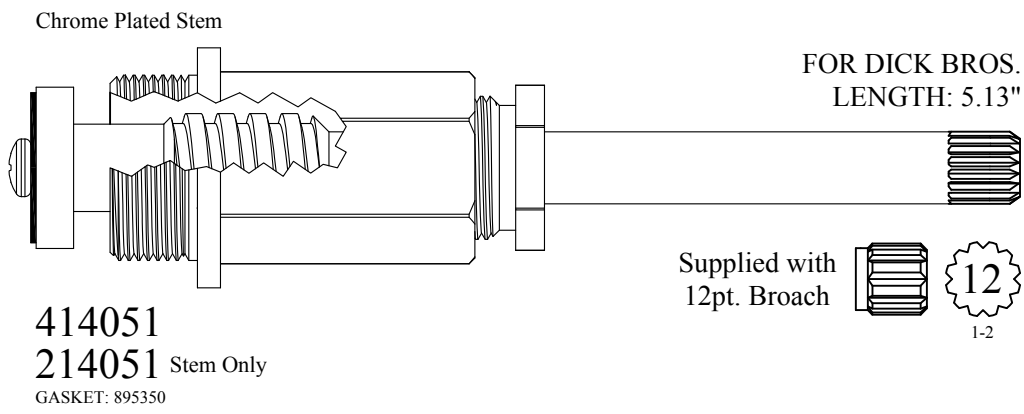

414051
214051 Stem Only
GASKET: 895350

Supplied with
12pt. Broach

12
1-2

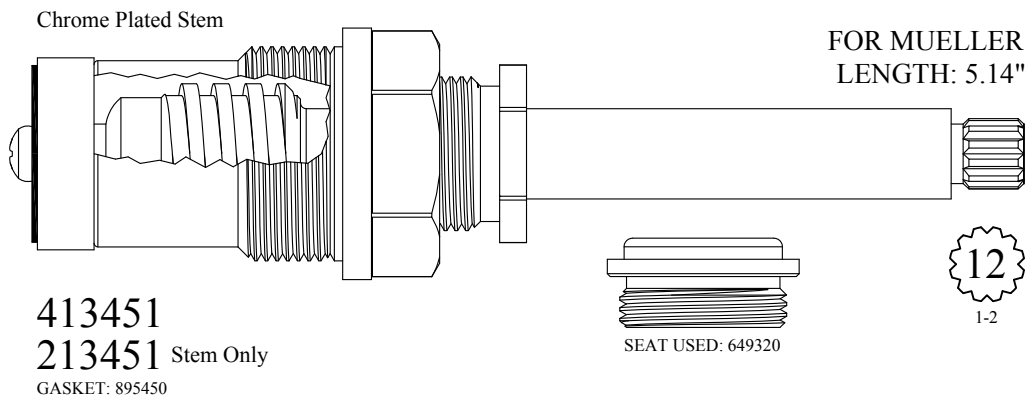
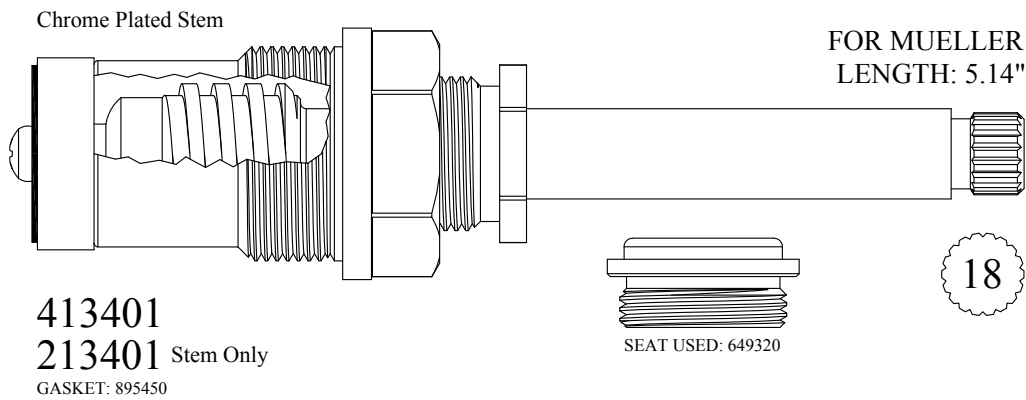
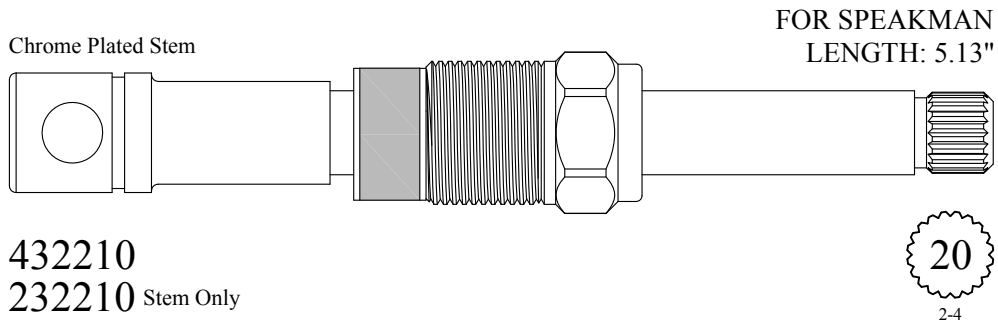
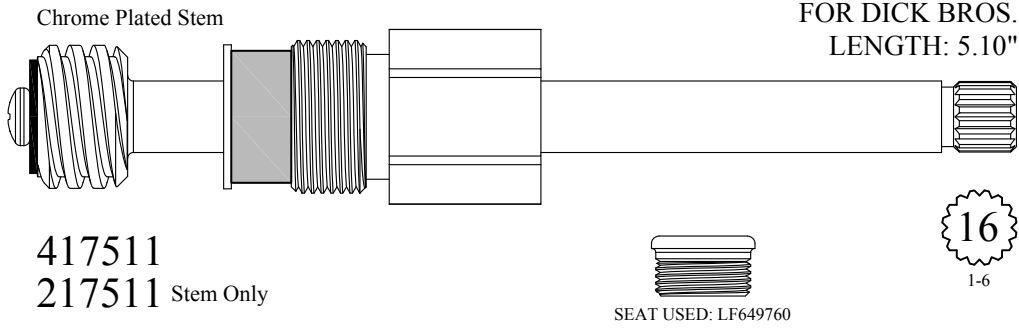

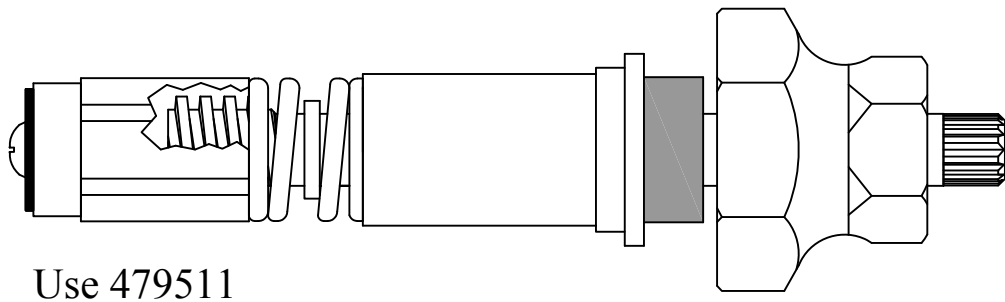
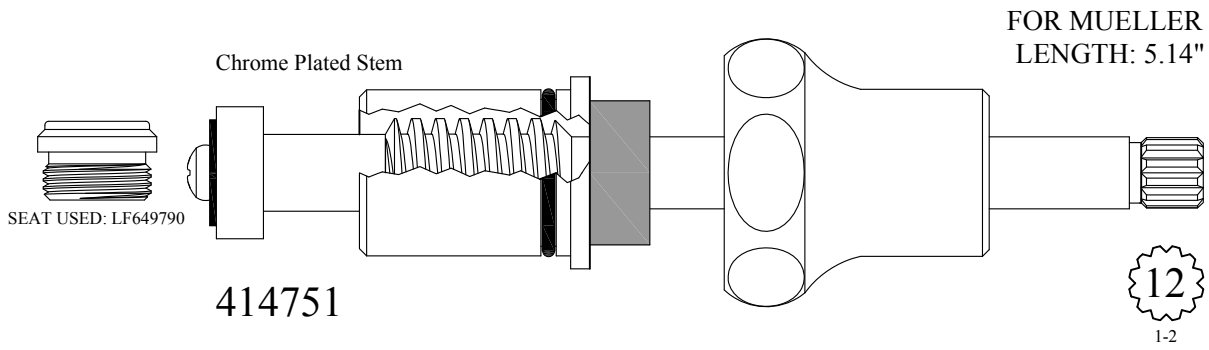
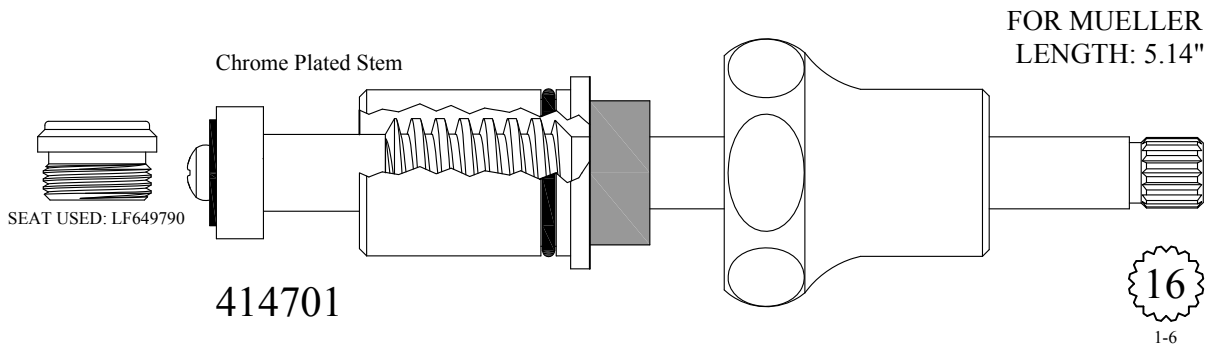
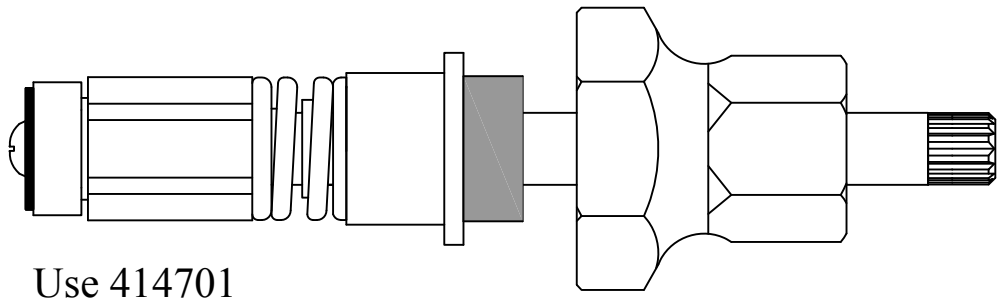

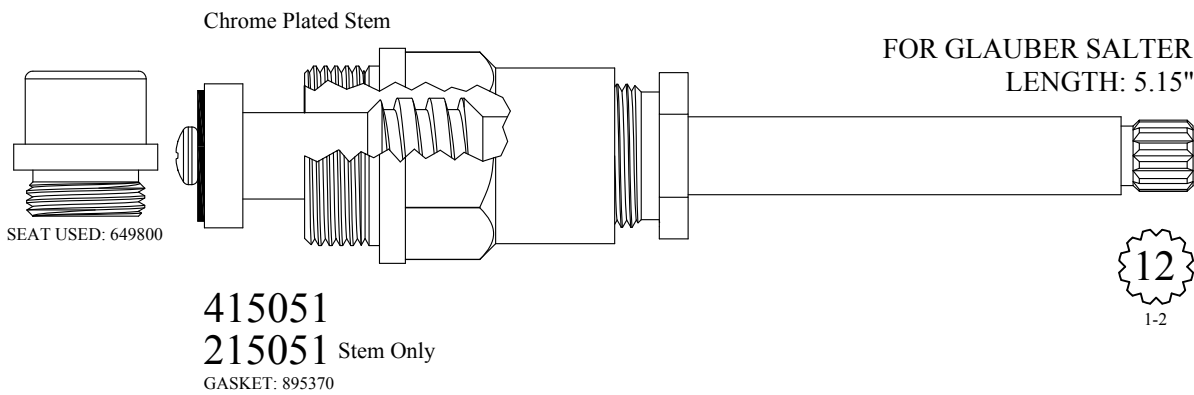
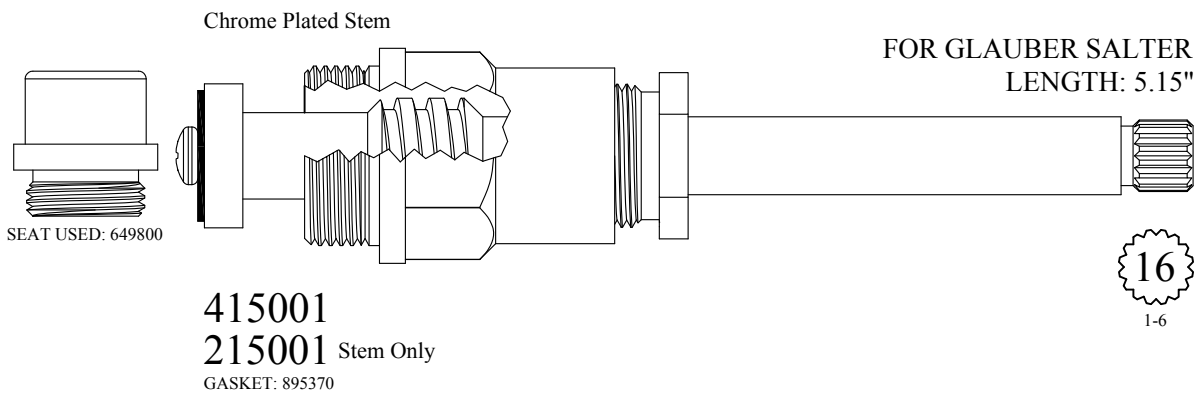
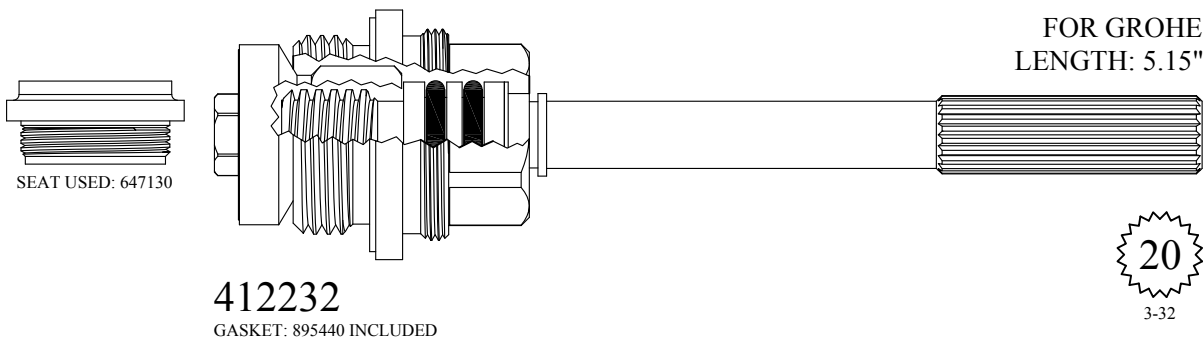
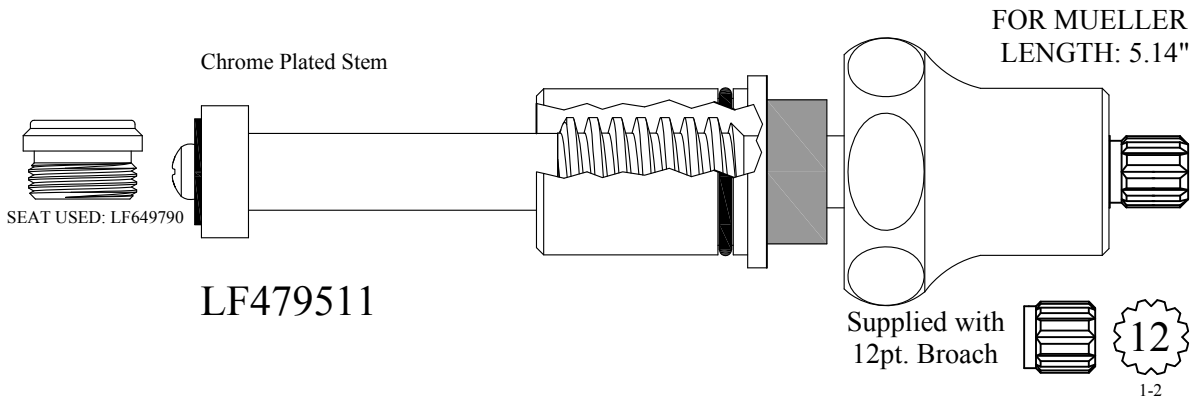

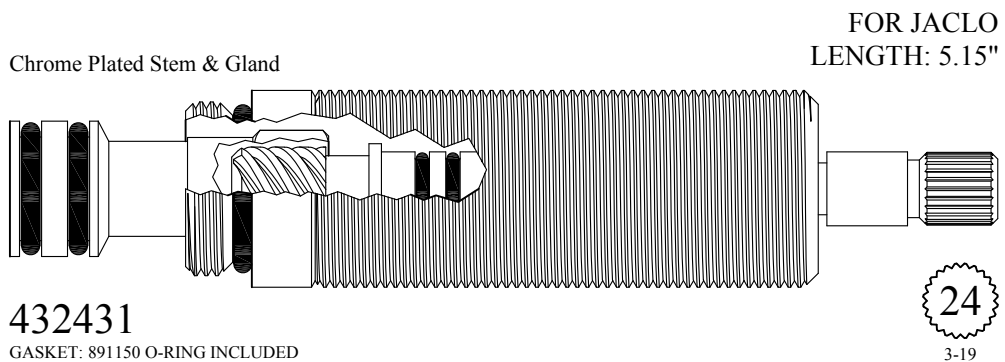
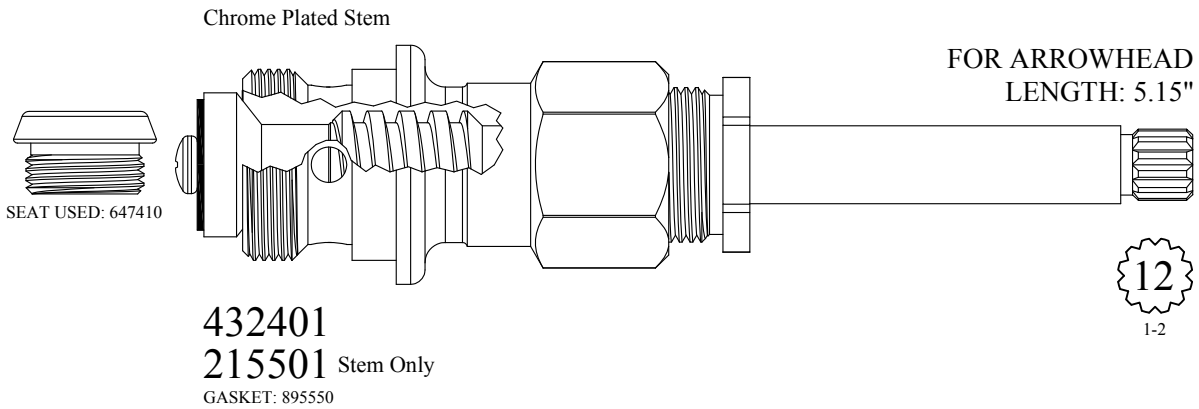
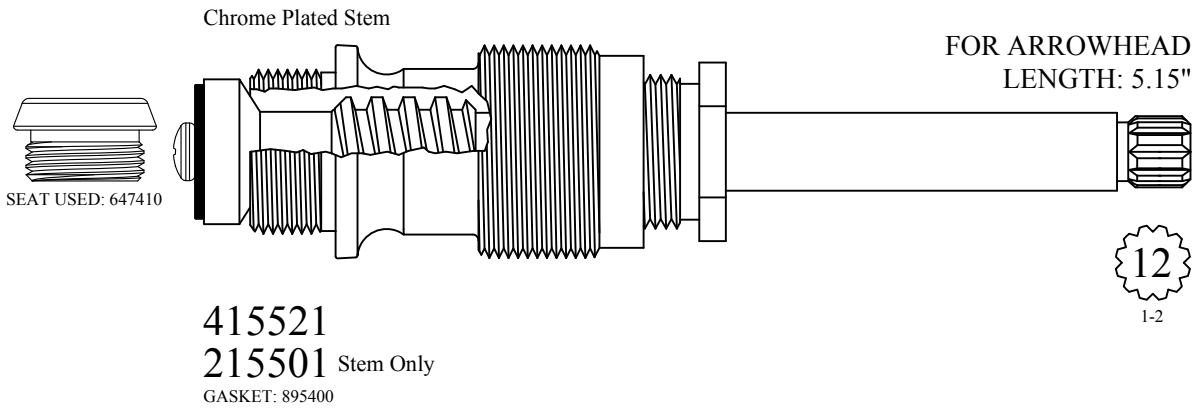
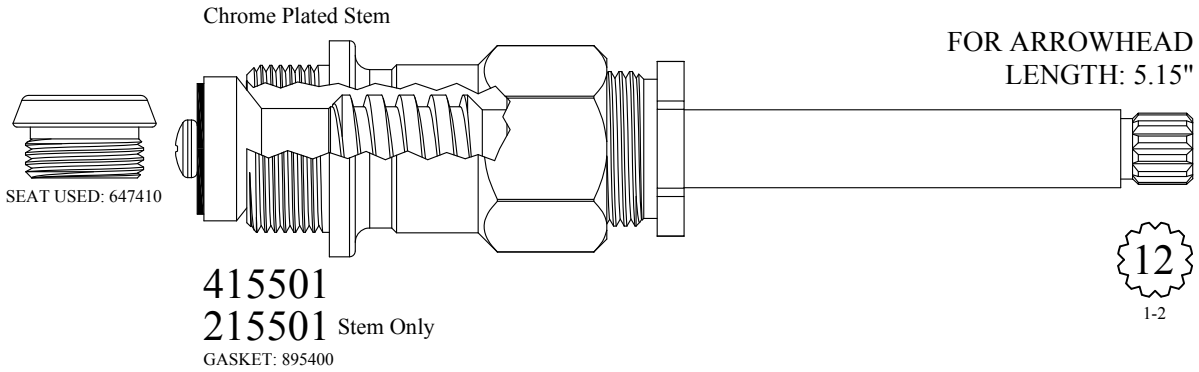

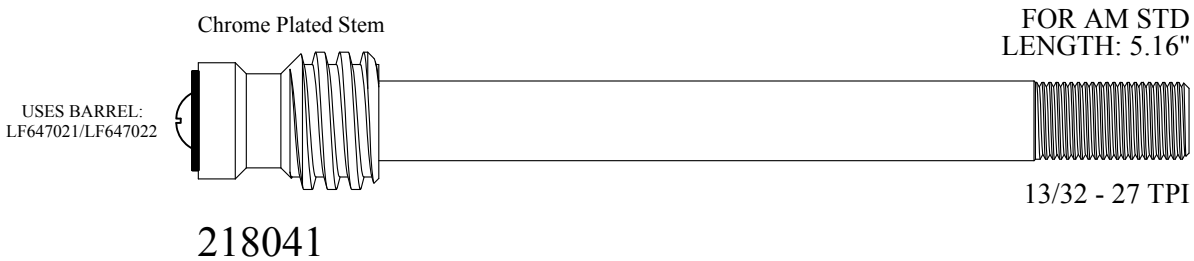
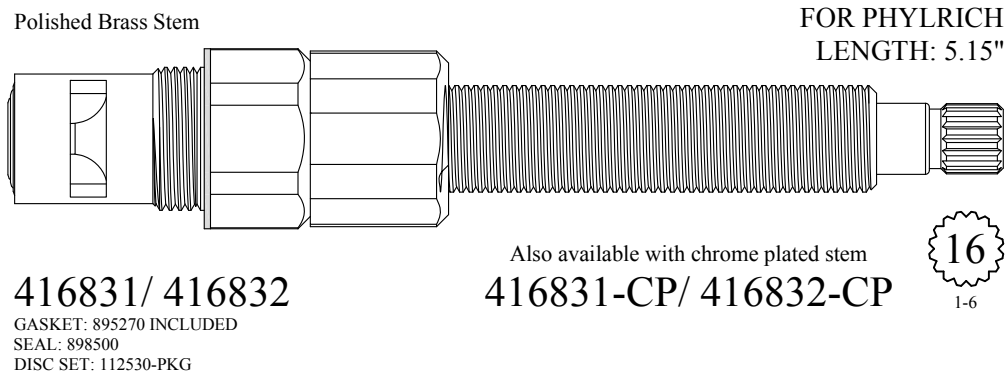
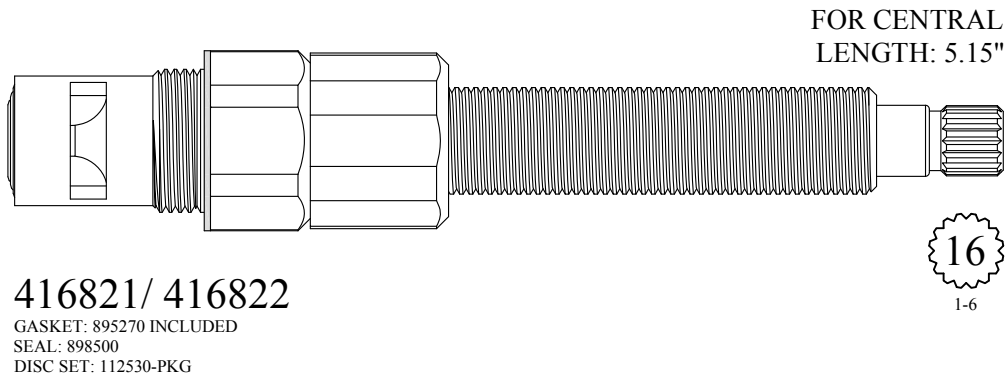
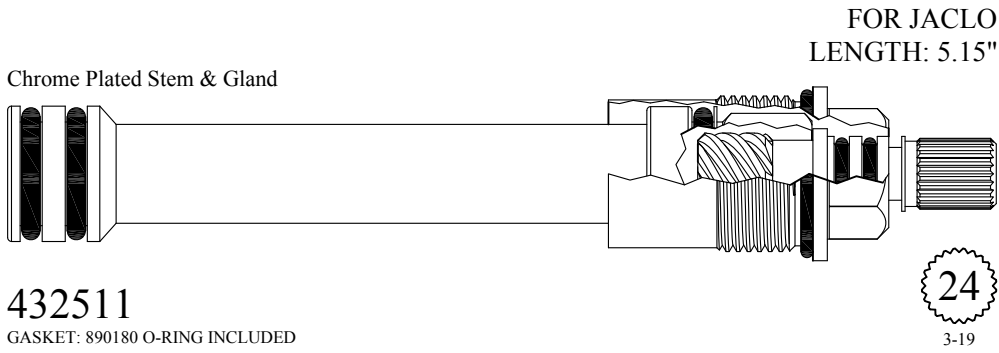

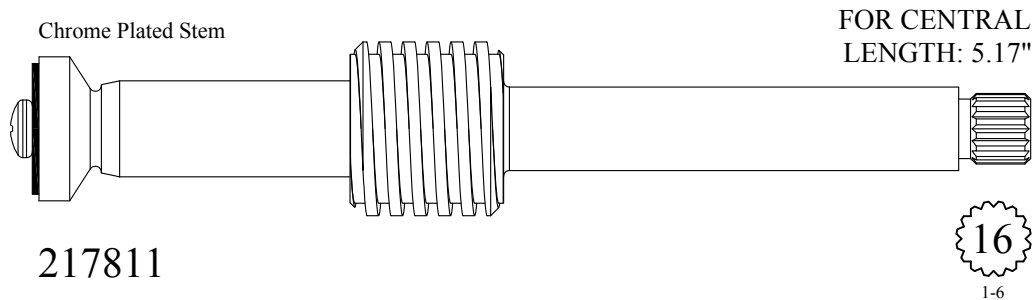
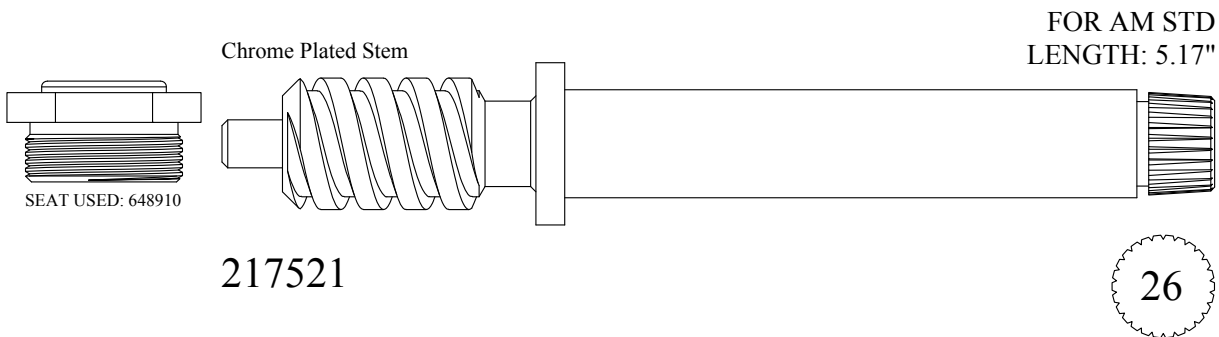
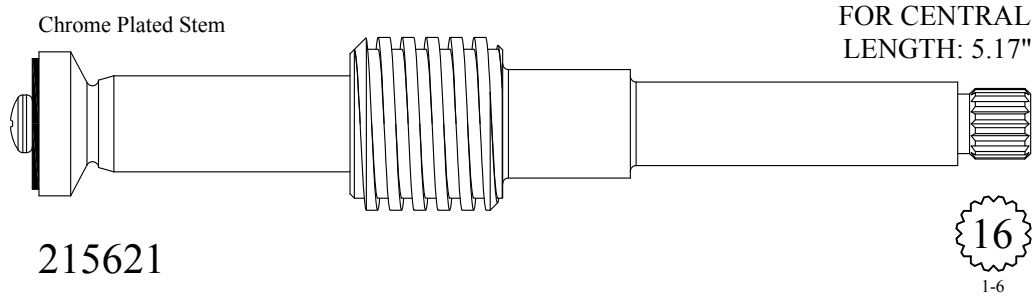
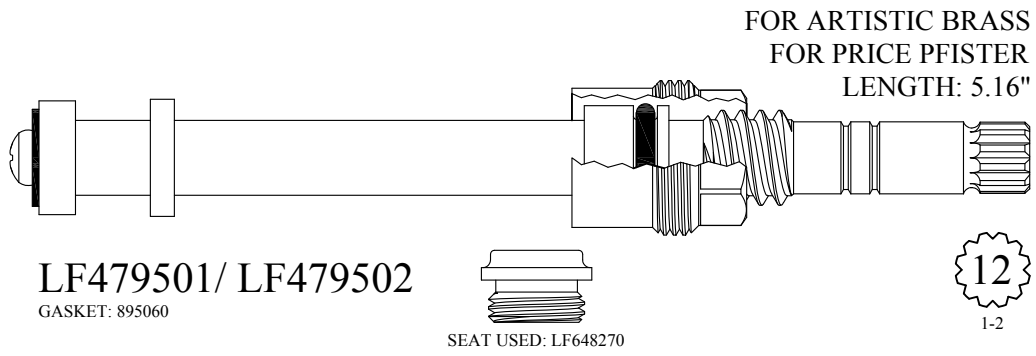

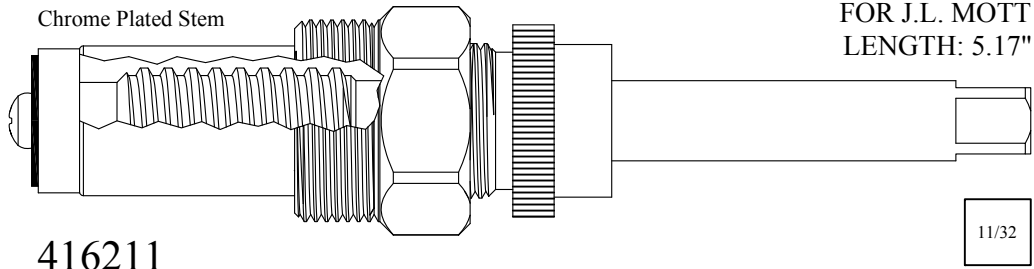

Chrome Plated Stem

FOR J.L. MOTT
LENGTH: 5.17"

11/32

416211
216211 Stem Only
GASKET: 895160

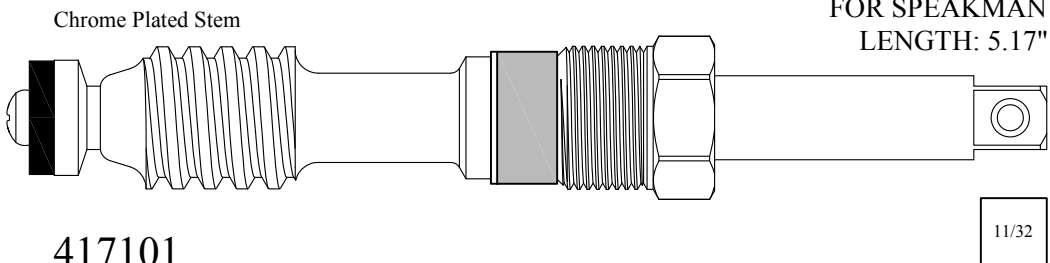

Chrome Plated Stem

FOR SPEAKMAN
LENGTH: 5.17"

11/32

417101
217101 Stem Only

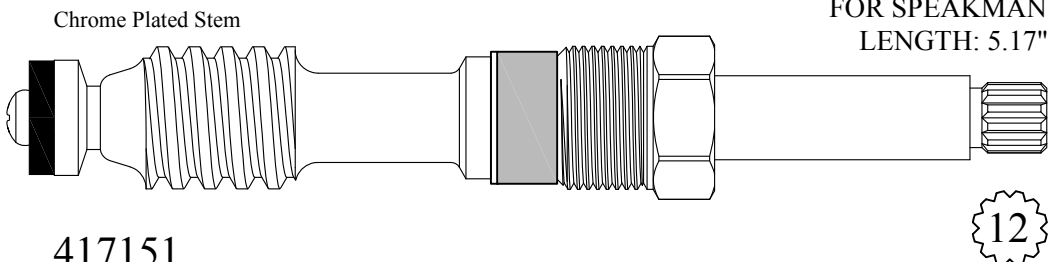

Chrome Plated Stem

FOR SPEAKMAN
LENGTH: 5.17"

12
1-2

417151
217151 Stem Only

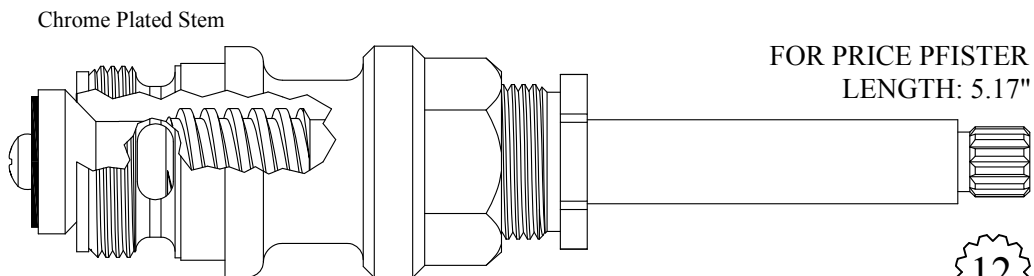

Chrome Plated Stem

FOR PRICE PFISTER
LENGTH: 5.17"

12
1-2

432001
232001 Stem Only
GASKET: 895560

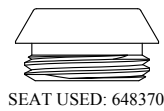

SEAT USED: 648370

Chrome Plated Stem

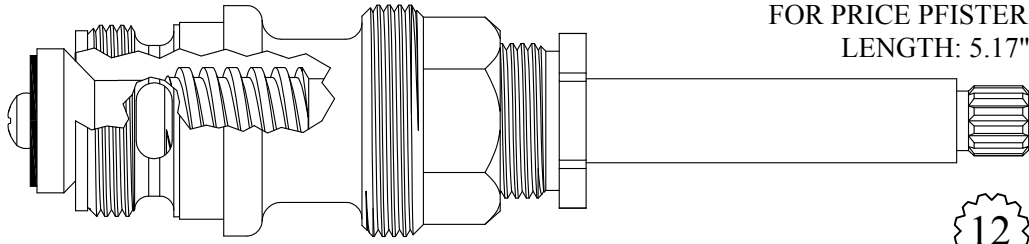

FOR PRICE PFISTER
LENGTH: 5.17"

432011
232001 Stem Only
GASKET: 895560



SEAT USED: 648370



1-2

Chrome Plated Gland

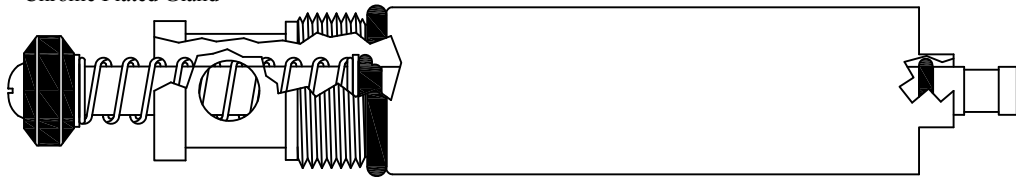

FOR KOHLER
LENGTH: 5.17"

432810
GASKET: 891150 O-RING INCLUDED

Chrome Plated Stem

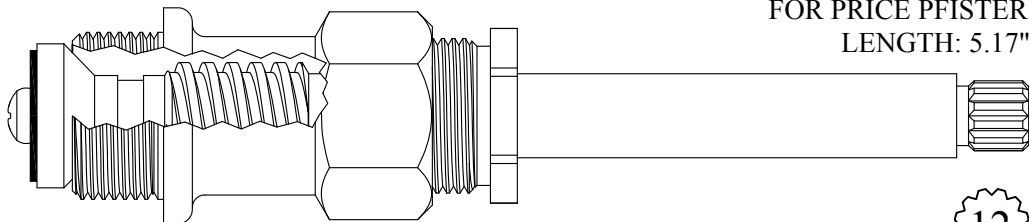

FOR PRICE PFISTER
LENGTH: 5.17"

415301/ 415302
215301/ 215302 Stem Only
GASKET: 895400



SEAT USED: 648370



1-2

Chrome Plated Stem

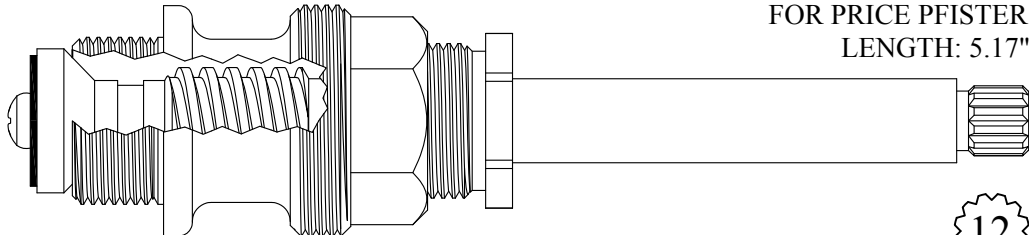

FOR PRICE PFISTER
LENGTH: 5.17"

415311/ 415312
215301/ 215302 Stem Only
GASKET: 895400



SEAT USED: 648370



1-2

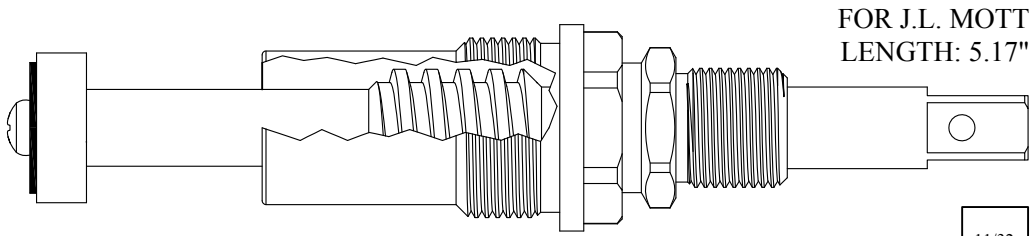

LF479701
LF279701 Stem Only
GASKET: 895320

11/32

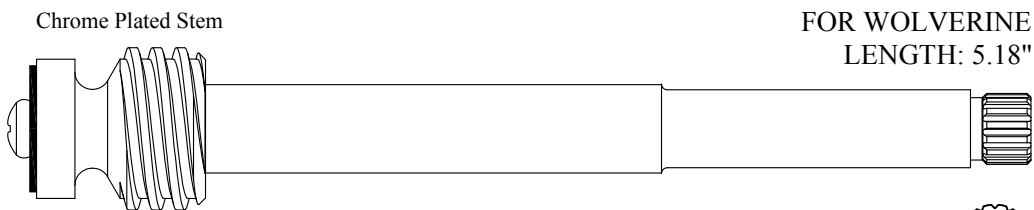

215921

15
3-27

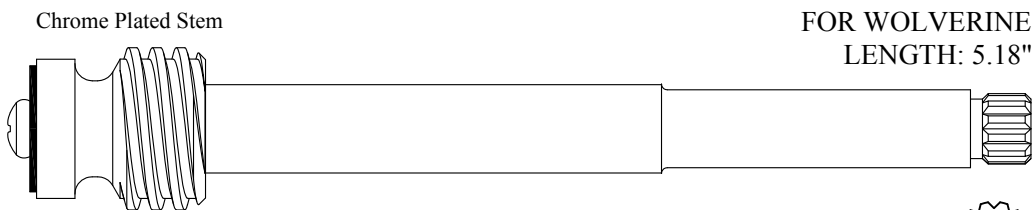

215971

12
1-2

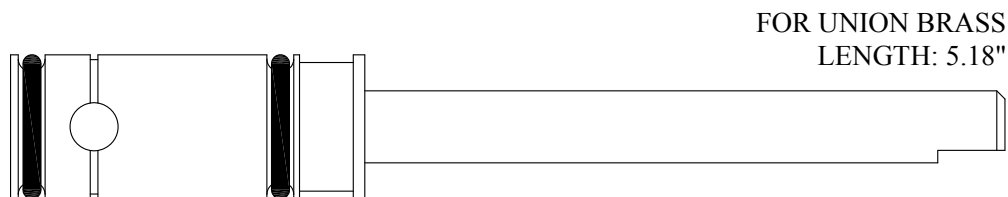

232700

1/2

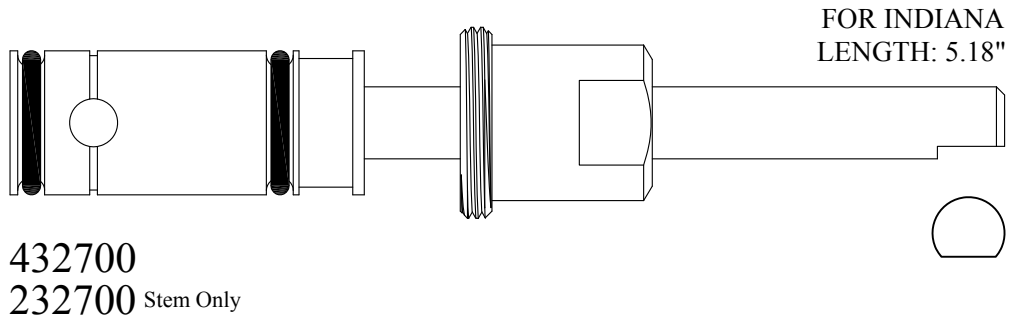

432700
232700 Stem Only

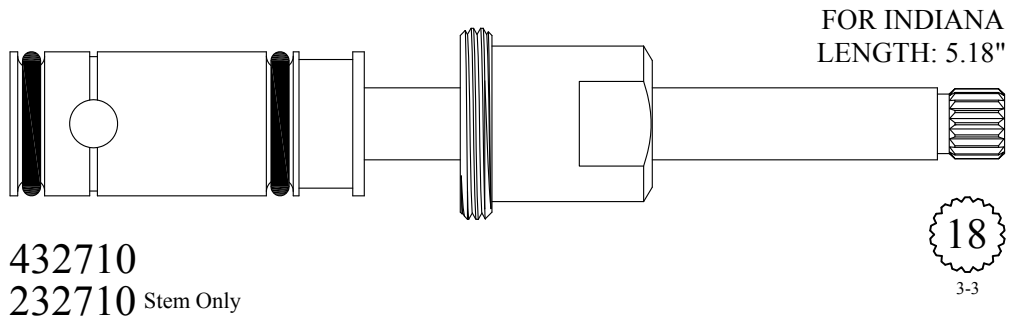

432710
232710 Stem Only

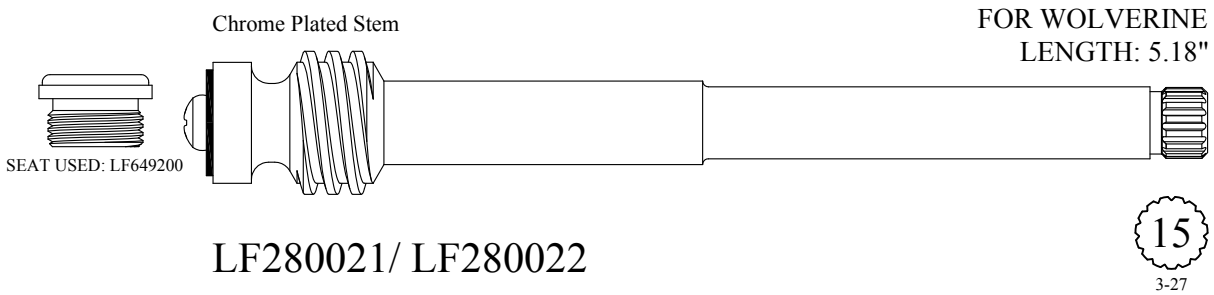

LF280021/ LF280022

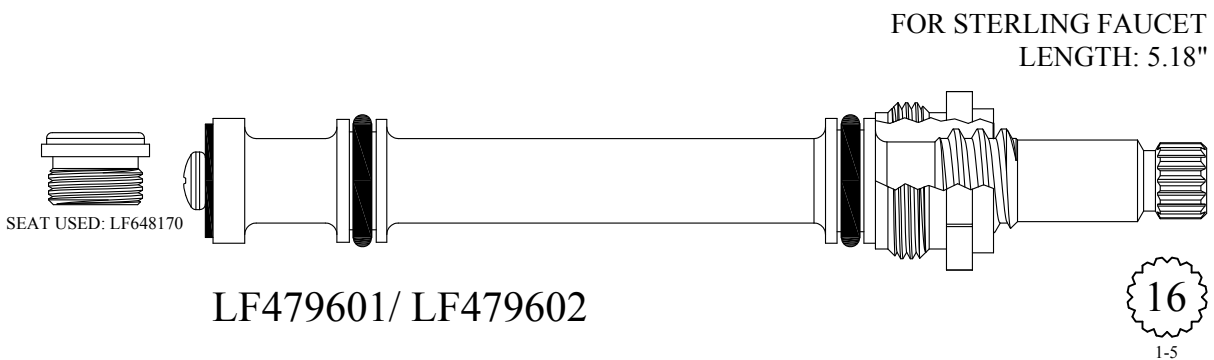

LF479601/ LF479602

Chrome Plated Stem & Sleeve

FOR ACME
LENGTH: 5.19"

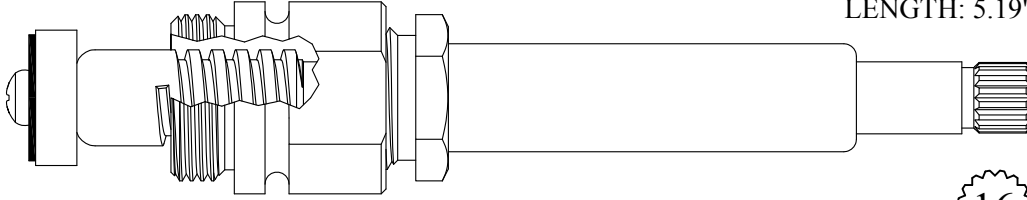

414621
214621 Stem Only
GASKET: 895180

16
1-6

Chrome Plated Stem

FOR CENTRAL
LENGTH: 5.19"

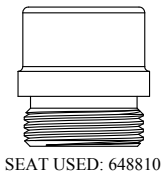

SEAT USED: 648810

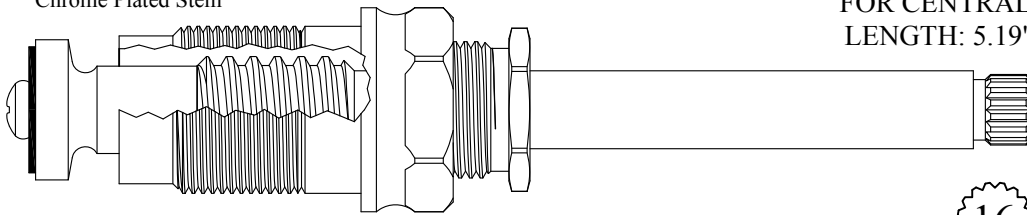

416801
216801 Stem Only
GASKET: 895400

16
1-6

FOR ACME
LENGTH: 5.19"

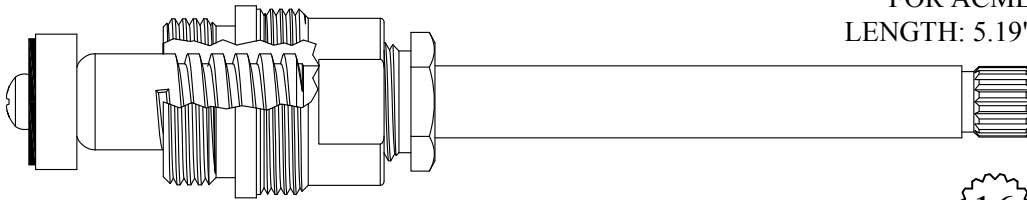

416911
216911 Stem Only
GASKET: 895180

16
1-6

Chrome Plated Stem

FOR STERLING BRASS
FOR DICK BROS.
LENGTH: 5.19"

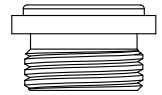

SEAT USED: LF649010

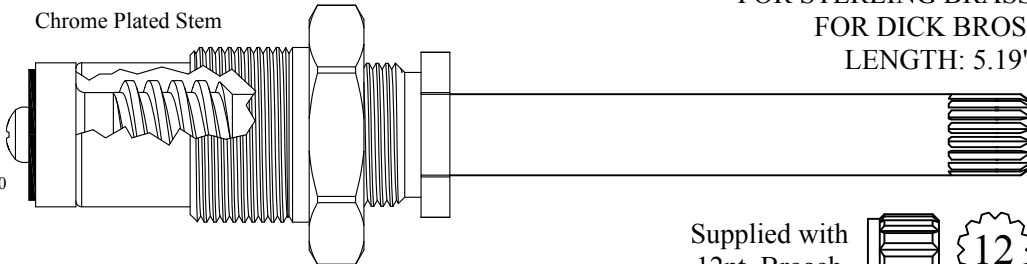

Supplied with
12pt. Broach

12
1-2

416951/ 416952
GASKET: 895370

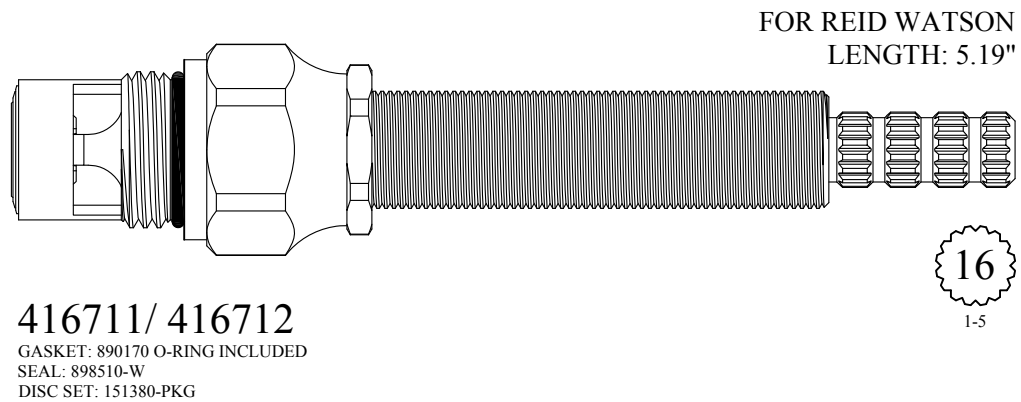
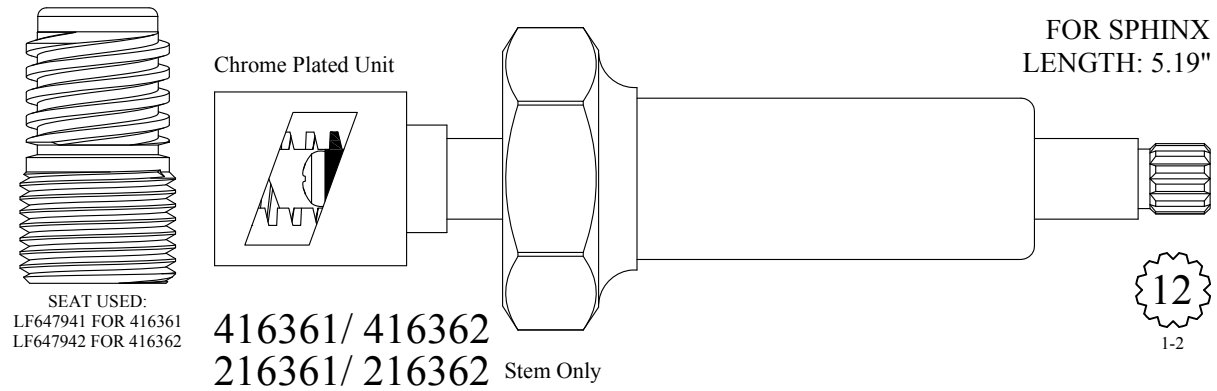
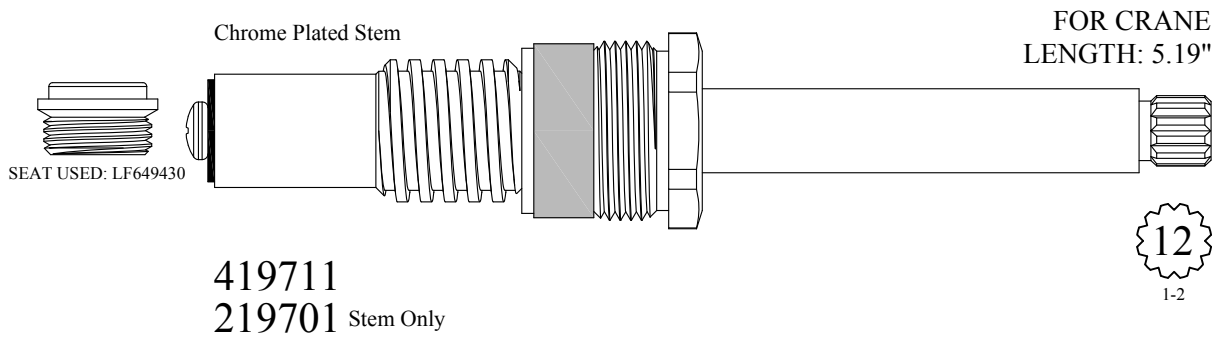
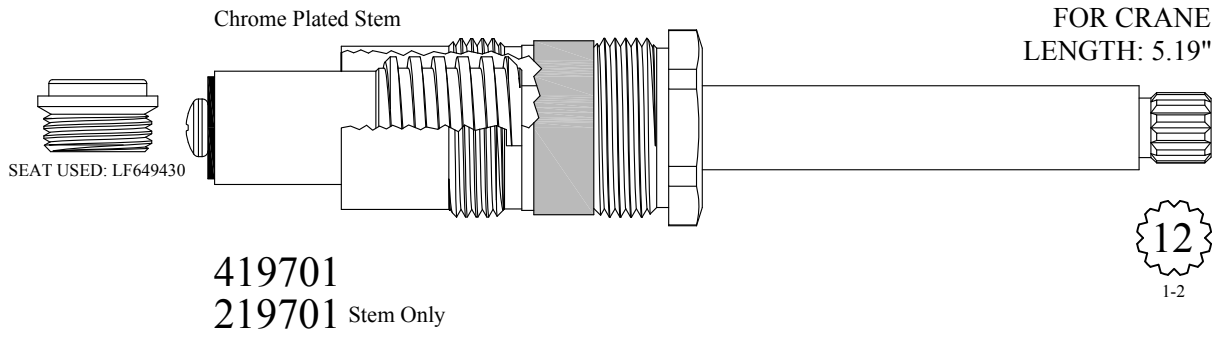

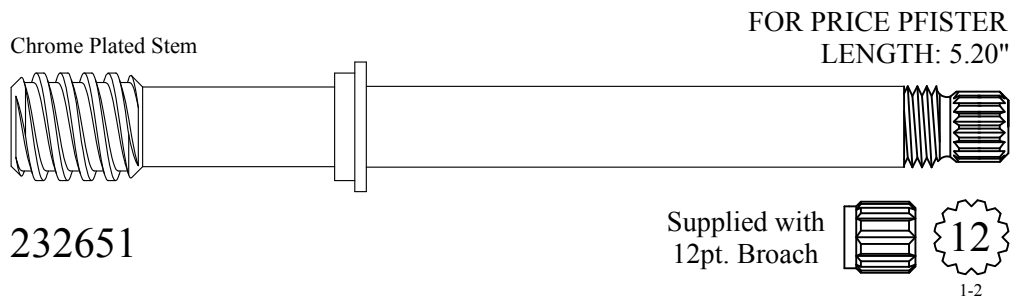
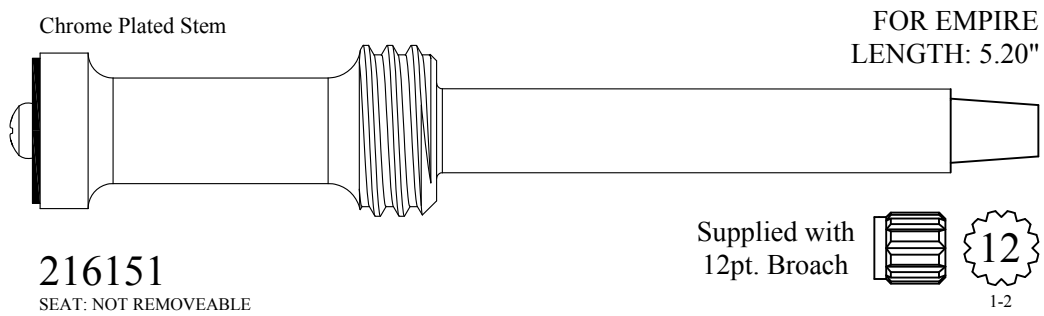
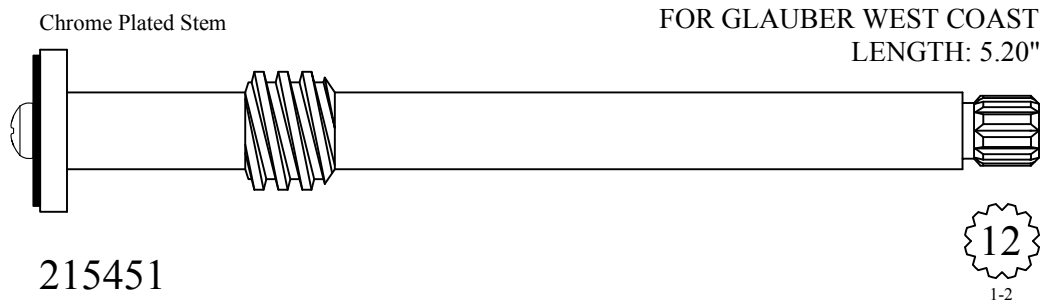
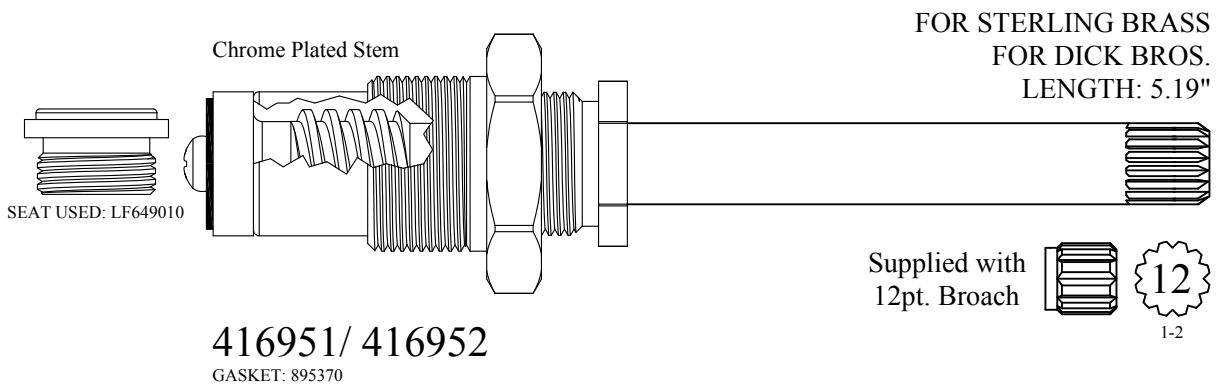

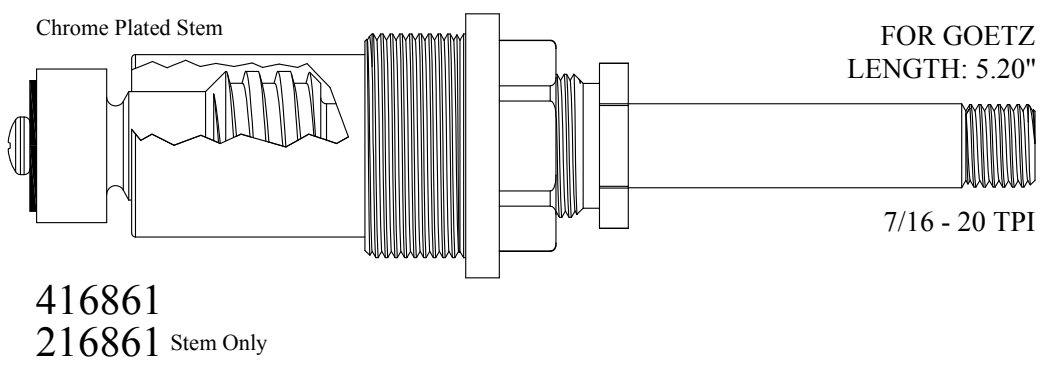
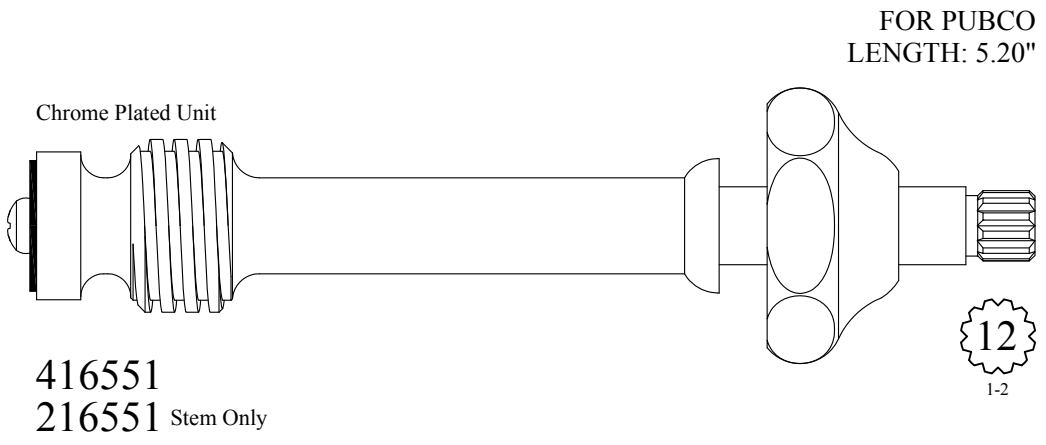
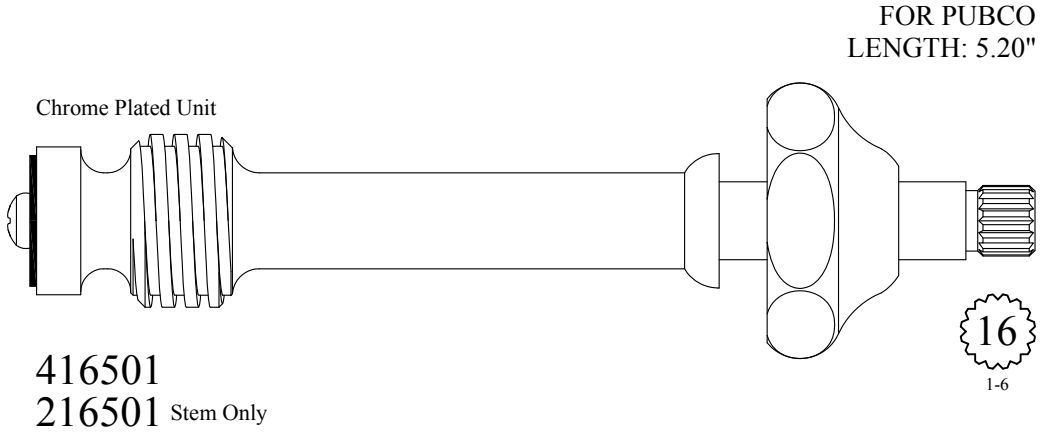
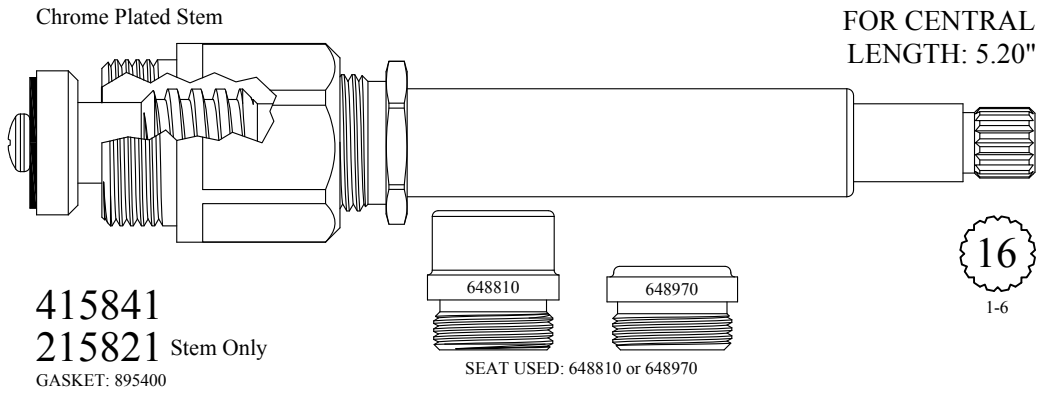

Also available with chrome plated stem

415831/ 415832

215821/ 215822 Stem Only

FOR CENTRAL
LENGTH: 5.20"

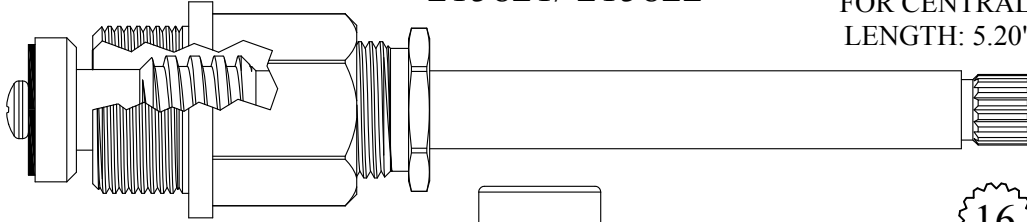

16
1-6

415801/ 415802

215801/ 215802 Stem Only

GASKET: 895400

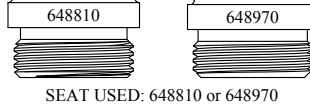

SEAT USED: 648810 or 648970

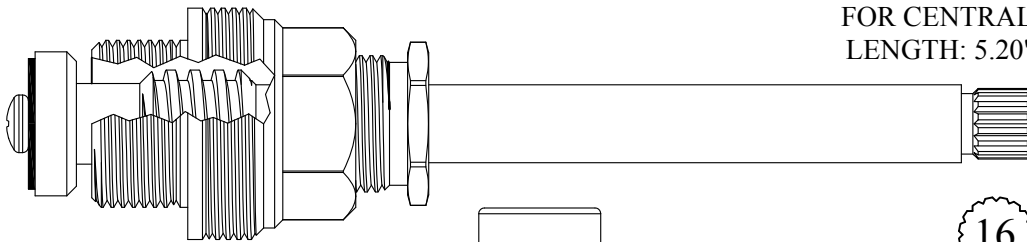

FOR CENTRAL
LENGTH: 5.20"

16
1-6

415811/ 415812

215801/ 215802 Stem Only

GASKET: 895400

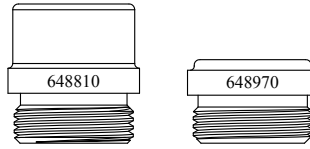

SEAT USED: 648810 or 648970

Chrome Plated Stem

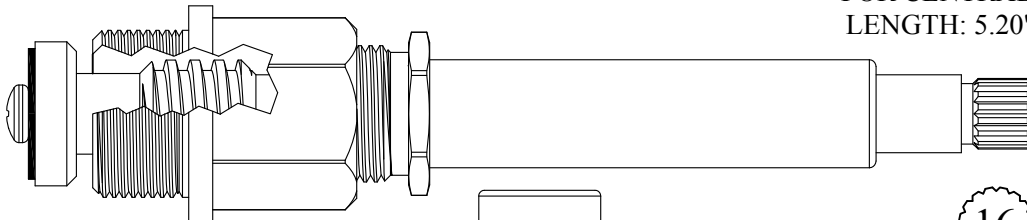

FOR CENTRAL
LENGTH: 5.20"

16
1-6

415821/ 415822

215821/ 215822 Stem Only

GASKET: 895400

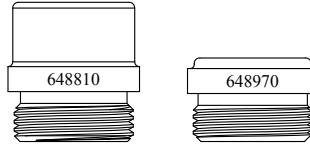

SEAT USED: 648810 or 648970

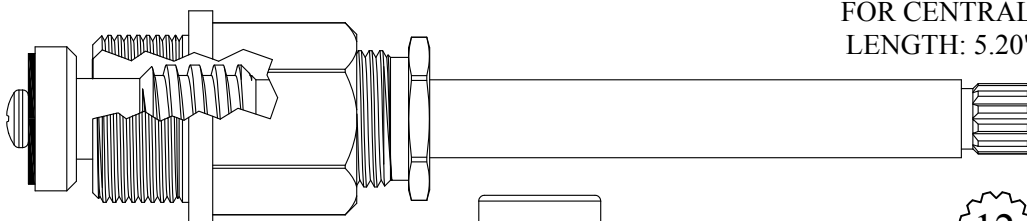

FOR CENTRAL
LENGTH: 5.20"

12
1-2

415851/ 415852

215851/ 215852 Stem Only

GASKET: 895400

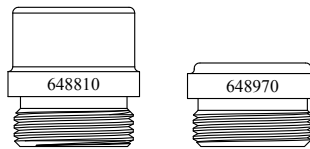

SEAT USED: 648810 or 648970

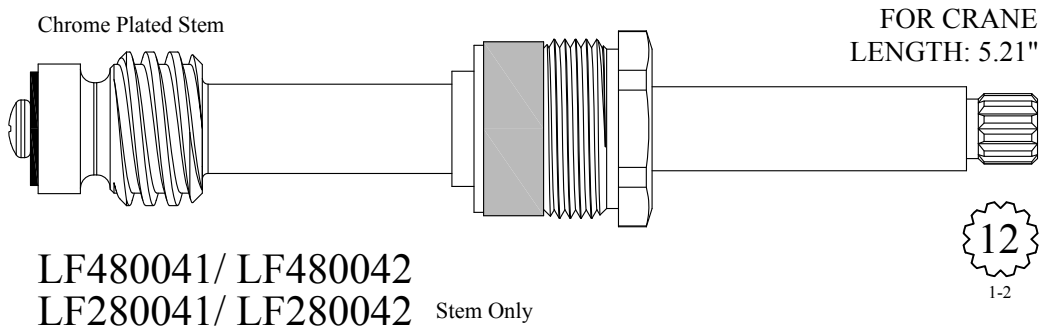
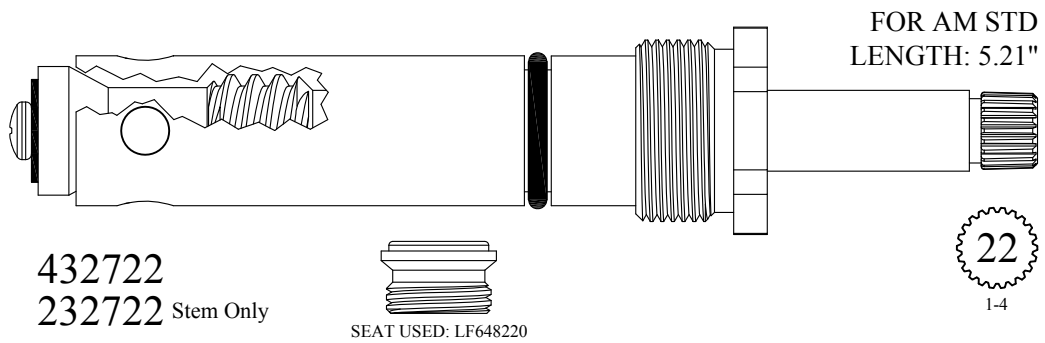
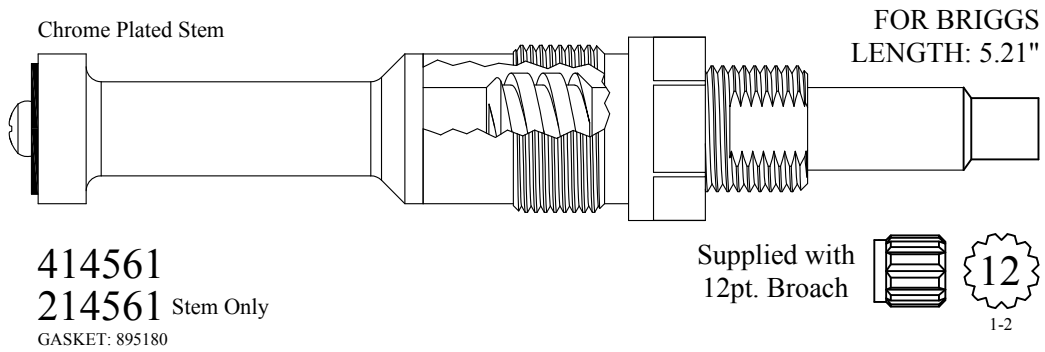
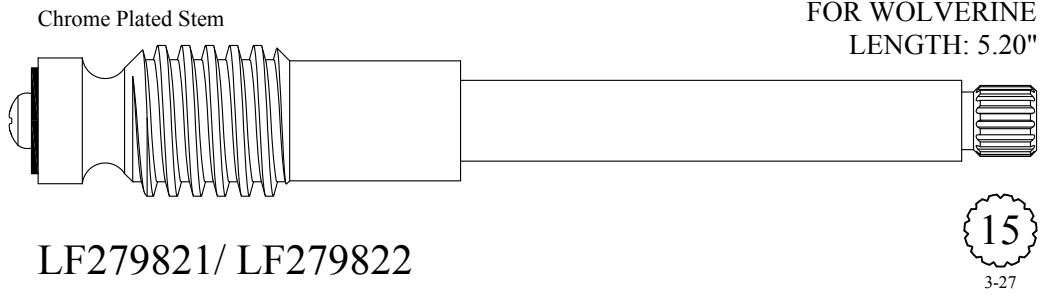

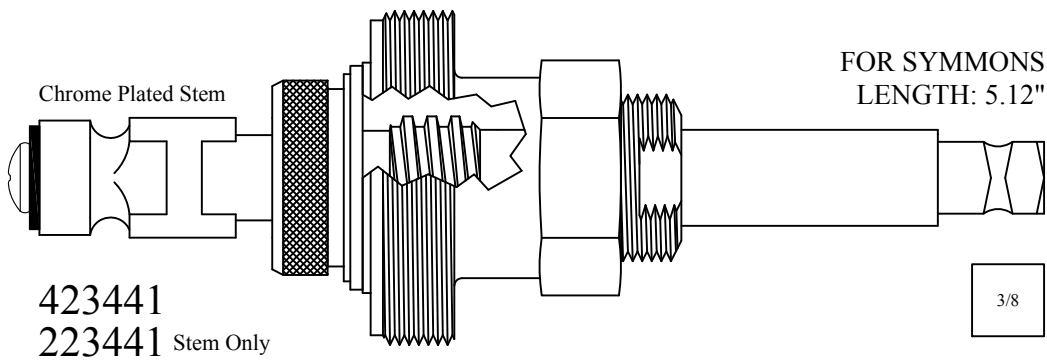
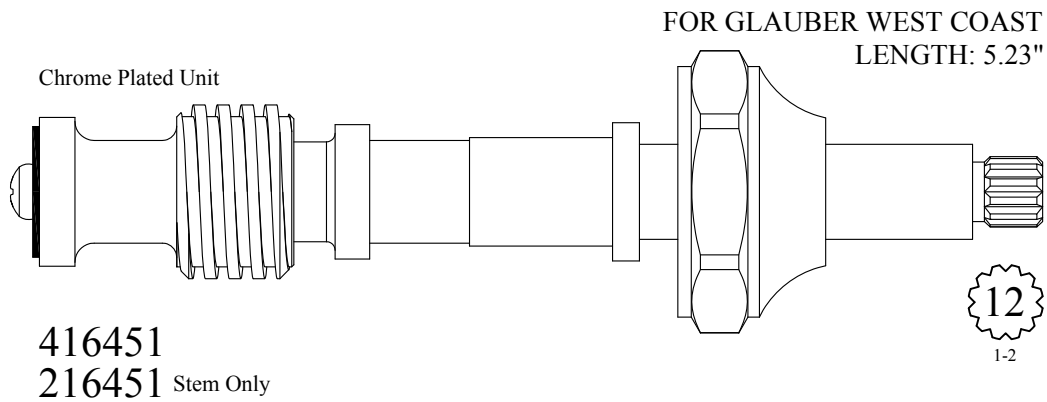
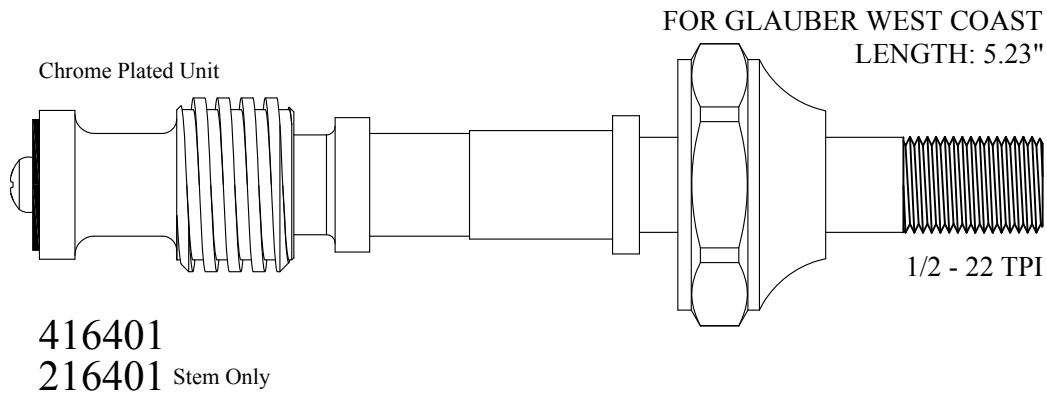
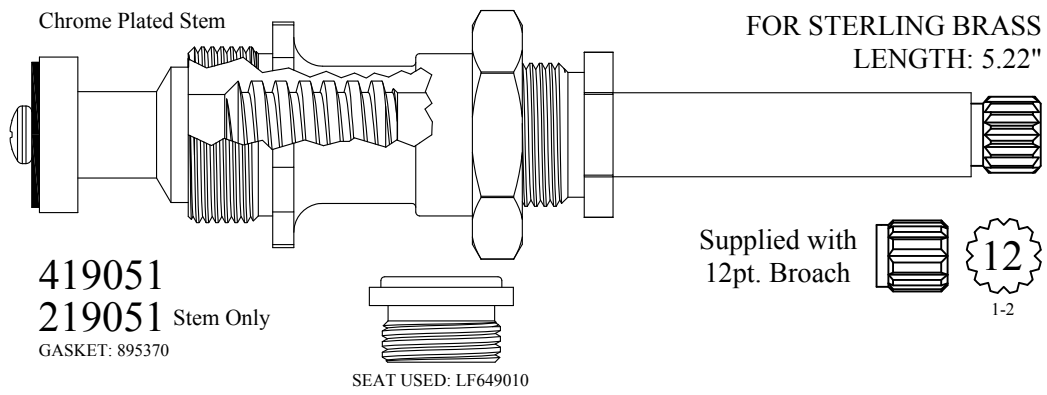

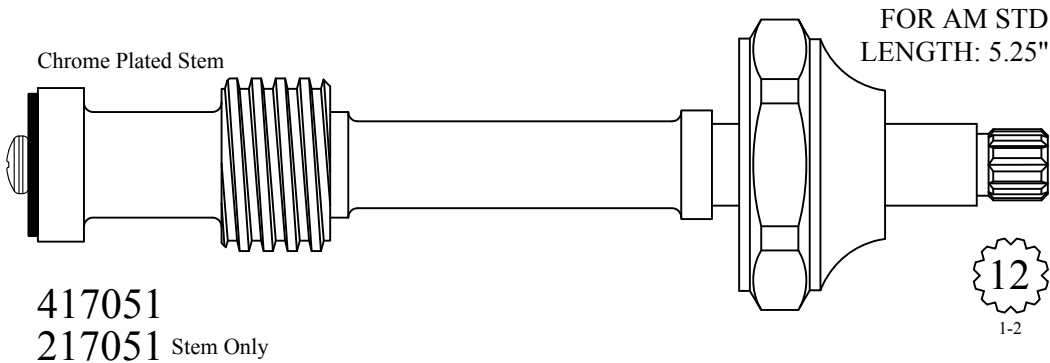
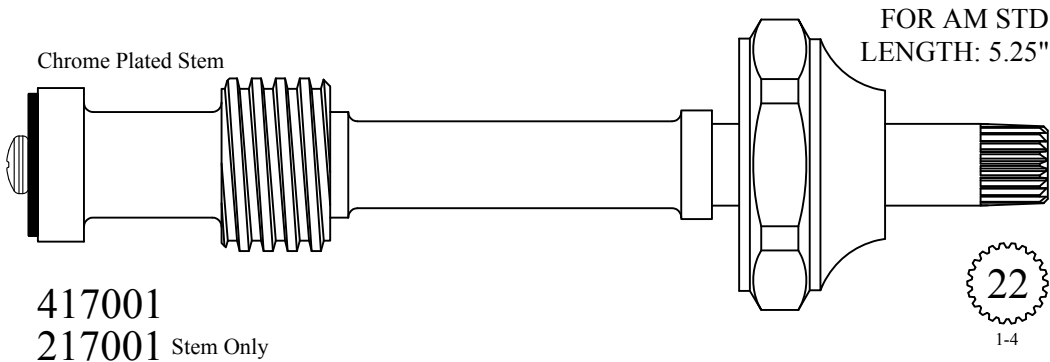
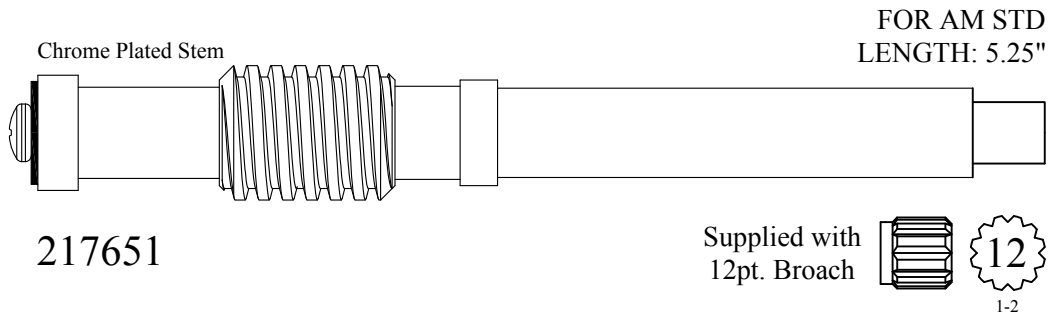
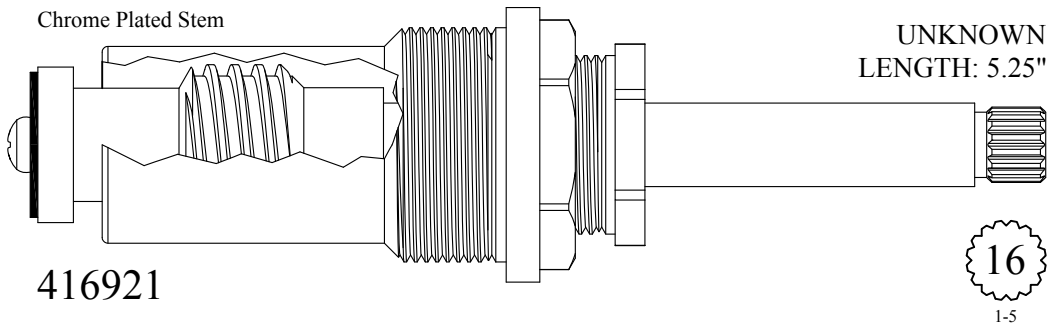
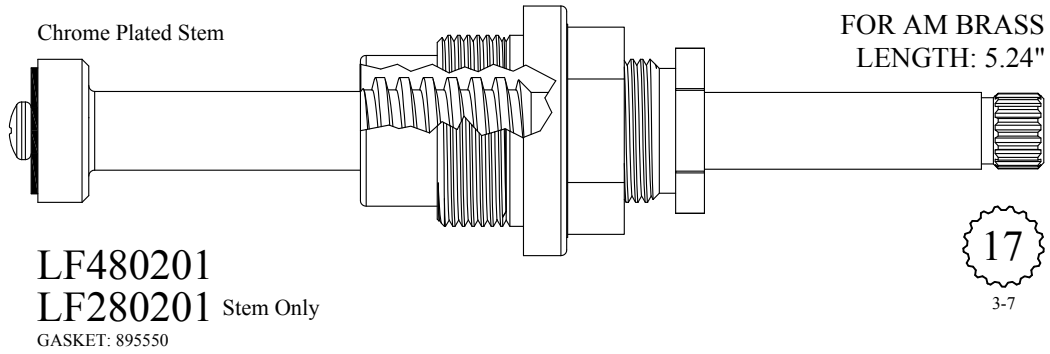

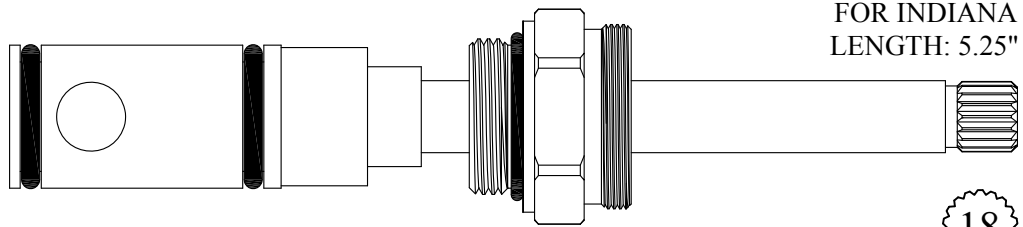

FOR INDIANA
LENGTH: 5.25"

432730
232730 Stem Only
GASKET: 890180 O-RING INCLUDED

18
3-3

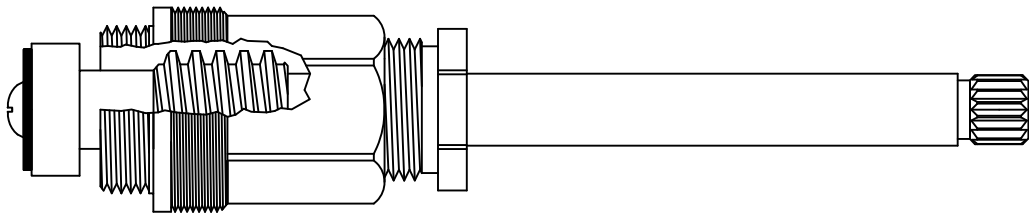

Old Style, Use 413301 or 413301-CP

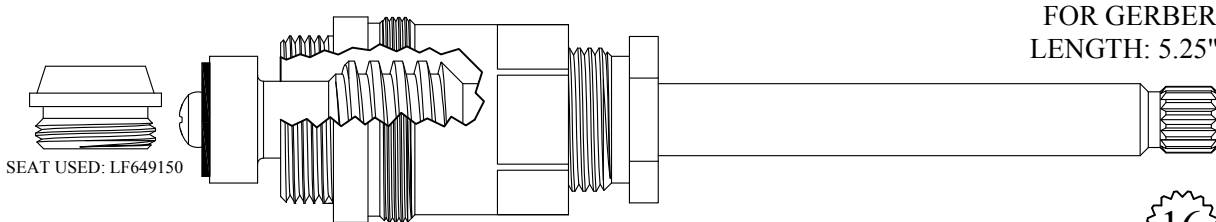

FOR GERBER
LENGTH: 5.25"

SEAT USED: LF649150

413301/ 413302
213301/ 213302 Stem Only
GASKET: 895400

Also available with chrome plated stem

413301-CP

16
2-3

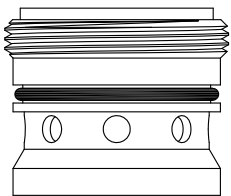

SEAT KIT USED: 106090

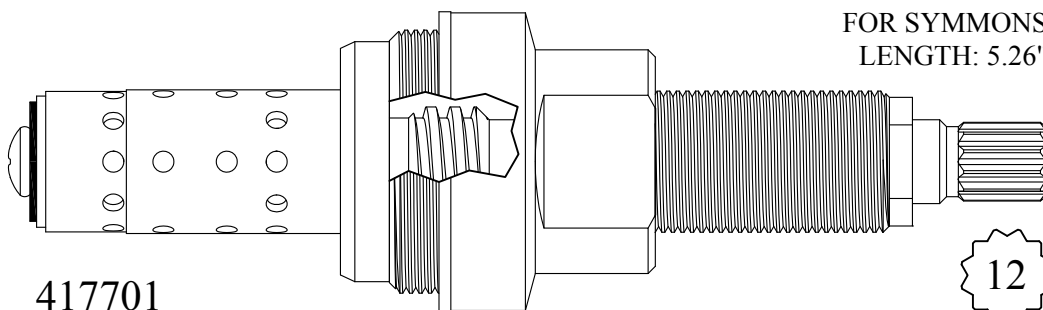

FOR SYMMONS
LENGTH: 5.26"

417701
217701 Stem Only
GASKET: 895500 INCLUDED

12
Symmons Large

Nickel Plated Stem

FOR CHICAGO
LENGTH: 5.26"

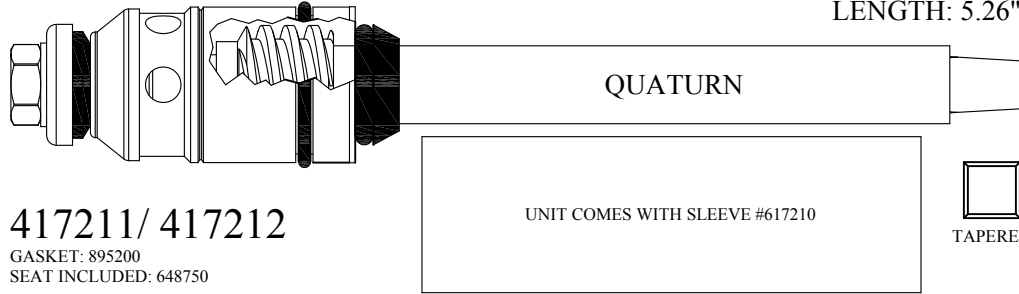

417211/ 417212

GASKET: 895200
SEAT INCLUDED: 648750

Chrome Plated Stem

FOR ENTERPRISE
LENGTH: 5.27"

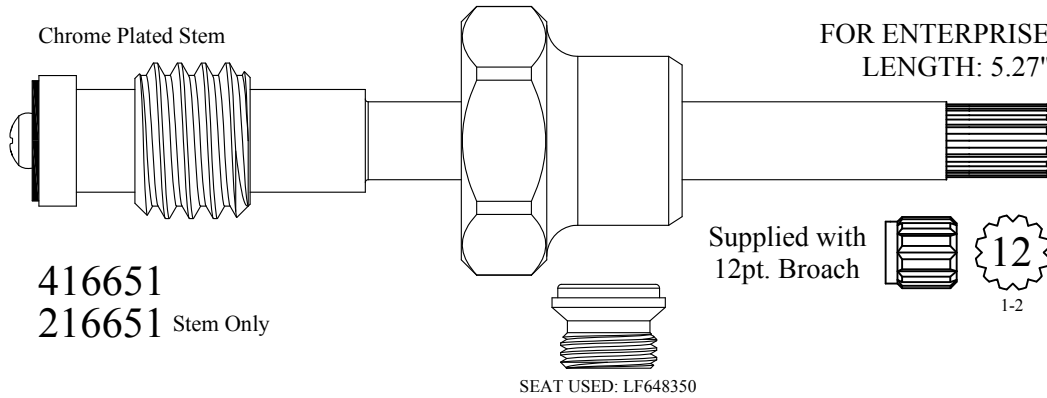

416651

216651 Stem Only

Chrome Plated Stem
18 TPI Gland

FOR UNION BRASS
LENGTH: 5.27"

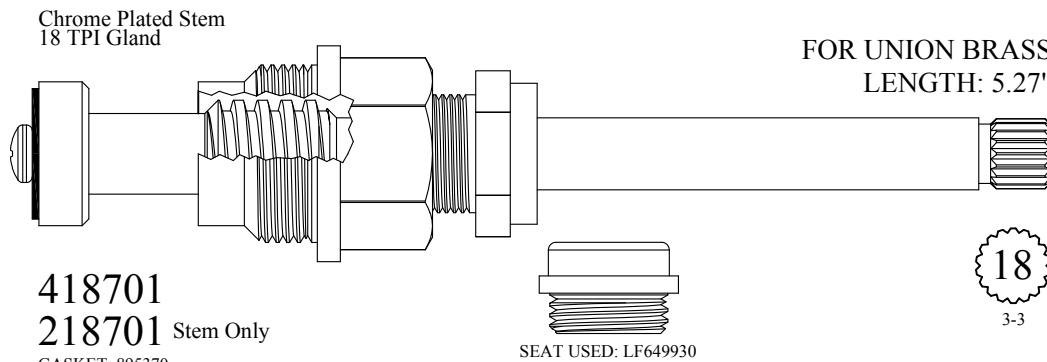

418701

218701 Stem Only

GASKET: 895370

Chrome Plated Stem
20 TPI Gland

FOR UNION BRASS
LENGTH: 5.27"

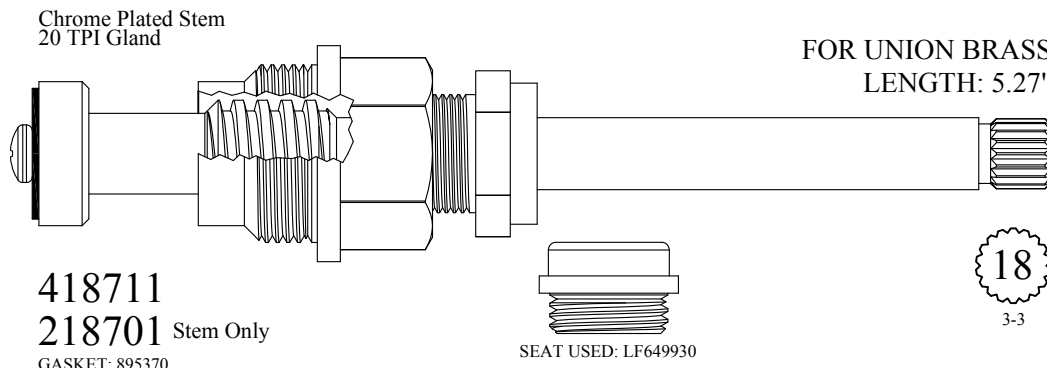

418711

218701 Stem Only

GASKET: 895370

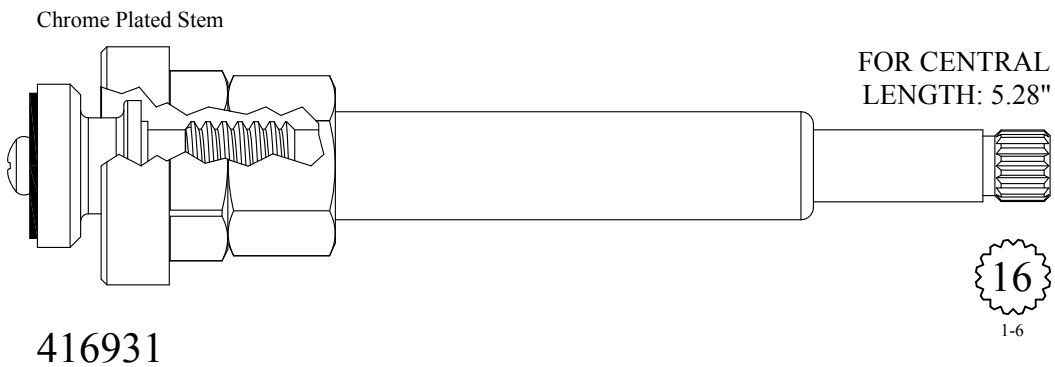
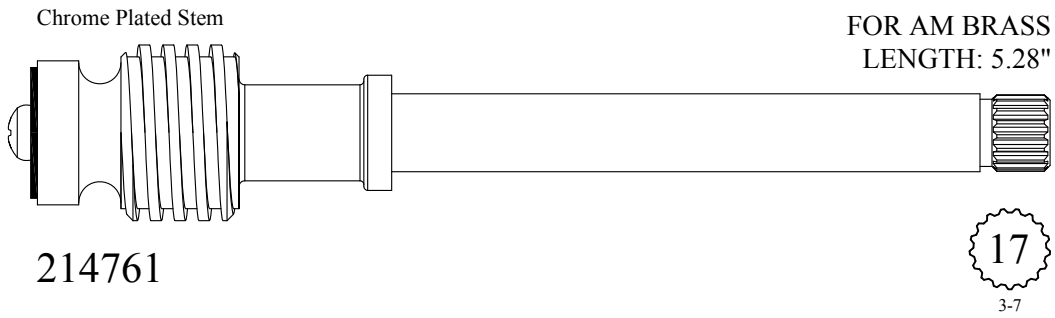
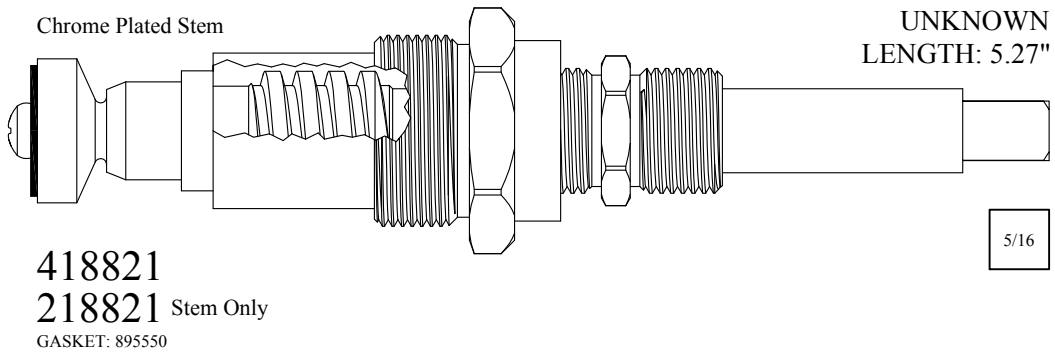
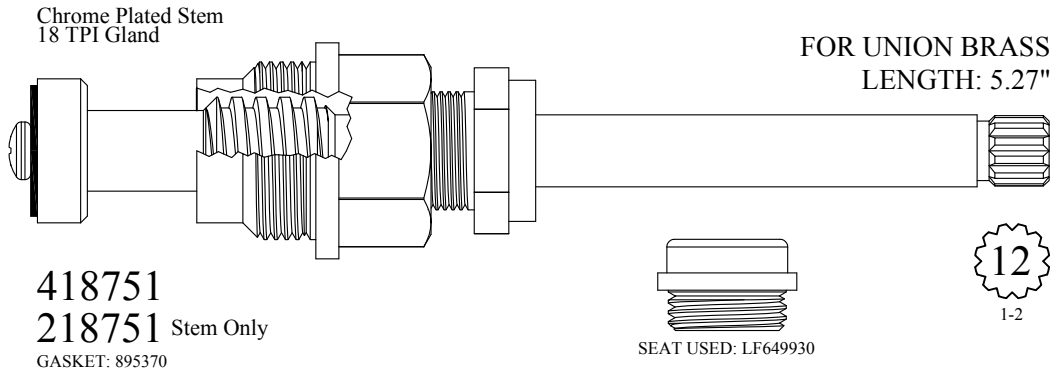

FOR SEARS
FOR FEDERAL HUBER
LENGTH: 5.28"

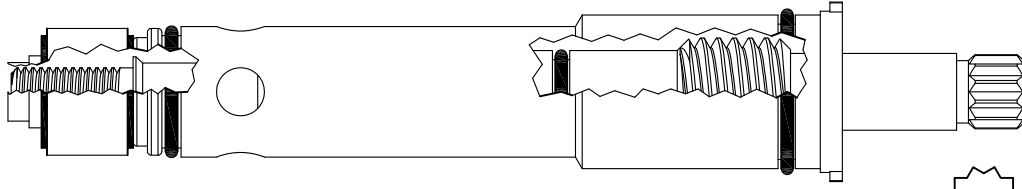

432901

12
3-10

FOR ELJER
LENGTH 5.28"

Plastic Plunger End

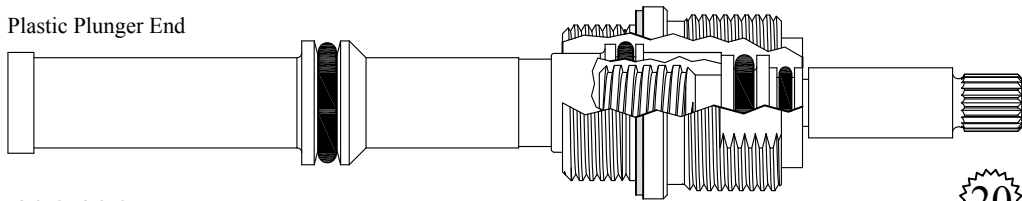

433432

GASKET: 895160 INCLUDED

20
3-20

Nickel Plated Stem

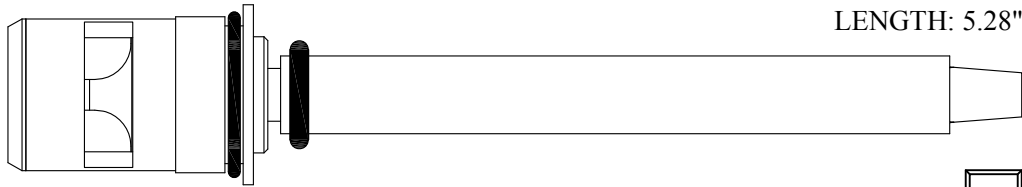

FOR CHICAGO
LENGTH: 5.28"

LF475411/ LF475412

GASKET: 890170 O-RING INCLUDED
SEAL: 898590
DISC SET: 151380-PKG

TAPERED

Chrome Plated Stem

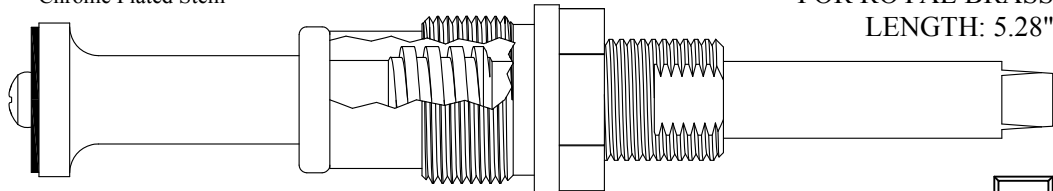

FOR ROYAL BRASS
LENGTH: 5.28"

LF479901
LF279901 Stem Only

5/16
TAPERED

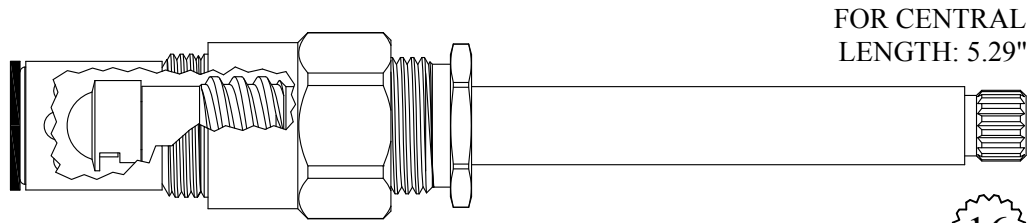

FOR CENTRAL
LENGTH: 5.29"

411021
GASKET: 895100

16
1-6

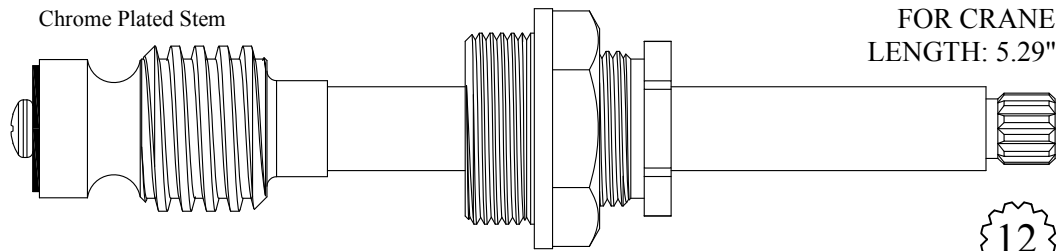

Chrome Plated Stem

FOR CRANE
LENGTH: 5.29"

417201
217201 Stem Only
GASKET: 895560

12
1-2

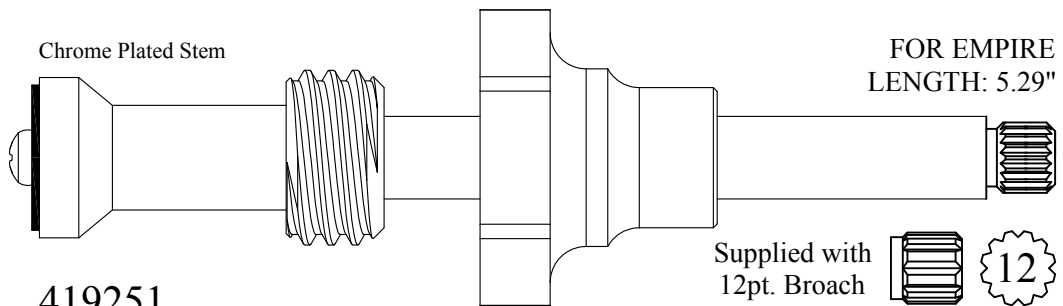

Chrome Plated Stem

FOR EMPIRE
LENGTH: 5.29"

419251
219251 Stem Only

Supplied with
12pt. Broach

12
1-2

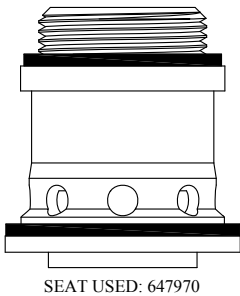

SEAT USED: 647970

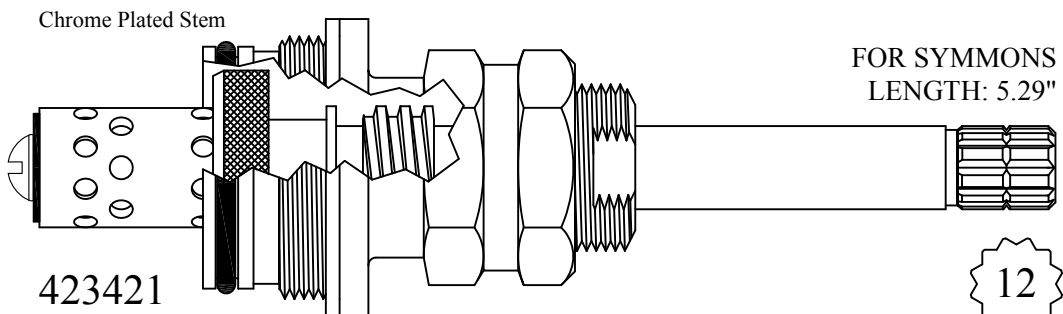

Chrome Plated Stem

FOR SYMMONS
LENGTH: 5.29"

423421
223421 Stem Only
GASKET: 895500 INCLUDED

12
Symmons Large

FOR KOHLER
LENGTH: 5.34"

Chrome Escutcheon Tube

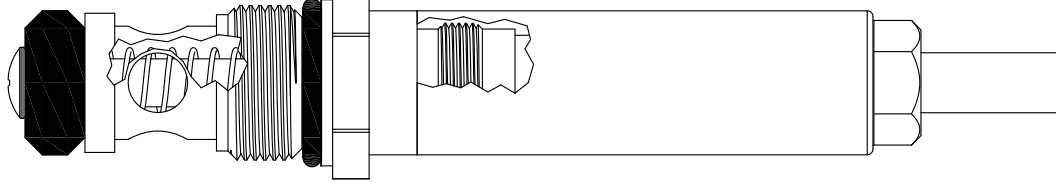

432910

GASKET: 891150 O-RING INCLUDED

FOR AM STD
LENGTH: 5.30"

Chrome Plated Stem

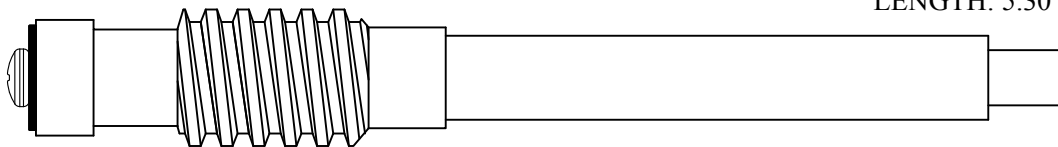

225151

Supplied with
12pt. Broach



12

1-2

FOR MILWAUKEE
LENGTH: 5.30"

Chrome Plated Stem

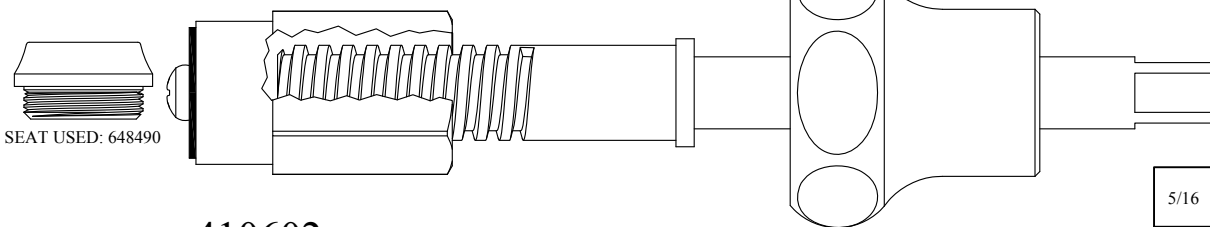

SEAT USED: 648490

5/16

410602

210602 Stem Only

GASKET: 894960 INCLUDED

FOR MILWAUKEE
LENGTH: 5.30"

Chrome Plated Stem

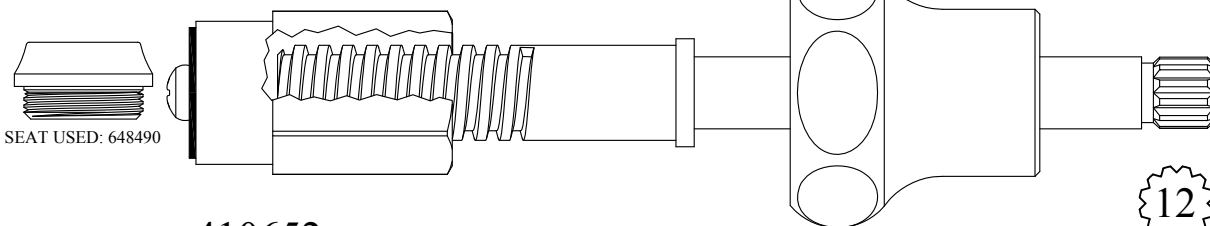

SEAT USED: 648490

12

1-2

410652

210652 Stem Only

GASKET: 894960 INCLUDED

FOR NFC / AMERICAN FAUCETS
 LENGTH: 5.30"

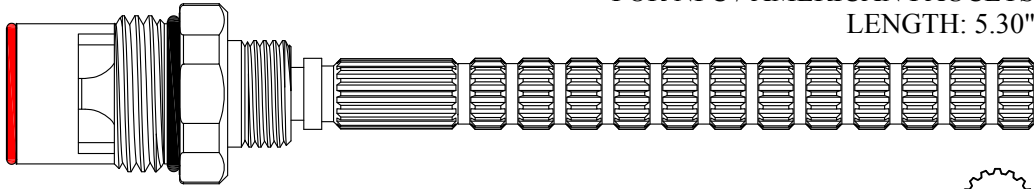

417221/ 417222
 GASKET: 890170 O-RING INCLUDED
 SEAL: 898580-R/B
 DISC SET: 151380-PKG

16
 3-16

Chrome Plated Stem

UNKNOWN
 LENGTH: 5.31"

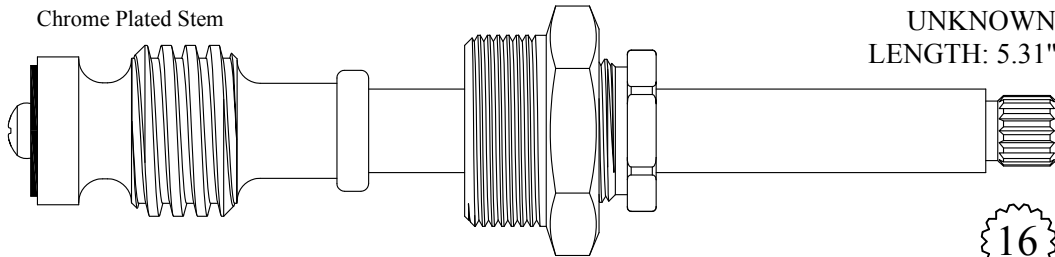

418121
218121 Stem Only
 GASKET: 895550

16
 1-6

Chrome Plated Stem

UNKNOWN
 LENGTH: 5.31"

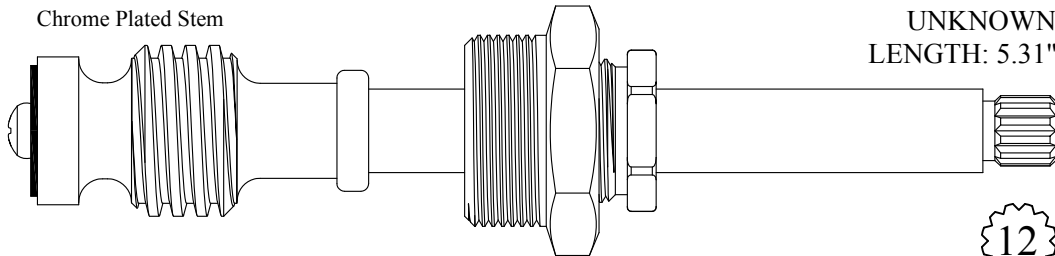

418171
218171 Stem Only
 GASKET: 895340

12
 1-2

Chrome Plated Stem

FOR SYMONS
 LENGTH: 5.31"

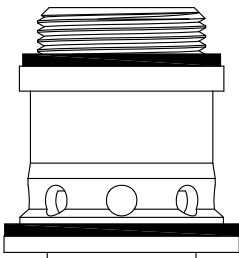

SEAT USED: 647970

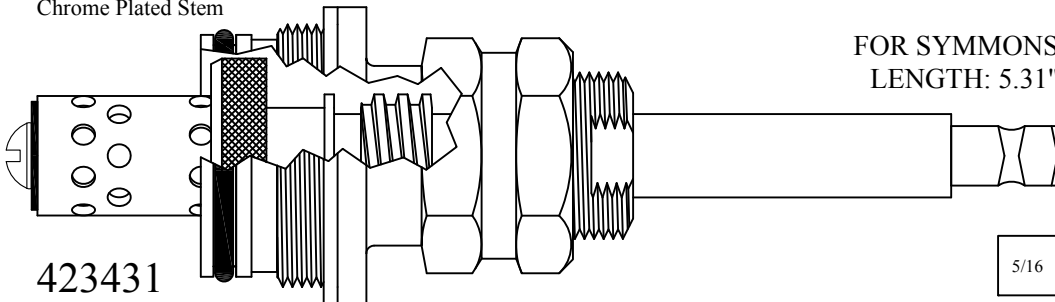

423431
223431 Stem Only
 GASKET: 895500 INCLUDED

5/16

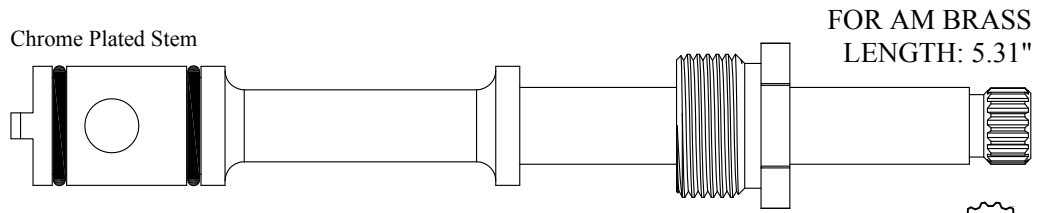

432800
232800 Stem Only

17
3-7

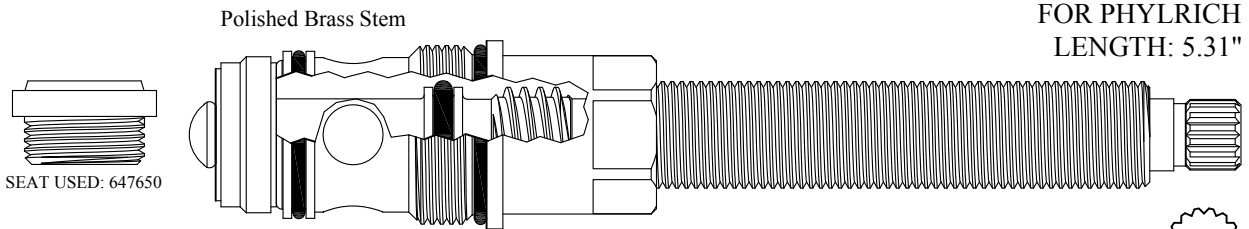

433361
GASKET: 890190 O-RING INCLUDED

Also available with chrome plated stem
433361-CP

16
1-6

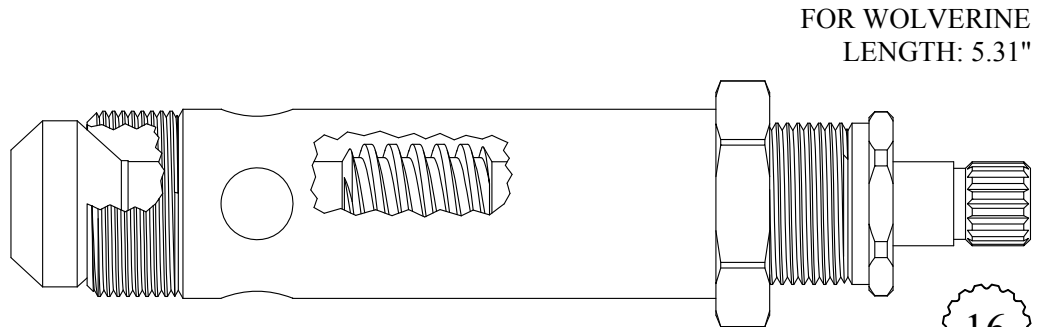

433381
233381 Stem Only
GASKET: 895550

16
3-26

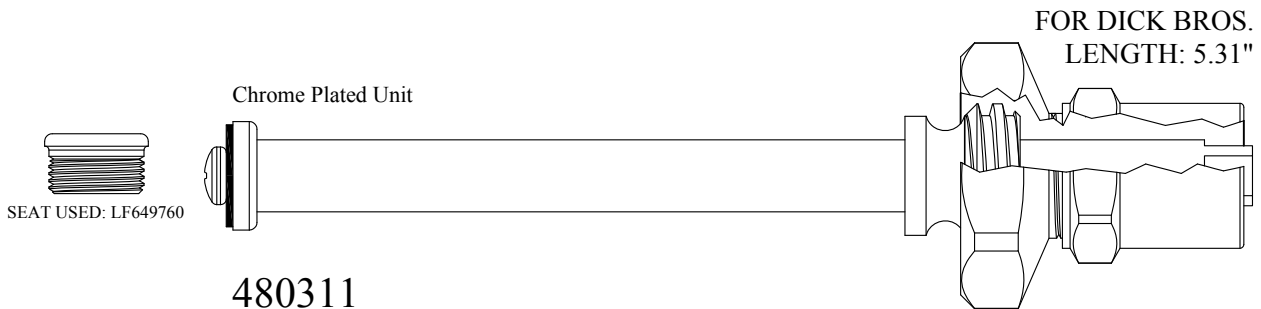

480311
280311 Stem Only
GASKET: 895400 INCLUDED

5/16

Chrome Plated Stem

FOR AM STD
STEM LENGTH: 5.31"

USES BARREL:
LF647021/LF647022

418001/ 418002
218001/ 218002 Stem Only
GASKET: 818000

Also available less barrel
199651/ 199652

22
1-4

Chrome Plated Stem

FOR AM STD
STEM LENGTH: 5.31"

USES BARREL:
LF647021/LF647022

418011/ 418012
218001/ 218002 Stem Only
GASKET: 818000

22
1-4

Chrome Plated Stem

FOR AM STD
STEM LENGTH: 5.31"

USES BARREL:
LF647021/LF647022

418021/ 418022
218021/ 218022 Stem Only
GASKET: 818010

3/8" Shank

20
3-14

Chrome Plated Stem

FOR AM STD
STEM LENGTH: 5.31"

USES BARREL:
LF647021/LF647022

418031/ 418032
218001/ 218002 Stem Only
GASKET: 818010

22
1-4

USES BARREL:
LF647021/LF647022

Chrome Plated Stem

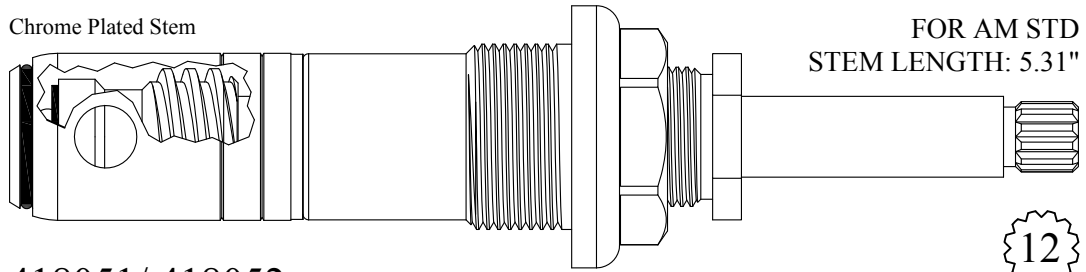

FOR AM STD
STEM LENGTH: 5.31"

418051/ 418052
218051/ 218052 Stem Only
GASKET: 818000

12
1-2

USES BARREL:
LF647021/LF647022

Chrome Plated Stem

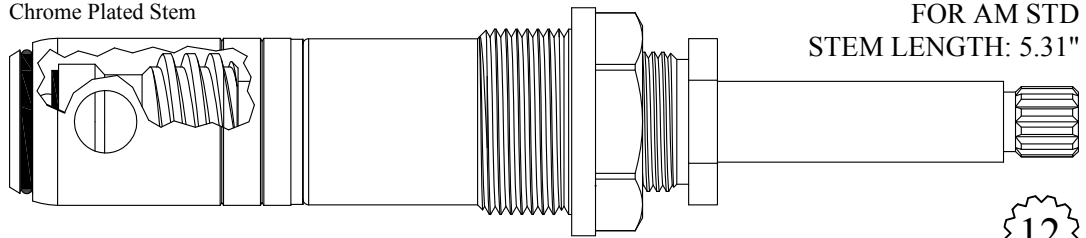

FOR AM STD
STEM LENGTH: 5.31"

418061/ 418062
218051/ 218052 Stem Only
GASKET: 818000

12
1-2

Chrome Plated Stem

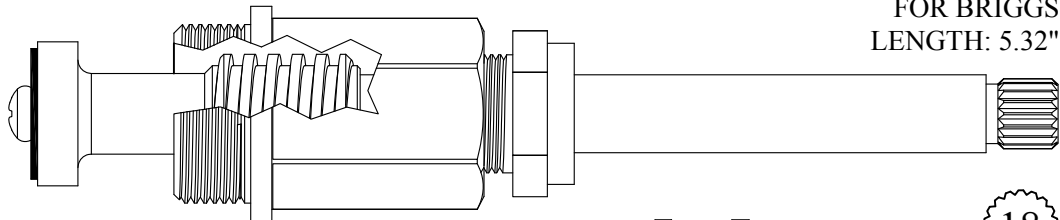

FOR BRIGGS
LENGTH: 5.32"

417901
217901 Stem Only
GASKET: 895370

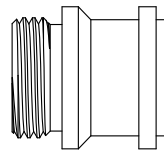

SEAT USED: 648630

18
3-3

Chrome Plated Unit
20 TPI Gland

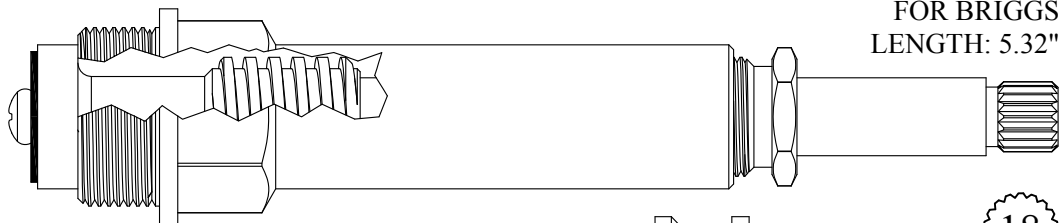

FOR BRIGGS
LENGTH: 5.32"

417911
217901 Stem Only
GASKET: 895370

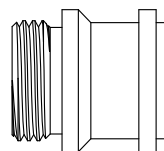

SEAT USED: 648630

18
3-3

Chrome Plated Stem

FOR BRIGGS
LENGTH: 5.32"

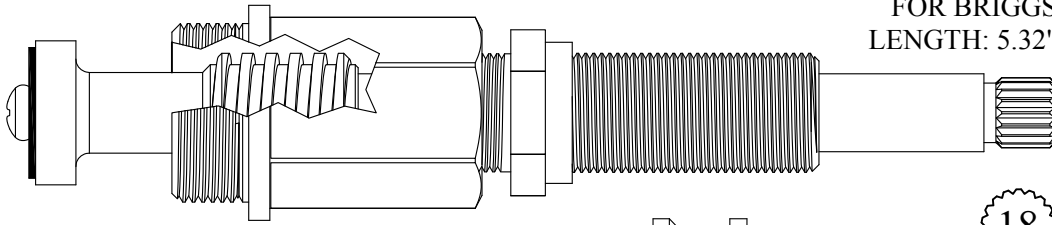

417921
417901 Stem Only
GASKET: 895370

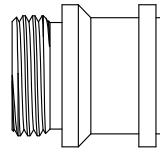

SEAT USED: 648630

18
3-3

Chrome Plated Unit
18 TPI Gland

FOR BRIGGS
LENGTH: 5.32"

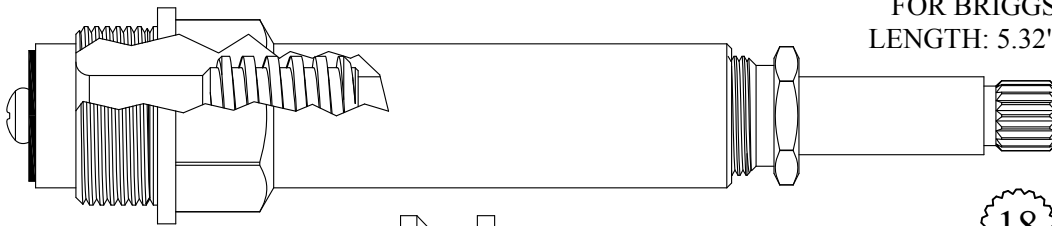

417931
217901 Stem Only
GASKET: 895370

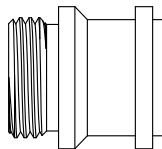

SEAT USED: 648630

18
3-3

Chrome Plated Stem

FOR STERLING FAUCET
LENGTH: 5.32"



SEAT USED: LF648170

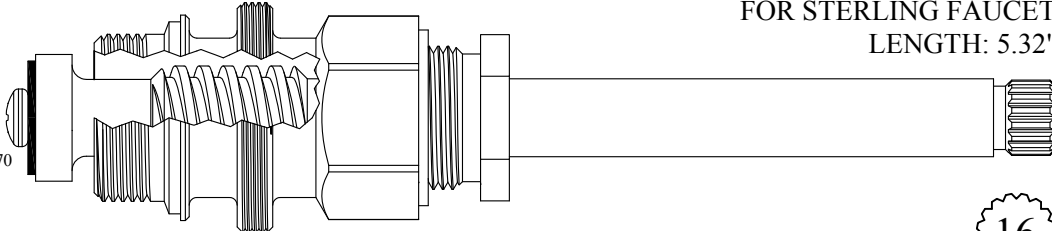

418201
218201 Stem Only
GASKET: 895400

16
1-5

Chrome Plated Stem

FOR STERLING FAUCET
LENGTH: 5.32"



SEAT USED: LF648170

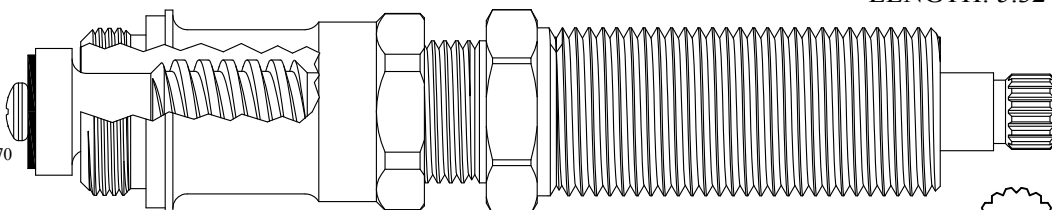

418231
218201 Stem Only
GASKET: 895400

16
1-5

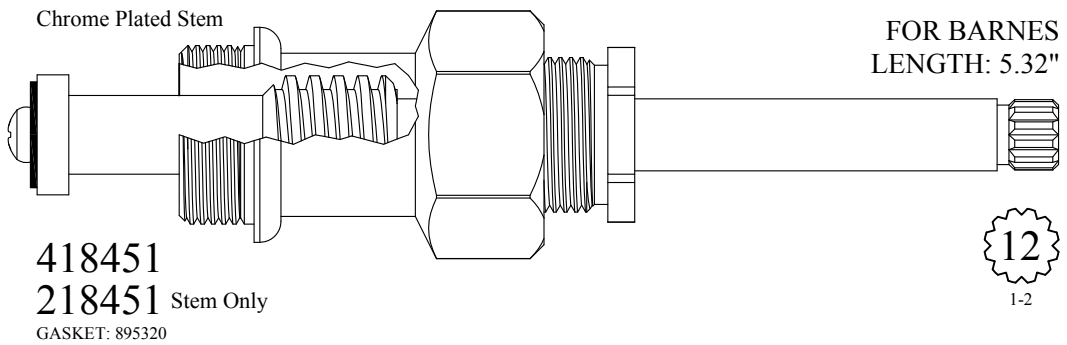
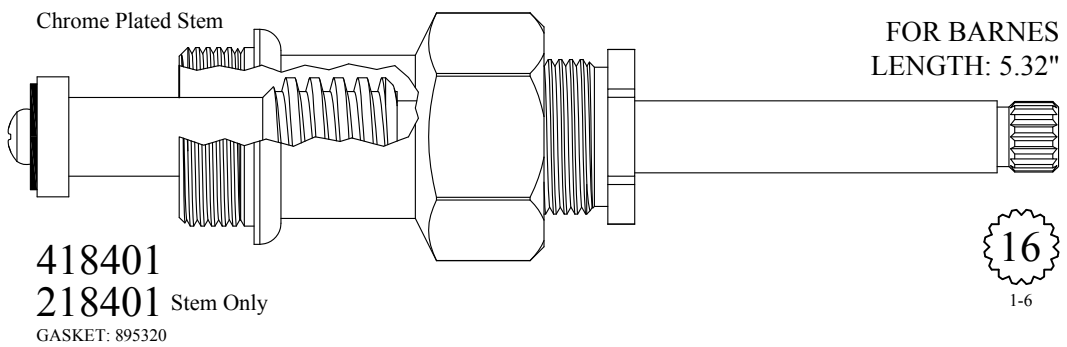
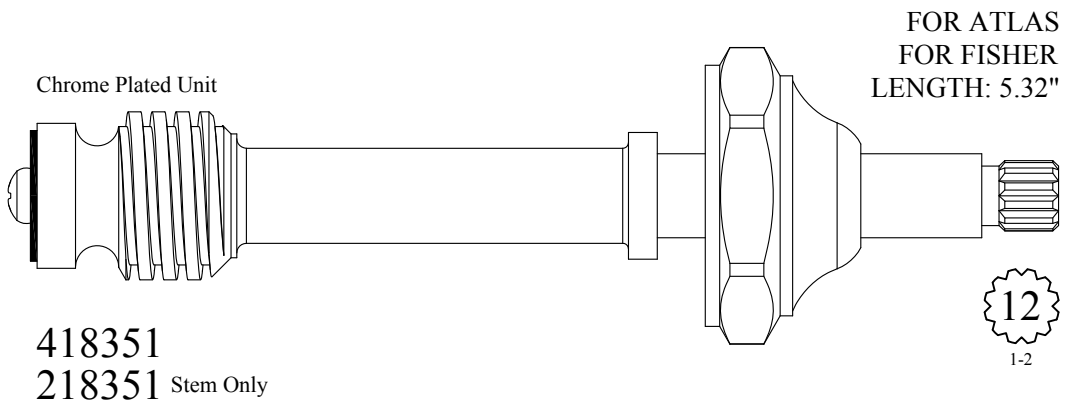
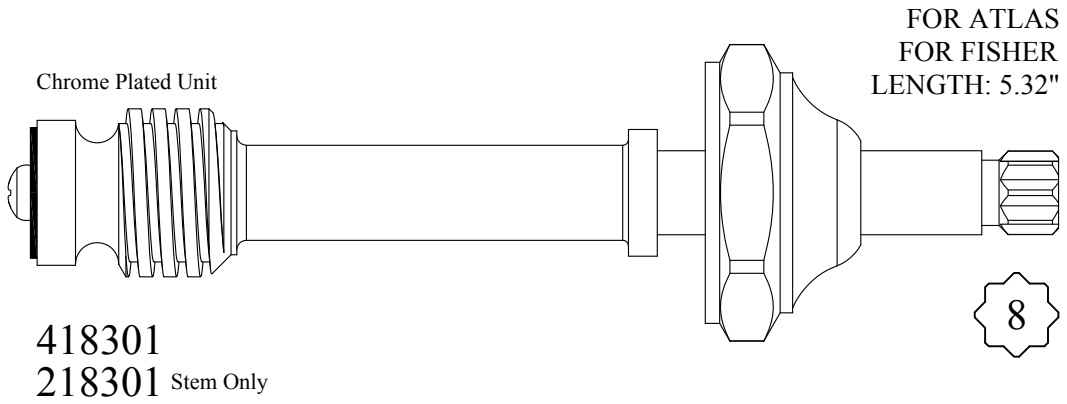

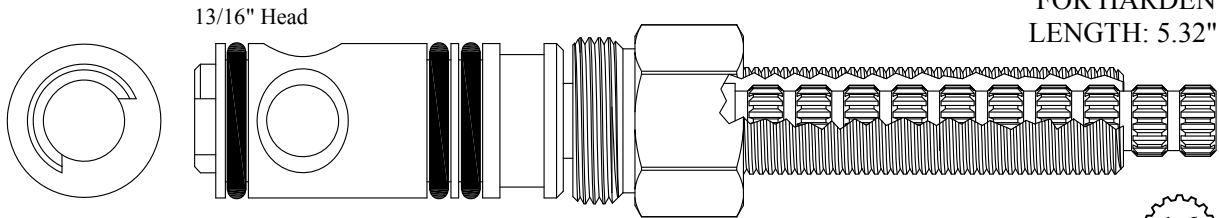

432920
232920 Stem Only

16
3-16

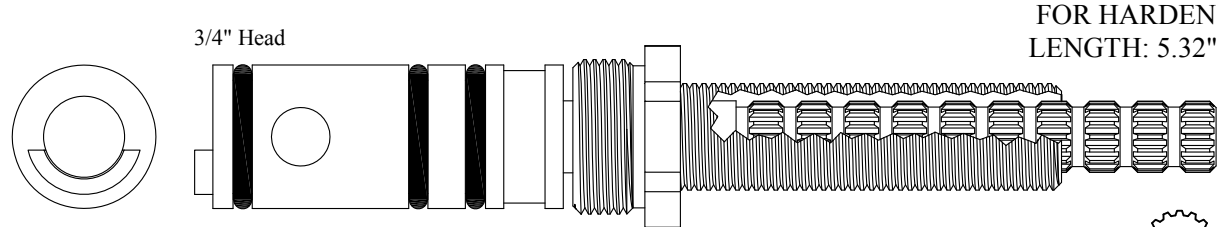

432930
232930 Stem Only

16
3-16

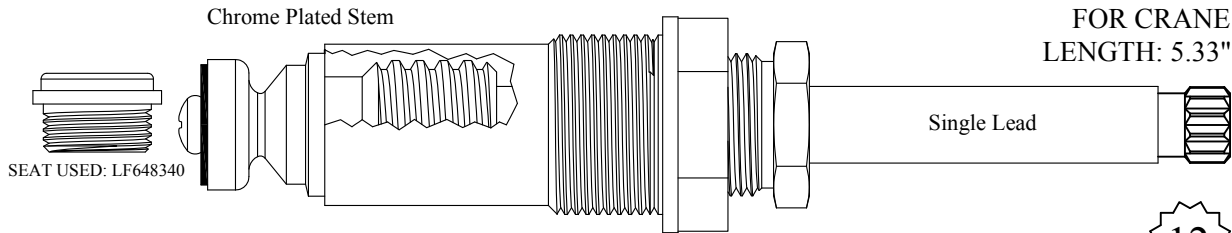

418501
218501 Stem Only
GASKET: 895370

12
3-10

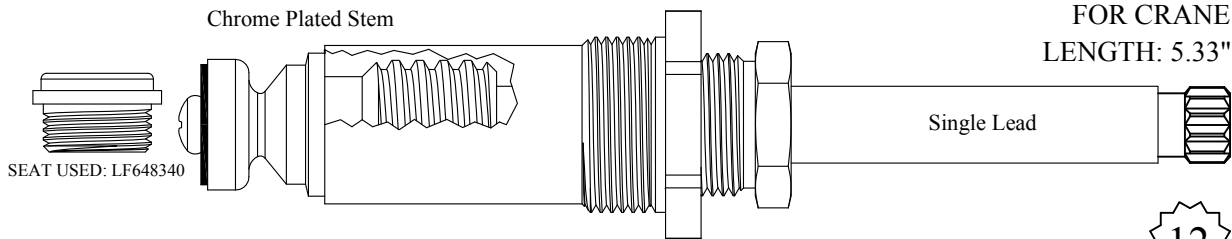

418541
218501 Stem Only
GASKET: 895370

12
3-10

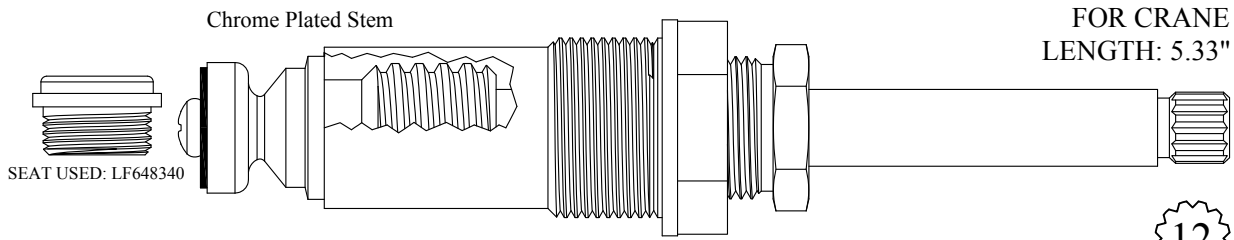

Chrome Plated Stem

FOR CRANE
LENGTH: 5.33"

SEAT USED: LF648340

418551
218551 Stem Only
GASKET: 895370

12
1-2

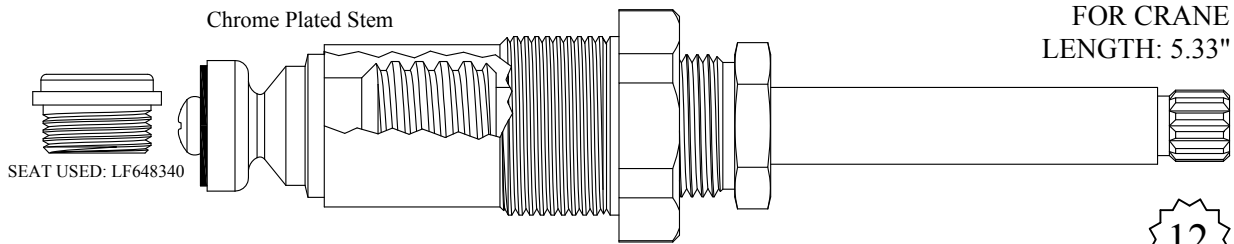

Chrome Plated Stem

FOR CRANE
LENGTH: 5.33"

SEAT USED: LF648340

418621
218501 Stem Only
GASKET: 895370

12
3-10

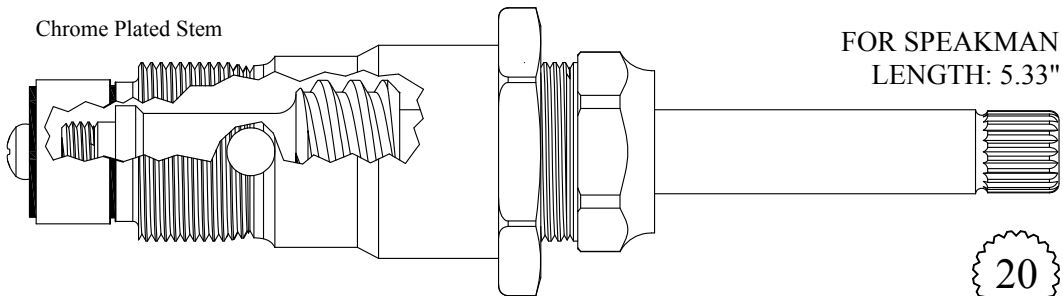

Chrome Plated Stem

FOR SPEAKMAN
LENGTH: 5.33"

433001
233001 Stem Only
GASKET: 895450

20
2-4

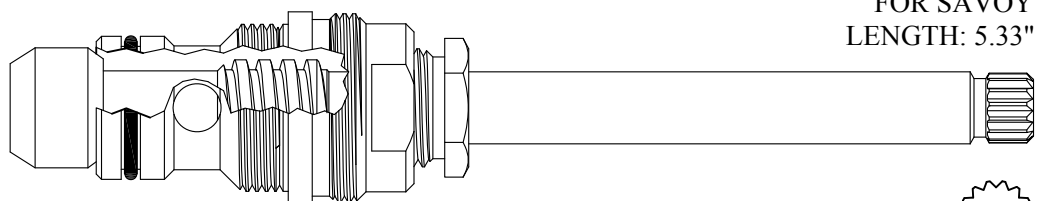

FOR SAVOY
LENGTH: 5.33"

433391
233391 Stem Only
GASKET: 895400

15
1-13

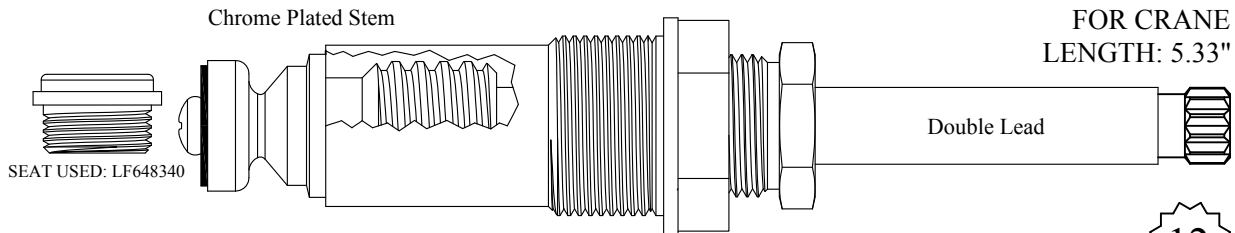

FOR CRANE
LENGTH: 5.33"

Double Lead

12
3-10

418531/ 418532
218531/ 218532 Stem Only
GASKET: 895370

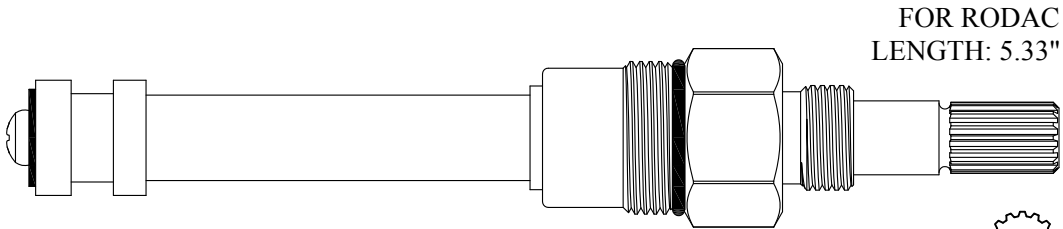

FOR RODAC
LENGTH: 5.33"

16
3-16

LF479801/ LF479802
GASKET: 890170 O-RING INCLUDED

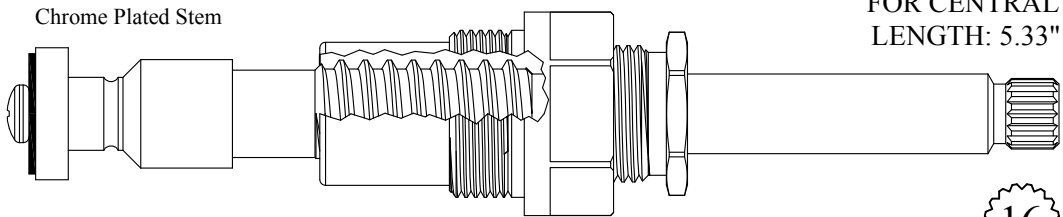

FOR CENTRAL
LENGTH: 5.33"

16
1-6

LF480171
LF280171 Stem Only
GASKET: 895400

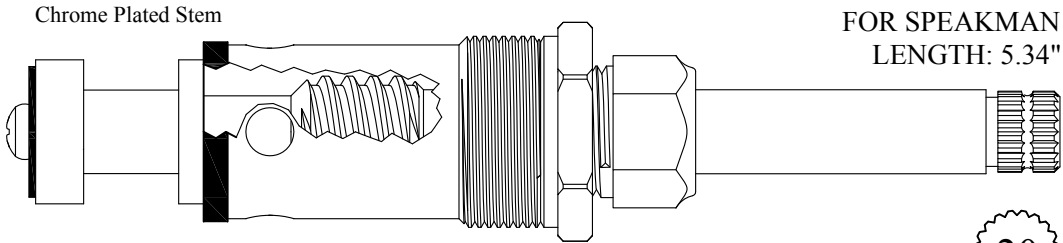

FOR SPEAKMAN
LENGTH: 5.34"

20
2-4

433201
233201 Stem Only

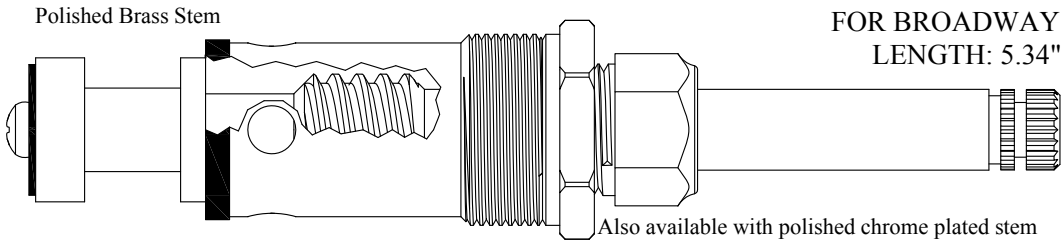

FOR BROADWAY
LENGTH: 5.34"

20
2-4

433221
233221 Stem Only

Also available with polished chrome plated stem
433221-CP
233221-CP Stem Only

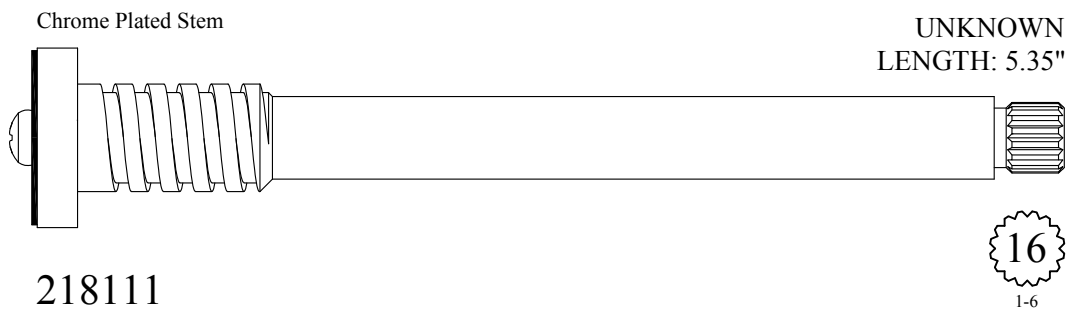
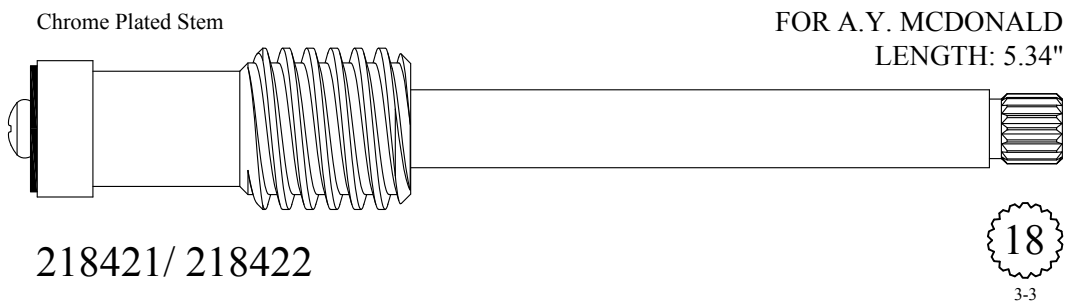
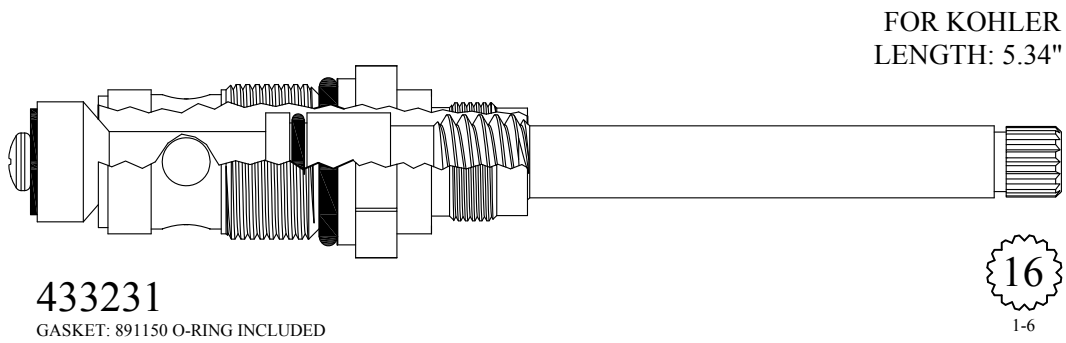
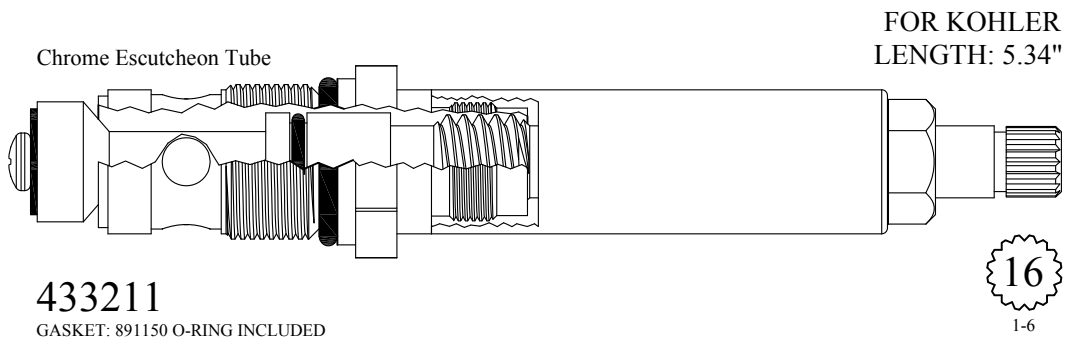

Chrome Plated Stem

FOR AM STD
LENGTH: 5.35"

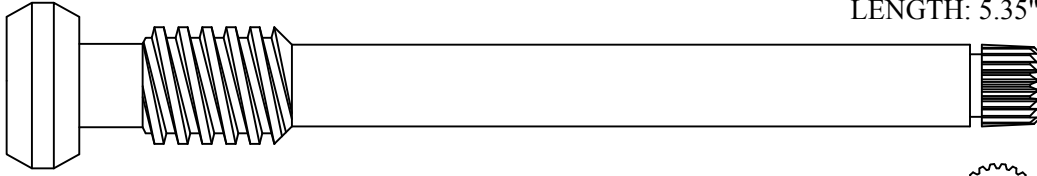

233531

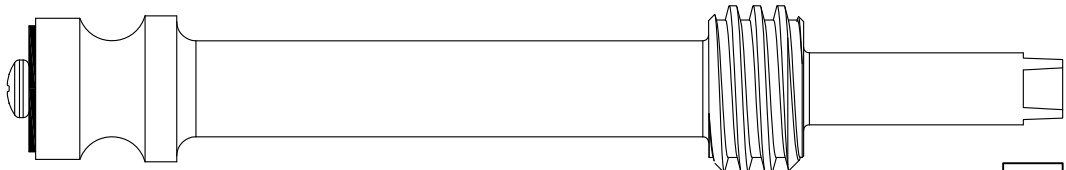

Not Available, Use 418521



Chrome Plated Unit

FOR DICK BROS.
LENGTH: 5.35"



SEAT USED: 648980

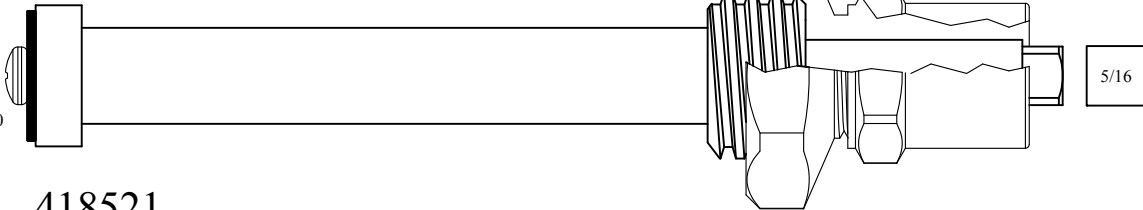

5/16

418521

218521 Stem Only

GASKET: 895400 INCLUDED

Chrome Plated Stem

FOR GLAUBER WEST COAST
LENGTH: 5.35"

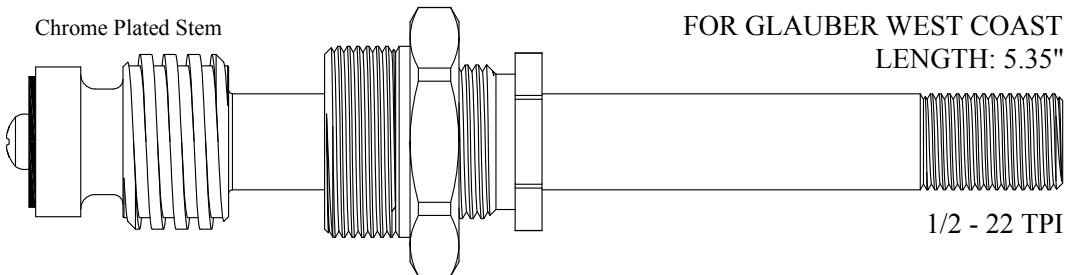

1/2 - 22 TPI

418601

218601 Stem Only

GASKET: 895570

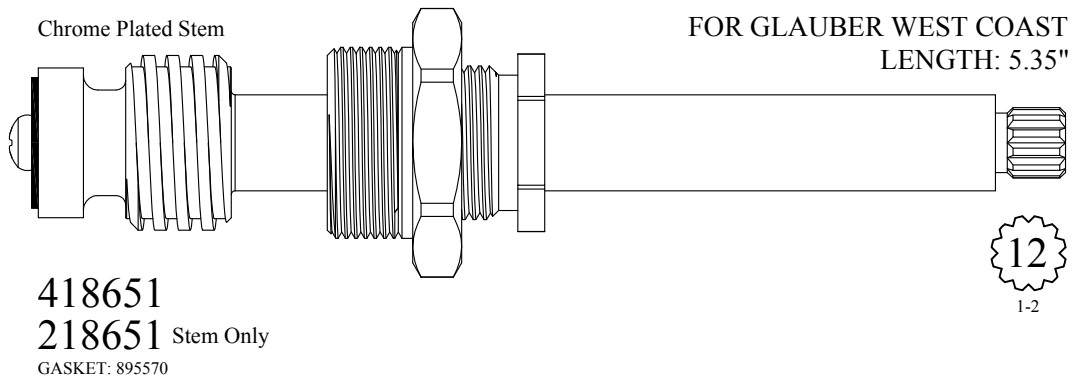

418651
 218651 Stem Only
 GASKET: 895570

12
 1-2

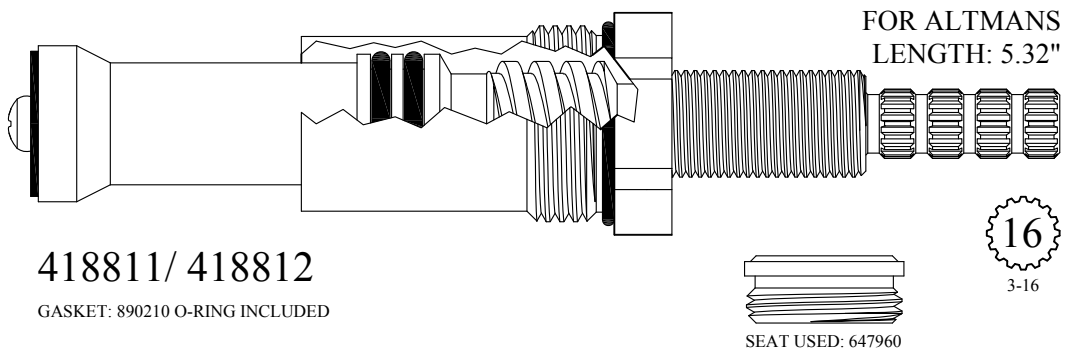

418811/ 418812
 GASKET: 890210 O-RING INCLUDED

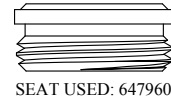

16
 3-16

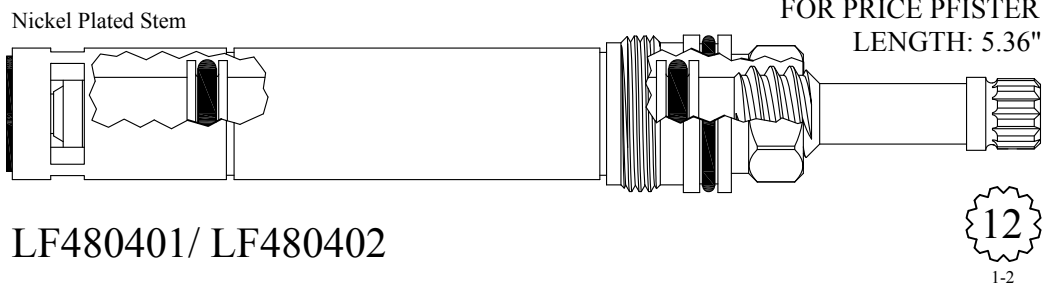

LF480401/ LF480402

12
 1-2

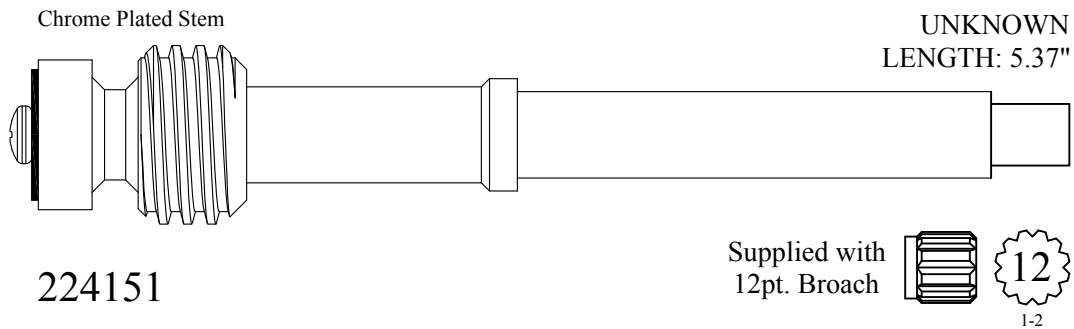

224151

Supplied with
 12pt. Broach



12
 1-2

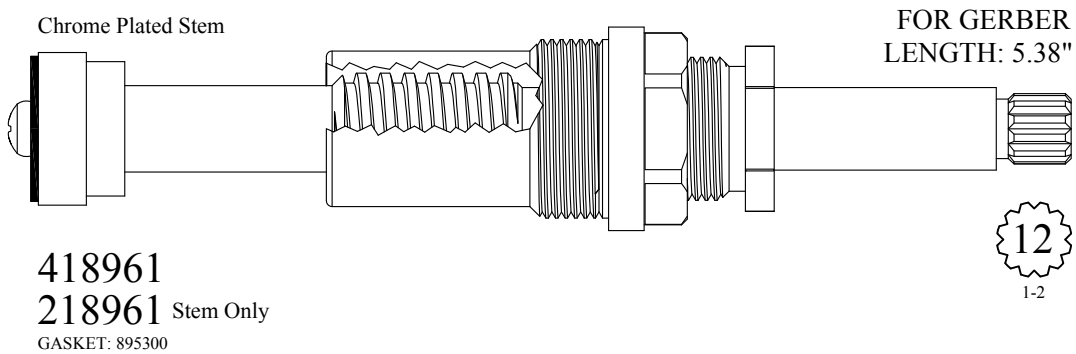
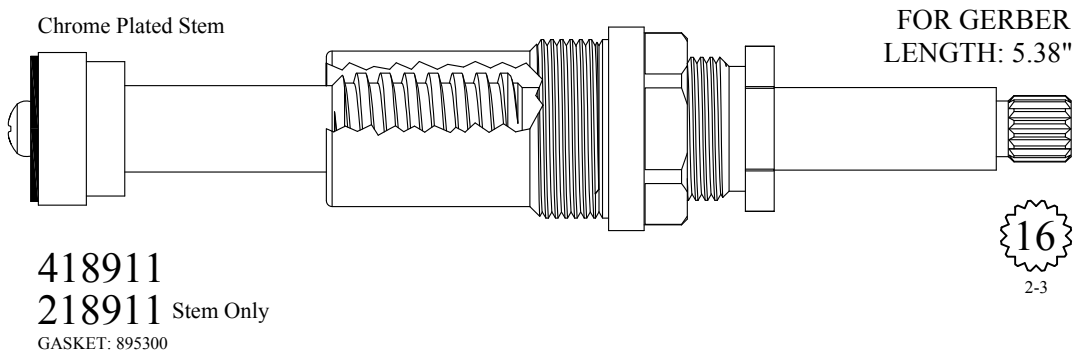
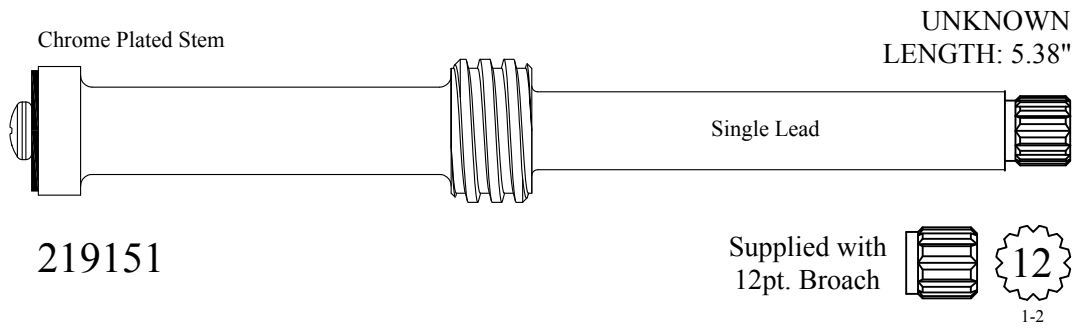
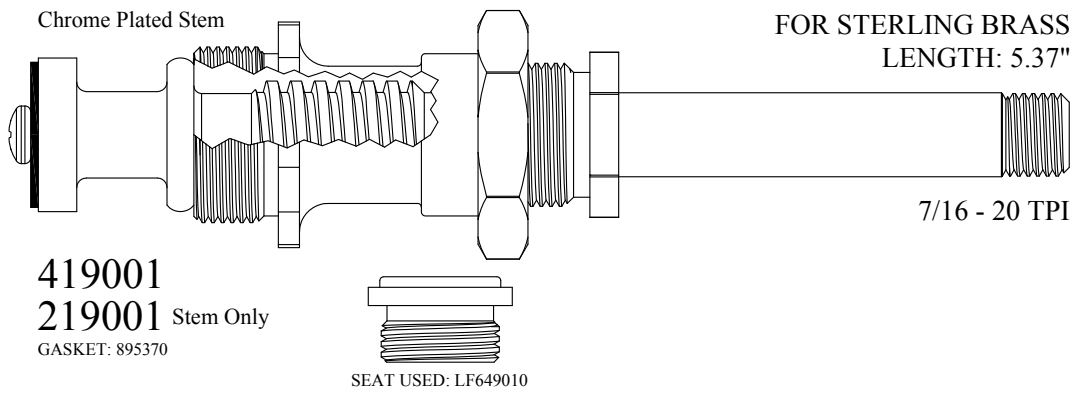

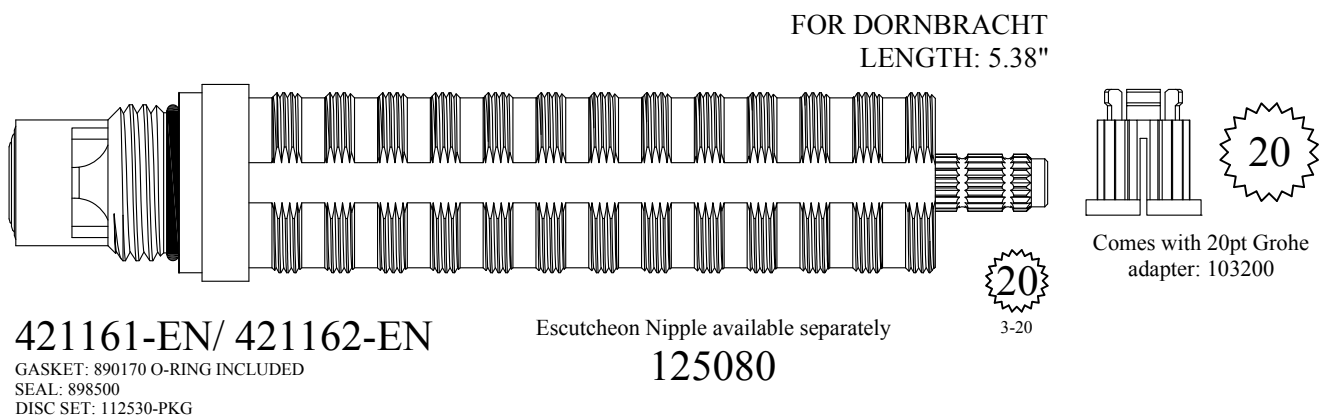
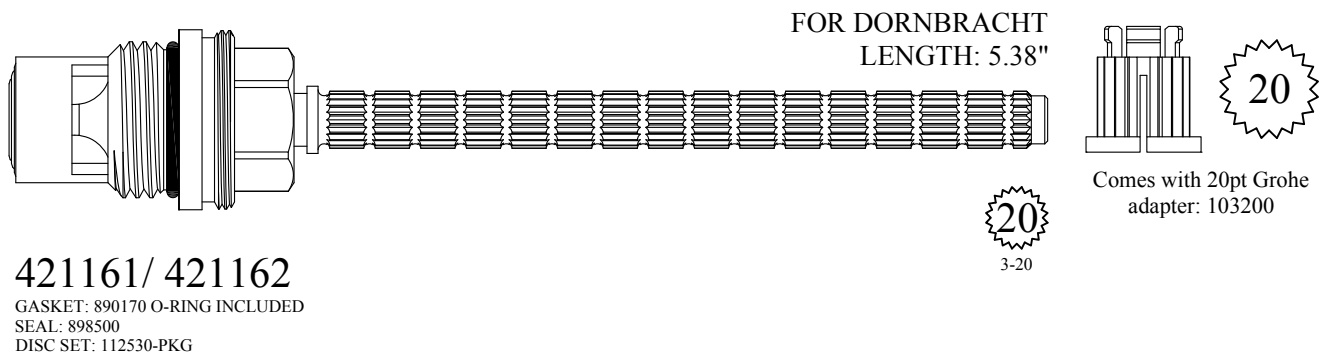
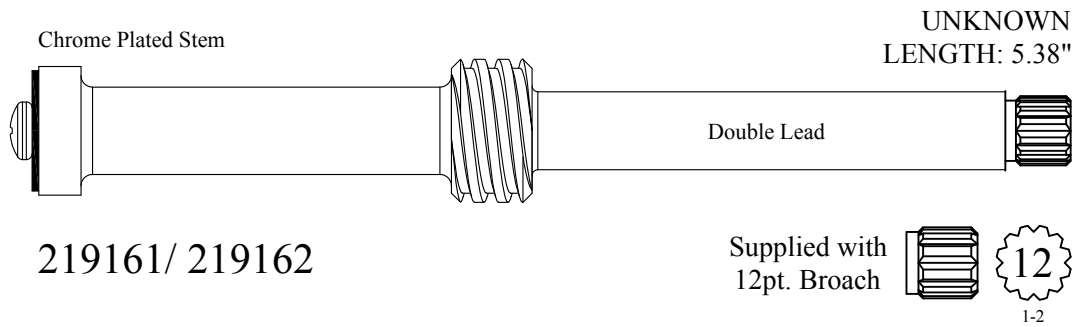
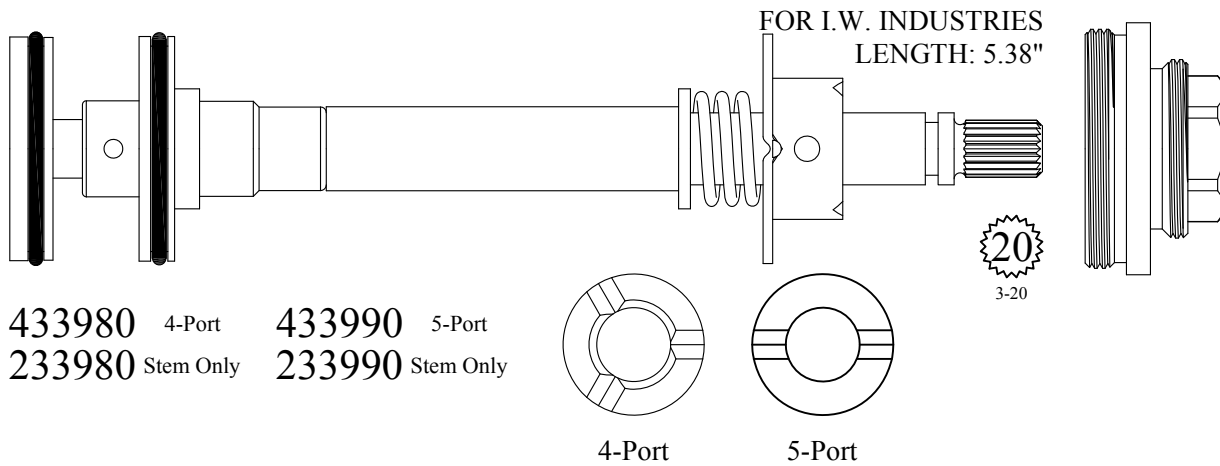

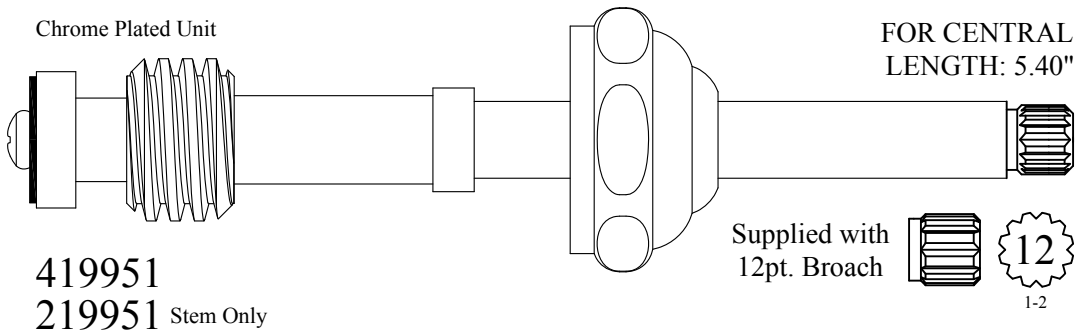
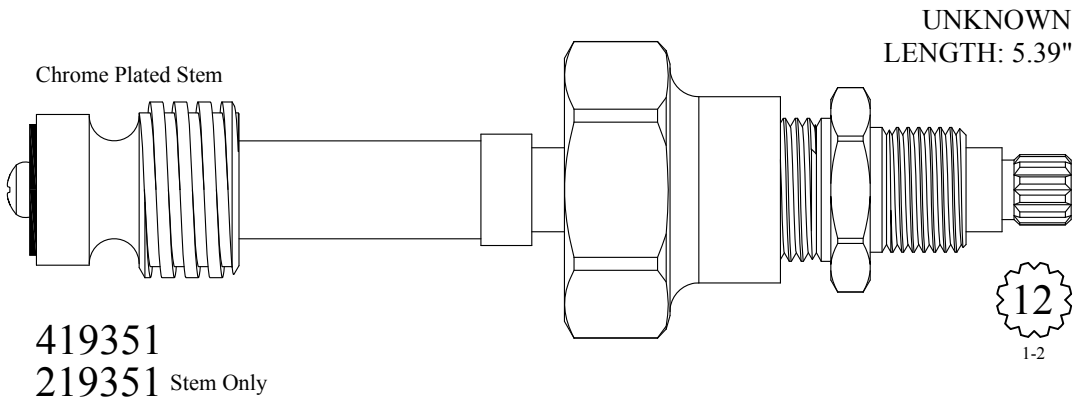
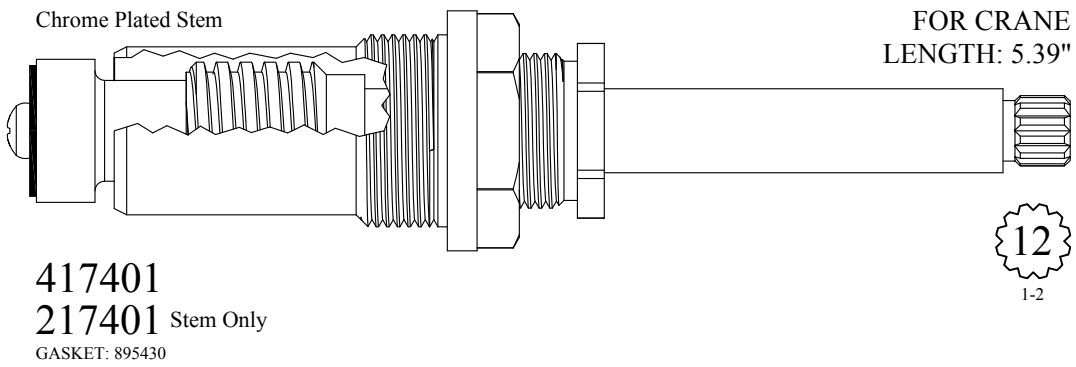
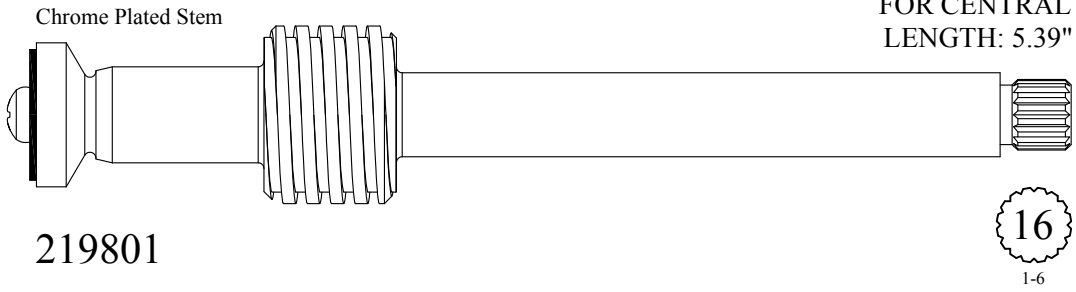

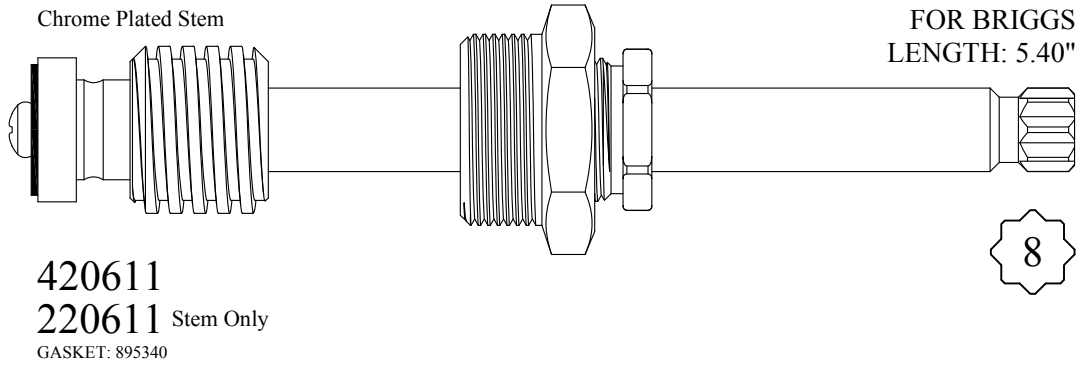

420611
220611 Stem Only
 GASKET: 895340

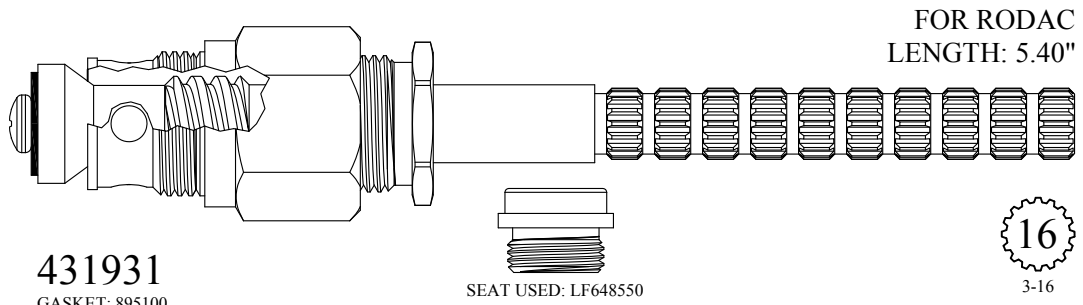

431931
 GASKET: 895100

SEAT USED: LF648550

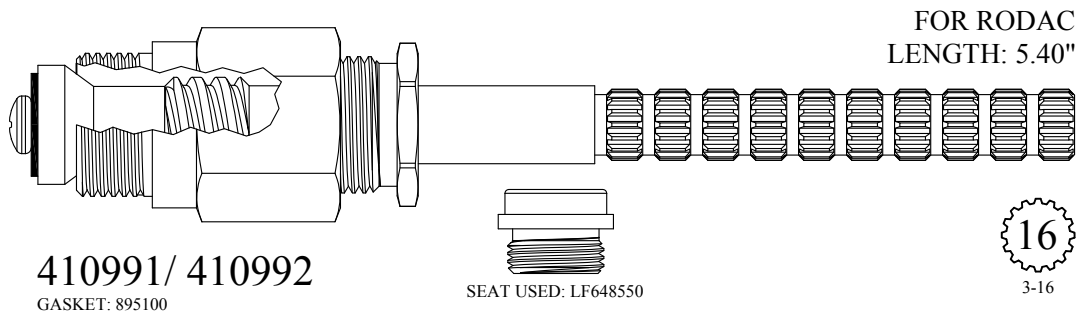

410991/ 410992
 GASKET: 895100

SEAT USED: LF648550

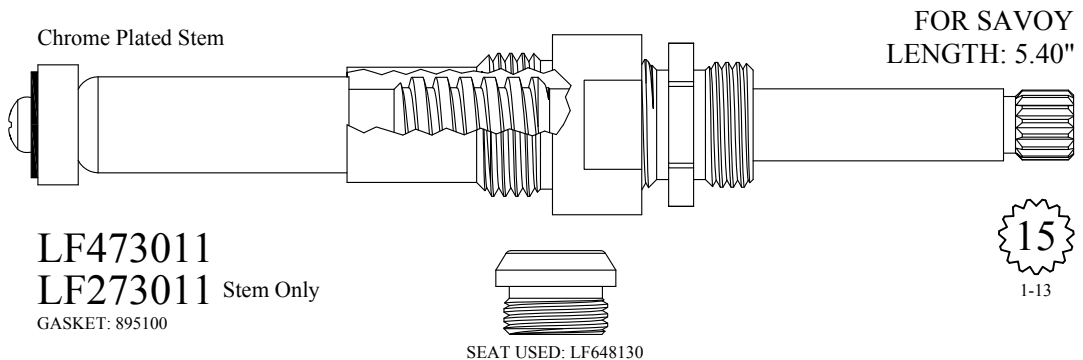

LF473011
LF273011 Stem Only
 GASKET: 895100

SEAT USED: LF648130



Chrome Plated Stem

FOR DICK BROS.
LENGTH: 5.41"

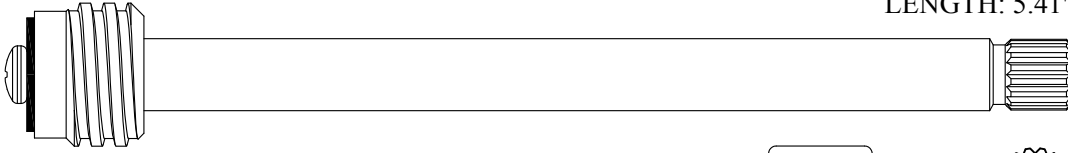

220411



SEAT USED: LF649760



Chrome Plated Stem

FOR ROYAL BRASS
LENGTH: 5.41"

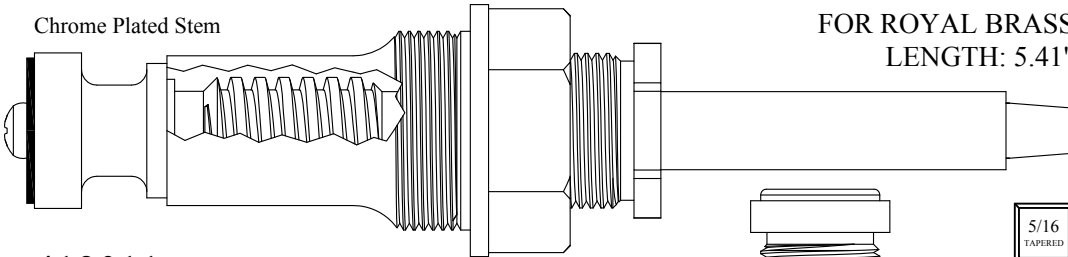

419011

219011 Stem Only

GASKET: 895560

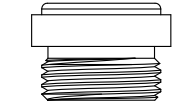

SEAT USED: 649850



Chrome Plated Stem

FOR ROYAL BRASS
LENGTH: 5.41"

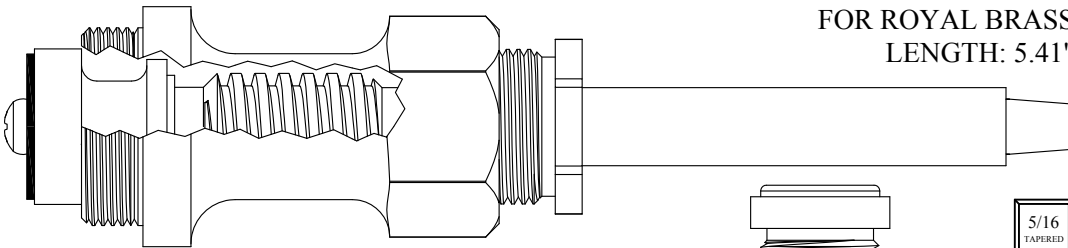

419021

219011 Stem Only

GASKET: 895560

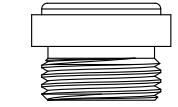

SEAT USED: 649850



Chrome Plated Stem

FOR ROYAL BRASS
LENGTH: 5.41"

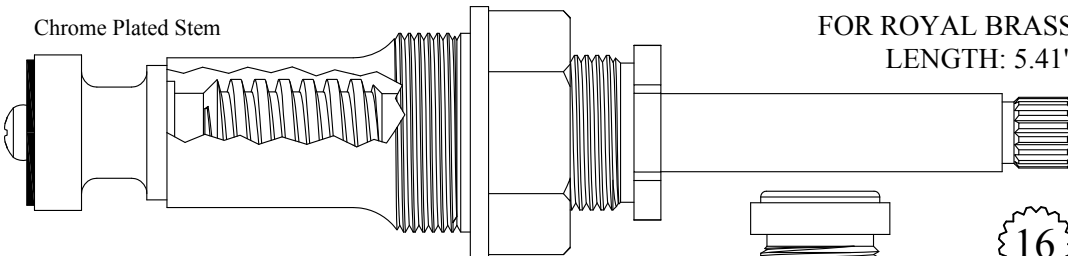

419031

219031 Stem Only

GASKET: 895560

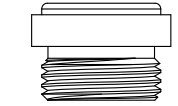

SEAT USED: 649850



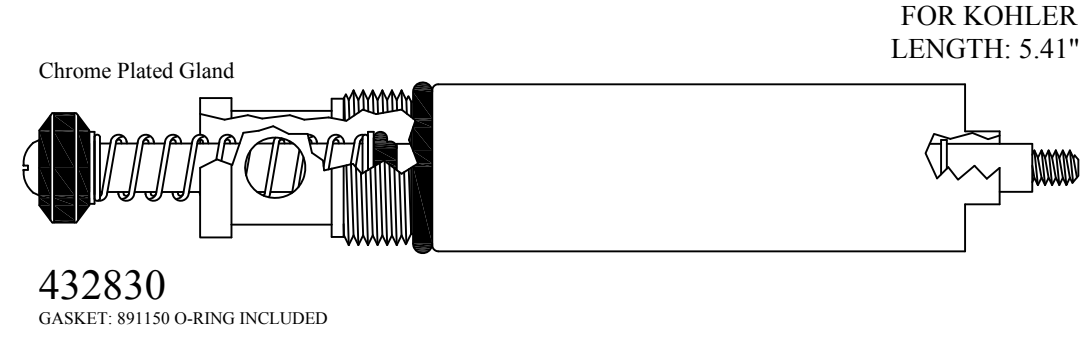
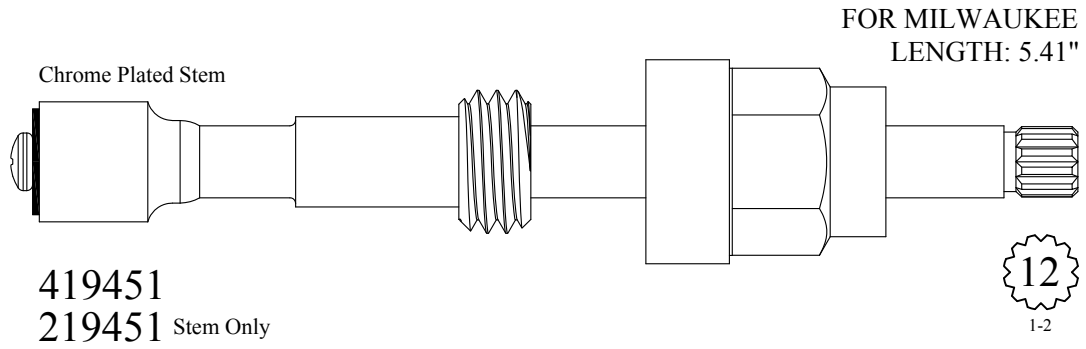
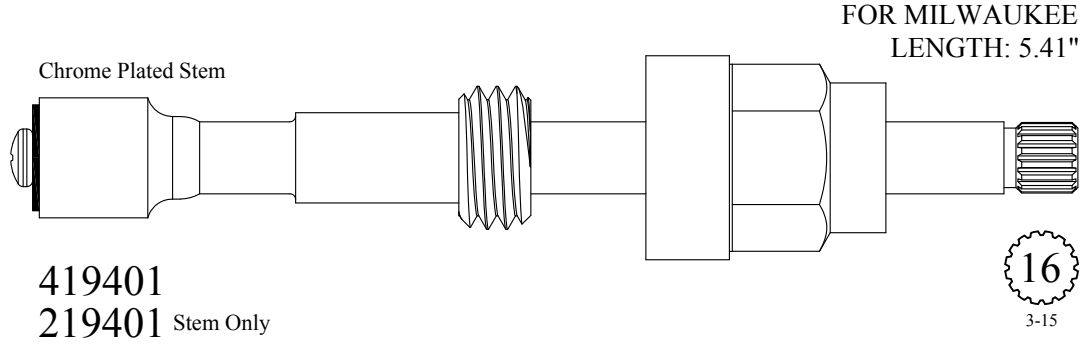
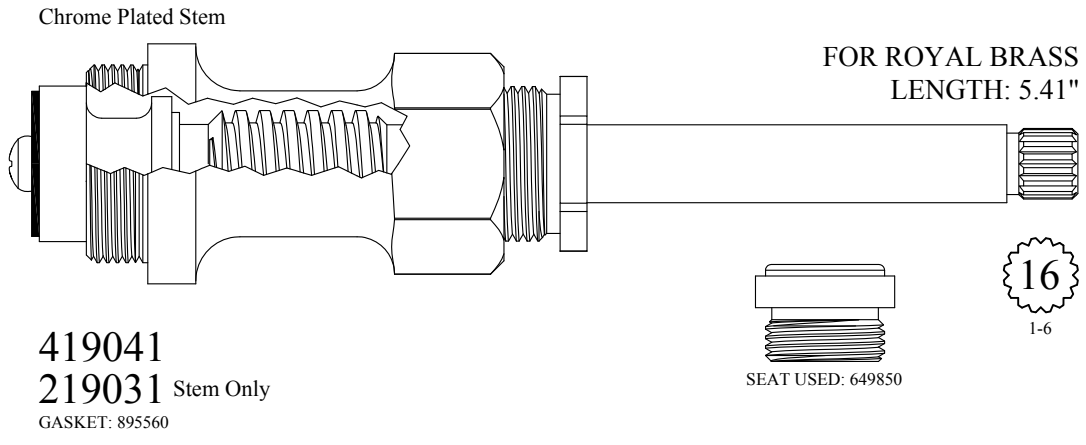

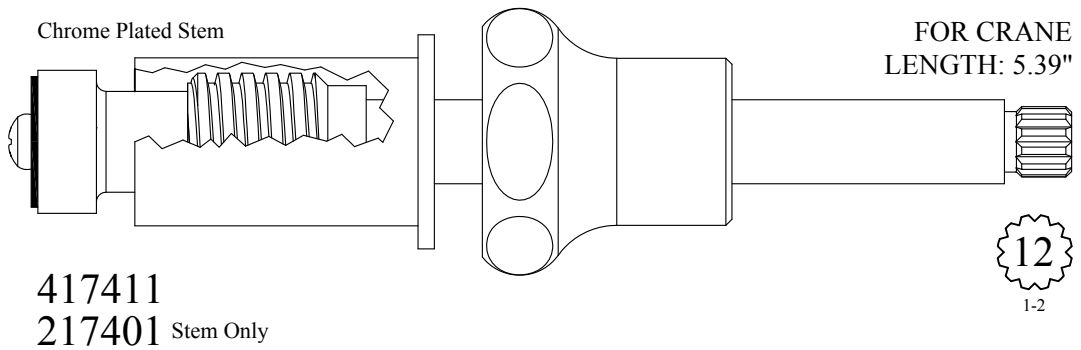
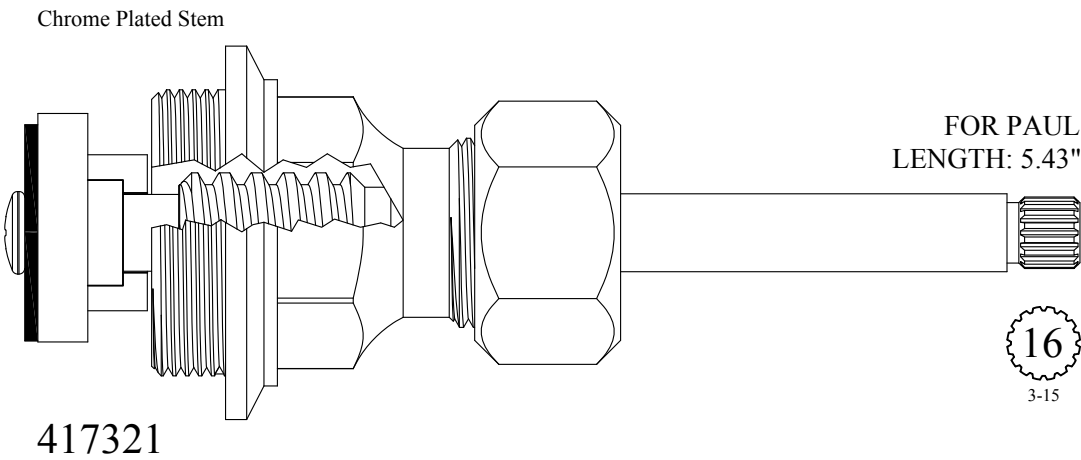
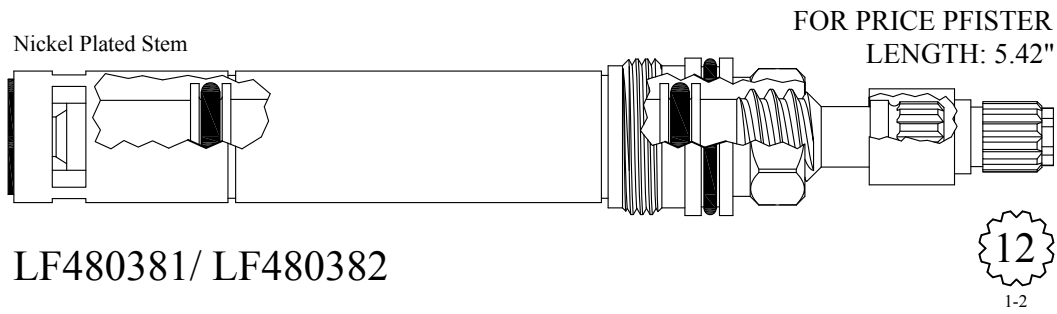
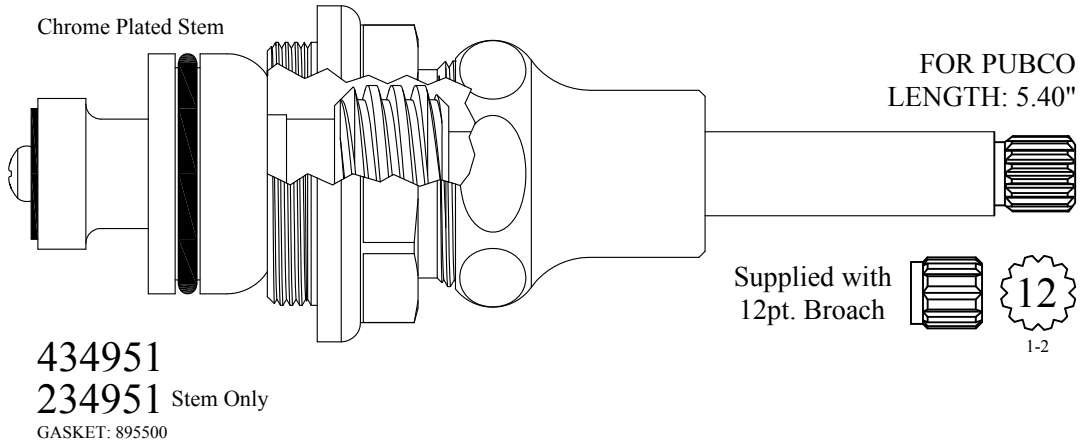

FOR MUELLER
LENGTH: 5.43"

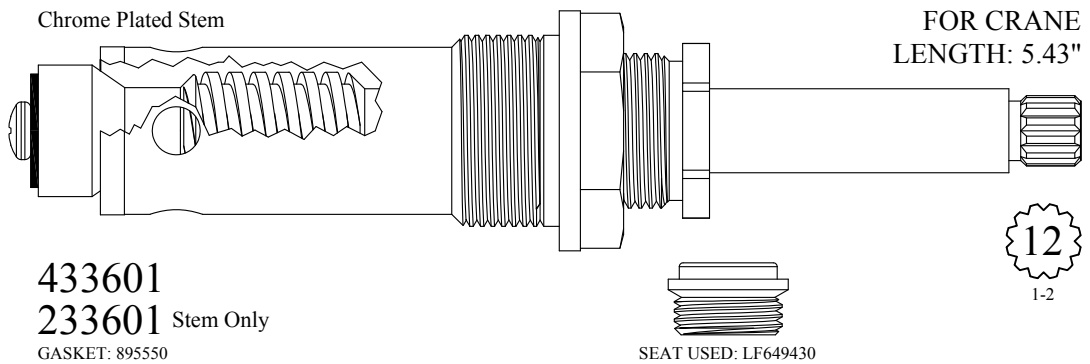
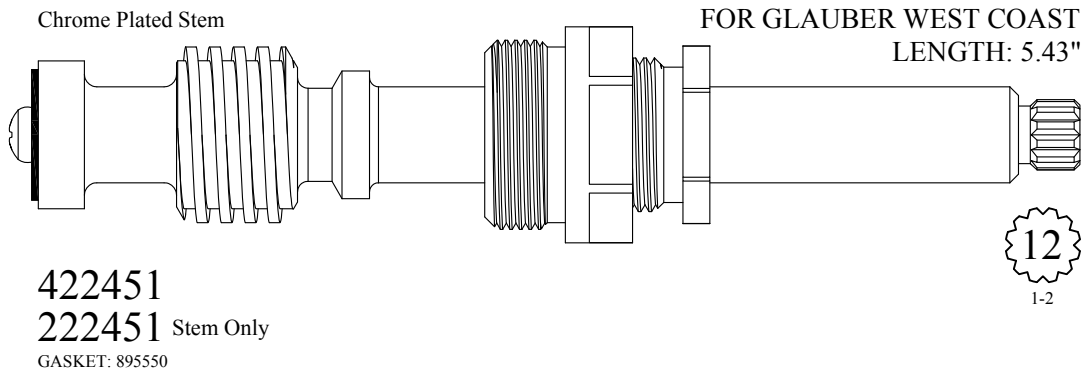
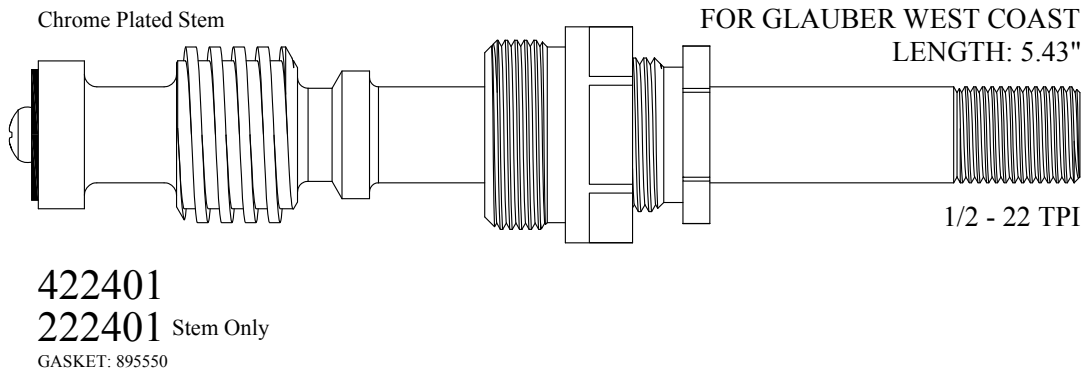
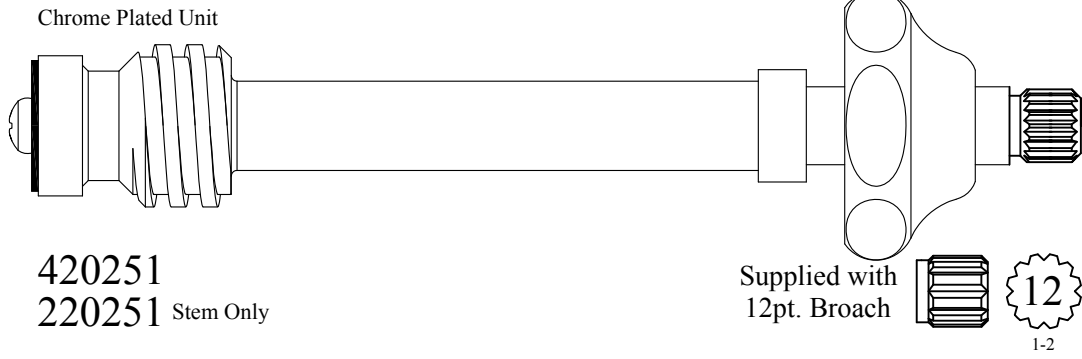



FOR ONDINE
LENGTH: 5.43"

421221/ 421222

GASKET: 890170 O-RING INCLUDED
SEAL: 898570-R/B
DISC SET: 151380-PKG

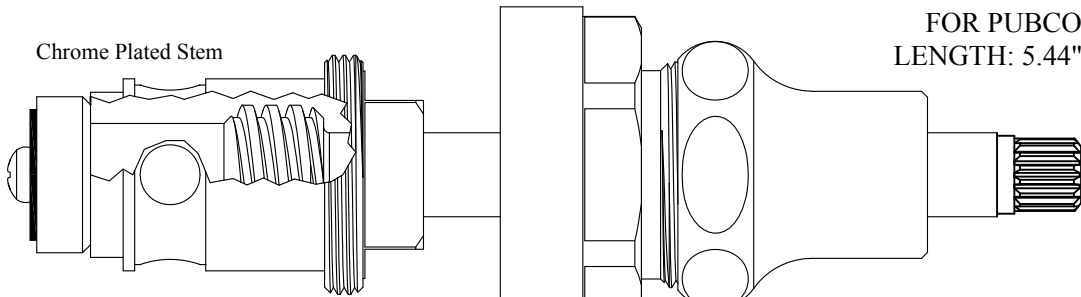

Chrome Plated Stem

FOR PUBCO
LENGTH: 5.44"

433351

233351 Stem Only

Supplied with
12pt. Broach

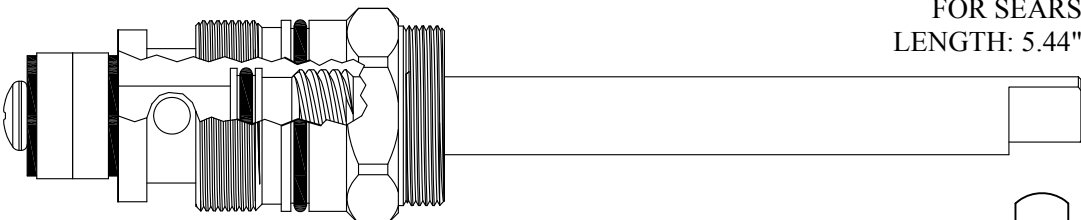

FOR SEARS
LENGTH: 5.44"

434741

GASKET: 890200

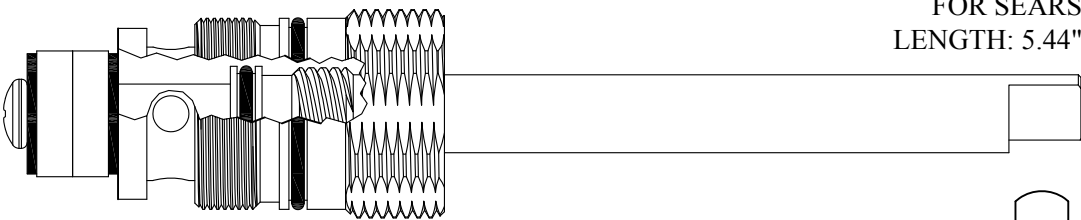

FOR SEARS
LENGTH: 5.44"

434841

GASKET: 890200



FOR ONDINE
LENGTH: 5.44"

16
3-16

421241/ 421242

GASKET: 890210 O-RING INCLUDED
SEAL: 898610-R/B
DISC SET: 109850-PKG

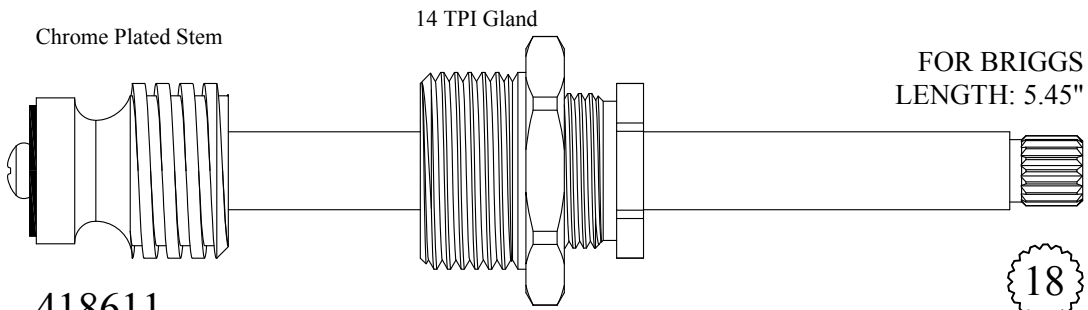

FOR BRIGGS
LENGTH: 5.45"

18
3-3

418611

220301 Stem Only

GASKET: 895570

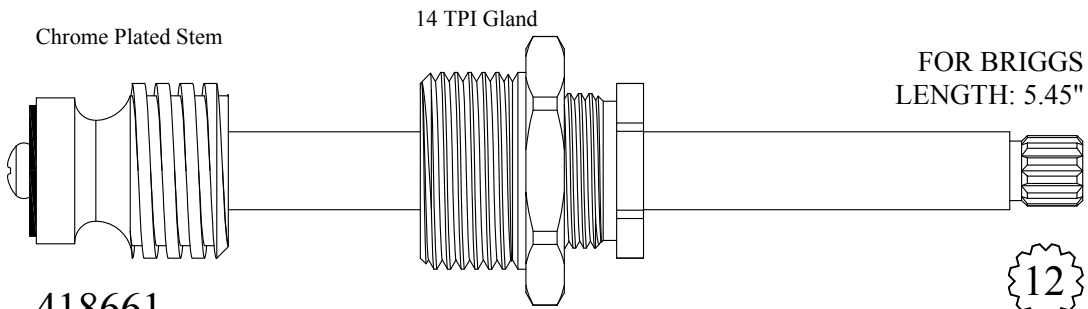

FOR BRIGGS
LENGTH: 5.45"

12
1-2

418661

220351 Stem Only

GASKET: 895570

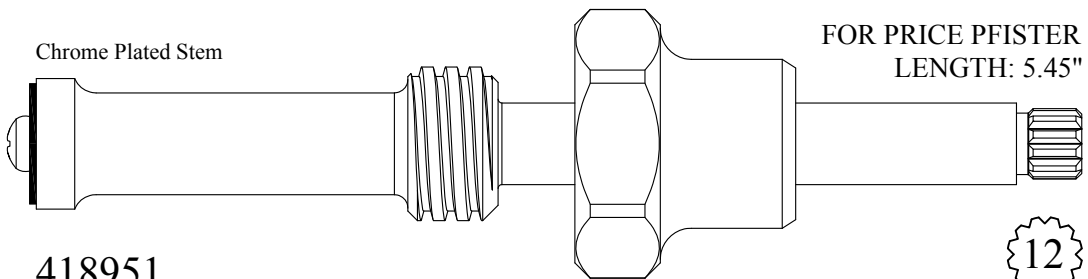

FOR PRICE PFISTER
LENGTH: 5.45"

12
1-2

418951

218951 Stem Only

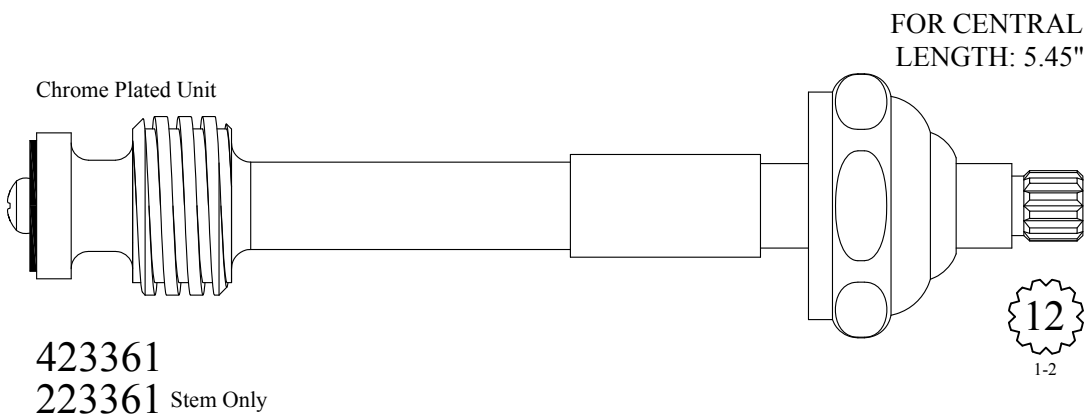
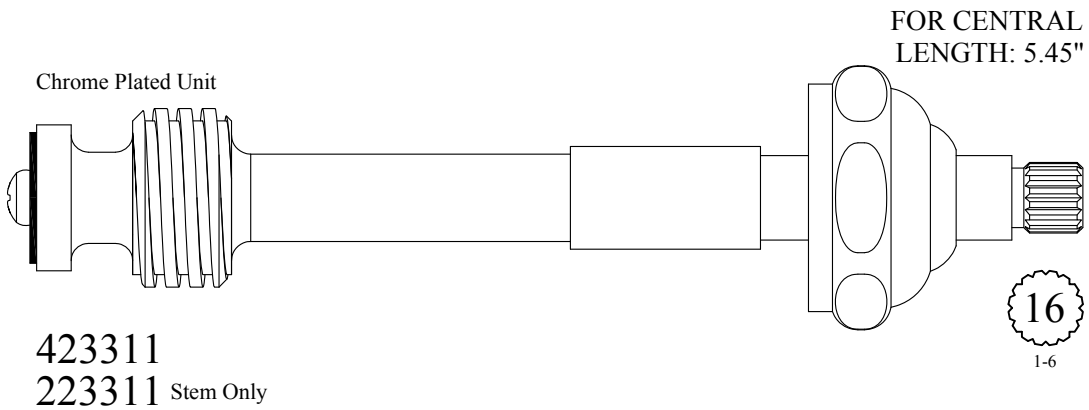
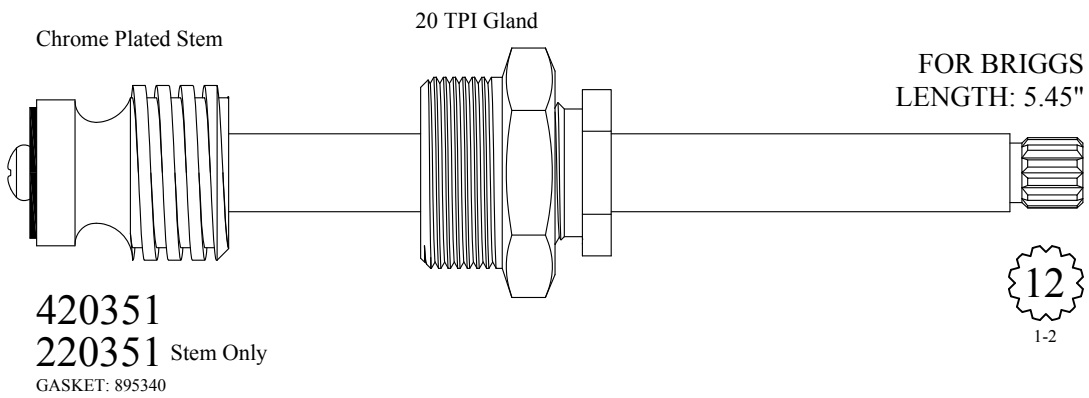
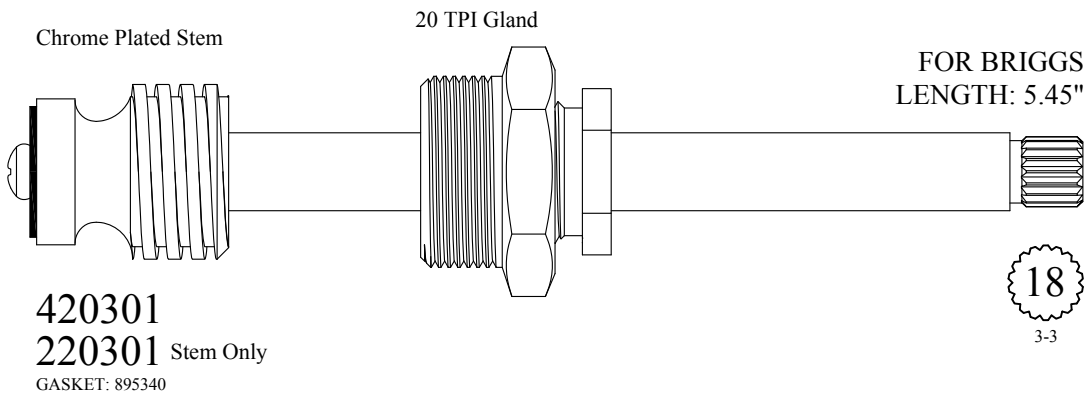

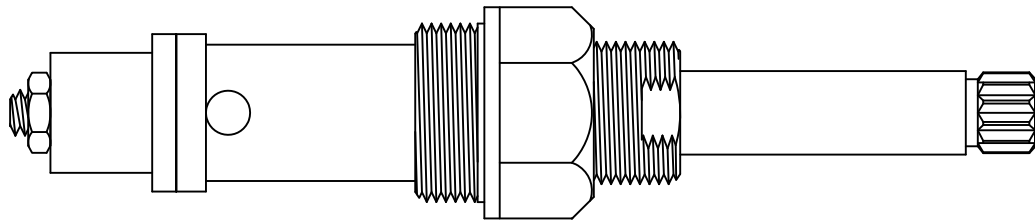

Old Style, Use 433281

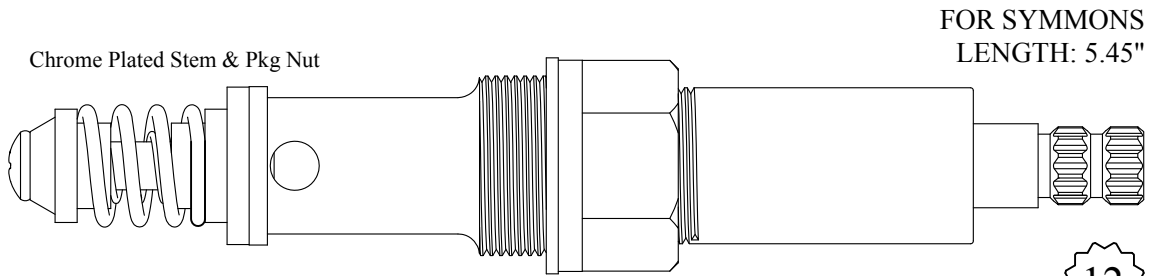

433281

GASKET: 895350 INCLUDED

12

Symmons Small

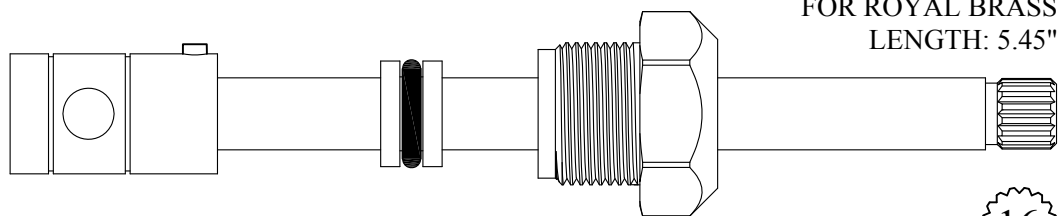

433520

233520 Stem Only

GASKET: 895100

16

1-6

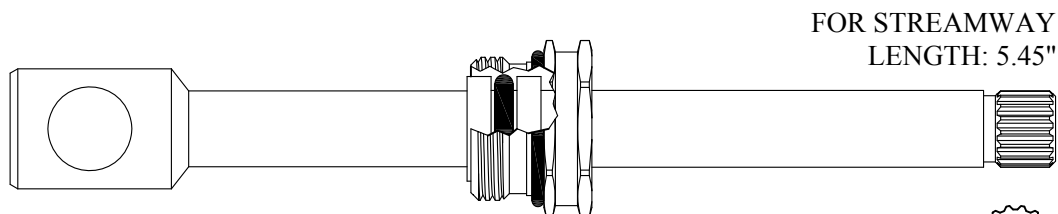

434810

234810 Stem Only

GASKET: 890170 O-RING INCLUDED

17

3-7

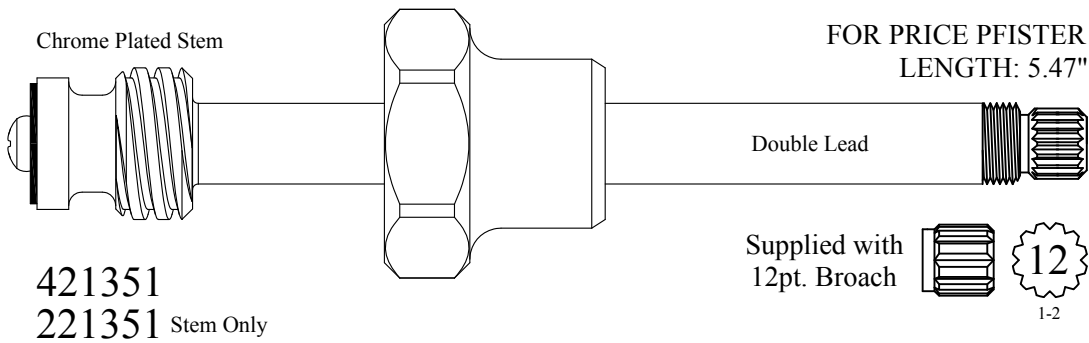
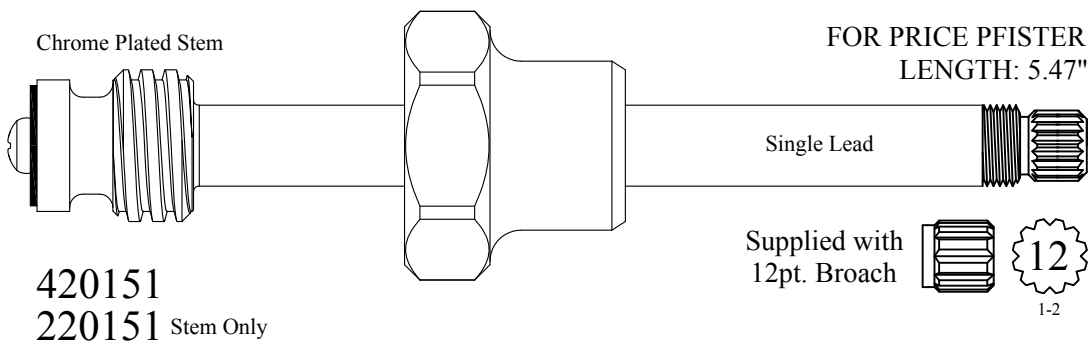
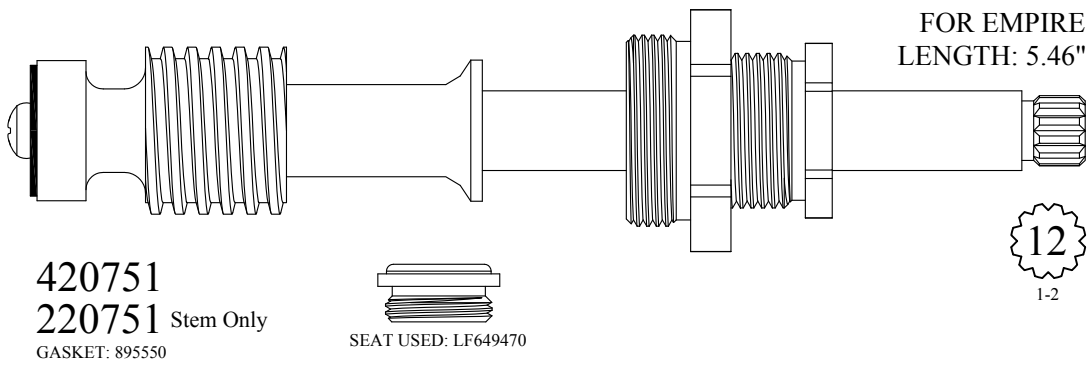
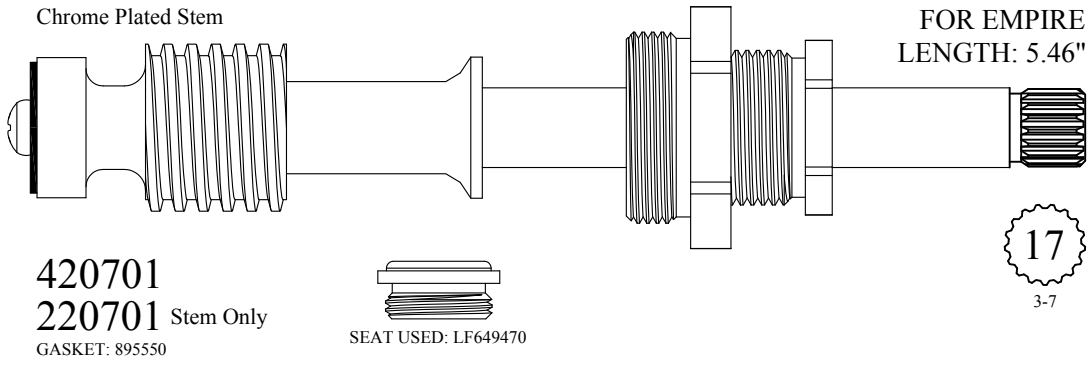

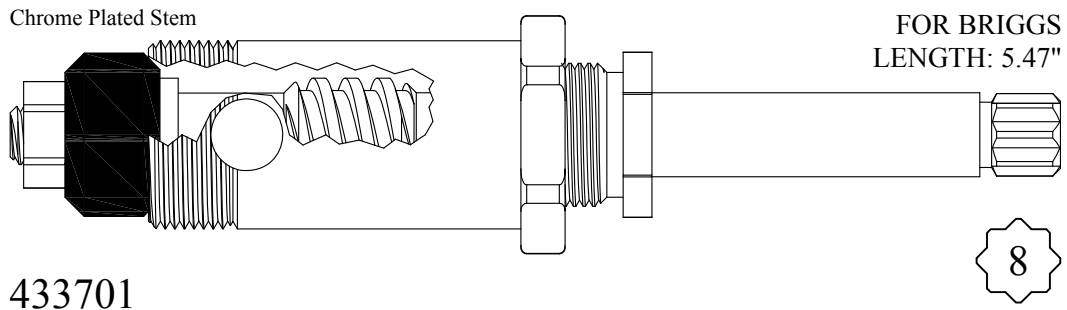

433701
 233701 Stem Only
 GASKET: 895340

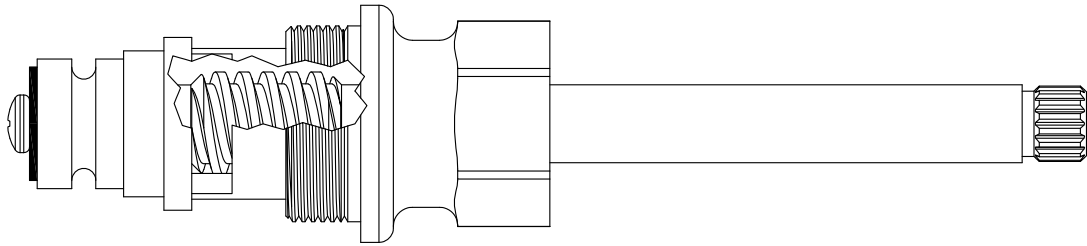

Not Available, Use 434001

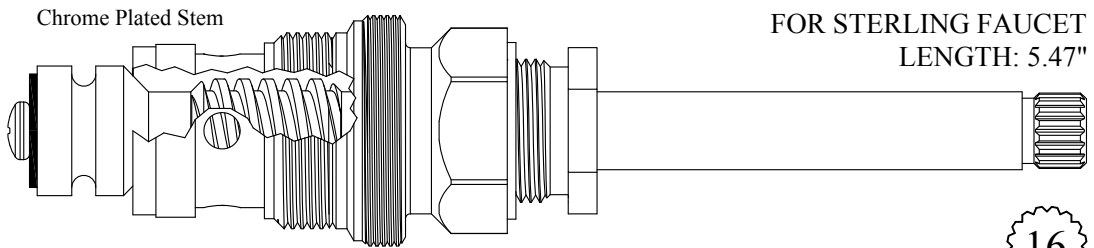

434001
 234001 Stem Only
 GASKET: 895560

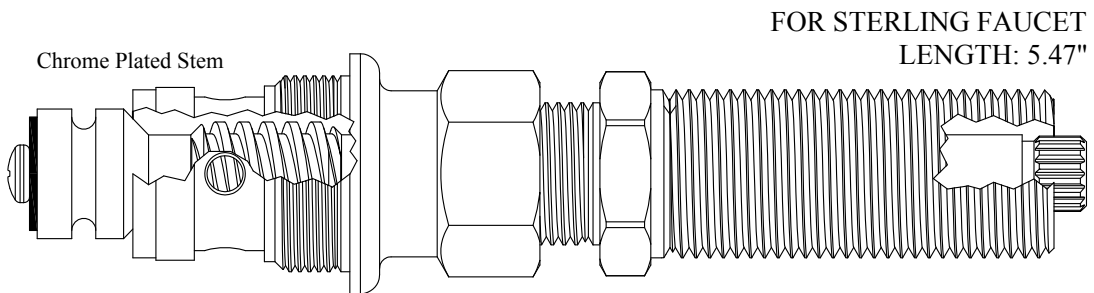

434011
 234001 Stem Only
 GASKET: 895560



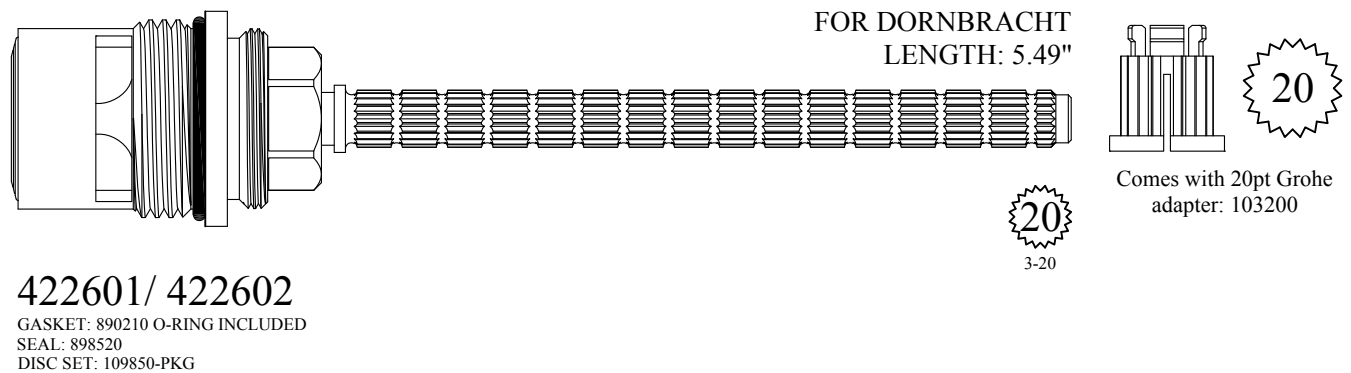
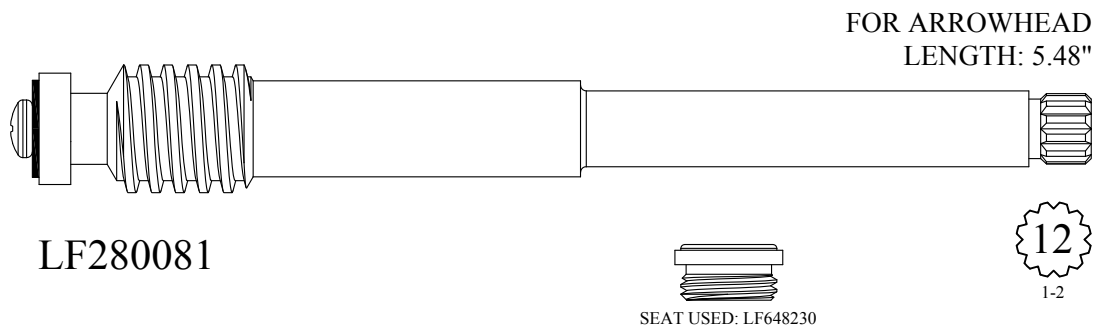
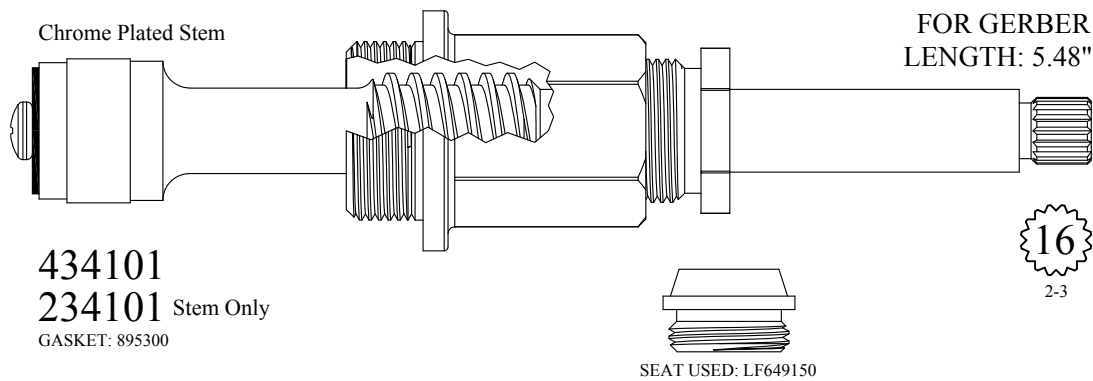
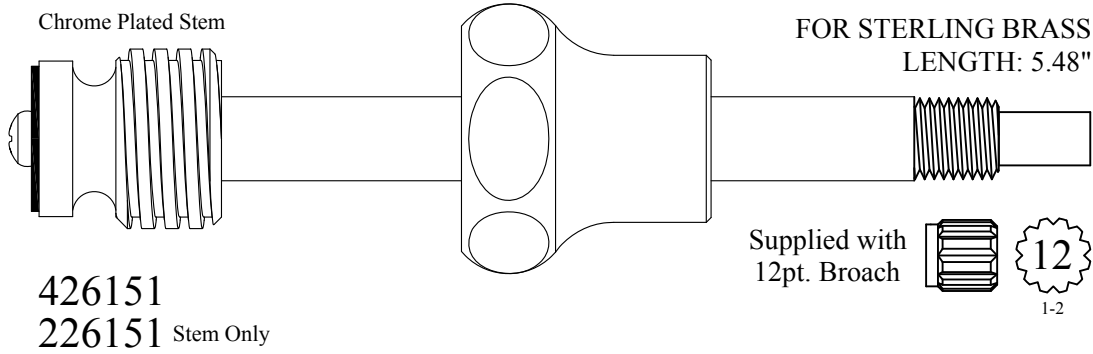

FOR DORNBRACHT
LENGTH: 5.49"

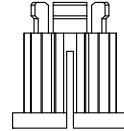
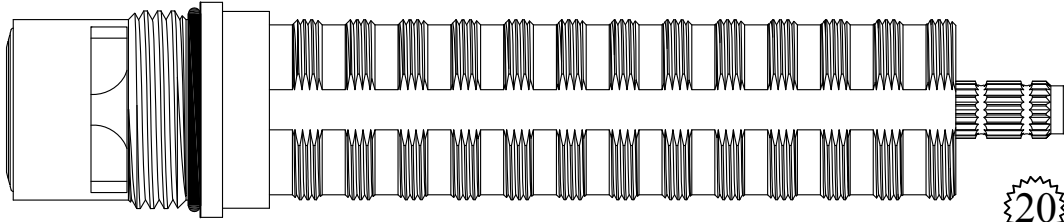

20

Comes with 20pt Grohe
adapter: 103200

20
3-20

422601-EN/ 422602-EN

GASKET: 890210 O-RING INCLUDED
SEAL: 898520
DISC SET: 109850-PKG

Escutcheon Nipple available separately
125080

Chrome Plated Stem

UNKNOWN
LENGTH: 5.50"

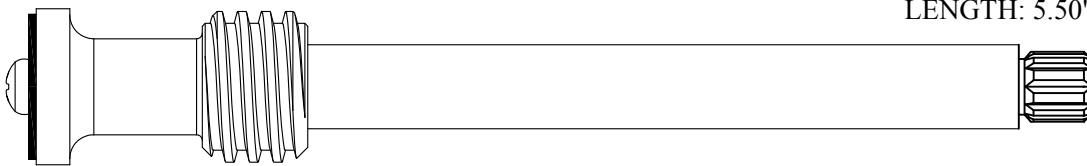

221021

Supplied with
12pt. Broach  12
1-2

FOR WOLVERINE
LENGTH: 5.50"

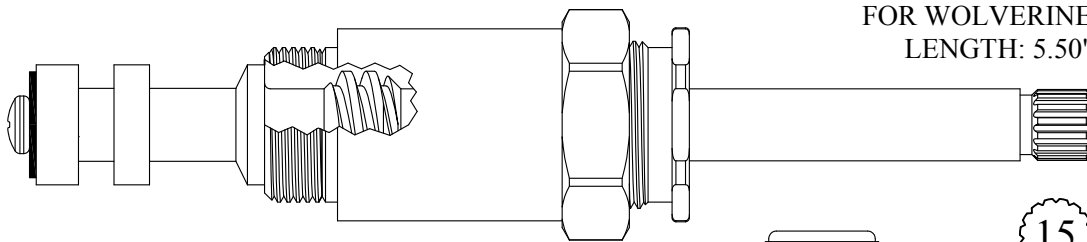

418311
GASKET: 895150

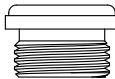
 15
3-27
SEAT USED: LF649200

FOR WOLVERINE
LENGTH: 5.50"

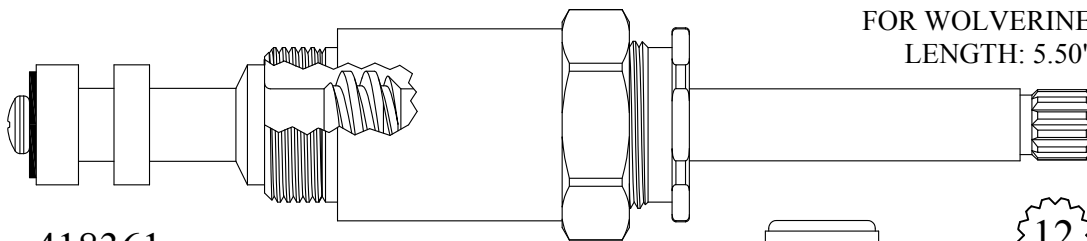

418361
GASKET: 895150

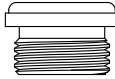
 12
1-2
SEAT USED: LF649200

Chrome Plated Stem

FOR ART F
LENGTH: 5.50"

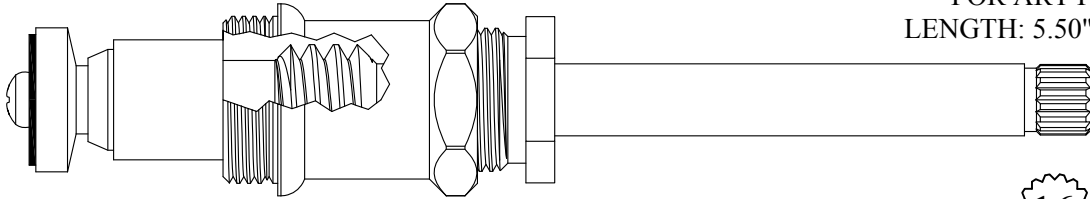

420501
220501 Stem Only
GASKET: 895400

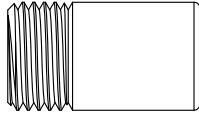

SEAT USED: 649260

16
1-6

Chrome Plated Stem

FOR ART F
LENGTH: 5.50"

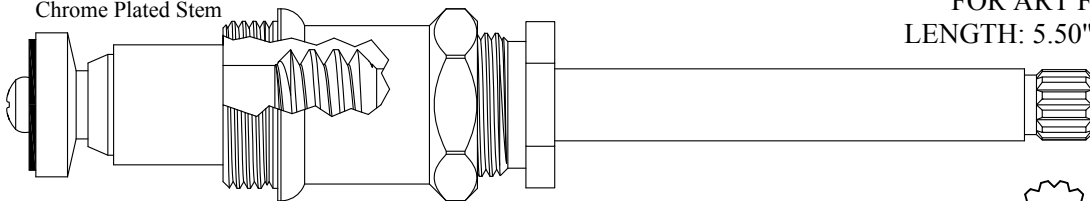

420551
220551 Stem Only
GASKET: 895400

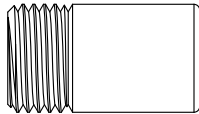

SEAT USED: 649260

12
1-2

Chrome Plated Stem

FOR ART F
LENGTH: 5.50"

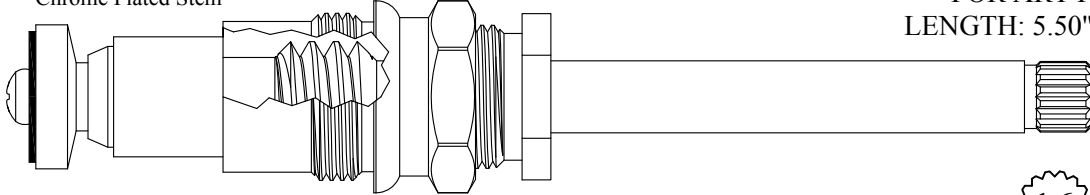

420511
220501 Stem Only
GASKET: 895400



SEAT USED: LF649430

16
1-6

Chrome Plated Stem

FOR ART F
LENGTH: 5.50"

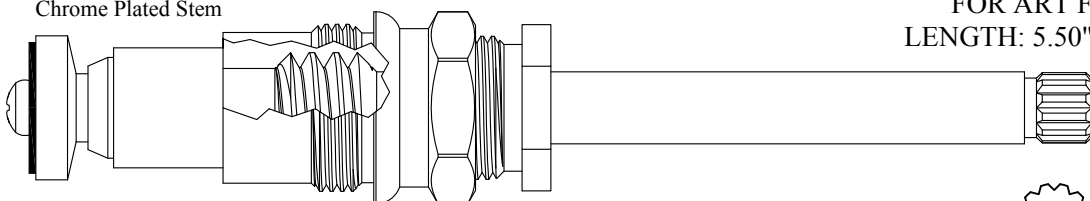

420561
220551 Stem Only
GASKET: 895400



SEAT USED: LF649430

12
1-2

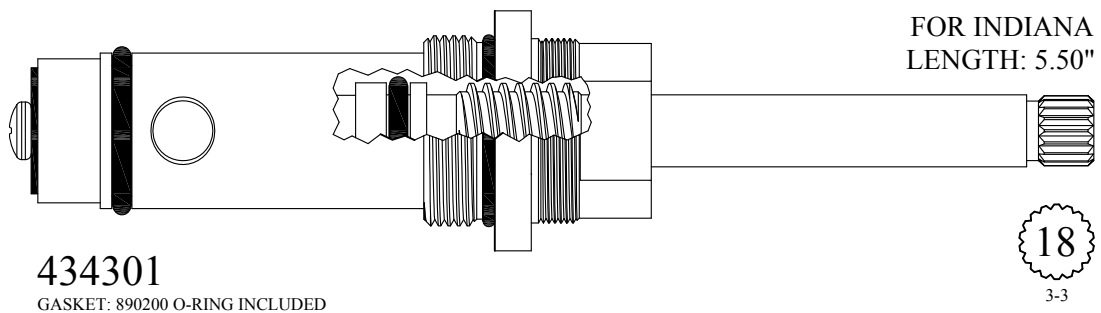
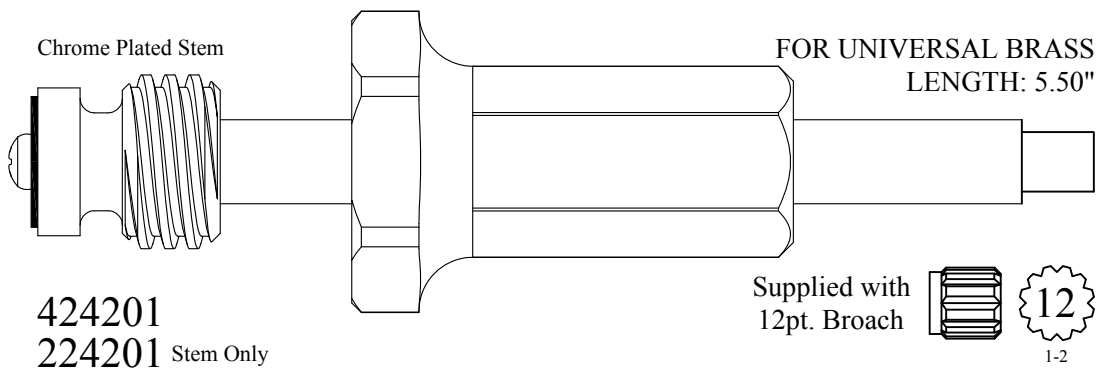
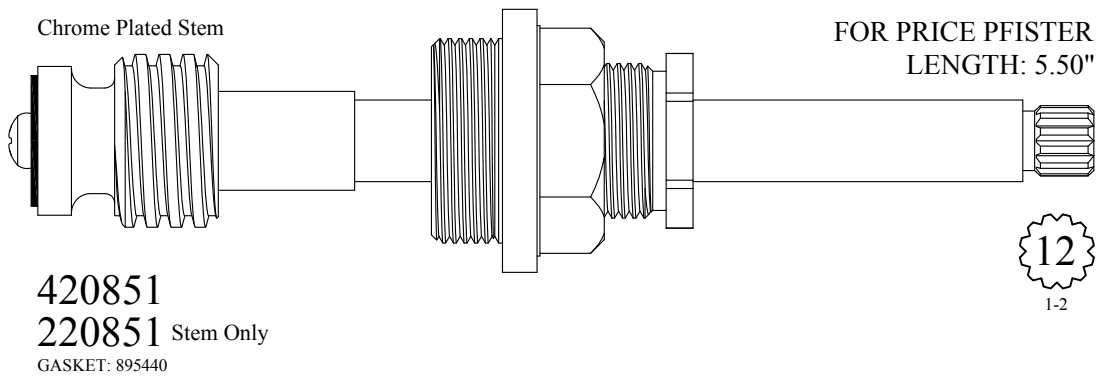
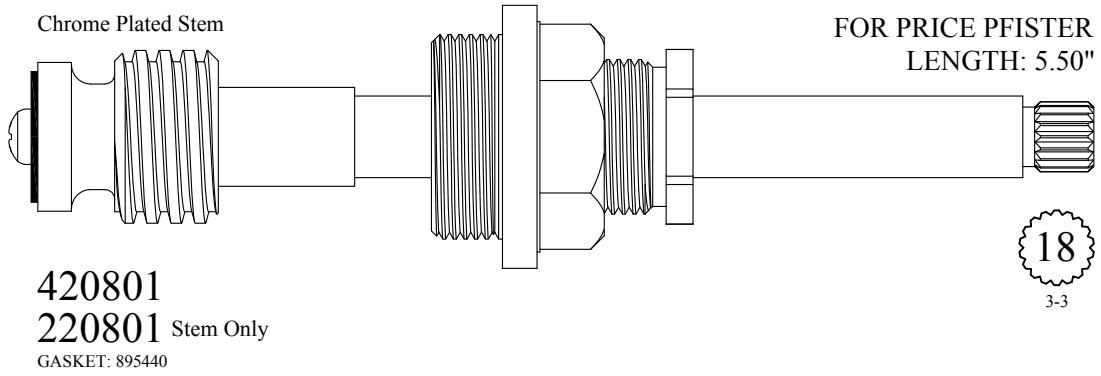

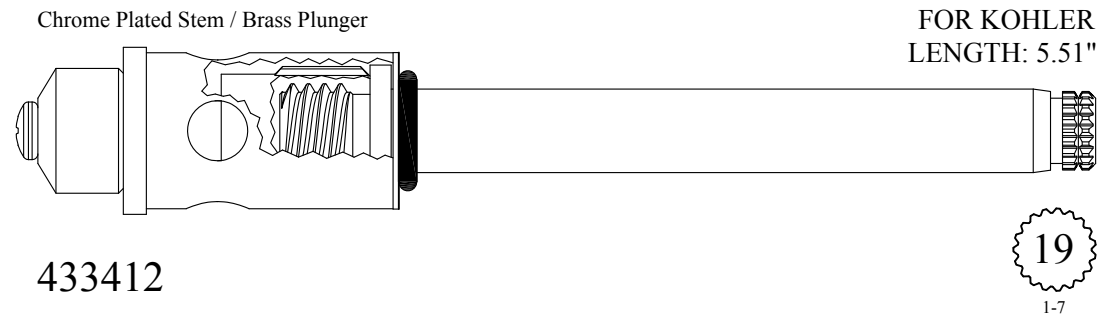
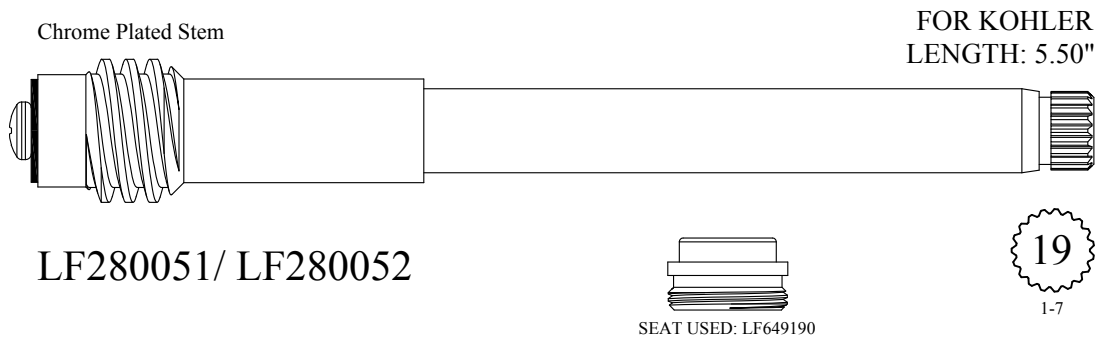
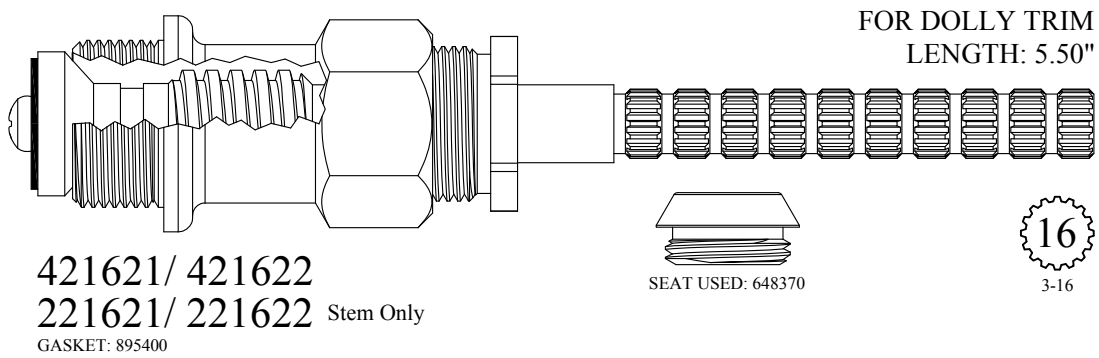
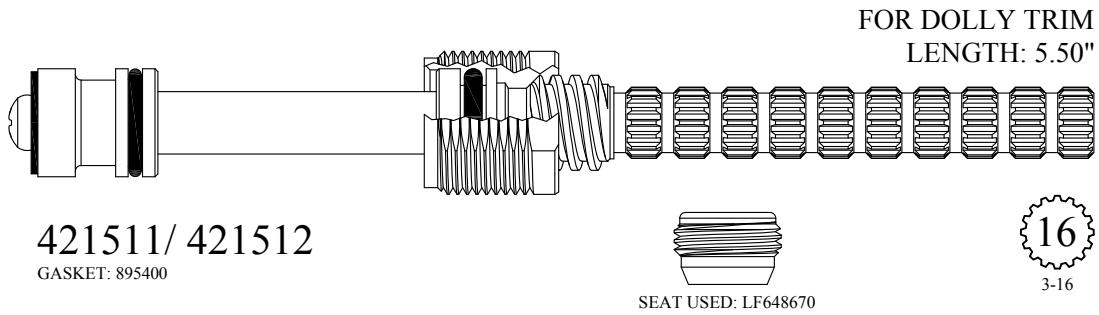

Chrome Plated Stem & Bonnet / Brass Plunger

FOR KOHLER
LENGTH: 5.51"

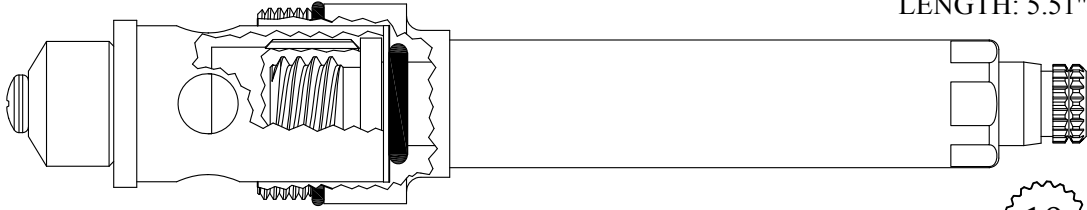

433422

GASKET: 890210 O-RING INCLUDED

19

1-7

Chrome Plated Stem

UNKNOWN
LENGTH: 5.52"

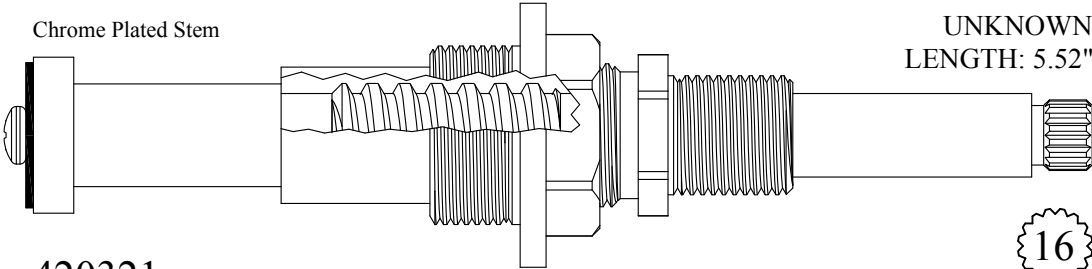

420321

GASKET: 895370

16

1-6

Chrome Plated Unit

FOR BRIGGS
LENGTH: 5.52"

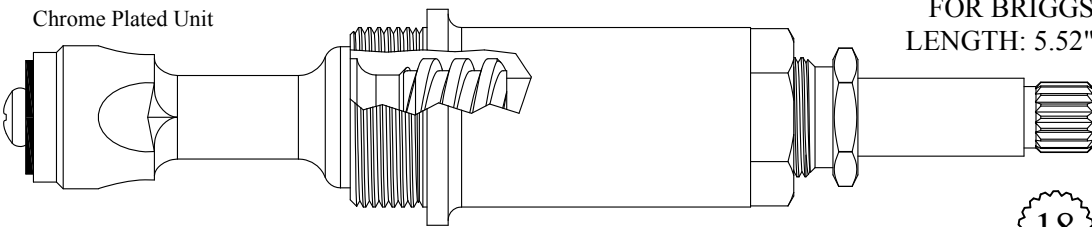

433712

233712 Stem Only

GASKET: 895370

18

3-3

Chrome Plated Stem

FOR GERBER
LENGTH: 5.52"

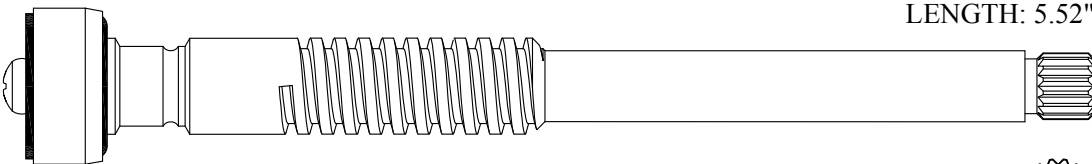

236411

16

2-3

Chrome Plated Stem

FOR PRICE PFISTER
LENGTH: 5.53"

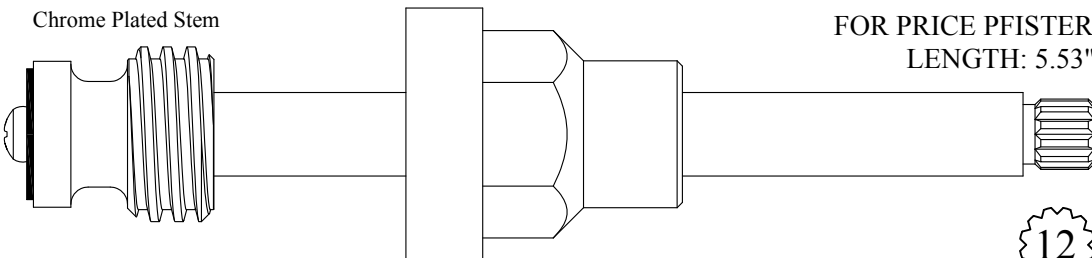

420861

220861 Stem Only

12

1-2

Chrome Plated Unit

FOR APEX
LENGTH: 5.53"

420951
220951 Stem Only

Supplied with
12pt. Broach

12
1-2

Chrome Plated Unit

FOR BRIGGS
LENGTH: 5.45"

421051
220951 Stem Only

Supplied with
12pt. Broach

12
1-2

FOR DOLLY TRIM
LENGTH: 5.53"

432021
234731 Stem Only
GASKET: 895560

SEAT USED: 648370

16
3-16

FOR DOLLY TRIM
LENGTH: 5.53"

434731
234731 Stem Only
GASKET: 895550

SEAT USED: 648370

16
3-16

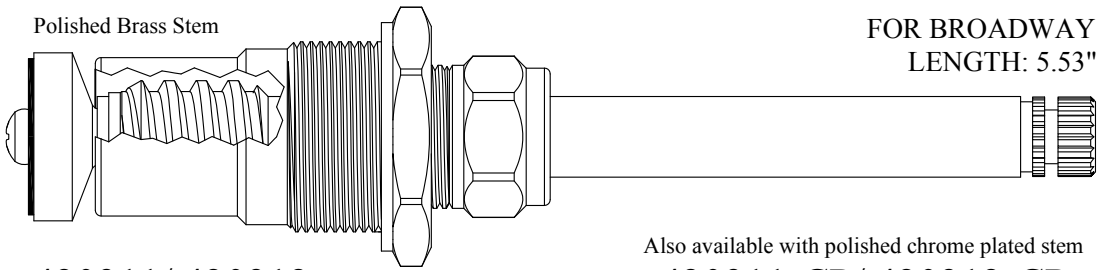

20
2-4

420311/ 420312
220311/ 220312 Stem Only
GASKET: 895570

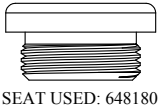

SEAT USED: 648180

Also available with polished chrome plated stem
420311-CP/ 420312-CP
220311-CP/ 220312-CP Stem Only

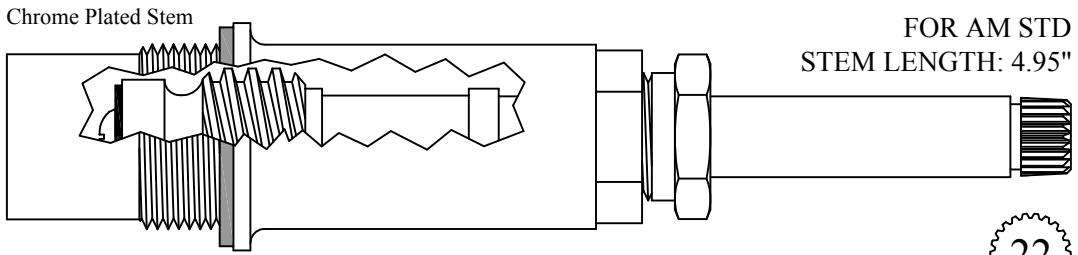

22
1-4

412311
LF278011 Stem Only
GASKET INCLUDED: 895350

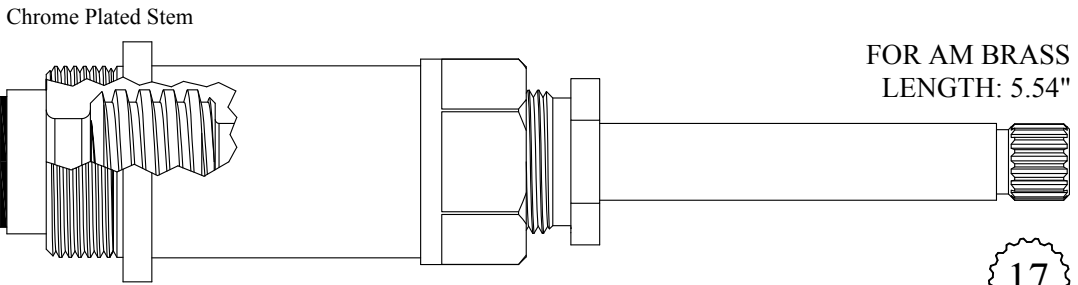

17
3-7

421201
221201 Stem Only
GASKET: 895550



SEAT USED: LF648140

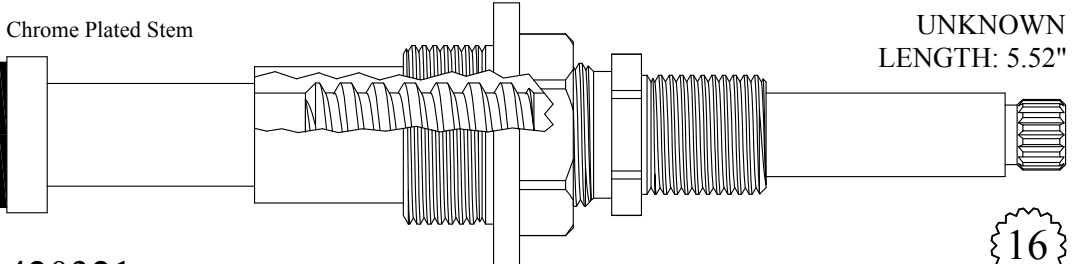

16
1-6

420321
GASKET: 895370

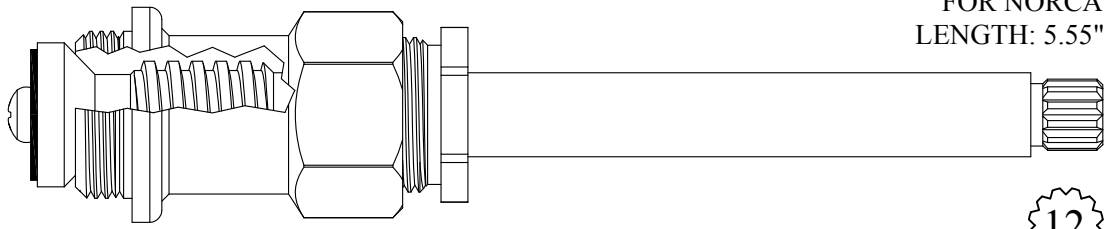

FOR NORCA
LENGTH: 5.55"

12
1-2

421631
GASKET: 895400

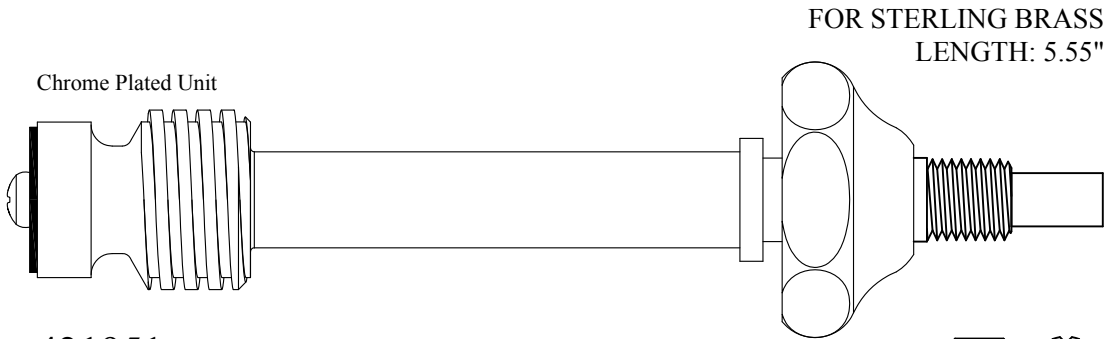

FOR STERLING BRASS
LENGTH: 5.55"

Chrome Plated Unit

Supplied with
12pt. Broach  12
1-2

421951
221951 Stem Only

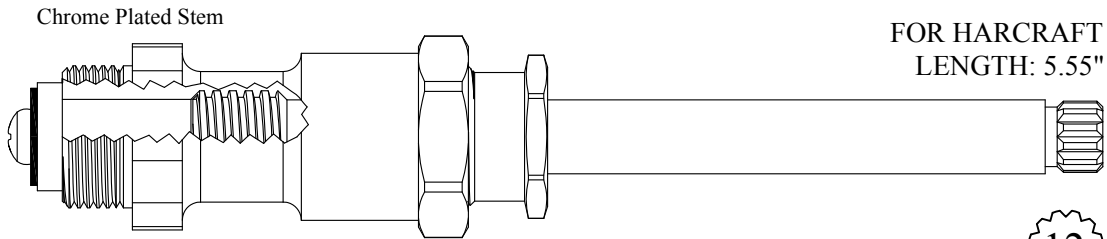

FOR HARCRAFT
LENGTH: 5.55"

Chrome Plated Stem

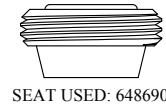

SEAT USED: 648690

12
1-2

423001
223001 Stem Only
GASKET: 895100

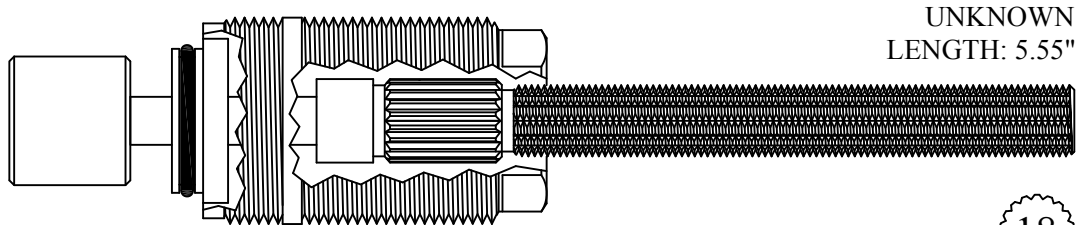

UNKNOWN
LENGTH: 5.55"

18
3-3

434610

19
1-7

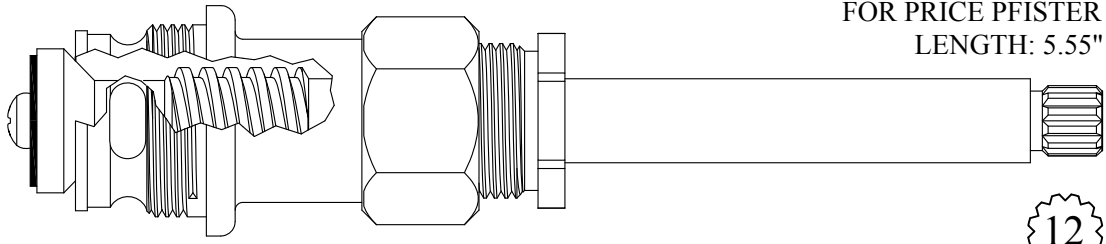

FOR PRICE PFISTER
LENGTH: 5.55"

434701
234701 Stem Only
GASKET: 895550

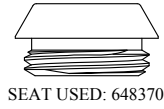

SEAT USED: 648370

12
1-2

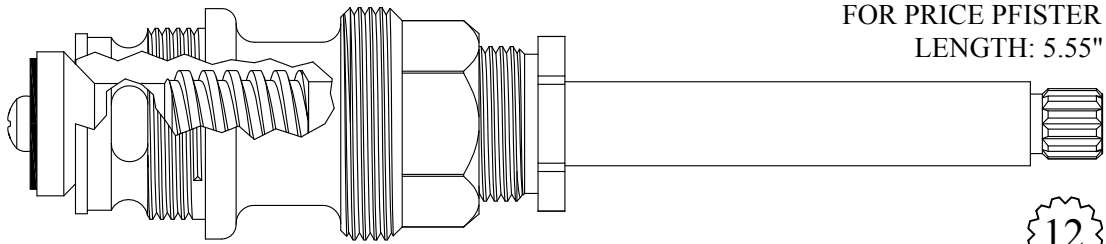

FOR PRICE PFISTER
LENGTH: 5.55"

434711
234701 Stem Only
GASKET: 895550



SEAT USED: 648370

12
1-2

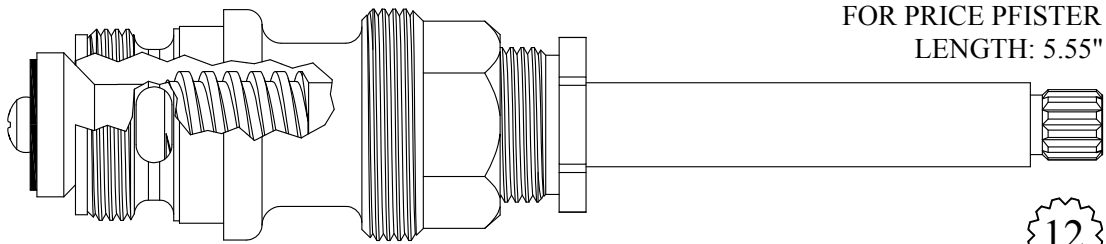

FOR PRICE PFISTER
LENGTH: 5.55"

434751
234701 Stem Only
GASKET: 895560



SEAT USED: 648370

12
1-2

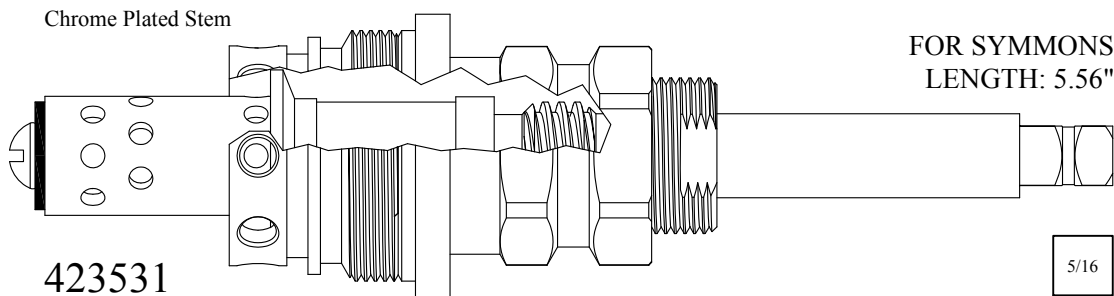

Chrome Plated Stem

FOR SYMMONS
LENGTH: 5.56"

423531
223531 Stem Only
GASKET: 895500 INCLUDED

5/16

FOR NEWPORT
FOR PHYLRICH
LENGTH: 5.56"

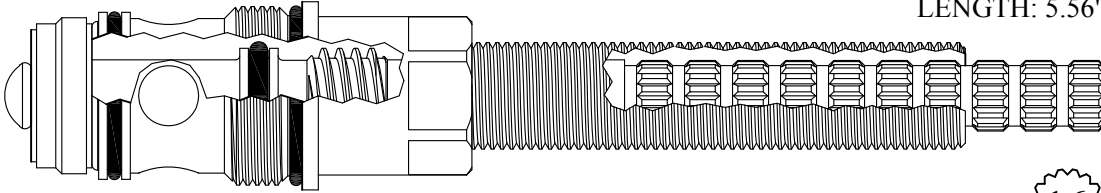

433371

GASKET: 890190 O-RING INCLUDED

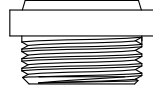

SEAT USED: 647650

16
1-6

FOR PRICE PFISTER
LENGTH: 5.55"

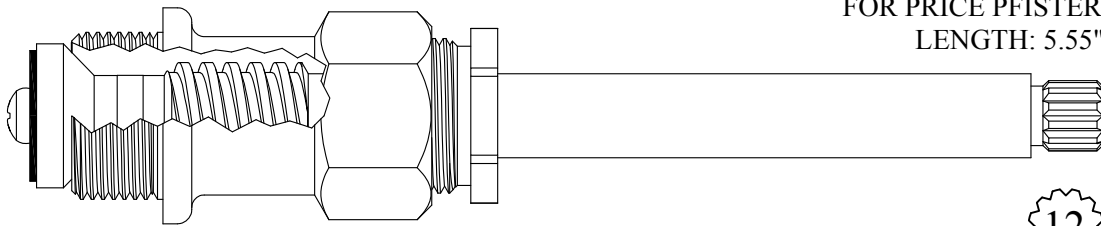

421601/ 421602

221601/ 221602 Stem Only
GASKET: 895400

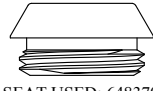

SEAT USED: 648370

12
1-2

FOR PRICE PFISTER
LENGTH: 5.55"

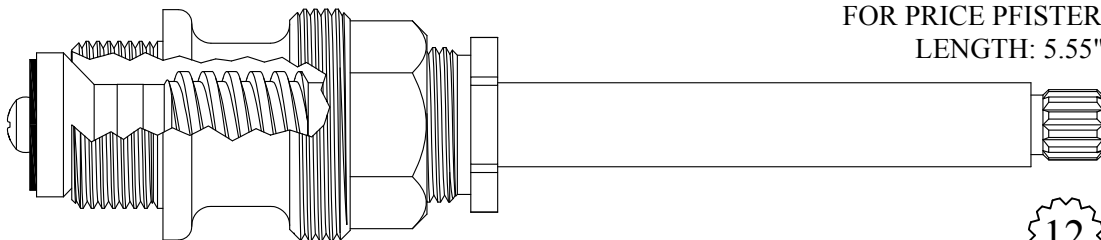

421611/ 421612

221601/ 221602 Stem Only
GASKET: 895400

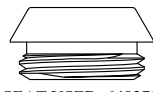

SEAT USED: 648370

12
1-2

1/2 Turn Ceramic

FOR GERBER
LENGTH: 5.56"

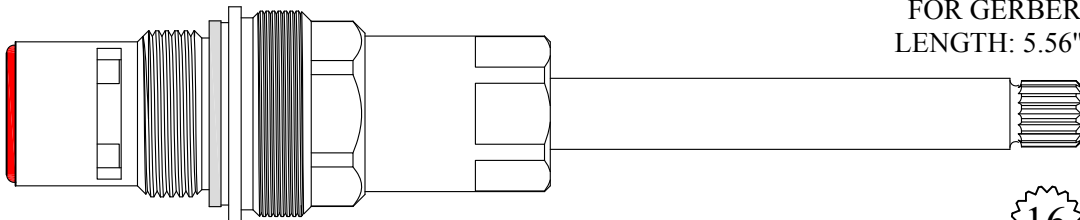

422411/ 422412

GASKET: 895180 INCLUDED
SEAL: 898570-R/B
DISC SET: 124290-PKG

16
2-3

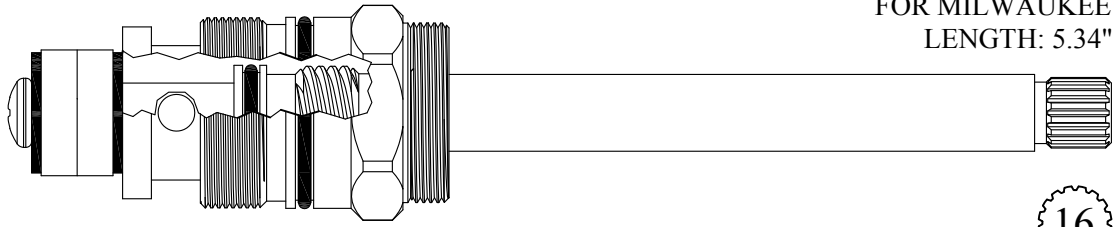

FOR MILWAUKEE
LENGTH: 5.34"

434721

GASKET: 890200 O-RING INCLUDED

16
3-15

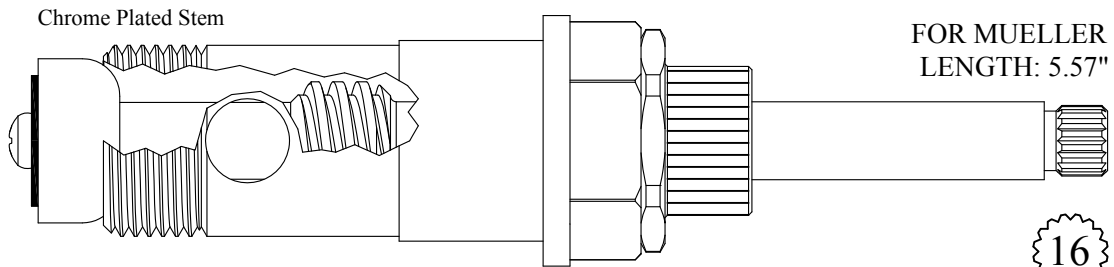

FOR MUELLER
LENGTH: 5.57"

434821

GASKET: 895440

16
1-6

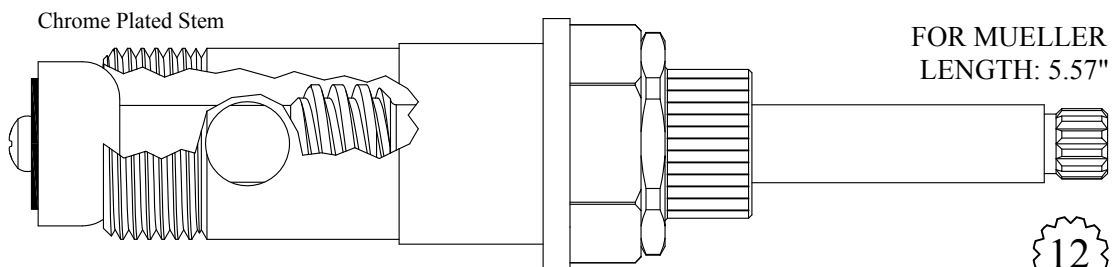

FOR MUELLER
LENGTH: 5.57"

434871

234871 Stem Only

GASKET: 895440

12
1-2

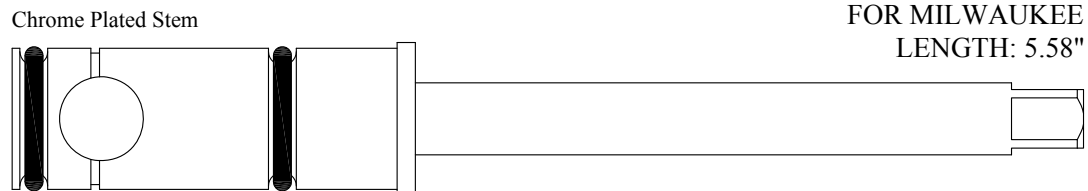

FOR MILWAUKEE
LENGTH: 5.58"

237420

5/16

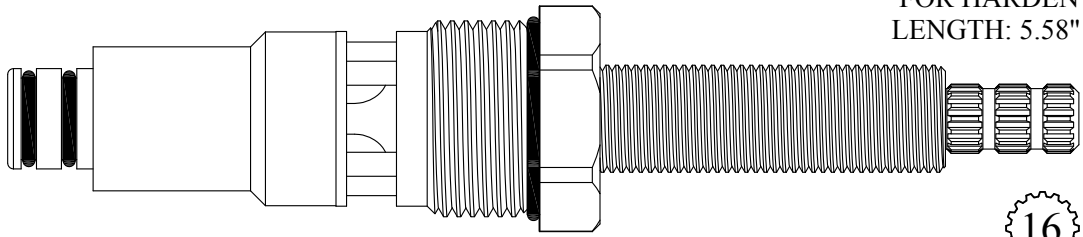

FOR HARDEN
LENGTH: 5.58"

423931/ 423932

GASKET: 890210 O-RING INCLUDED
DISC SET: 151380-PKG

16
3-16

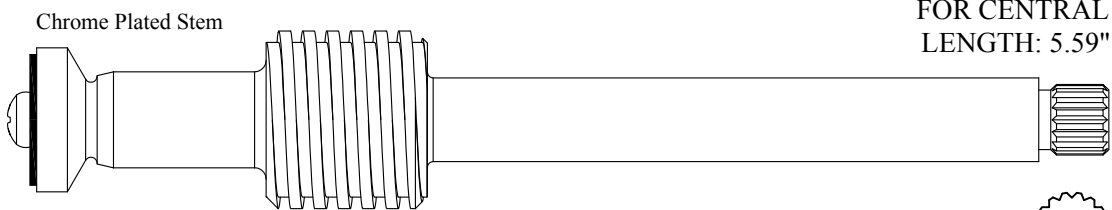

Chrome Plated Stem

FOR CENTRAL
LENGTH: 5.59"

222201

16
1-6

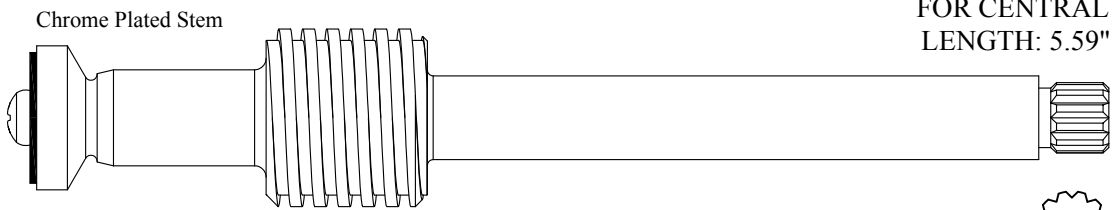

Chrome Plated Stem

FOR CENTRAL
LENGTH: 5.59"

222251

12
1-2

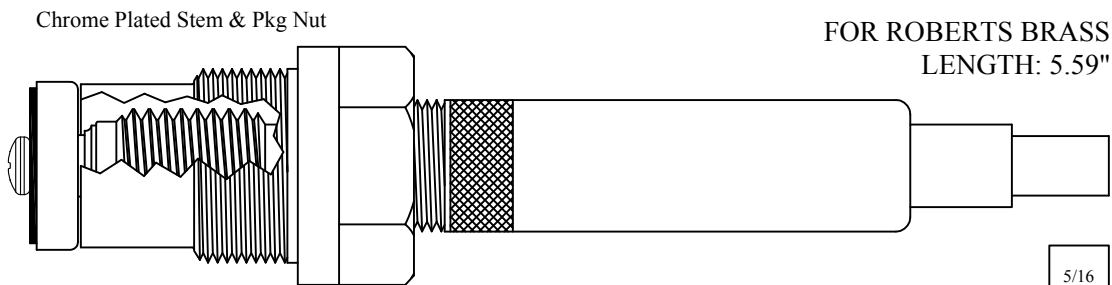

Chrome Plated Stem & Pkg Nut

FOR ROBERTS BRASS
LENGTH: 5.59"

420711

220711 Stem Only

GASKET: 895450

5/16

Chrome Plated Stem & Pkg Nut

FOR ROBERTS BRASS
LENGTH: 5.59"

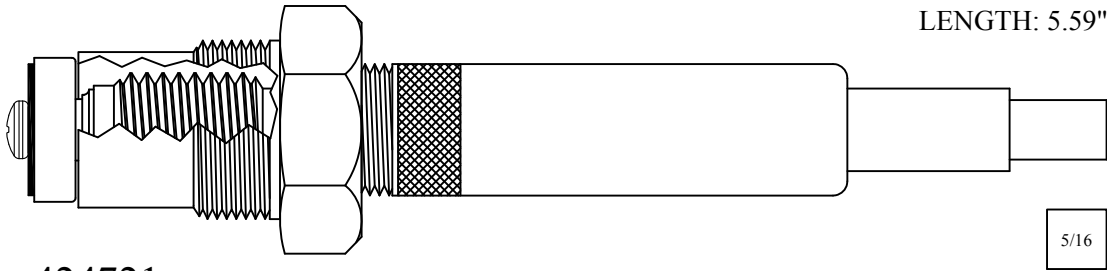

424721

224721 Stem Only

GASKET: 895320

Chrome Plated Stem

FOR CRANE
LENGTH: 5.60"

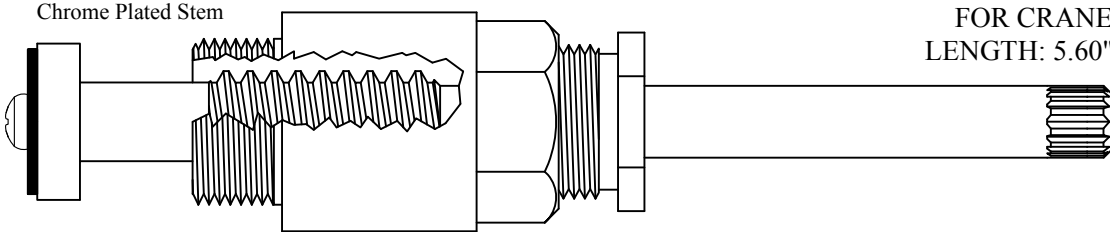

Not Available, Use 423151

Chrome Plated Stem

FOR CRANE
LENGTH: 5.60"

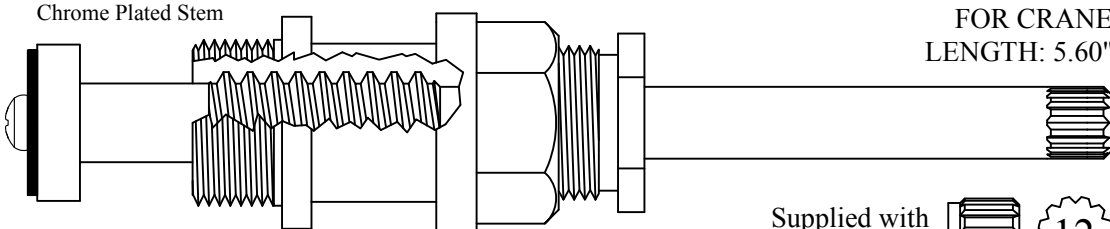

423151

223151 Stem Only

GASKET: 895400

Supplied with
12pt. Broach



1-2



SEAT USED: 648370

Chrome Plated Stem

FOR ROYAL BRASS
LENGTH: 5.60"

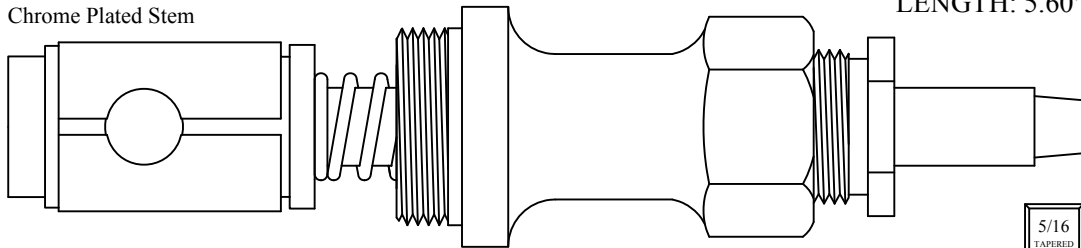

433540

233540 Stem Only

GASKET: 895560

Chrome Plated Stem

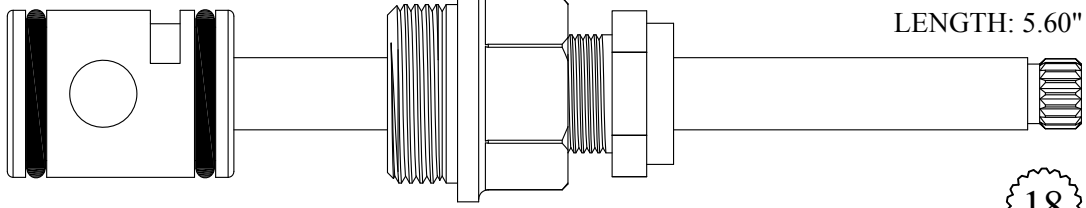

FOR UNION BRASS
LENGTH: 5.60"

435200
235200 Stem Only

18
3-3

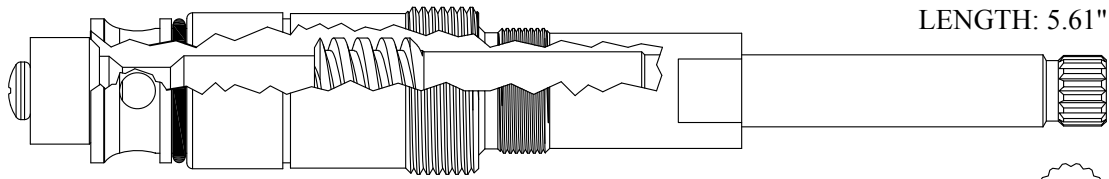

FOR AM STD
LENGTH: 5.61"

433801
233801 Stem Only
WAVE WASHER INCLUDED: 897110

16

Chrome Plated Stem & Esc Tube

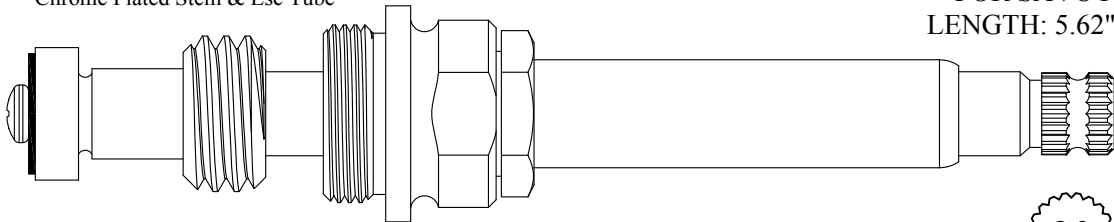

FOR SAVOY
LENGTH: 5.62"

422711
222711 Stem Only
GASKET: 895320

20
2-4

Chrome Plated Stem & Esc Tube

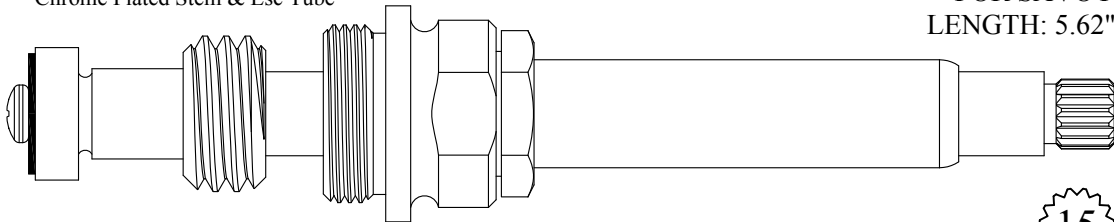

FOR SAVOY
LENGTH: 5.62"

422721
222721 Stem Only
GASKET: 895320

15
1-13

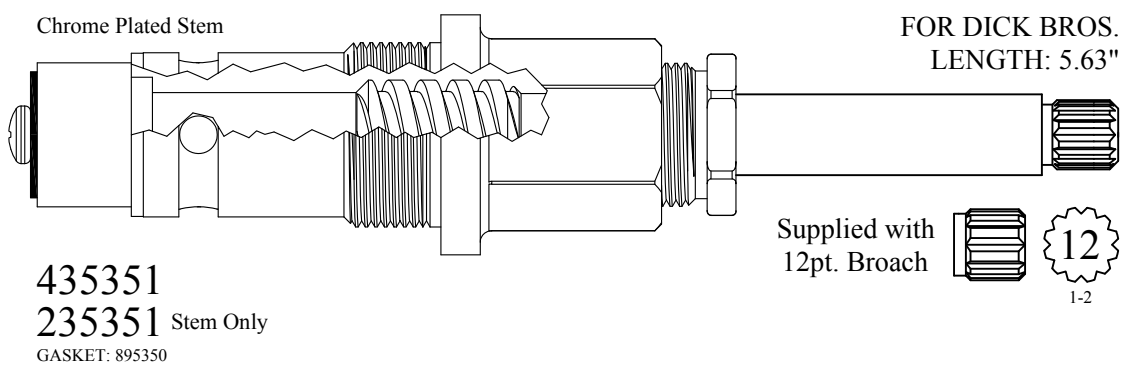
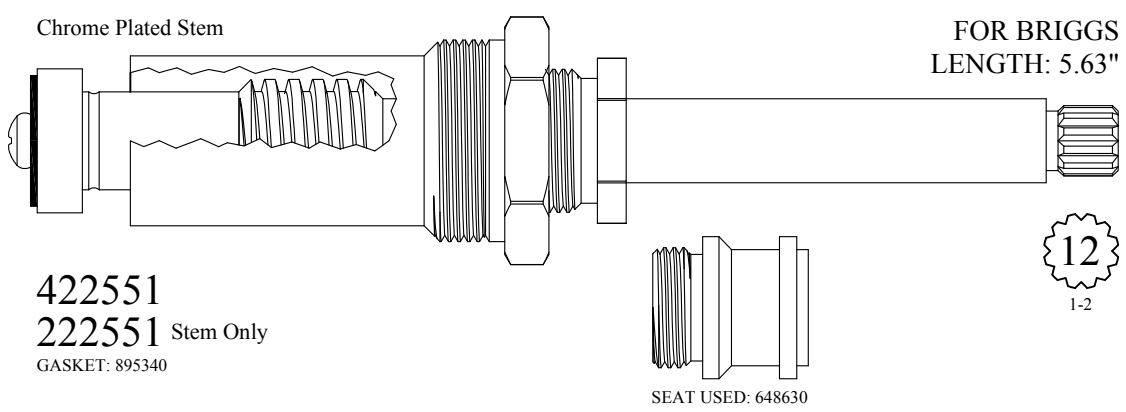
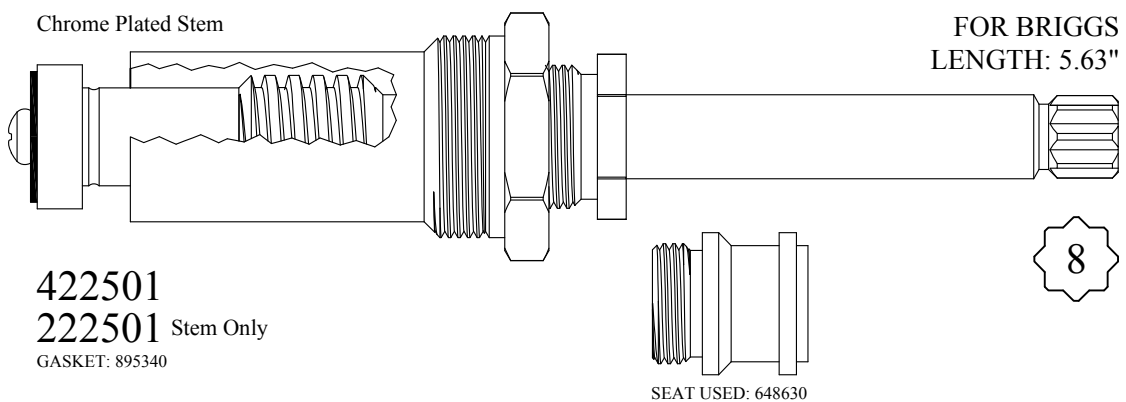
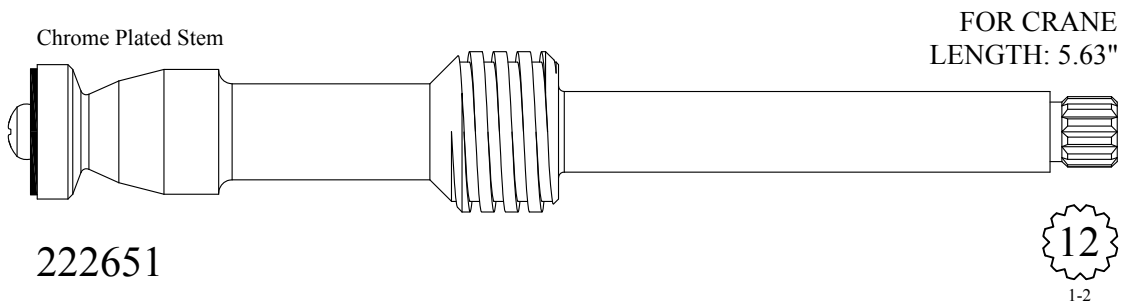

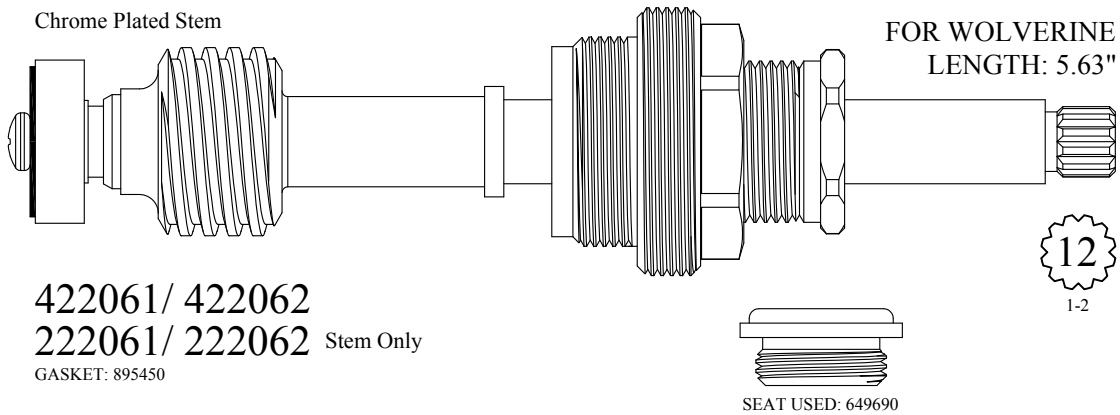
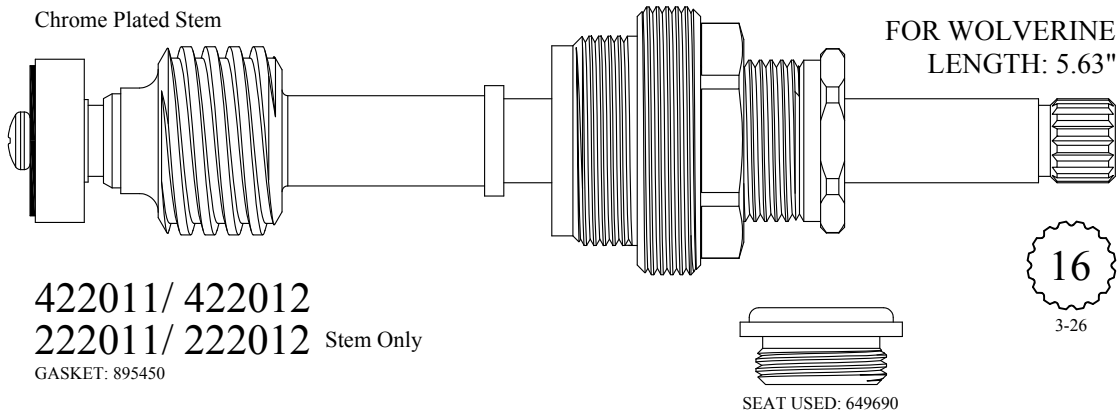
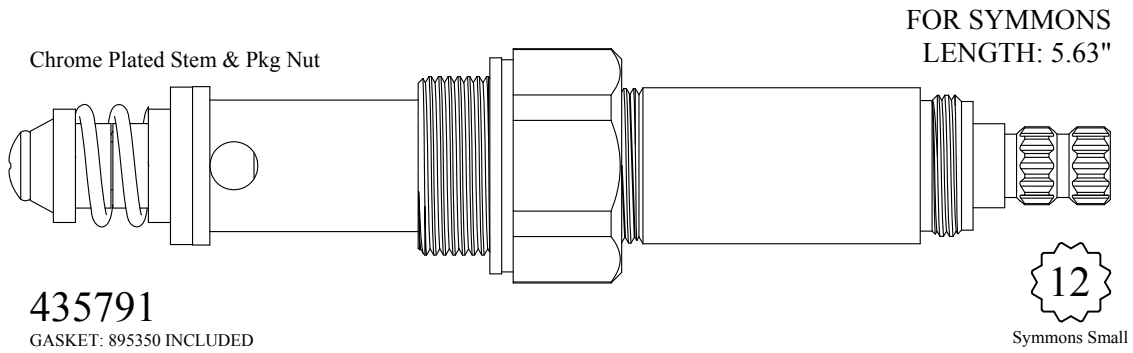
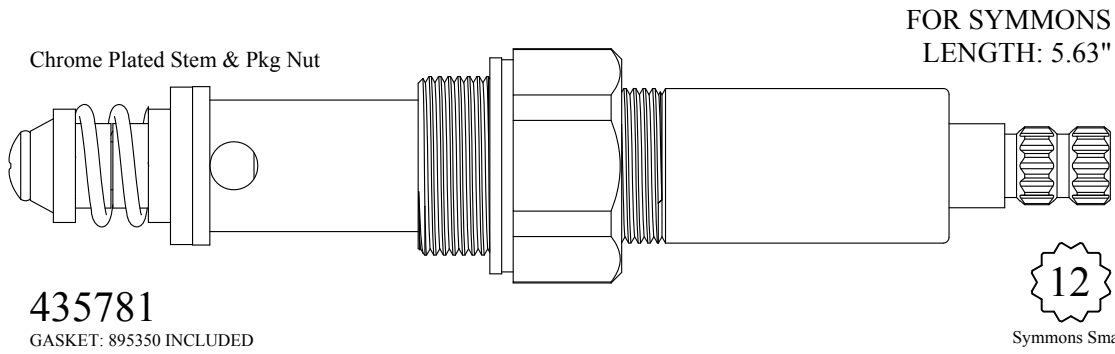

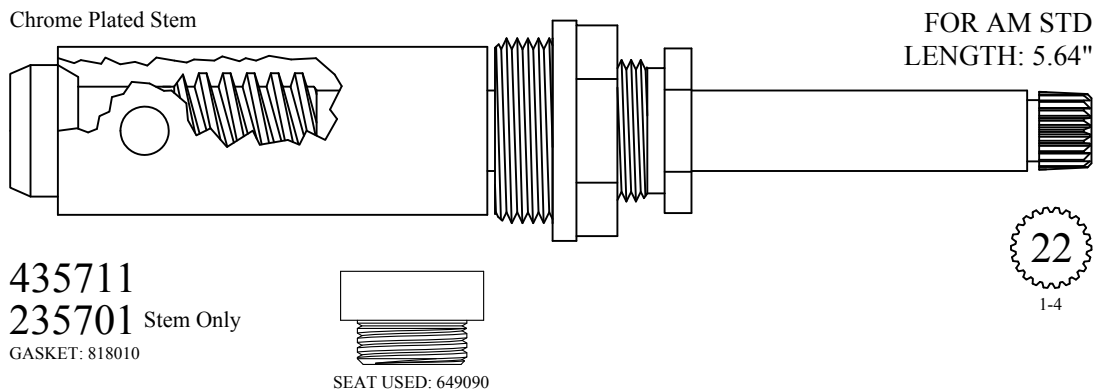
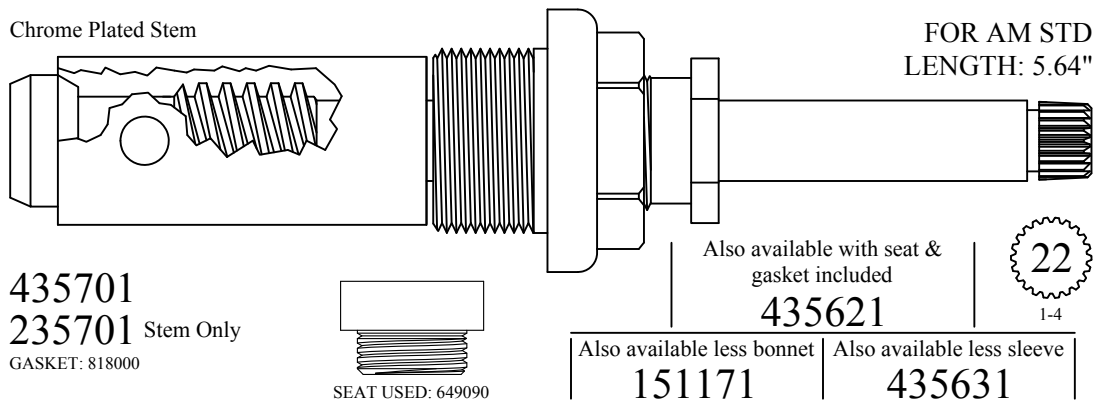
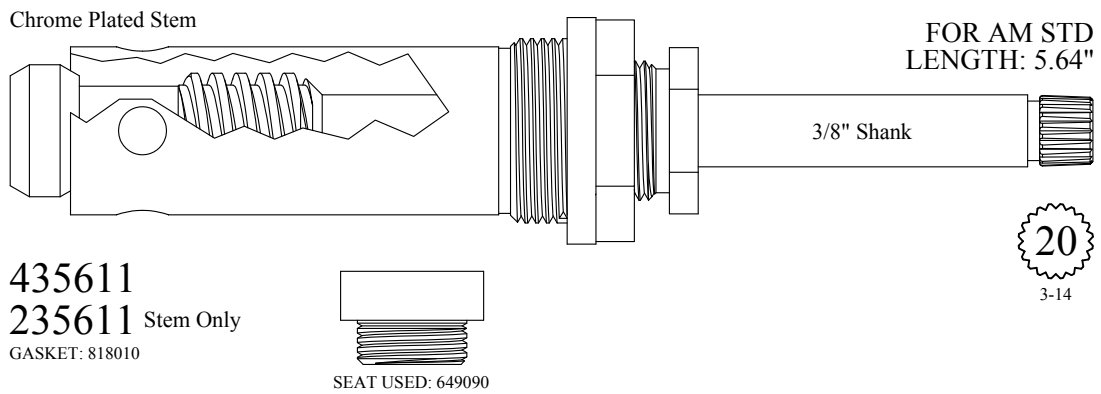
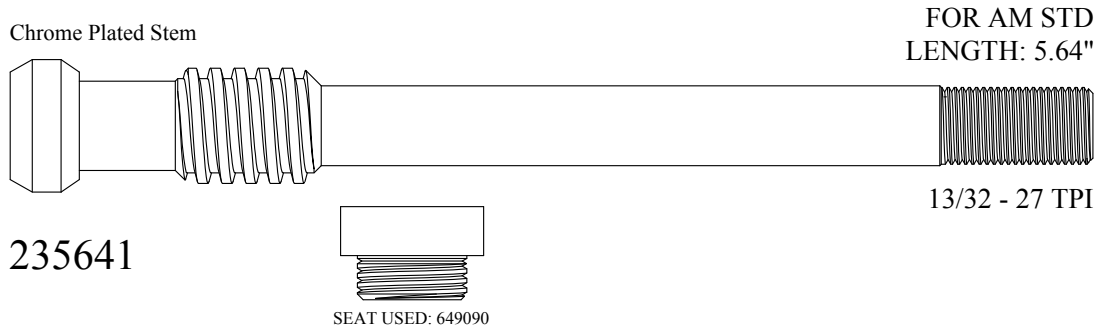

Chrome Plated Stem

FOR AM STD
LENGTH: 5.64"

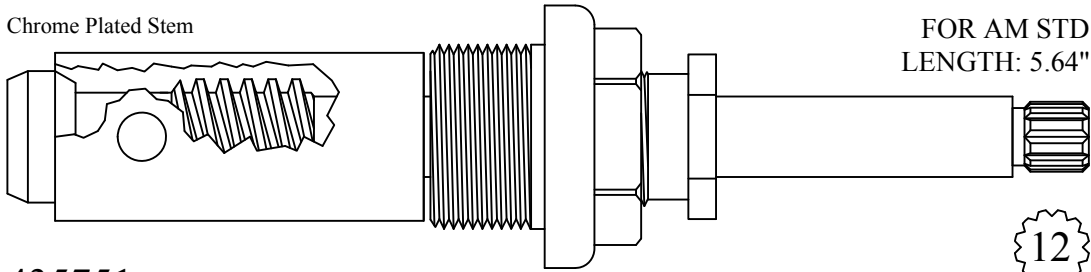

12
1-2

435751
235751 Stem Only
GASKET: 818000

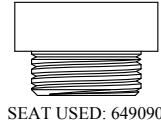

SEAT USED: 649090

Chrome Plated Stem

FOR CRANE
LENGTH: 5.64"

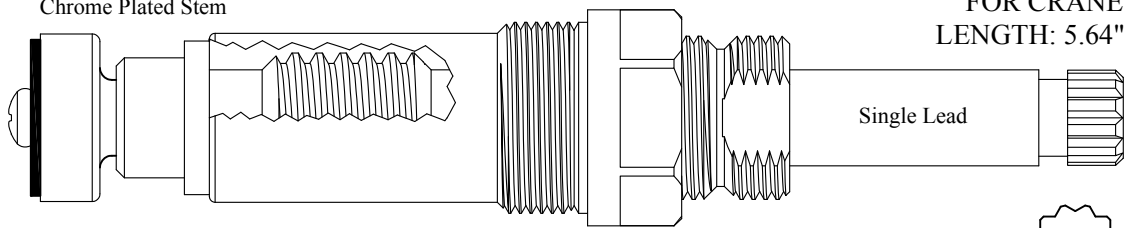

12

LF480101
LF280101 Stem Only
GASKET: 895340



SEAT USED: LF649660

Chrome Plated Stem

FOR CRANE
LENGTH: 5.64"

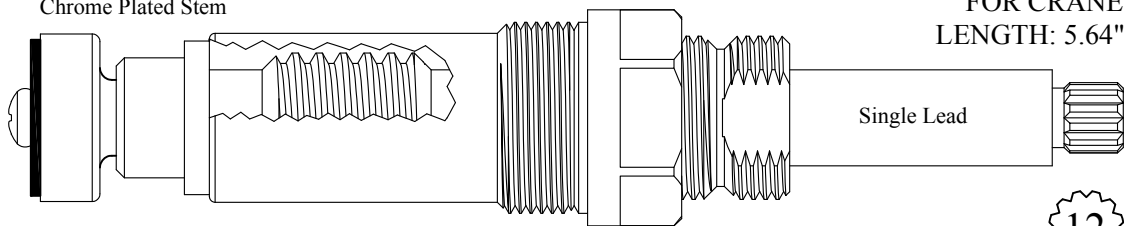

12
1-2

LF480111
LF280111 Stem Only
GASKET: 895340



SEAT USED: LF649660

Chrome Plated Stem

FOR CRANE
LENGTH: 5.64"

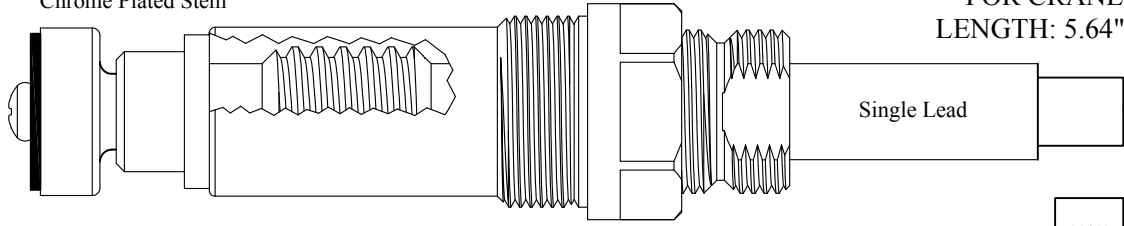

23/64

LF480121
LF280121 Stem Only
GASKET: 895340



SEAT USED: LF649660

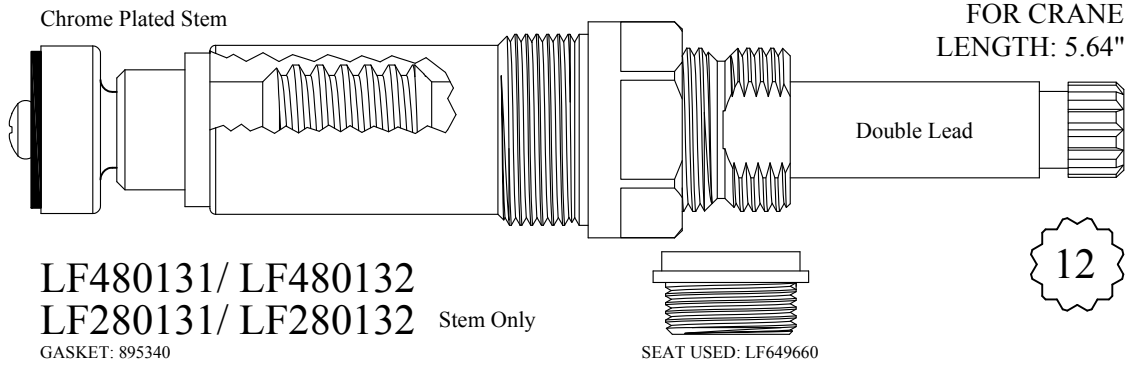

LF480131/ LF480132
 LF280131/ LF280132 Stem Only
 GASKET: 895340

SEAT USED: LF649660

12

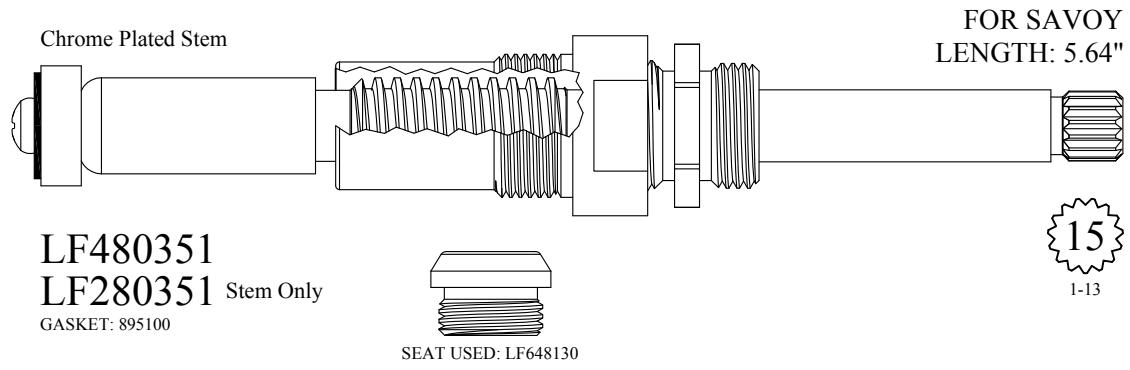

LF480351
 LF280351 Stem Only
 GASKET: 895100

SEAT USED: LF648130

15
 1-13

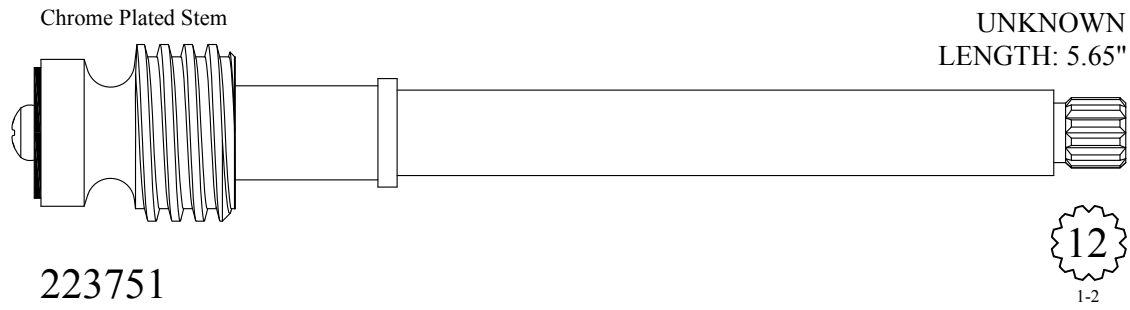

223751

12
 1-2

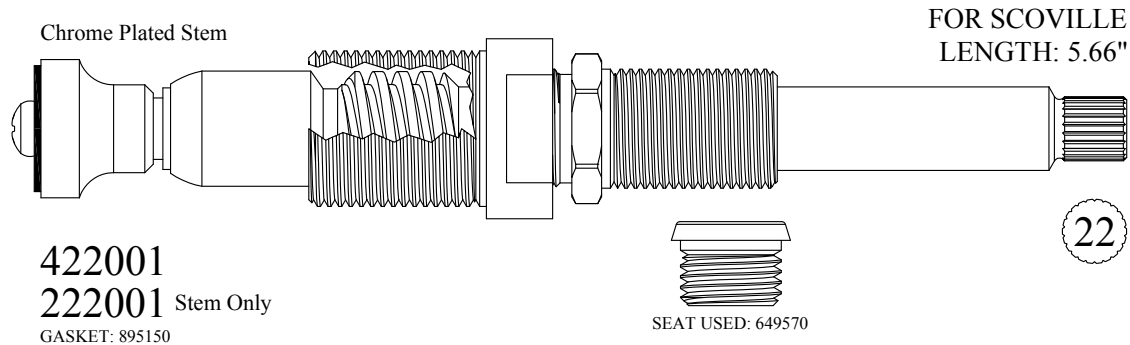

422001
 222001 Stem Only
 GASKET: 895150

SEAT USED: 649570

22

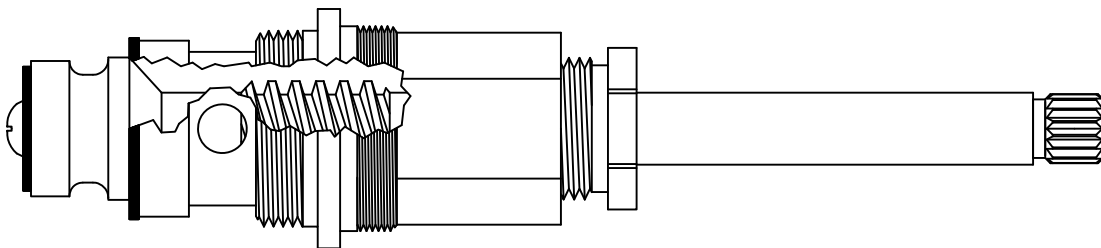
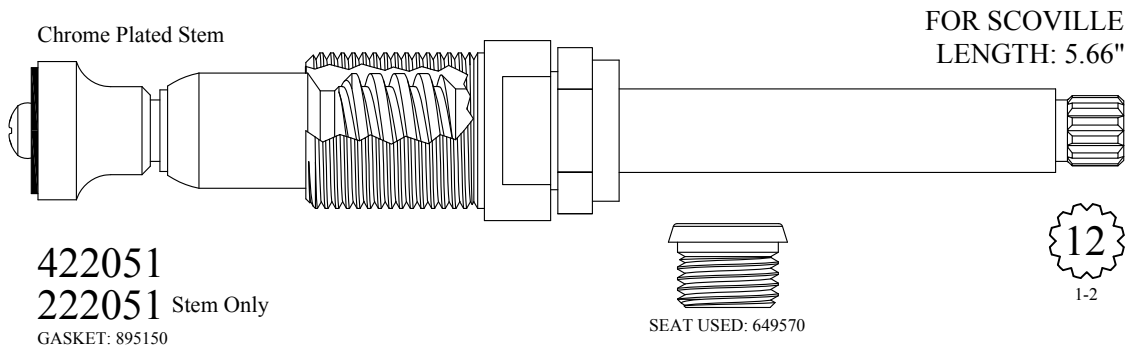
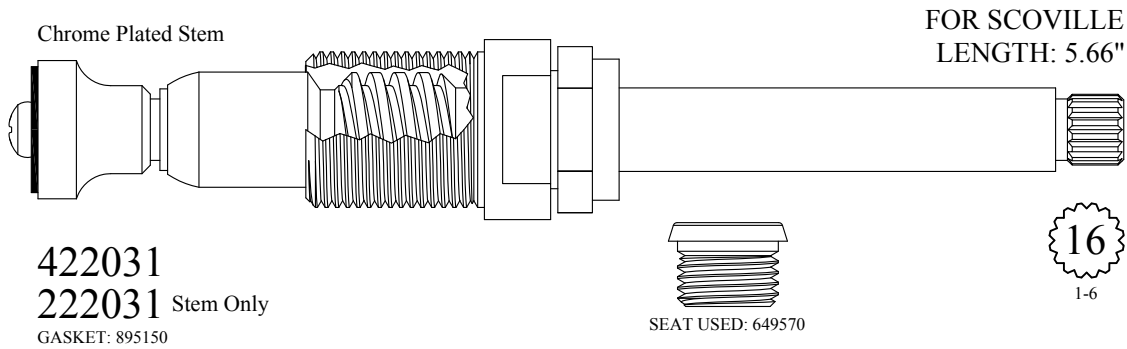

Old Style, Use 433401

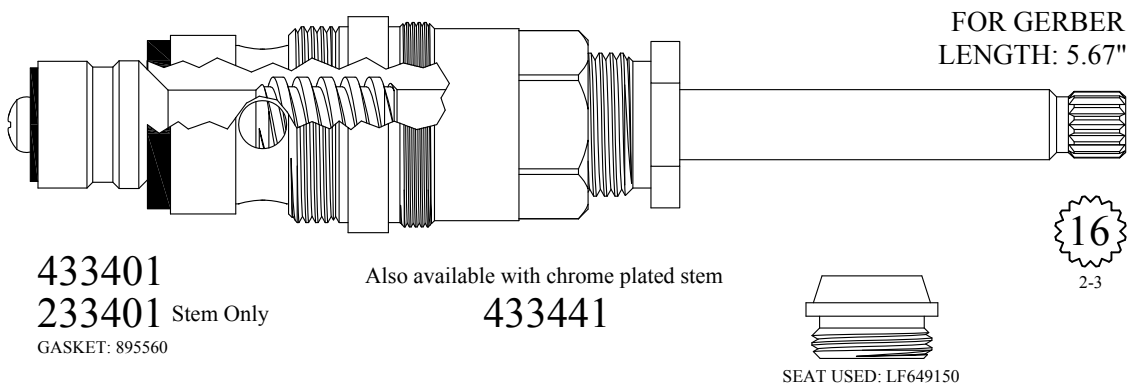

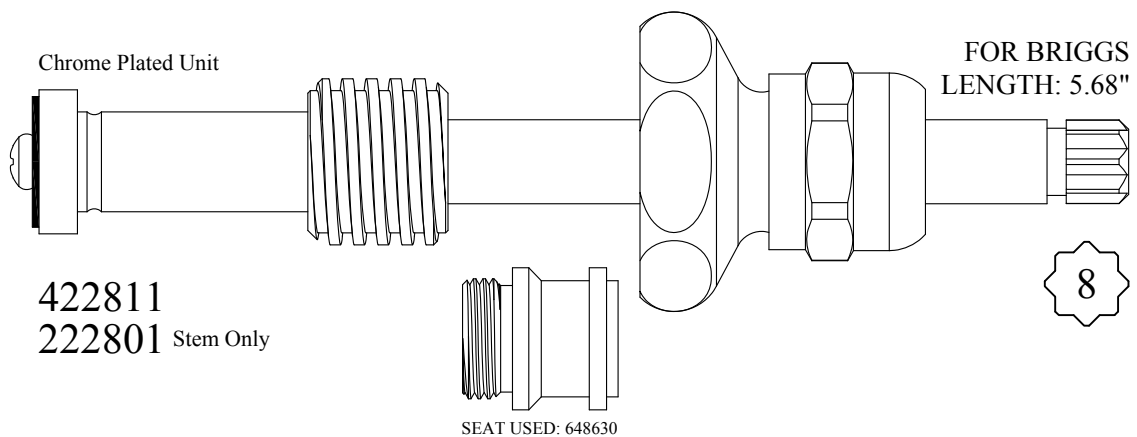
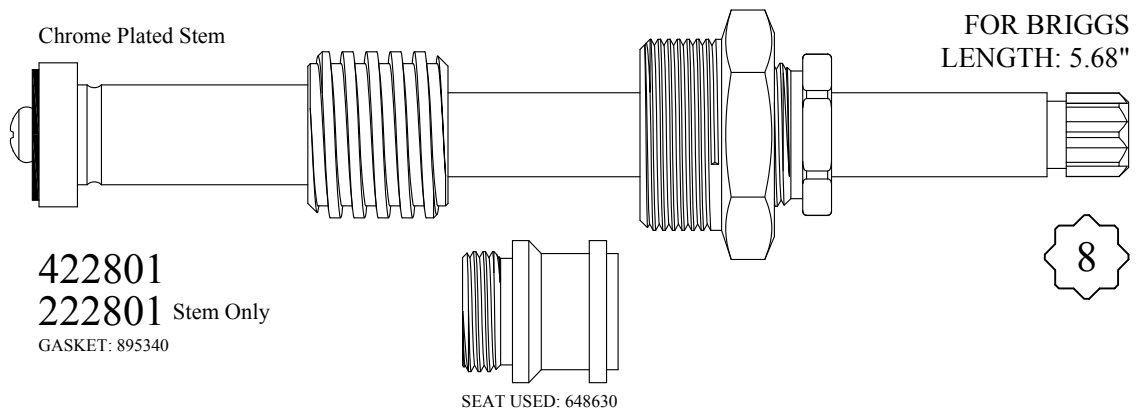
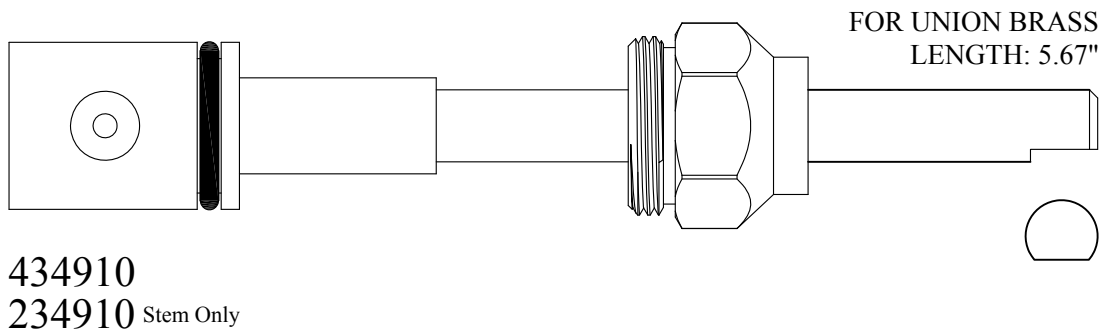
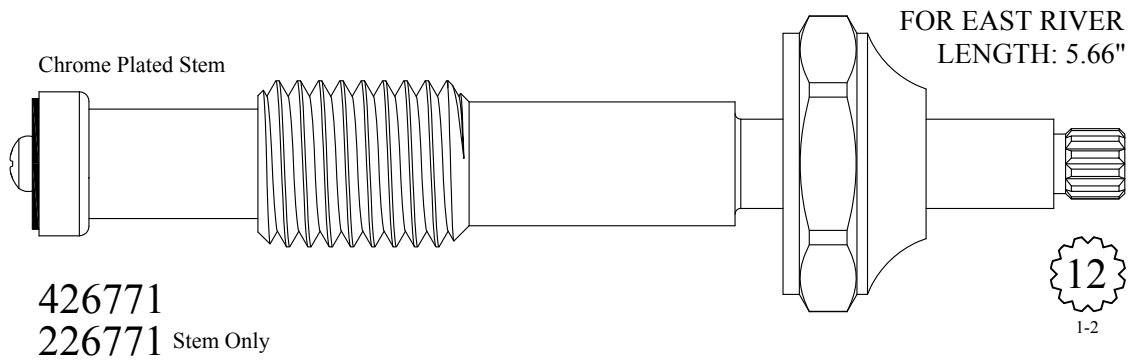

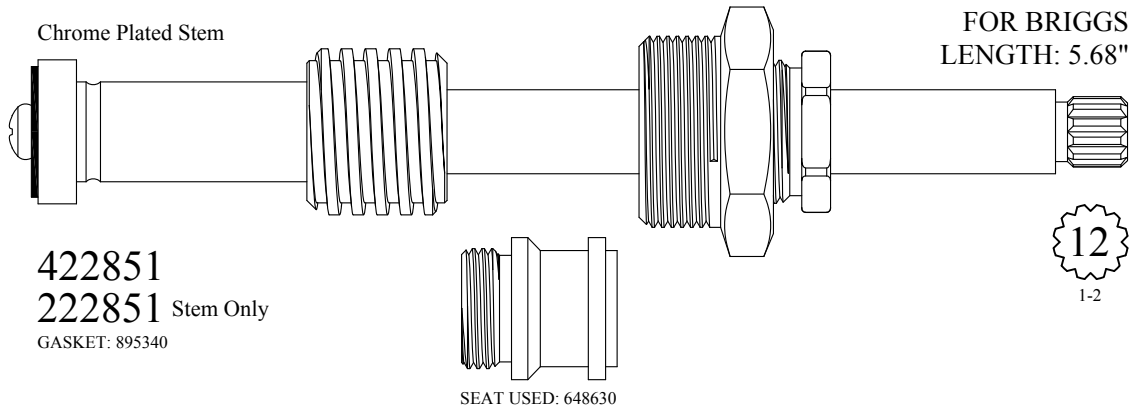

422851
222851 Stem Only
GASKET: 895340

12
1-2

SEAT USED: 648630

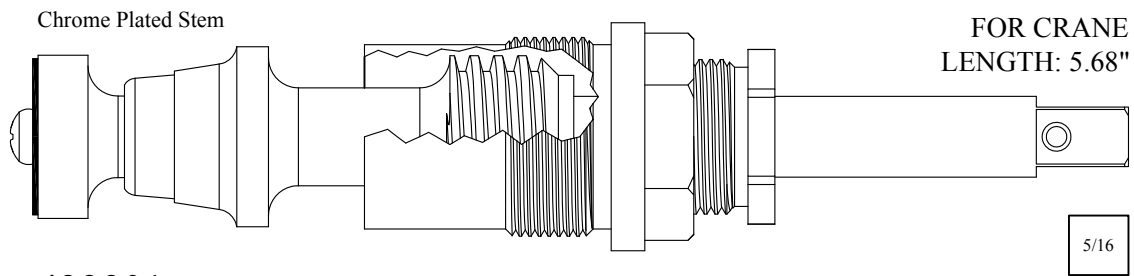

423901
223901 Stem Only
GASKET: 895440

5/16

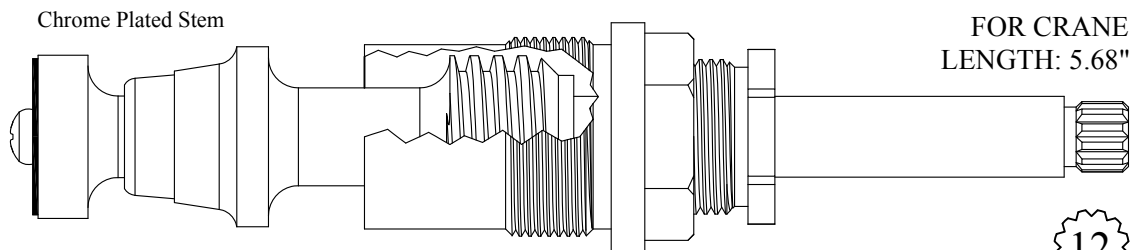

423951
223951 Stem Only
GASKET: 895440

12
1-2

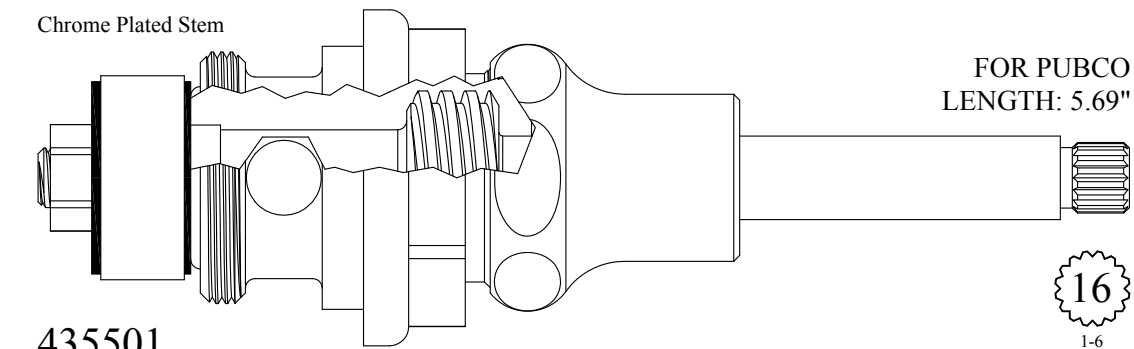

435501
235501 Stem Only
GASKET: 895500

16
1-6

Chrome Plated Stem

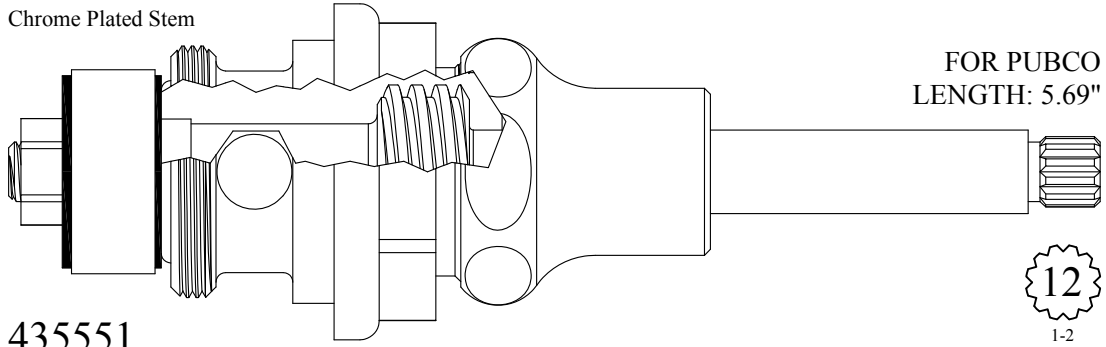

435551
 235551 Stem Only
 GASKET: 895500



Chrome Plated Stem

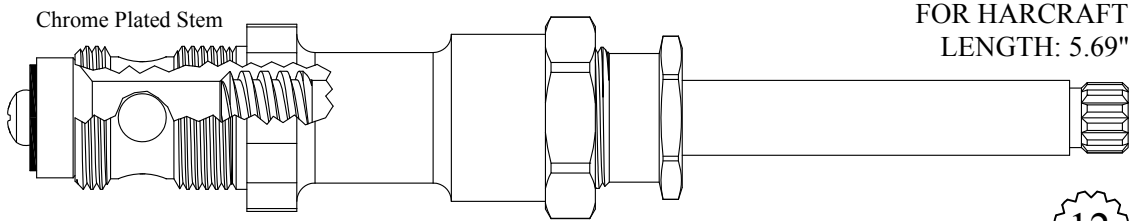



435721
 235721 Stem Only
 GASKET: 895100

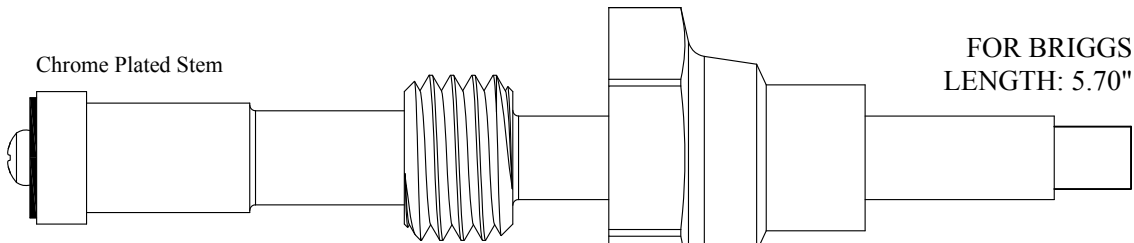

Chrome Plated Stem



417851
 217851 Stem Only

Supplied with
 12pt. Broach  
 1-2

Chrome Plated Stem

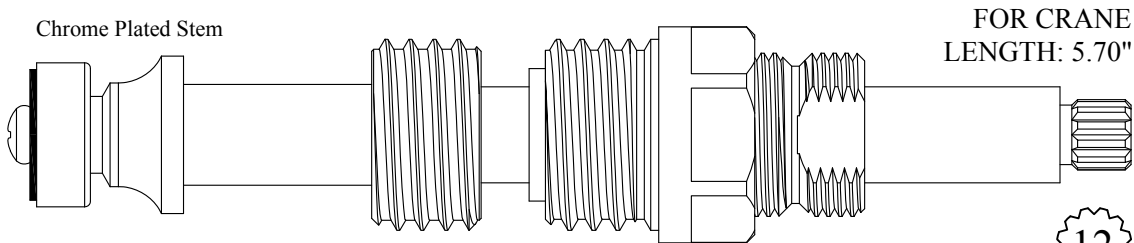

424561
 224561 Stem Only
 GASKET: 895340



Chrome Plated Stem

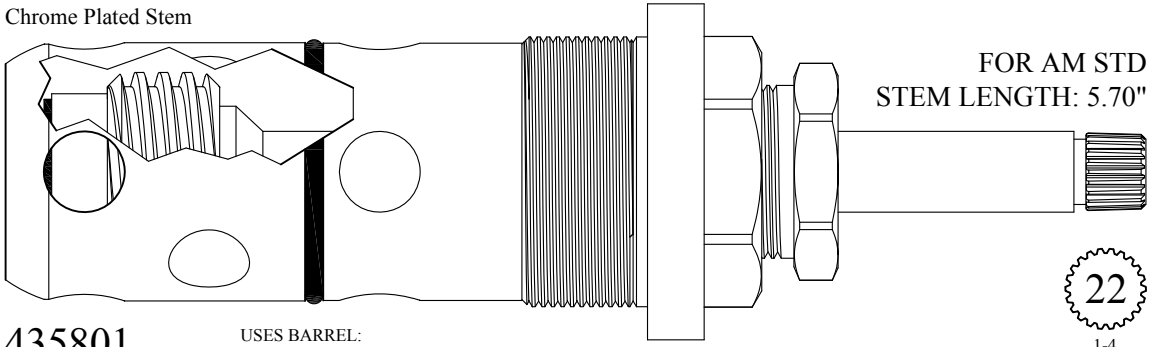

FOR AM STD
STEM LENGTH: 5.70"

435801
235801 Stem Only

USES BARREL:
635801



Chrome Plated Stem

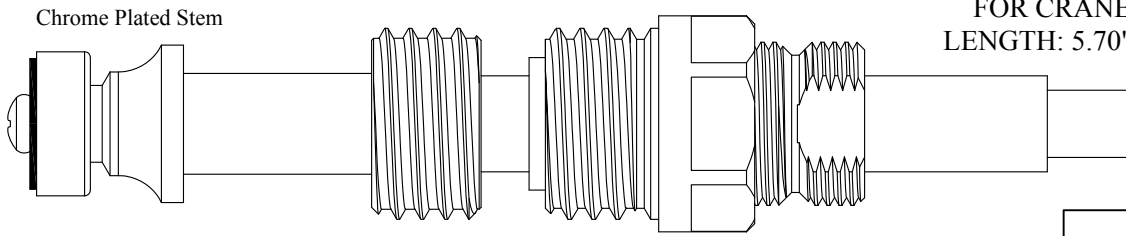

FOR CRANE
LENGTH: 5.70"

424511/ 424512
224511/ 224512 Stem Only
GASKET: 895340



Chrome Plated Stem

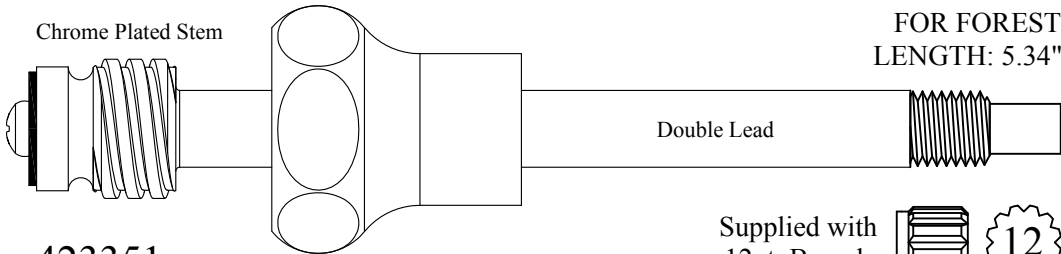

FOR FOREST
LENGTH: 5.34"

Double Lead

423351
223351 Stem Only

Supplied with
12pt. Broach

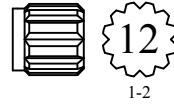

Chrome Plated Stem

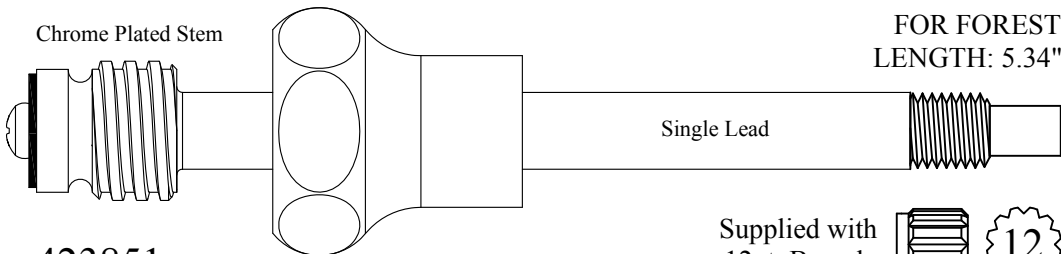

FOR FOREST
LENGTH: 5.34"

Single Lead

423851
223851 Stem Only

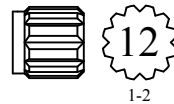

Supplied with
12pt. Broach

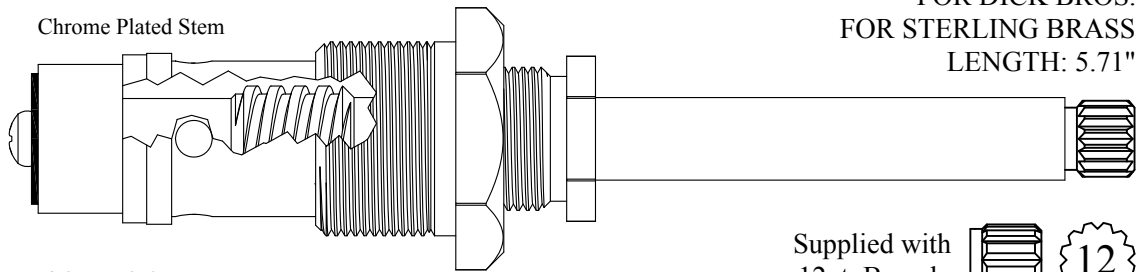



FOR DICK BROS.
FOR STERLING BRASS
LENGTH: 5.71"

435732
235732 Stem Only
GASKET: 895430

Supplied with
12pt. Broach  
1-2

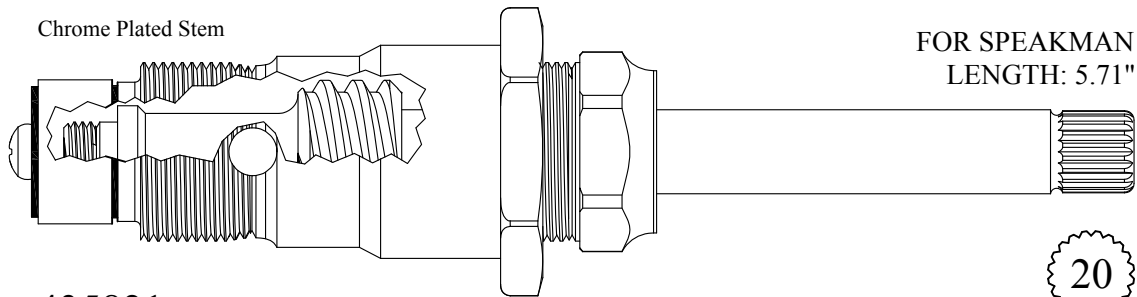

FOR SPEAKMAN
LENGTH: 5.71"

435821
235821 Stem Only
GASKET: 895450

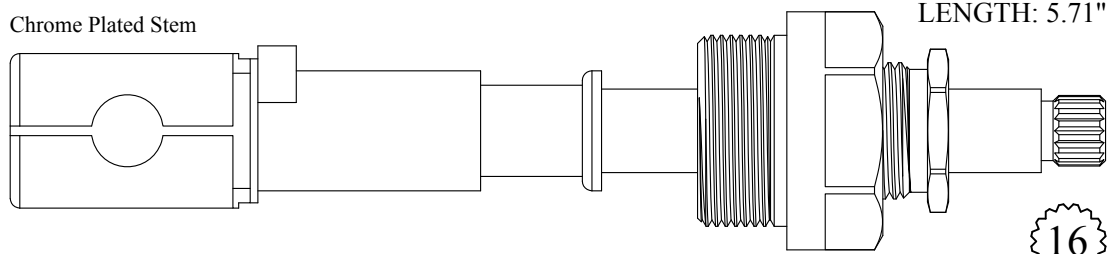

2-4



FOR CENTRAL
LENGTH: 5.71"

437410
237410 Stem Only
GASKET: 895550

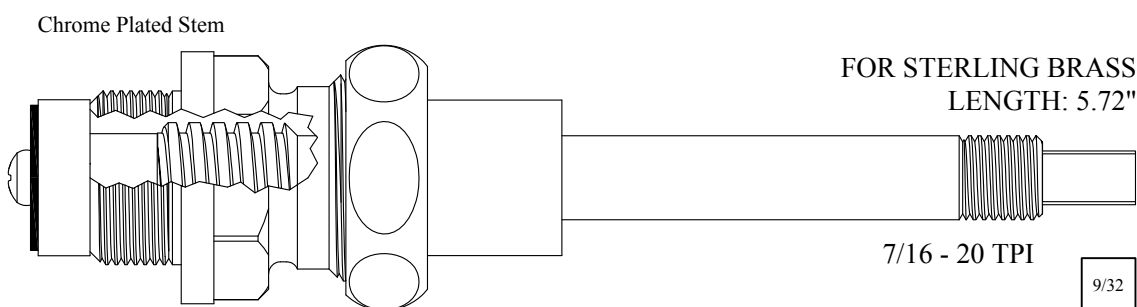
1-6



FOR STERLING BRASS
LENGTH: 5.72"

425401
225401 Stem Only
GASKET: 895370

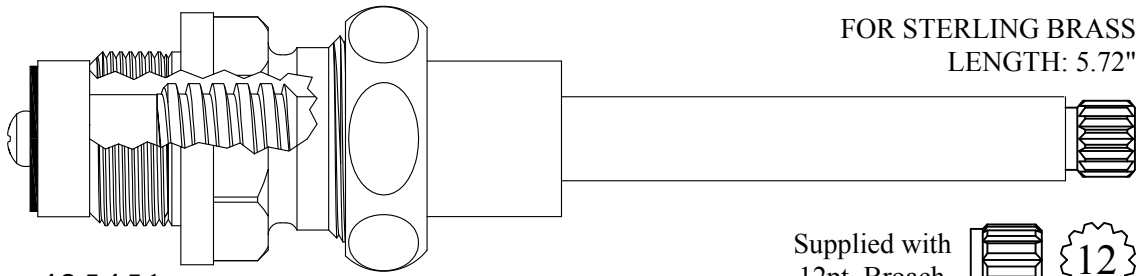

7/16 - 20 TPI 

Chrome Plated Stem



FOR STERLING BRASS
LENGTH: 5.72"

425451
225451 Stem Only
GASKET: 895370

Supplied with
12pt. Broach  
1-2

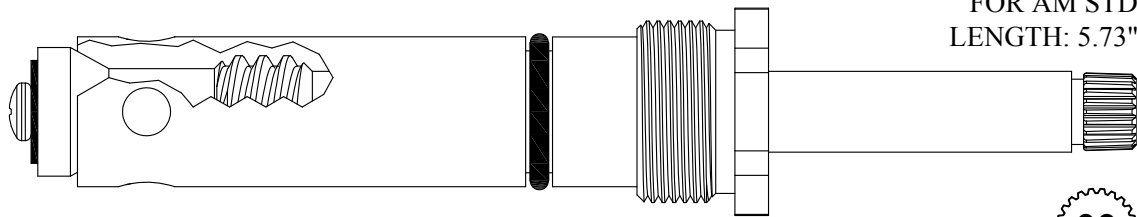

FOR AM STD
LENGTH: 5.73"

435312
235312 Stem Only

1-4

SEAT USED: LF648220

Chrome Plated Stem

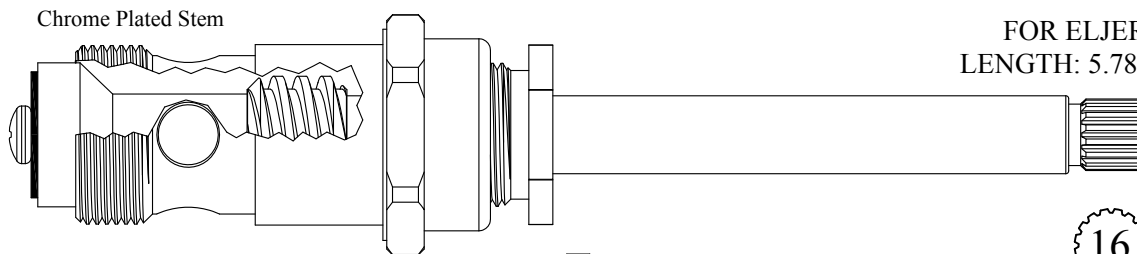

FOR ELJER
LENGTH: 5.78"

435811
235811 Stem Only
GASKET: 895350

3-15

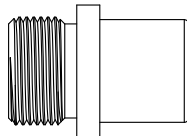

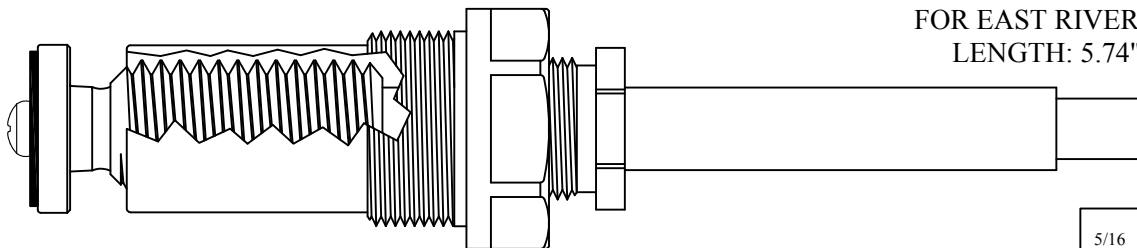
SEAT USED: LF649640



FOR EAST RIVER
LENGTH: 5.74"

427211
227211 Stem Only
GASKET: 895540

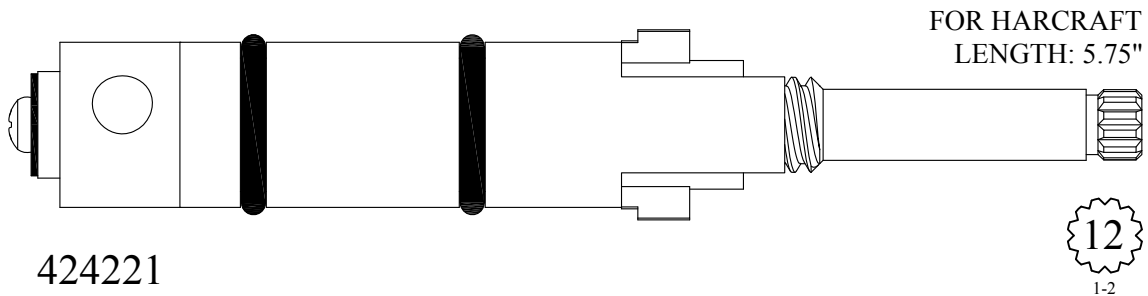
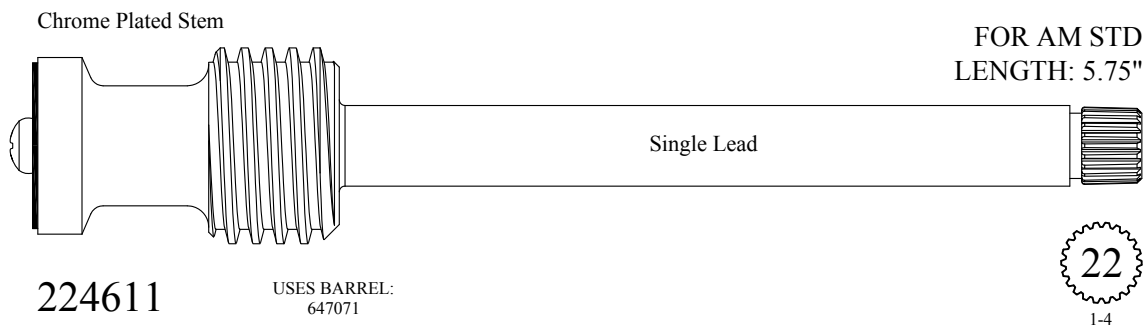
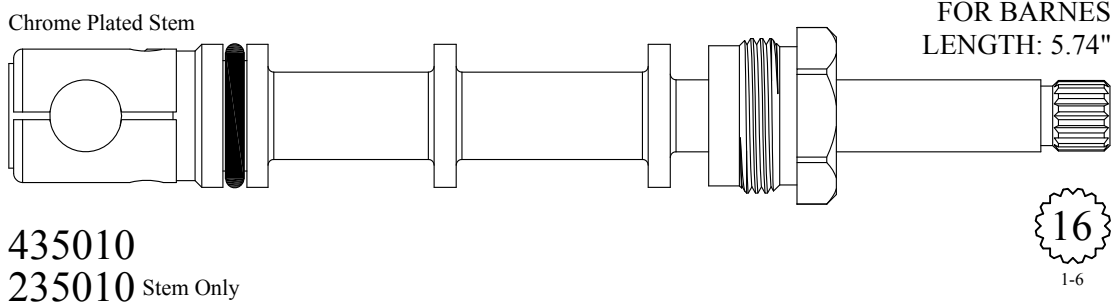
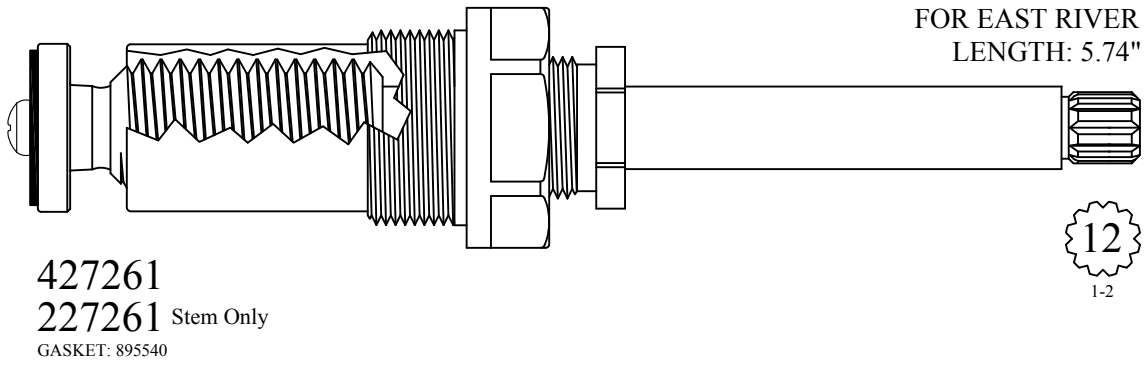



Chrome Plated Stem

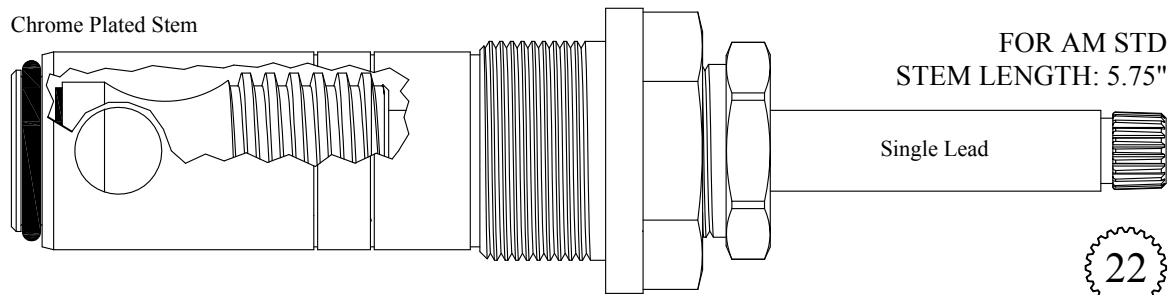

FOR AM STD
STEM LENGTH: 5.75"

Single Lead



424601

USES BARREL:
647051

224601 Stem Only

GASKET: 824600

Also available less barrel

424631

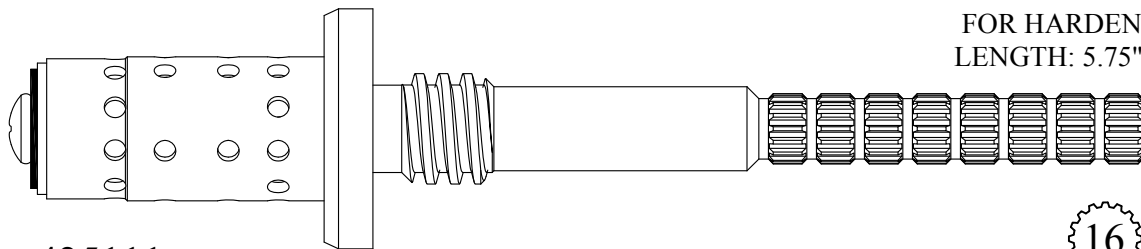

FOR HARDEN
LENGTH: 5.75"



425111

225111 Stem Only

GASKET: 895500

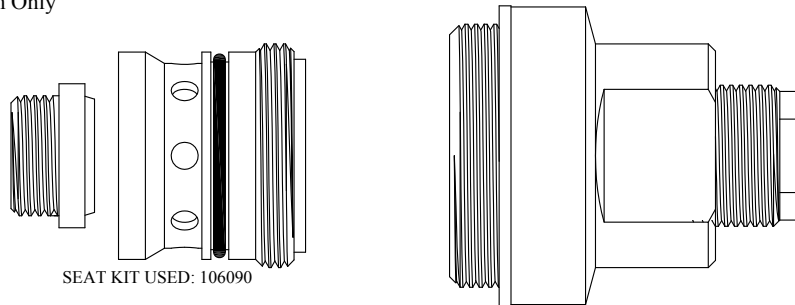

SEAT KIT USED: 106090

Chrome Plated Stem

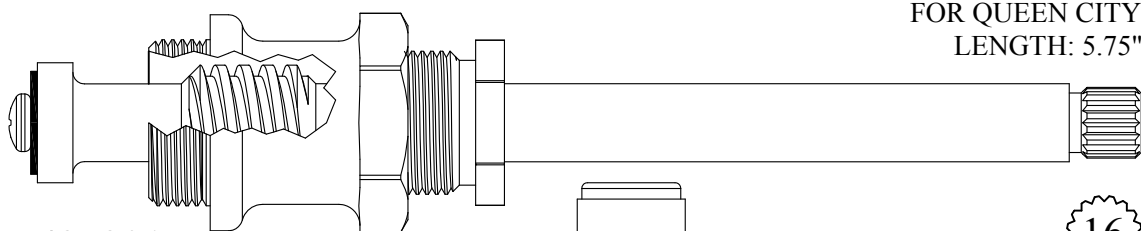

FOR QUEEN CITY
LENGTH: 5.75"



425201

225201 Stem Only

GASKET: 895400

SEAT USED: 649840

Chrome Plated Stem

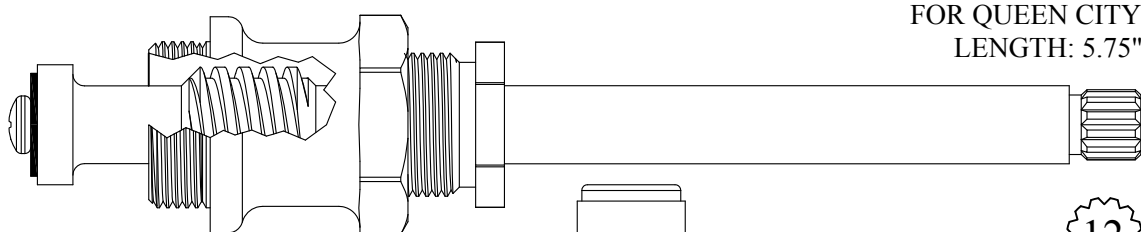

FOR QUEEN CITY
LENGTH: 5.75"



425251

225251 Stem Only

GASKET: 895400

SEAT USED: 649840

FOR HOT & COLD STEM USE PRICE PFISTER 421601/421602

Chrome Plated Stem

FOR CALIFORNIA BRASS
LENGTH: 5.75"

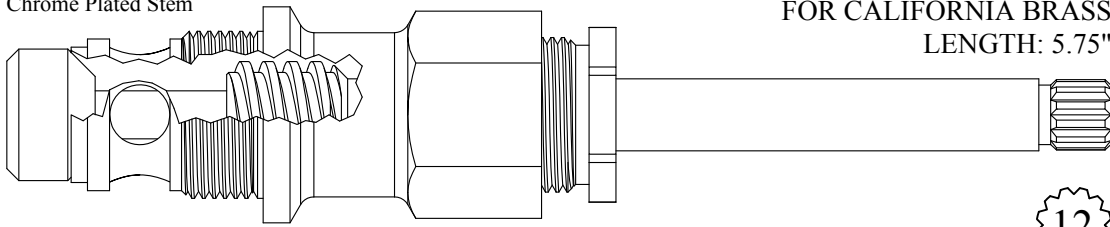

434801

234801 Stem Only

GASKET: 895400

12
1-2

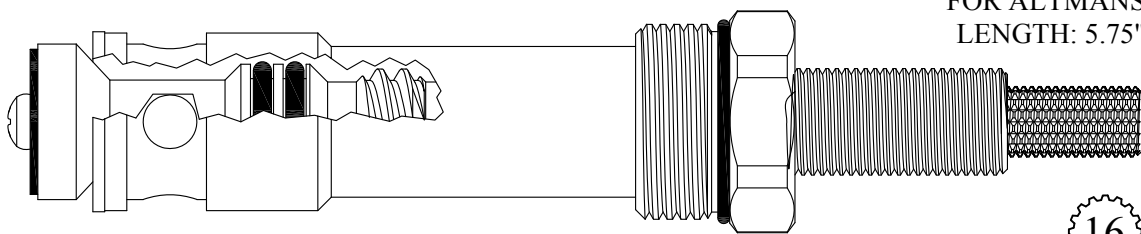

FOR ALTMANS
LENGTH: 5.75"

435841

GASKET: 890210 O-RING INCLUDED

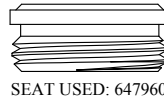

SEAT USED: 647960

16
3-16

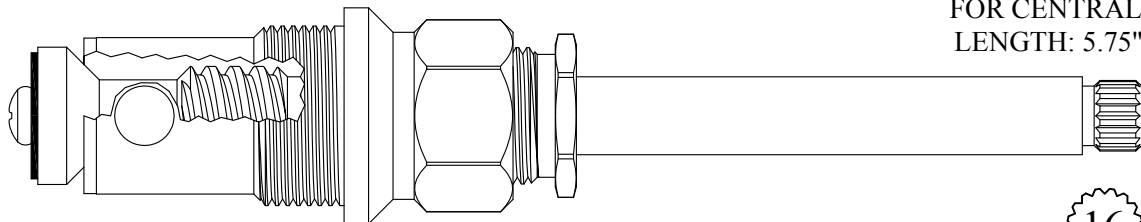

FOR CENTRAL
LENGTH: 5.75"

436101

236101 Stem Only

GASKET: 895370



SEAT USED: 648970

16
1-6

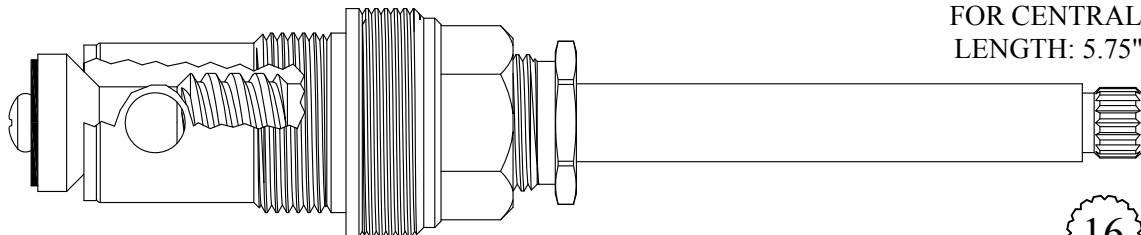

FOR CENTRAL
LENGTH: 5.75"

436111

236101 Stem Only

GASKET: 895370



SEAT USED: 648970

16
1-6

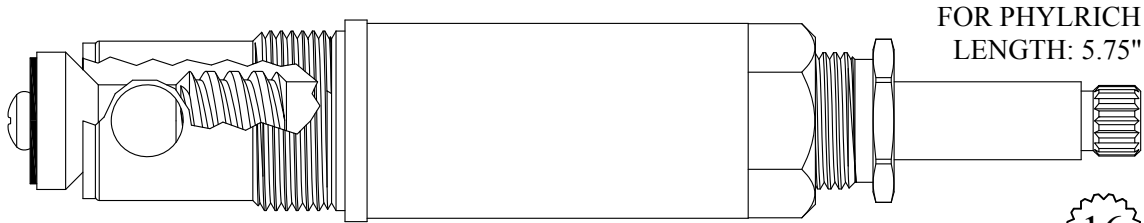

FOR PHYLRICH
LENGTH: 5.75"

436131
236101 Stem Only
GASKET: 895370



SEAT USED: 648970

16
1-6

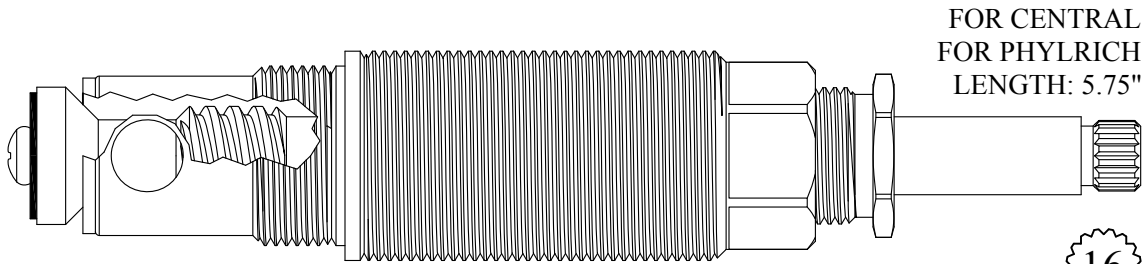

FOR CENTRAL
FOR PHYLRICH
LENGTH: 5.75"

436141
236101 Stem Only
GASKET: 895370

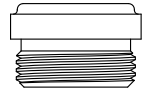

SEAT USED: 648970

16
1-6

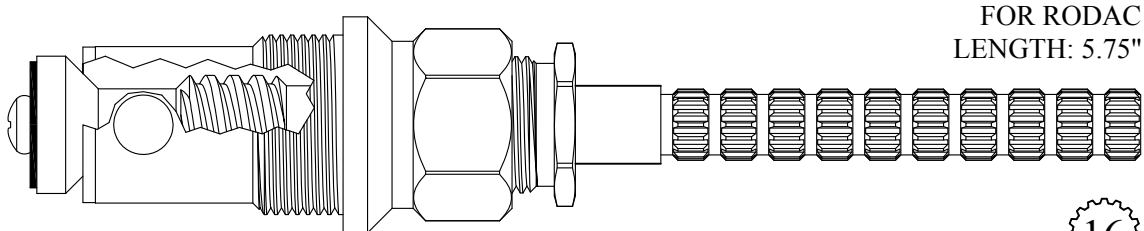

FOR RODAC
LENGTH: 5.75"

436151
236151 Stem Only
GASKET: 895370



SEAT USED: 648970

16
3-16

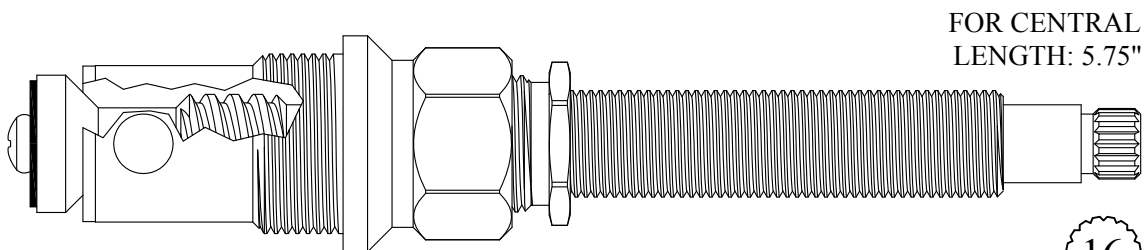

FOR CENTRAL
LENGTH: 5.75"

436161
236101 Stem Only
GASKET: 895370

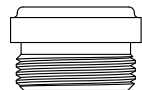

SEAT USED: 648970

16
1-6

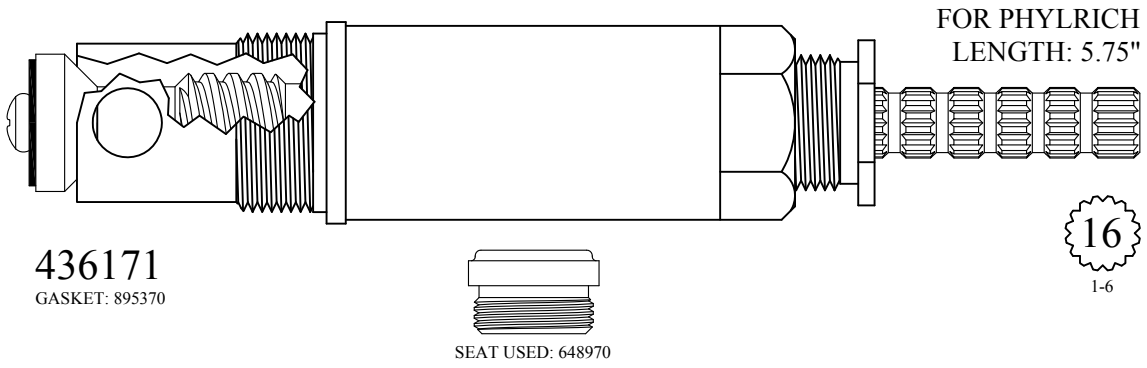

436171
GASKET: 895370

SEAT USED: 648970

16
1-6

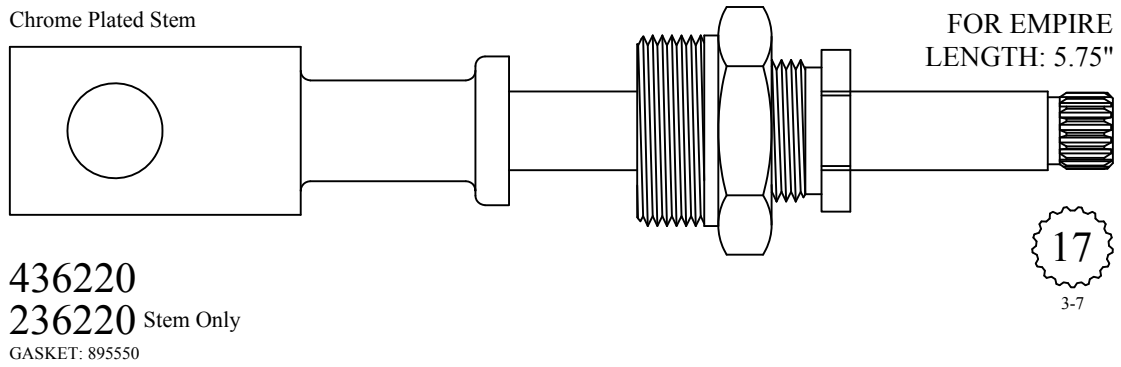

436220
236220 Stem Only
GASKET: 895550

17
3-7

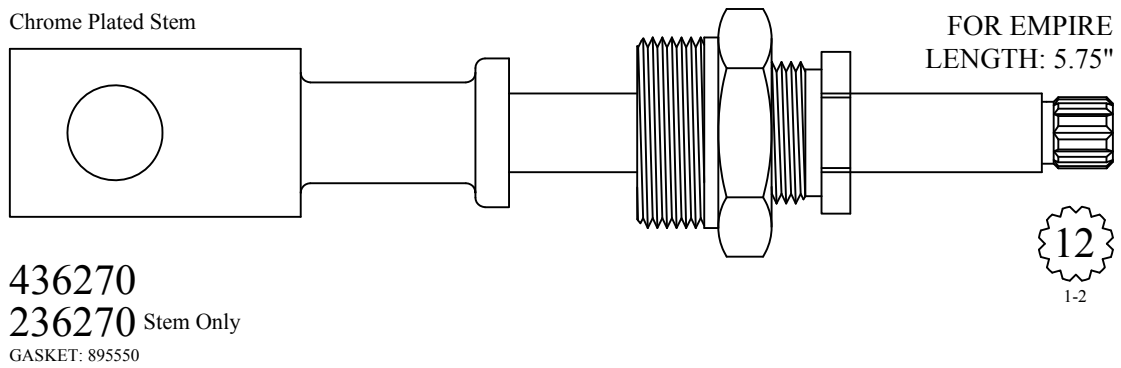

436270
236270 Stem Only
GASKET: 895550

12
1-2

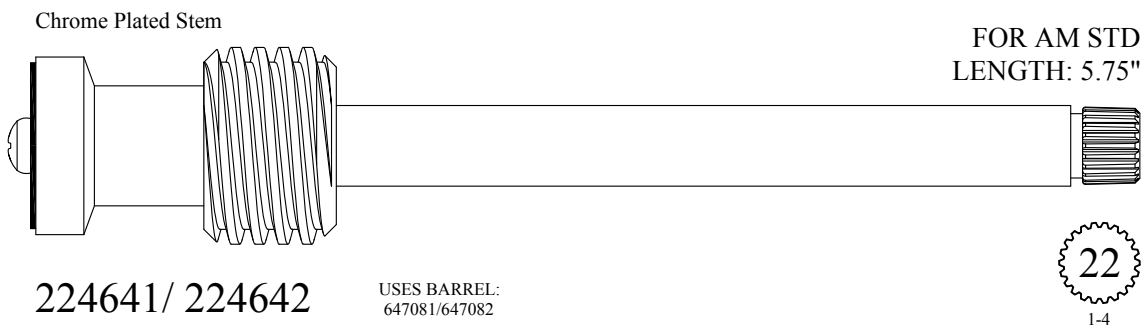

224641/ 224642

USES BARREL:
647081/647082

22
1-4

Chrome Plated Stem

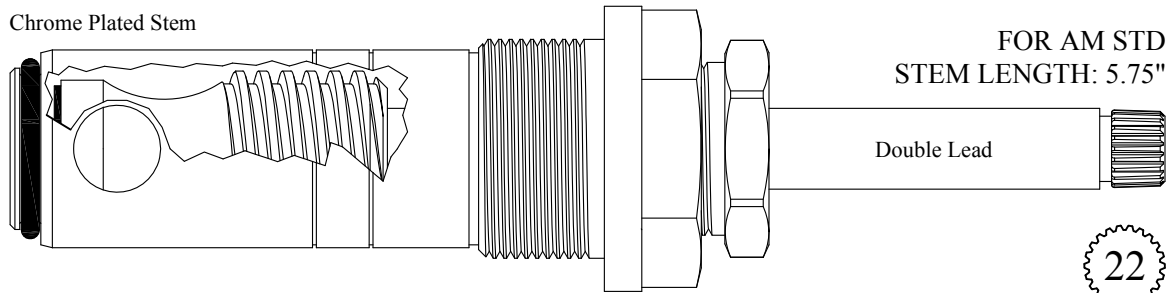

FOR AM STD
STEM LENGTH: 5.75"

Double Lead



1-4

424621/ 424622

USES BARREL:
647061 / 647062

224621/ 224622 Stem Only

GASKET: 824600

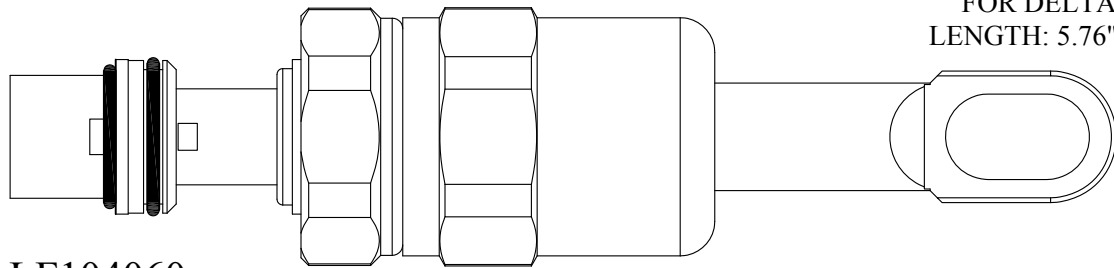

FOR DELTA
LENGTH: 5.76"

LF104060

Chrome Plated Stem

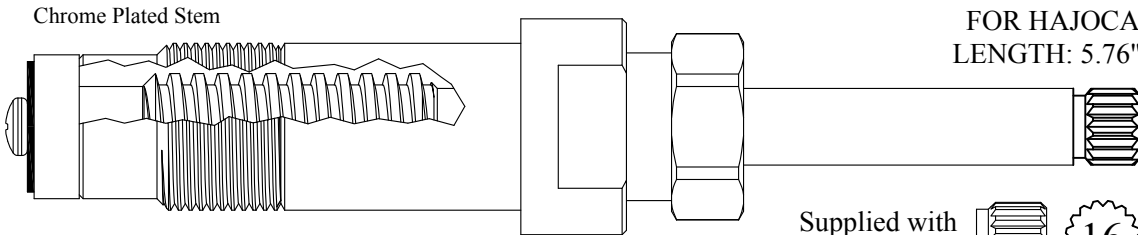

FOR HAJOCA
LENGTH: 5.76"

Supplied with
12pt. Broach



1-6

422021

222021 Stem Only

GASKET: 895400

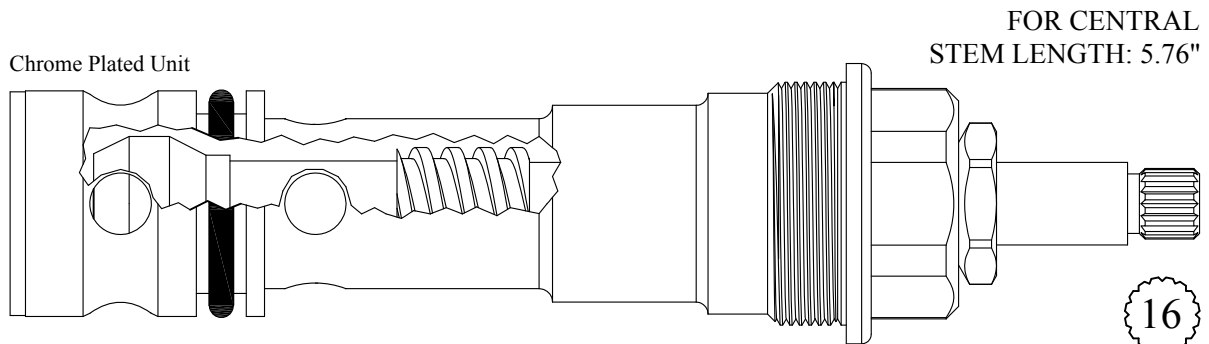

FOR CENTRAL
STEM LENGTH: 5.76"

Chrome Plated Unit



1-6

438671

238741 Stem Only

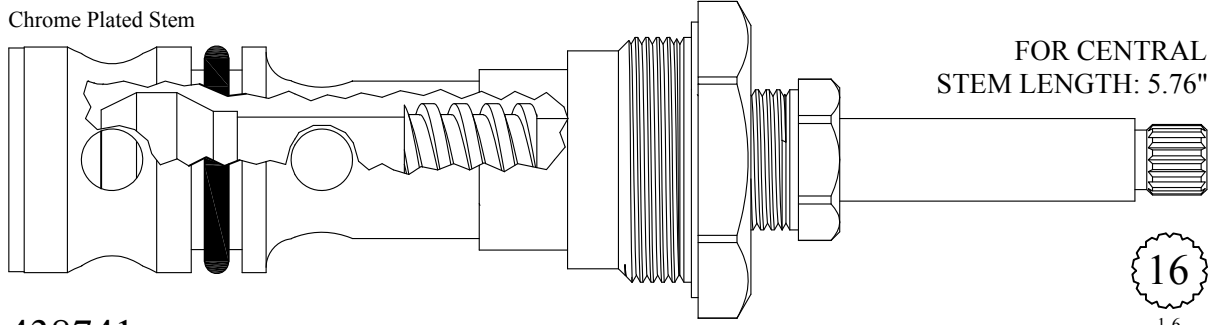

438741
238741 Stem Only

16
1-6

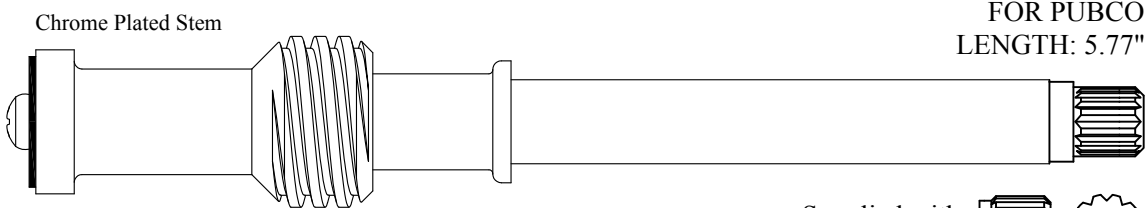

225361

Supplied with
12pt. Broach  12
1-2

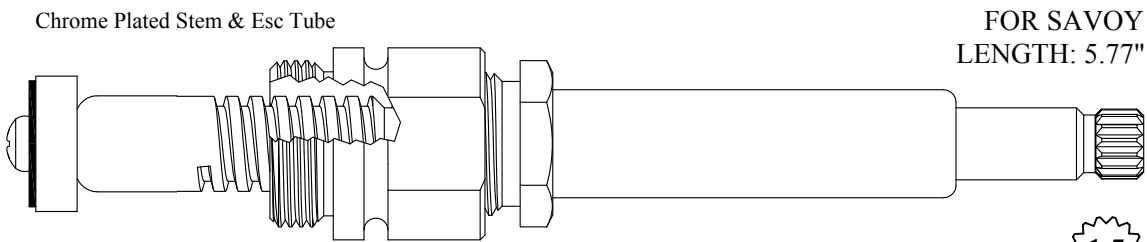

423211
223411 Stem Only
GASKET: 895400



15
1-13

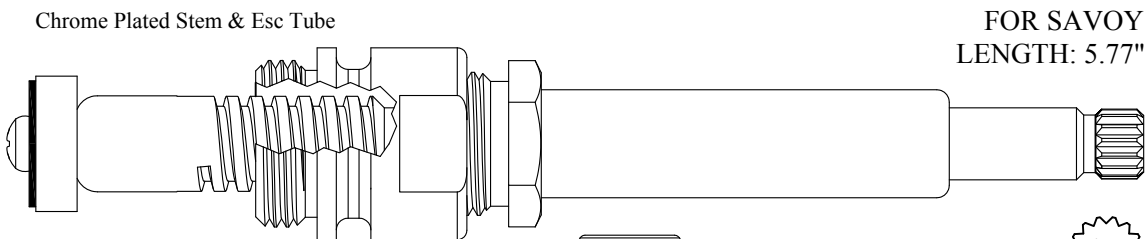

423411
223411 Stem Only
GASKET: 895400



15
1-13

Chrome Plated Stem

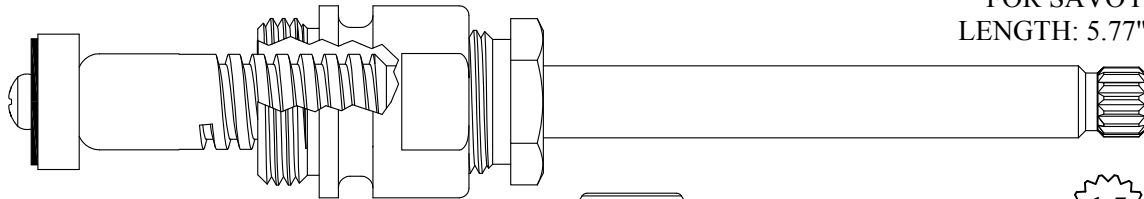

FOR SAVOY
LENGTH: 5.77"

423411-LT
223411 Stem Only
GASKET: 895400



15
1-13

Chrome Plated Stem & Esc Tube

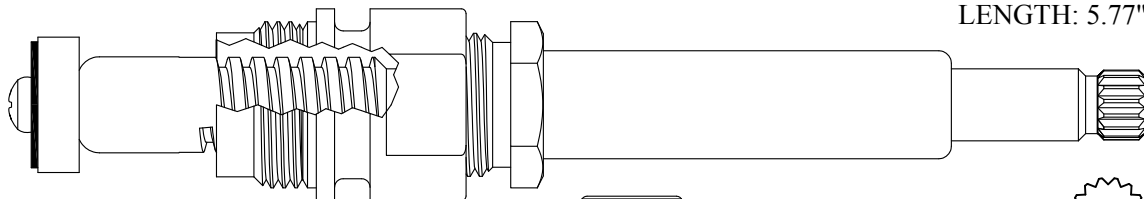

FOR SAVOY
LENGTH: 5.77"

423511
223411 Stem Only
GASKET: 895400



15
1-13

Chrome Plated Stem & Esc Holder

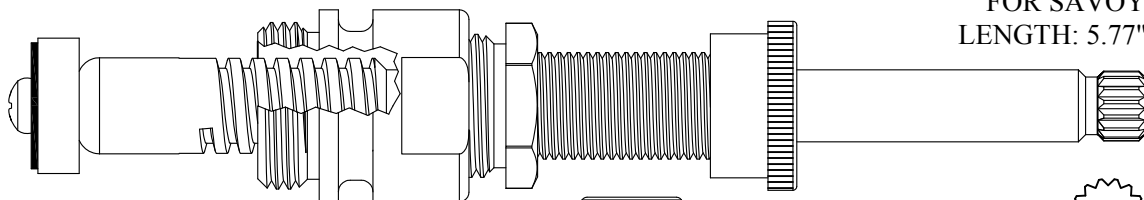

FOR SAVOY
LENGTH: 5.77"

423521
223411 Stem Only
GASKET: 895400



15
1-13

Chrome Plated Stem & Esc Tube

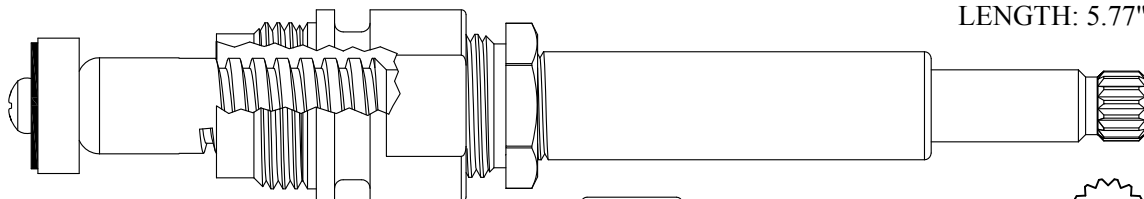

FOR SAVOY
LENGTH: 5.77"

423541
223411 Stem Only
GASKET: 895400



15
1-13

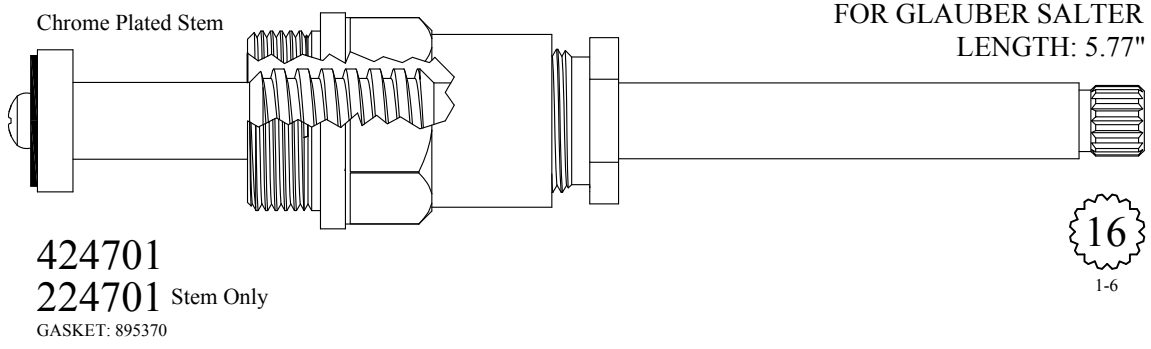

424701
 224701 Stem Only
 GASKET: 895370

16
 1-6

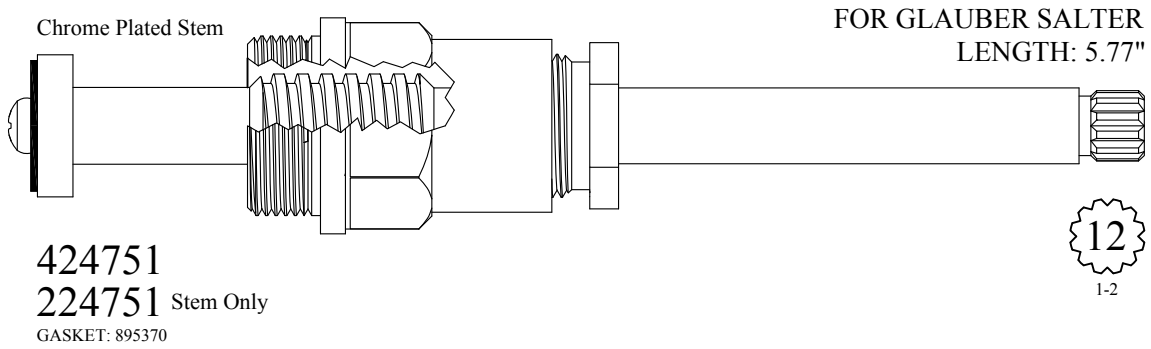

424751
 224751 Stem Only
 GASKET: 895370

12
 1-2

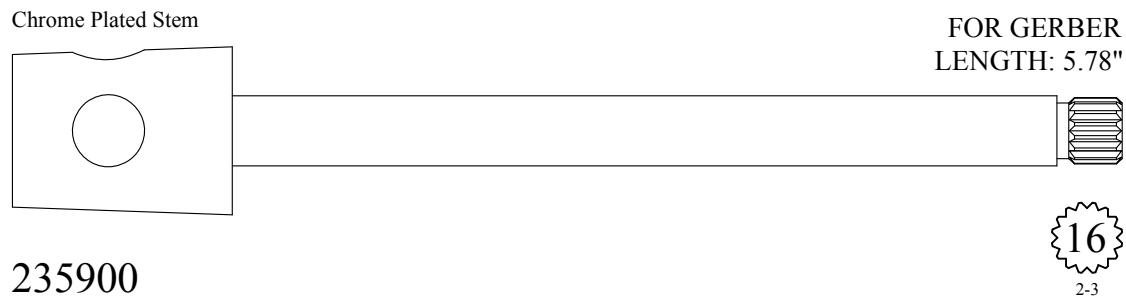

235900

16
 2-3

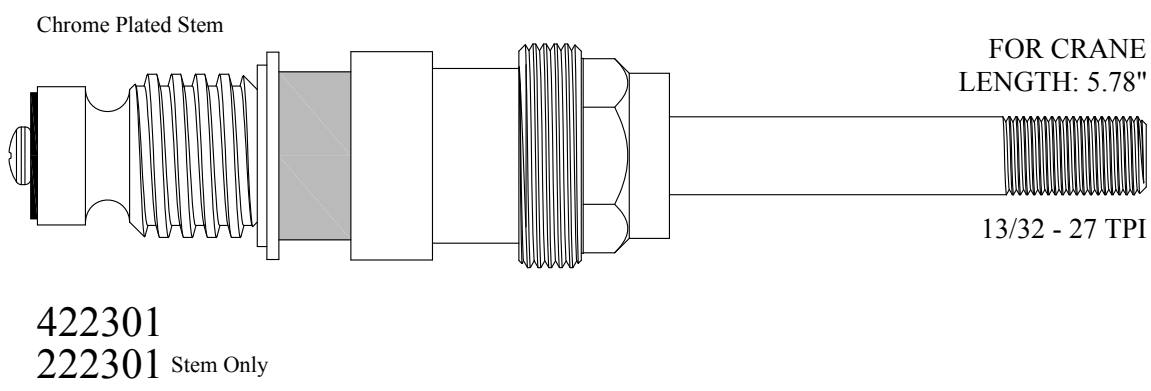

422301
 222301 Stem Only

13/32 - 27 TPI

Chrome Plated Stem

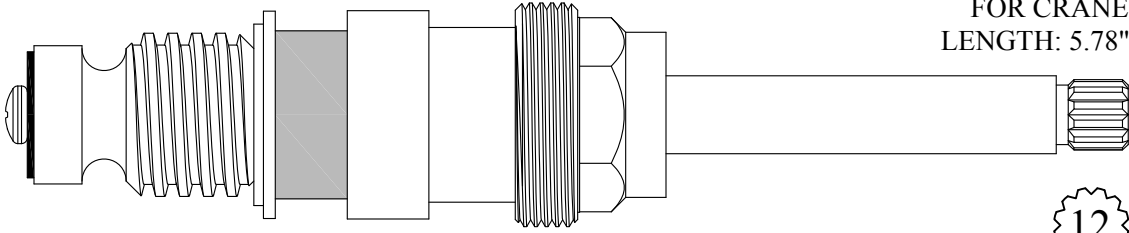

FOR CRANE
LENGTH: 5.78"

12
1-2

422351
222351 Stem Only

Chrome Plated Stem

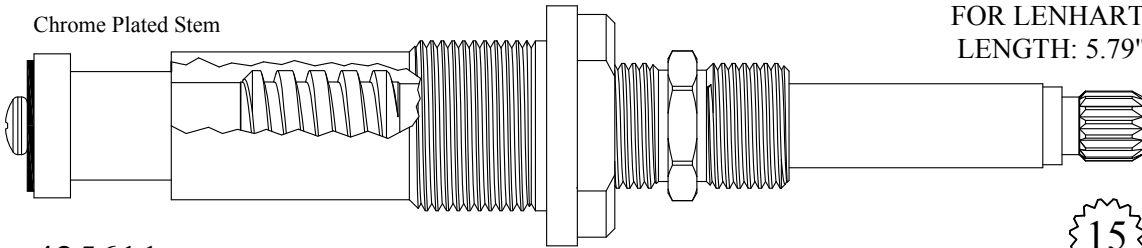

FOR LENHART
LENGTH: 5.79"

15
1-13

425611
225611 Stem Only
GASKET: 895370

Chrome Plated Stem

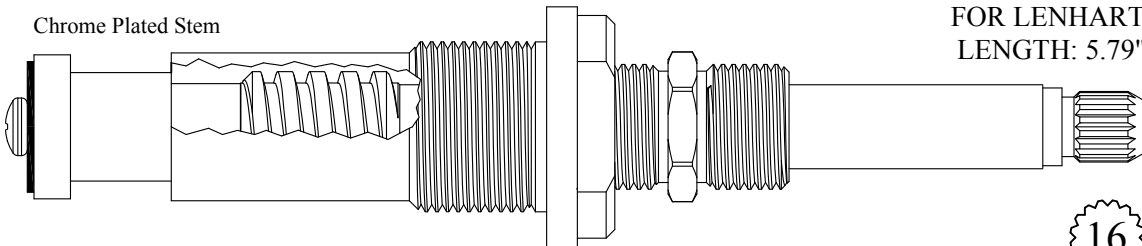

FOR LENHART
LENGTH: 5.79"

16
1-6

425621
225621 Stem Only
GASKET: 895370

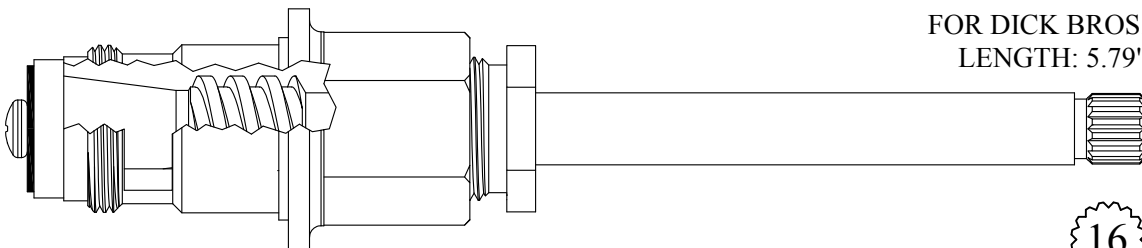

FOR DICK BROS.
LENGTH: 5.79"

16
1-6

436301
236301 Stem Only
GASKET: 895350

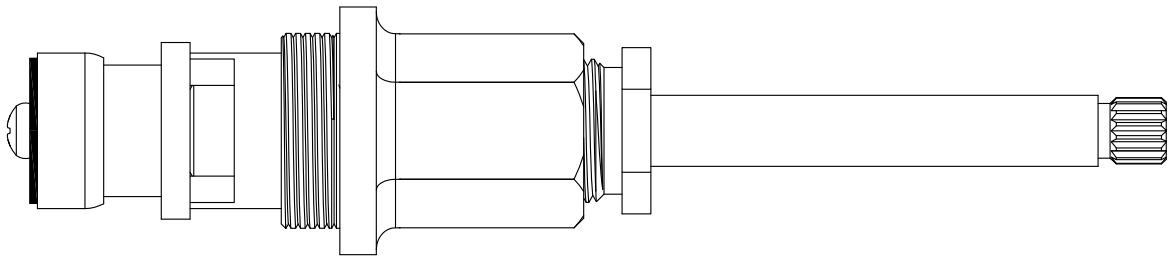
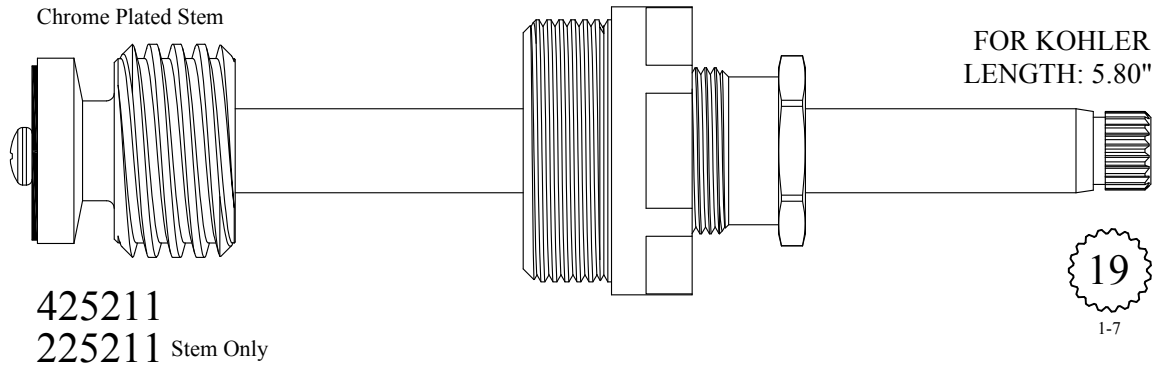

Old Style, Use 434401 or 236411 stem only

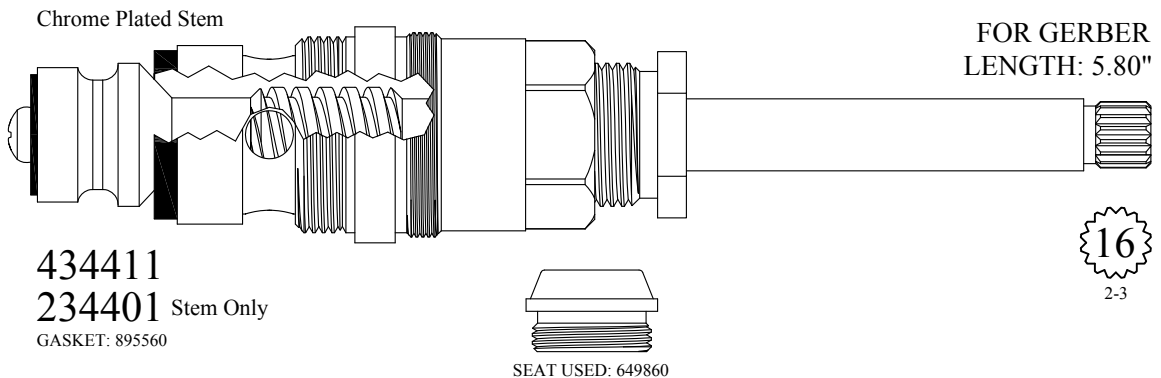
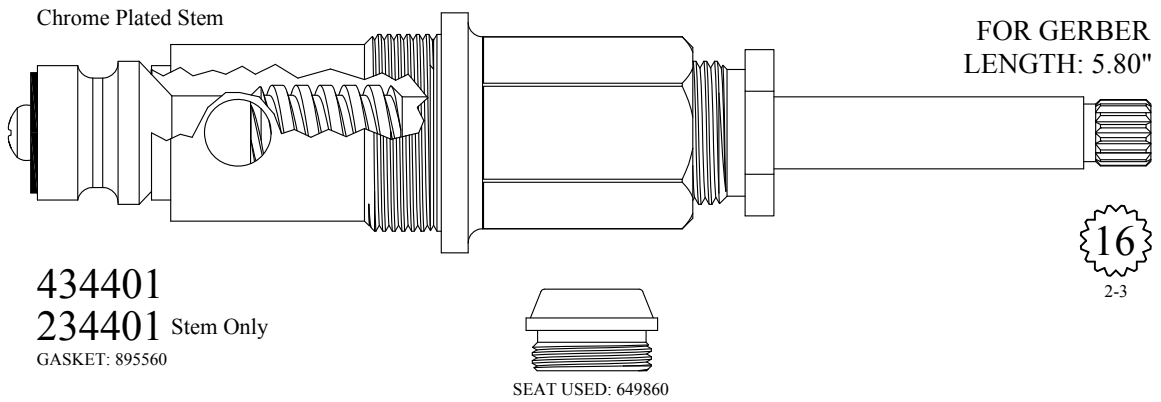

Chrome Plated Stem

FOR AM STD
STEM LENGTH: 5.81"

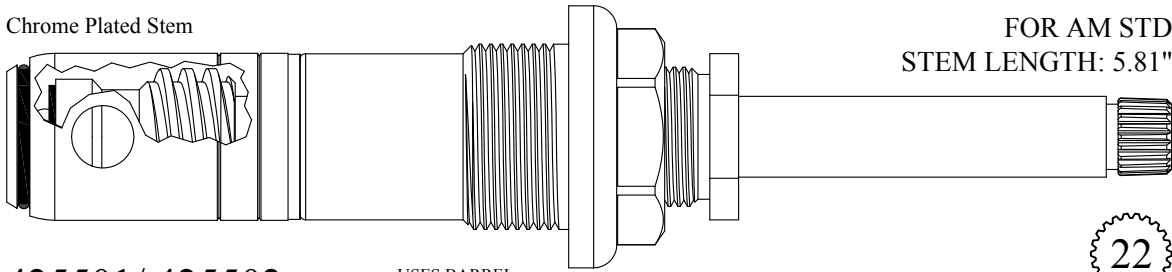

425501/ 425502
225501/ 225502 Stem Only
GASKET: 818000

USES BARREL:
LF647021/LF647022



Chrome Plated Stem

FOR AM STD
STEM LENGTH: 5.81"

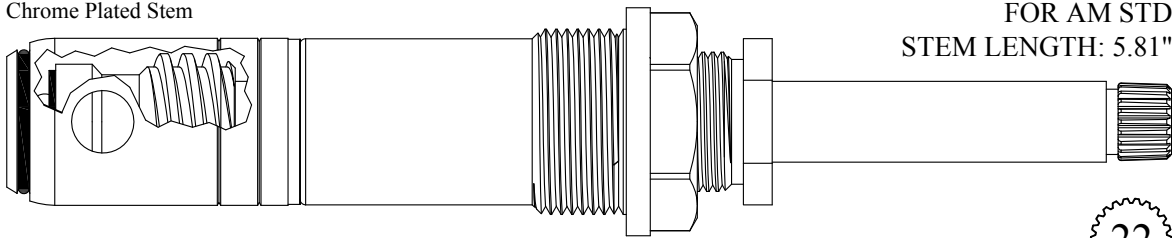

425511
225501 Stem Only
GASKET: 818010

USES BARREL:
LF647021

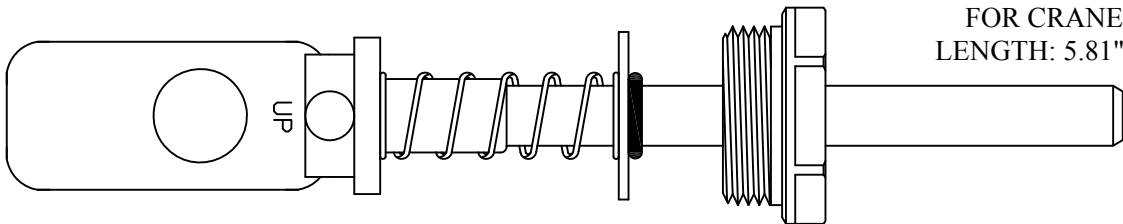

FOR CRANE
LENGTH: 5.81"

436000
236000 Stem Only
GASKET: 895370 INCLUDED

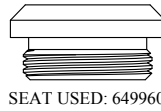

SEAT USED: 649960

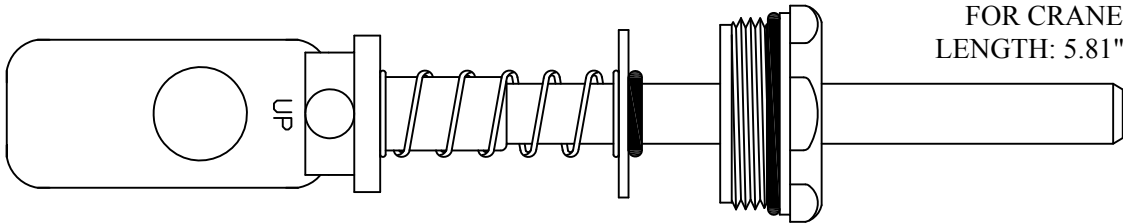

FOR CRANE
LENGTH: 5.81"

436010
236000 Stem Only
GASKET: 890210 O-RING INCLUDED

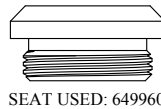

SEAT USED: 649960

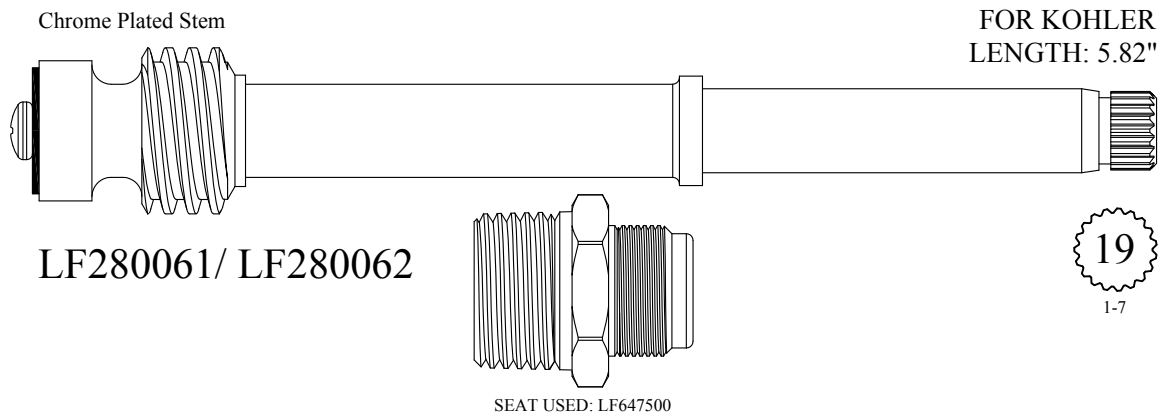
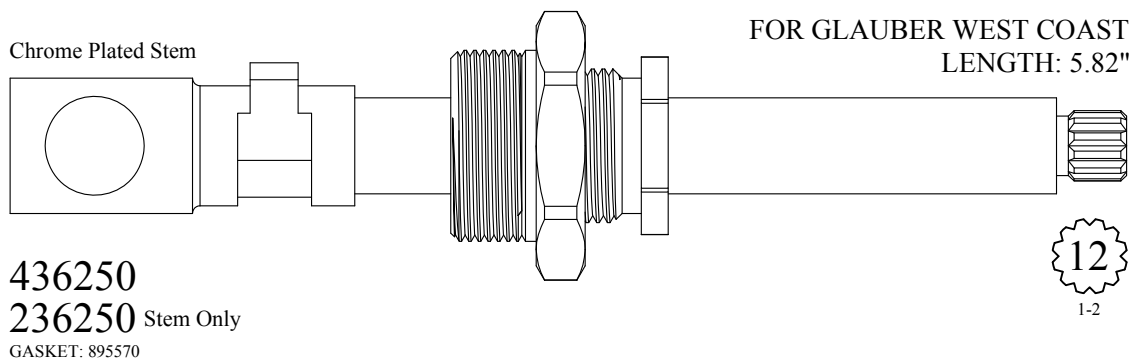
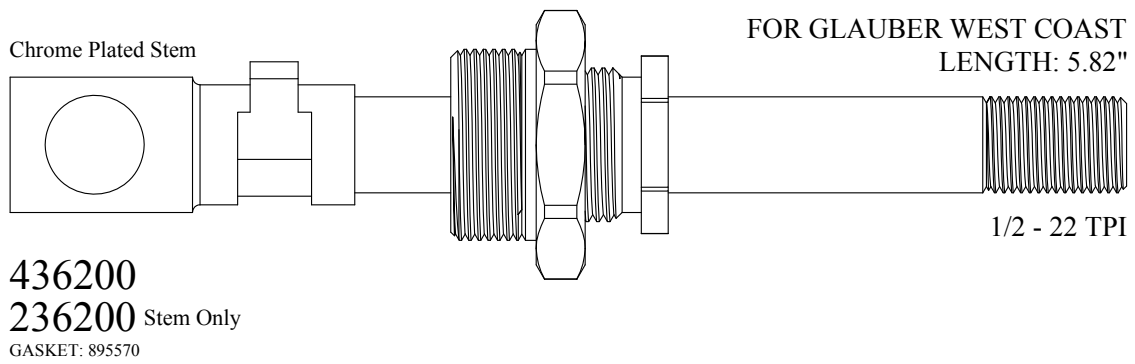
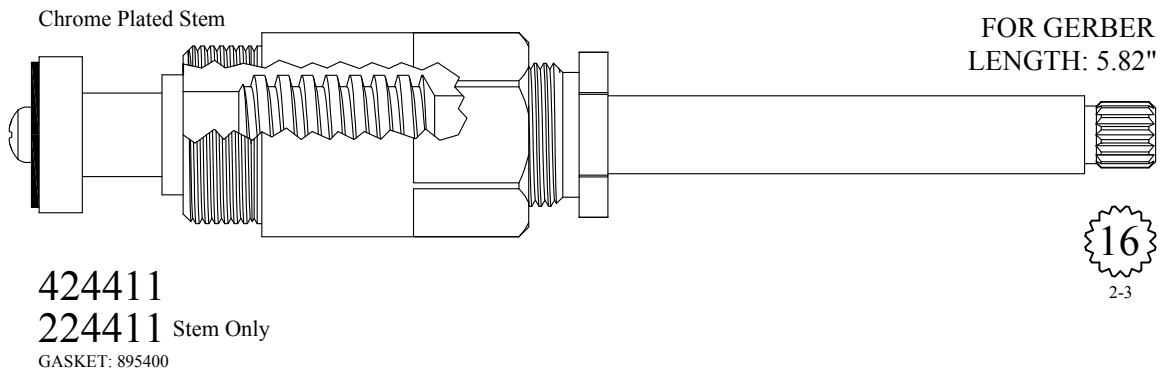

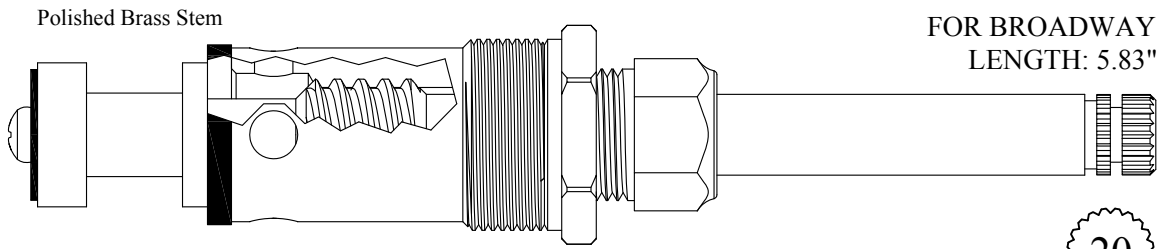

Polished Brass Stem

FOR BROADWAY
LENGTH: 5.83"

436321
236321 Stem Only

Also available with polished chrome plated stem

436321-CP
236321-CP Stem Only

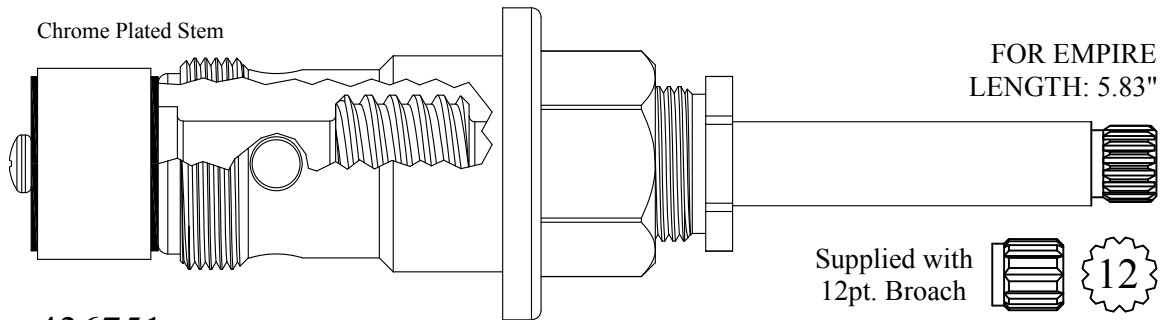

Chrome Plated Stem

FOR EMPIRE
LENGTH: 5.83"

436751
236751 Stem Only
GASKET: 895450

Supplied with
12pt. Broach

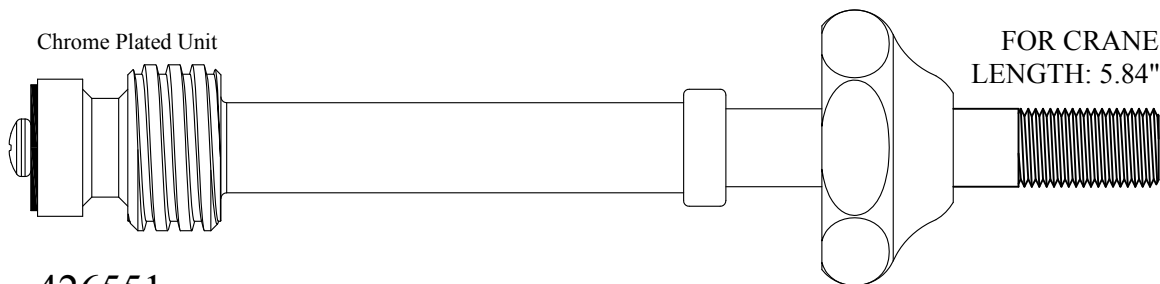

Chrome Plated Unit

FOR CRANE
LENGTH: 5.84"

426551
226551 Stem Only

Supplied with
12pt. Broach

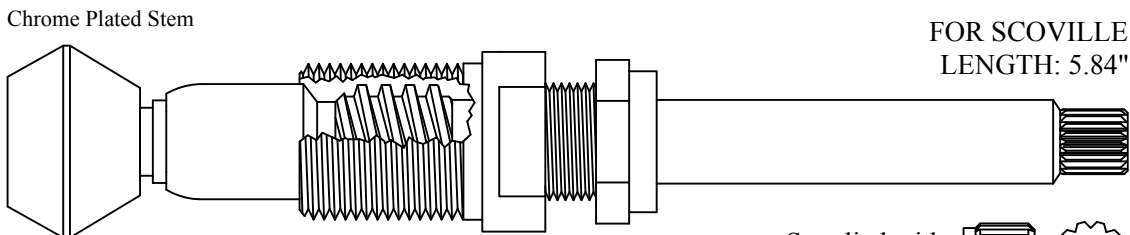

Chrome Plated Stem

FOR SCOVILLE
LENGTH: 5.84"

436241
236241 Stem Only
GASKET: 895150

Supplied with
12pt. Broach



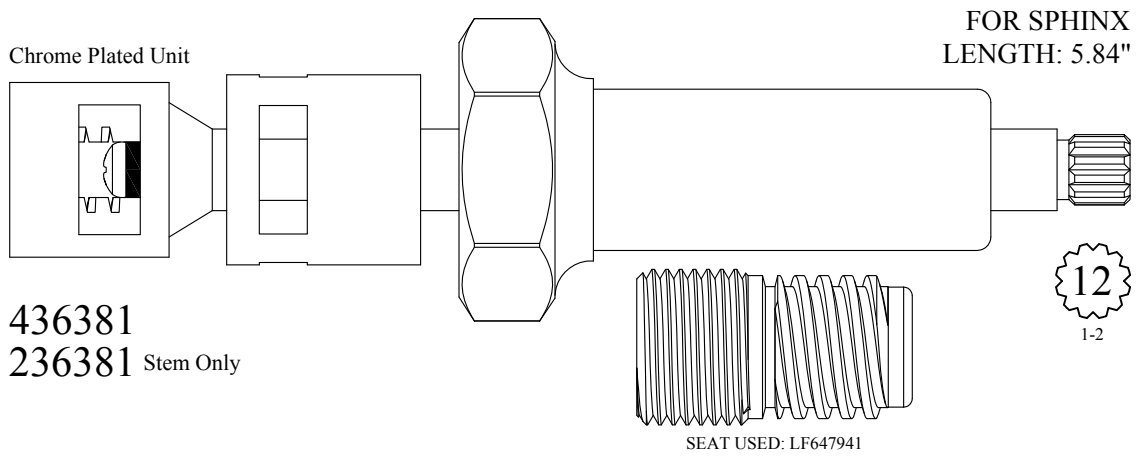

436381
236381 Stem Only

12
1-2

SEAT USED: LF647941

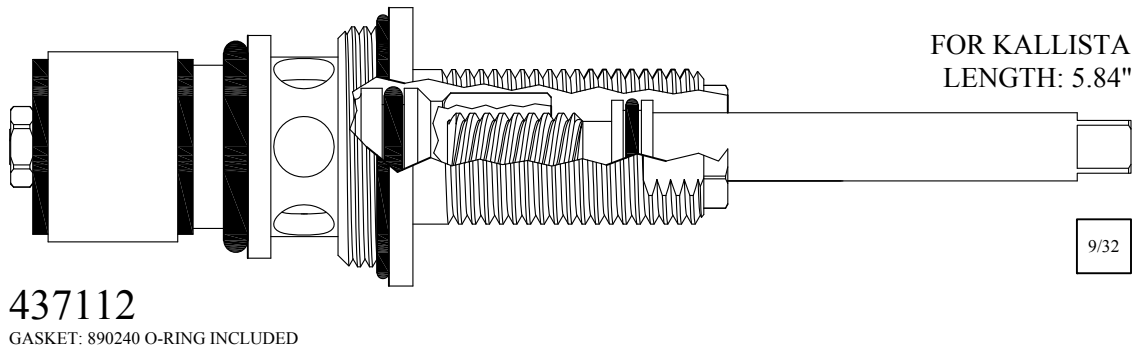

437112
GASKET: 890240 O-RING INCLUDED

9/32

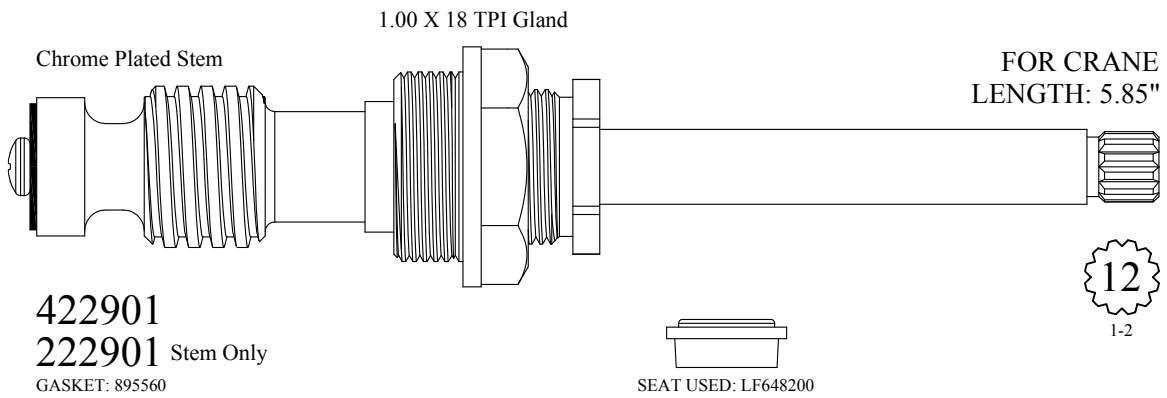

422901
222901 Stem Only
GASKET: 895560

12
1-2

SEAT USED: LF648200

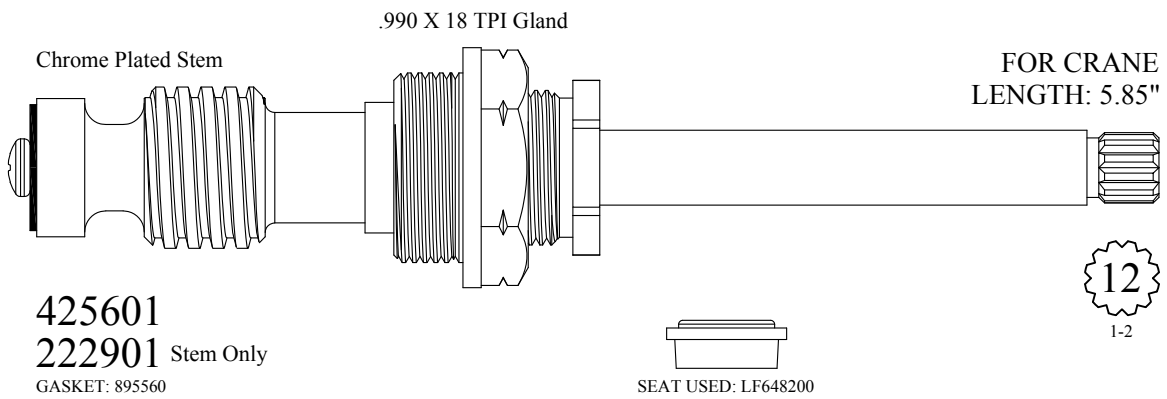

425601
222901 Stem Only
GASKET: 895560

12
1-2

SEAT USED: LF648200

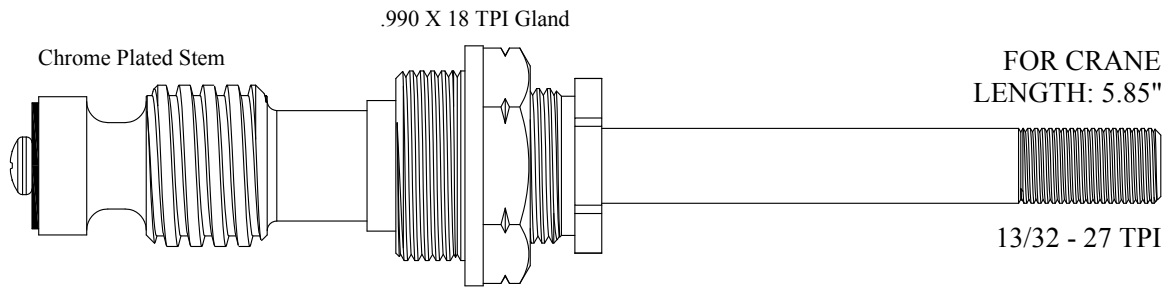

425631
225631 Stem Only
GASKET: 895560

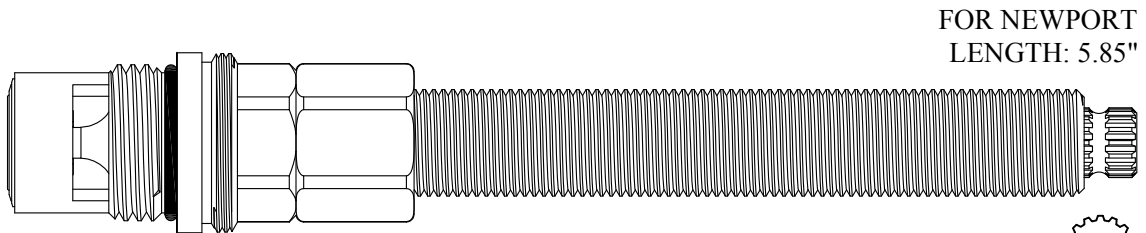
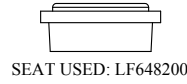

411271/ 411272
GASKET: 890170 O-RING INCLUDED
SEAL: 898510-W
DISC SET: 151380-PKG

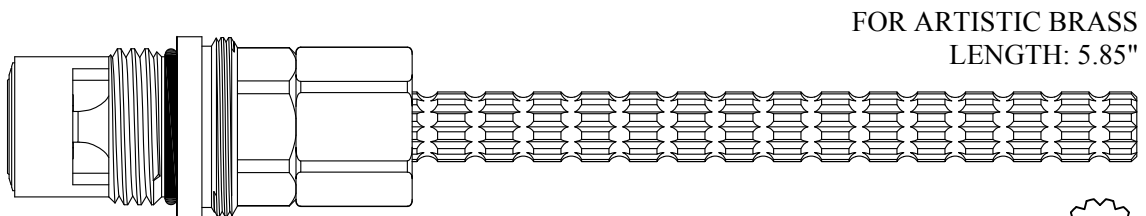

425721/ 425722
GASKET: 890170 O-RING INCLUDED
SEAL: 898510-W
DISC SET: 151380-PKG

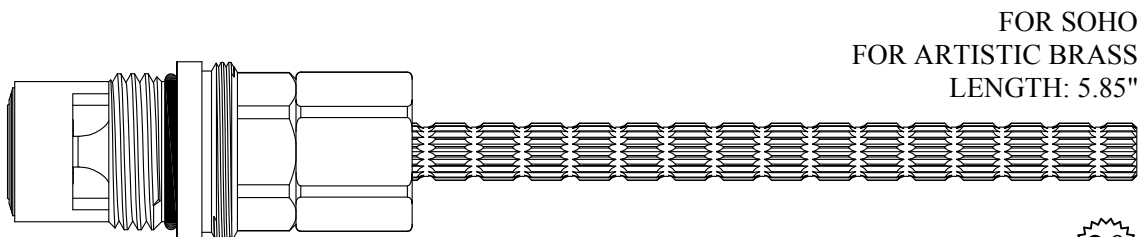

425741/ 425742
GASKET: 890170 O-RING INCLUDED
SEAL: 898510-W
DISC SET: 151380-PKG



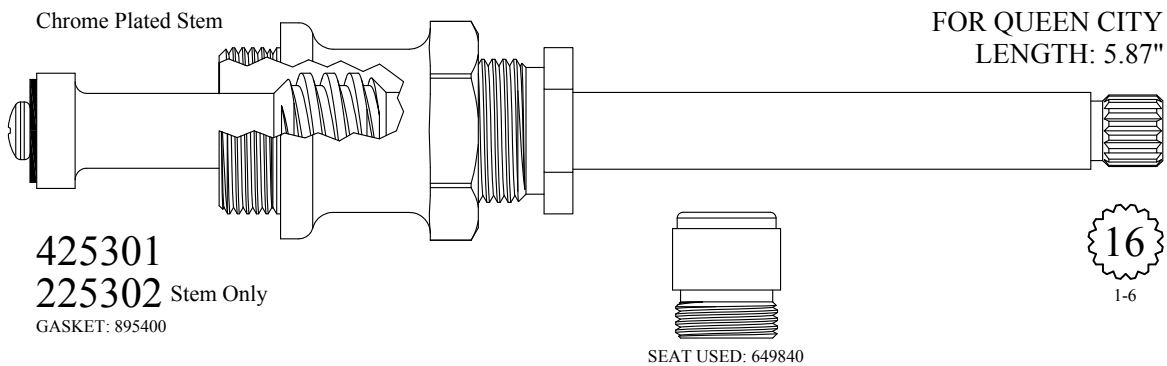
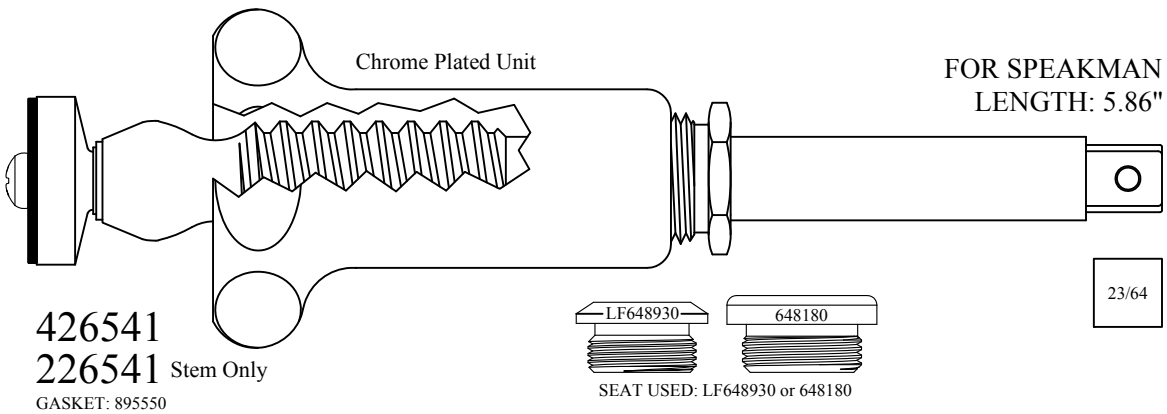
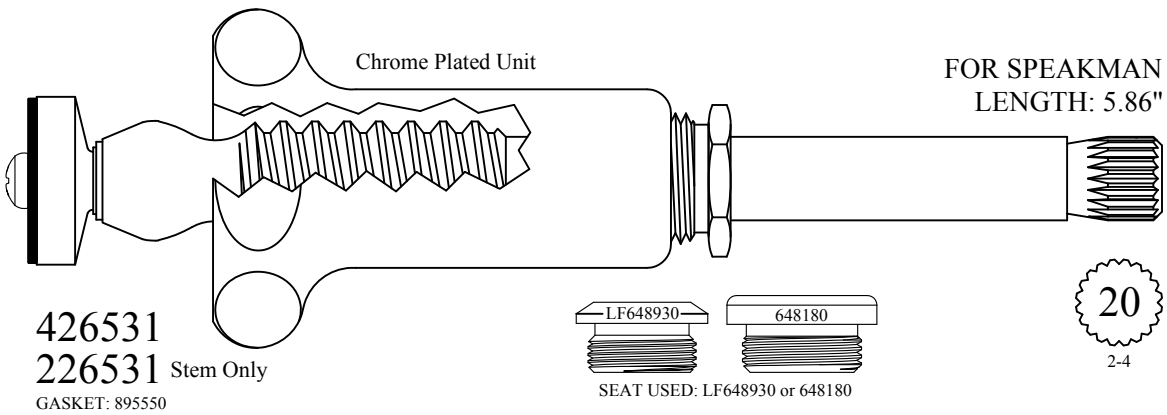
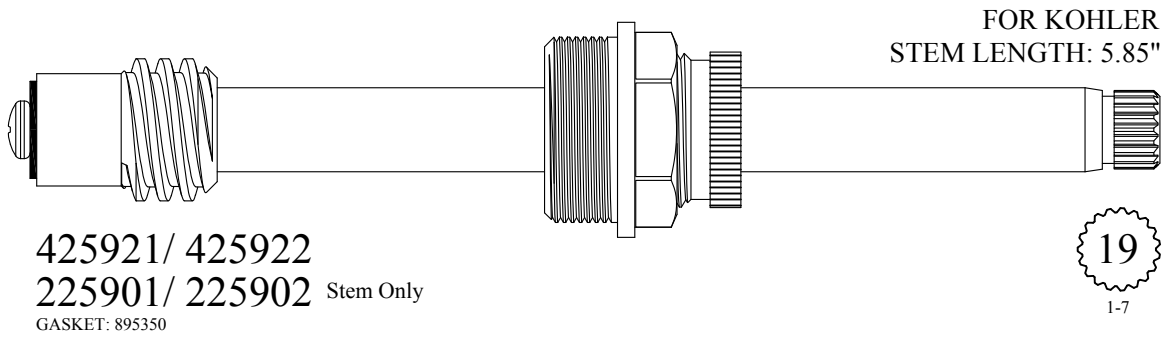

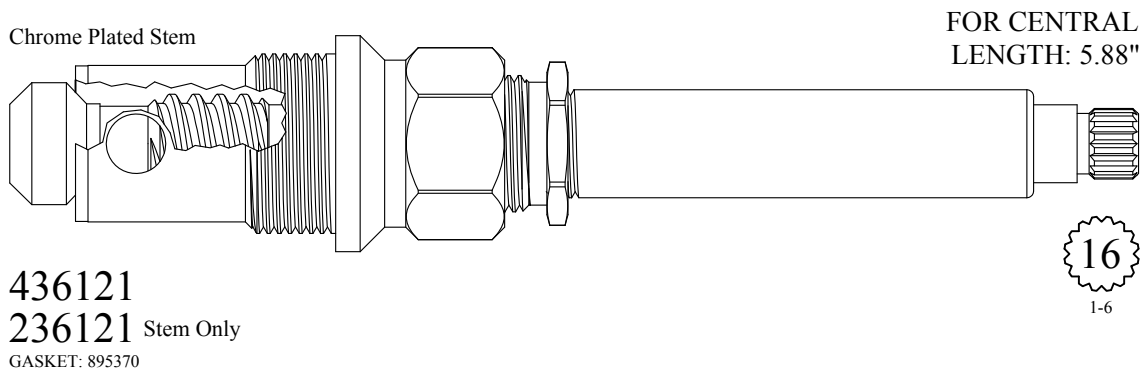
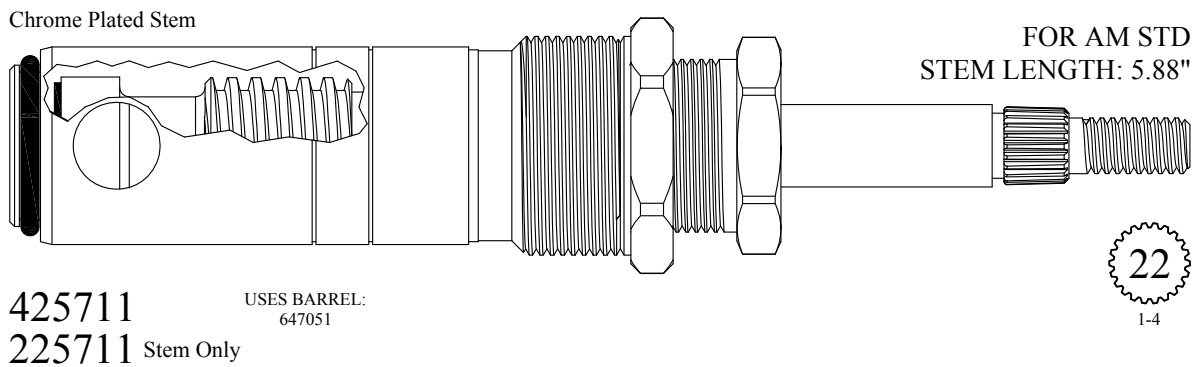
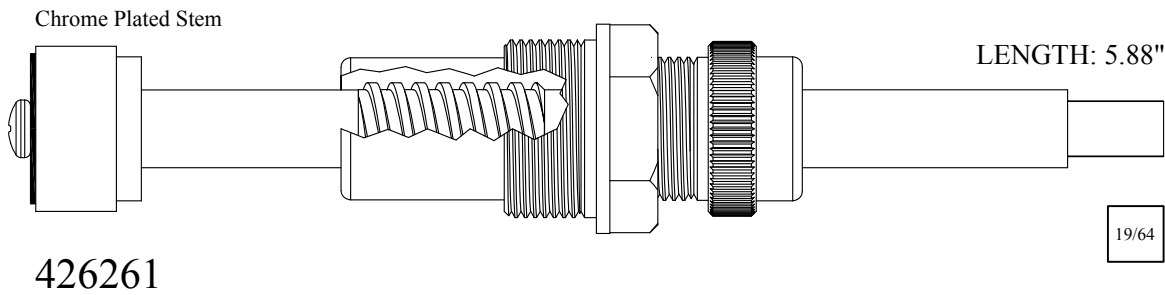
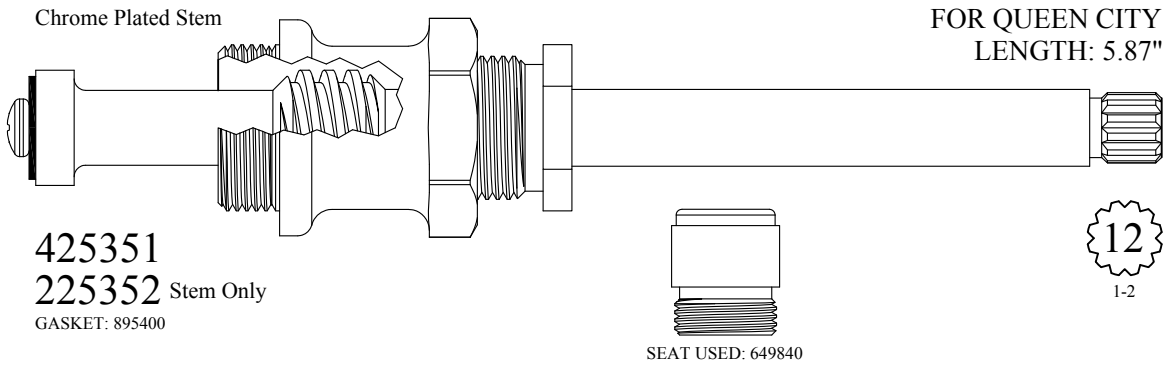

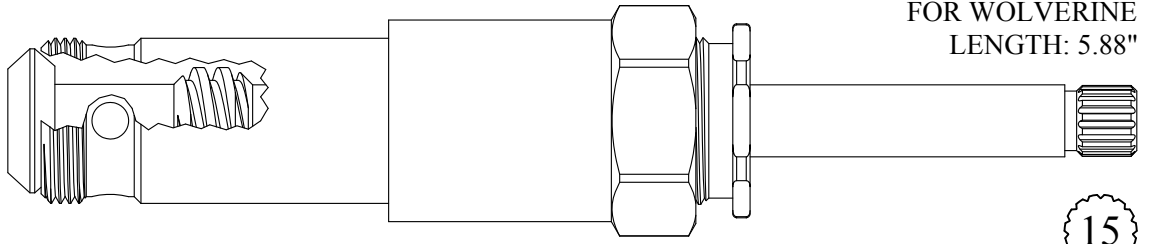

FOR WOLVERINE
LENGTH: 5.88"

436711
GASKET: 895400

15
3-27

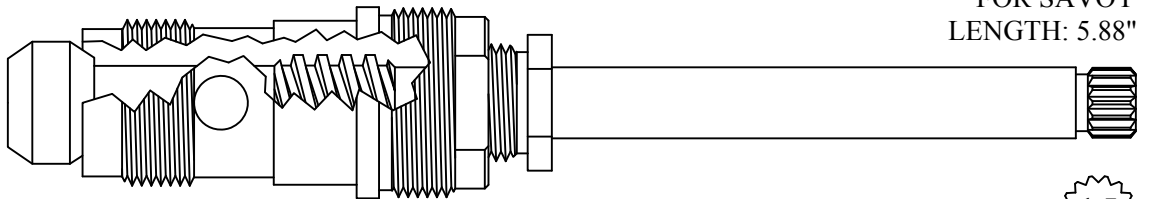

FOR SAVOY
LENGTH: 5.88"

438921
238921 Stem Only
GASKET: 895400

15
1-13

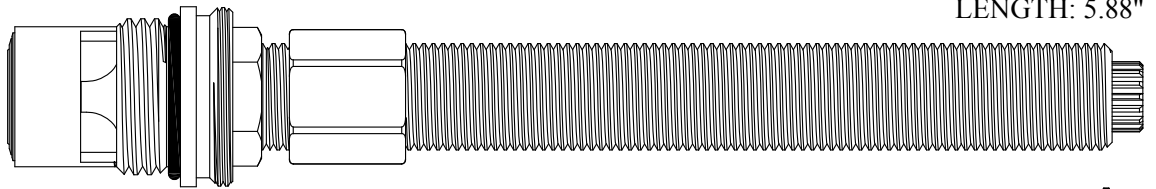

FOR NEWPORT
LENGTH: 5.88"

411281/ 411282
GASKET: 890170 O-RING INCLUDED
SEAL: 898510-W
DISC SET: 151380-PKG

16
3-16

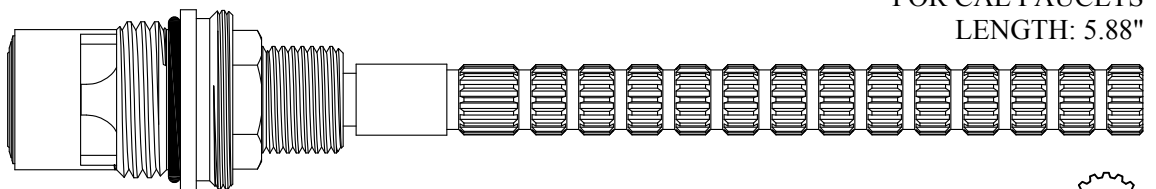

FOR CAL FAUCETS
LENGTH: 5.88"

411291/ 411292
GASKET: 890170 O-RING INCLUDED
SEAL: 898510-W
DISC SET: 151380-PKG

16
3-16

Ceramic Conversion for 421601 / 421602

FOR ARTISTIC BRASS
FOR PRICE PFISTER
LENGTH: 5.88"

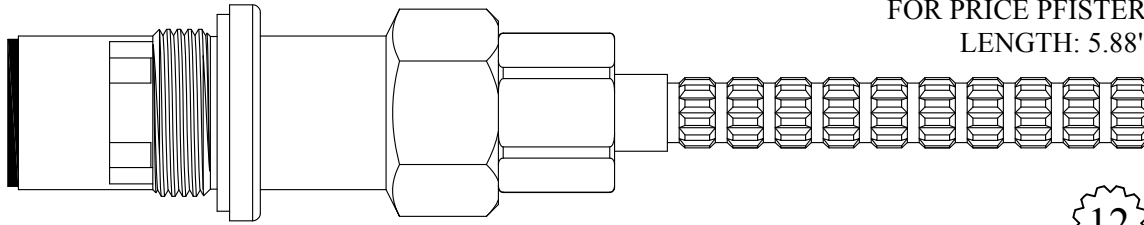

421691/ 421692

GASKET: 895390 INCLUDED
SEAL: 898550
DISC SET: 124290-PKG

12
1-2

Chrome Plated Stem

FOR QUEEN CITY
LENGTH: 5.89"

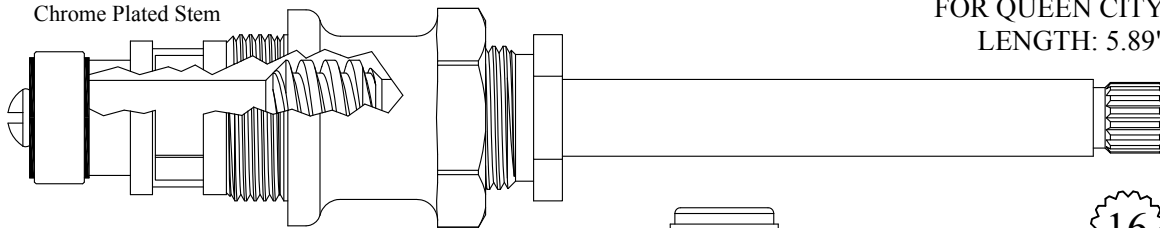

436211
236211 Stem Only

GASKET: 895400

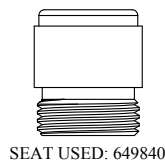

SEAT USED: 649840

16
1-6

1/2 Turn Ceramic

FOR DOLLY TRIM
LENGTH: 5.89"

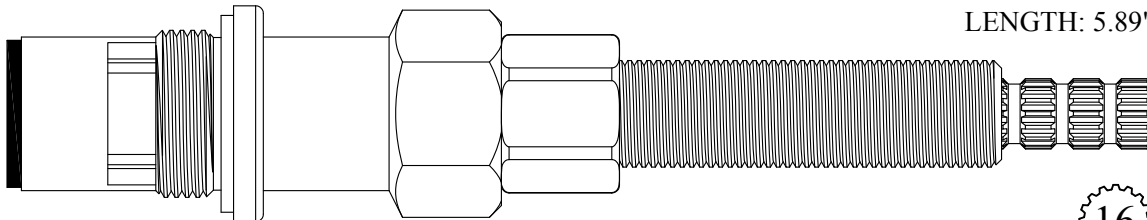

421641/ 421642

GASKET: 895390 INCLUDED
SEAL: 898550
DISC SET: 124290-PKG

16
3-16

FOR PRICE PFISTER
LENGTH: 5.89"

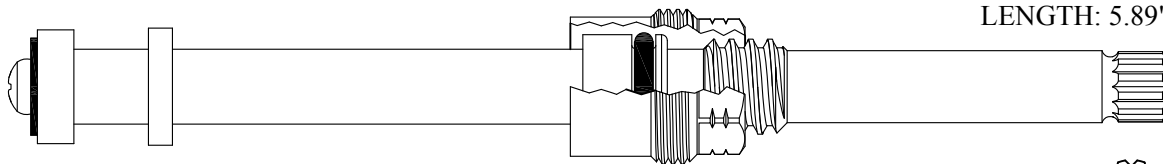

LF480071/ LF480072

GASKET: 895060



SEAT USED: LF648270

12
1-2

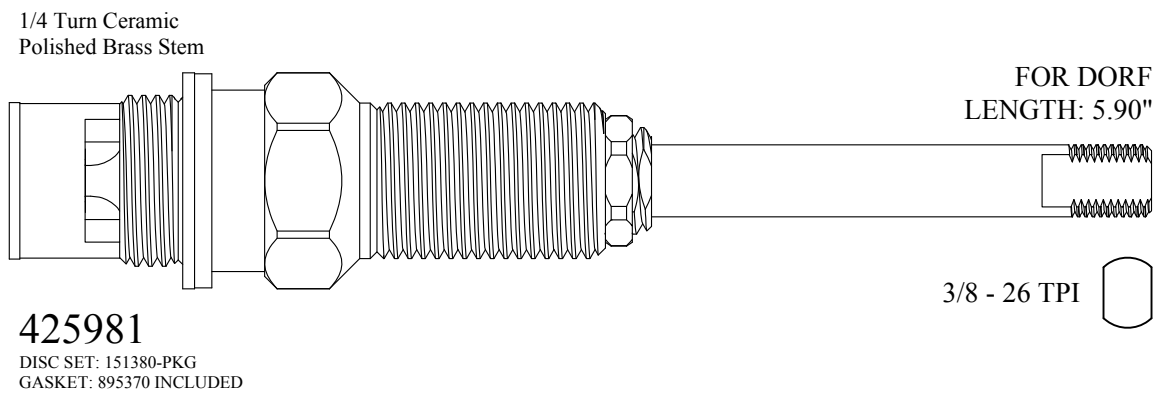
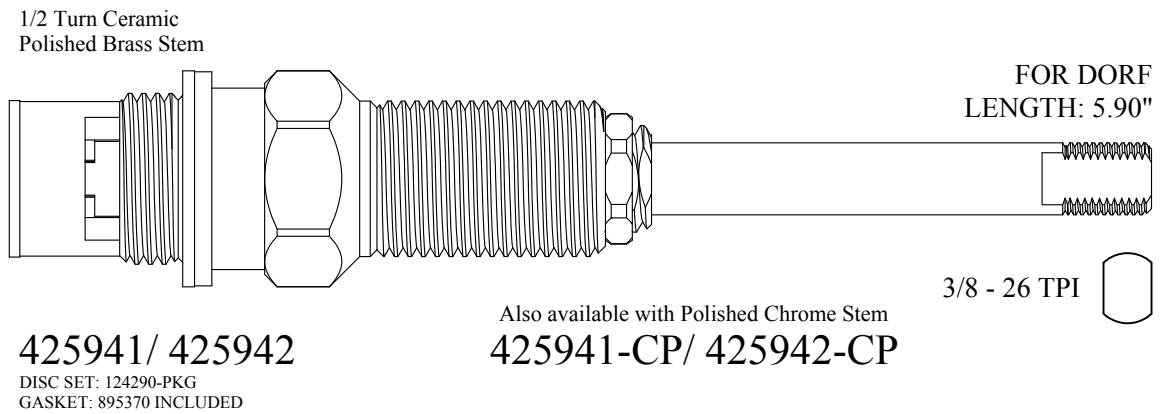
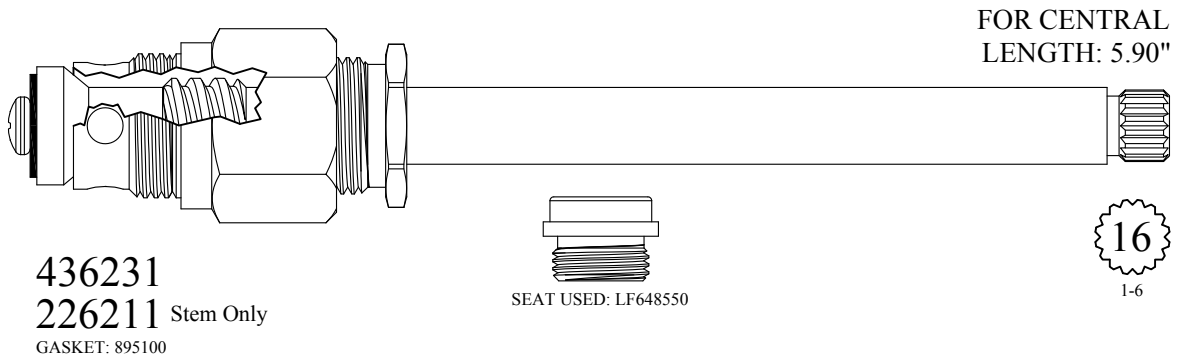
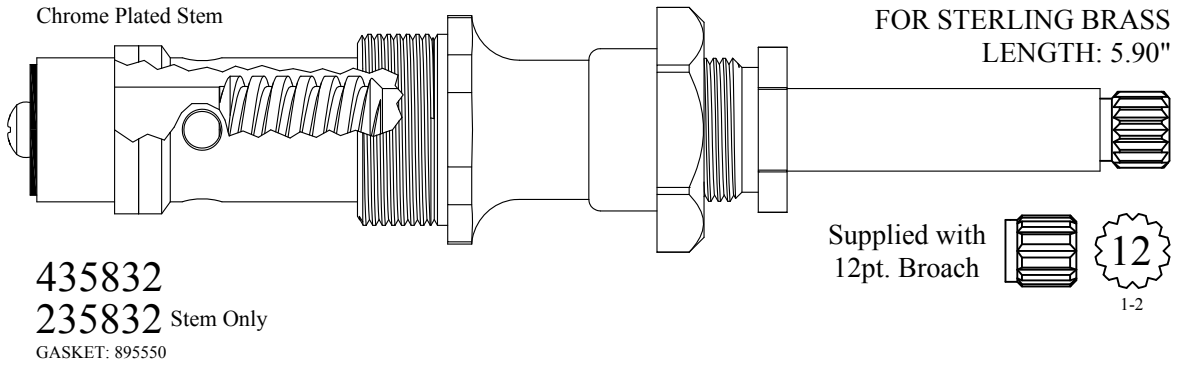

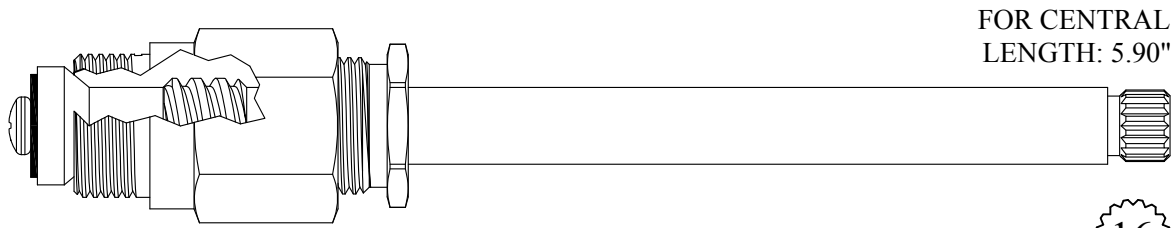

FOR CENTRAL
LENGTH: 5.90"

426211/ 426212
226211/ 226212 Stem Only
GASKET: 895100

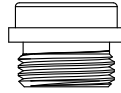

SEAT USED: LF648550

16
1-6

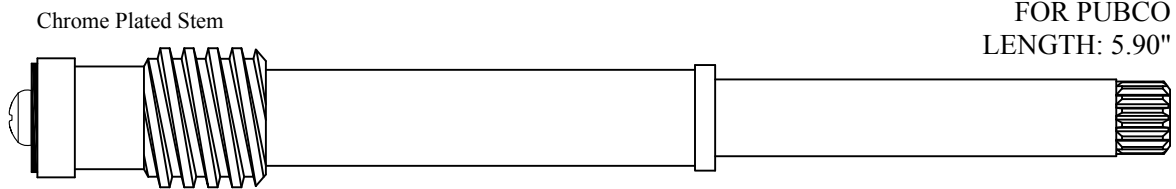

FOR PUBCO
LENGTH: 5.90"

LF280091

16
1-6

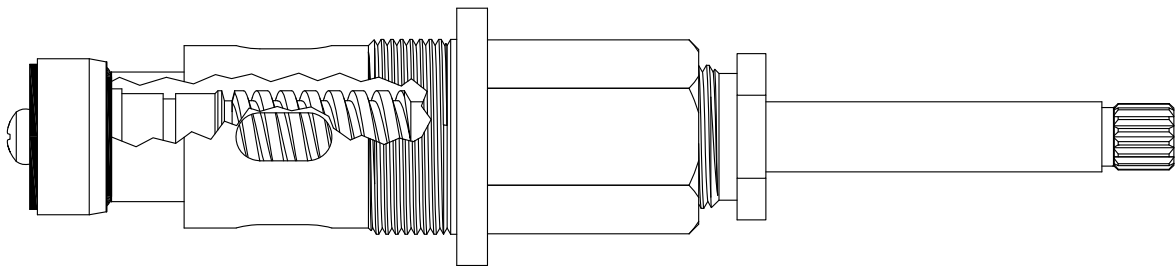

Old Style, Use 433441 or 236401 stem only

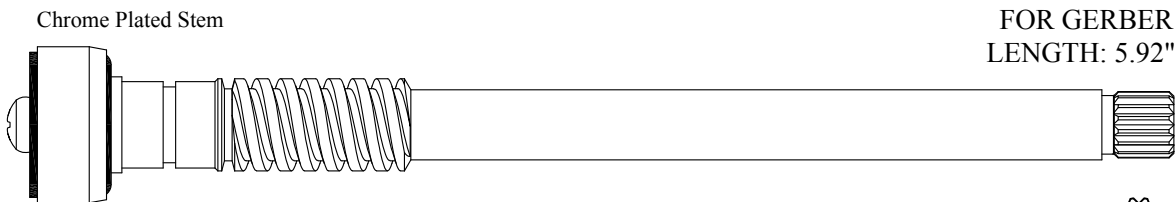

FOR GERBER
LENGTH: 5.92"

236401

16
2-3

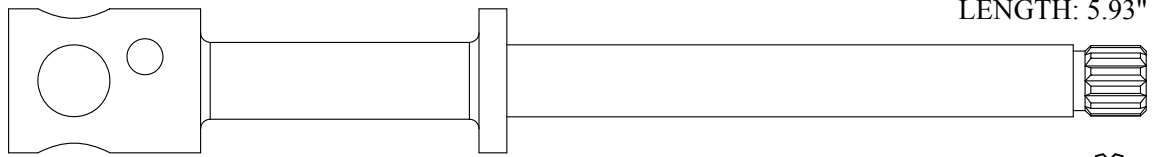

FOR GRAND HAVEN
LENGTH: 5.93"

236310

12
1-2

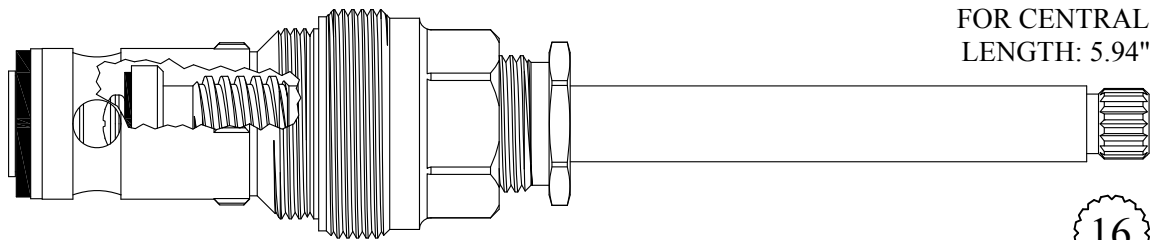

FOR CENTRAL
LENGTH: 5.94"

424711

GASKET: 895340
SEAT INCLUDED : 647850

16
1-6

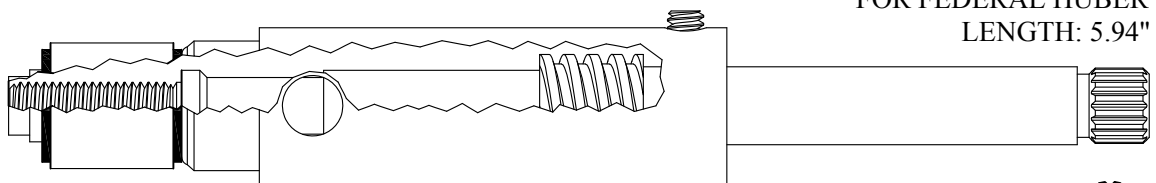

FOR FEDERAL HUBER
LENGTH: 5.94"

436441

16
1-5

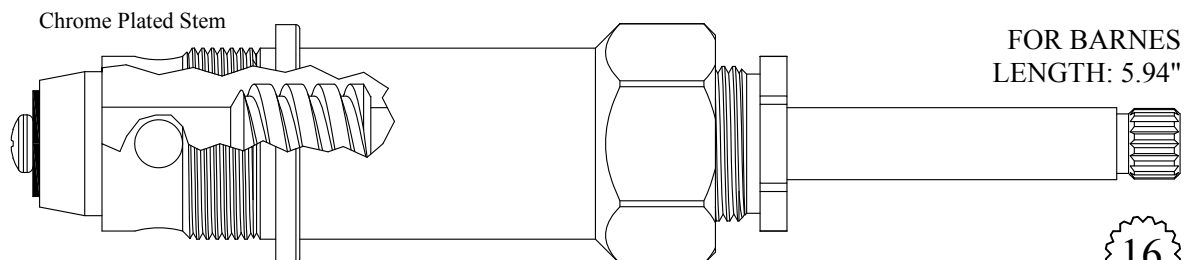

FOR BARNES
LENGTH: 5.94"

437601

237601 Stem Only

16
1-6

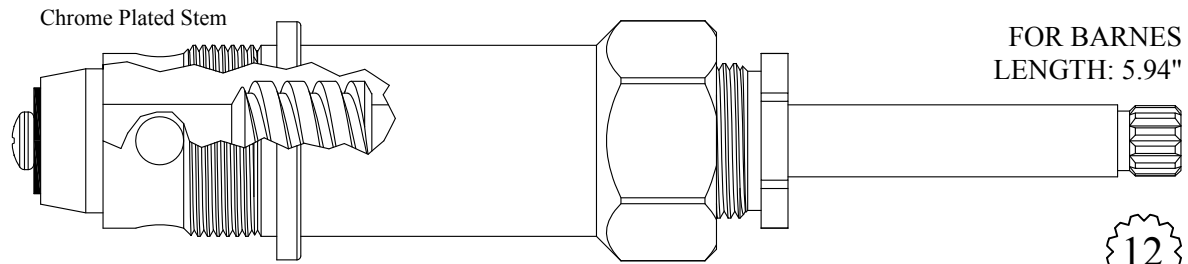

Chrome Plated Stem

FOR BARNES
LENGTH: 5.94"

437651
237651 Stem Only

12
1-2

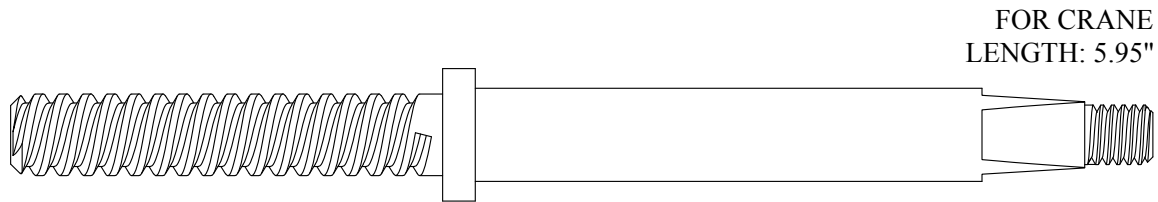

FOR CRANE
LENGTH: 5.95"

281522

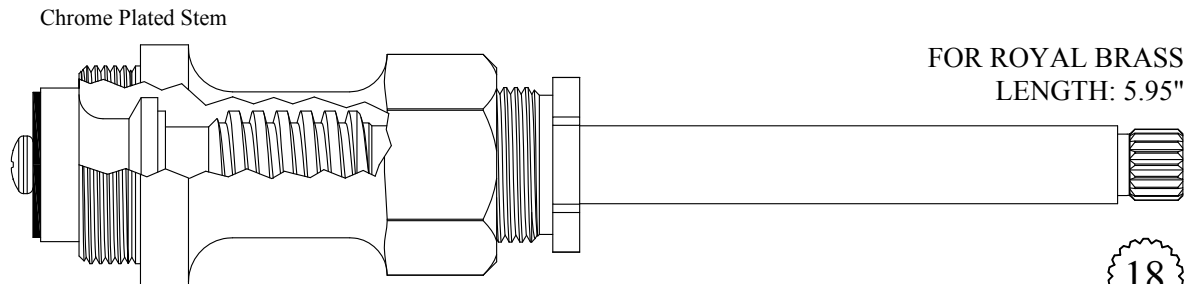

Chrome Plated Stem

FOR ROYAL BRASS
LENGTH: 5.95"

426001
226001 Stem Only
GASKET: 895560

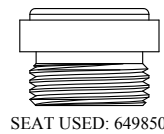

SEAT USED: 649850

18
3-3

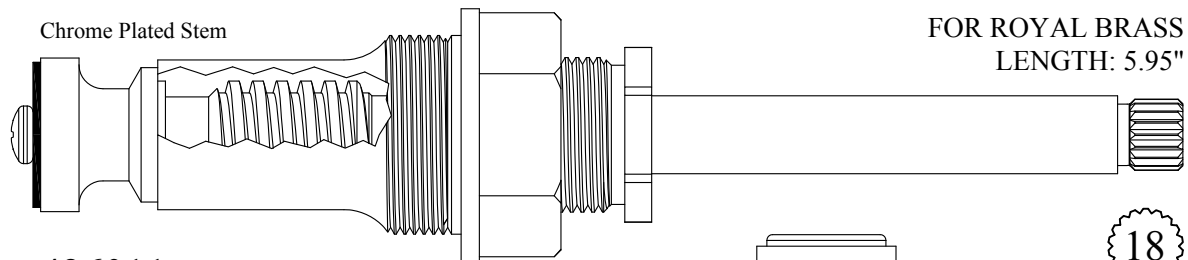

Chrome Plated Stem

FOR ROYAL BRASS
LENGTH: 5.95"

426011
226001 Stem Only
GASKET: 895560

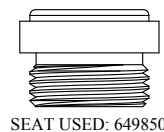

SEAT USED: 649850

18
3-3

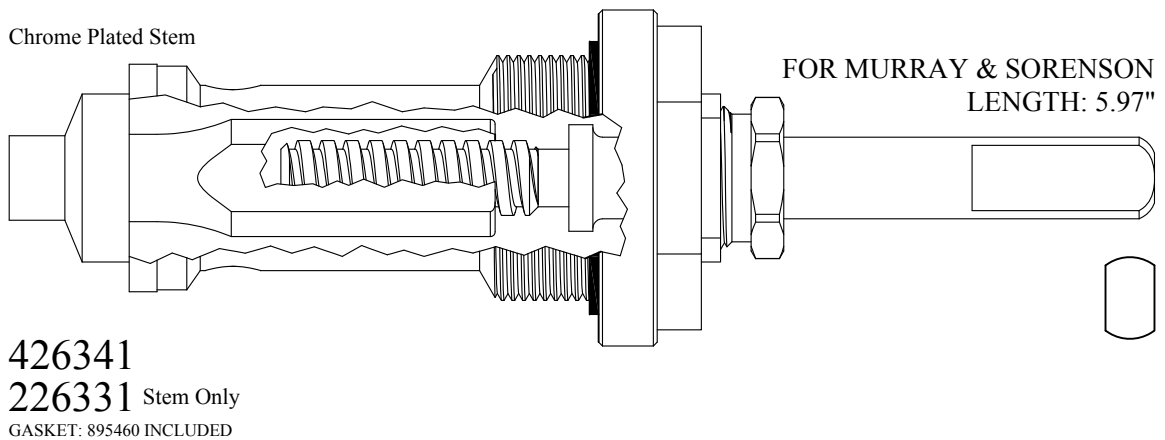
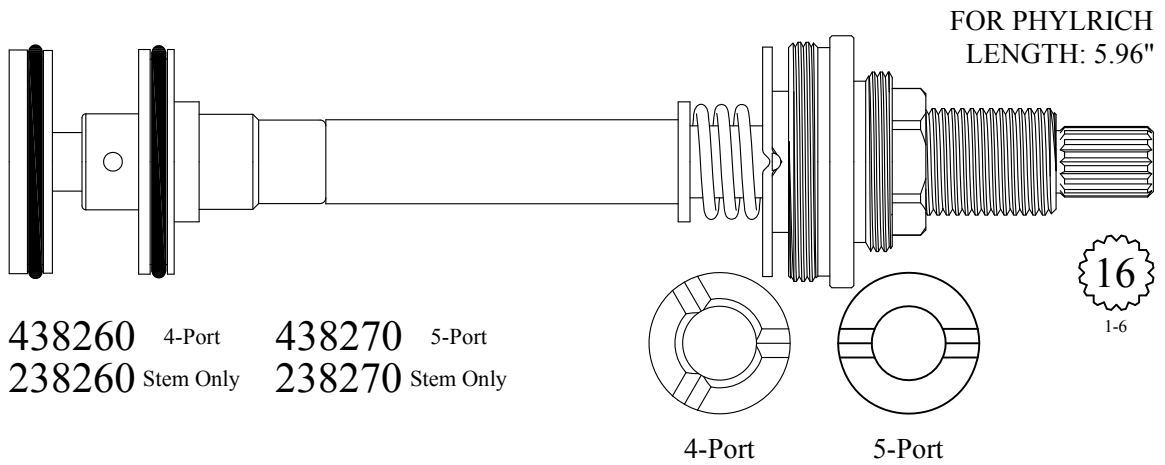
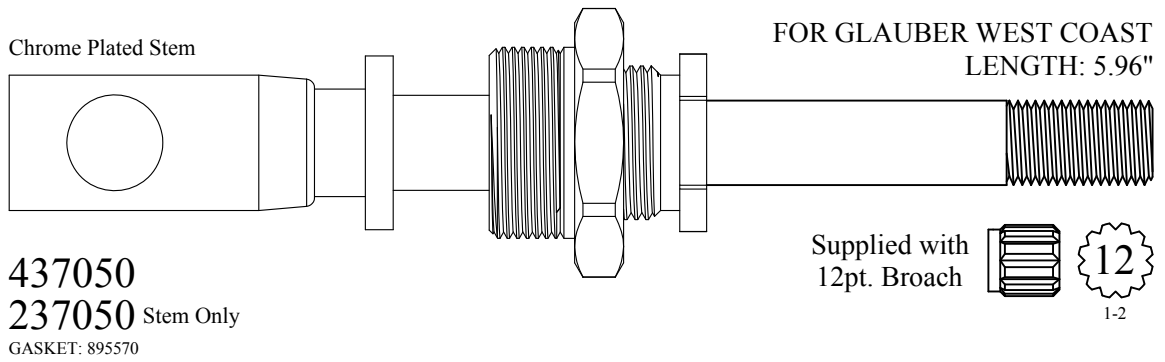
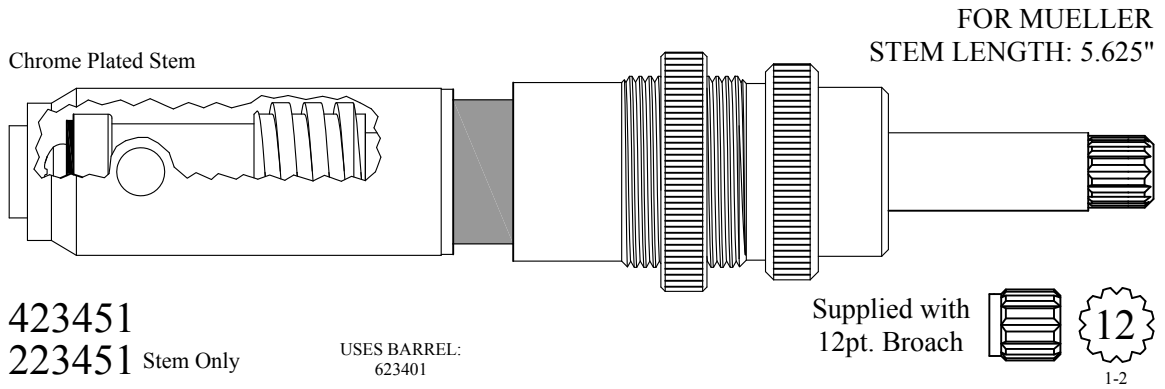

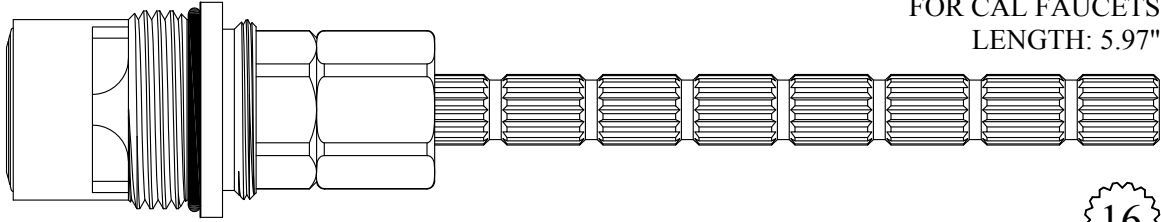

FOR CAL FAUCETS
LENGTH: 5.97"

16
1-6

421661/ 421662
GASKET: 890210 O-RING INCLUDED
SEAL: 898520
DISC SET: 109850-PKG

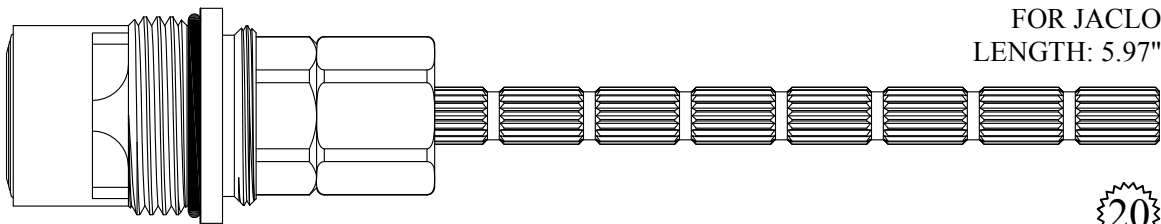

FOR JACLO
LENGTH: 5.97"

20
3-20

421681/ 421682
GASKET: 890210 O-RING INCLUDED
SEAL: 898520
DISC SET: 109850-PKG

Chrome Plated Stem



FOR KOHLER
LENGTH: 5.98"

19
1-7

437311
237311 Stem Only
GASKET: 895350

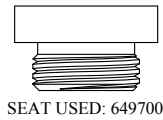

SEAT USED: 649700

Chrome Plated Stem & Packing Nut

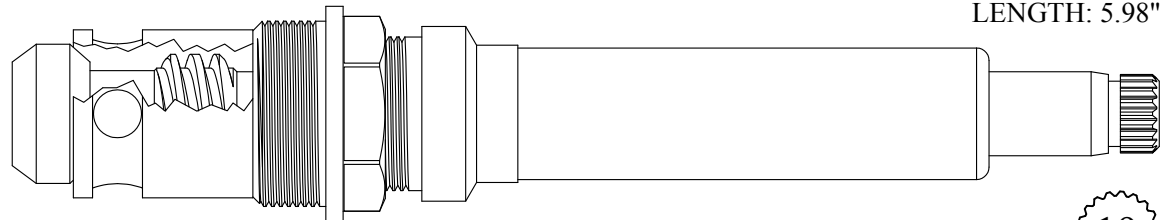

FOR KOHLER
LENGTH: 5.98"

19
1-7

437321
237311 Stem Only
GASKET: 895350

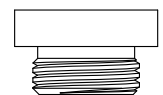

SEAT USED: 649700

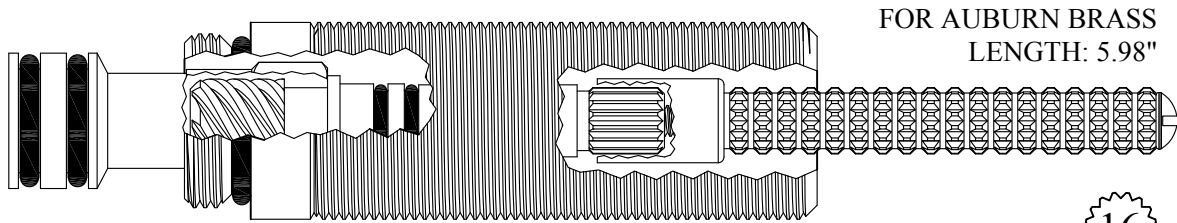

FOR AUBURN BRASS
LENGTH: 5.98"

437611
GASKET: 891150 O-RING INCLUDED

16
2-3

Chrome Plated Stem

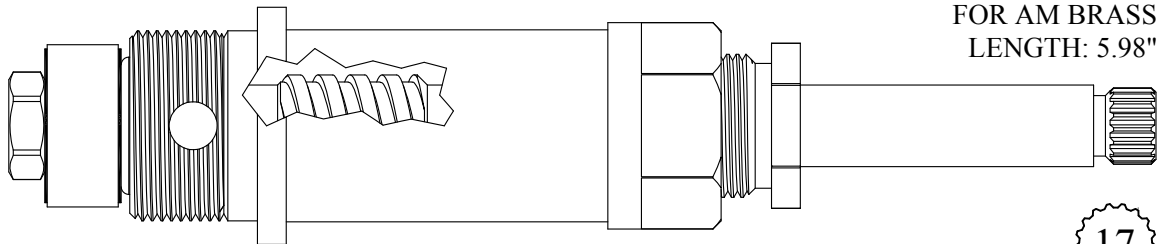

FOR AM BRASS
LENGTH: 5.98"

438701
238701 Stem Only
GASKET: 895550

17
3-7

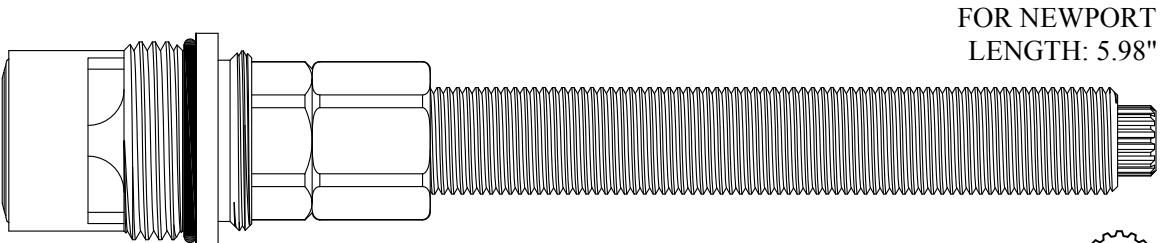

FOR NEWPORT
LENGTH: 5.98"

424911/ 424912
GASKET: 890210 O-RING INCLUDED
SEAL: 898520
DISC SET: 109850-PKG

16
3-16

Chrome Plated Stem

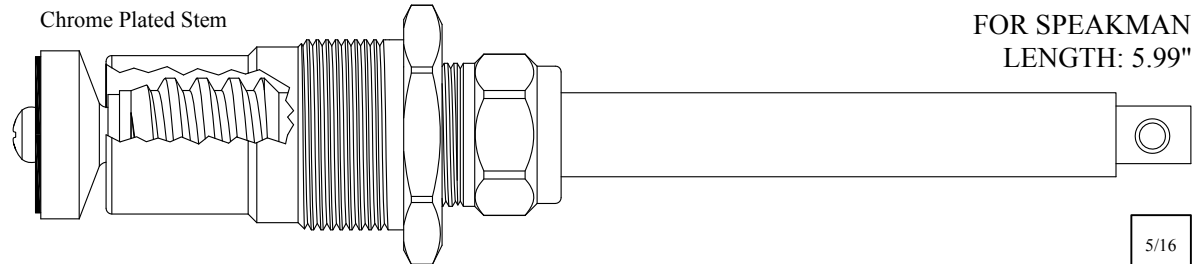

FOR SPEAKMAN
LENGTH: 5.99"

426041
226041 Stem Only
GASKET: 895550

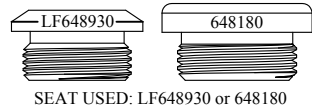

SEAT USED: LF648930 or 648180

5/16

Chrome Plated Stem

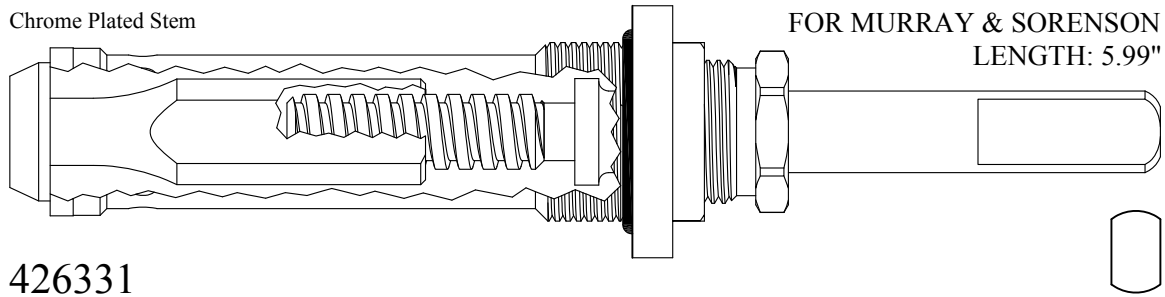

FOR MURRAY & SORENSON
LENGTH: 5.99"

426331

226331 Stem Only

GASKET: 891180 O-RING INCLUDED

Chrome Plated Stem

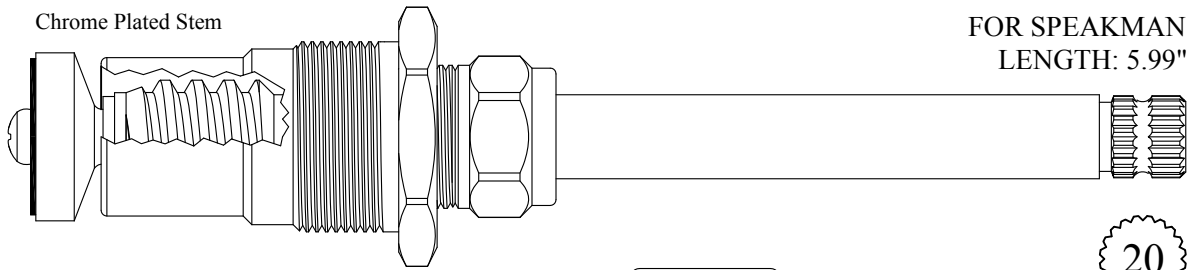

FOR SPEAKMAN
LENGTH: 5.99"

426021/ 426022

226021/ 226022 Stem Only

GASKET: 895550

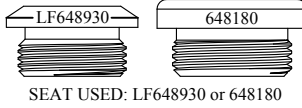

20
2-4

Chrome Plated Stem

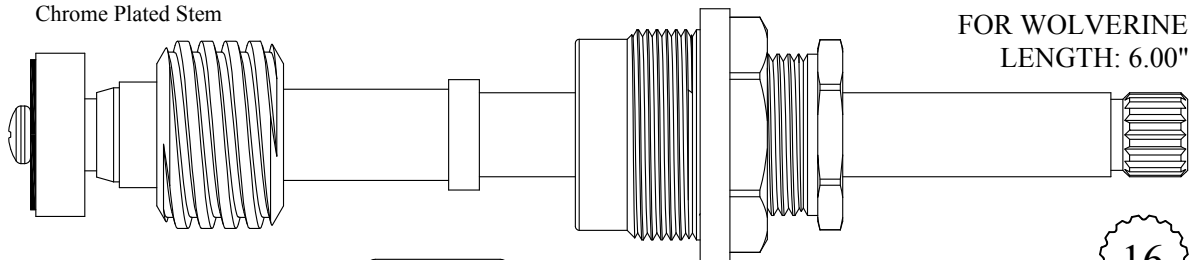

FOR WOLVERINE
LENGTH: 6.00"

426201

226201 Stem Only

GASKET: 895450

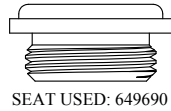

16
3-26

Chrome Plated Stem

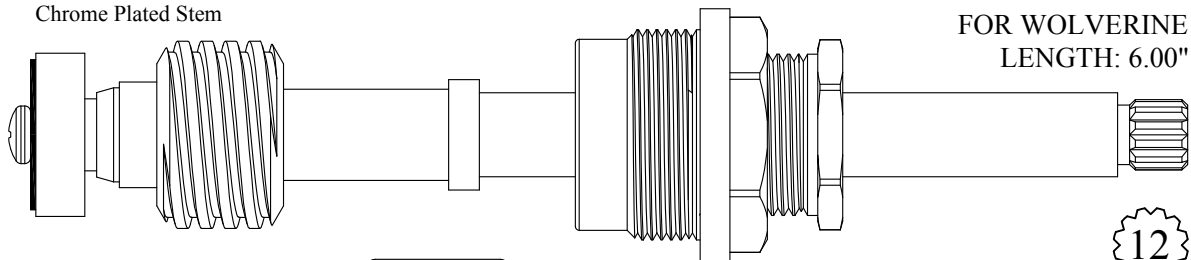

FOR WOLVERINE
LENGTH: 6.00"

426251

226251 Stem Only

GASKET: 895450

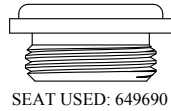

12
1-2

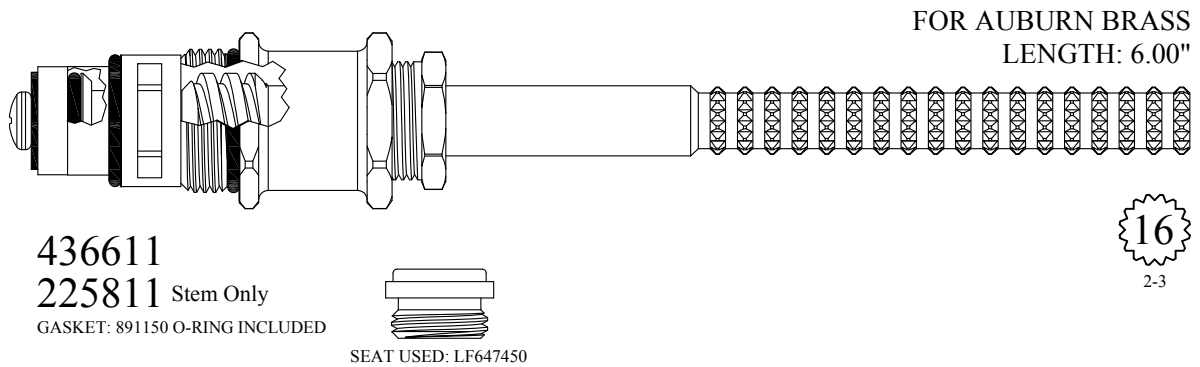
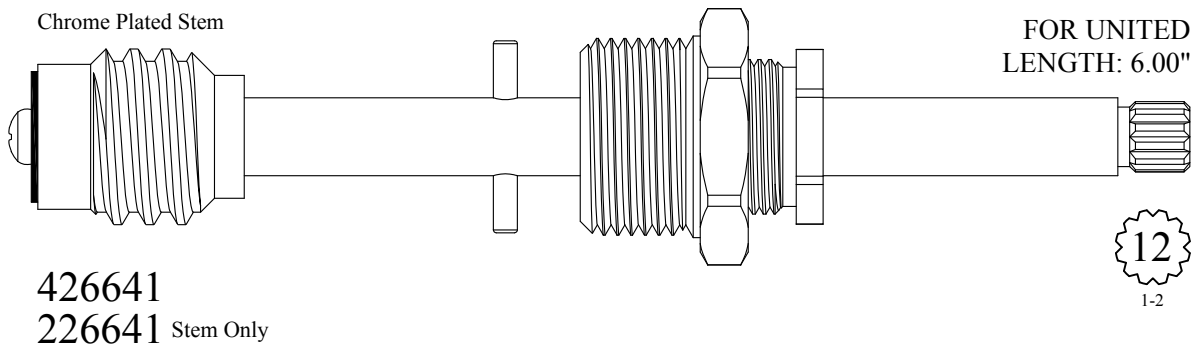
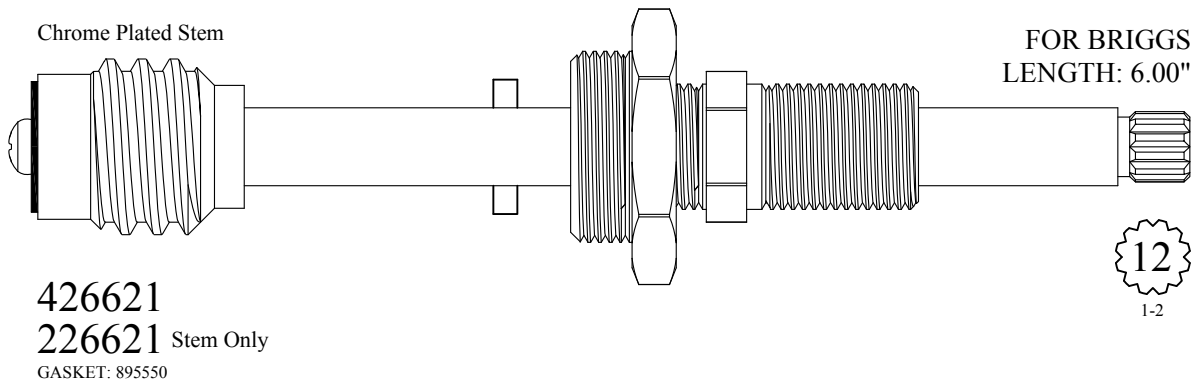
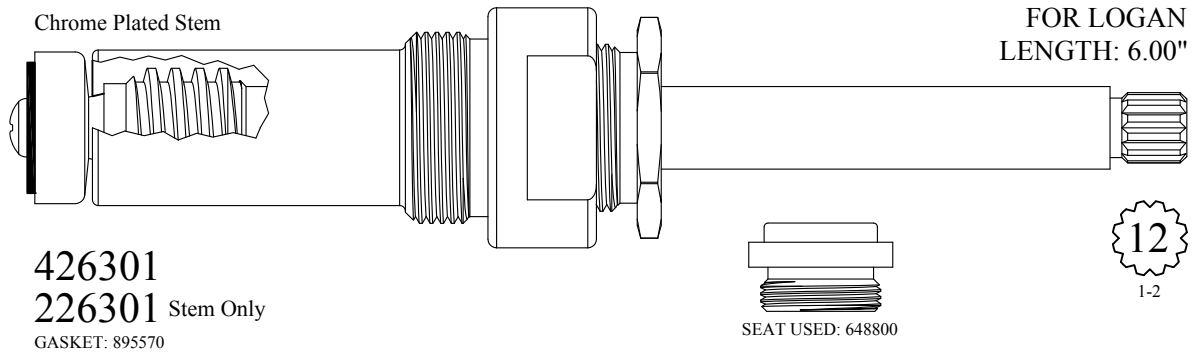

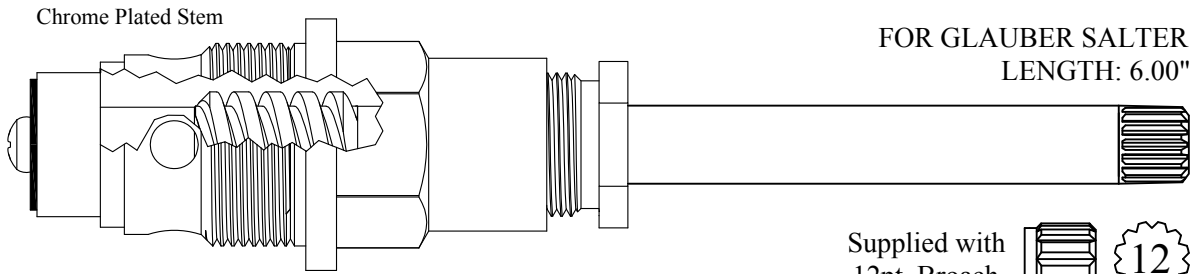

437451
 237451 Stem Only
 GASKET: 895440

Supplied with  12
 1-2

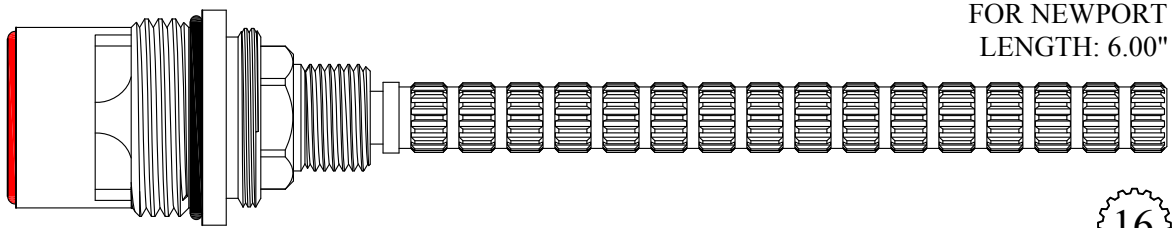

423651/ 423652
 GASKET: 890210 O-RING INCLUDED
 SEAL: 898610-R/B
 DISC SET: 109850-PKG

FOR NEWPORT
 LENGTH: 6.00"

 16
 3-16

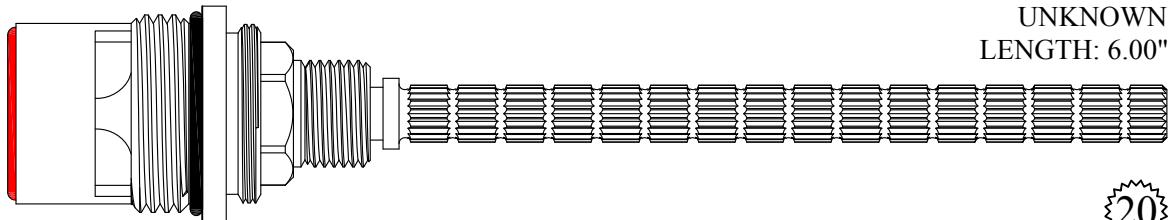

423671/ 423672
 GASKET: 890170 O-RING INCLUDED
 SEAL: 898610-R/B
 DISC SET: 109850-PKG

UNKNOWN
 LENGTH: 6.00"

 20
 3-20

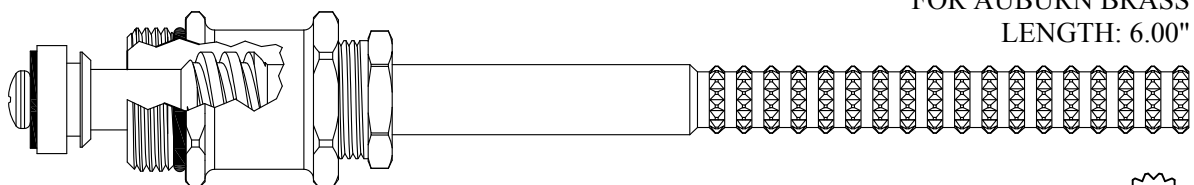

425811/ 425812
 225811/ 225812 Stem Only
 GASKET: 891150 O-RING INCLUDED

FOR AUBURN BRASS
 LENGTH: 6.00"

 16
 2-3

 SEAT USED: LF647450

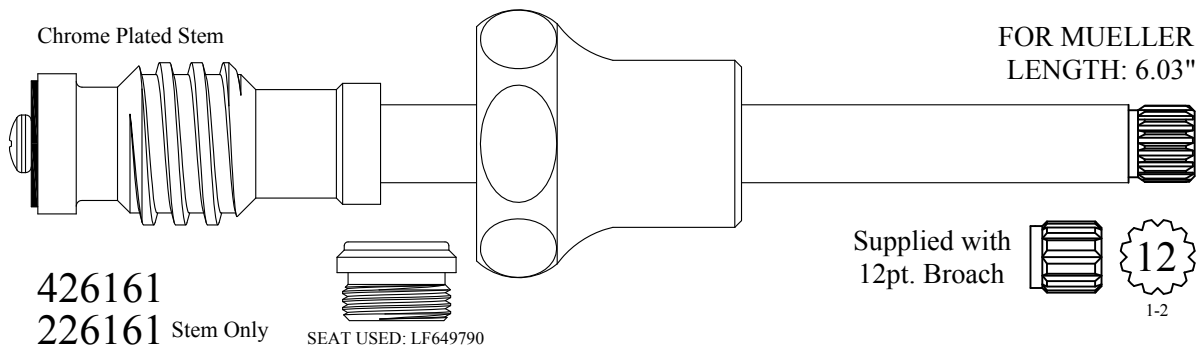
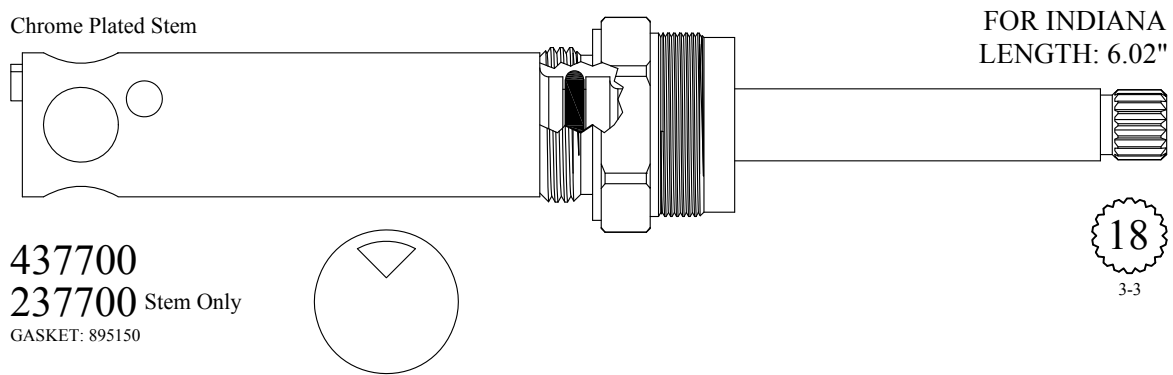
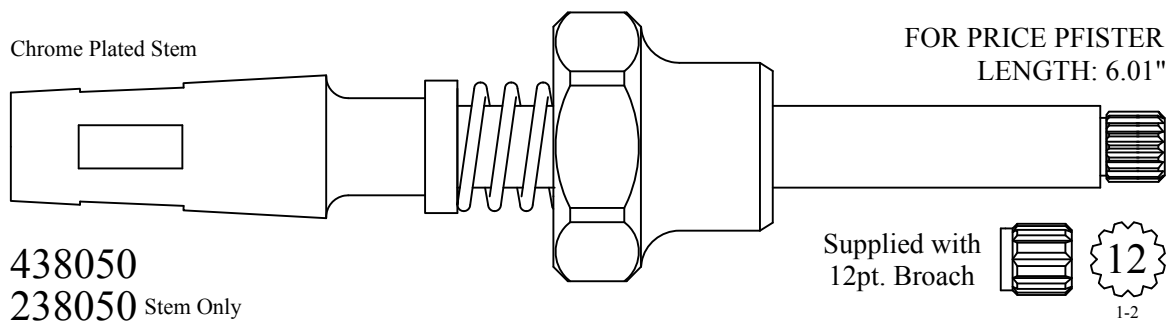
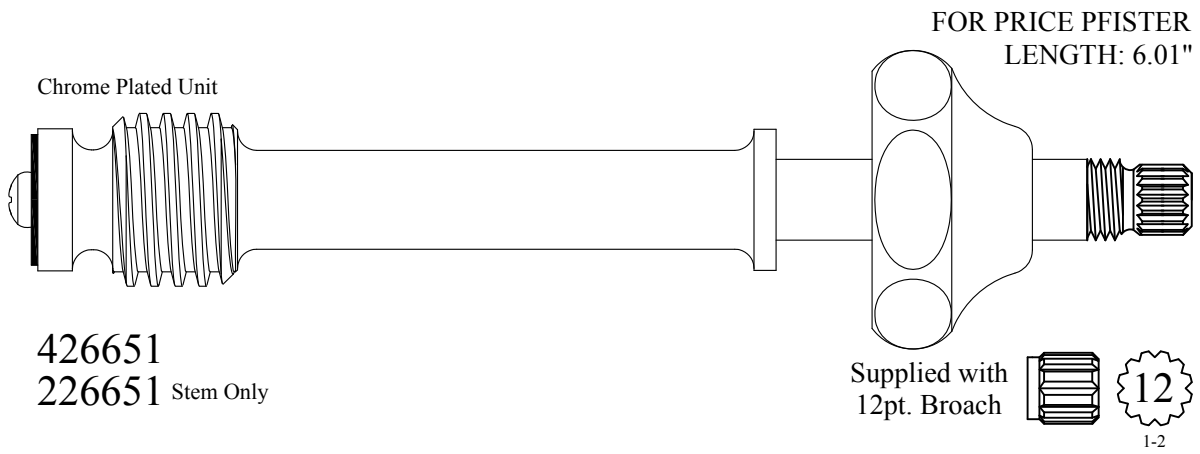

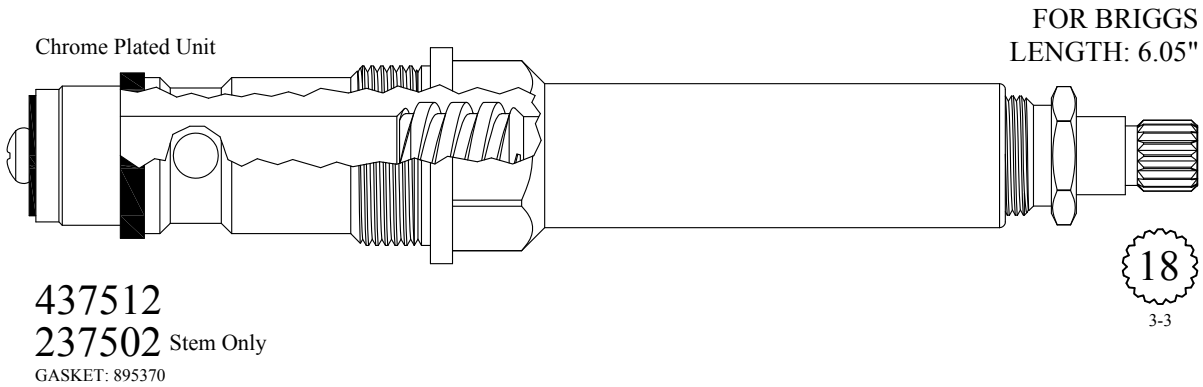
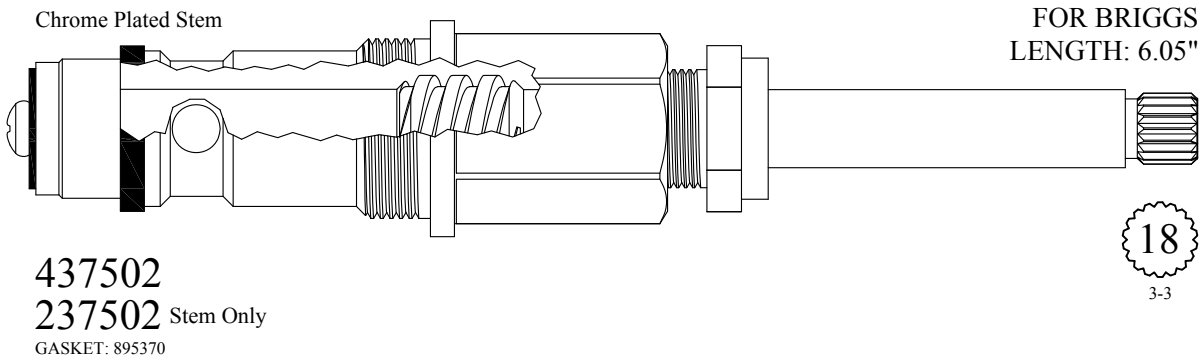
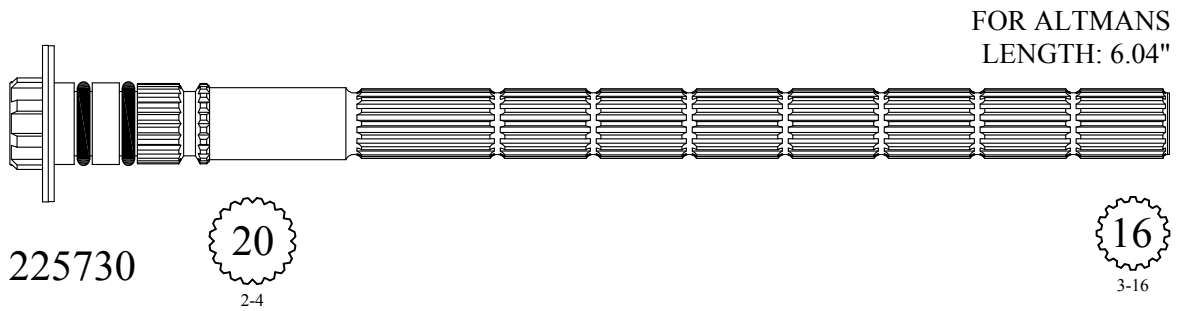
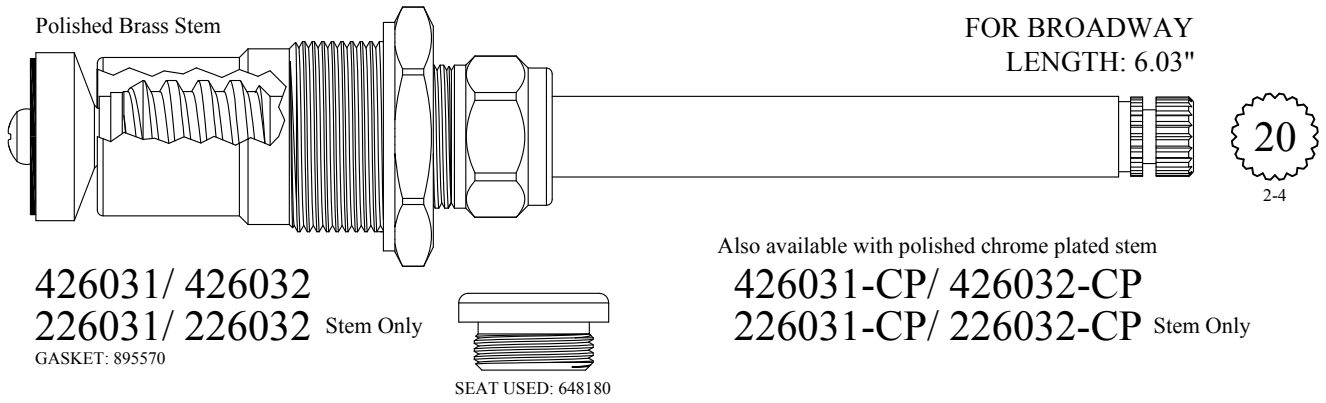

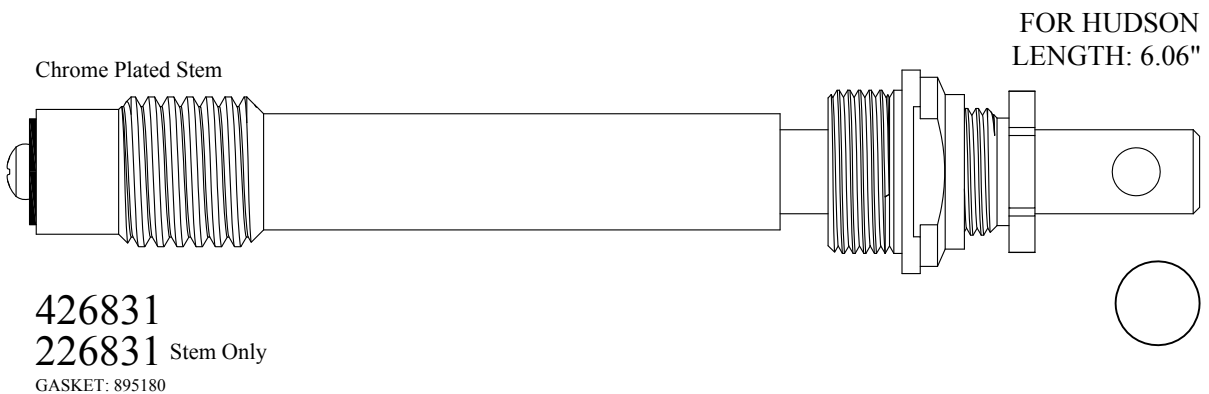
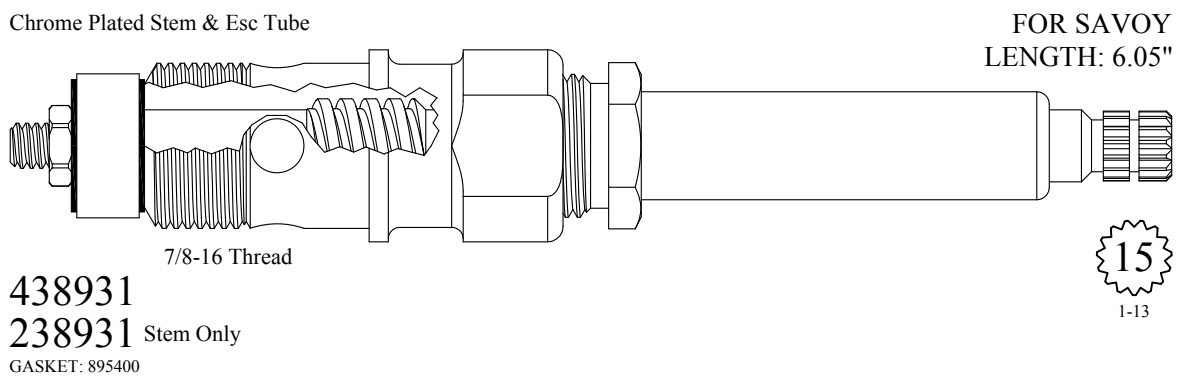
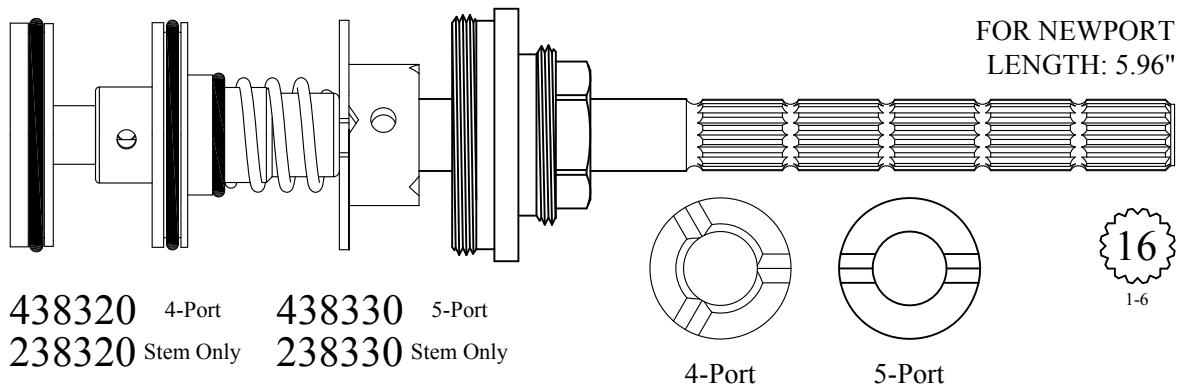
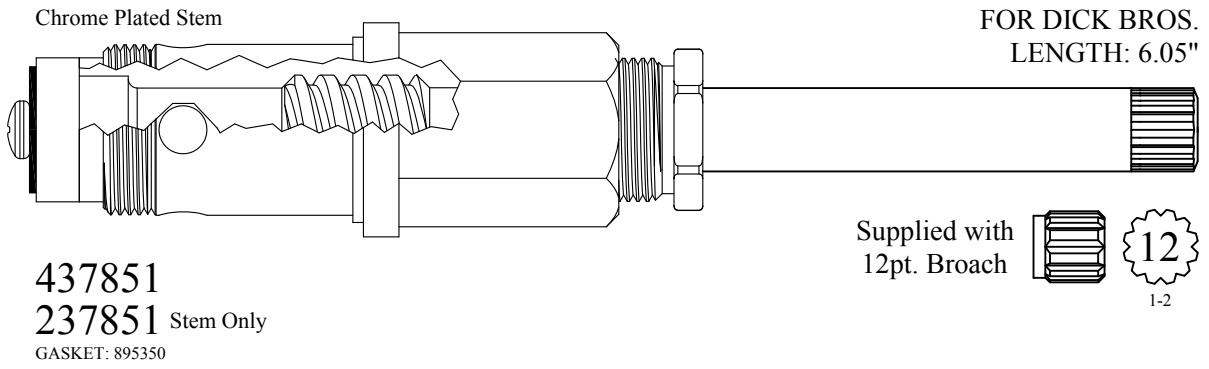

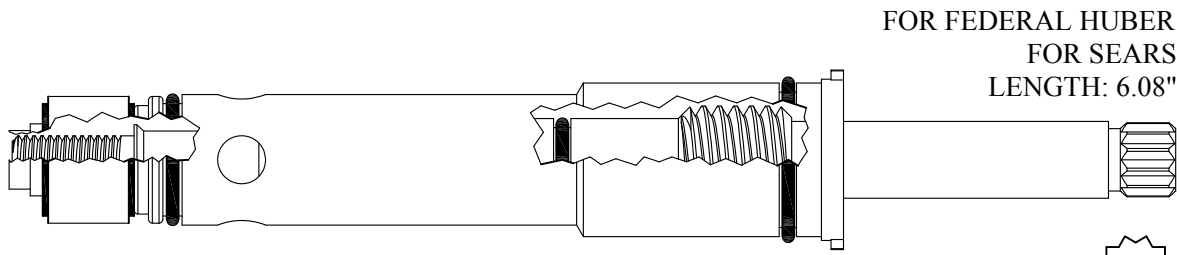

FOR FEDERAL HUBER
FOR SEARS
LENGTH: 6.08"

437011

12
3-10

Chrome Plated Stem

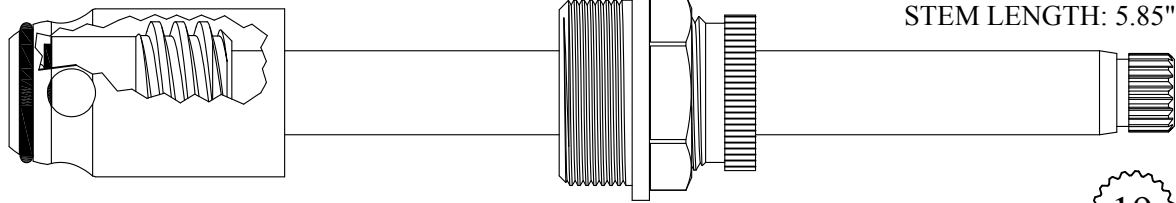

FOR KOHLER
STEM LENGTH: 5.85"

425931
225901 Stem Only
GASKET: 895350

USES BARREL:
647321

19
1-7

Chrome Plated Stem

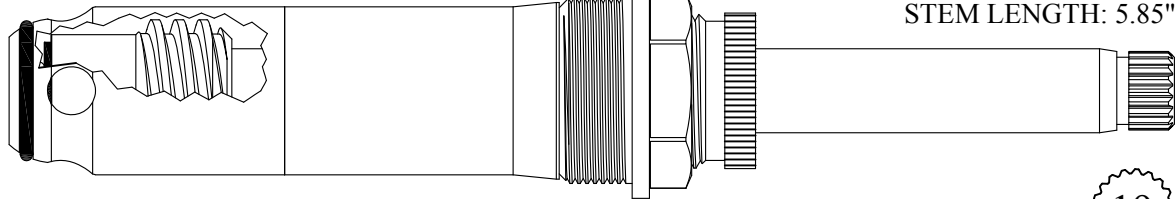

FOR KOHLER
STEM LENGTH: 5.85"

425901/ 425902
225901/ 225902 Stem Only
GASKET: 895350

USES BARREL:
647321/647322

19
1-7

Chrome Plated Stem

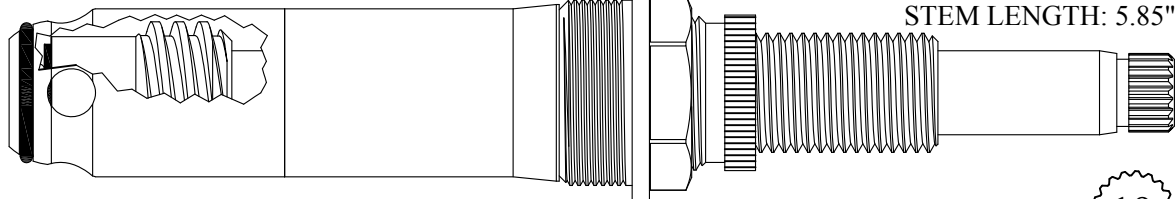

FOR KOHLER
STEM LENGTH: 5.85"

425911/ 425912
225901/ 225902 Stem Only
GASKET: 895350

USES BARREL:
647321/647322

19
1-7

Chrome Plated Stem

FOR KOHLER
STEM LENGTH: 5.85"

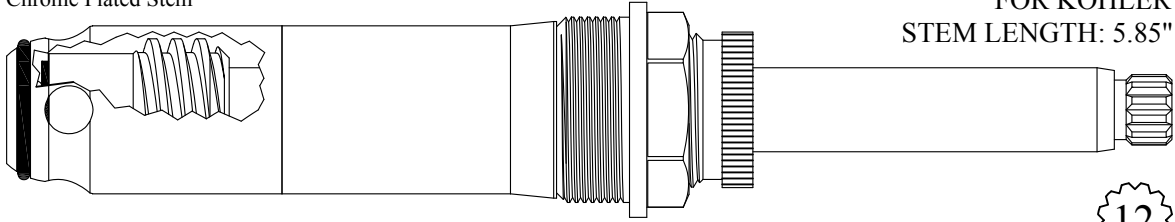

425951/ 425952
225951/ 225952 Stem Only
GASKET: 895350

USES BARREL:
647321/647322

12
1-2

Chrome Plated Stem & Packing Nut

FOR KOHLER
STEM LENGTH: 5.85"

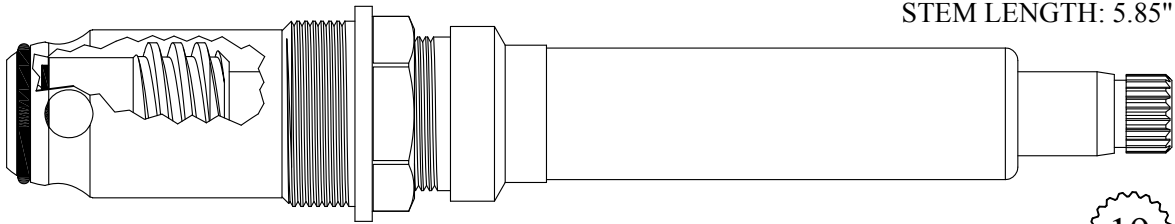

425961/ 425962
225901/ 225902 Stem Only
GASKET: 895350

USES BARREL:
647321/647322

19
1-7

Chrome Plated Stem

FOR FEDERAL HUBER
LENGTH: 6.08"

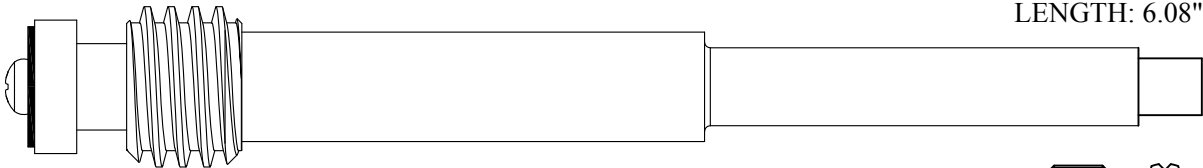

226631

Supplied with
12pt. Broach



12
1-2

437011

FOR FEDERAL HUBER
FOR SEARS
LENGTH: 6.08"

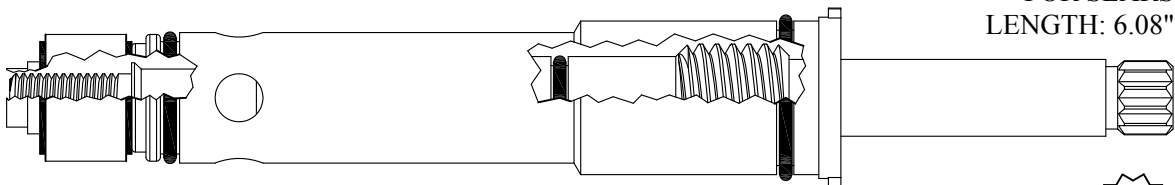

12
3-10

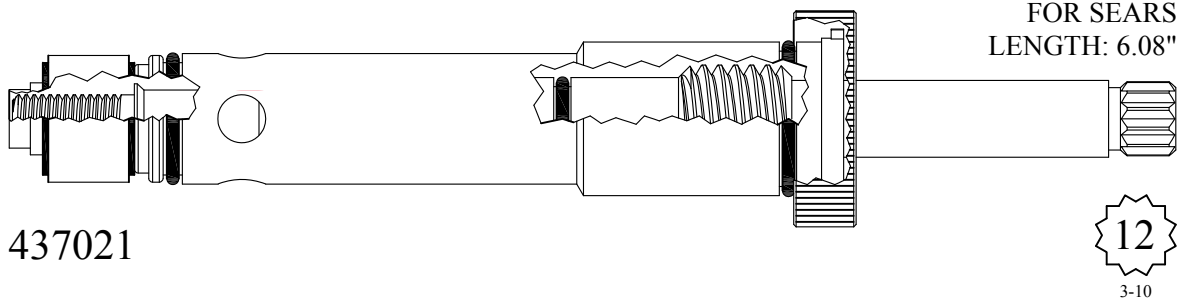

437021

12
3-10

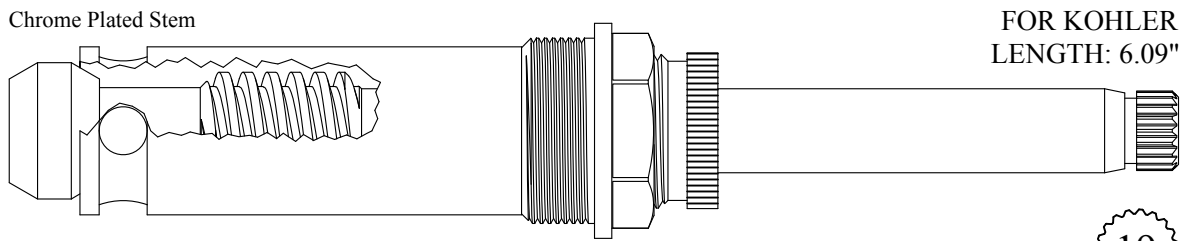

437301
237301 Stem Only
GASKET: 895350

Also available with seat 649700
437301-S

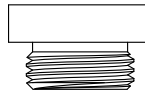

19
1-7

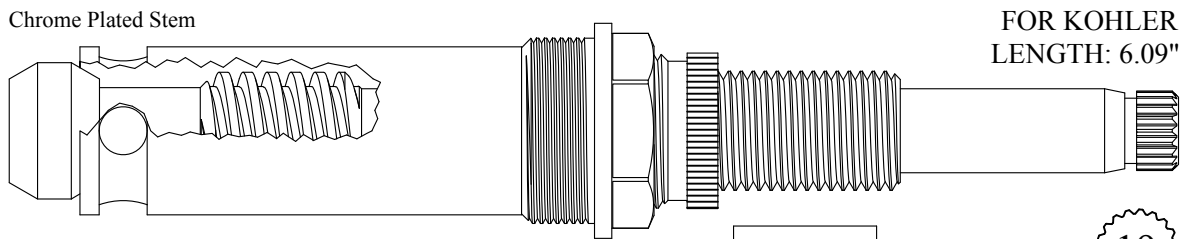

437331
237301 Stem Only
GASKET: 895350

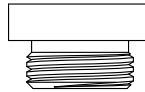

SEAT USED: 649700

19
1-7

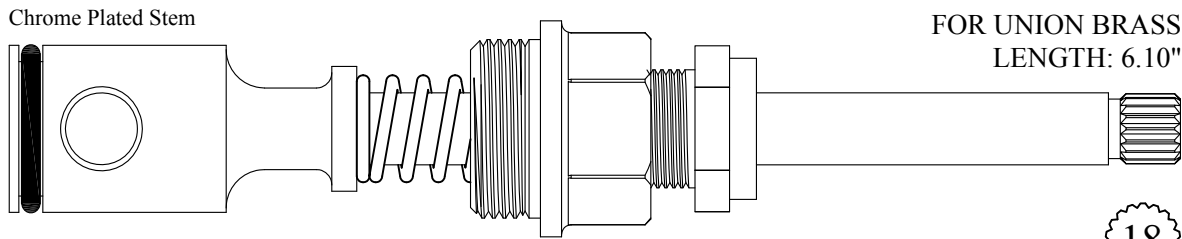

437900
237900 Stem Only
GASKET: 895330

18
3-3

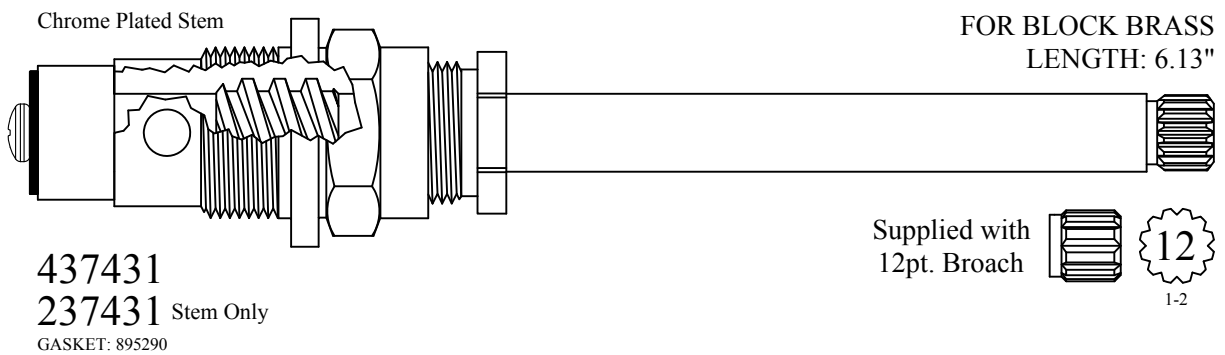
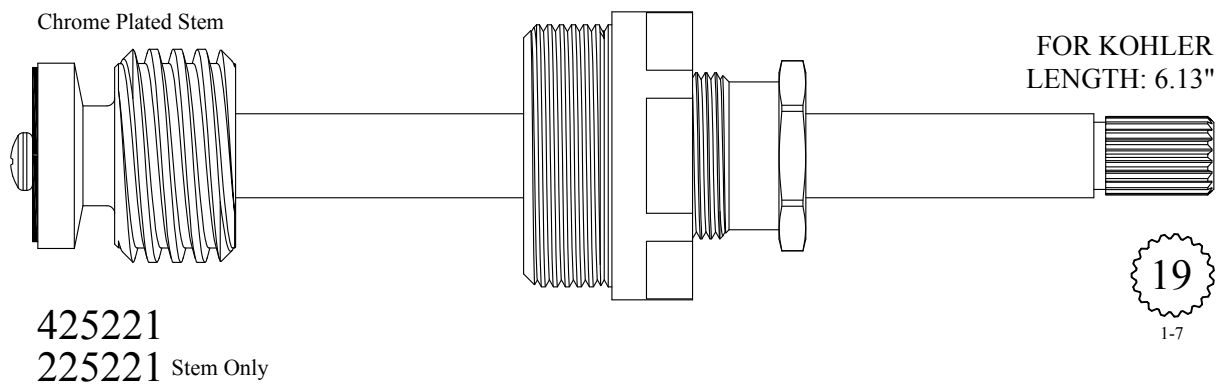
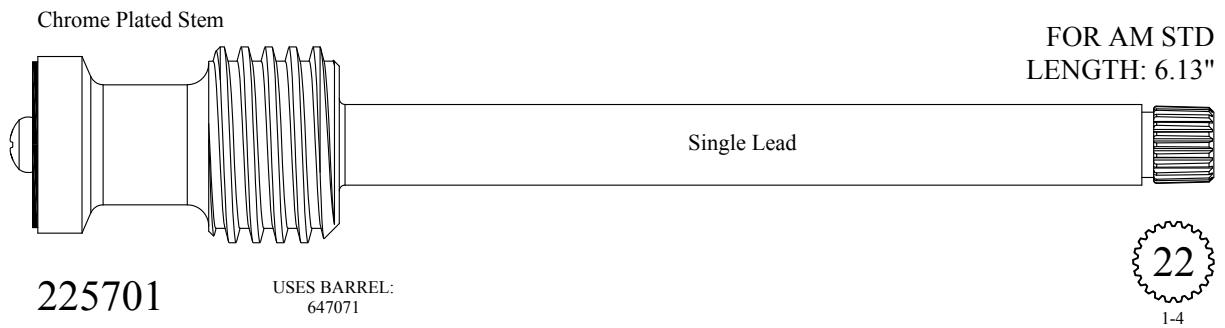
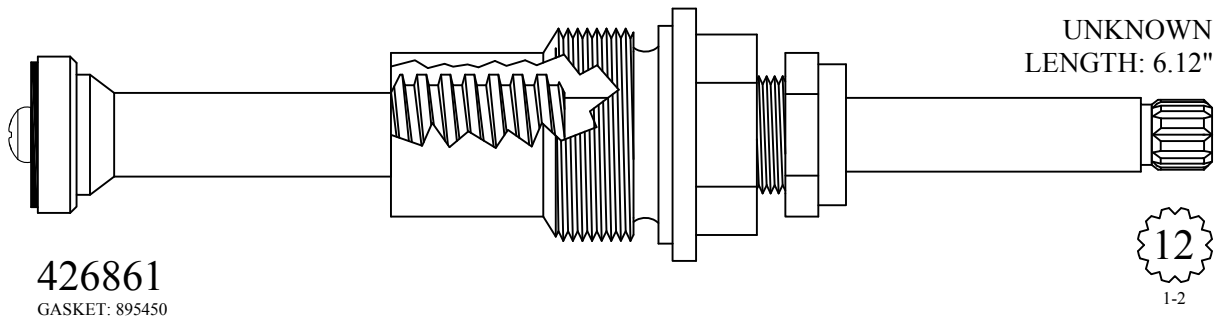

Chrome Plated Stem

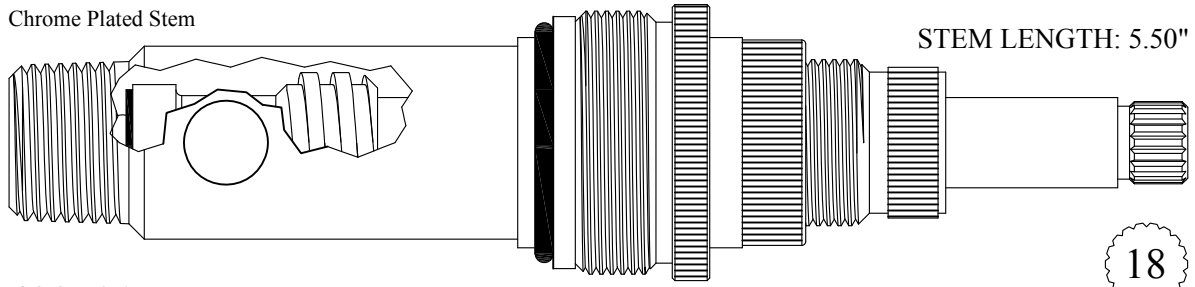

STEM LENGTH: 5.50"

18

422701

222701 Stem Only

GASKET: 891210 O-RING INCLUDED

Chrome Plated Stem

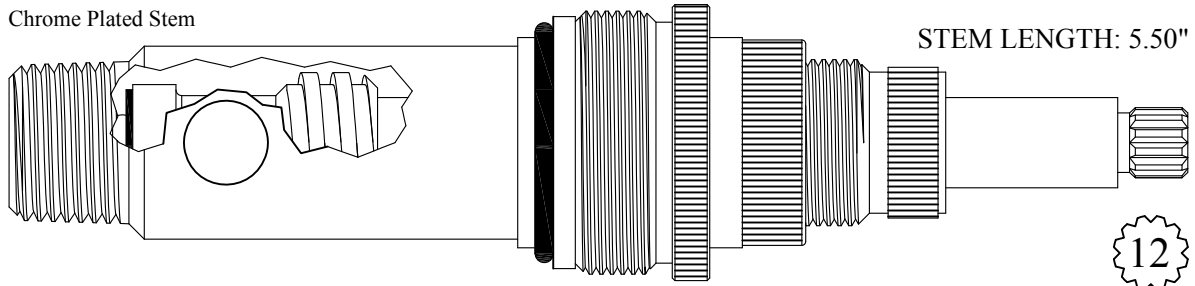

STEM LENGTH: 5.50"

12
1-2

422751

222751 Stem Only

GASKET: 891210 O-RING INCLUDED

Chrome Plated Stem

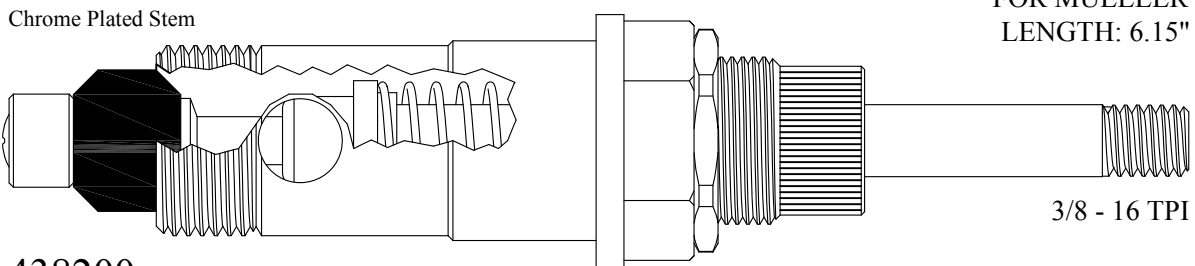

FOR MUELLER
LENGTH: 6.15"

3/8 - 16 TPI

438200

238200 Stem Only

GASKET: 895440

Chrome Plated Stem

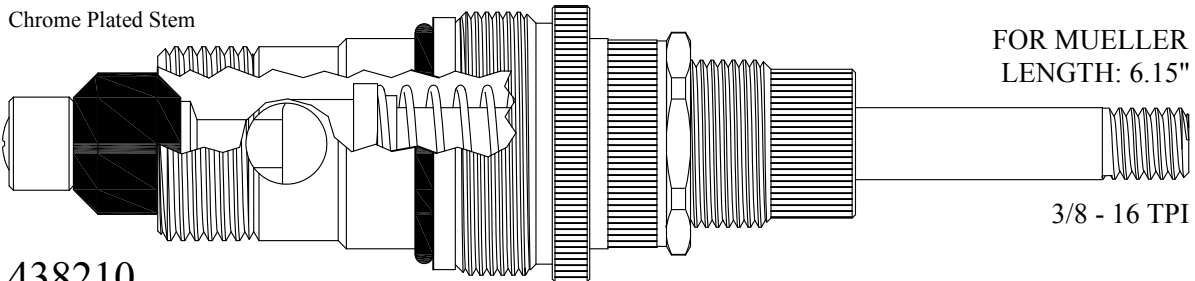

FOR MUELLER
LENGTH: 6.15"

3/8 - 16 TPI

438210

238200 Stem Only

GASKET: 895440

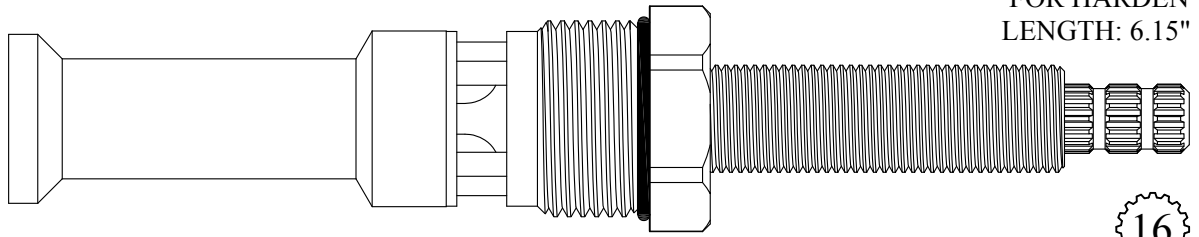

FOR HARDEN
LENGTH: 6.15"

426411/ 426412

GASKET: 890210 O-RING INCLUDED
SEAL: 64705-07
DISC SET: 151380-PKG



3-16

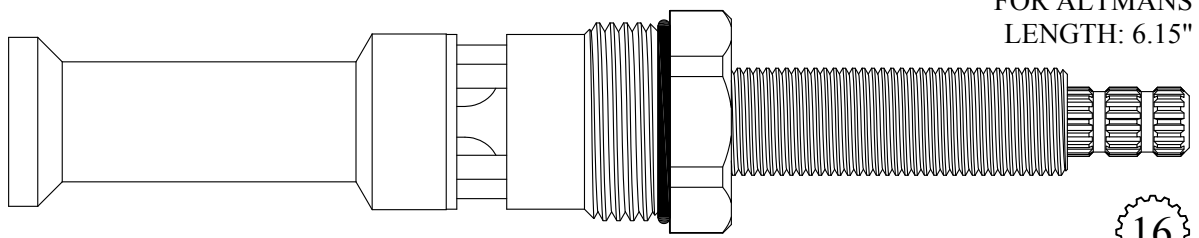

FOR ALTMANS
LENGTH: 6.15"

426421/ 426422 (Replaces Walter# 418811 / 418812 Compression Units)

GASKET: 890210 O-RING INCLUDED
SEAL: 898510-W
DISC SET: 151380-PKG



3-16

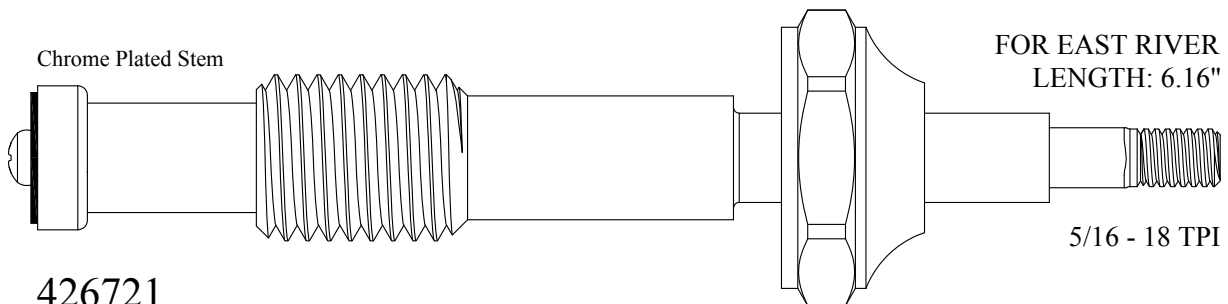

Chrome Plated Stem

FOR EAST RIVER
LENGTH: 6.16"

426721

226721 Stem Only

5/16 - 18 TPI

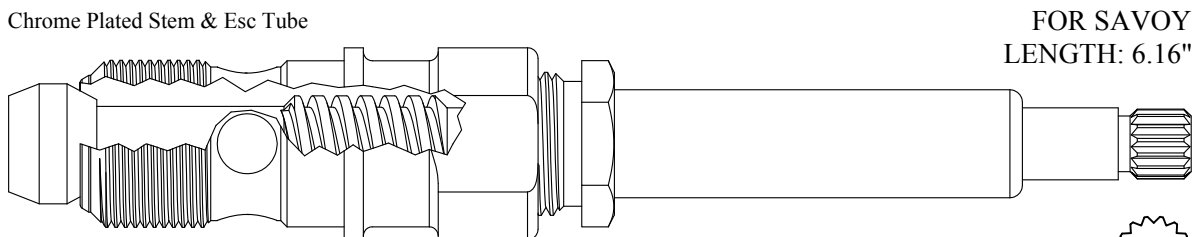

Chrome Plated Stem & Esc Tube

FOR SAVOY
LENGTH: 6.16"

438911

238911 Stem Only

GASKET: 895400



1-13

Chrome Plated Stem & Esc Tube

FOR SAVOY
LENGTH: 6.16"

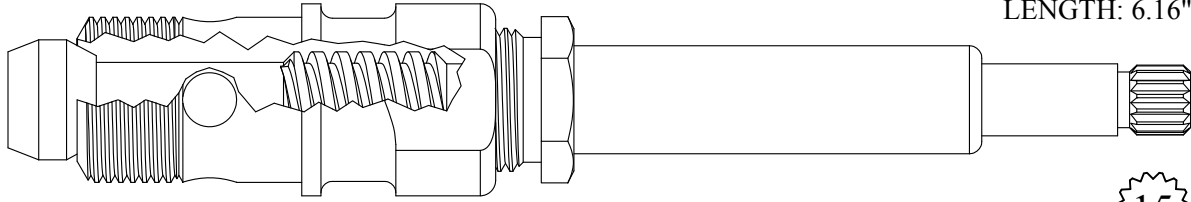

7/8-16 Thread

438941

238911 Stem Only

GASKET: 895400



1-13

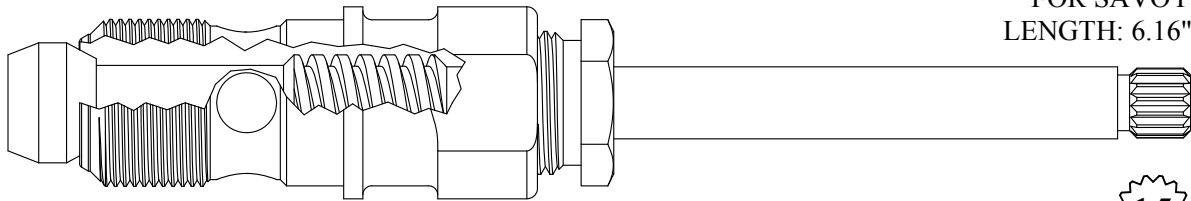

FOR SAVOY
LENGTH: 6.16"

438951

238951 Stem Only

GASKET: 895400



1-13

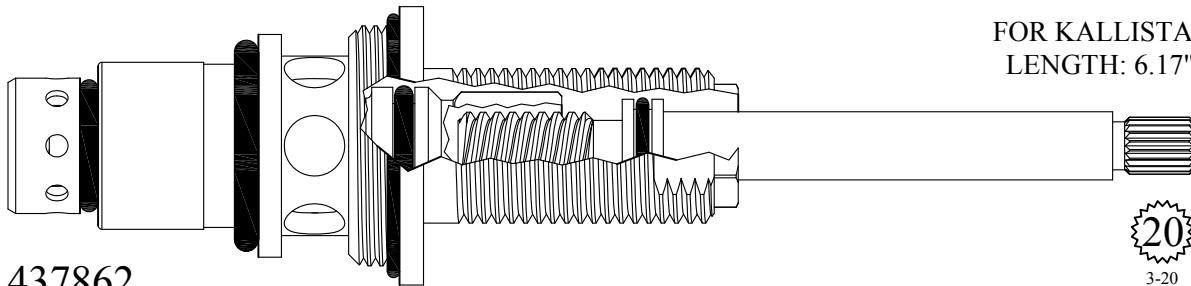

FOR KALLISTA
LENGTH: 6.17"

437862

GASKET: 890240 O-RNG INCLUDED



3-20

Chrome Plated Stem

FOR PRICE PFISTER
LENGTH: 6.17"

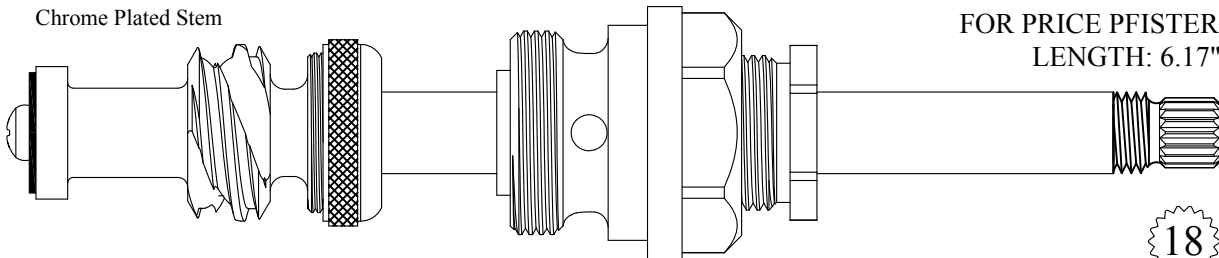

438301

238301 Stem Only

GASKET: 895450



Old Style
Price Pfister

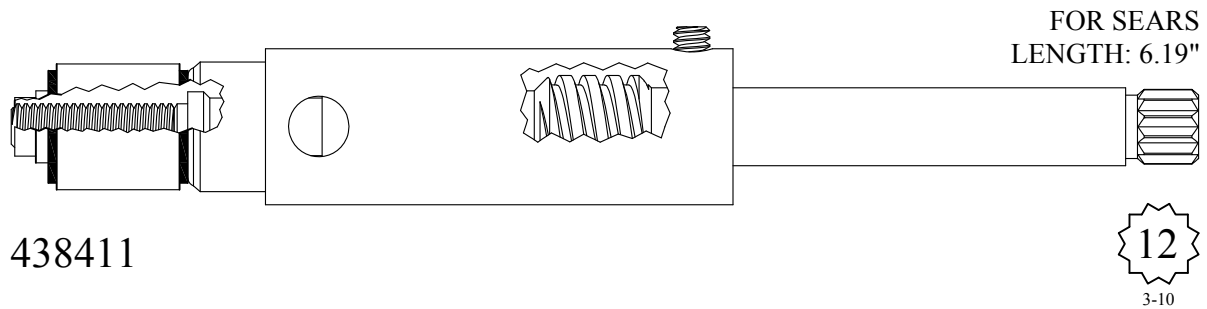
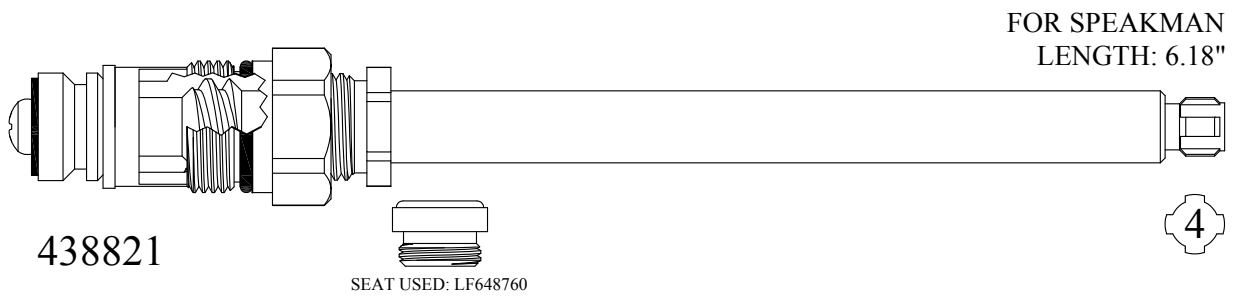
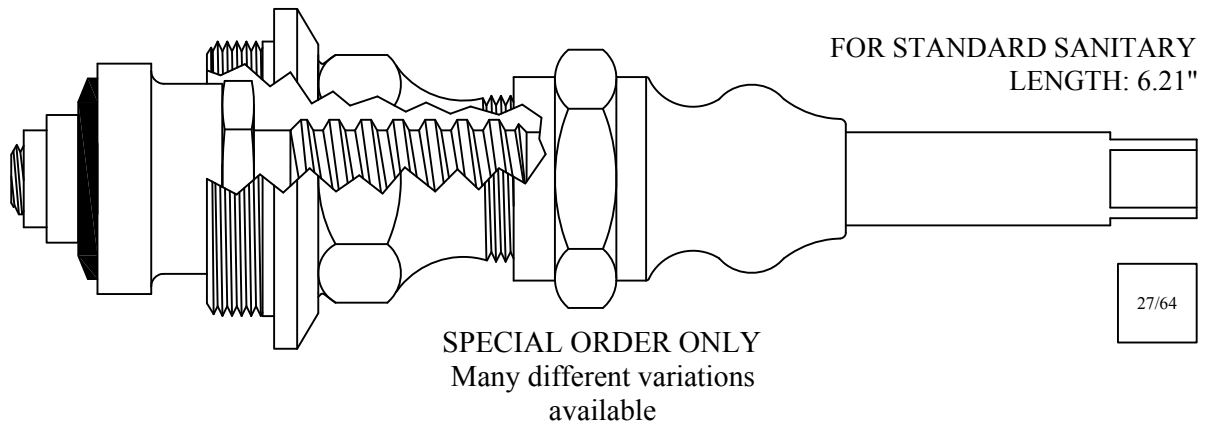
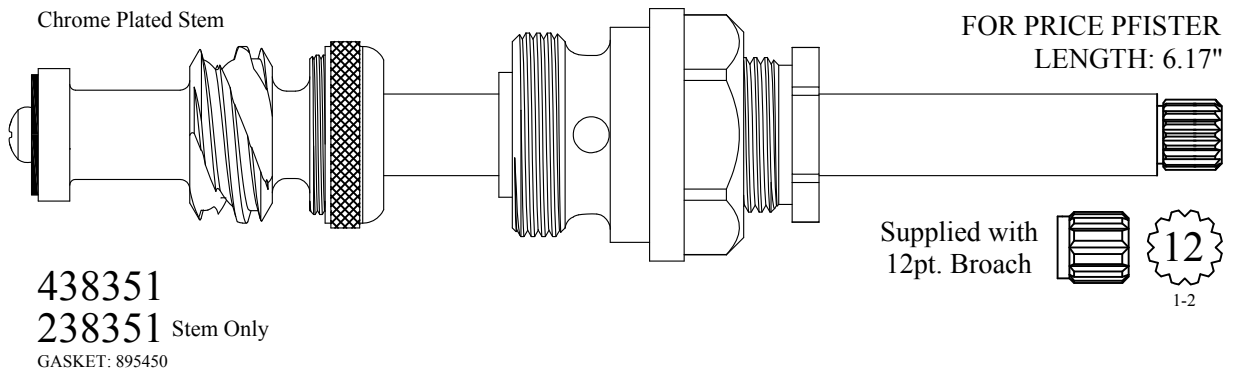

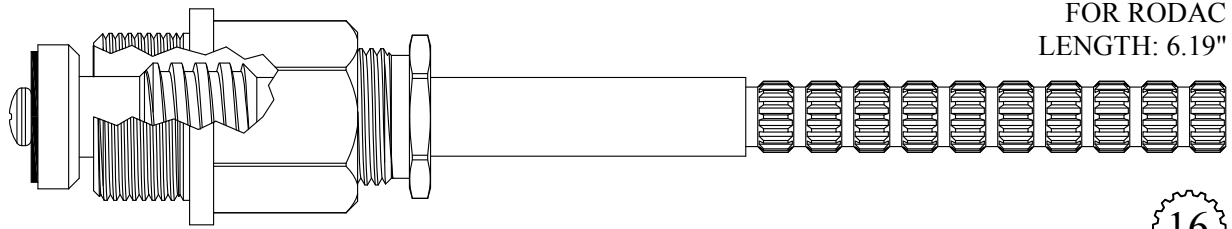

FOR RODAC
LENGTH: 6.19"



421711/ 421712
221711/ 221712 Stem Only
GASKET: 895400

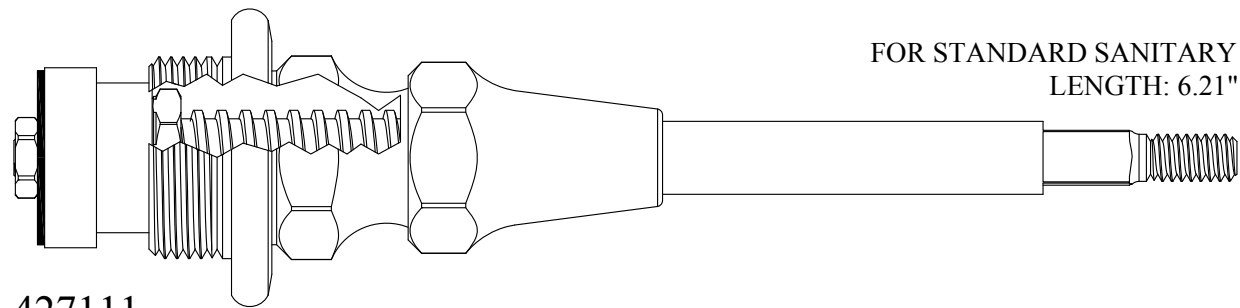

FOR STANDARD SANITARY
LENGTH: 6.21"

427111
GASKET: 895440

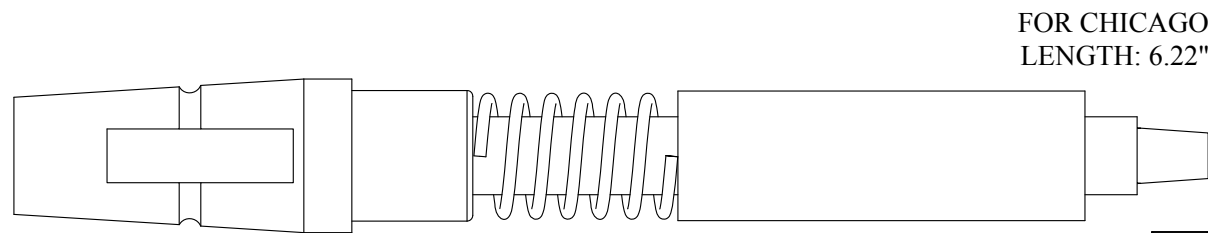

FOR CHICAGO
LENGTH: 6.22"

238840

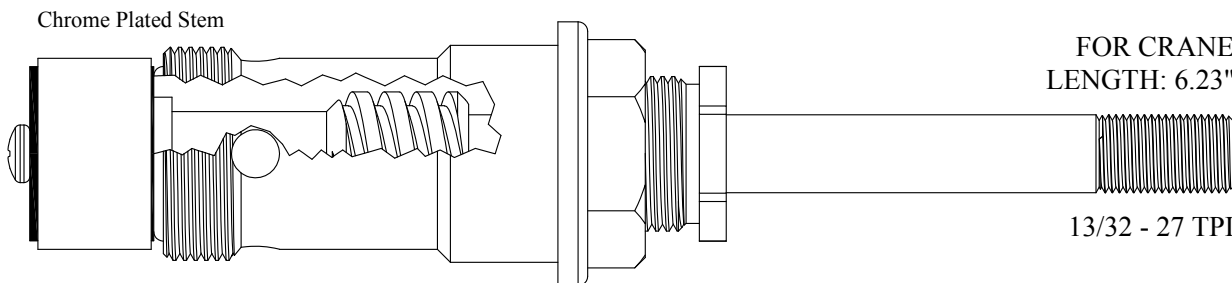

FOR CRANE
LENGTH: 6.23"

13/32 - 27 TPI

438601
238601 Stem Only
GASKET: 895450

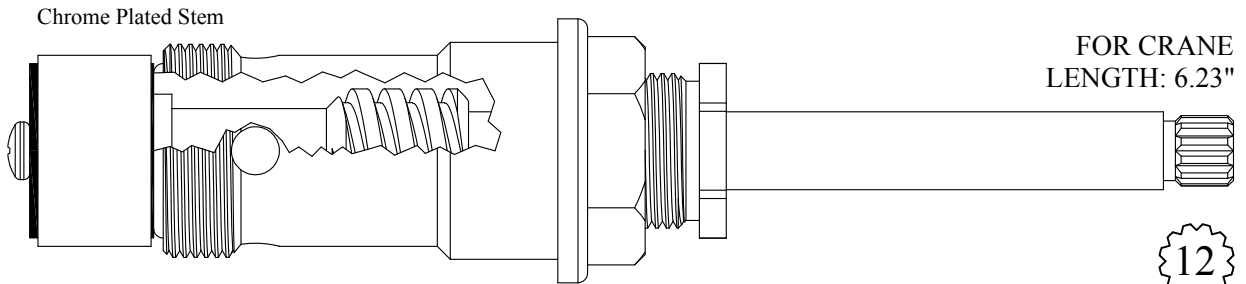

438651
 238651 Stem Only
 GASKET: 895450

12
 1-2

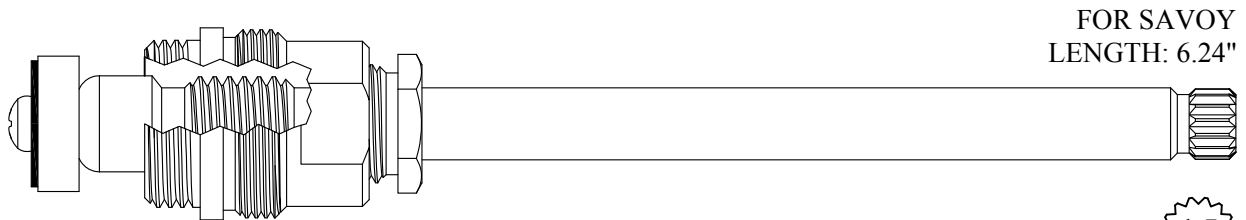

426741
 226741 Stem Only
 GASKET: 895400



15
 1-13

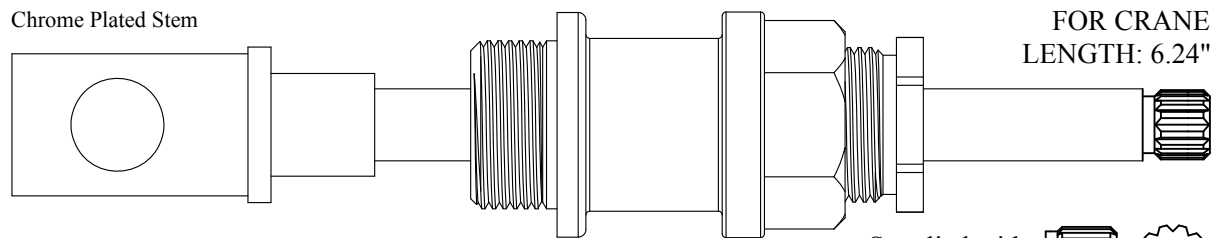

438550
 238550 Stem Only
 GASKET: 895400

Supplied with
 12pt. Broach



12
 1-2



438850
 238850 Stem Only

Supplied with
 12pt. Broach



12
 1-2

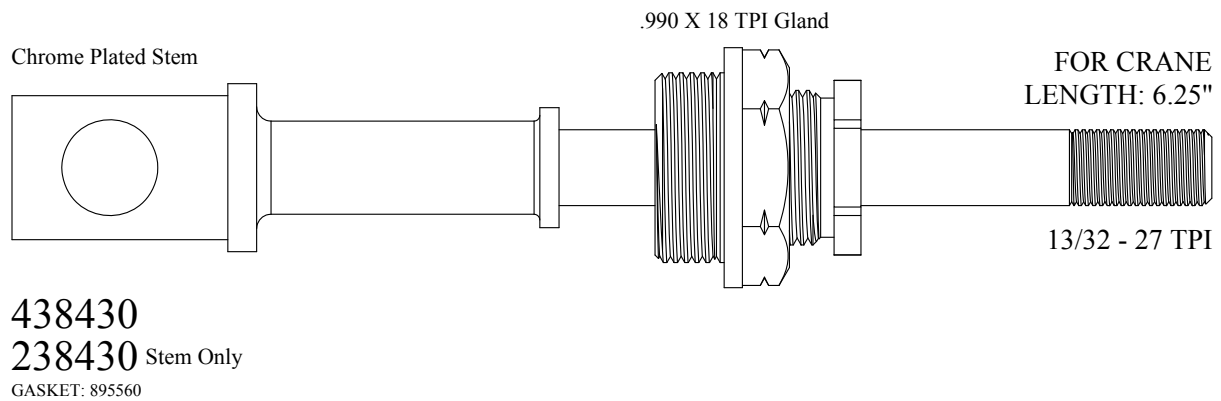
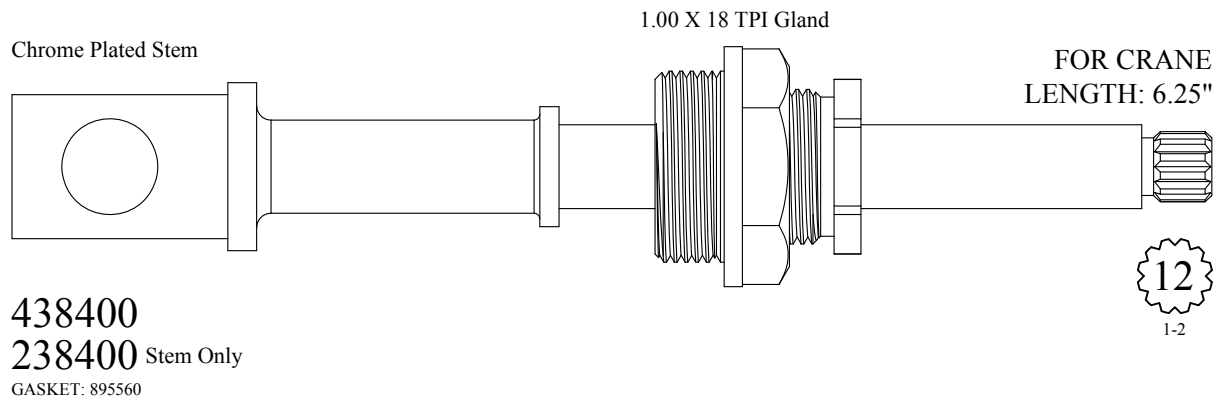
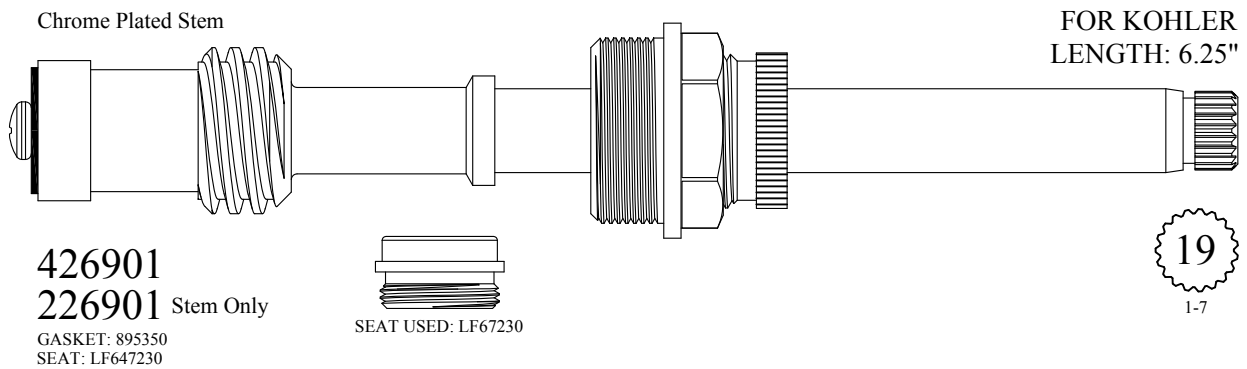
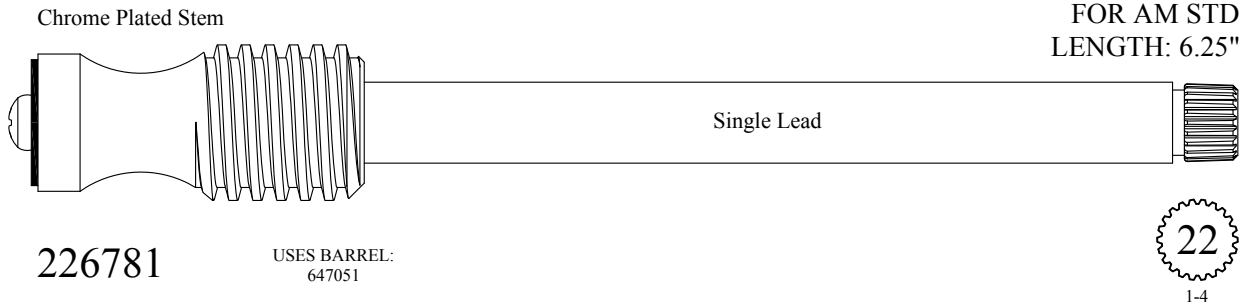

Chrome Plated Stem

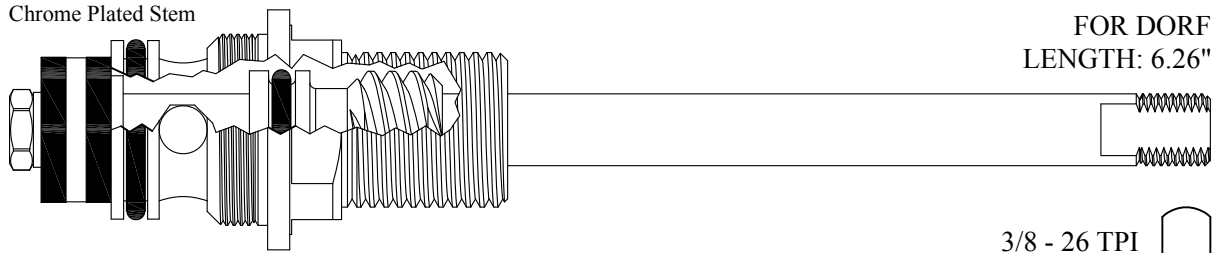

FOR DORF
LENGTH: 6.26"

3/8 - 26 TPI



438511
GASKET: 895550

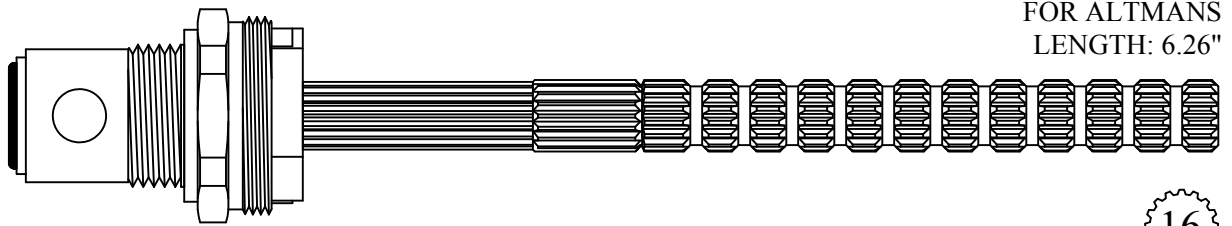

FOR ALTMANS
LENGTH: 6.26"



426731/ 426732
GASKET: 895100

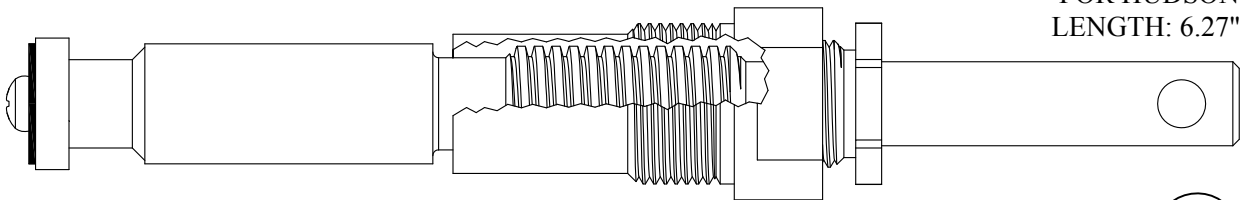

FOR HUDSON
LENGTH: 6.27"



427121
227121 Stem Only
GASKET: 895380

Chrome Plated Sleeve

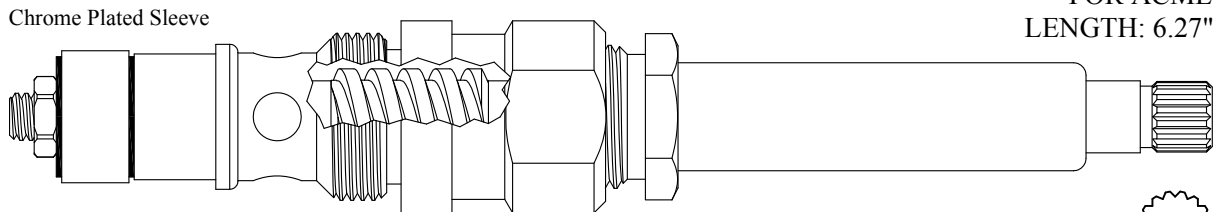

FOR ACME
LENGTH: 6.27"



438611
238611 Stem Only
GASKET: 895180

FOR ACME
LENGTH: 6.27"

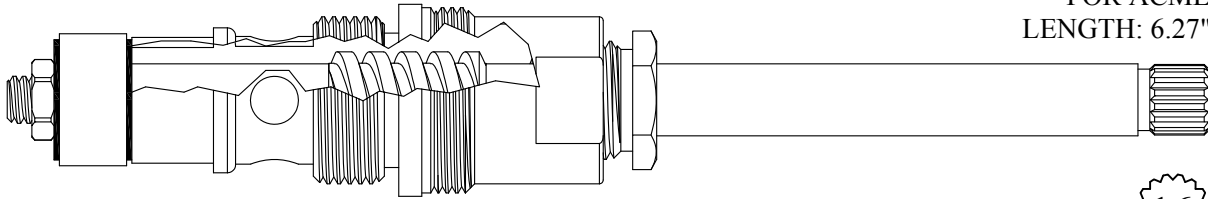

438621
238611 Stem Only
GASKET: 895180

16
1-6

FOR AM BRASS
LENGTH: 6.29"

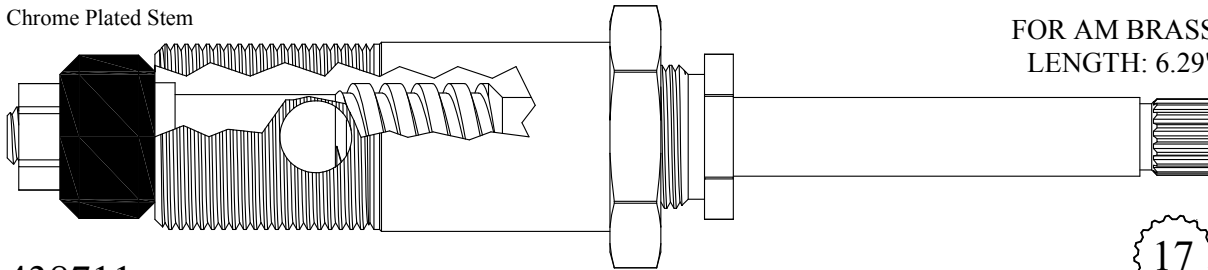

438711
238711 Stem Only
GASKET: 895550

17
3-7

FOR KOHLER
LENGTH: 6.29"

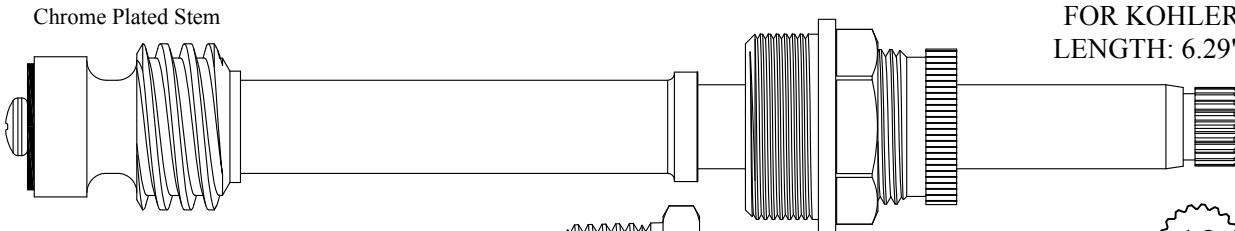

LF480501/ LF480502
LF280501/ LF280502 Stem Only
GASKET: 895350

19
1-7

SEAT USED: LF647500

FOR BROADWAY
LENGTH: 6.33"

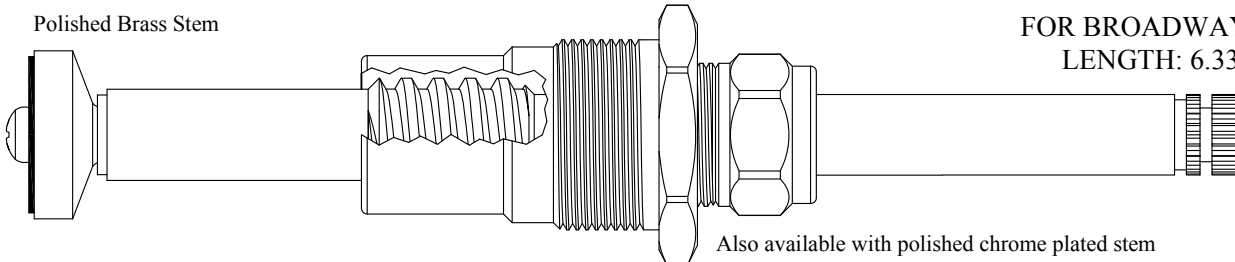

426931/ 426932
226931/ 226932 Stem Only
GASKET: 895570

Also available with polished chrome plated stem
426931-CP/ 426932-CP
226931-CP/ 226932-CP Stem Only

20
2-4

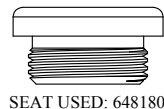

SEAT USED: 648180

Polished Brass Stem

FOR BROADWAY
LENGTH: 6.34"

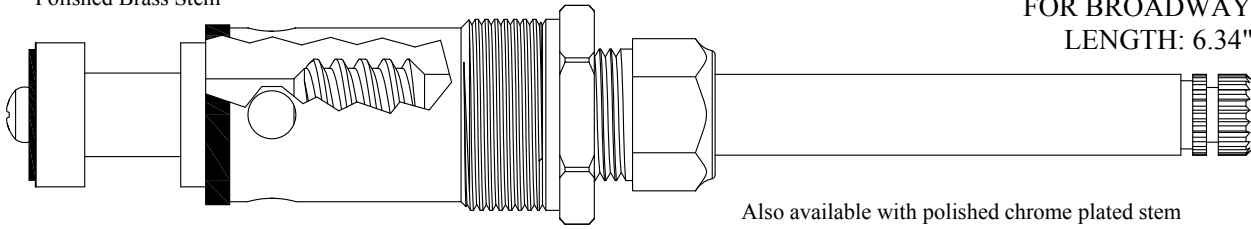

20
2-4

438311
238311 Stem Only

Also available with polished chrome plated stem

438311-CP
238311-CP Stem Only

Chrome Plated Stem

Also available less bonnet
426521-B

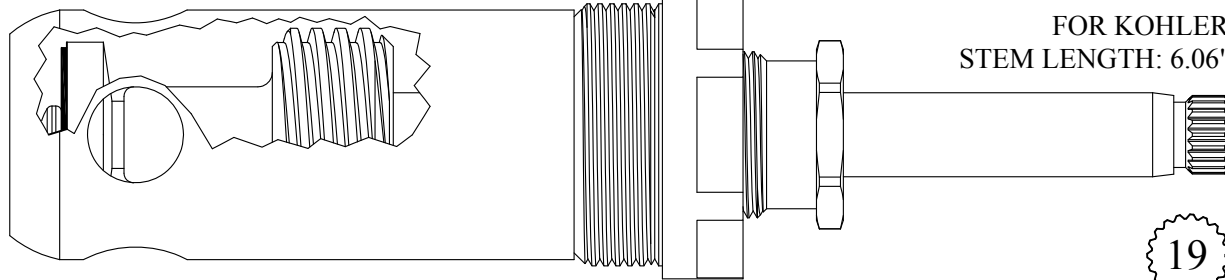

FOR KOHLER
STEM LENGTH: 6.06"

19
1-7

426521
226521 Stem Only

USES BARREL:
647361

Chrome Plated Stem

FOR GLAUBER WEST COAST
LENGTH: 6.38"

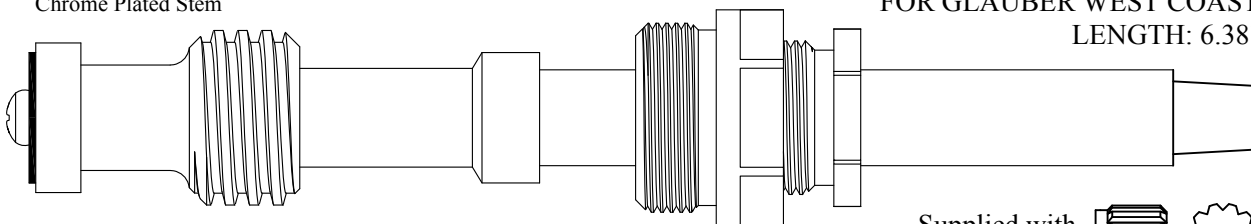

Supplied with
12pt. Broach



12
1-2

424351
224351 Stem Only
GASKET: 895550

FOR ARTISTIC BRASS
LENGTH: 6.39"

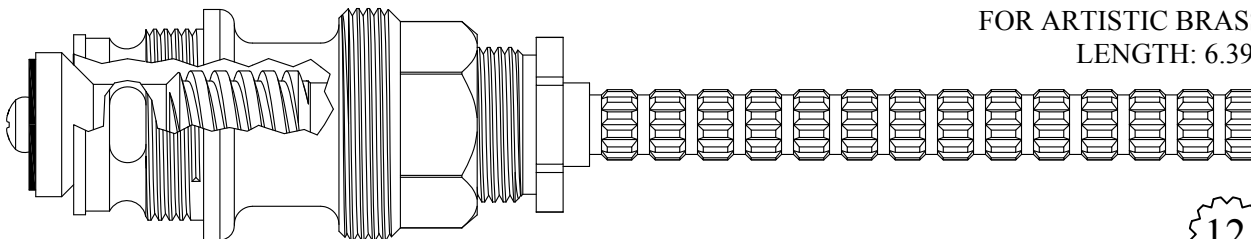

12
1-2

438831
238831 Stem Only
GASKET: 895550



SEAT USED: 648370

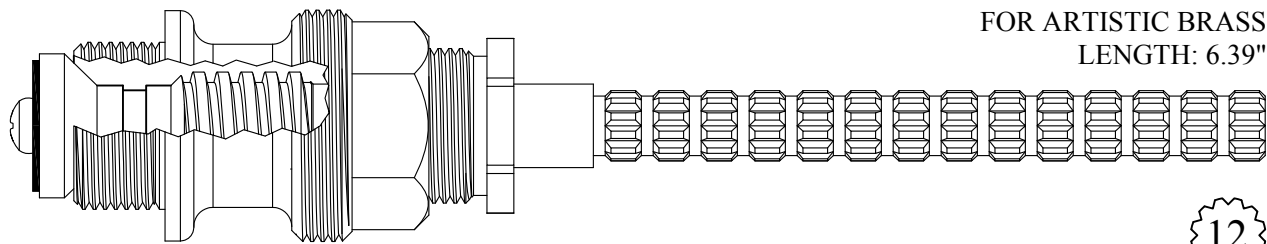

FOR ARTISTIC BRASS
LENGTH: 6.39"

12
1-2

426911/ 426912

226911/ 226912 Stem Only

GASKET: 895400



SEAT USED: 648370

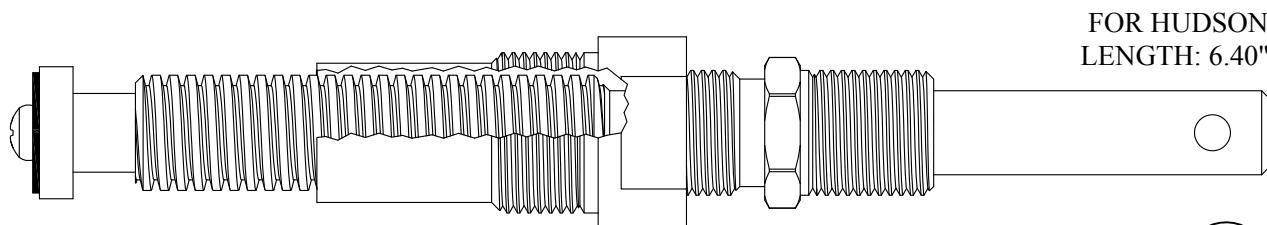

FOR HUDSON
LENGTH: 6.40"



427131

227131 Stem Only

GASKET: 895380

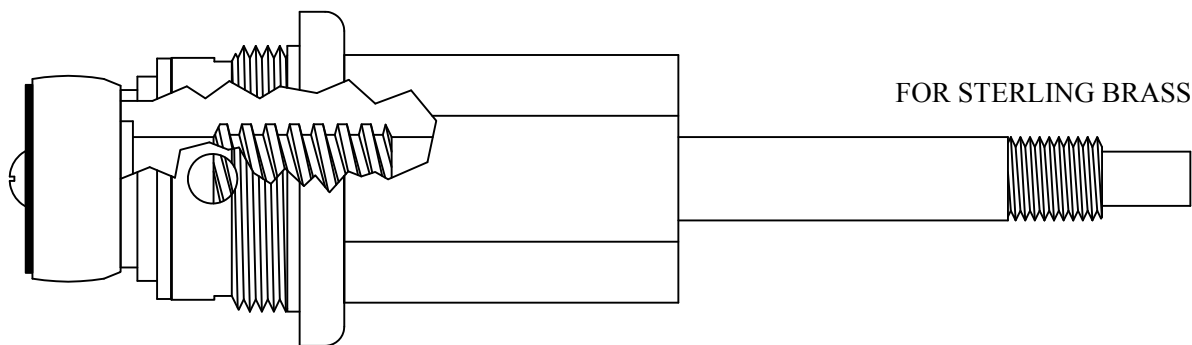

FOR STERLING BRASS

Not Available, Use 438101

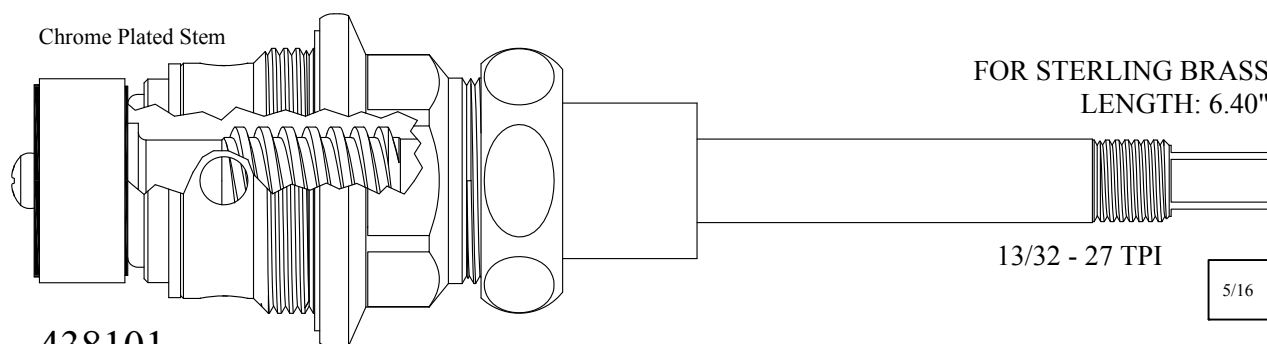

Chrome Plated Stem

FOR STERLING BRASS
LENGTH: 6.40"

13/32 - 27 TPI

5/16

438101

238101 Stem Only

GASKET: 895500

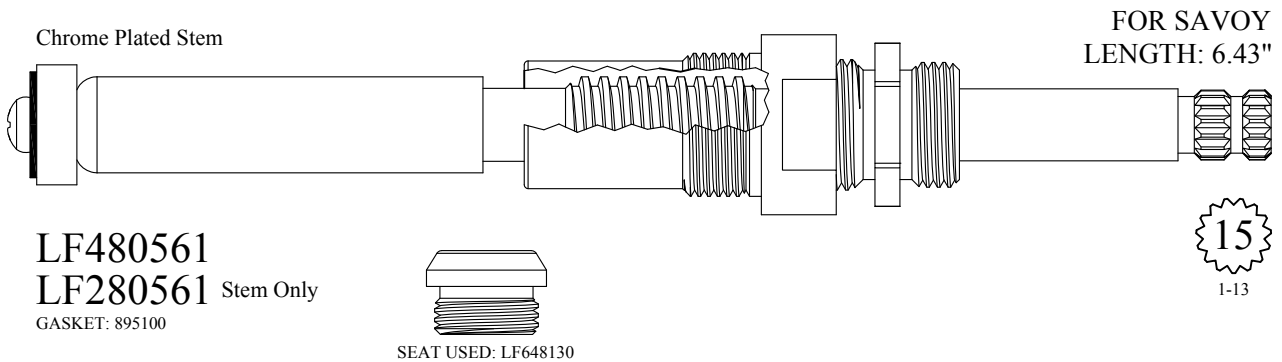
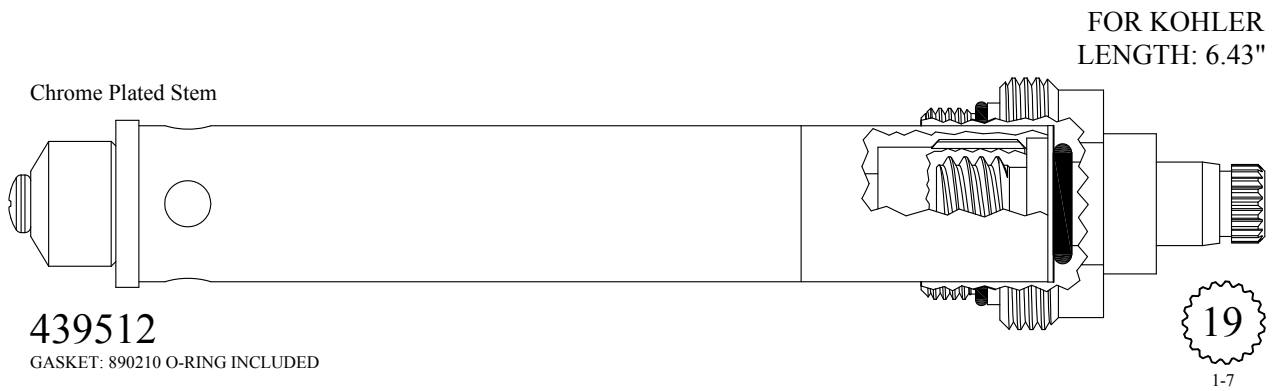
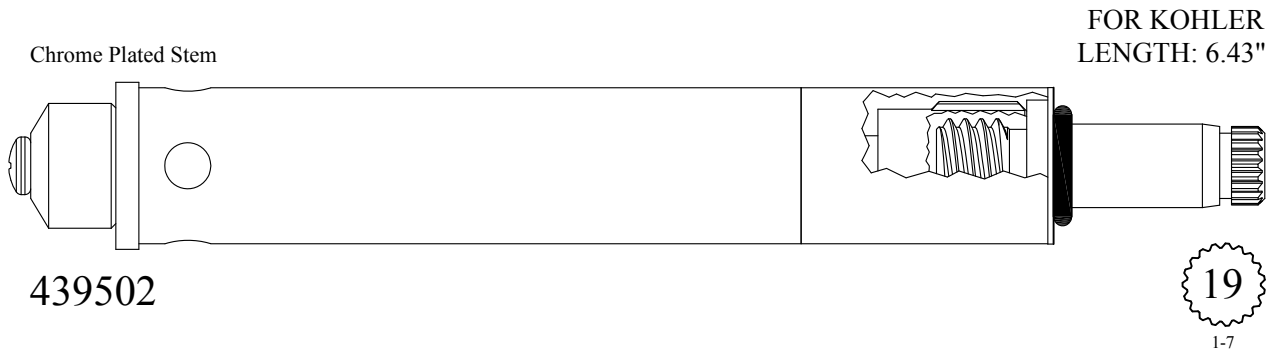
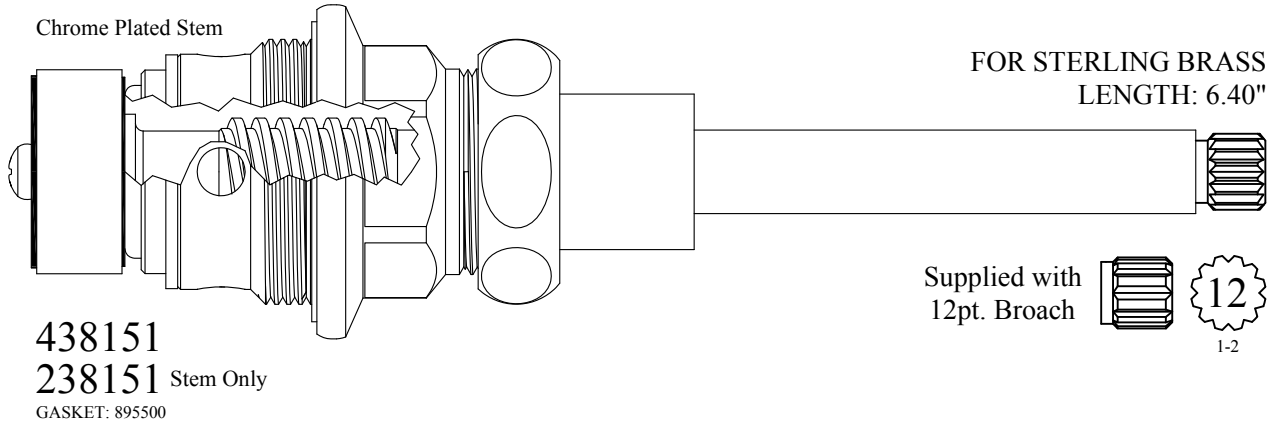

Chrome Plated Stem

FOR ROYAL BRASS
LENGTH: 6.44"

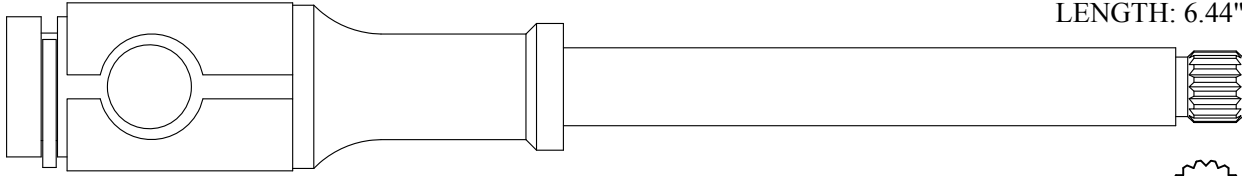

239420

16
1-6

Chrome Plated Stem

FOR AM STD
LENGTH: 6.44"

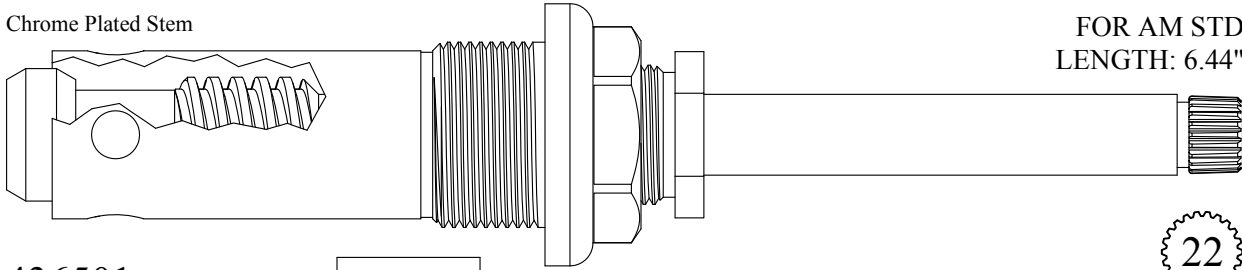

436501
236501 Stem Only
GASKET: 818000

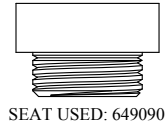

SEAT USED: 649090

22
1-4

Chrome Plated Stem & Esc Tube

FOR SAVOY
LENGTH: 6.44"

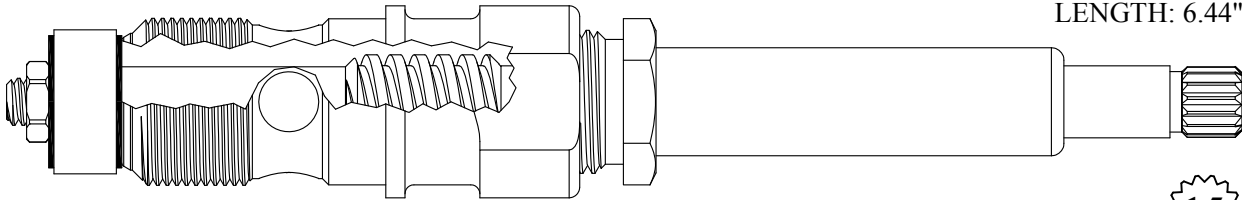

7/8-20 Thread

438901
238901 Stem Only
GASKET: 895400

15
1-13

Chrome Plated Stem

FOR ROYAL BRASS
LENGTH: 6.44"

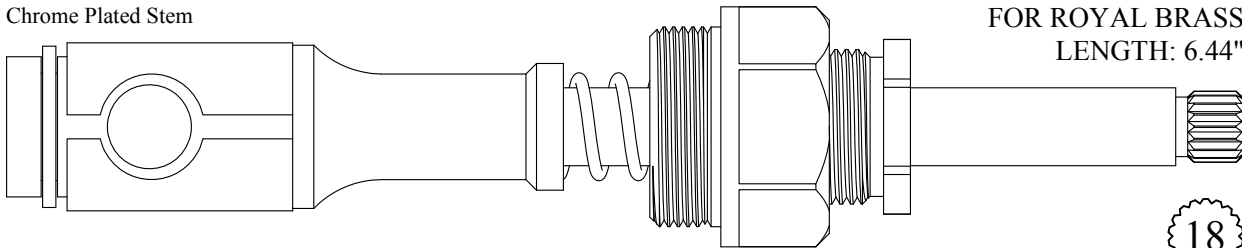

439400
239400 Stem Only
GASKET: 895560

18
3-3

Chrome Plated Stem

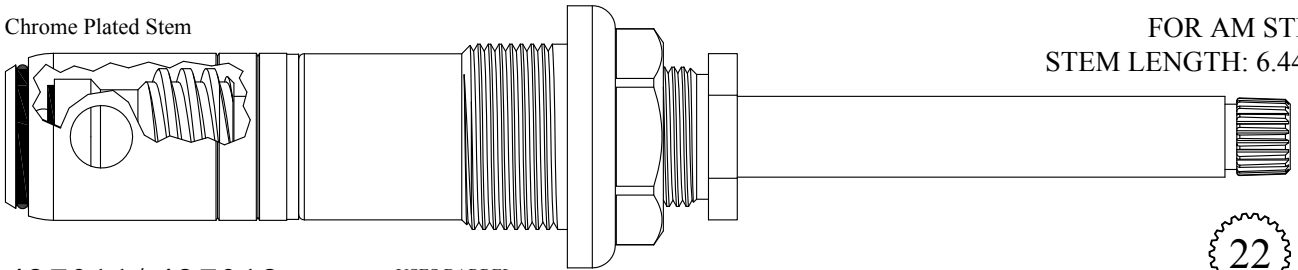

FOR AM STD
STEM LENGTH: 6.44"

427011/ 427012
227011/ 227012 Stem Only
GASKET: 818000

USES BARREL:
LF647021/LF647022

22
1-4

Chrome Plated Stem

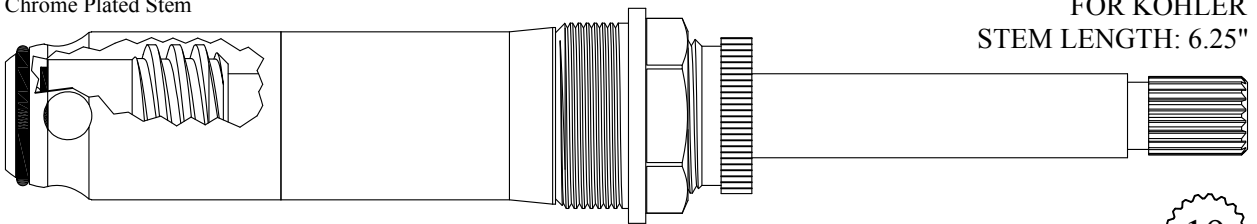

FOR KOHLER
STEM LENGTH: 6.25"

426701
226701 Stem Only
GASKET: 895350

USES BARREL:
647321

19
1-7

Chrome Plated Stem

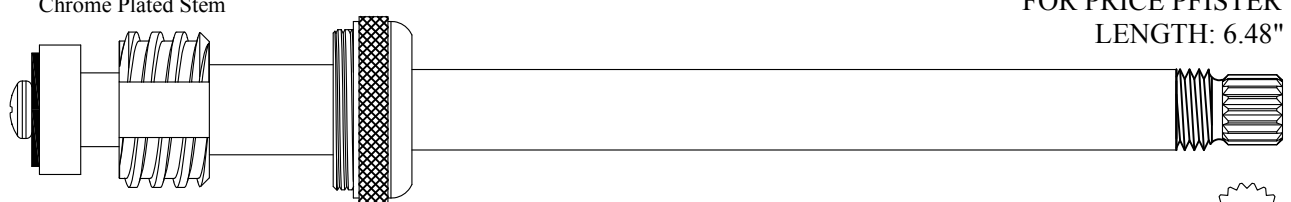

FOR PRICE PFISTER
LENGTH: 6.48"

239152

18
Old Style
Price Pfister

Chrome Plated Stem

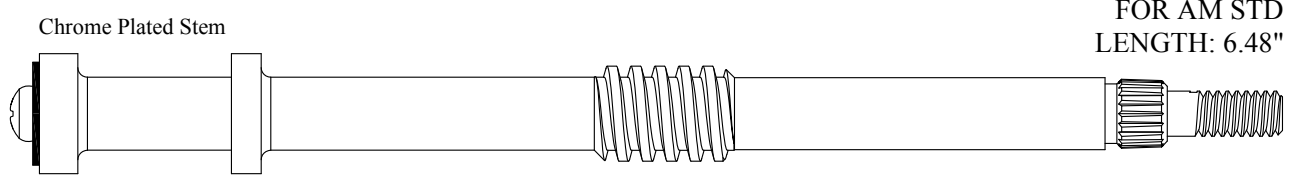

FOR AM STD
LENGTH: 6.48"

LF280511

20
3-14

FOR ALTMANS
LENGTH: 6.49"

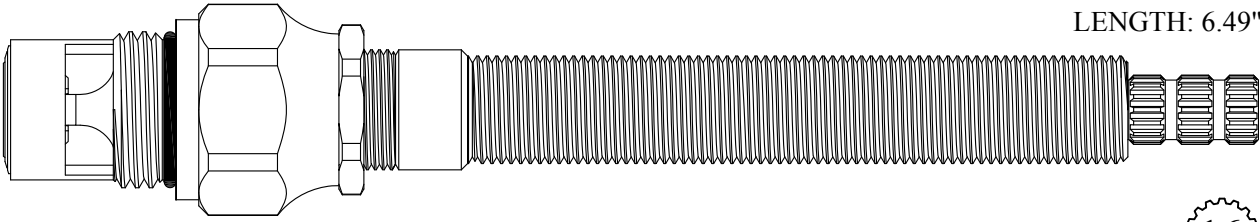

426841/ 426842 (459201 / 459202 w/ Ceramic Adapter Parts)

GASKET: 890170 O-RING INCLUDED
SEAL: 898510-W
DISC SET: 151380-PKG

16
3-16

UNKNOWN
LENGTH: 6.50"

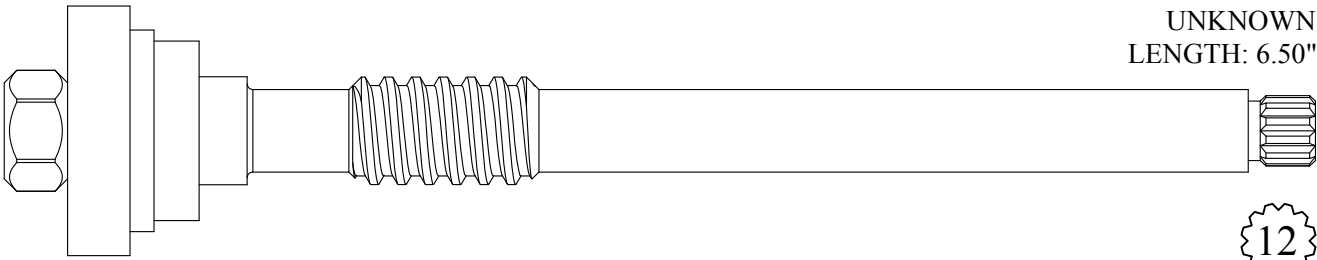

227461

12
1-2

Chrome Plated Stem

FOR BRIGGS
LENGTH: 6.50"

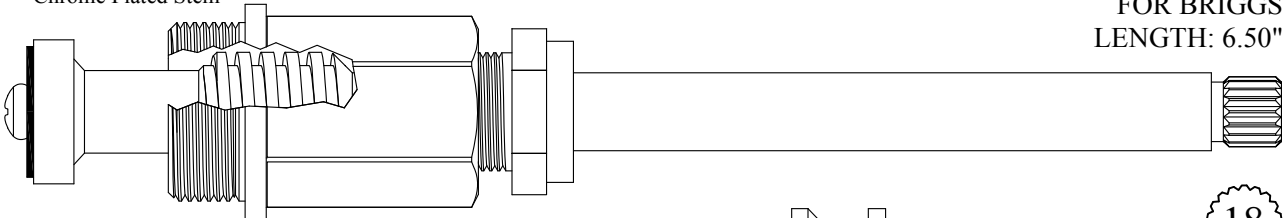

427141
227141 Stem Only
GASKET: 895370

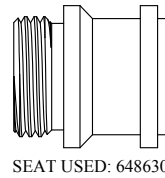

SEAT USED: 648630

18
3-3

Chrome Plated Stem

FOR LOGAN
LENGTH: 6.50"

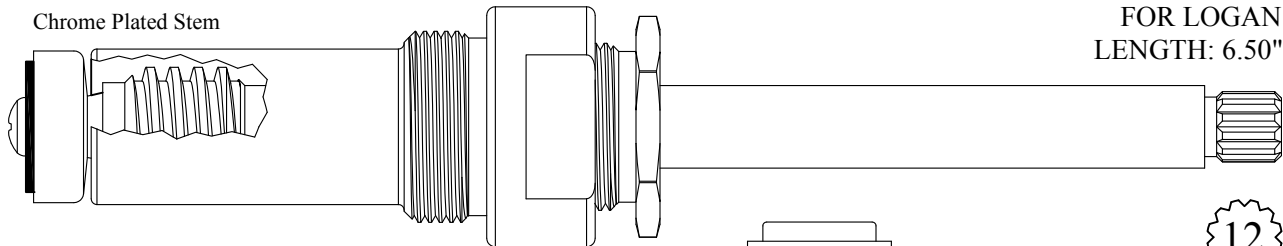

427201
227201 Stem Only
GASKET: 895570

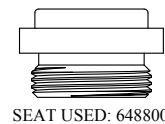

SEAT USED: 648800

12
1-2

Chrome Plated Stem

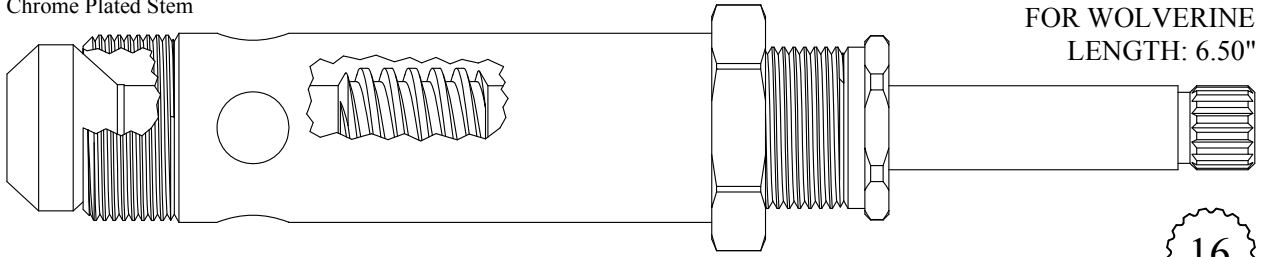

FOR WOLVERINE
LENGTH: 6.50"

439171
239171 Stem Only
GASKET: 895550

16
3-26

Chrome Plated Stem

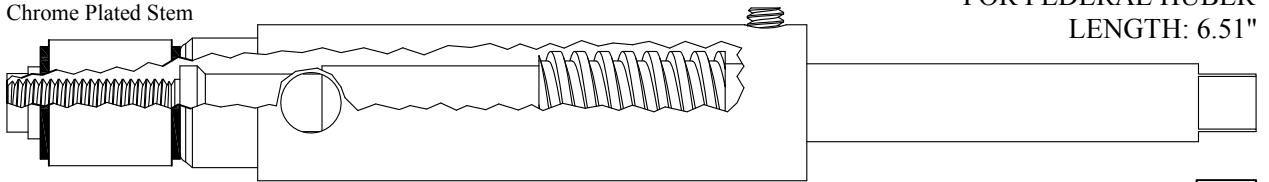

FOR FEDERAL HUBER
LENGTH: 6.51"

439001

5/16

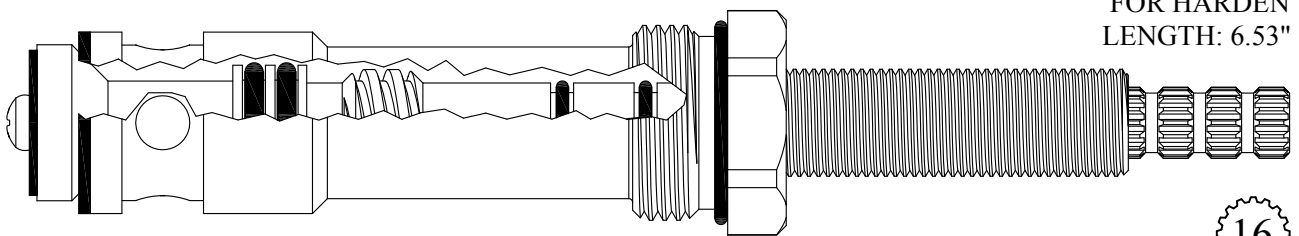

FOR HARDEN
LENGTH: 6.53"

439141
GASKET: 891180 O-RING INCLUDED

16
3-16

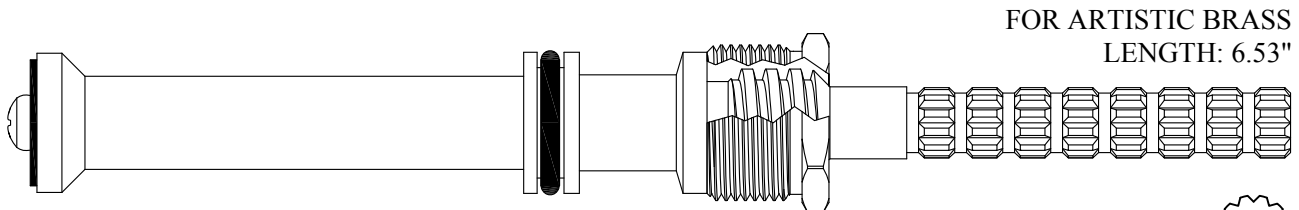

FOR ARTISTIC BRASS
LENGTH: 6.53"

426941/ 426942

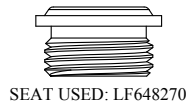

12
1-2

Chrome Plated Stem

FOR HAJOCA
LENGTH: 6.55"

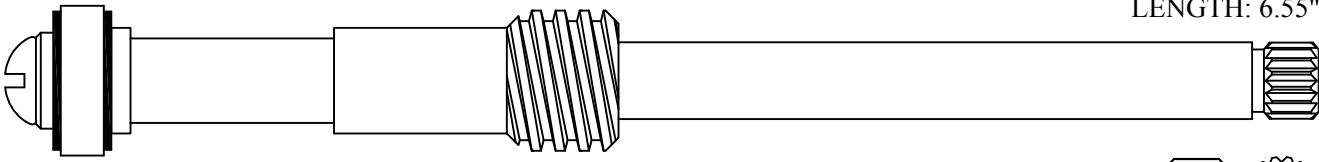

239601

Supplied with
12pt. Broach



16

1-6

Also available less barrel

426821

Chrome Plated Stem

FOR KOHLER
STEM LENGTH: 6.24"

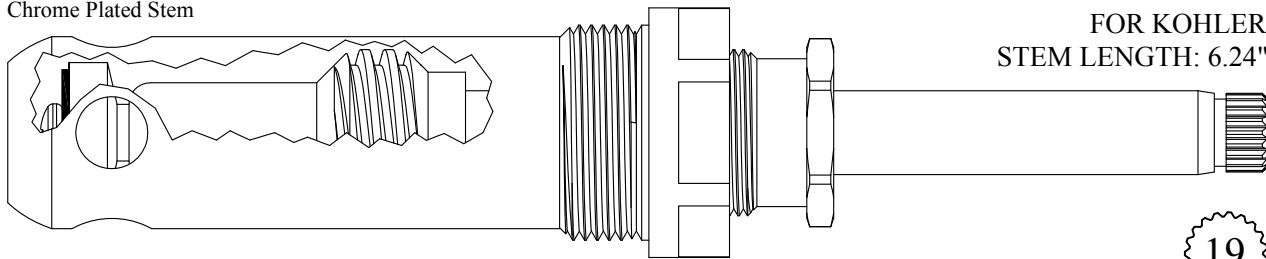

426801

226801 Stem Only

GASKET: 895450

USES BARREL:
647331

19

1-7

FOR SPEAKMAN
LENGTH: 6.57"

Chrome Plated Stem

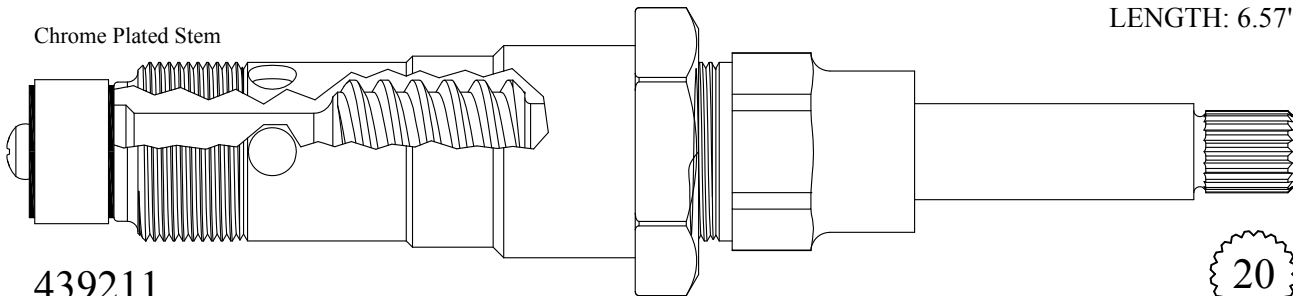

439211

239211 Stem Only

GASKET: 895450

20

2-4

Chrome Plated Stem

FOR ROYAL BRASS
LENGTH: 6.57"

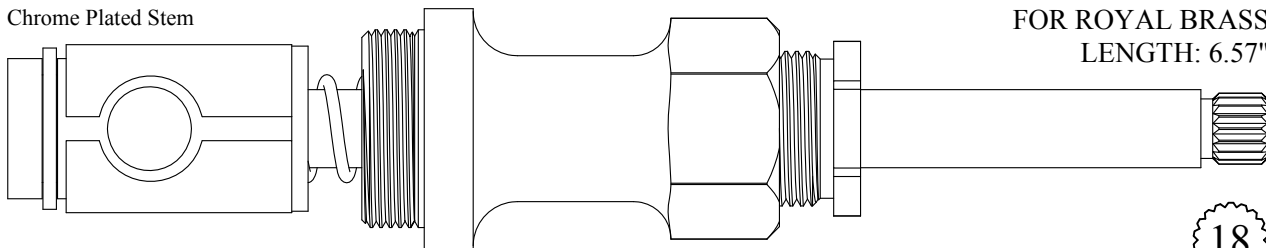

439630

239630 Stem Only

GASKET: 895560

18

3-3

FOR PHYLRICH
LENGTH: 6.58"

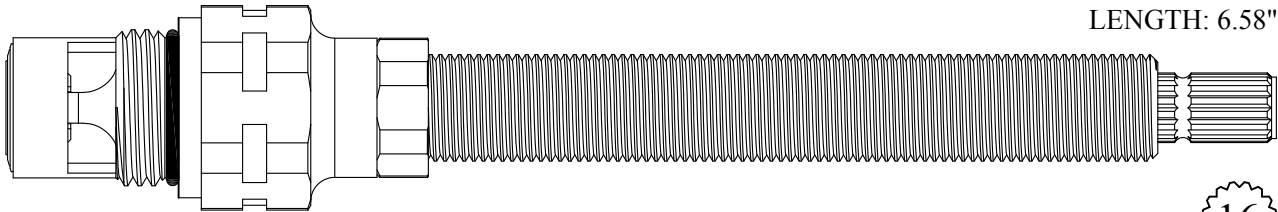

427281/ 427282

GASKET: 890170 O-RING INCLUDED
SEAL: 898510-W
DISC SET: 151380-PKG

Individual items available
Stem Ext. 5.00": #136050
Ext. Adap. Screw: #103310

16
1-6

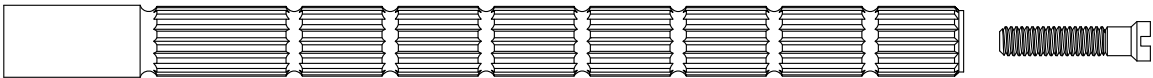

Plastic Body

FOR PRECISION
LENGTH: 6.59"

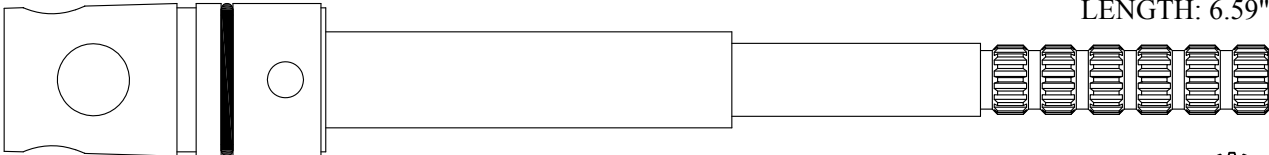

239160

16
3-16

FOR HARDEN
LENGTH: 6.60"

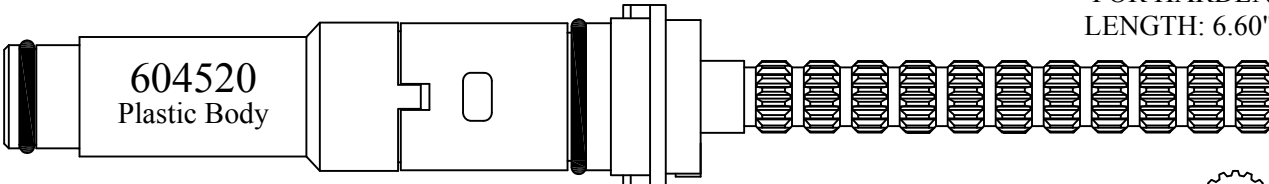

403941/ 403942

604520
Plastic Body

Available: Stem Only
203941
203942

16
3-16

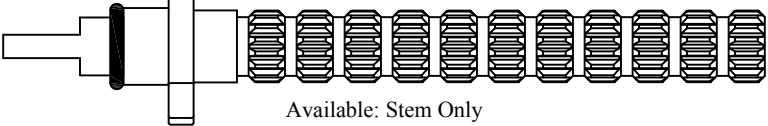

Chrome Plated Unit

FOR CRANE
LENGTH: 6.60"

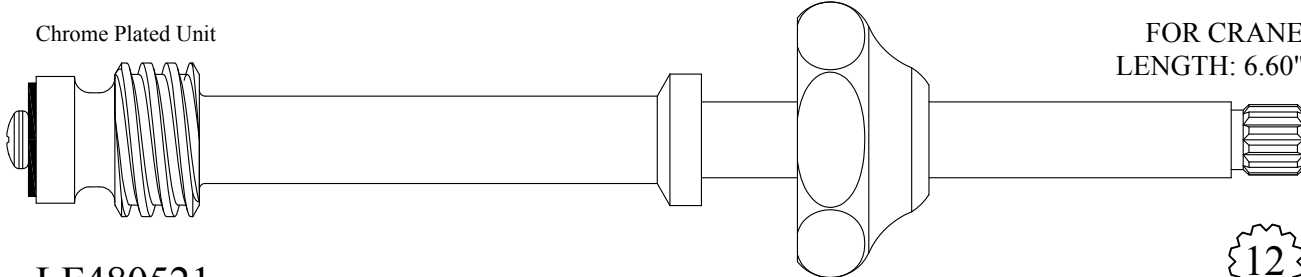

LF480521
LF280521 Stem Only

12
1-2

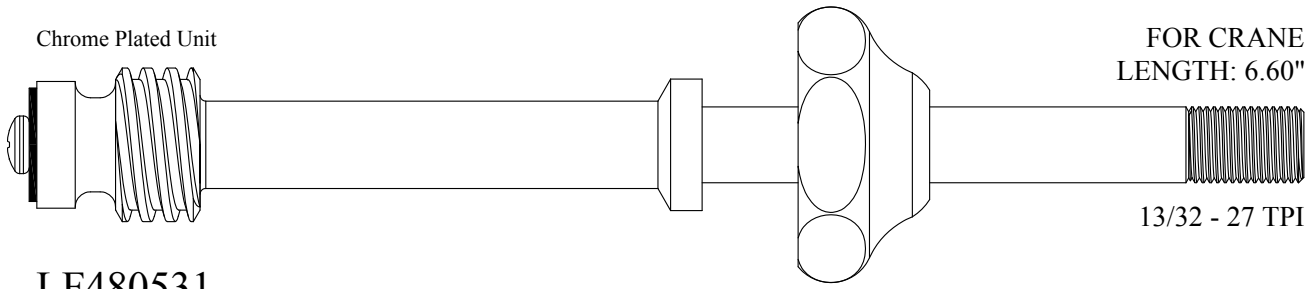

Chrome Plated Unit

FOR CRANE
LENGTH: 6.60"

13/32 - 27 TPI

LF480531
LF280531 Stem Only

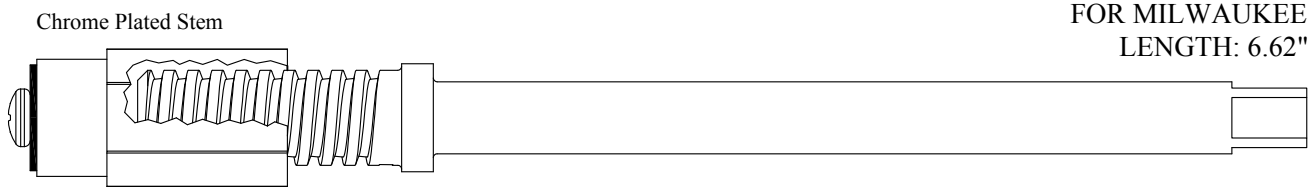

Chrome Plated Stem

FOR MILWAUKEE
LENGTH: 6.62"

5/16

426312
226312 Stem Only

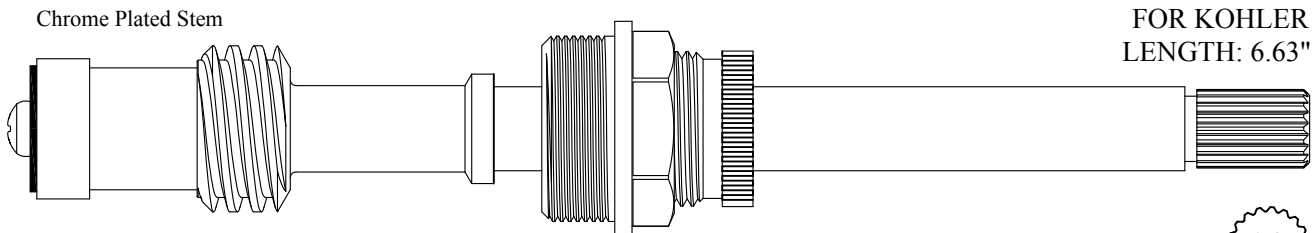

Chrome Plated Stem

FOR KOHLER
LENGTH: 6.63"



SEAT USED: LF647230

19
1-7

426921
226921 Stem Only
GASKET: 895350

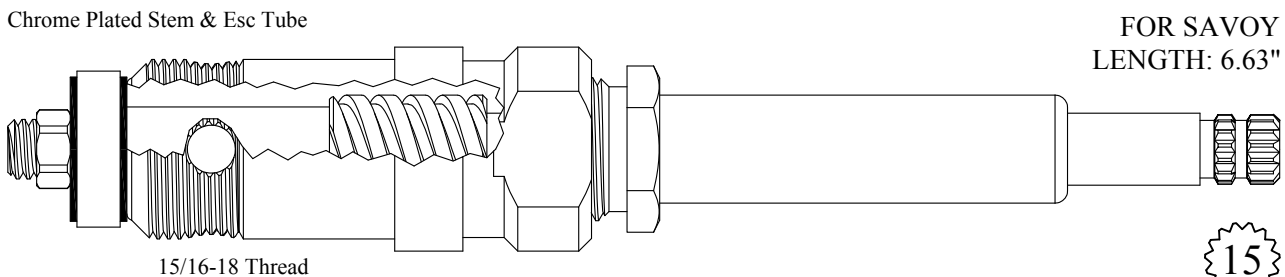

Chrome Plated Stem & Esc Tube

FOR SAVOY
LENGTH: 6.63"

15/16-18 Thread

15
1-13

439121
239121 Stem Only
GASKET: 895320

Chrome Plated Stem & Esc Tube

FOR SAVOY
LENGTH: 6.63"

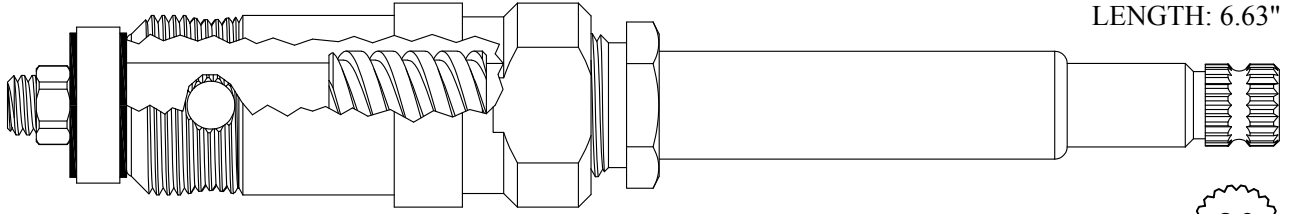

439131
239131 Stem Only
GASKET: 895320

20
2-4

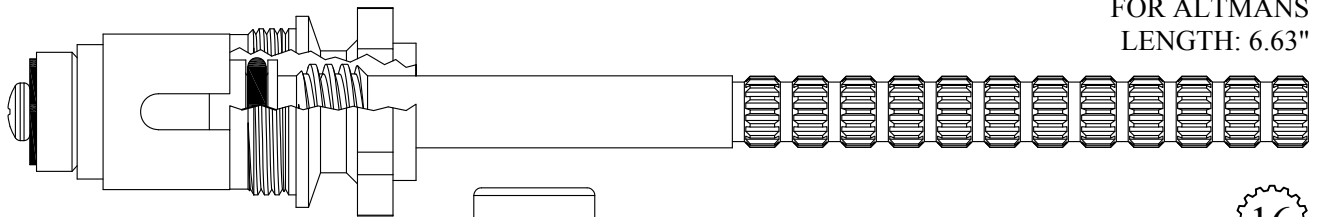

FOR ALTMANS
LENGTH: 6.63"

439181
GASKET: 895180



SEAT USED: LF649930

16
3-16

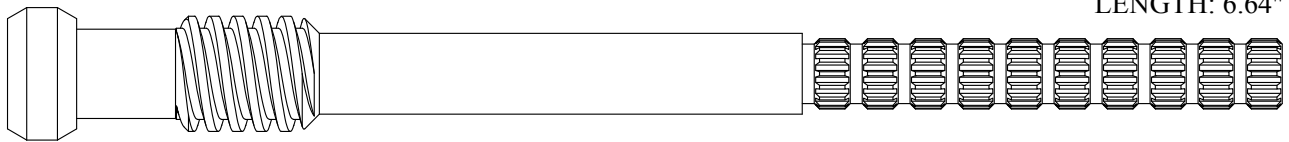

FOR AM STD
LENGTH: 6.64"

235741

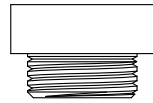

SEAT USED: 649090

16
3-16

Chrome Plated Gland

FOR KOHLER
LENGTH: 6.67"

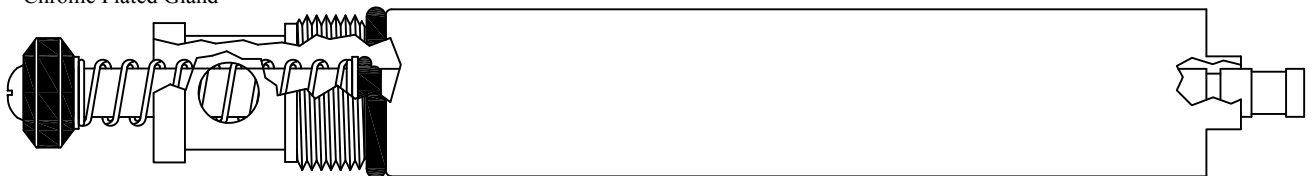

434600
GASKET: 891150 O-RING INCLUDED

Chrome Plated Stem

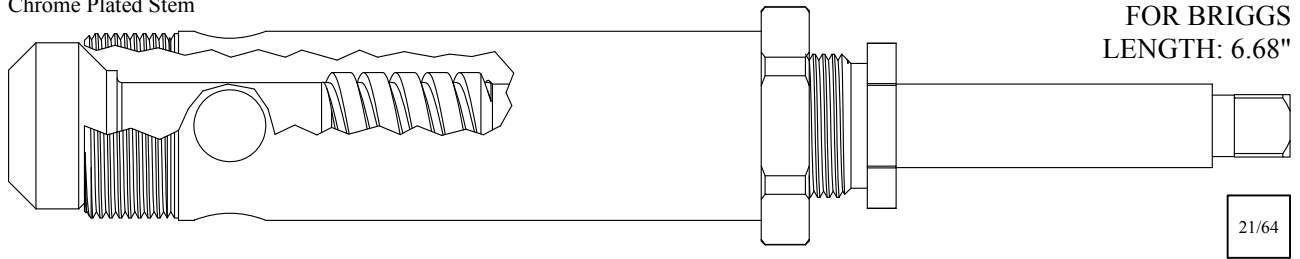

FOR BRIGGS
LENGTH: 6.68"

21/64

439201

239201 Stem Only

GASKET: 895340

Chrome Plated Stem

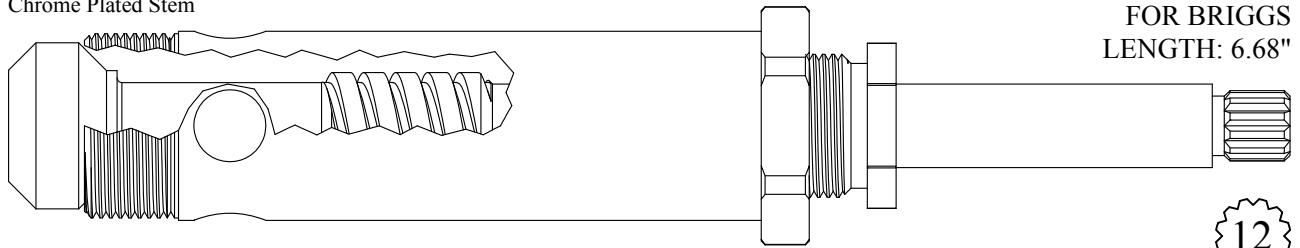

FOR BRIGGS
LENGTH: 6.68"

12
1-2

439251

239251 Stem Only

GASKET: 895340

Chrome Plated Stem

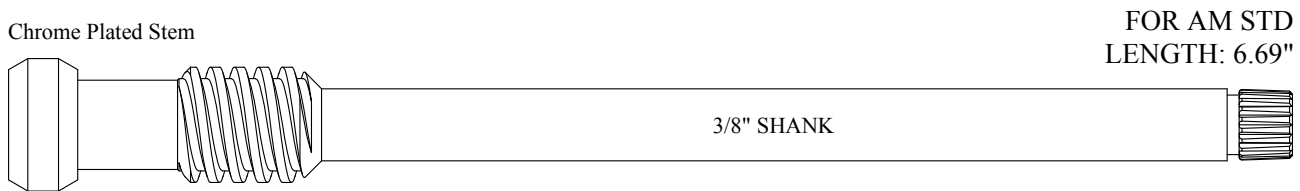

FOR AM STD
LENGTH: 6.69"

3/8" SHANK

20
3-14

239231

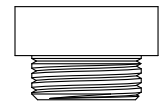

SEAT USED: 649090

Nickel Plated Gland

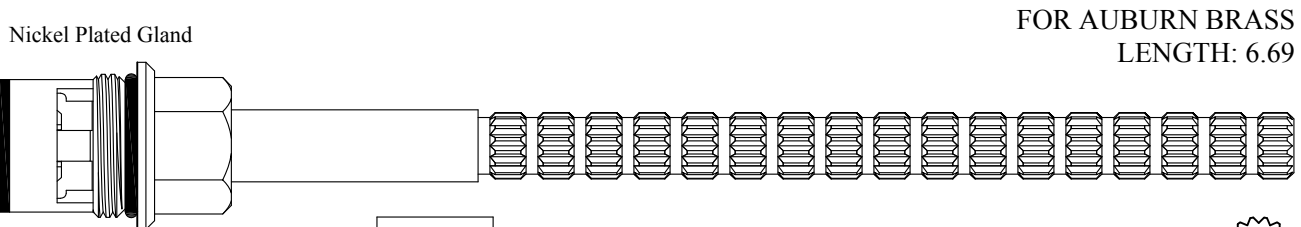

FOR AUBURN BRASS
LENGTH: 6.69

16
2-3

427601/ 427602

GASKET: 890160 O-RING INCLUDED
DISC SET: 151380-PKG

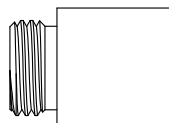

SEAT USED: 649350

FOR ARTISTIC BRASS
LENGTH: 6.72

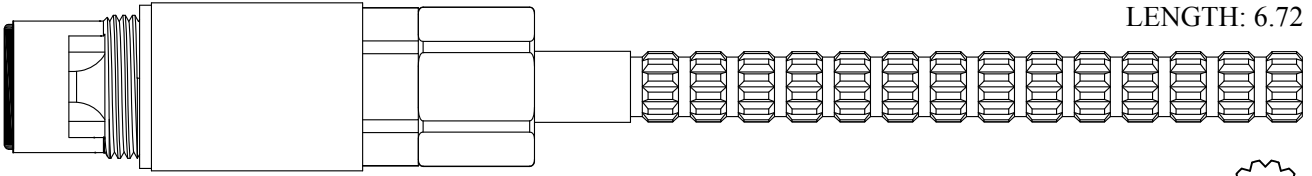

427301/ 427302

GASKET: 895100 INCLUDED
SEAL: 898540
DISC SET: 112530-PKG

Also available with
16pt Harden Broach
427331 / 427332

16
3-16

12
1-2

FOR CONCINNY
LENGTH: 6.72"

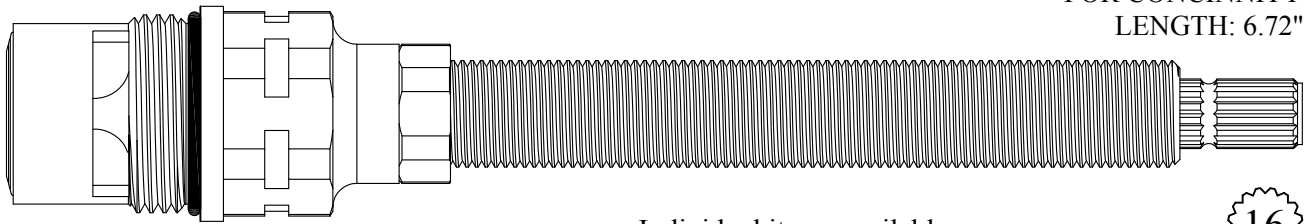

428031/ 428032

GASKET: 890210 O-RING INCLUDED
SEAL: 898520
DISC SET: 109850-PKG

Individual items available
Stem Ext. 5.00": #136050
Ext. Adap. Screw: #103310

16
1-6

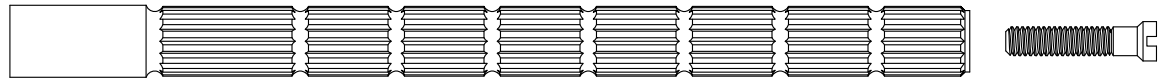

Chrome Plated Stem

FOR CRANE
LENGTH: 6.74"

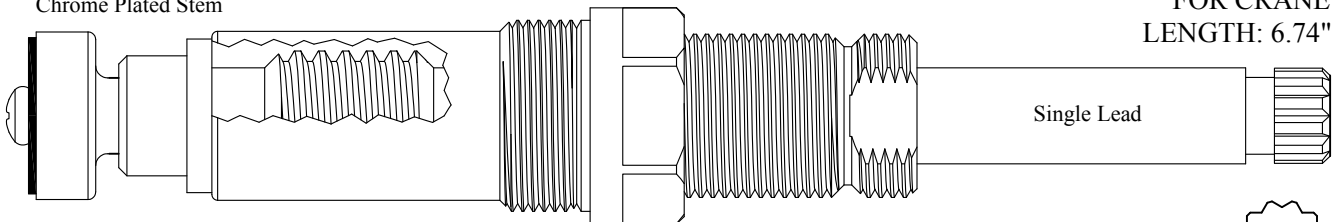

427001

227001 Stem Only

GASKET: 895340

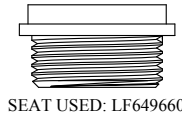

SEAT USED: LF649660

12

Chrome Plated Stem

FOR CRANE
LENGTH: 6.74"

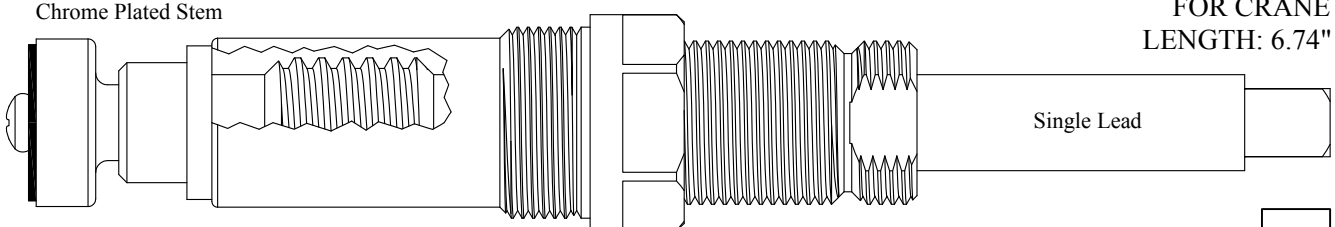

427031

227031 Stem Only

GASKET: 895340



SEAT USED: LF649660

23/64

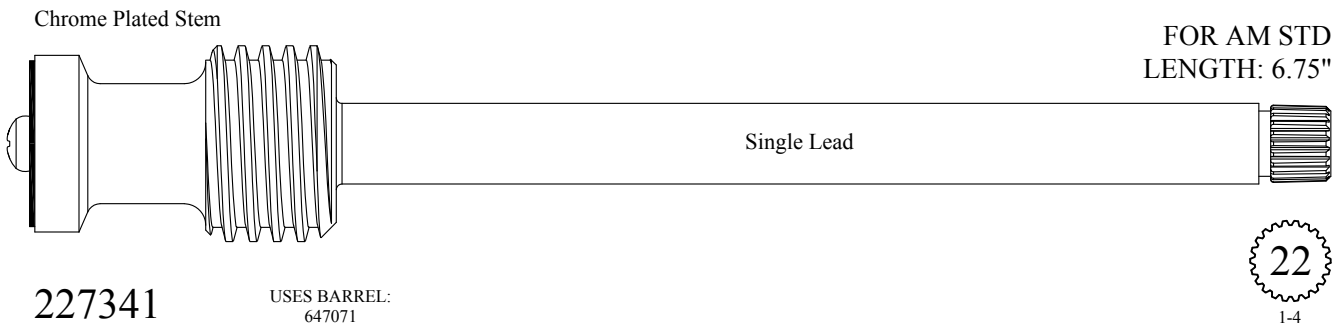
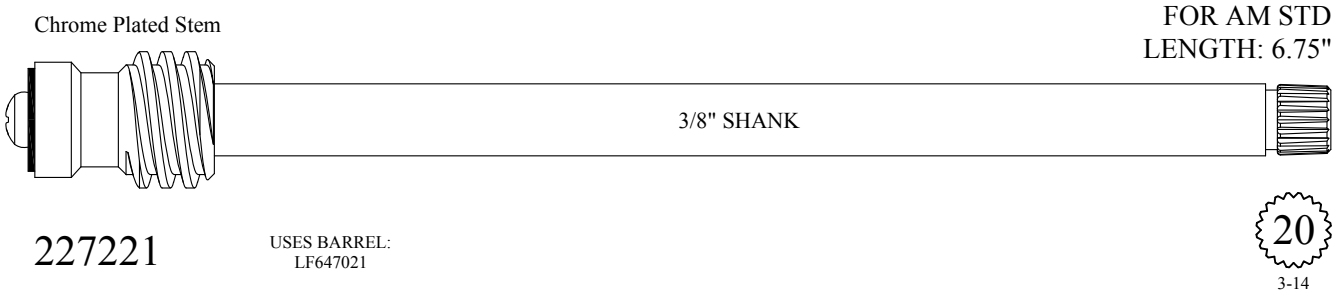
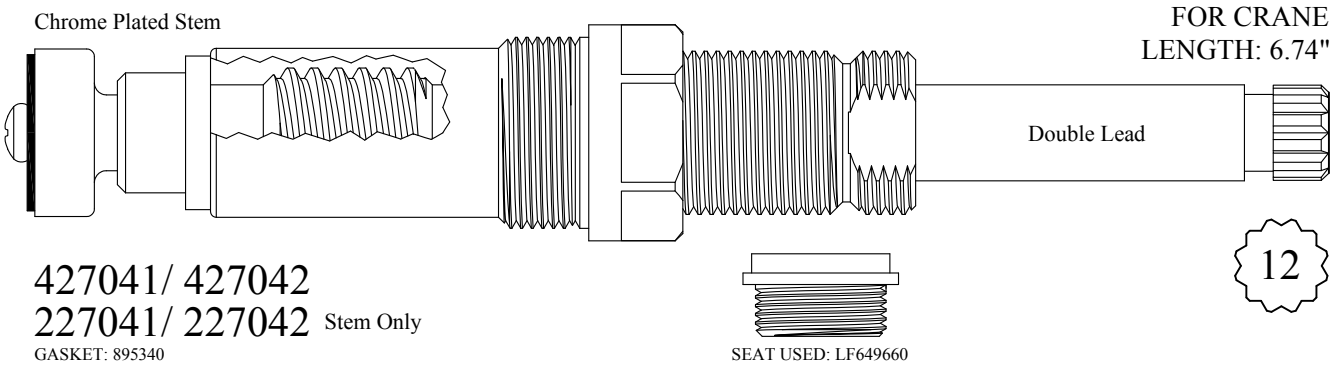
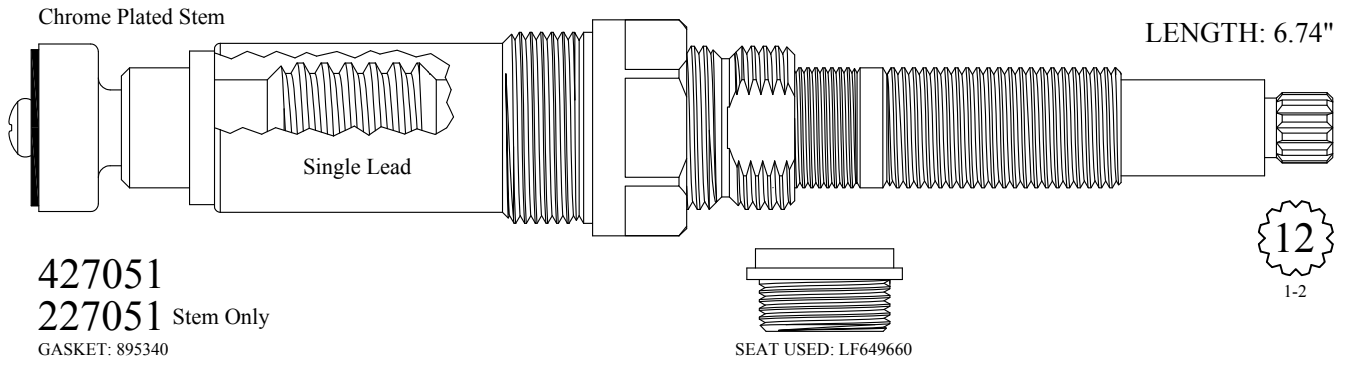

Chrome Plated Stem

FOR AM STD
STEM LENGTH: 6.75"

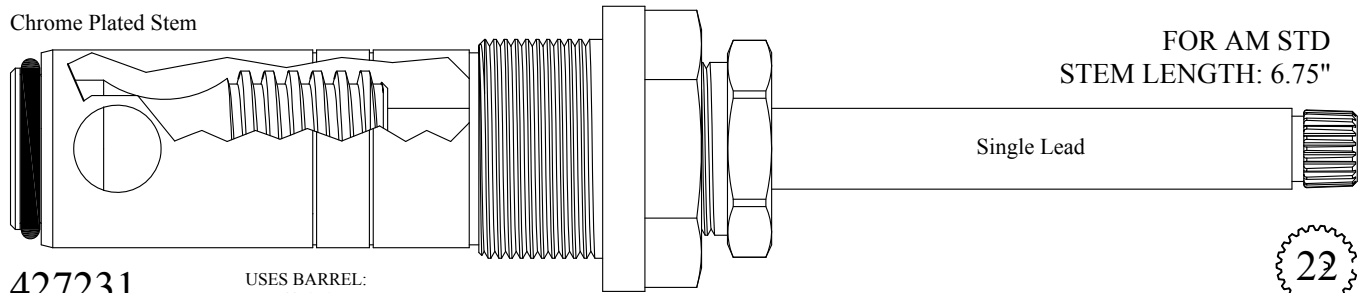

427231
227231 Stem Only
GASKET: 824600

USES BARREL:
647051

Single Lead

22
1-4

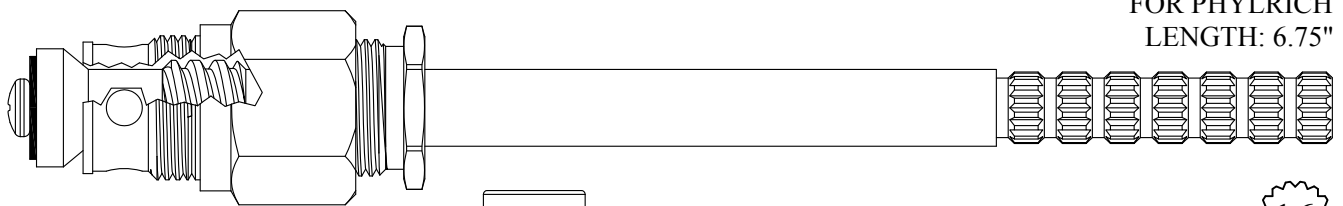

FOR PHYLRICH
LENGTH: 6.75"

439621
GASKET: 895100



SEAT USED: LF648550

16
1-6

Chrome Plated Stem

FOR AM STD
LENGTH: 6.75"

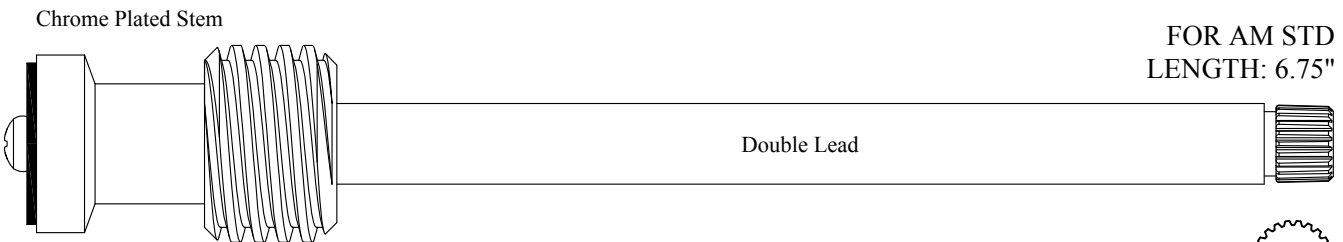

227351/ 227352

USES BARREL:
647081/647082

Double Lead

22
1-4

Chrome Plated Stem

FOR AM STD
LENGTH: 6.75"

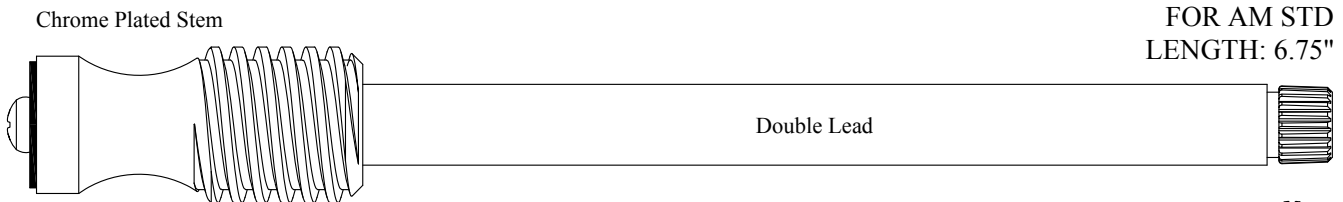

227361/ 227362

USES BARREL:
647061/647062

Double Lead

22
1-4



FOR PHYLRICH
LENGTH: 6.75"

427241/ 427242

GASKET: 895100

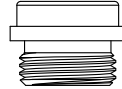

SEAT USED: LF648550

16
1-6

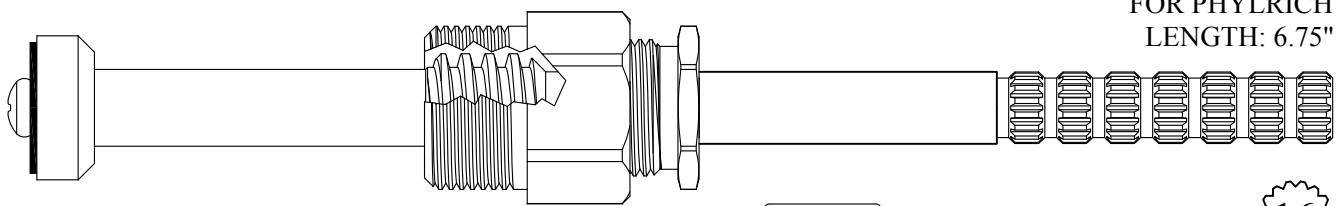

FOR PHYLRICH
LENGTH: 6.75"

427321/ 427322

GASKET: 895400



SEAT USED: 648970

16
1-6

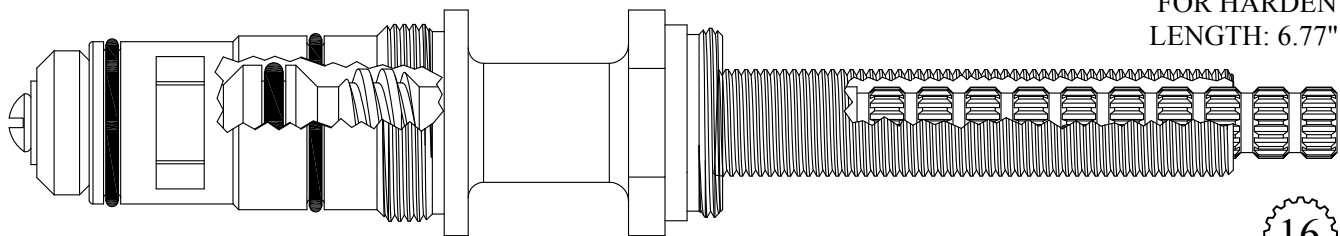

FOR HARDEN
LENGTH: 6.77"

439241

16
3-16

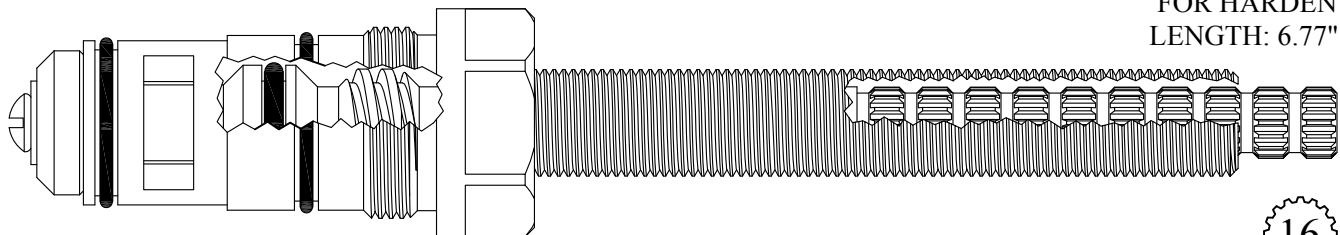

FOR HARDEN
LENGTH: 6.77"

439221

16
3-16

Chrome Plated Stem

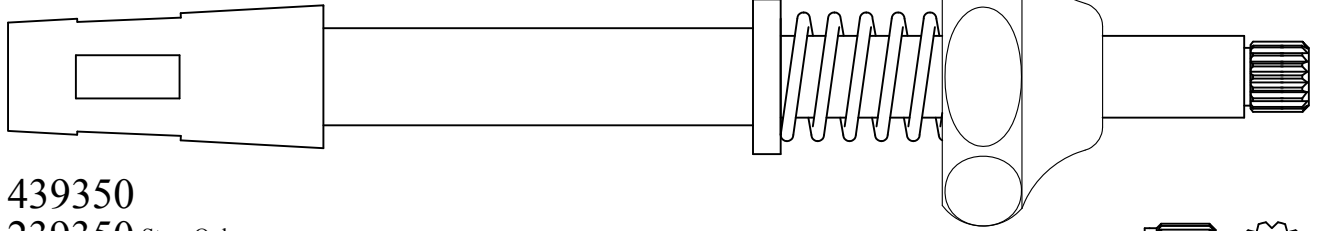

FOR PRICE PFISTER
LENGTH: 6.78"

439350
239350 Stem Only

Supplied with
12pt. Broach



12
1-2

Chrome Plated Stem

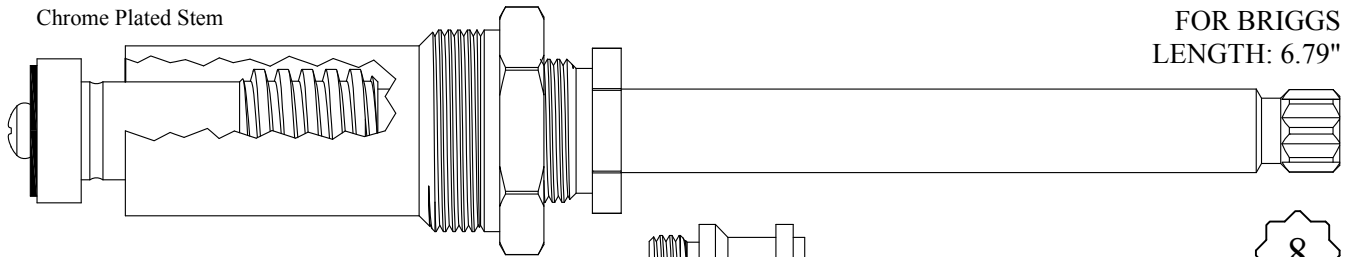

FOR BRIGGS
LENGTH: 6.79"

427441
227441 Stem Only
GASKET: 895340

SEAT USED: 648630

8

Chrome Plated Stem

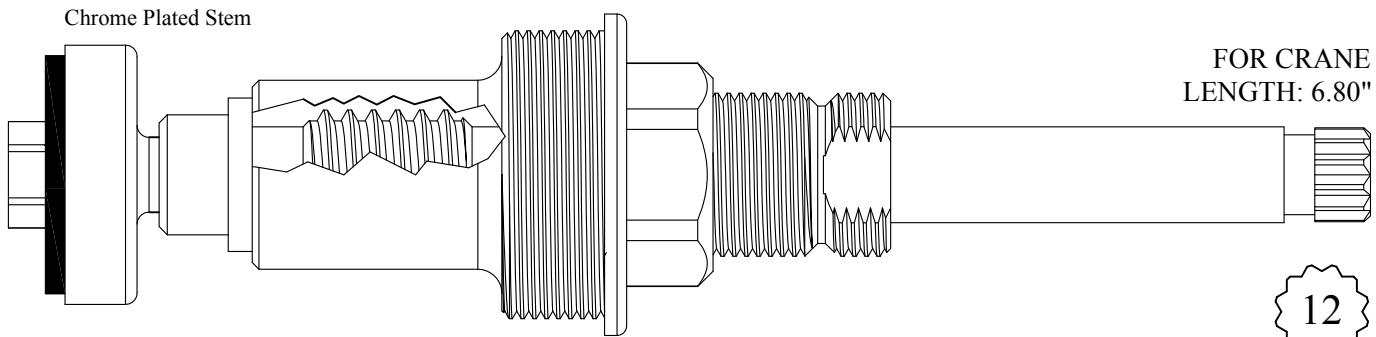

FOR CRANE
LENGTH: 6.80"

427181
227181 Stem Only

12

Chrome Plated Stem

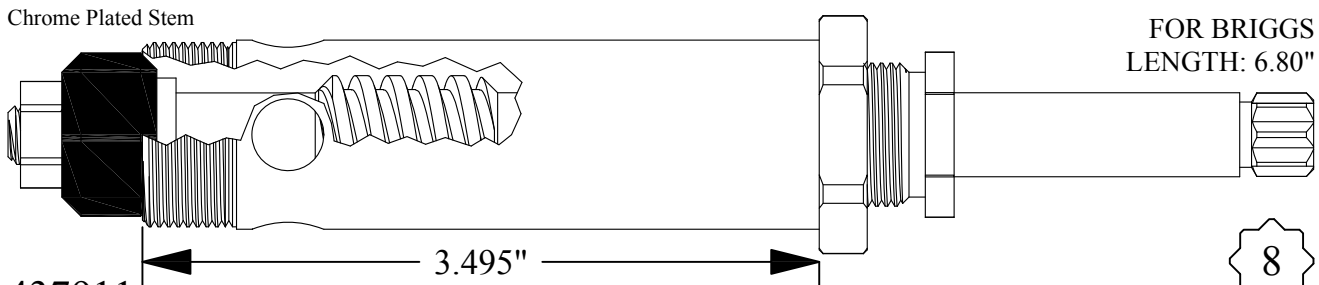

FOR BRIGGS
LENGTH: 6.80"

437911
237911 Stem Only
GASKET: 895340

8

Chrome Plated Stem

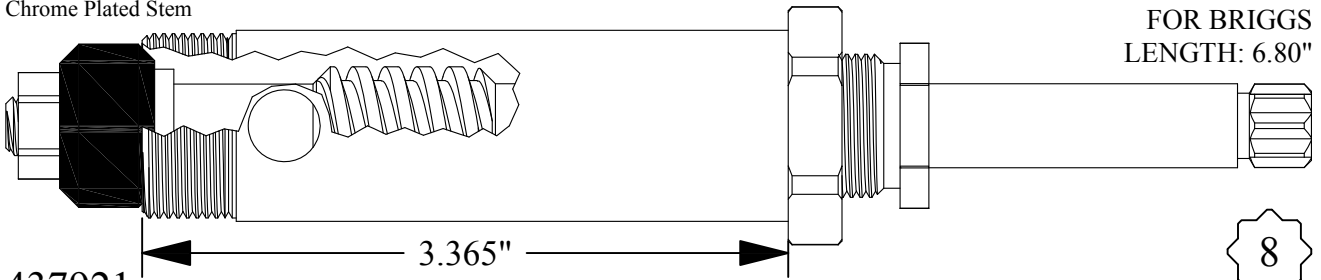

437921
 237911 Stem Only
 GASKET: 895340

8

Chrome Plated Stem

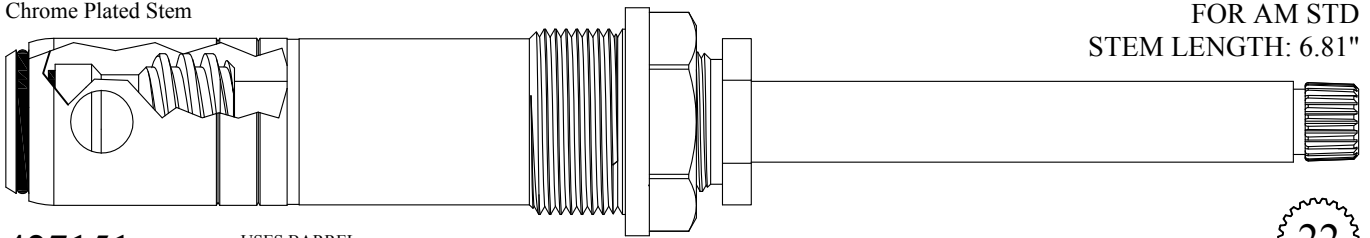

427151
 227021 Stem Only
 GASKET: 818010
 USES BARREL:
 LF647021

22
 1-4

Chrome Plated Stem

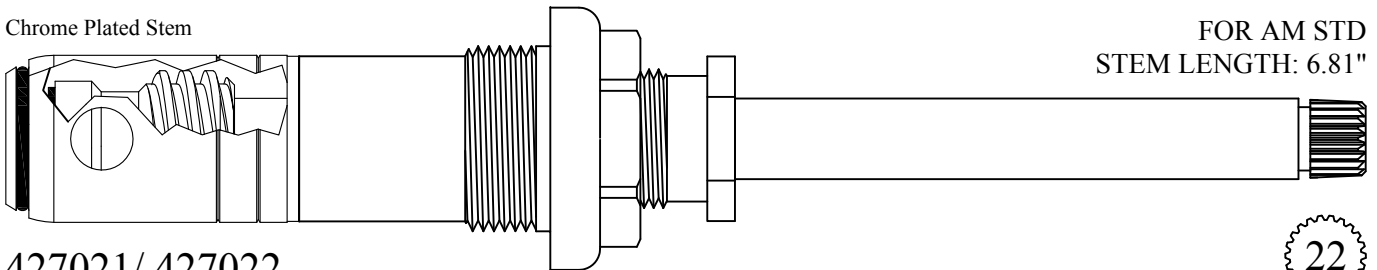

427021/ 427022
 227021/ 227022 Stem Only
 GASKET: 818000
 USES BARREL:
 LF647021/LF647022

22
 1-4

Chrome Plated Stem

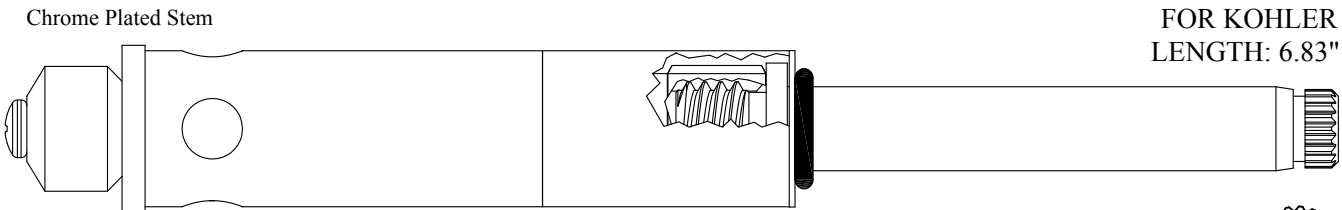

439312

19
 1-7

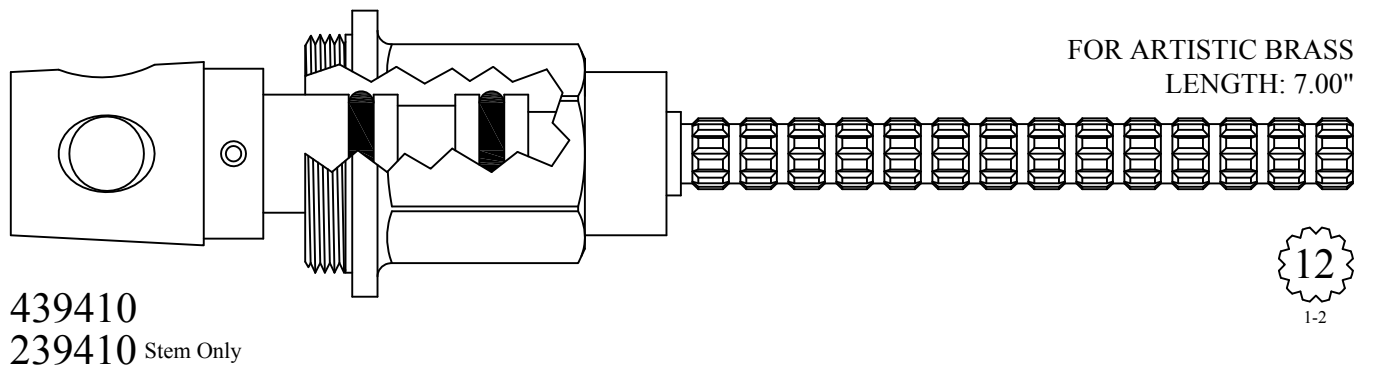
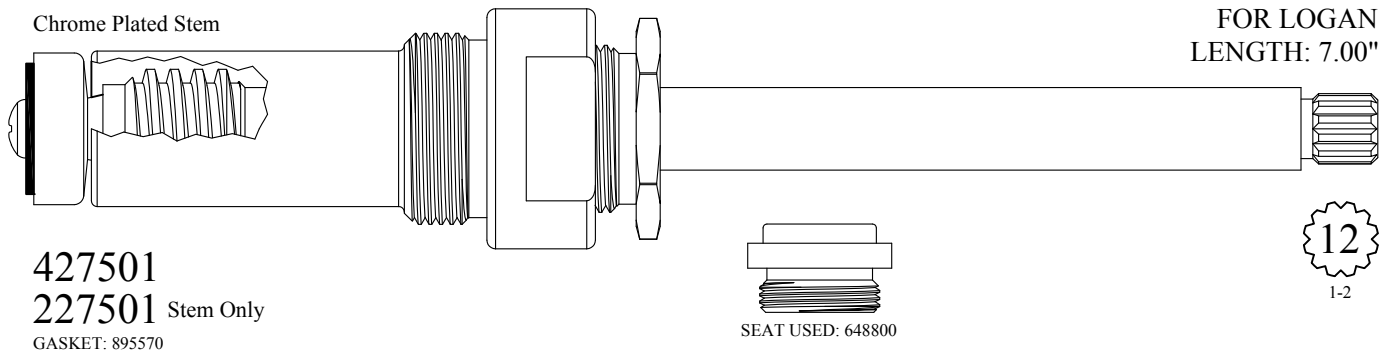
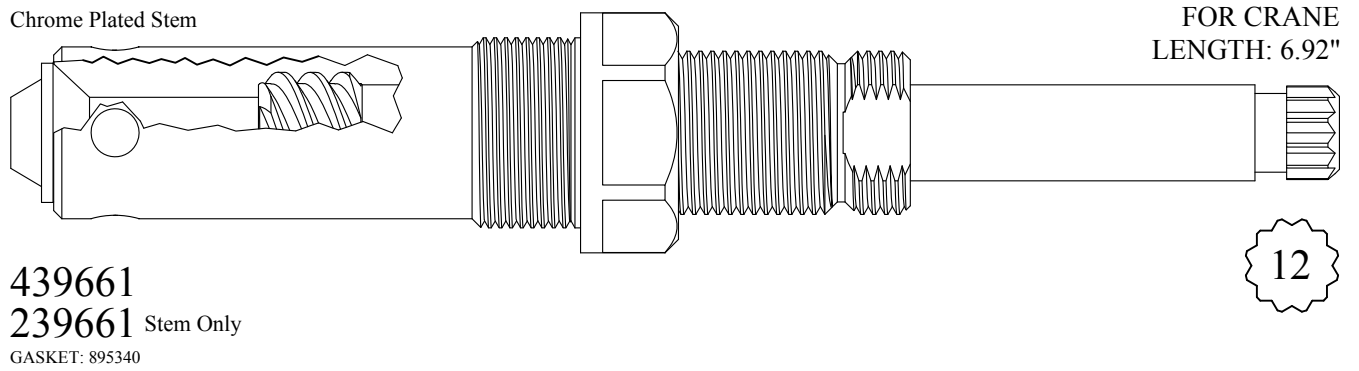
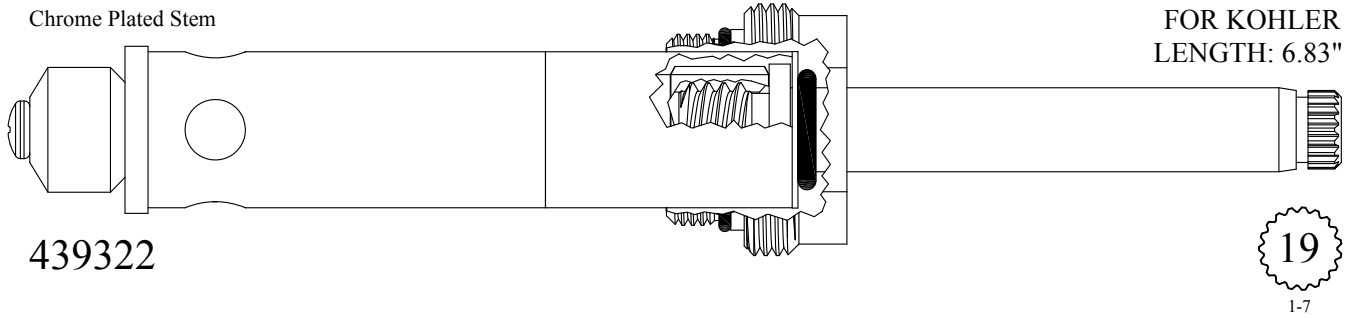

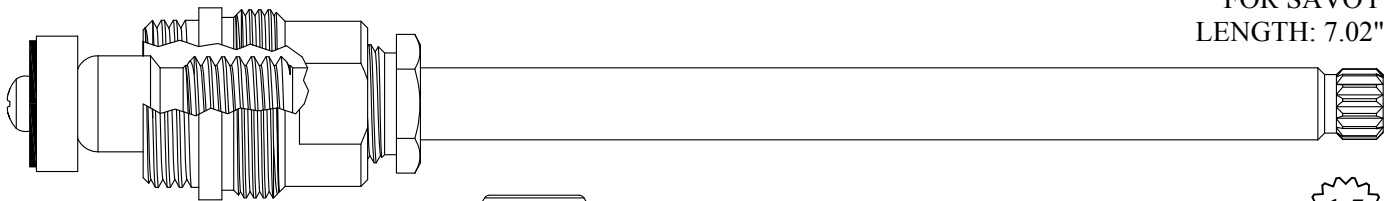

FOR SAVOY
LENGTH: 7.02"

427081
GASKET: 895400

SEAT USED: LF648130

15
1-13

Chrome Plated Stem

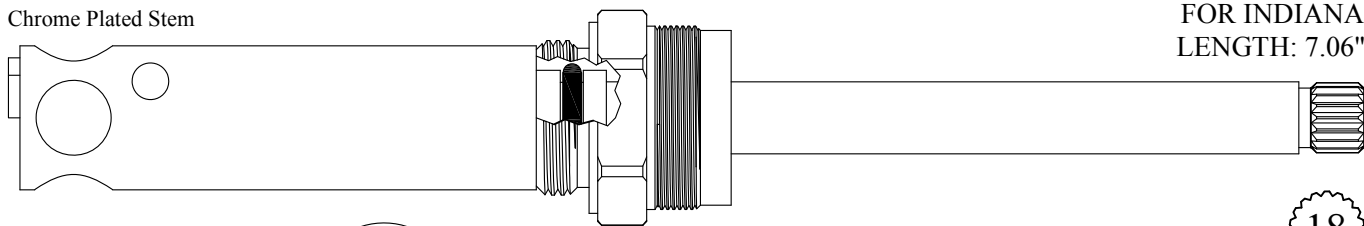

FOR INDIANA
LENGTH: 7.06"

439520
239520 Stem Only
GASKET: 895150

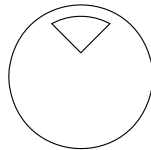

18
3-3

Chrome Plated Stem

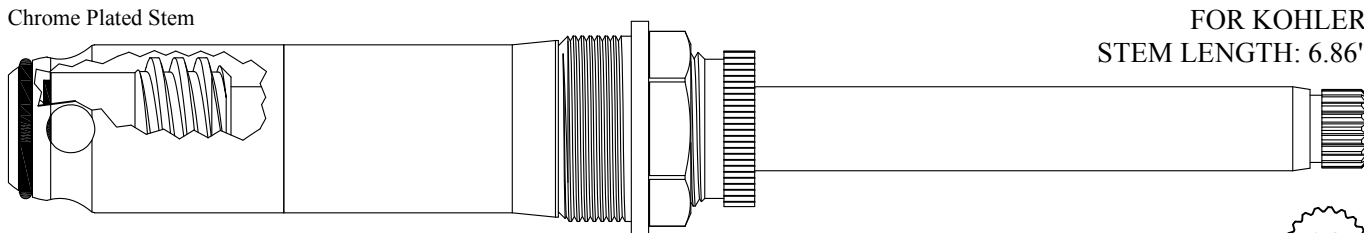

FOR KOHLER
STEM LENGTH: 6.86"

426711
226711 Stem Only
GASKET: 895350

USES BARREL:
647321

19
1-7



FOR BRIGGS
LENGTH: 7.11"

224212

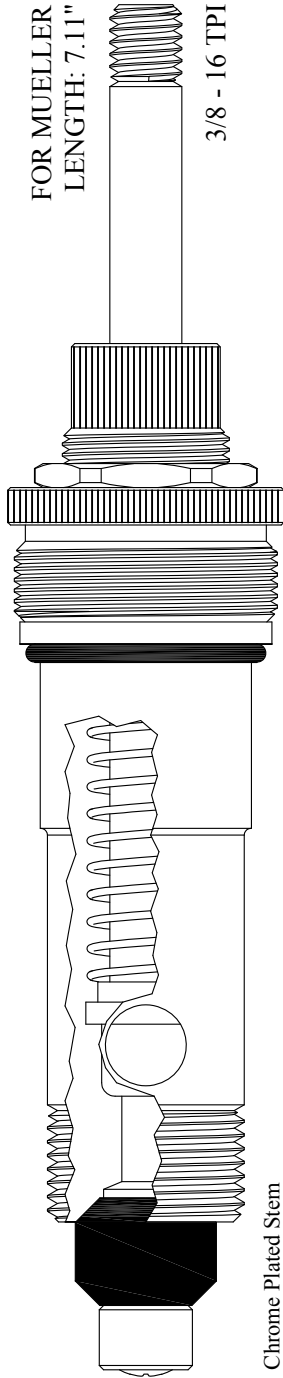

439640
239640 Stem Only

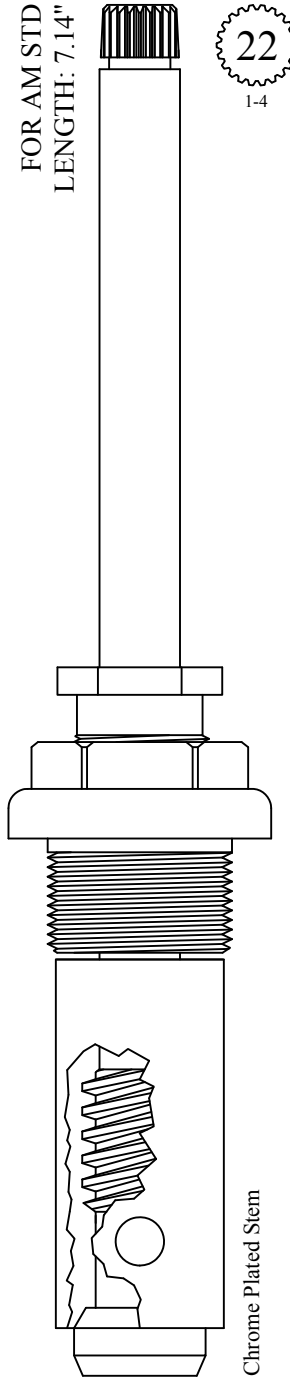

GASKET: 818000

435041
235041 Stem Only

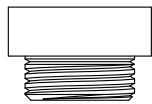

SEAT USED: 649090

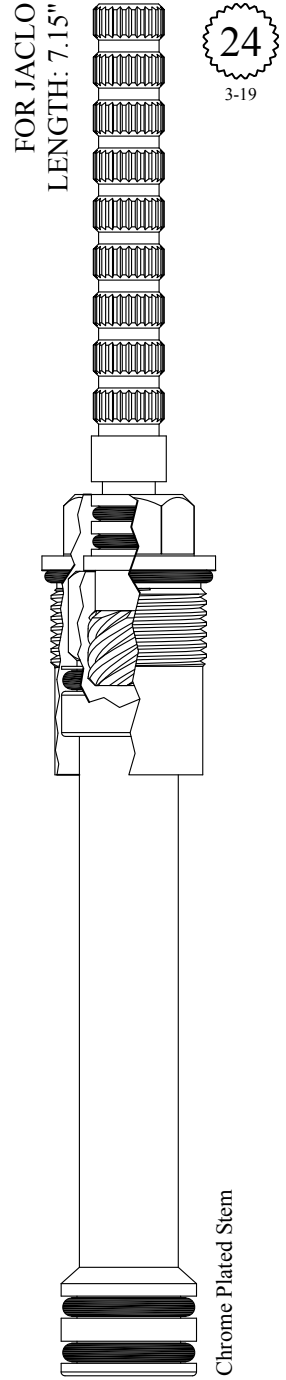

GASKET: 890180 O-RING INCLUDED

439421

FOR AM STD
LENGTH: 7.25"

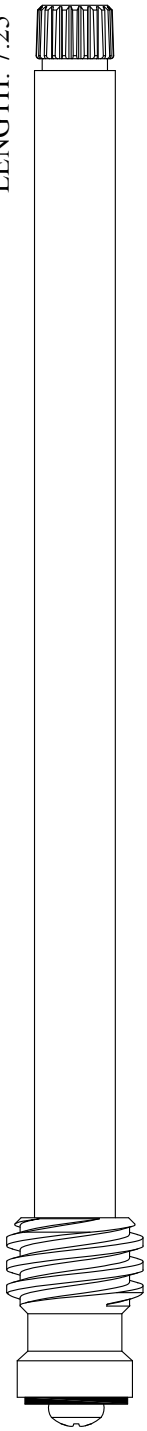

22
1-4

Chrome Plated Stem

227611
USES BARREL:
LF647021

FOR HARDEN
LENGTH: 7.32"

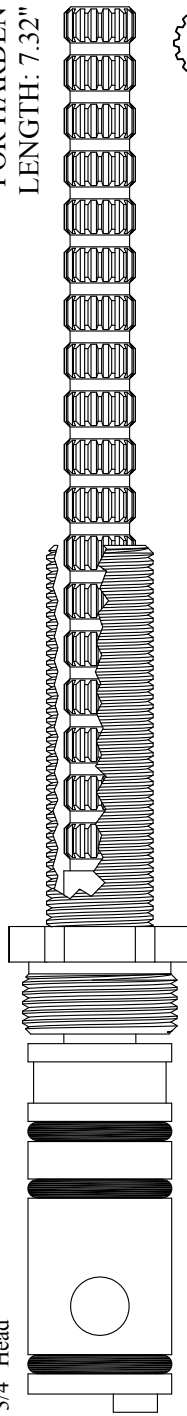

16
3-16

3/4" Head

439730
239730 Stem Only

FOR ARTISTIC BRASS
LENGTH: 7.35"

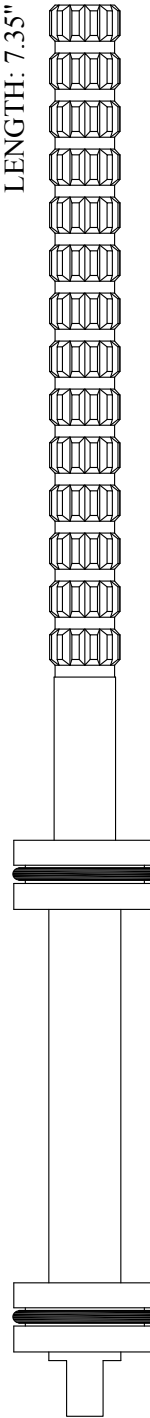

12
1-2

239690

FOR SPEAKMAN
LENGTH: 7.35"

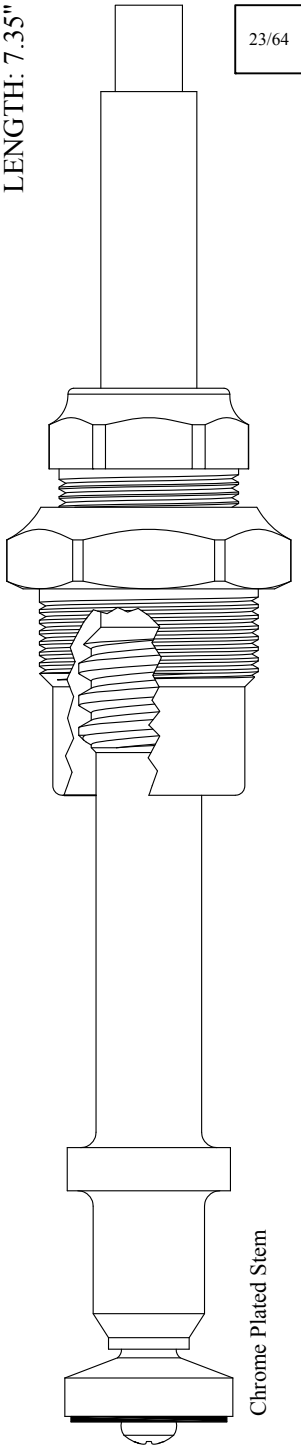

Chrome Plated Stem

GASKET: 895450

428321

228321 Stem Only

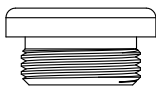

SEAT USED: 648180

FOR PHYLRICH
LENGTH: 7.60"

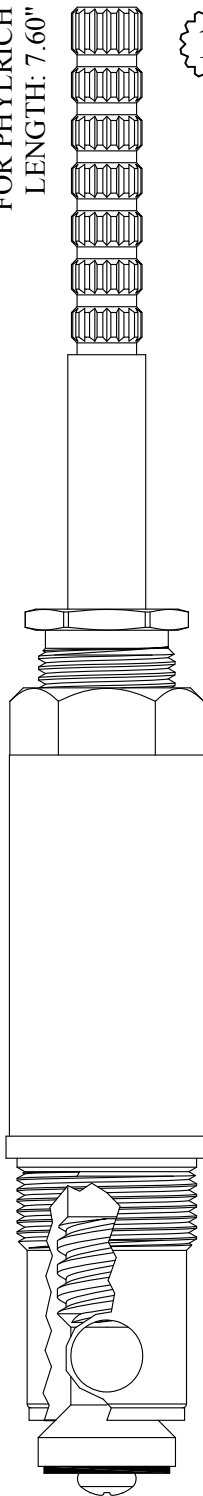

16
1-6

GASKET: 895370

439681



SEAT USED: 648970

FOR STANDARD SANITARY
LENGTH: 7.74"

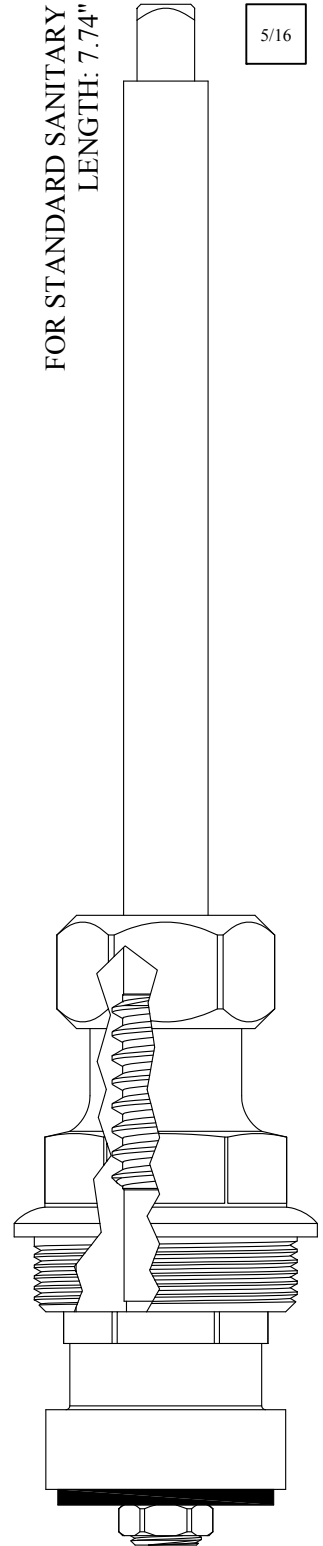

5/16

GASKET: 895500

427801

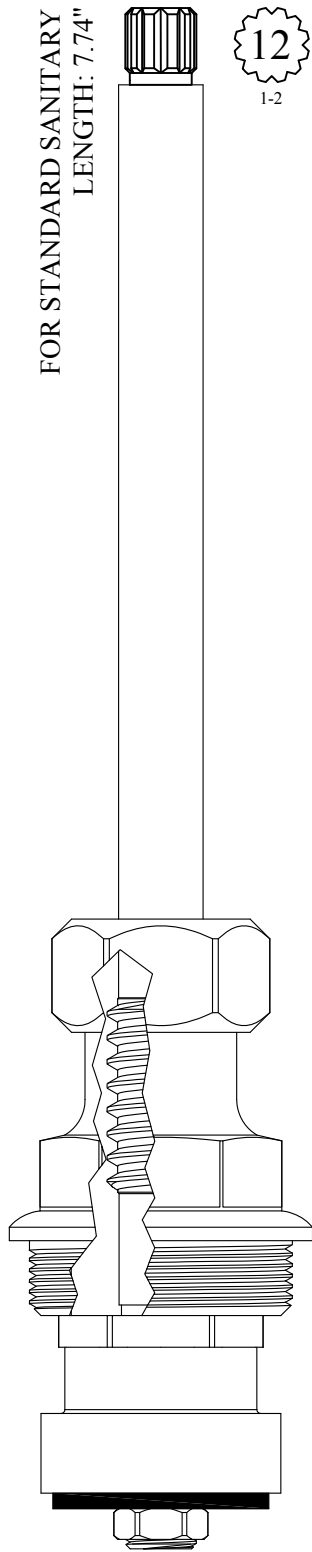

FOR STANDARD SANITARY
LENGTH: 7.74"

12
1-2

GASKET: 895500
427851

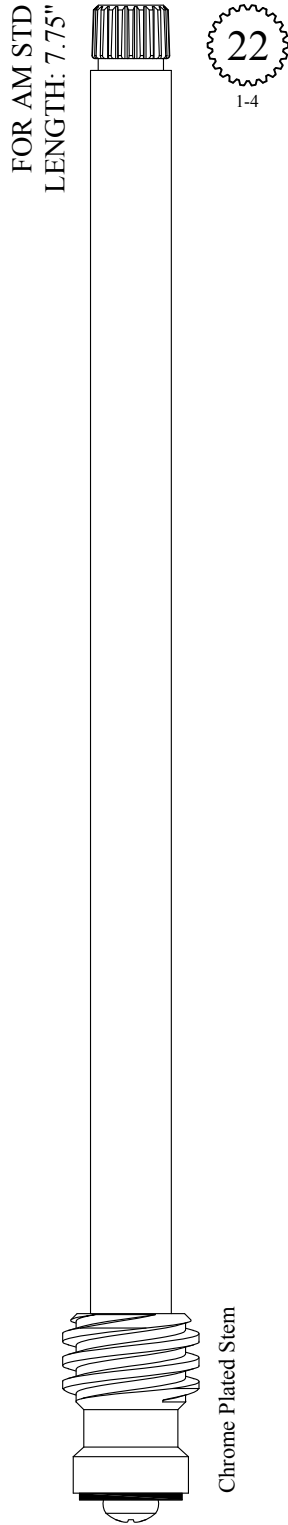

FOR AM STD
LENGTH: 7.75"

22
1-4

Chrome Plated Stem

227811
USES BARREL:
LF647021

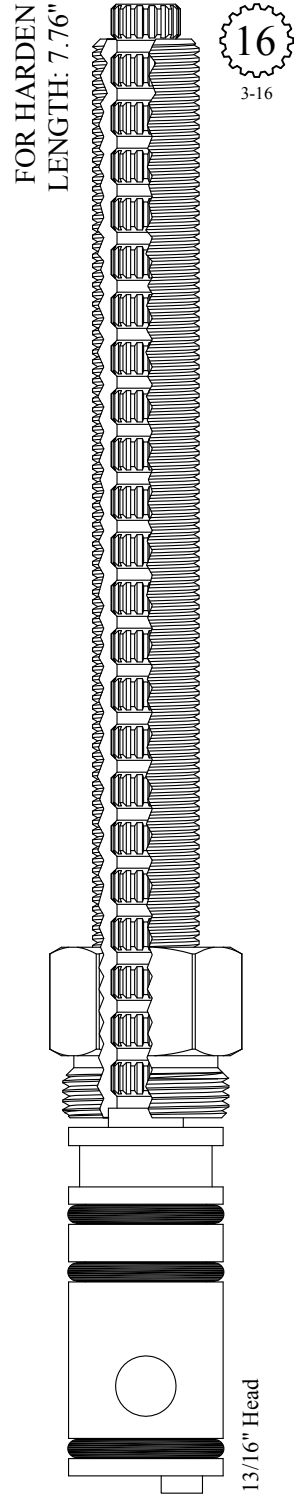

FOR HARDEN
LENGTH: 7.76"

16
3-16

13/16" Head

439760
239760 Stem Only

FOR HARDEN
LENGTH: 7.88"

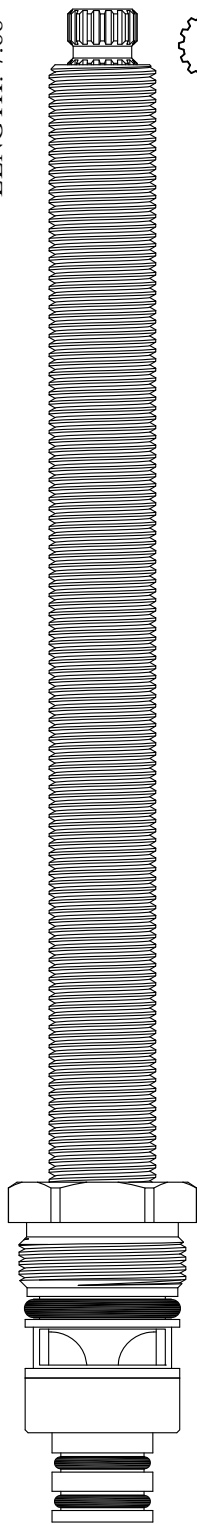

16
3-16

DISC SET: 151380-PKG

428201
428202

FOR CRANE
LENGTH: 7.91"

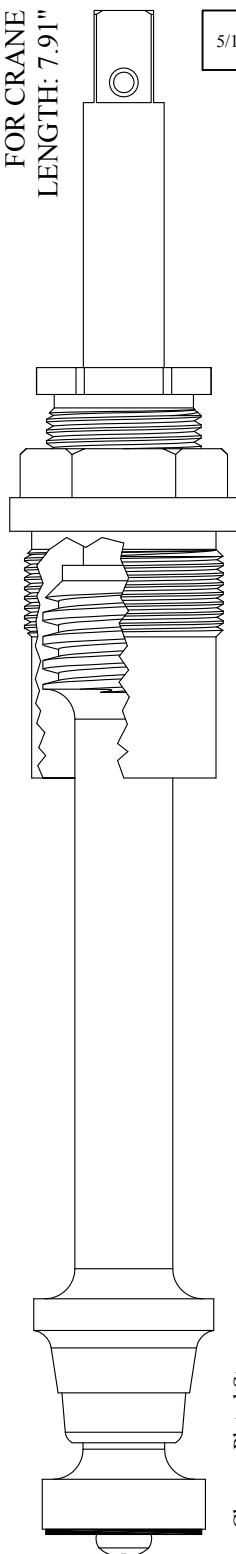

5/16

Chrome Plated Stem

GASKET: 895560

428001
228001 Stem Only

FOR CRANE
LENGTH: 7.91"

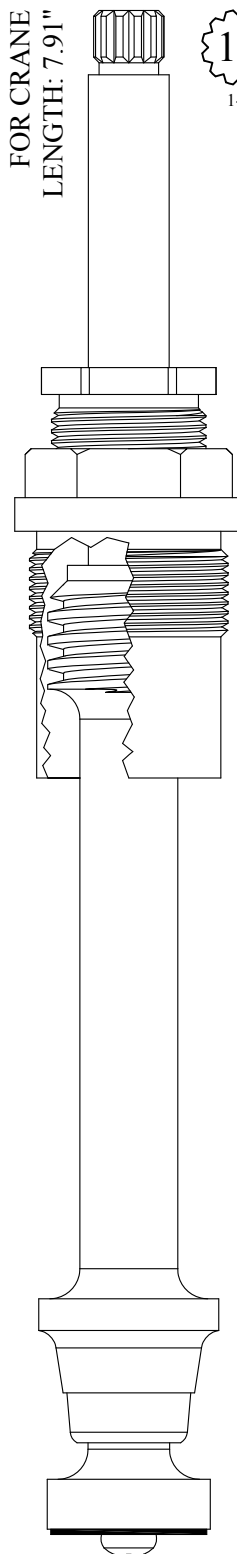

12
1-2

Chrome Plated Stem

GASKET: 895560

428051
228051 Stem Only

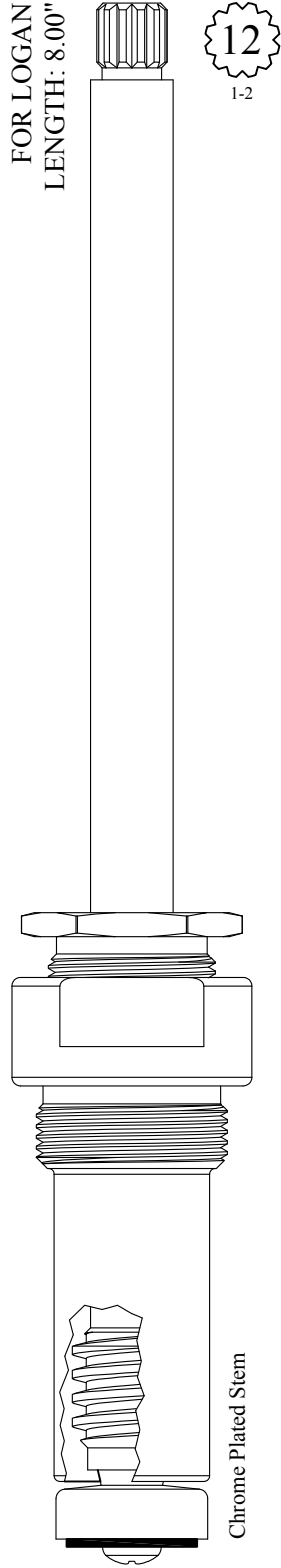

GASKET: 895570

428301
228301 Stem Only



SEAT USED: 648800

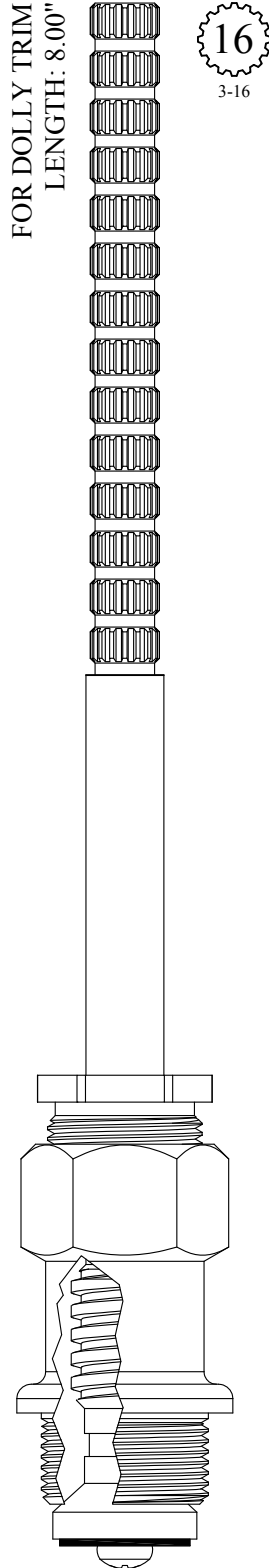

GASKET: 895400

428221
428222
228221 Stem Only
228222 Stem Only



SEAT USED: 648370

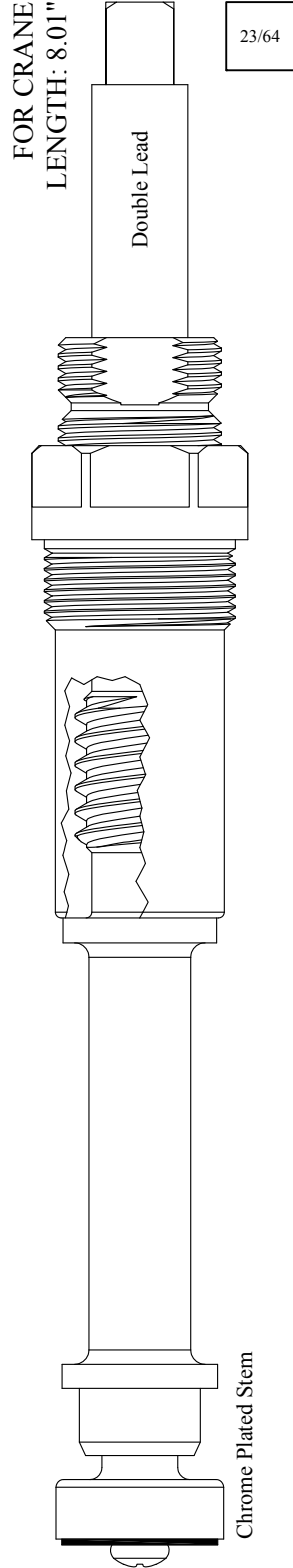

GASKET: 895550

LF480911
LF480912
LF280911 Stem Only
LF280912 Stem Only

FOR CRANE
LENGTH: 8.01"

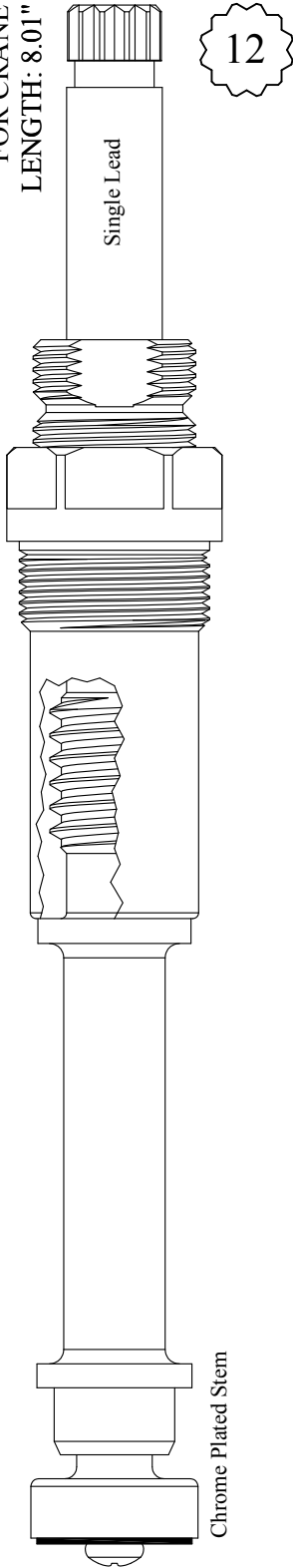

GASKET: 895340

LF480991
LF280991 Stem Only



SEAT USED: LF649660

FOR NEWPORT
LENGTH: 8.17"

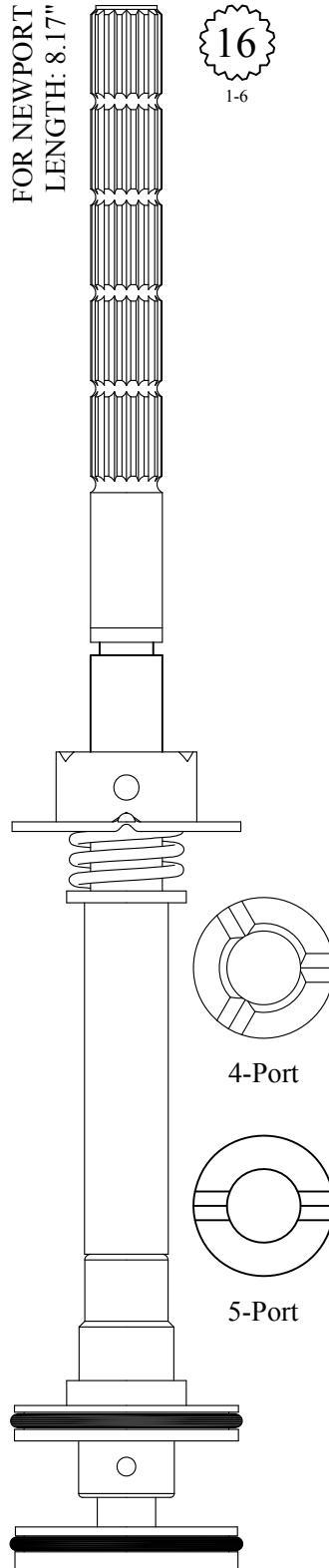

439860 4-Port
239860 Stem Only
439870 5-Port
239870 Stem Only

FOR HARDEN
LENGTH: 8.18"

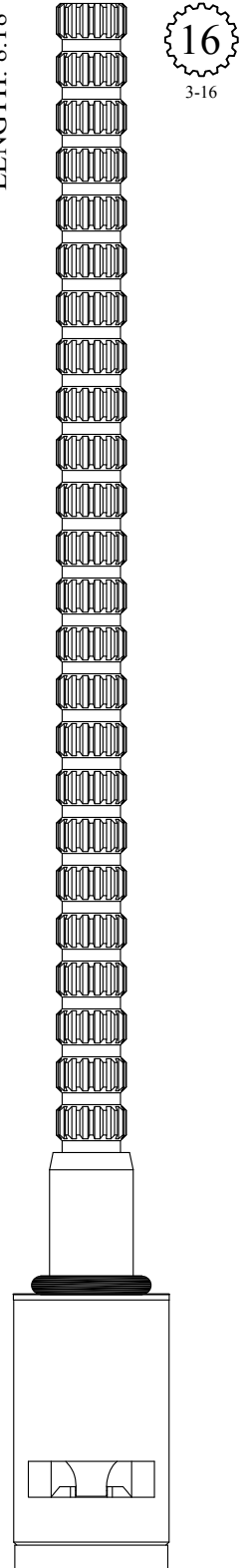

DISC SET: 151380-PKG

428211
428212

FOR HARDEN
LENGTH: 8.28"

16
3-16

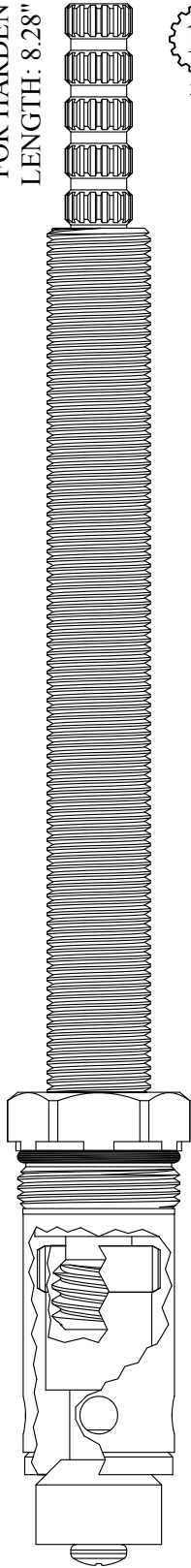

GASKET: 891140 O-RING INCLUDED

439722

FOR HARDEN
LENGTH: 8.32"

16
3-16

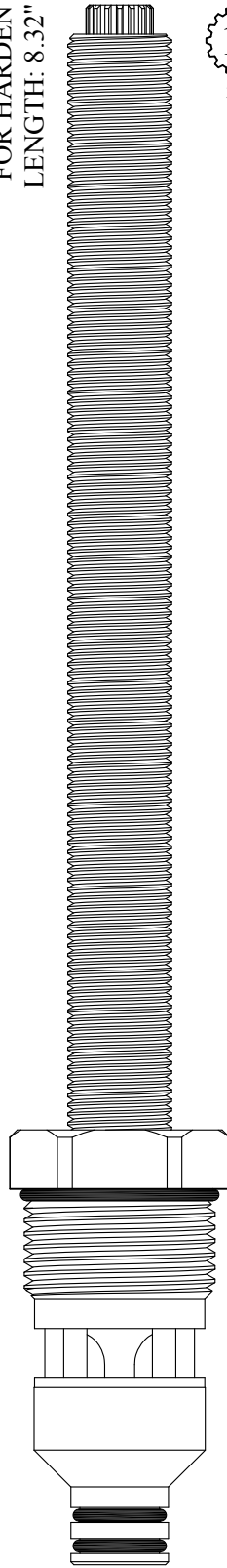

GASKET: 890210 O-RING INCLUDED
DISC SET: 151380-PRG

428111
428112

FOR CRANE
LENGTH: 8.38"

13/32 - 27 TPI

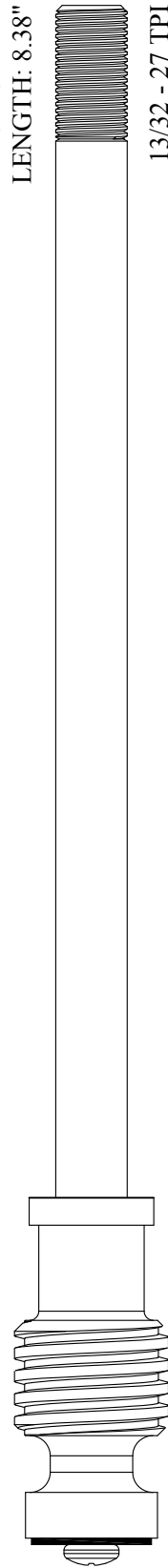

Chrome Plated Stem

227101

FOR AM STD
LENGTH: 8.38"

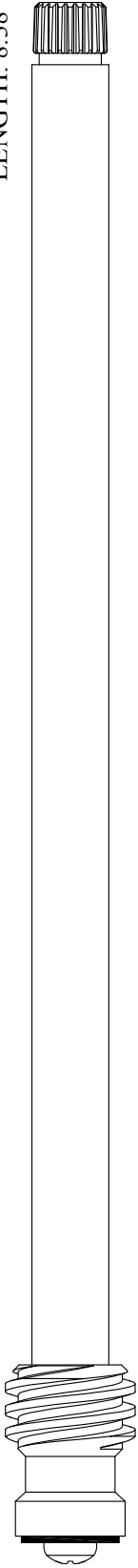

22
1-4

Chrome Plated Stem

228241
USES BARREL:
LF647021

FOR ALTMANS
LENGTH: 8.50"

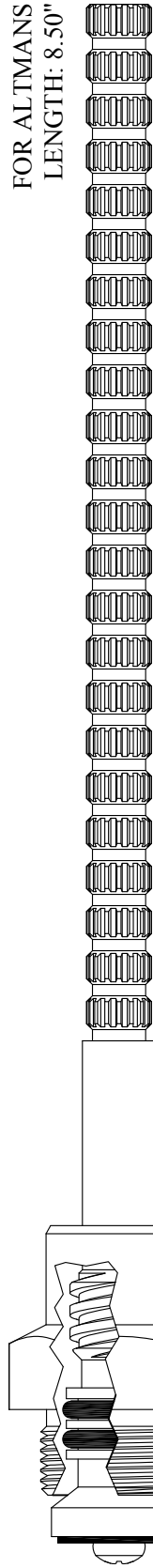

16
3-16

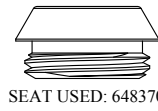

SEAT USED: 648370

GASKET: 895390

428271
428272

FOR HARDEN
LENGTH: 8.57"

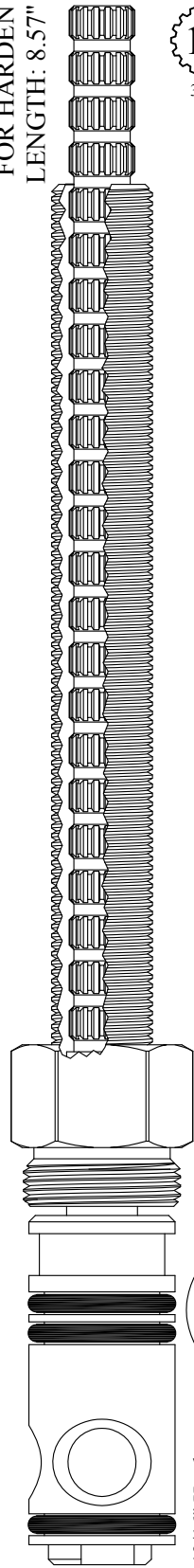

16
3-16

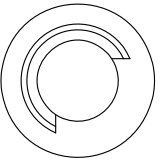

13/16" Head

439740
239740 Stem Only

FOR ALTMANS
LENGTH: 8.73"

16
3-16

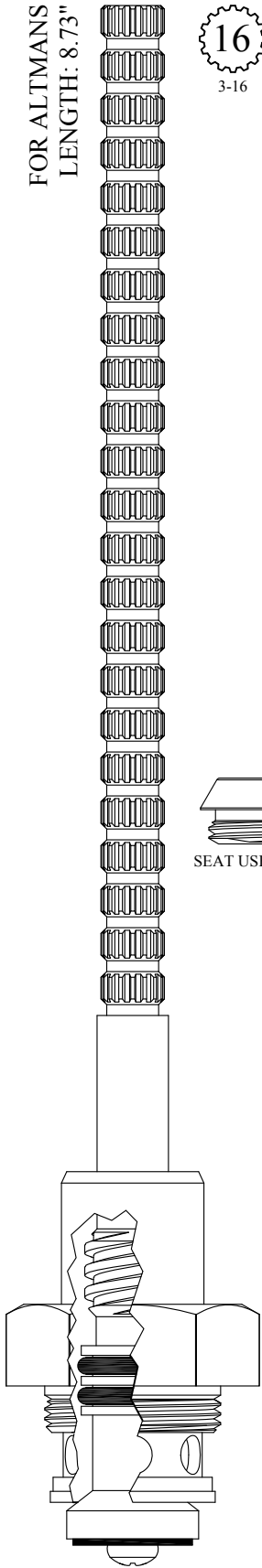

GASKET: 895550

439771

FOR KOHLER
LENGTH: 8.87"

19
1-7

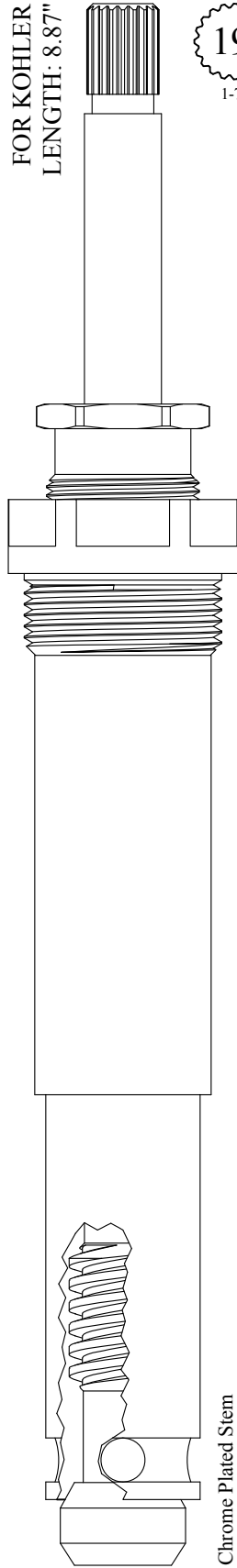

Chrome Plated Stem

GASKET: 895450

439801
239801 Stem Only

FOR KOHLER
LENGTH: 8.87"

12
1-2

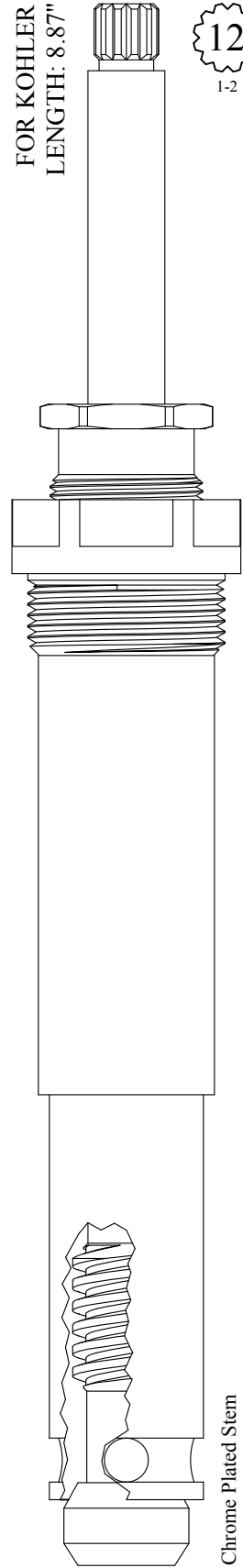

Chrome Plated Stem

GASKET: 895450

439851
239851 Stem Only

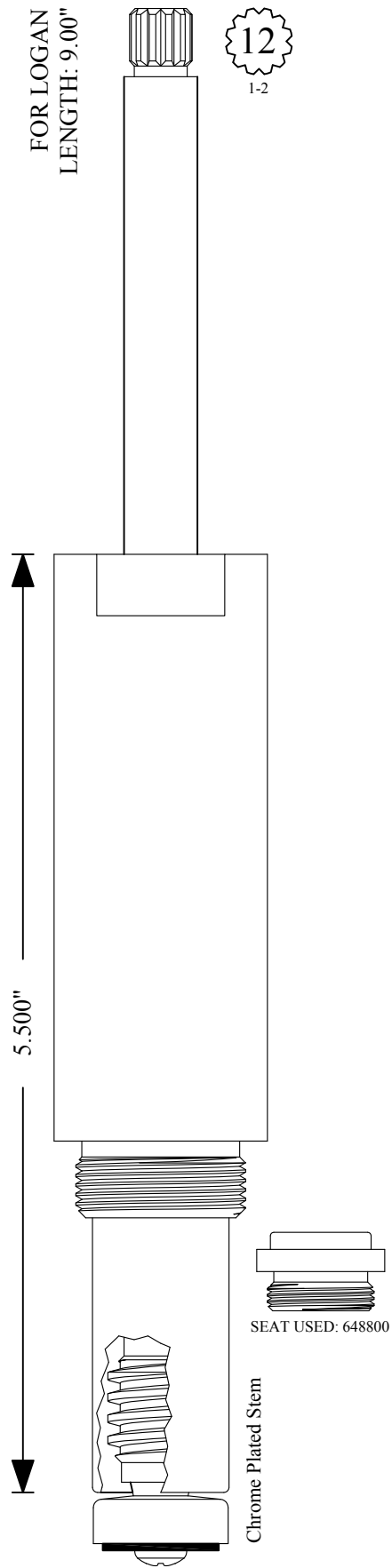

GASKET: 895570

428311

228311 Stem Only

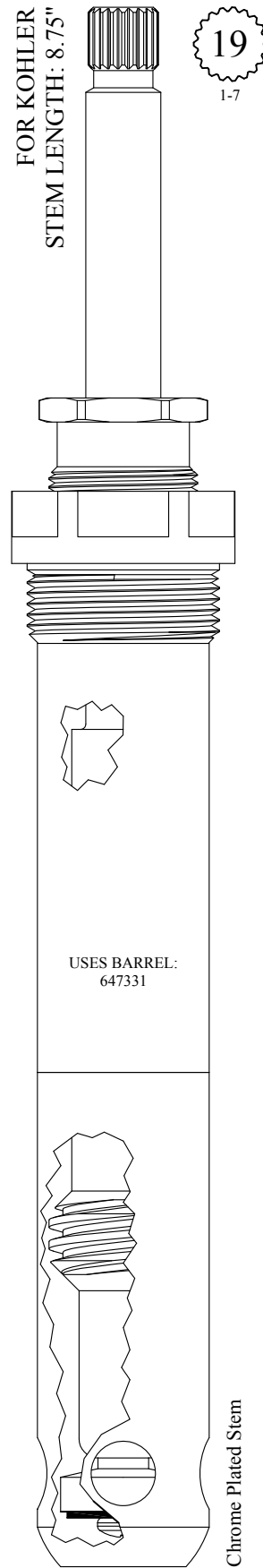

GASKET: 895450

428331

228331 Stem Only

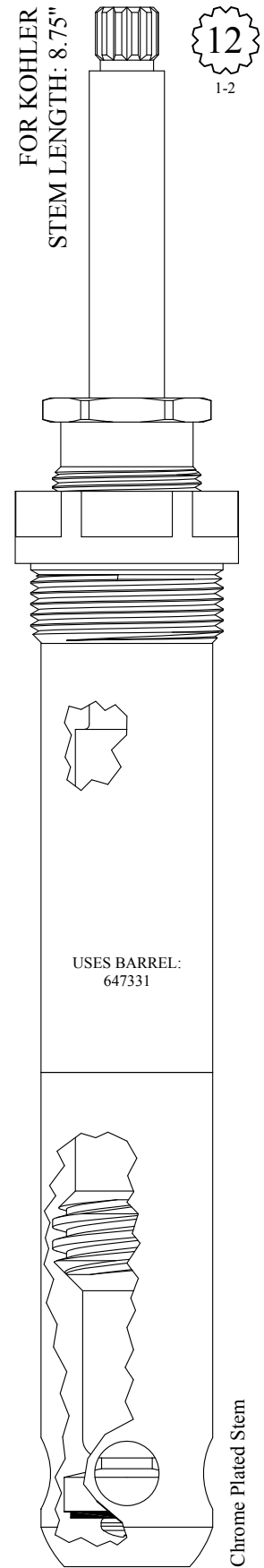

GASKET: 895450

428381

228381 Stem Only

FOR SPEAKMAN
LENGTH: 9.09"

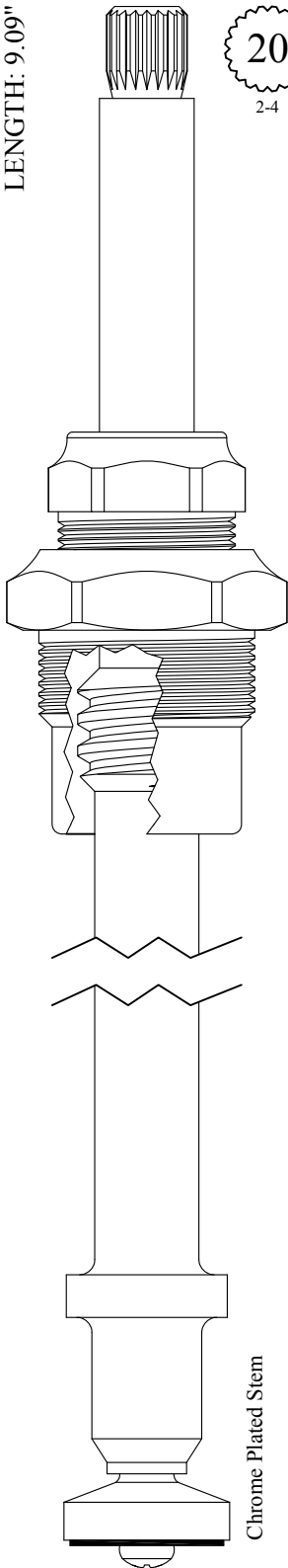

20
2-4

Chrome Plated Stem

GASKET: 895450

428341

228341 Stem Only



SEAT USED: LF648930 or 648180

FOR SPEAKMAN
LENGTH: 9.09"

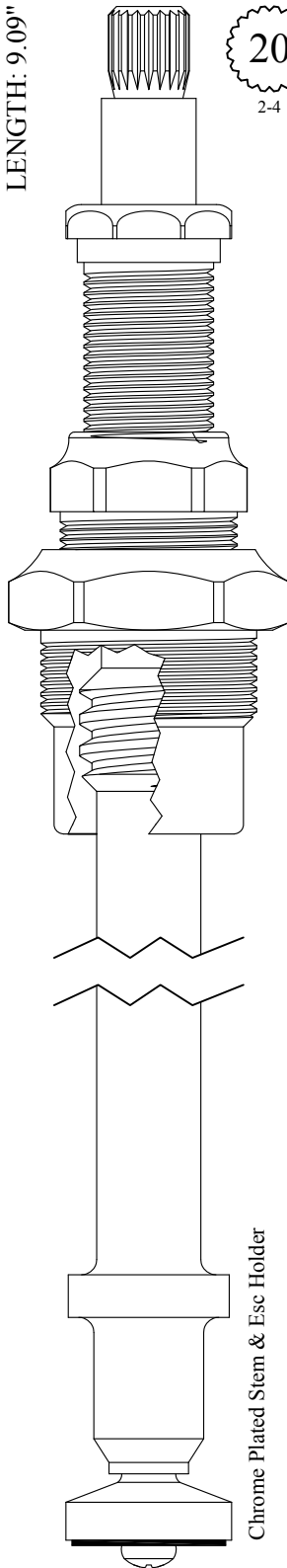

20
2-4

Chrome Plated Stem & Esc Holder

GASKET: 895450

428421

228421 Stem Only



SEAT USED: LF648930 or 648180

FOR FEDERAL HUBER
LENGTH: 9.13"

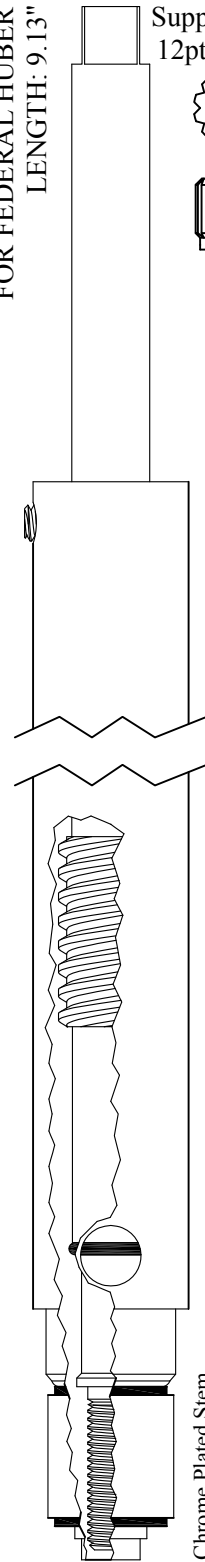

Supplied with
12pt. Broach

12
1-2

Chrome Plated Stem

439921

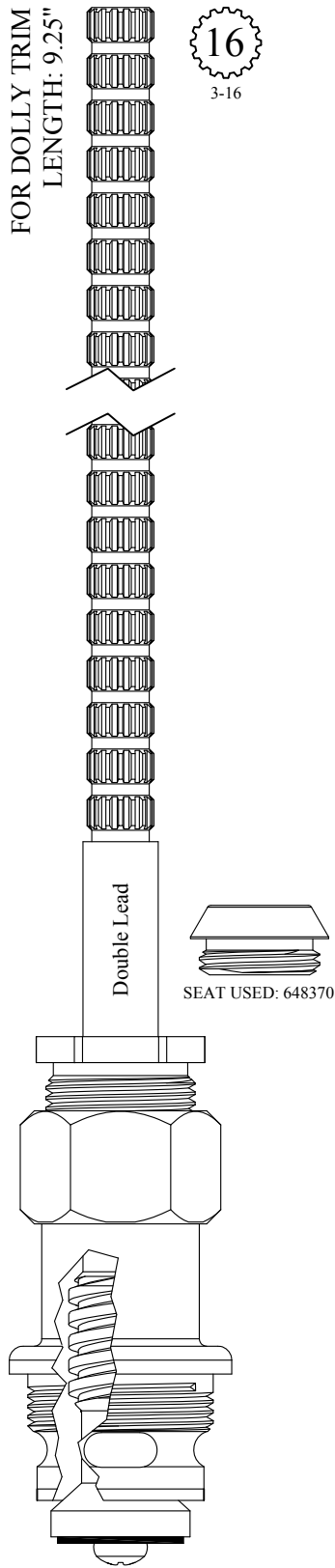

GASKET: 895550

439881
239881 Stem Only

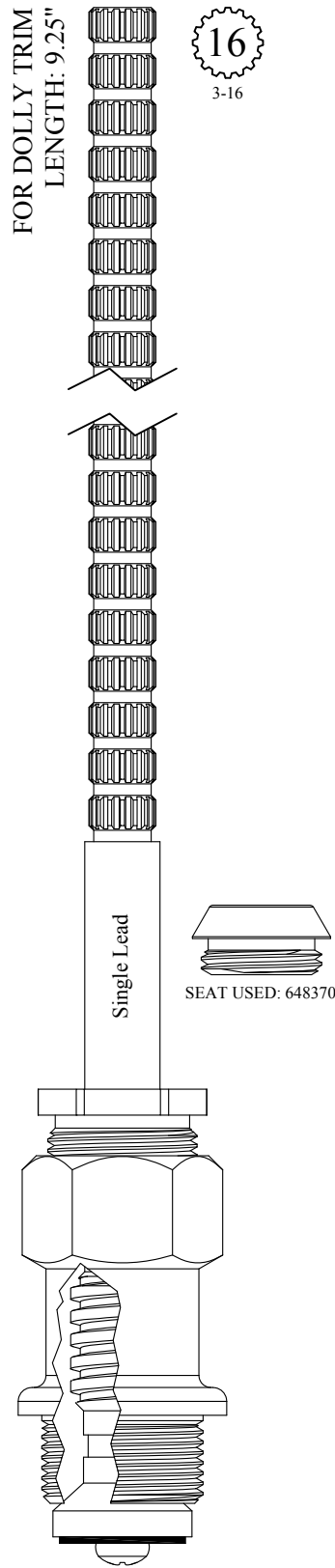

GASKET: 895400

428391
428392
228391 Stem Only
228392 Stem Only

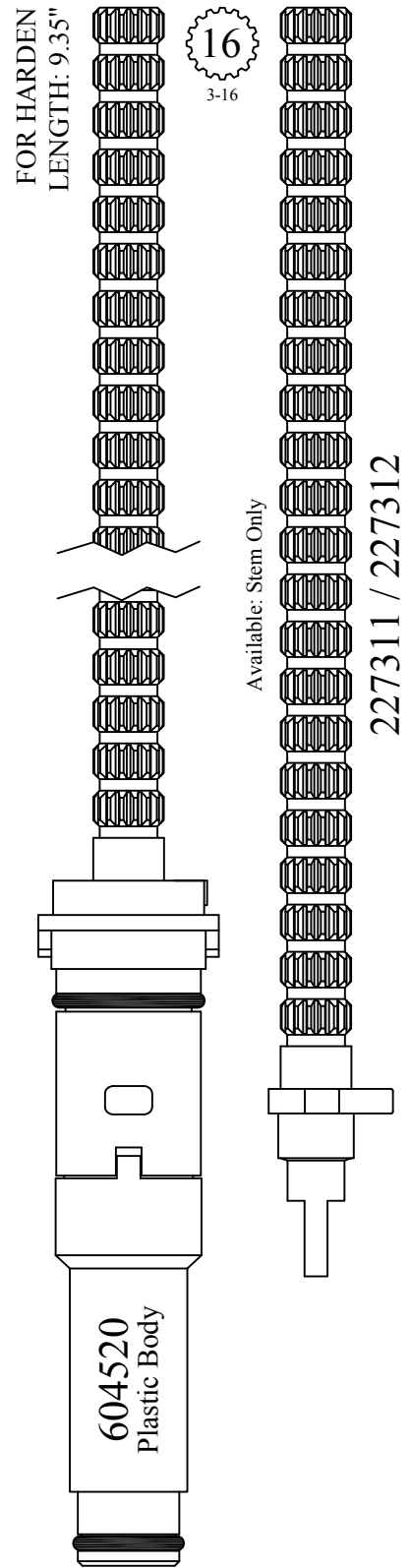

Available: Stem Only

227311 / 227312

427311
427312

FOR AM STD
LENGTH: 9.38"

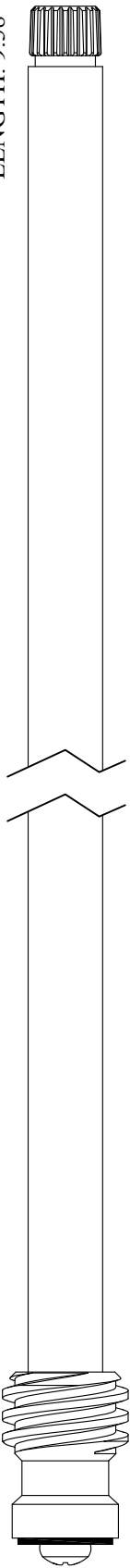

22
1-4

Chrome Plated Stem

228411
USES BARREL:
LF647021

FOR LOGAN
LENGTH: 9.50"



12
1-2

Chrome Plated Stem

GASKET: 895570

428401
228401 Stem Only

FOR ALTMANS
LENGTH: 9.50"

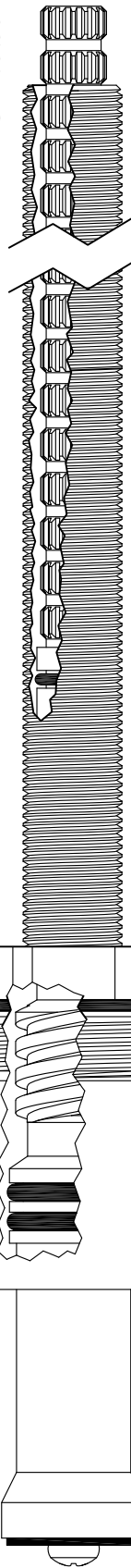

16
3-16

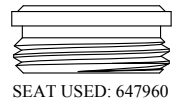

SEAT USED: 647960

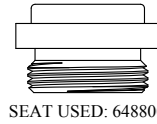

SEAT USED: 648800

GASKET: 890210 O-RING INCLUDED

428451
428452

FOR HARDEN
LENGTH: 9.53"

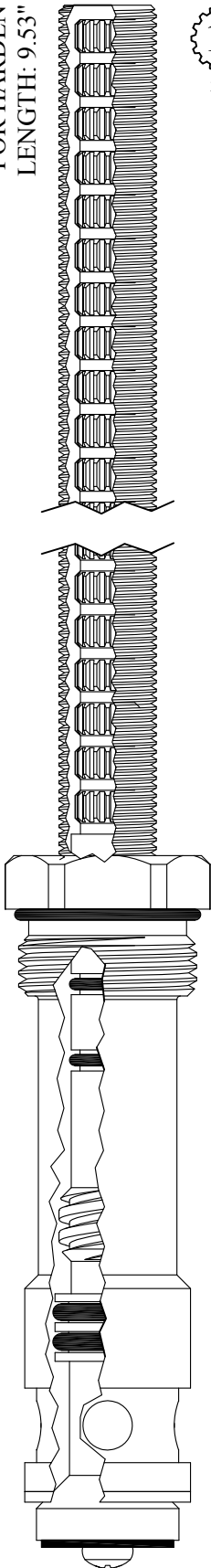

16
3-16

GASKET: 891180 O-RING INCLUDED

439911

FOR HARDEN
LENGTH: 9.66"

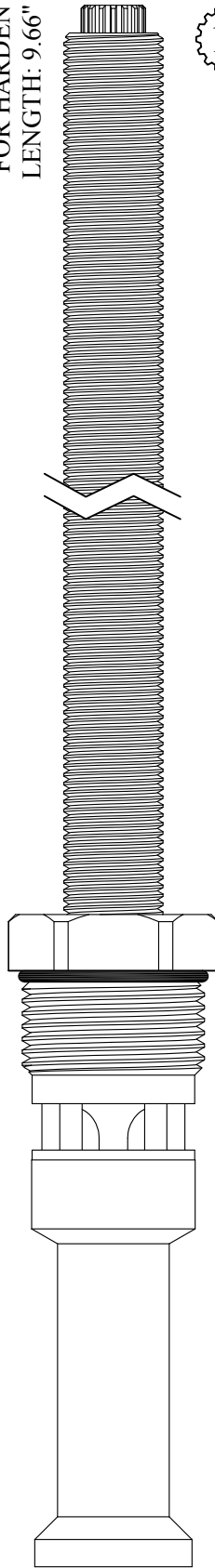

16
3-16

GASKET: 890210 O-RING INCLUDED
SEAL: 898510
DISC SET: 151380-PKG

428441
428442

FOR ALTMANS
LENGTH: 9.66"

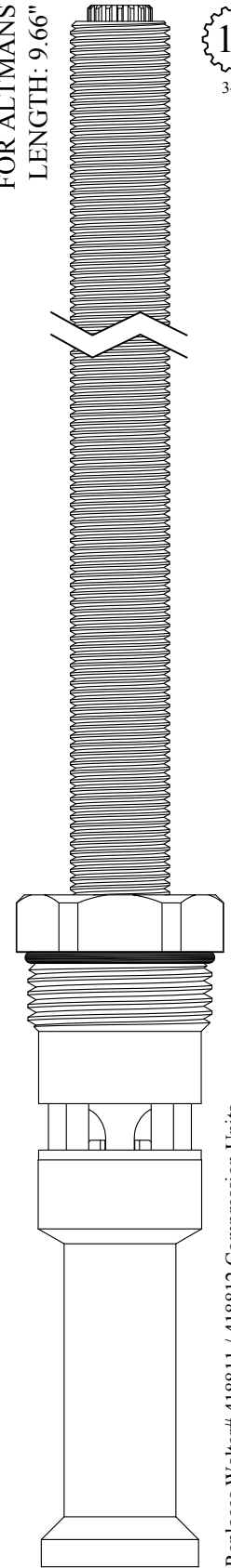

16
3-16

GASKET: 890210 O-RING INCLUDED
SEAL: 898510
DISC SET: 151380-PKG

428461
428462

Replaces Walter# 418811 / 418812 Compression Units

FOR AM STD
LENGTH: 9.75"

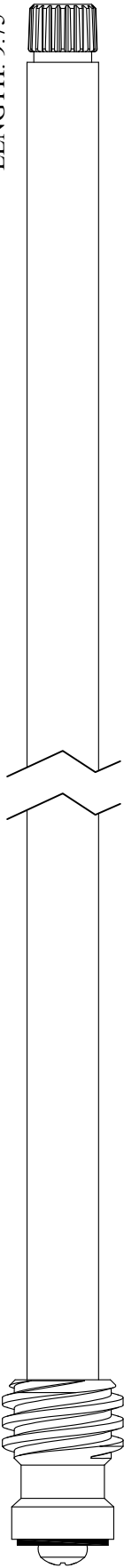

22
1-4

228431
USES BARREL:
LF647021

FOR AM STD
LENGTH: 10.75"

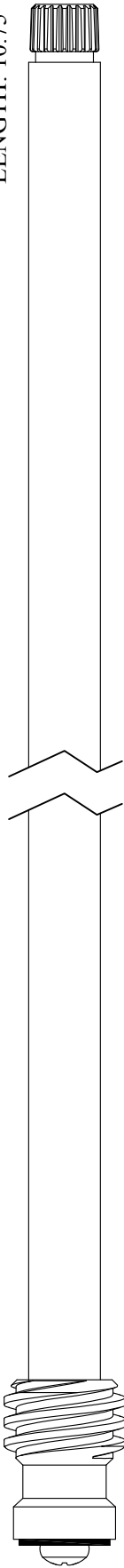

22
1-4

228611
USES BARREL:
LF647021

FOR CRANE
LENGTH: 10.80"

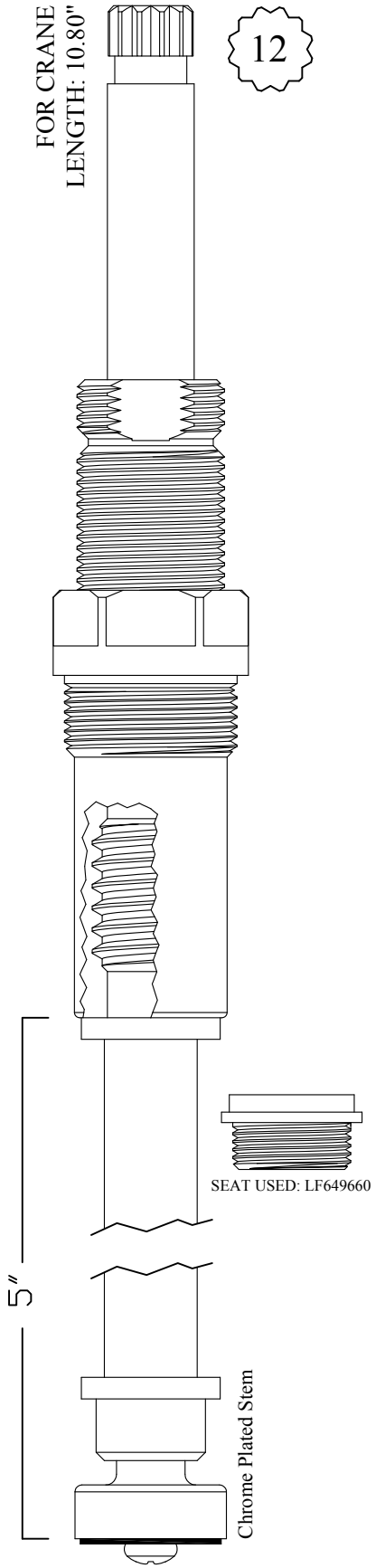

12

GASKET: 895340

428501
228501 Stem Only

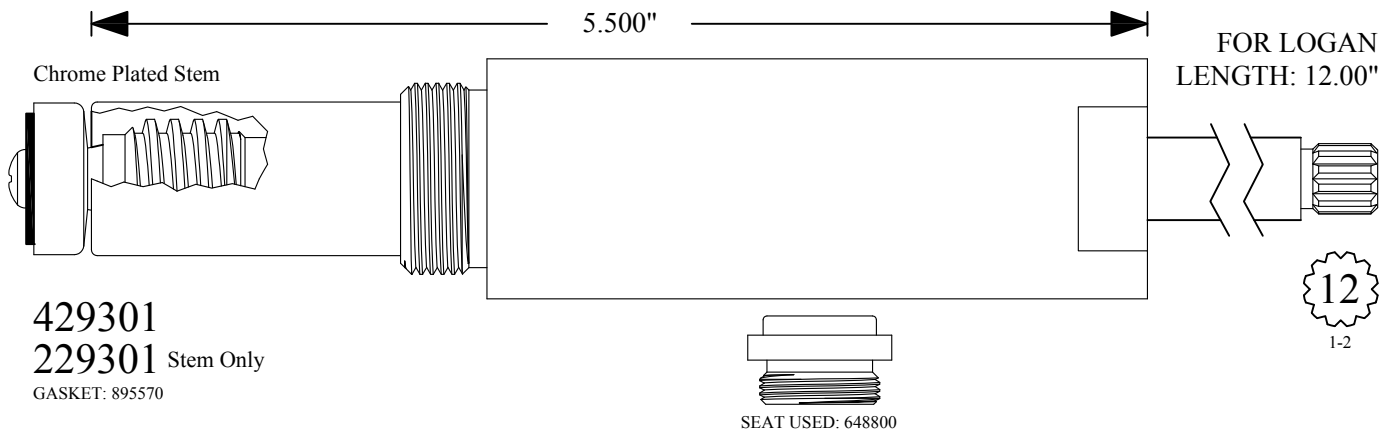
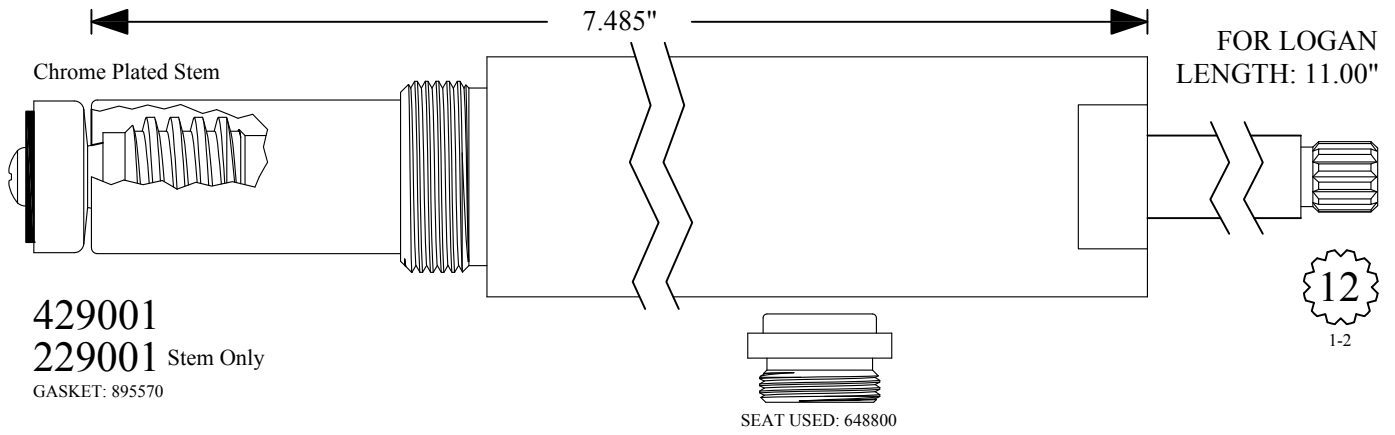

Also available in the following lengths:

UNIT	STEM ONLY	LENGTH
429501	229501	14.00"
429601	229601	16.00"
429701	229701	18.00"

Send Your Orders To:

BARRY E.  SR. CO.

E-mail: orderdesk@barrywalter.com

Fax: 1.800.886.9831

Phone: 1.800.767.5552