

MISSION STATEMENT

Our mission is to serve with integrity, being dedicated to manufacturing and supplying superior quality plumbing parts to our customers with a focus on relationships and an eye on future needs while caring for our team and their families by providing a fair wage and good benefits in a safe and quality work environment.

TERMS AND CONDITIONS OF SALE

SALES POLICY:

It is our policy to sell the OEM and wholesale level only. Possession of this book does not constitute an offer to sell. Prices are subject to change without notice. All orders will be shipped and invoiced at the prevailing price at the time of shipment. We reserve the right to adjust orders to standard package quantities unless otherwise stated on purchase order. All orders are subject to acceptance by Barry E. Walter Sr. Co., 2550 E. Platte Ave., Fort Morgan, CO 80701. The Minimum billing is \$50.00. Drop shipments will carry a 10% surcharge and must meet minimum requirements.

TERMS:

3% 20, Net 30. Payment must be received within 20 days of the invoice date for the discount to be allowed. Any amount past due is subject to finance charge on the total past due balance in accordance with the truth-in-lending act. Invoices not paid according to the terms are subject to MONTHLY SERVICE CHARGES of 1 1/2% per month (which is an ANNUAL PERCENTAGE RATE OF 18%). Returned checks (NSF) will be charged a \$25.00 handling charge. Prices are subject to any federal, state, sales use or other tax applying, unless exemption certificates are on file with Barry E. Walter Sr. Co. Cancellation of regular merchandise orders can be authorized only by Barry E. Walter Sr. Co. Handling charges may be assessed for canceled orders.

FREIGHT:

All orders will be shipped FOB Fort Morgan, Colorado. Shipping charges will be prepaid and added to the invoice unless different arrangements have been made.

RETURNS:

No goods will be accepted for return unless authorized by Barry E. Walter Sr. Co. in advance of return. Return goods are subject to a minimum 20% handling charge plus freight. All material returned without prior written permission will be assessed a minimum of 50% plus freight.

CLAIMS:

Claims for shortage must be made within five days after receipt of shipment. Items defective in material or workmanship will be replaced without charge. It is expressly understood that Barry E. Walter Sr. Co., liability is limited to furnishing of such replacement parts and that Barry E. Walter Sr. Co. will not be liable for any damages, losses, or expenses arising in connection with the use of or inability to use our products for any purpose. Damaged shipments must be made available to the carrier or transportation company for inspection.

SPECIAL MATERIAL:

Materials made to the specifications of the customers by Barry E. Walter Sr. Co. are not returnable. Once an order has been placed it cannot be canceled. Barry E. Walter Sr. Co. reserves the right to charge a \$50.00 research fee to identify and quote on customer special requests.

GENERAL:

Barry E. Walter Sr. Co. represents that it has complied with the Fair Labor Standards Act of 1938, as amended, and the Fair Employment Practice Act. All Catalogs, Price List, and Production Information Publications remain the property of Barry E. Walter Sr. Co. We also stock many items which are not currently included in our catalog and are constantly adding replacement parts. If you don't find the item you need, just ask!

Any usage of original manufactures' names or numbers, product names, and model names or numbers on invoices, quotes, or packing slips are strictly for descriptive and identification purposes. All drawing representations or depictions of original manufactures' products in Barry E. Walter Sr. Co. catalogs or faxes are strictly for identification purposes, and are used to determine the proper Barry Walter Co. replacement part. They are not meant to imply that the parts are manufactured by the original equipment manufacturer.

INDEX BY MANUFACTURER

ACME.....2	Docol.....194	Lenhart.....322	Savoy.....433
Acorn.....4	Dolly Trim.....195	Leonard.....323	Sayco.....450
Advance Tabco / B&K.....8	Dolphin.....197	Liberty.....326	Scoville.....457
Altmans.....9	Donner.....197	Logan.....326	Sears/UR/Elkay.....458
American Brass.....13	Dorf.....198	Mangori.....328	Seacrest.....465
American Kitchen.....19	Dornbracht.....202	Mansfield.....328	Sepco.....465
American Standard.....20	Dwyer.....206	McCambridge.....329	Sherle Wagner.....467
Apex.....60	East River.....206	Melcliff.....329	Sigma.....469
Aquasource.....60	Electroway.....208	Metcraft.....330	Sign of the Crab.....469
Arjo.....61	Elizabethan.....208	Michigan Brass.....331	Simbolo.....472
Arselux.....61	Eljer.....209	Milwaukee.....334	Sisco.....472
Armonia.....62	Elk.....223	Mixet.....342	Soho.....473
Arrowhead.....64	EMCO.....223	Moen.....343	Speakman.....475
Art F.....67	Empire.....226	Mountain.....345	Sphinx.....497
Arti Deco.....69	Enterprise.....228	Mueller.....346	Springhouse.....498
Artistic Brass.....69	Fantini.....228	Murray & Sorenson.....356	Standard Sanitary.....499
Atlas.....73	Federal Huber.....229	Newport.....357	Sterling Brass.....501
Auburn Brass.....76	Fiat.....233	NFC / American Faucets..360	Sterling Faucet.....505
A.Y. McDonald.....78	Fisher.....234	Nibco.....360	Streamliner.....518
Avilion.....78	Foremost.....236	Nicolazzi.....361	Streamway.....518
Balocchi.....80	Forest.....236	Norca.....361	Sunrise/Pro Plus.....522
Barber Wilson.....80	Franke.....237	Omni.....362	Super Grif.....522
Bardes.....81	Gerber.....238	Ondine.....362	Symmons.....524
Barnes.....81	Glacier Bay.....246	Orion.....363	System.....530
Bear Brand.....86	Glauber Salter.....247	Ottone & Meloda.....364	T&S.....530
Belmont.....87	Glauber West Coast.....251	P.E. Guerin.....365	Tanner.....533
Belvedere.....87	Goetz.....255	Pacific.....367	Tempress.....535
Block Brass.....88	Grand Haven.....256	Pacifica.....368	THG.....535
Borg-Warner.....91	Grohe.....258	Paini.....368	Twyford Bathrooms.....535
Bradley.....92	Hajoca.....260	Paul.....369	Union Brass/Gopher.....536
Brasscraft.....94	Harcraft.....261	Pegasus.....370	United.....543
Briggs.....94	Harden.....267	Perlick.....371	Universal Brass.....543
Broadway.....116	Harrington.....276	Phoenix.....371	Urrea.....544
Burlington.....120	Hastings.....276	Phylrich.....375	Watts.....544
Cal Faucets.....122	Haws.....277	Piazza.....384	Water Saver.....545
California Brass.....123	Helvex.....277	Piel.....385	Watermark.....546
Cambridge.....124	Hudson.....278	Pilot.....385	Waterworks.....546
Case.....124	Illinois.....278	Porcher.....385	Wellington.....547
Central.....127	Import.....279	Powers.....386	West Brass.....548
Chase.....144	Indiana.....283	Precision.....388	West Brass (Italy).....548
Chatsworth.....144	I.W. Industries.....287	Premier.....388	West Brass (Japan).....548
CHG.....145	J.L. Mott.....288	Price Pfister.....389	Willoughby.....551
Chicago.....147	Jaclo.....289	Principe.....410	Wolverine.....553
Cifial.....152	Jacuzzi.....290	Pubco.....411	Yugo.....558
Cleveland.....152	Jado.....291	Queen City.....414	Zurn.....559
Concinnity.....153	Jameco.....292	Rapetti.....415	Unknown.....560
Coyne Delaney.....154	Kallista.....292	Reid Watson.....416	
Crane.....155	Kingsbury.....296	Richmond Rheem.....418	
Cuthbert.....182	Kingston Brass.....296	Roberts Brass.....419	
Danfoss.....182	Kohler.....299	Rodac.....420	
Delta.....183	Kroin by Vola.....320	Rohl.....421	
Dick Brothers.....185	Kugler.....320	Ross & Gade.....422	
Dishmaster.....193	Labonge.....321	Royal Brass.....425	
Disney Cruise.....193	Larden.....321	Rugo.....432	
Dobo.....194	Lawler.....321	Santec.....432	

FOR ACME BRASS

LENGTH: 2.88"

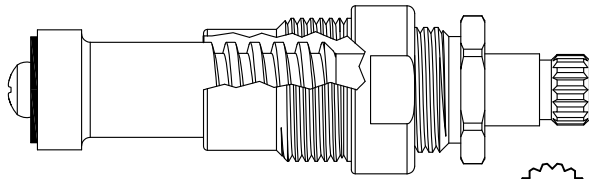

LF465301/ LF465302

GASKET: 895100

16
1-6

LENGTH: 4.17"

Chrome Plated Stem

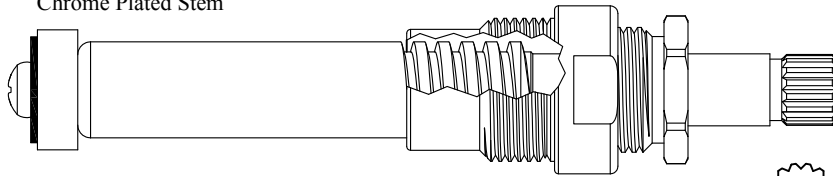

LF469801

LF269801 Stem Only

GASKET: 895100

16
1-6

LENGTH: 4.91"

Chrome Plated Stem

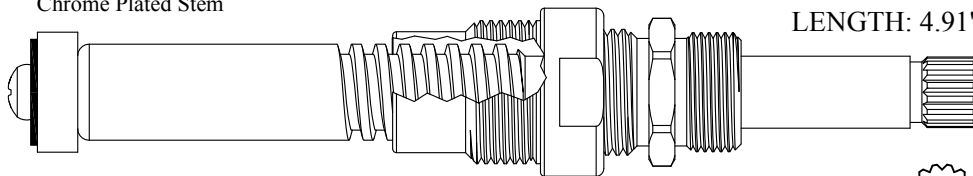

LF475001

LF275001 Stem Only

GASKET: 895100

16
1-6

LENGTH: 5.19"

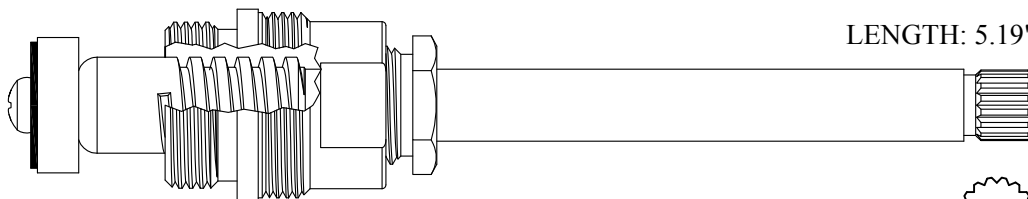

416911

216911 Stem Only

GASKET: 895180

16
1-6

FOR ACME BRASS

Chrome Plated Stem & Sleeve

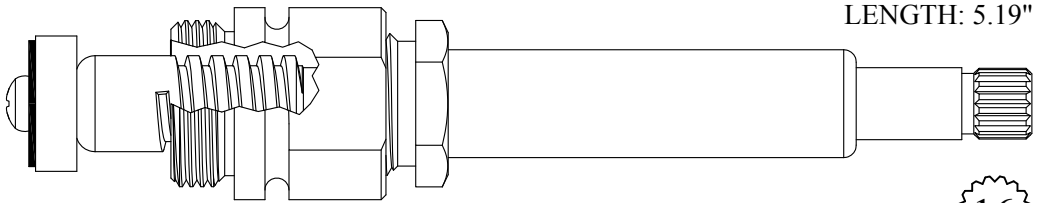

LENGTH: 5.19"

414621

214621 Stem Only

GASKET: 895180



Chrome Plated Sleeve

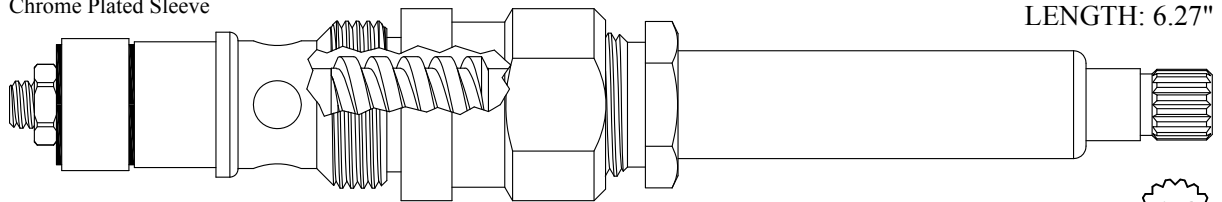

LENGTH: 6.27"

438611

238611 Stem Only

GASKET: 895180

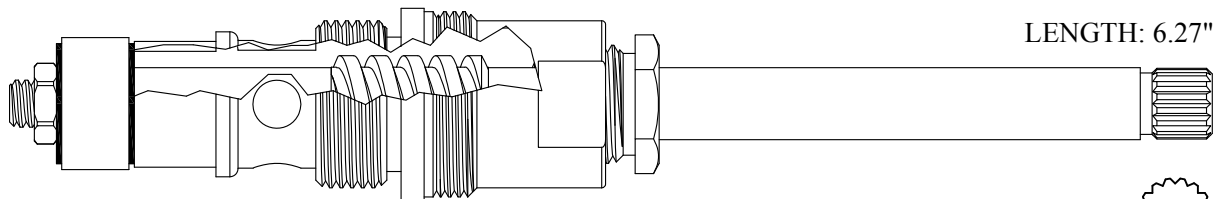

LENGTH: 6.27"

438621

238611 Stem Only

GASKET: 895180



BARRY E.  ALTER  SR. CO.

FOR ACORN

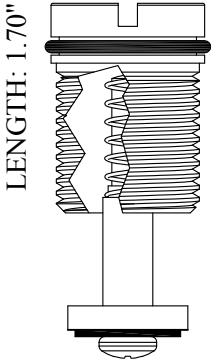

LENGTH: 1.70"

LF400190

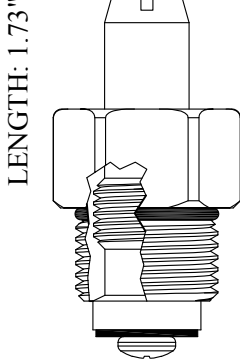

LENGTH: 1.73"

GASKET: 890160 O-RING INCLUDED

LF454071
LF254071 Stem Only

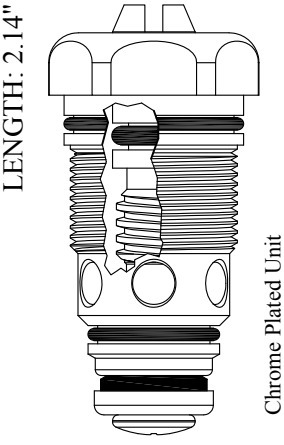

LENGTH: 2.14"

Chrome Plated Unit

461922

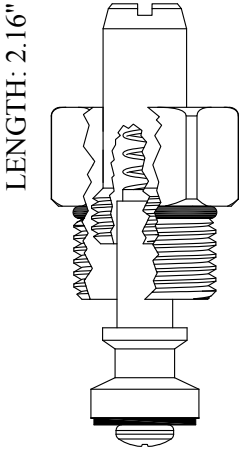

LENGTH: 2.16"

GASKET: 890160 O-RING INCLUDED

LF400571
LF200571 Stem Only

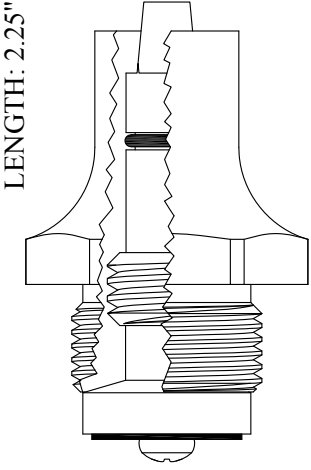

LENGTH: 2.25"

Chrome Plated Bonnet

GASKET: 895570

483121

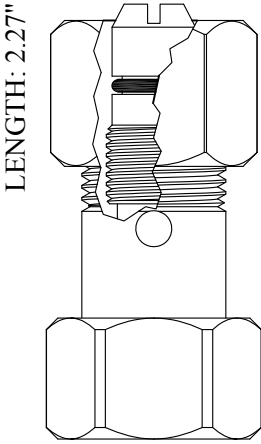

LENGTH: 2.27"

LF138921
LF136401 Stem Only

FOR ACORN

Also available less bonnet
LF463260

LENGTH: 2.28"

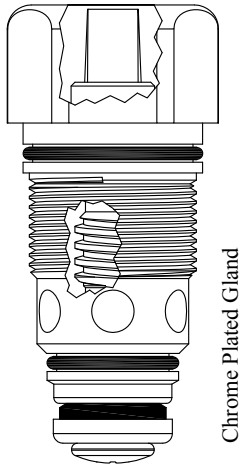

Chrome Plated Gland

462702

LENGTH: 2.37"

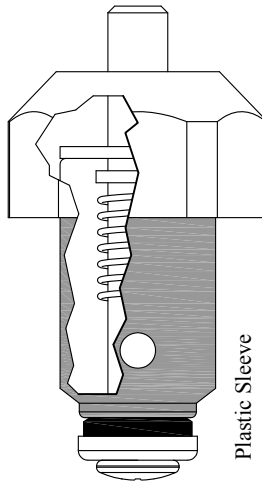

Plastic Sleeve

LF463270

LENGTH: 2.38"

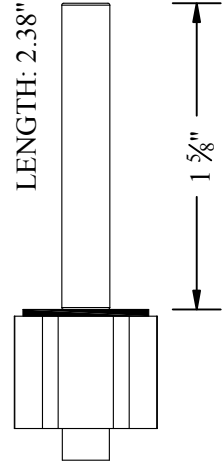

LF158310



SEAT USED: LF647560

Also available less bonnet
464542

LENGTH: 2.44"

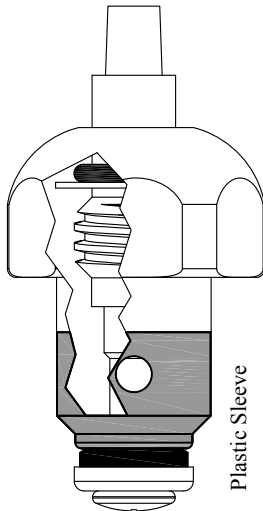

Plastic Sleeve

464552

LENGTH: 2.54"

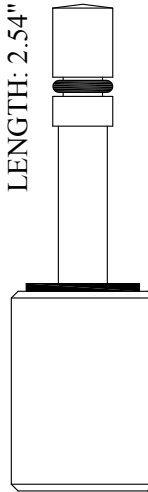

Stainless Steel Shank

LF138990

LENGTH: 2.57"

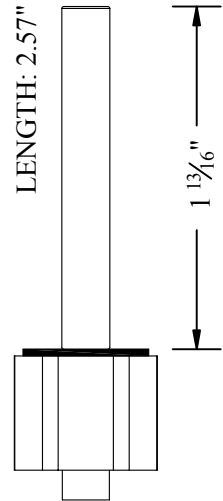

LF130680



SEAT USED: LF647560



SEAT USED: LF647560

FOR ACORN

Also available less gland
LF117621

LENGTH: 2.72"

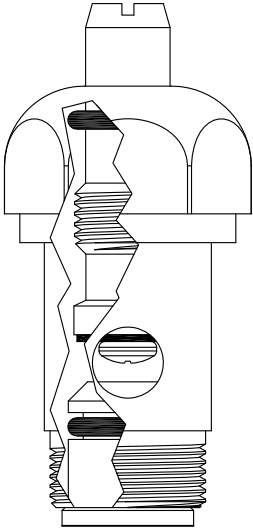

GASKET: 895400
 SEAT INCLUDED: LF601780

LF401781
LF254071 Stem Only

Also available less bonnet
LF466490

LENGTH: 3.13"

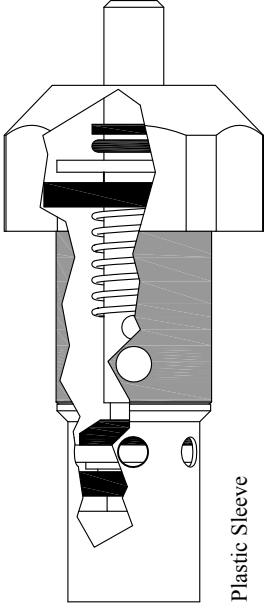

Plastic Sleeve

LF466500

LENGTH: 3.24"

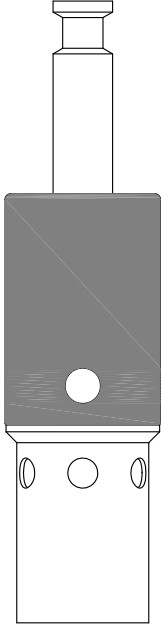

Plastic Sleeve

468490

LENGTH: 3.65"

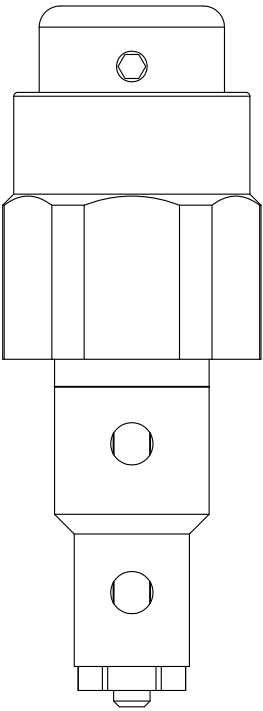

LF402880

LENGTH: 4.00"

5/16
 TAPERED

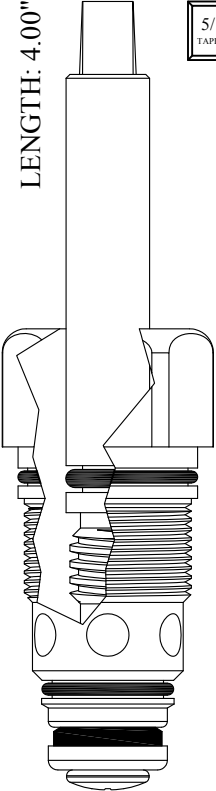

Chrome Plated Gland

469702

LENGTH: 4.00"

5/16
 TAPERED

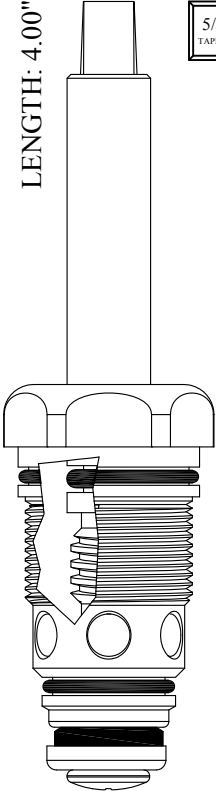

Chrome Plated Gland

469712

FOR ACORN

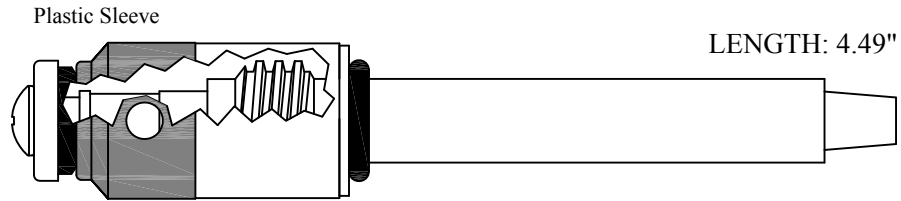

470052
270052 Stem Only

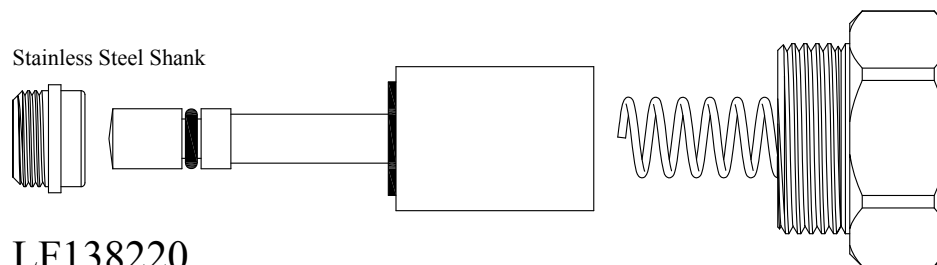

LF138220
GASKET INCLUDED: 895550
SEAT INCLUDED: LF647560

Send Your Orders To:

BARRY E.  WALTER  SR. CO.

E-mail: orderdesk@barrywalter.com

Fax: 1.800.886.9831

Phone: 1.800.767.5552

FOR ADVANCED TABCO / B & K

LENGTH: 1.60"

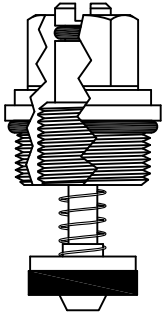

GASKET: 890170 O-RING INCLUDED

400241

Gland turns
clockwise
into valve body



LENGTH: 1.61"

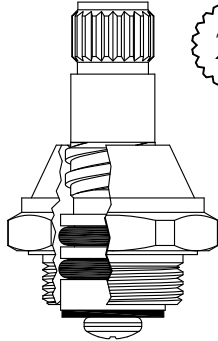

20

2-4

Chrome Plated Gland

GASKET: 895100

LF455411
LF455412

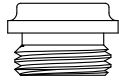

SEAT USED: LF648270

Gland turns
counter-clockwise
into valve body



LENGTH: 1.61"

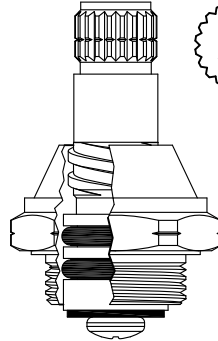

20

2-4

Chrome Plated Gland

GASKET: 895100

LF455462

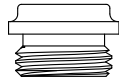

SEAT USED: LF648270

LENGTH: 1.65"

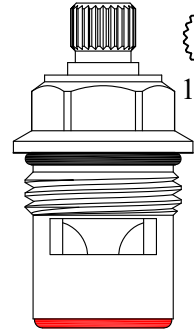

24

11/32"
(import)

Chrome Plated Gland

GASKET: 890170 O-RING INCLUDED
SEAL: 898570-R/B
DISC SET: 151380-PKG

LF452601
LF452602

Gland turns
clockwise
into valve body



Knurled lock ring also available

952900

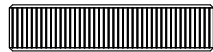

LENGTH: 1.65"

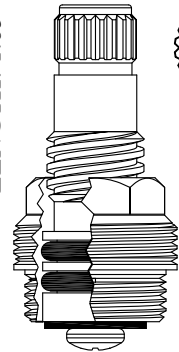

20

2-4

Also available as chrome plated unit

LF452901-CP/ LF452902-CP

GASKET: 895100

LF452901
LF452902

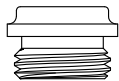

SEAT USED: LF648270

Gland turns
counter-clockwise
into valve body



LENGTH: 1.65"

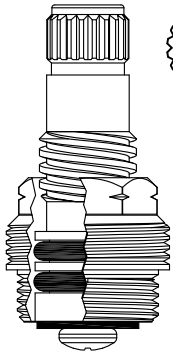

20

2-4

GASKET: 895100

LF452922

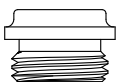

SEAT USED: LF648270

LENGTH: 1.68"

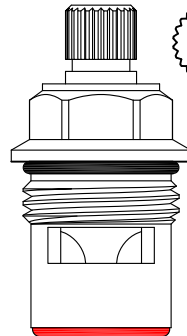

24

3-19

Chrome Plated Gland

GASKET: 890170 O-RING INCLUDED
SEAL: 898570-R/B
DISC SET: 151380-PKG

LF452621
LF452622

LENGTH: 2.34"

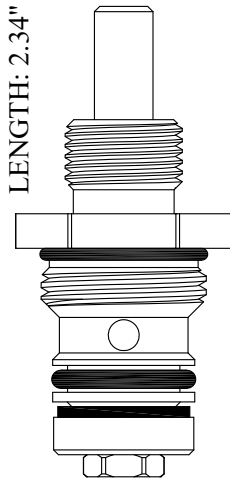

Chrome Plated Unit

GASKET: 890180 O-RING INCLUDED

LF464450
LF264450 Stem Only

FOR ALTMANS

LENGTH: 2.30"

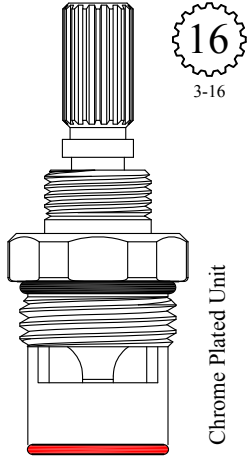

Chrome Plated Unit

GASKET: 890170 O-RING INCLUDED
SEAL: 898580-R/B
DISC SET: 151380-PKG

LF462411
LF462412

LENGTH 2.74"

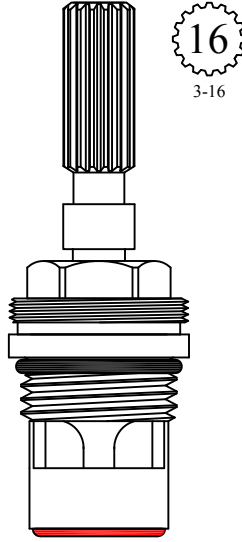

GASKET: 890170 O-RING INCLUDED
SEAL: 898570-R/B
DISC SET: 151380-PKG

LF464911
LF464912

LENGTH: 2.75"

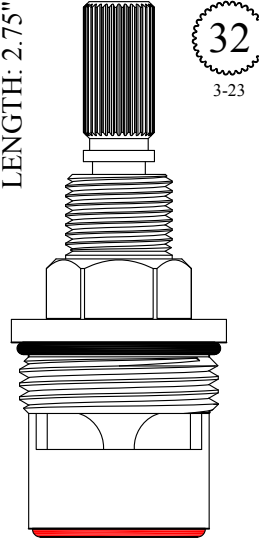

GASKET: 890210 O-RING INCLUDED
SEAL: 898610-R/B
DISC SET: 109850-PKG

401571
401572

LENGTH 2.75"

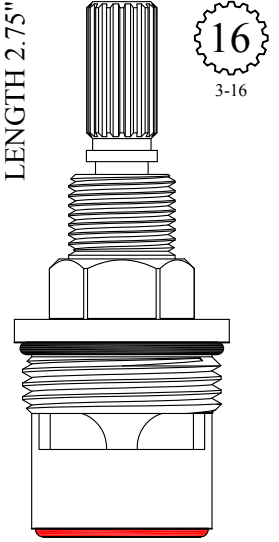

GASKET: 890210 O-RING INCLUDED
SEAL: 898610-R/B
DISC SET: 109850-PKG

401641
401642

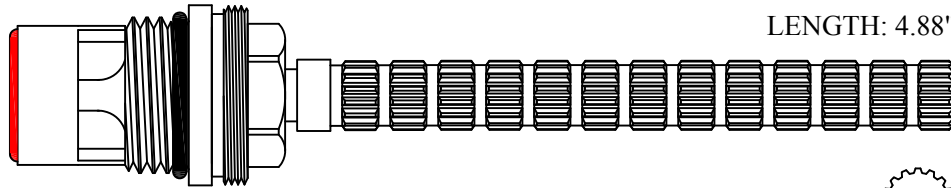

LENGTH: 4.88"

417311/ 417312

GASKET: 890170 O-RING INCLUDED
SEAL: 898570-R/B
DISC SET: 151380-PKG

16
3-16

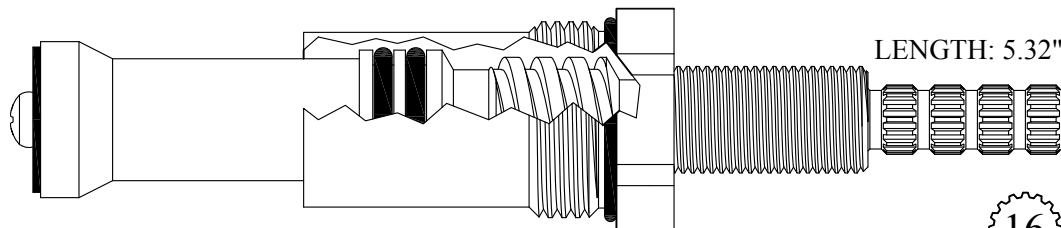

LENGTH: 5.32"

418811/ 418812

GASKET: 890210 O-RING INCLUDED

16
3-16

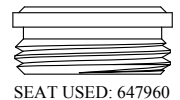

SEAT USED: 647960

FOR ALTMANS

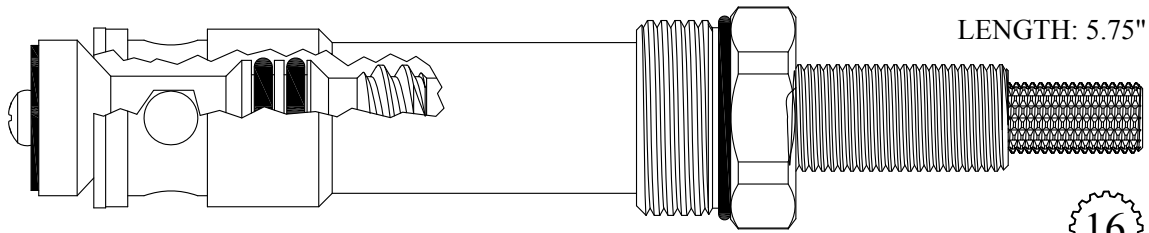

LENGTH: 5.75"

435841

GASKET: 890210 O-RING INCLUDED



SEAT USED: 647960

16
3-16

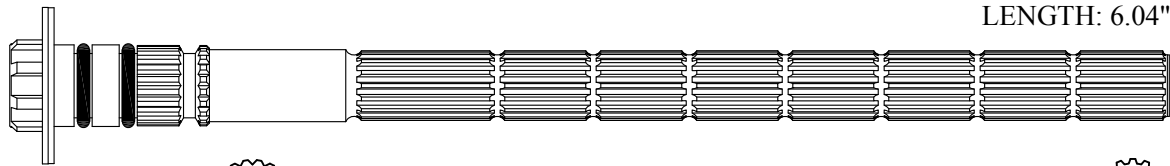

LENGTH: 6.04"

225730

20
2-4

16
3-16

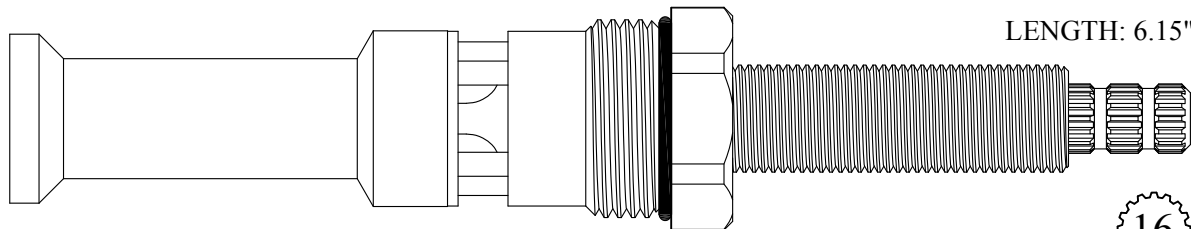

LENGTH: 6.15"

426421/ 426422 (Replaces Walter# 418811 / 418812 Compression Units)

GASKET: 890210 O-RING INCLUDED

SEAL: 898510-W

DISC SET: 151380-PKG

16
3-16

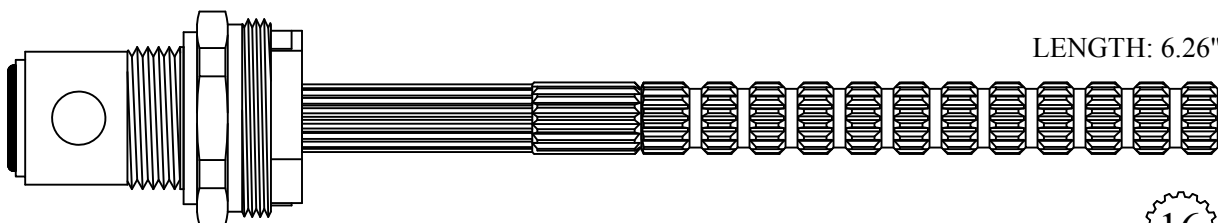

LENGTH: 6.26"

426731/ 426732

GASKET: 895100

16
3-16

FOR ALTMANS

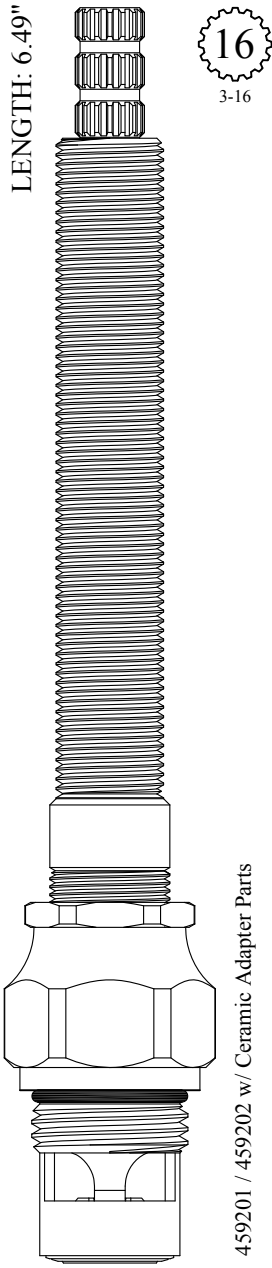

GASKET: 890170 O-RING INCLUDED
SEAL: 898510-W
DISC SET: 151380-PKG

426841
426842

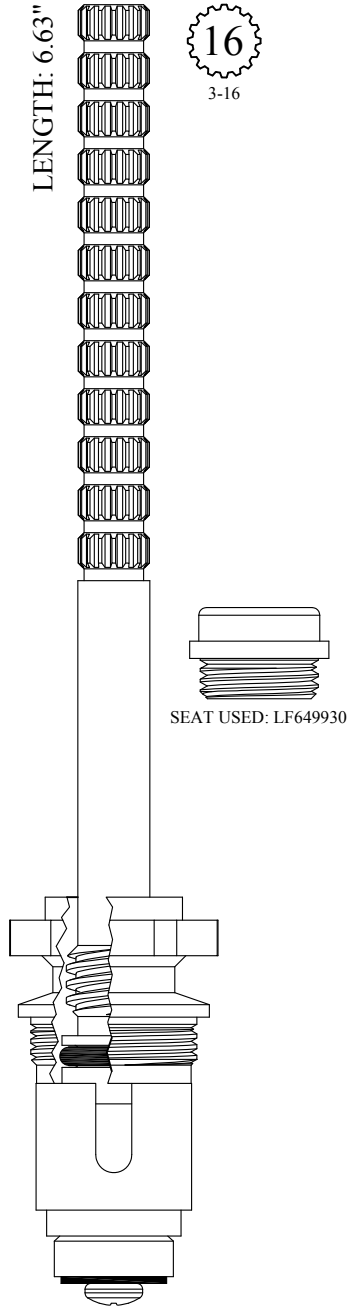

GASKET: 895180

439181

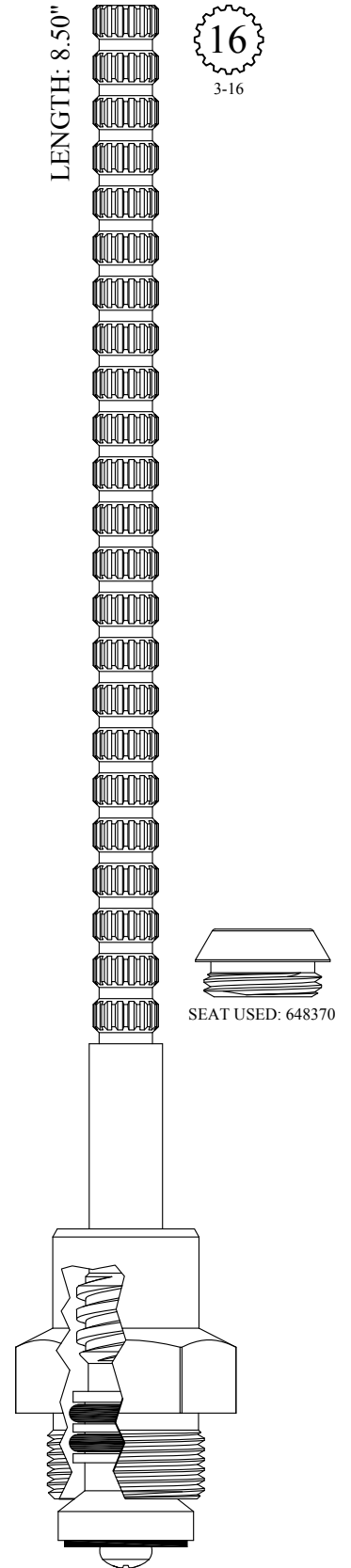

GASKET: 895390

428271
428272

FOR ALTMANS

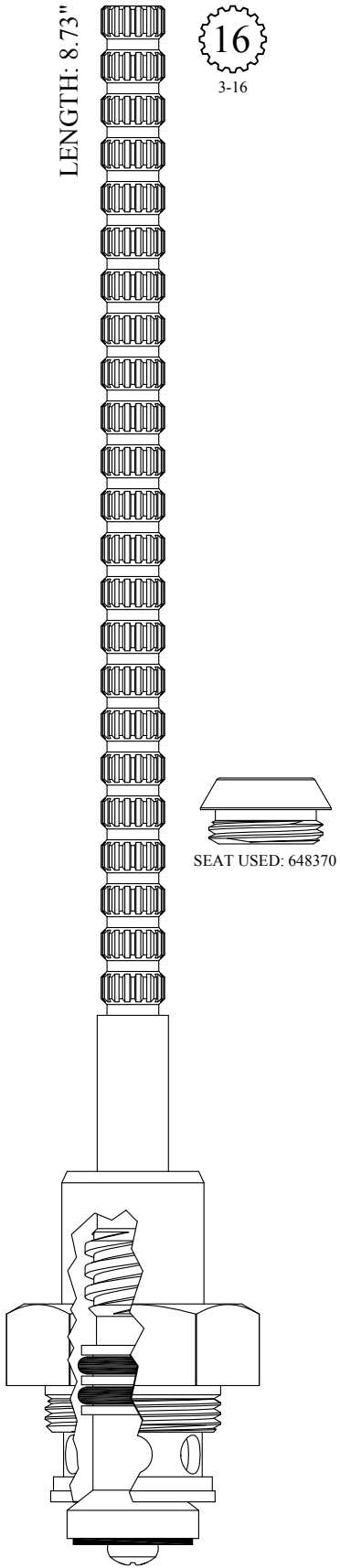

GASKET: 895550

439771

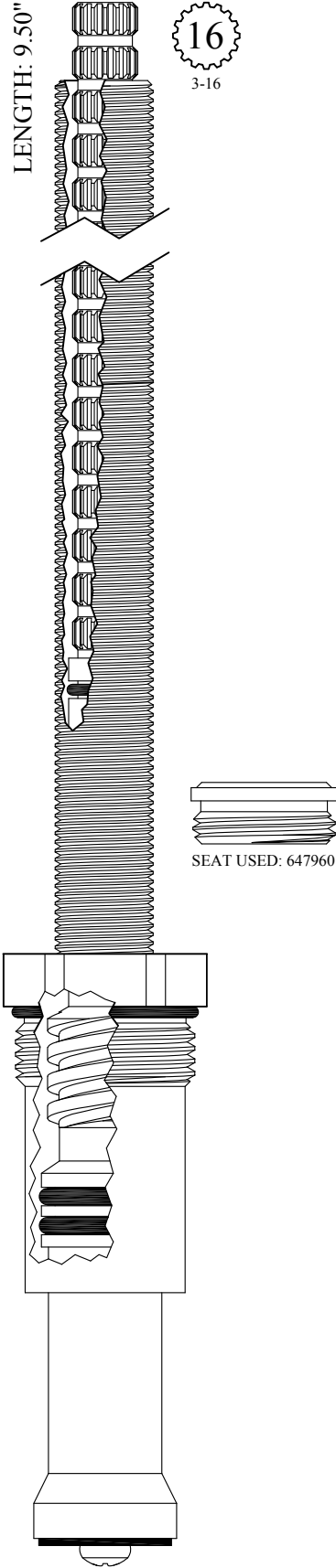

GASKET: 890210 O-RING INCLUDED

428451
428452

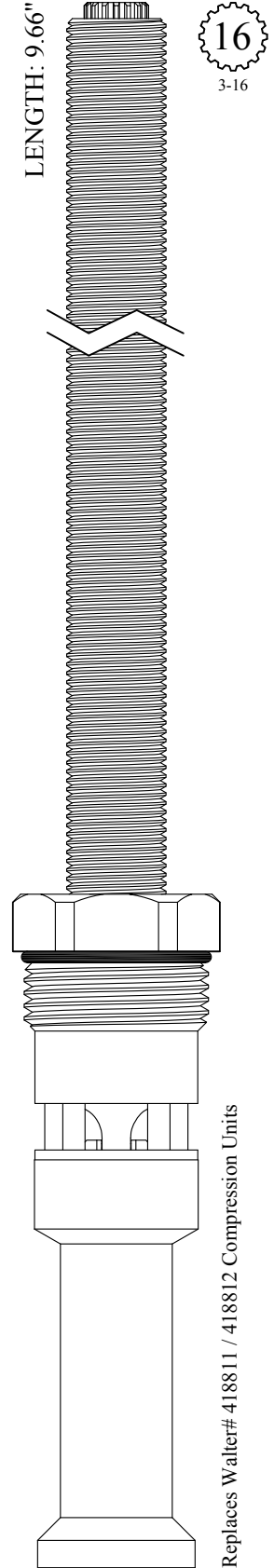

GASKET: 890210 O-RING INCLUDED
SEAL: 898510
DISC SET: 151380-PKG

428461
428462

Replaces Walter# 418811 / 418812 Compression Units

FOR AMERICAN BRASS

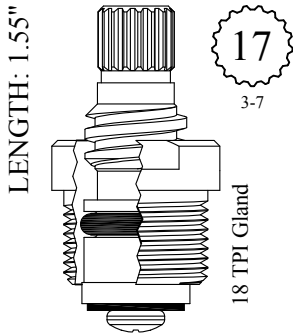

GASKET: 895100

LF451111
LF451112

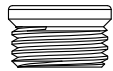

SEAT USED: LF648410

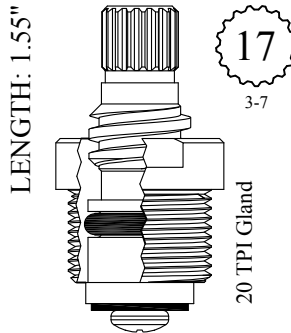

GASKET: 895100

LF451161
LF451162

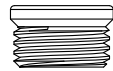

SEAT USED: LF648410

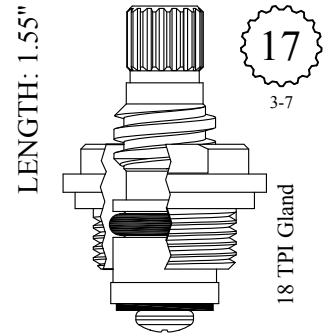

GASKET: 895100

LF452071
LF452072

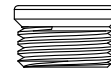

SEAT USED: LF648410

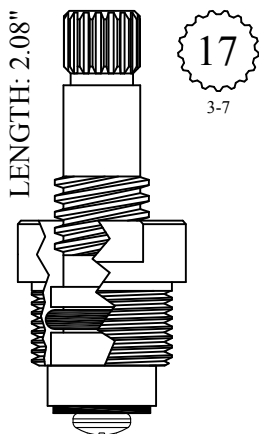

GASKET: 895100

LF458141
LF458142



SEAT USED: LF648410

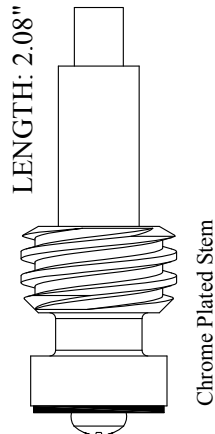

LF260501

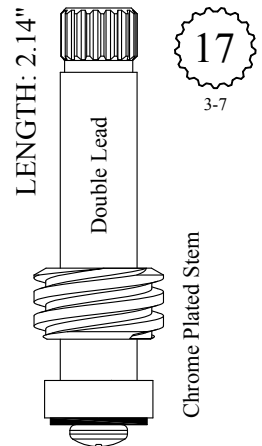

LF260011
LF260012

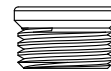

SEAT USED: LF648410

FOR AMERICAN BRASS

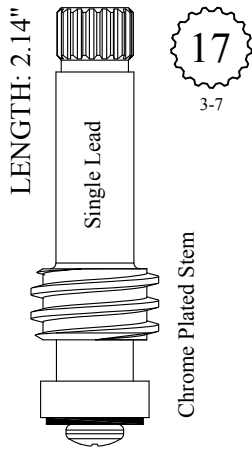

LF260211
LF260212

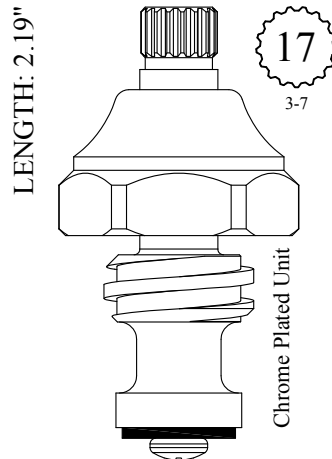

LF460241
LF460242
LF260241 Stem Only
LF260242 Stem Only

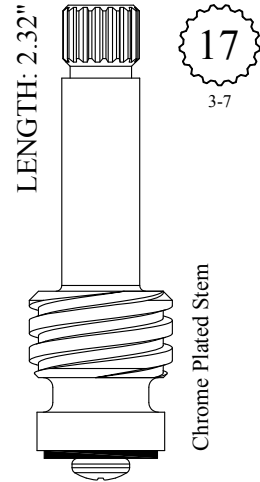

LF262021
LF262022

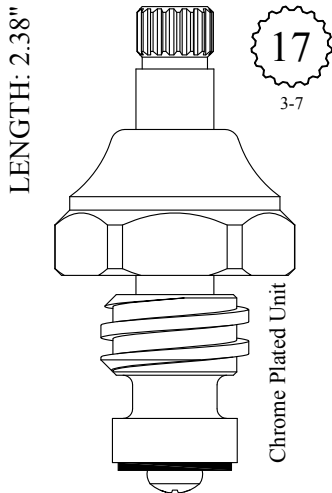
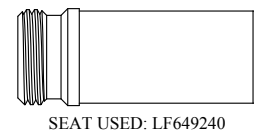

LF464211
LF464212
LF264211 Stem Only
LF264212 Stem Only

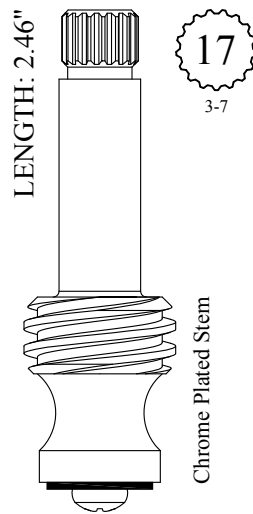

LF264271
LF264272

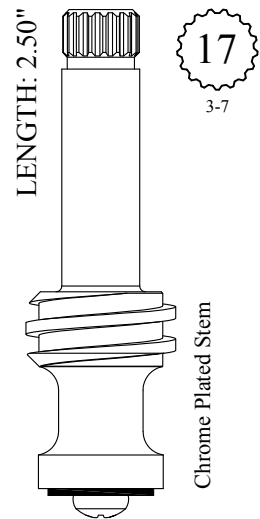

LF264261



FOR AMERICAN BRASS

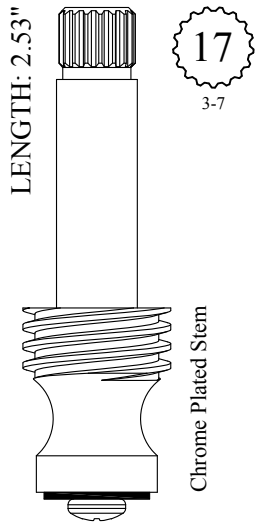

LF264291

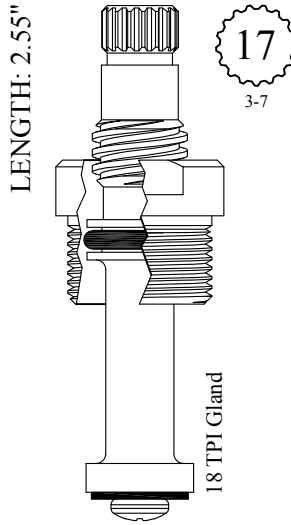

GASKET: 895100

LF463981
LF463982

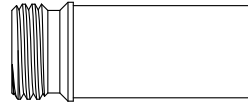

SEAT USED: LF648140

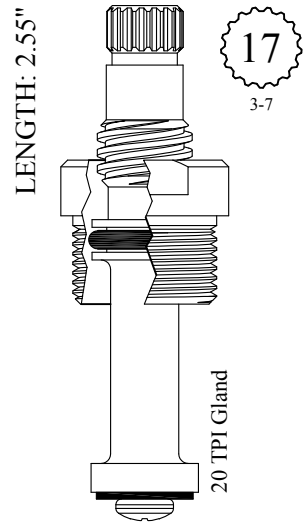

GASKET: 895100

LF464001
LF464002



SEAT USED: LF648140

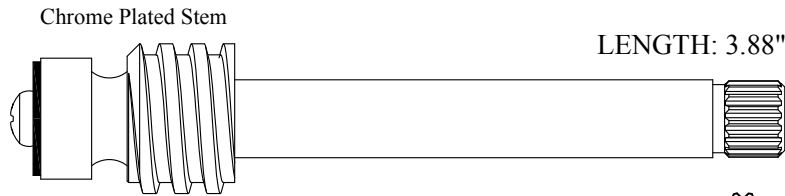

LF269161 / LF269162

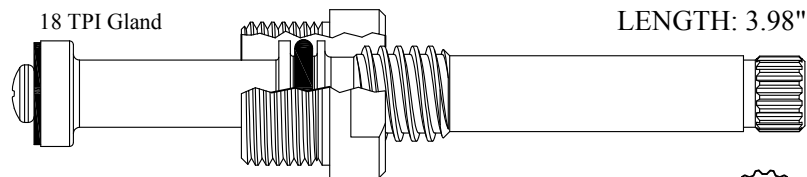

403601 / 403602

GASKET: 895100

FOR AMERICAN BRASS

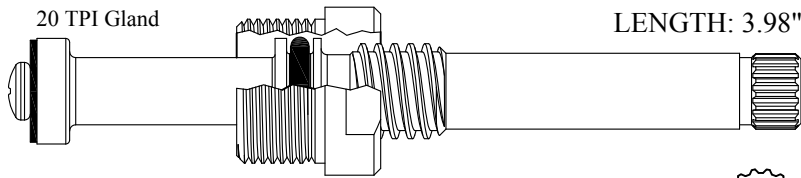

403611/ 403612
GASKET: 895100

17
3-7

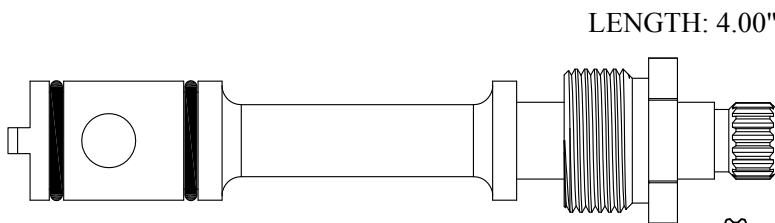
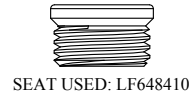

430350
230350 Stem Only

17
3-7

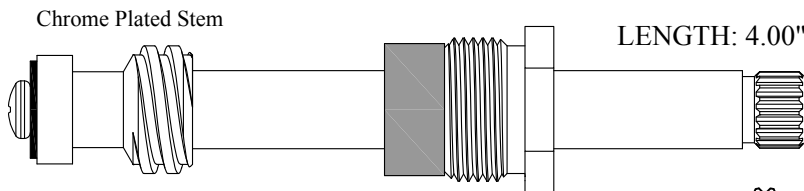

LF470021/ LF470022
LF270021/ LF270022 Stem Only

17
3-7

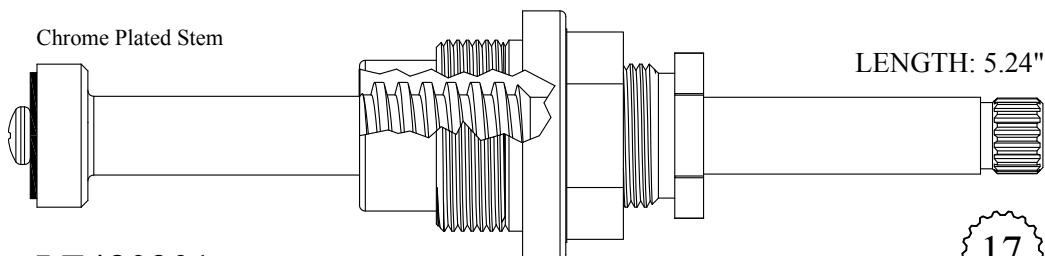
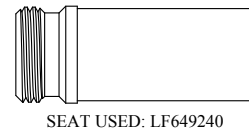

LF480201
LF280201 Stem Only
GASKET: 895550

17
3-7

FOR AMERICAN BRASS

Chrome Plated Stem

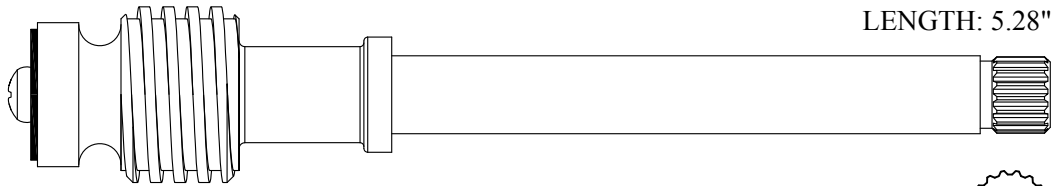

LENGTH: 5.28"

214761



Chrome Plated Stem

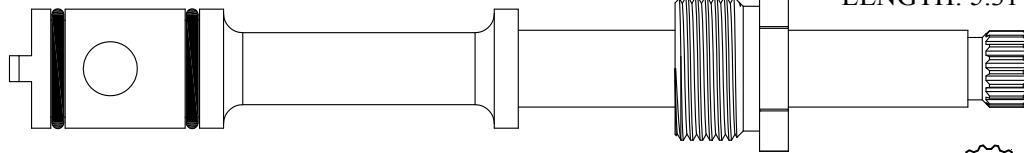

LENGTH: 5.31"

432800
232800 Stem Only



Chrome Plated Stem

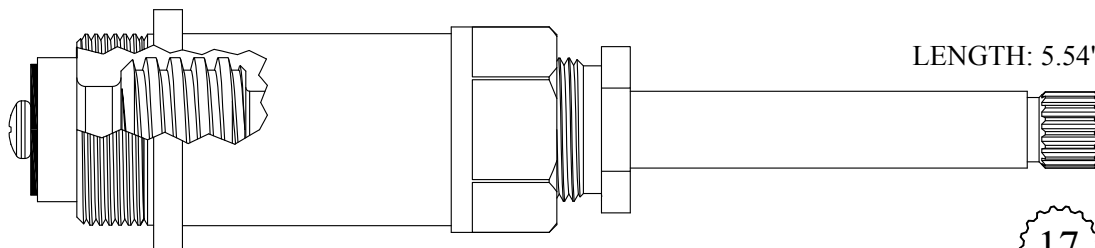

LENGTH: 5.54"

421201
221201 Stem Only
GASKET: 895550

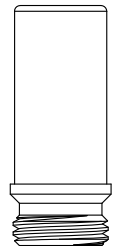

SEAT USED: LF648140

FOR AMERICAN BRASS

Chrome Plated Stem

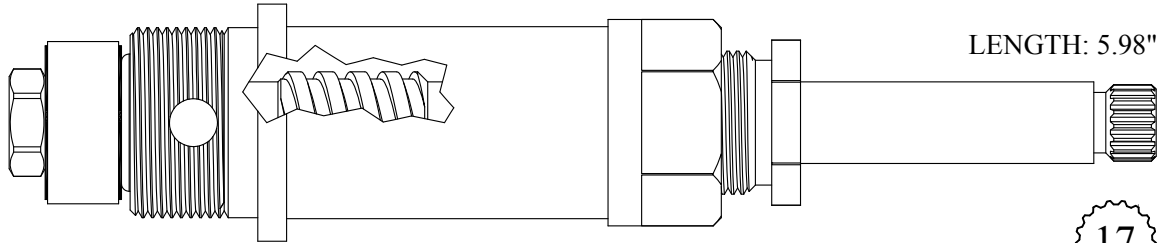

438701
238701 Stem Only
GASKET: 895550

17
3-7

Chrome Plated Stem

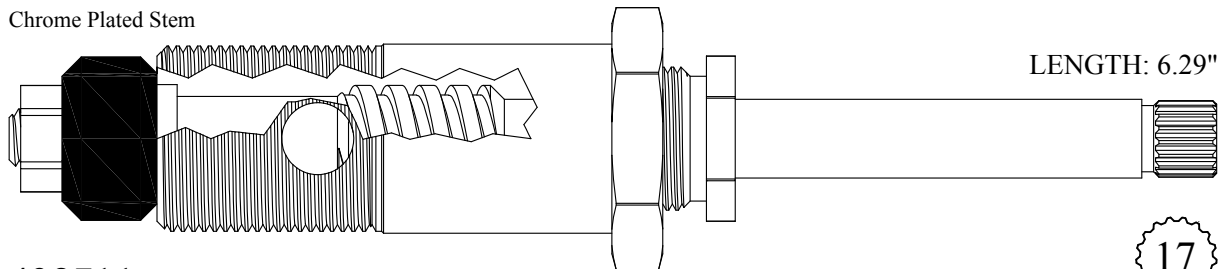

438711
238711 Stem Only
GASKET: 895550

17
3-7

Send Your Orders To:

BARRY E.  SR. CO.

E-mail: orderdesk@barrywalter.com

Fax: 1.800.886.9831

Phone: 1.800.767.5552

FOR AMERICAN KITCHEN

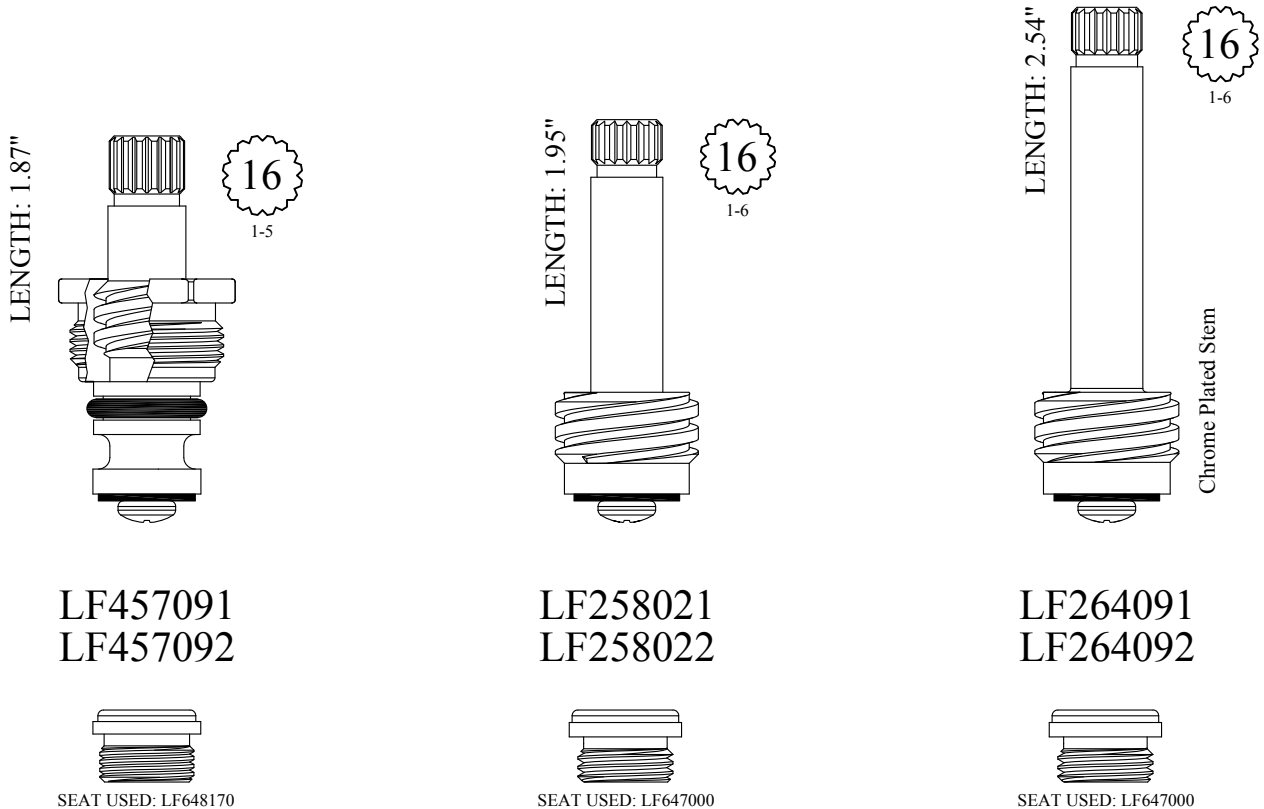

Send Your Orders To:

BARRY E.  SR. CO.

E-mail: orderdesk@barrywalter.com

Fax: 1.800.886.9831

Phone: 1.800.767.5552

FOR AMERICAN STANDARD

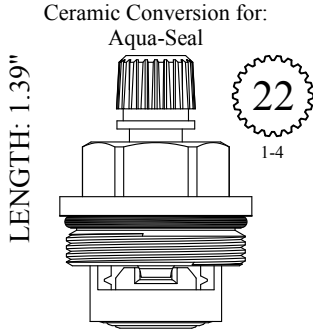

GASKET: 890180 O-RING INCLUDED
SEAL: 898500
DISC SET: 112530-PKG

LF450931
LF450932

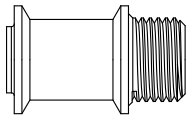

SEAT INCLUDED: LF646950

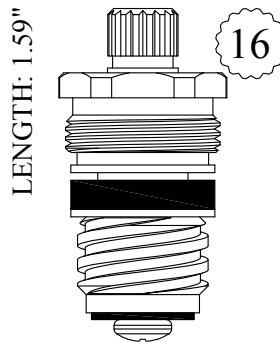

LF452011
LF452012
LF252081 Stem Only
LF252082 Stem Only



SEAT USED: LF648350

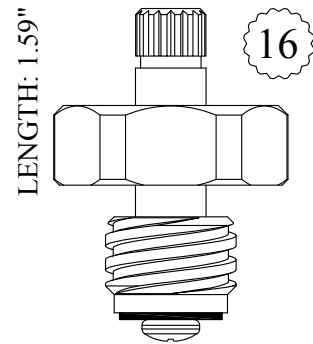

LF452081
LF452082
LF252081 Stem Only
LF252082 Stem Only



SEAT USED: LF648350

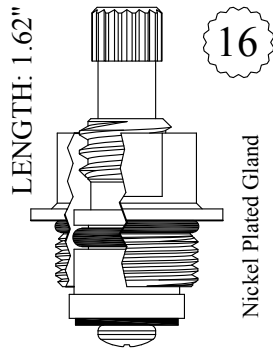

GASKET: 890160 O-RING INCLUDED

LF453041
LF453042



SEAT USED: LF648350

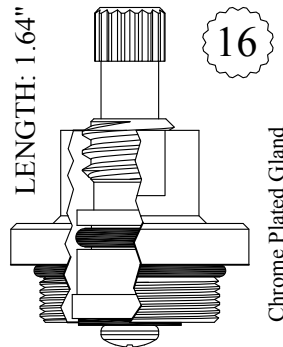

GASKET: 890200 O-RING INCLUDED

LF453141

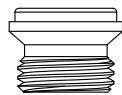

SEAT USED: LF648350

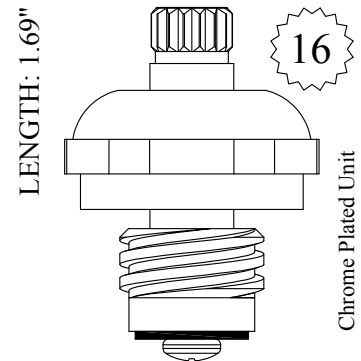

LF454011
LF454012
LF254011 Stem Only
LF254012 Stem Only

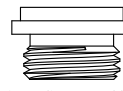

SEAT USED: LF648100

FOR AMERICAN STANDARD

Also available with locknut:
LF453091-N / LF453092-N

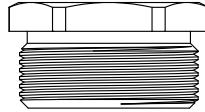

Locknut only:
653020

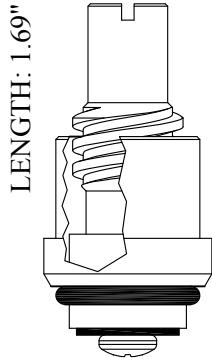

GASKET: 891130

453181
253181 Stem Only

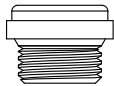

SEAT USED: LF648990

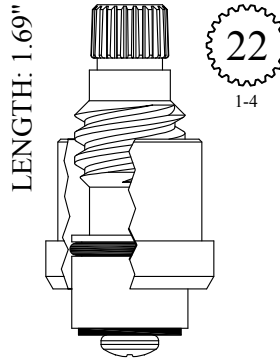

GASKET: 891130

LF453091
LF453092

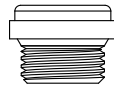

SEAT USED: LF648990

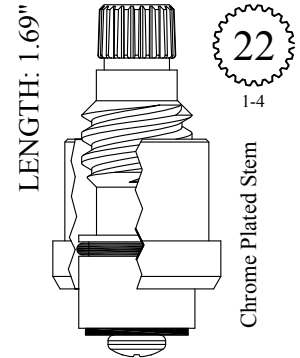

GASKET: 891130

LF453101
LF453102

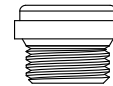

SEAT USED: LF648990

Also available with
stainless steel knurled ring:
LF453021-SS / LF453022-SS
Also available with locknut:
LF453021-N / LF453022-N

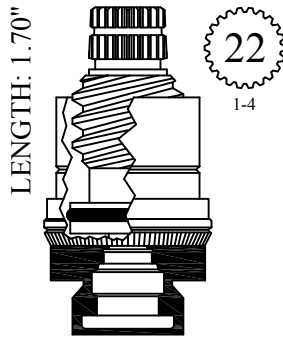
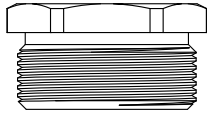

LF453021
LF453022



SEAT USED: LF648990

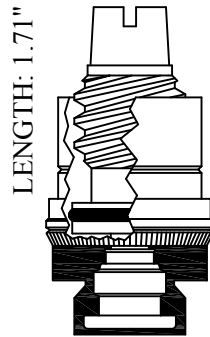

453191

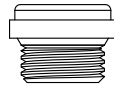

SEAT USED: LF648990

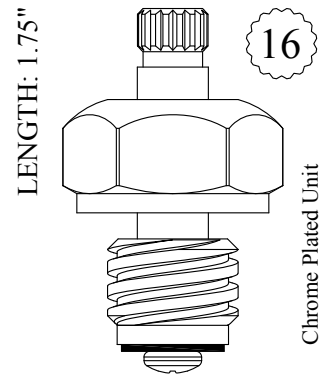

LF455081
LF455082
LF255081 Stem Only
LF255082 Stem Only

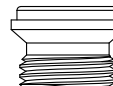

SEAT USED: LF648350

FOR AMERICAN STANDARD

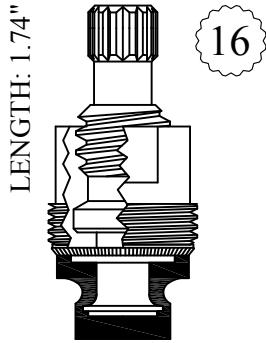

LF453001
LF453002



SEAT USED: LF647910 or LF649650

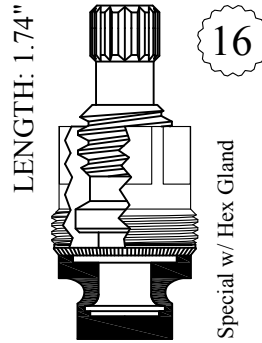

SEAT: LF647910
OR LF649650

452991



SEAT USED: LF647910 or LF649650

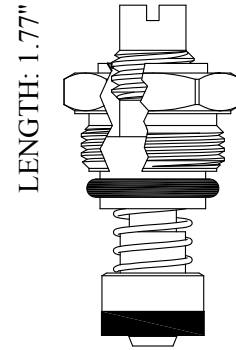

400171

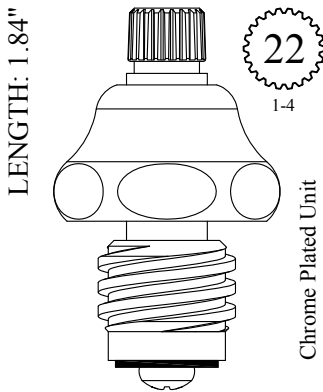

LF456021
LF456022
LF256021 Stem Only
LF256022 Stem Only



SEAT USED: LF648220

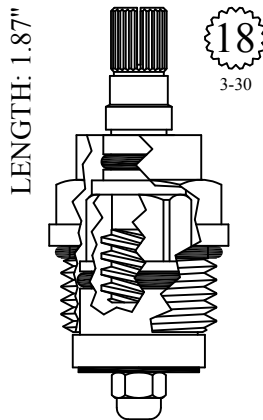

GASKET: 890180 O-RING INCLUDED

LF456302

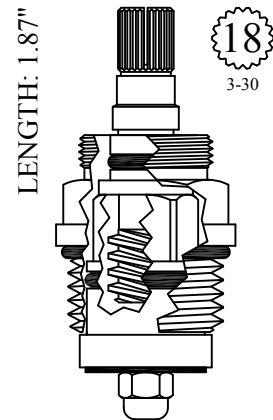

GASKET: 890180 O-RING INCLUDED

LF456312

FOR AMERICAN STANDARD

LENGTH: 1.91"

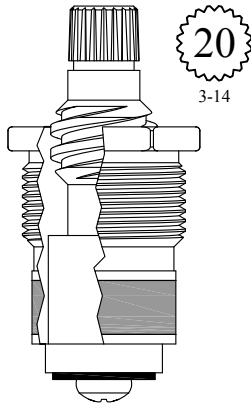

LF457101
 LF457102
 LF257101 Stem Only
 LF257102 Stem Only

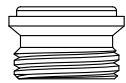

SEAT USED: LF648220

LENGTH: 1.95"

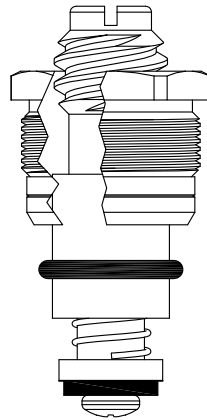

400591
 200591 Stem Only

LENGTH: 1.96"

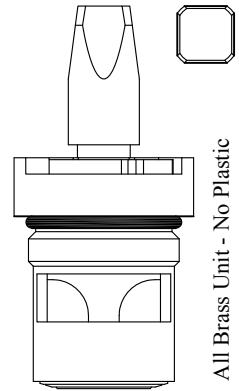

GASKET: 890170 O-RING INCLUDED
 SEAL: 898510-W
 DISC SET: 151380-PKG

All Brass Unit - No Plastic

LF458901
 LF458902

LENGTH: 1.96"

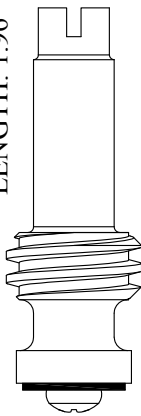

257351

LENGTH: 2.11"

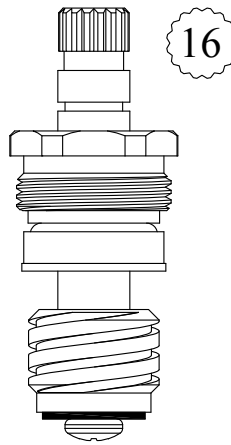

LF459121
 LF459122
 LF259121 Stem Only
 LF259122 Stem Only

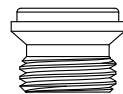

SEAT USED: LF648350

LENGTH: 2.12"

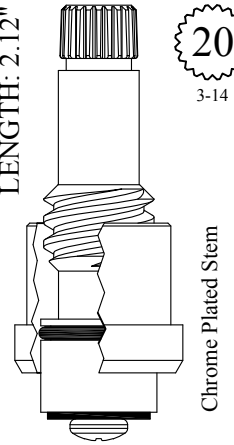

Chrome Plated Stem

GASKET: 891130

LF460121

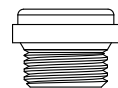

SEAT USED: LF648990

FOR AMERICAN STANDARD

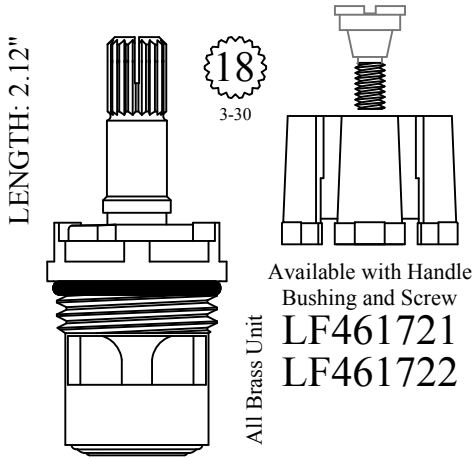

Available with Handle
Bushing and Screw
LF461721
LF461722

All Brass Unit

GASKET: 890170 O-RING INCLUDED
SEAL: 898510-W
DISC SET: 151380-PKG

LF461701
LF461702

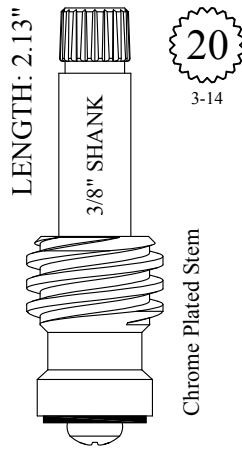

20
3-14

Chrome Plated Stem

LF260031
LF260032

USES BARREL:
LF647021/LF647022

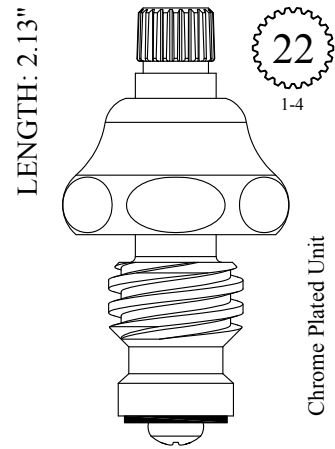

22
1-4

Chrome Plated Unit

LF460021
LF460022
LF260021 Stem Only
LF260022 Stem Only

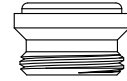

SEAT USED: LF648360

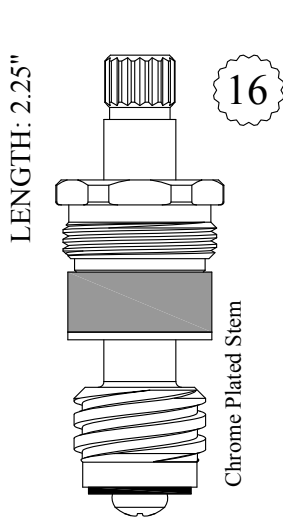

16

Chrome Plated Stem

LF461091
LF461092
LF261091 Stem Only
LF261092 Stem Only



SEAT USED: LF648350

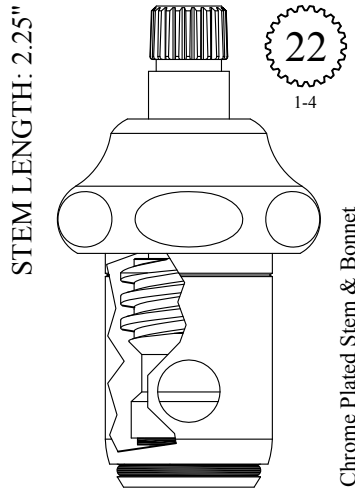

22
1-4

Chrome Plated Stem & Bonnet

GASKET: 861020 INCLUDED

LF461021
LF461022
LF261021 Stem Only
LF261022 Stem Only

USES BARREL:
LF647021/LF647022

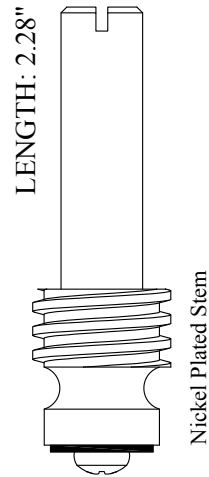

LENGTH: 2.28"

Nickel Plated Stem

261131

Send Your Orders To:

BARRY E.  SR. CO.

E-mail: orderdesk@barrywalter.com

Fax: 1.800.886.9831

Phone: 1.800.767.5552

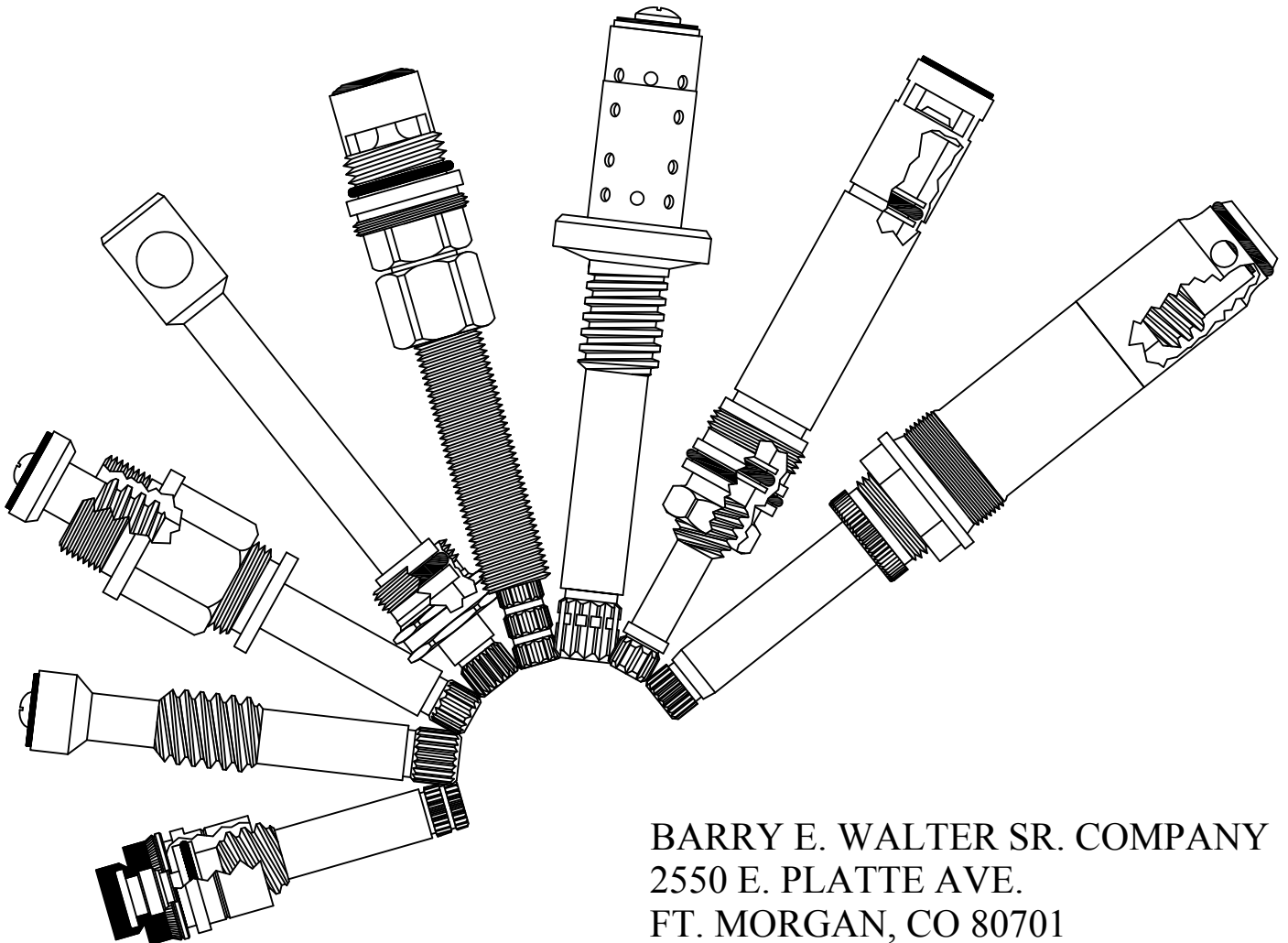

BARRY E. WALTER SR. COMPANY
2550 E. PLATTE AVE.
FT. MORGAN, CO 80701

*We are always adding
new parts. Check our
website for updates.*

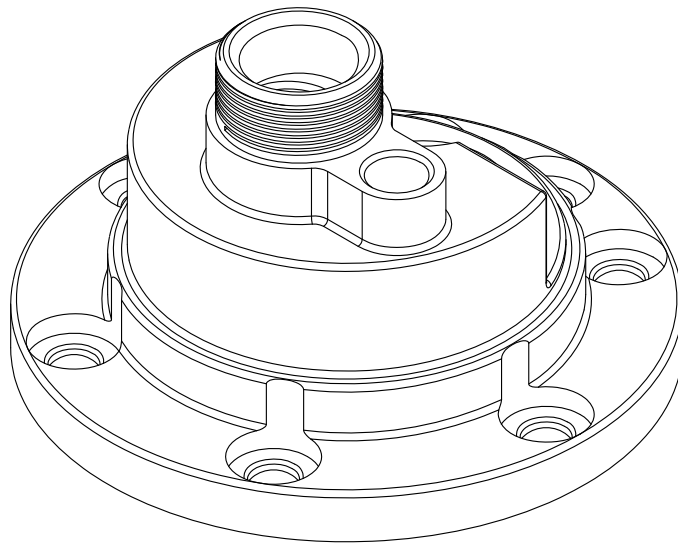

FOR SPEAKMAN G06-0021

BARRY E.  ALTER  SR. CO.

FOR AMERICAN STANDARD

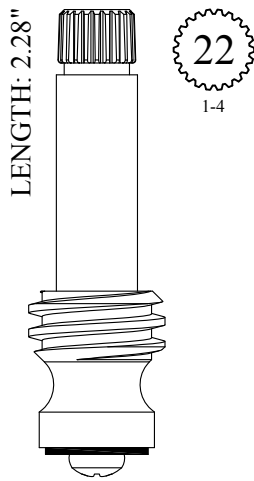

263281

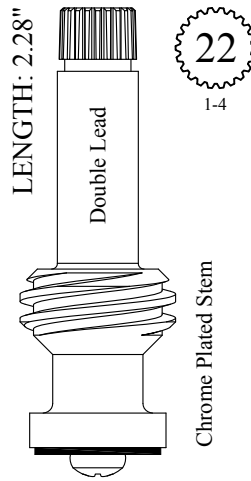

LF263231
LF263232

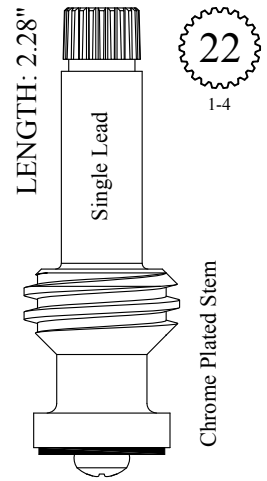

LF263241

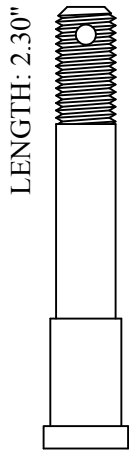

LF261120

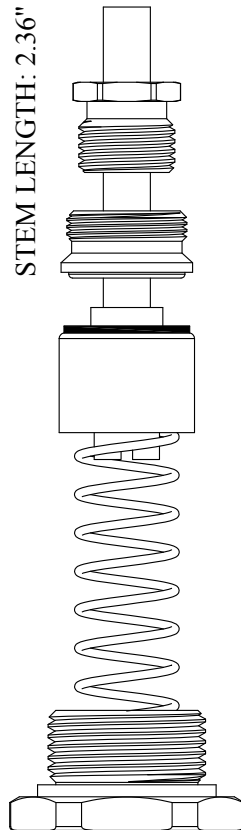

SEAT INCLUDED: LF649870

LF152150 Stem Only
LF124660 Repair Kit

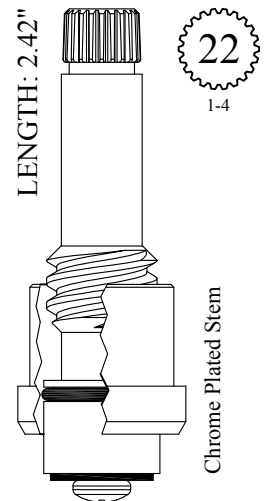

GASKET: 891130

LF464011
LF464012
LF264011 Stem Only
LF264012 Stem Only



SEAT USED: LF648990

FOR AMERICAN STANDARD

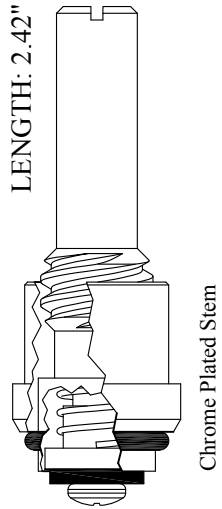

Chrome Plated Stem

464221
264221 Stem Only

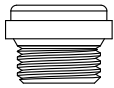

SEAT USED: LF648990

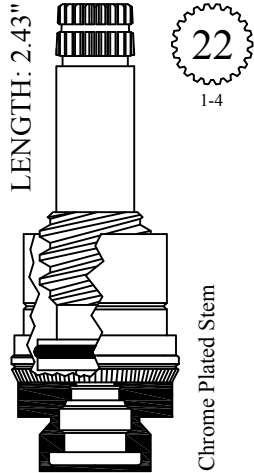

Chrome Plated Stem

LF463131
LF463132

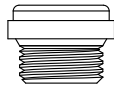

SEAT USED: LF648990

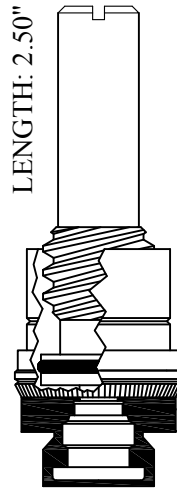

Chrome Plated Stem

401551

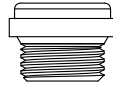

SEAT USED: LF648990

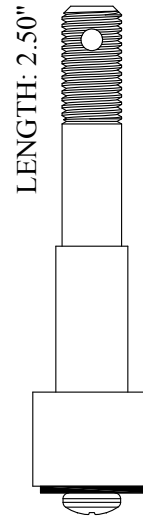

LF264300

Chrome Plated
Escutcheon Holder
also available:
Part #: 901550

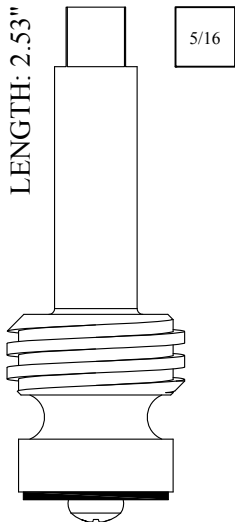

264851

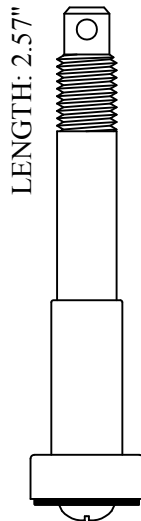

LF264250

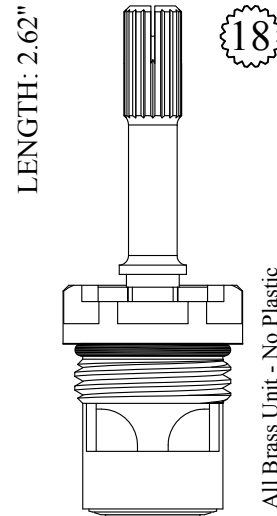

All Brass Unit - No Plastic

GASKET: 890170 O-RING INCLUDED
SEAL: 898510-W
DISC SET: 151380-PKG

401501
401502

FOR AMERICAN STANDARD

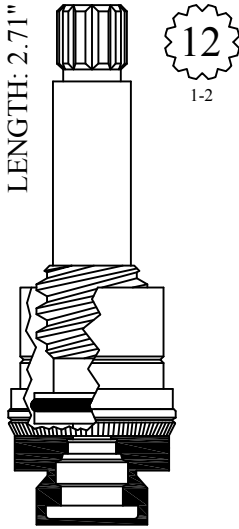

LF464901
LF464902

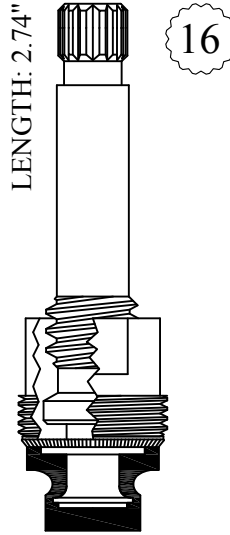

401631
401632

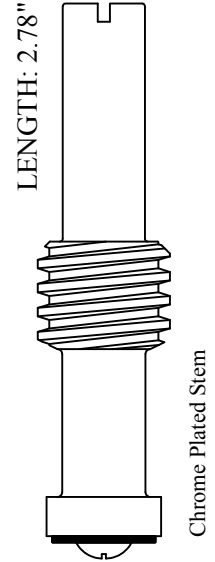
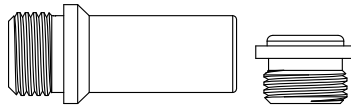

201711

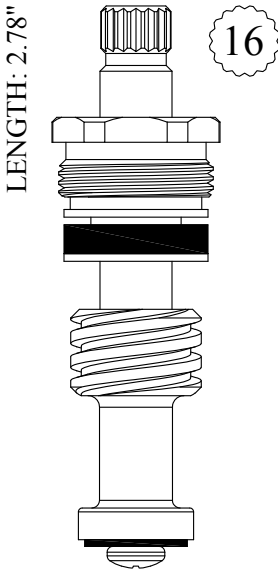

LF465101
LF465102
LF265101
LF265102

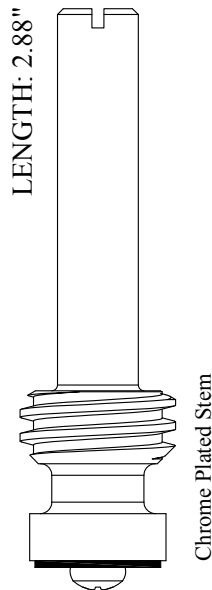

265611

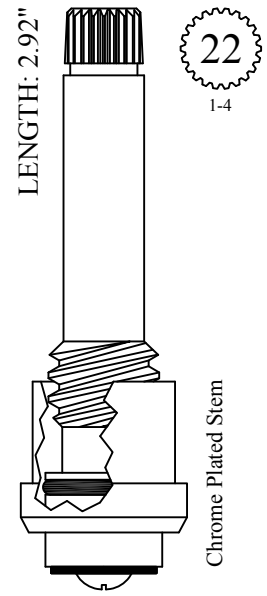

GASKET: 891130
LF466041
LF466042



FOR AMERICAN STANDARD

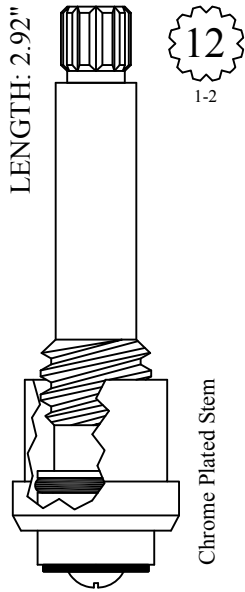

GASKET: 891130

LF466141
LF466142

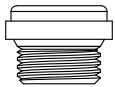

SEAT USED: LF648990

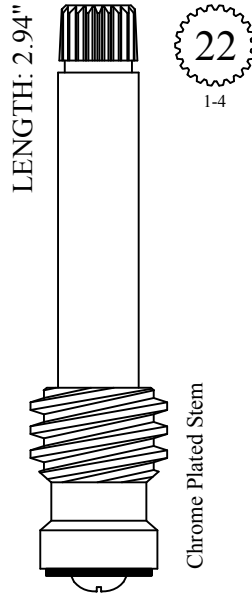

LF266171
LF266172

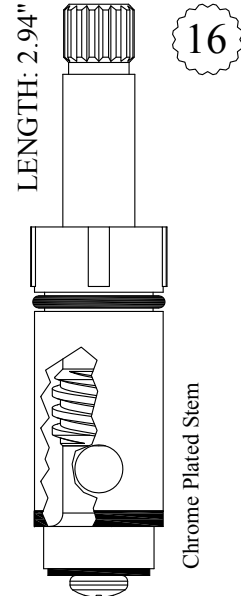

430442

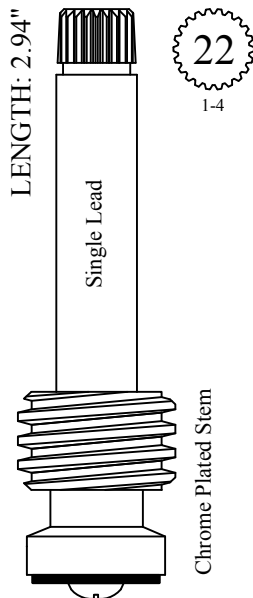

LF266031
USES BARREL:
LF647031

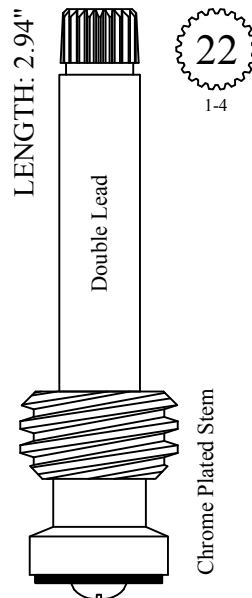

LF266151
LF266152
USES BARREL:
LF647041/LF647042

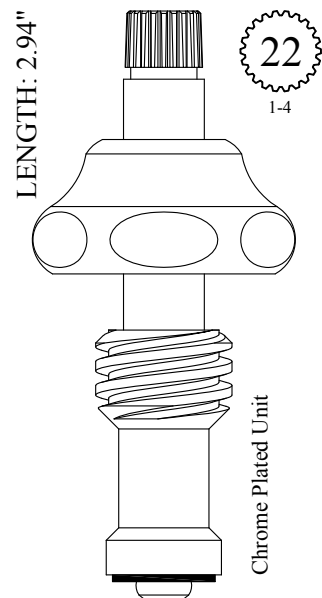

LF466081
LF266081 Stem Only

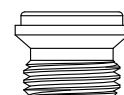

SEAT USED: LF648350

FOR AMERICAN STANDARD

Also available with locknut:
LF466011-N / LF466012-N

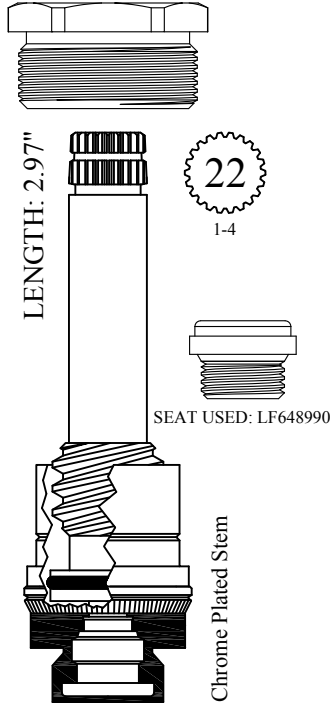

LF466011
LF466012

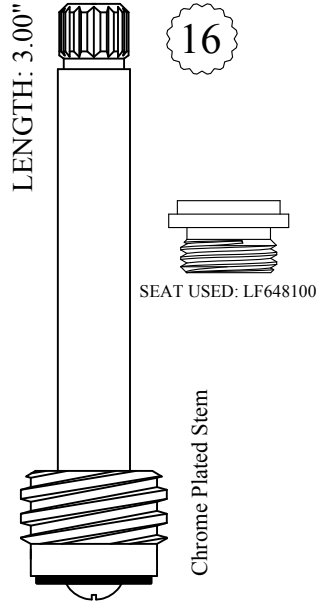

LF266071
LF266072

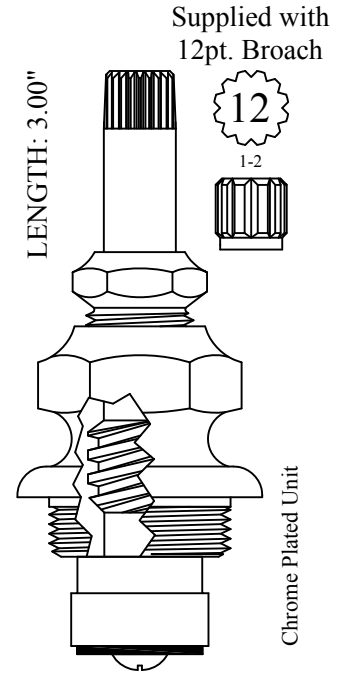

LF466301

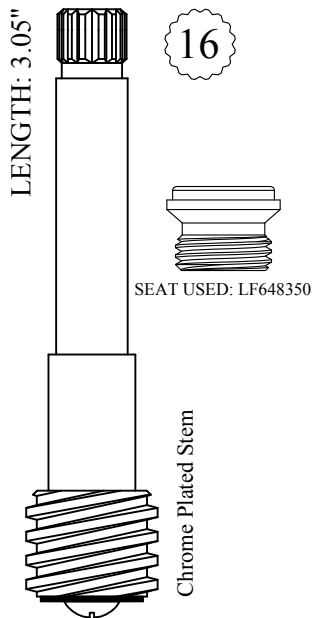

LF267021
LF267022

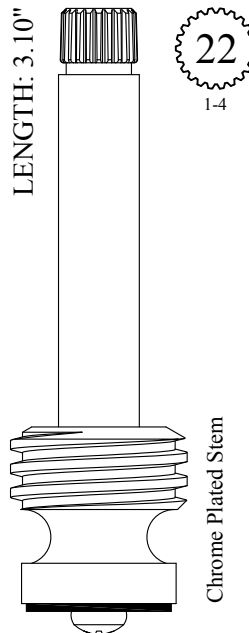

LF266381
LF266382

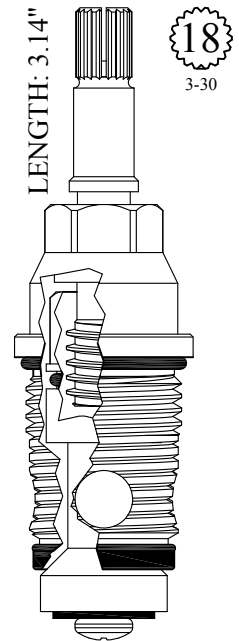

GASKET: 890170 O-RING INCLUDED

430022

FOR AMERICAN STANDARD

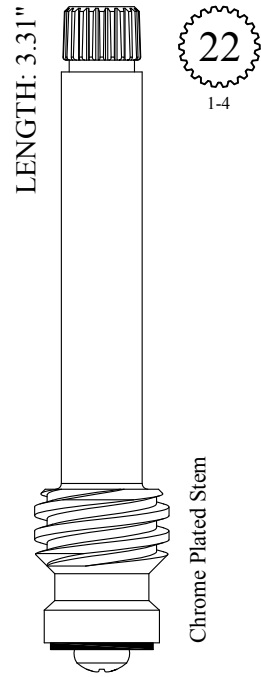
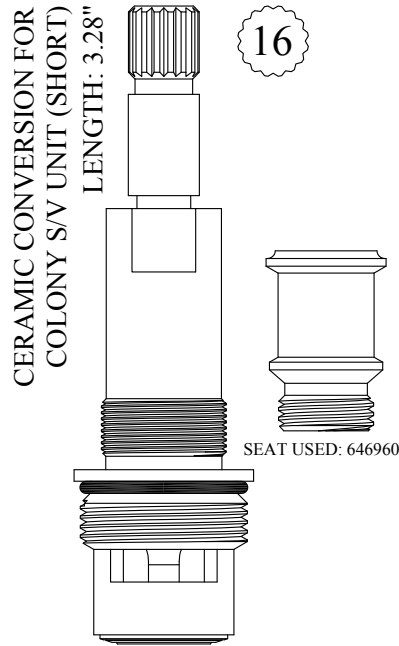
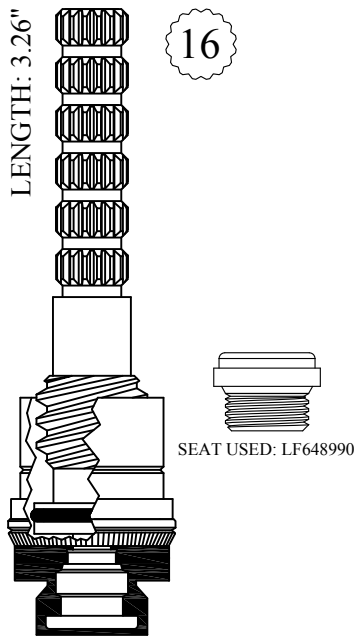

GASKET: 890180 O-RING INCLUDED
SEAL: 898510
DISC SET: 151380-PKG

402321
402322
202321 Stem Only
202322 Stem Only

402441

LF268041
LF268042

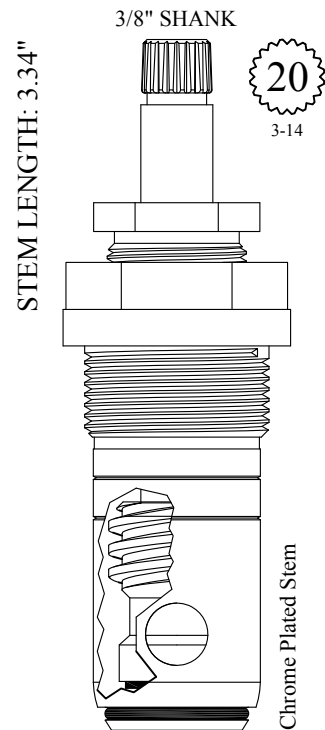
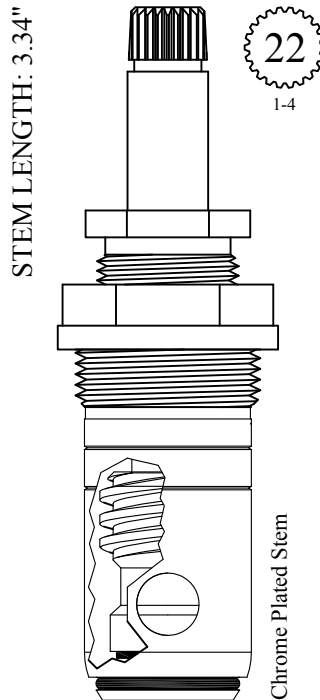
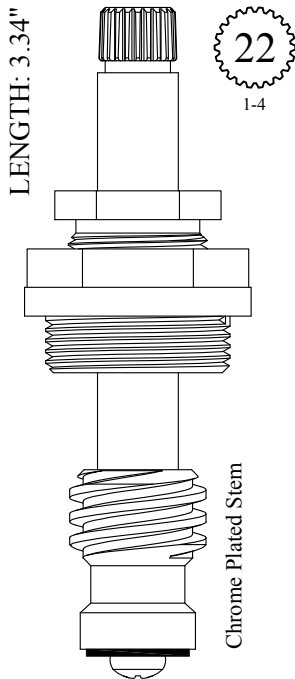

GASKET: 818010

GASKET: 818010

GASKET: 818010

LF468261
LF468262
LF268061 Stem Only
LF268062 Stem Only

LF468061
LF468062
LF268061 Stem Only
LF268062 Stem Only

LF468701
LF468702
LF268701 Stem Only
LF268702 Stem Only

USES BARREL:
LF647021/LF647022

USES BARREL:
LF647021/LF647022

FOR AMERICAN STANDARD

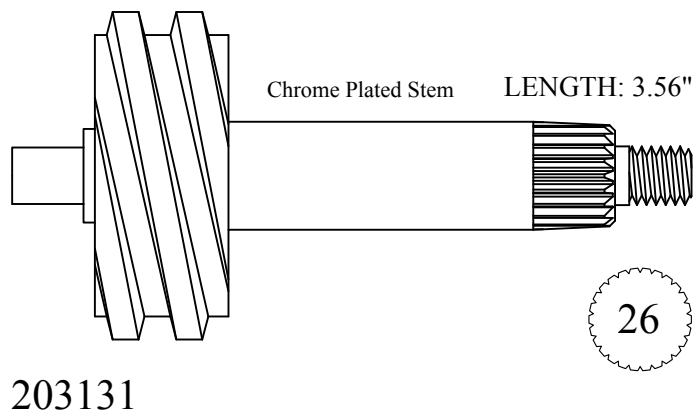
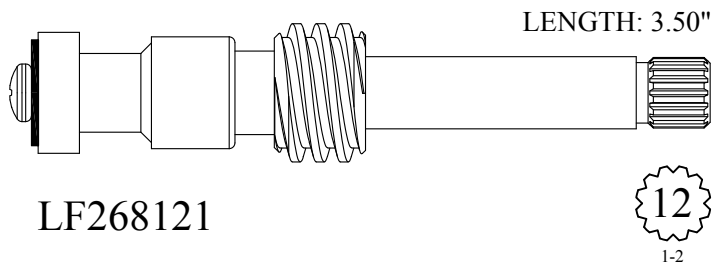
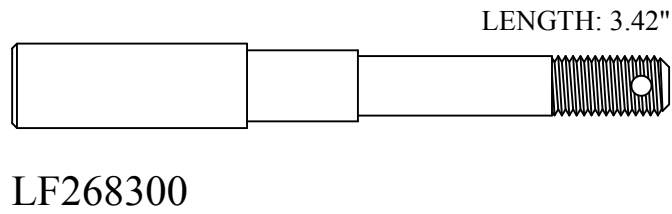
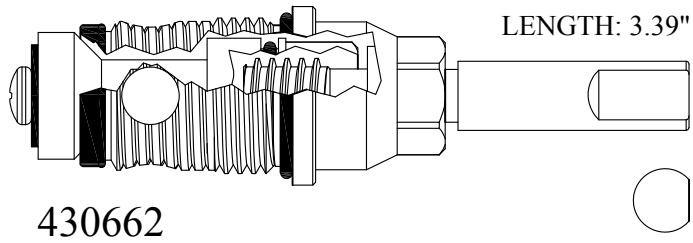

FOR AMERICAN STANDARD

STEM LENGTH: 3.56"

Chrome Plated Stem

USES BARREL:
LF647021/LF647022

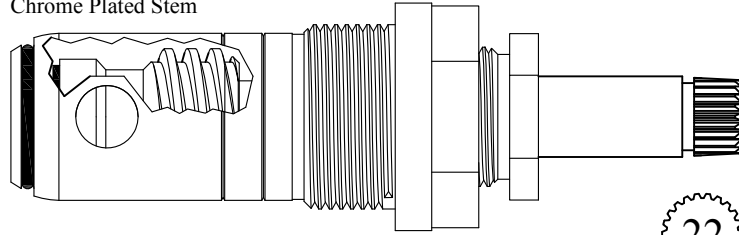

LF468081/ LF468082
LF268081/ LF268082 Stem Only
GASKET: 818010

22
1-4

LENGTH: 3.57"

Chrome Plated Unit

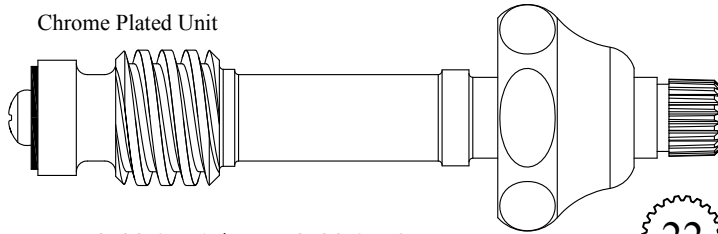

LF468071/ LF468072
LF268071/ LF268072 Stem Only

22
1-4

LENGTH: 3.59"

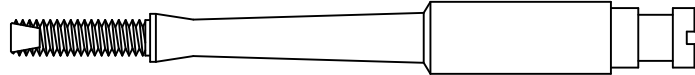

LF268310

LENGTH: 3.60"

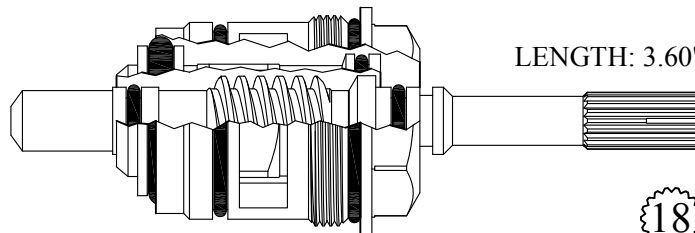

431681
GASKET: 890210 O-RING INCLUDED

18
3-30

FOR AMERICAN STANDARD

STEM LENGTH: 3.81"

Chrome Plated Stem

USES BARREL:
LF647021/LF647022

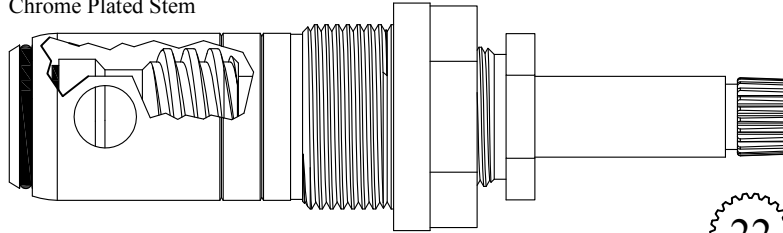

22
1-4

LF472011/ LF472012
LF272011/ LF272012 Stem Only
GASKET: 818010

Chrome Plated Stem

LENGTH: 3.79"

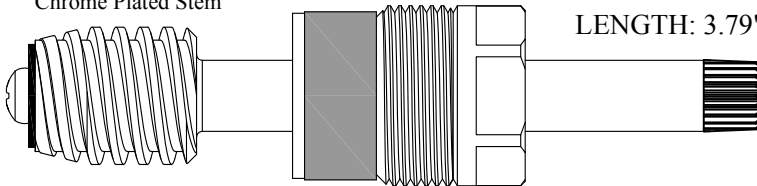

403251
203251 Stem Only

Supplied with
12pt. Broach

12
1-2

LENGTH: 3.83"

Chrome Plated Stem



SEAT USED: LF648350

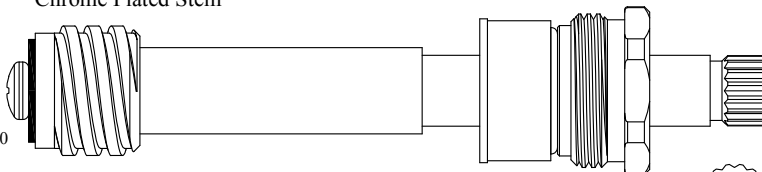

16

LF469071/ LF469072
LF269071/ LF269072 Stem Only

LENGTH: 3.87"

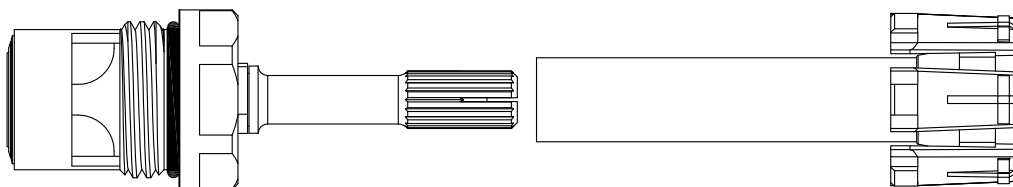

406101
GASKET: 890170 O-RING INCLUDED
SEAL: 898510-W
DISC SET: 151380-PKG

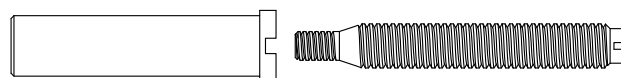

FOR AMERICAN STANDARD

CERAMIC CONVERSION FOR AM STD COLONY (LONG)

LENGTH: 3.90"

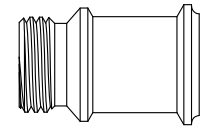

SEAT INCLUDED: 646960

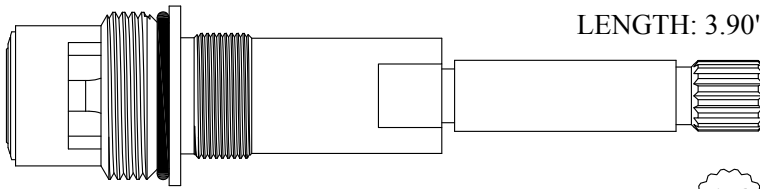

16

403481

GASKET: 890180 O-RING INCLUDED

SEAL: 898510-W

DISC SET: 151380-PKG

LENGTH: 3.92"

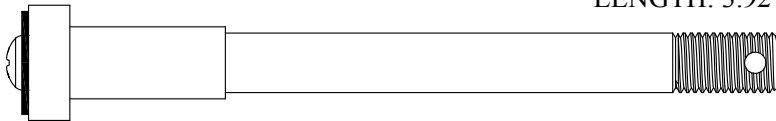

LF270030

STEM LENGTH: 4.00"

Chrome Plated Stem

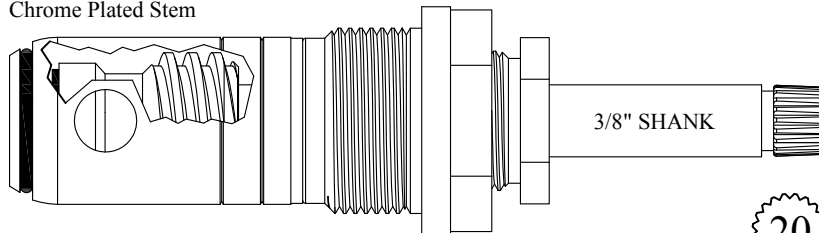

3/8" SHANK

USES BARREL:
LF647021/LF647022

20
3-14

LF470201/ LF470202

LF270201/ LF270202 Stem Only

GASKET: 818010

Chrome Plated Stem

LENGTH: 4.07"

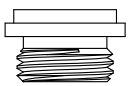

SEAT USED: LF648100

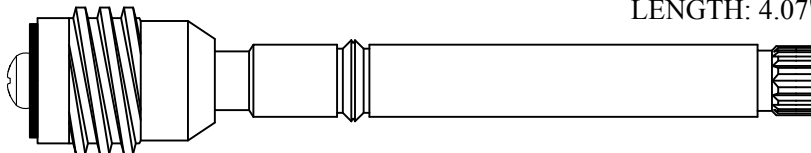

16

LF271021/ LF271022

FOR AMERICAN STANDARD

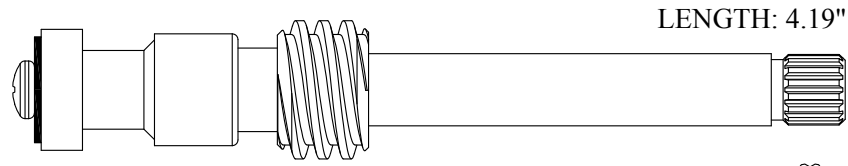

LF269901

16

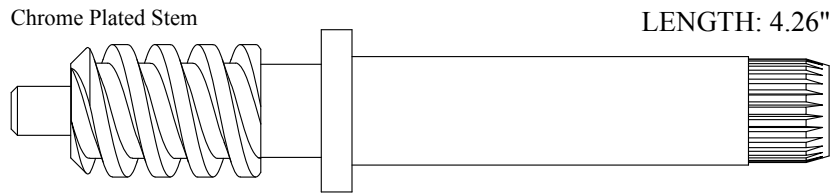

205731

26

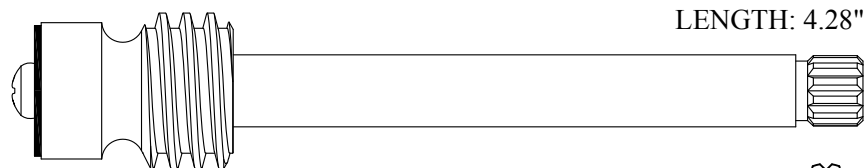

205661

12

1-2

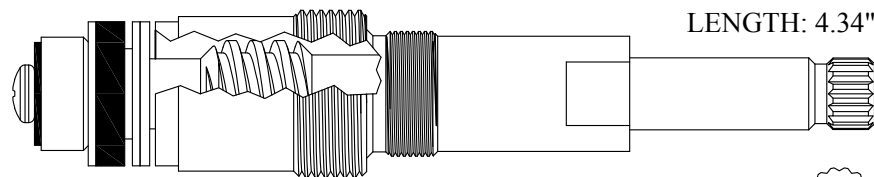

405701/ 405702

WAVE WASHER: 897110

16

FOR AMERICAN STANDARD

Chrome Plated Stem

LENGTH: 4.38"

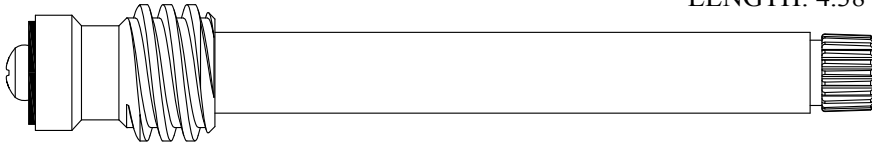

LF272071/ LF272072

22
1-4

Chrome Plated Stem

LENGTH: 4.44"



SEAT USED: LF648100

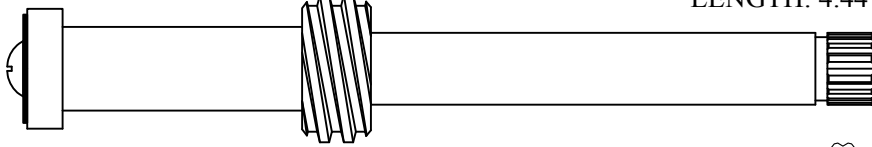

LF274041/ LF274042

16

LENGTH: 4.44"



SEAT USED: LF648220

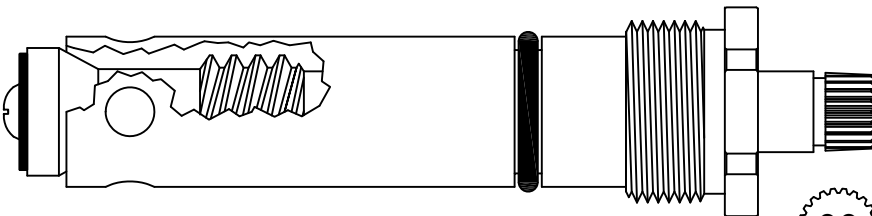

430602
230602 Stem Only

22
1-4

LENGTH: 4.48"

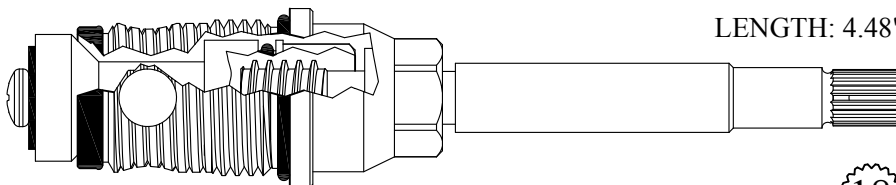

430692
GASKET: 890170

18
3-30

FOR AMERICAN STANDARD

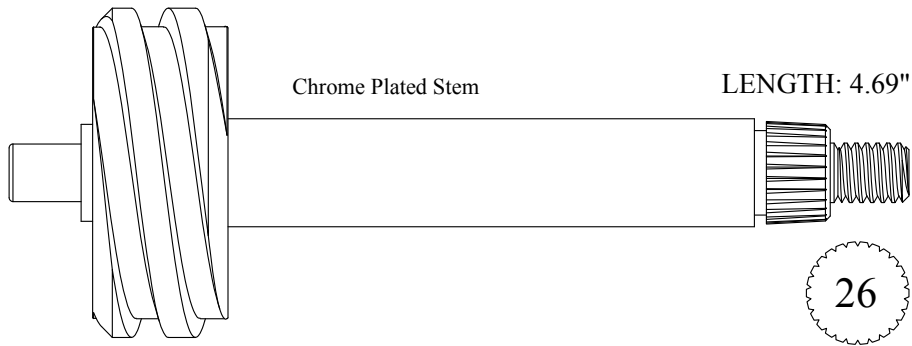

208811

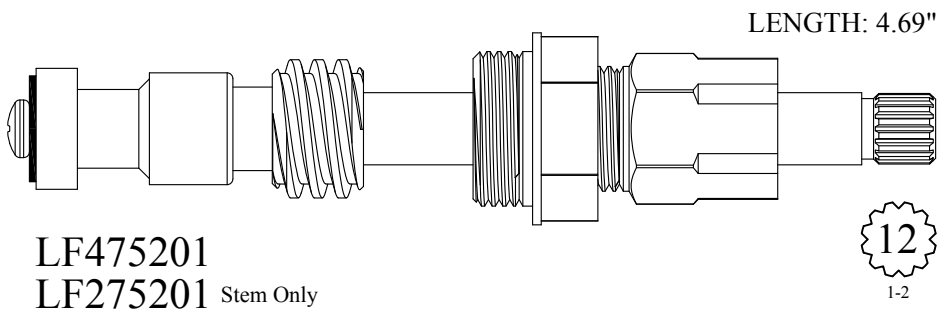

LF475201
LF275201 Stem Only

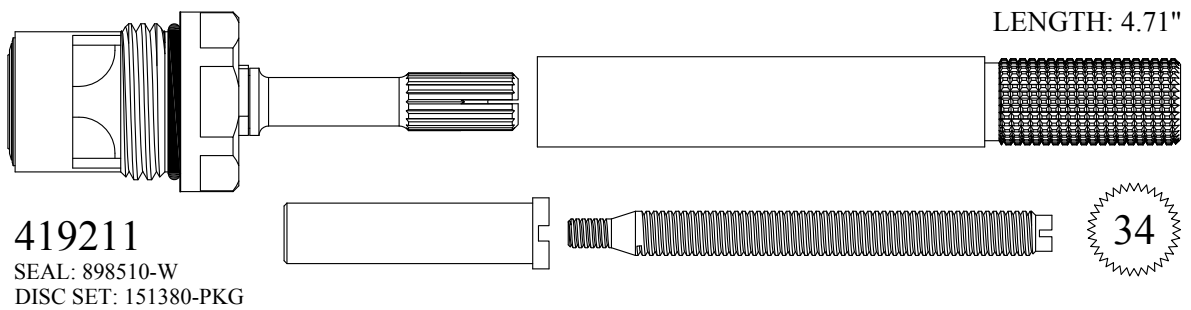

419211
SEAL: 898510-W
DISC SET: 151380-PKG

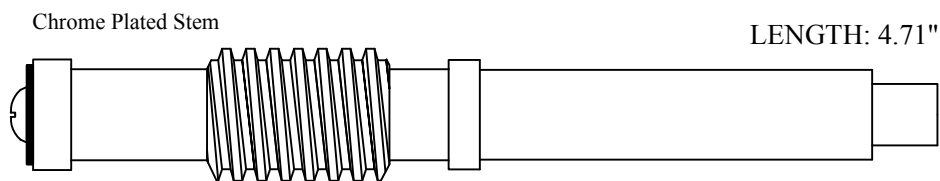

208951

Supplied with
12pt. Broach

12
1-2

FOR AMERICAN STANDARD

Chrome Plated Stem

STEM LENGTH: 4.81"

USES BARREL:
LF647021/LF647022

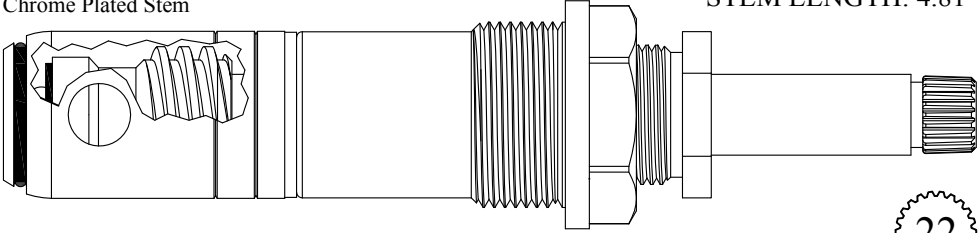

LF476031/ LF476032
LF276031/ LF276032 Stem Only LF476231/ LF476232

Also available less barrel

GASKET: 818010

22
1-4

Chrome Plated Stem

STEM LENGTH: 4.81"

USES BARREL:
LF647021/LF647022

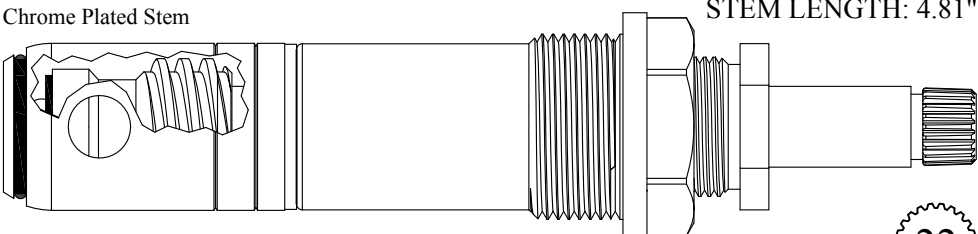

LF476041/ LF476042
LF276031/ LF276032 Stem Only LF476241/ LF476242

Also available less barrel

GASKET: 818010

22
1-4

Chrome Plated Stem

STEM LENGTH: 4.81"

USES BARREL:
LF647021/LF647022

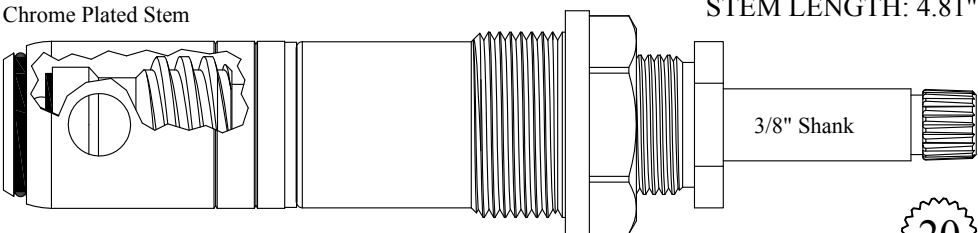

LF476131/ LF476132
LF276131/ LF276132 Stem Only LF476331/ LF476332

Also available less barrel

GASKET: 818010

20
3-14

Chrome Plated Stem

STEM LENGTH: 4.81"

USES BARREL:
LF647021/LF647022

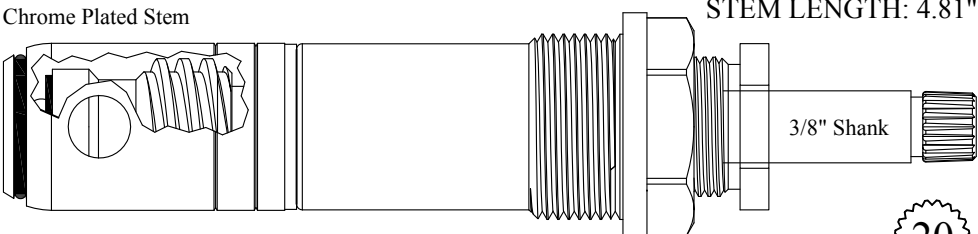

LF476141/ LF476142
LF276131/ LF276132 Stem Only LF476341/ LF476342

Also available less barrel

GASKET: 818010

20
3-14

FOR AMERICAN STANDARD

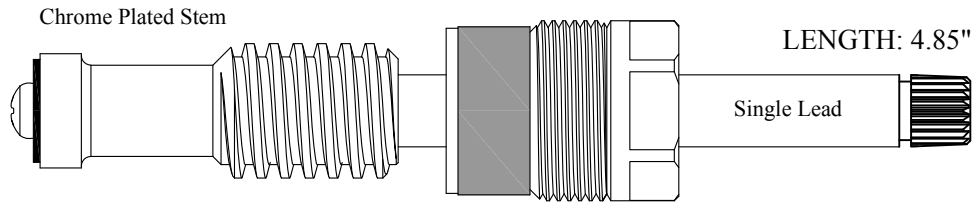

410351
210351

Supplied with
12pt. Broach

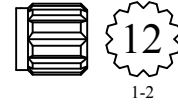

1-2

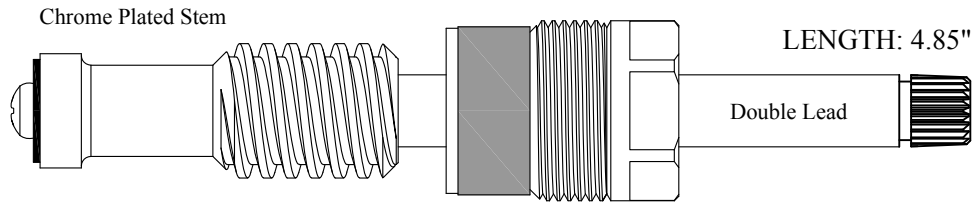

410361
210361

Supplied with
12pt. Broach

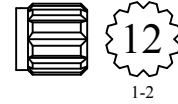

1-2

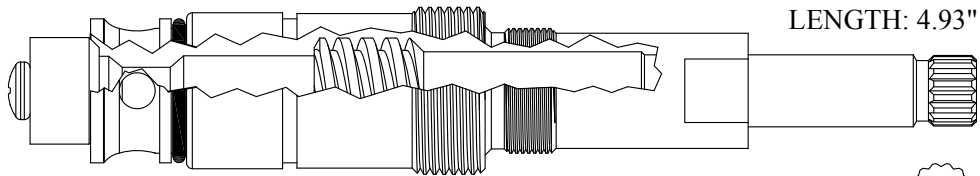

431601
INCLUDES WAVE WASHER: 897110

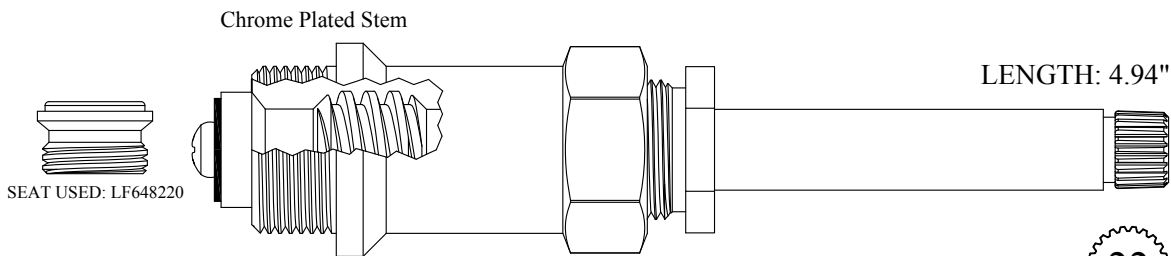

412301
212301 Stem Only
GASKET: 895400



1-4

FOR AMERICAN STANDARD

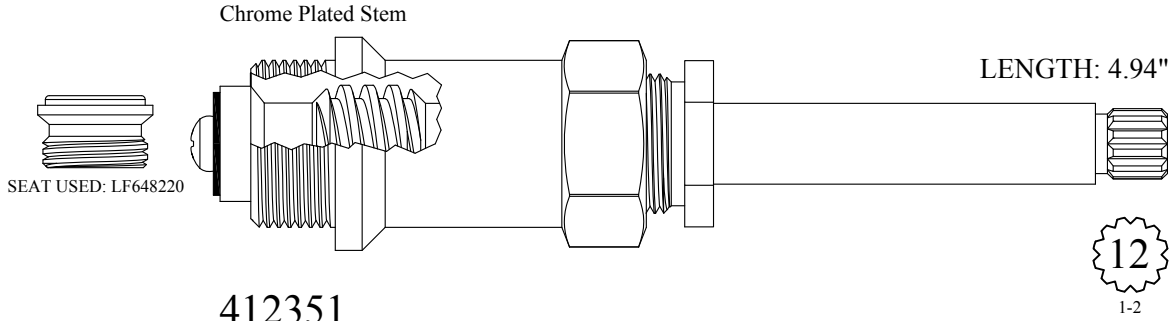

412351
212351 Stem Only
GASKET: 895400

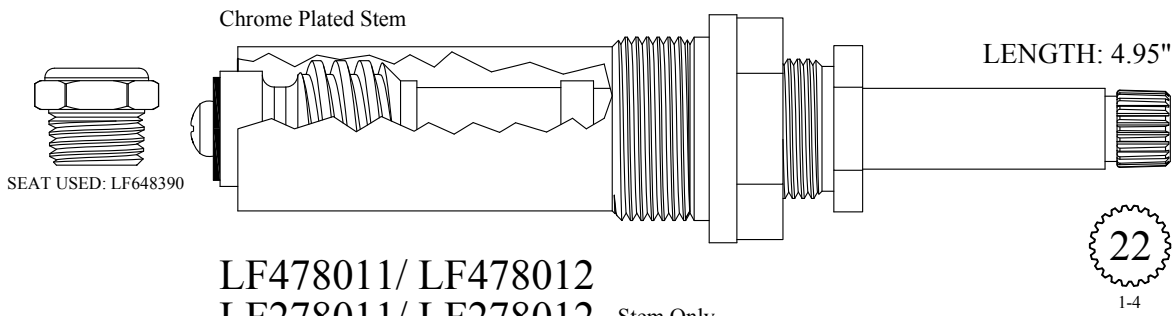

LF478011/ LF478012
LF278011/ LF278012 Stem Only

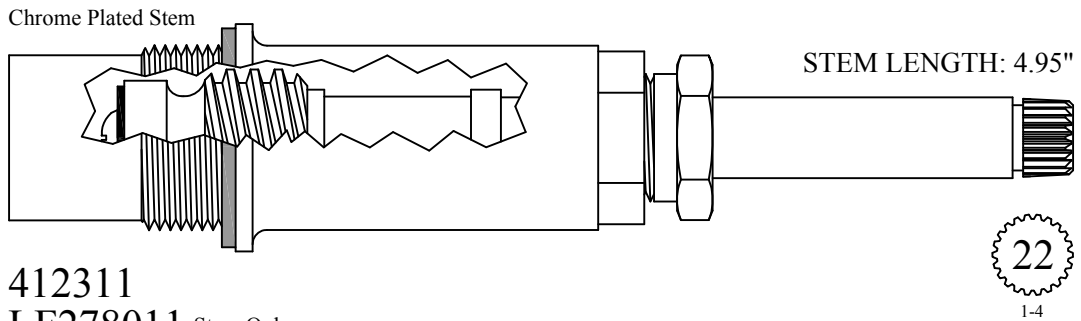

412311
LF278011 Stem Only
GASKET INCLUDED: 895350

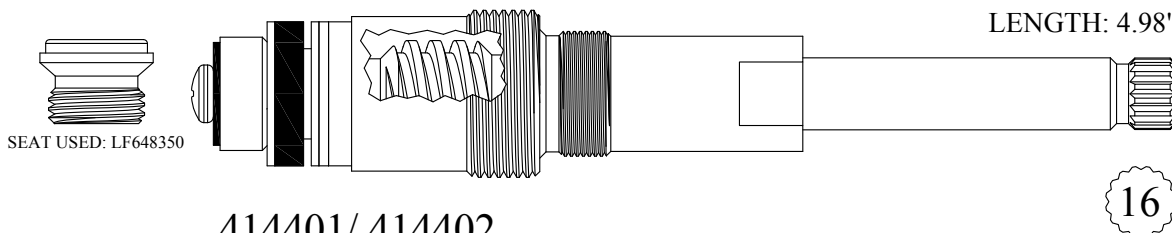

414401/ 414402
214401/ 214402 Stem Only
WAVE WASHER: 897110

FOR AMERICAN STANDARD

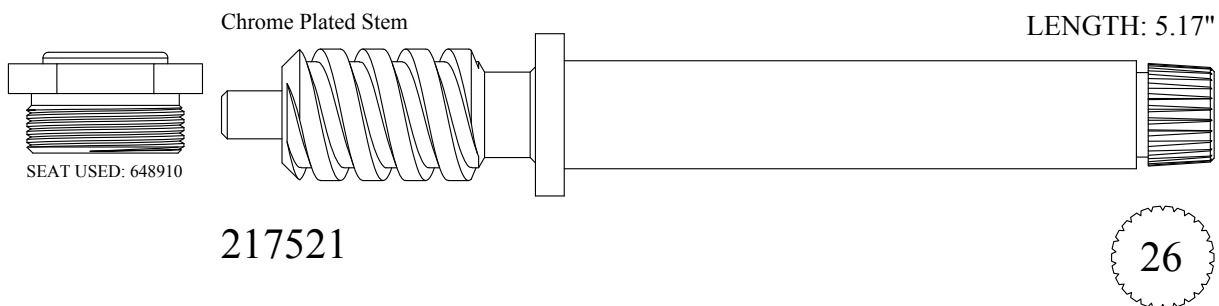
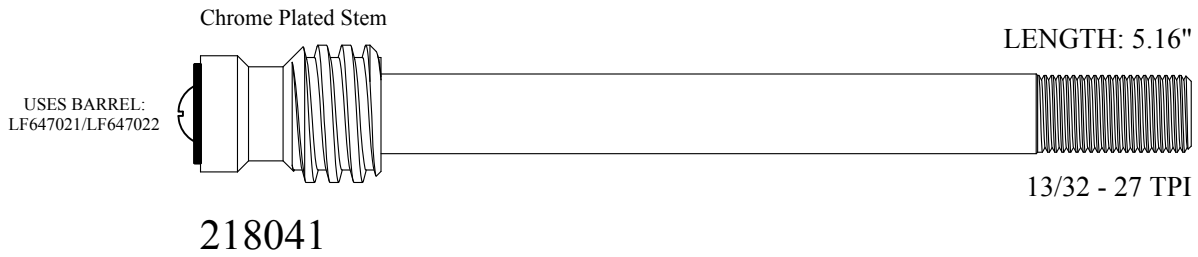
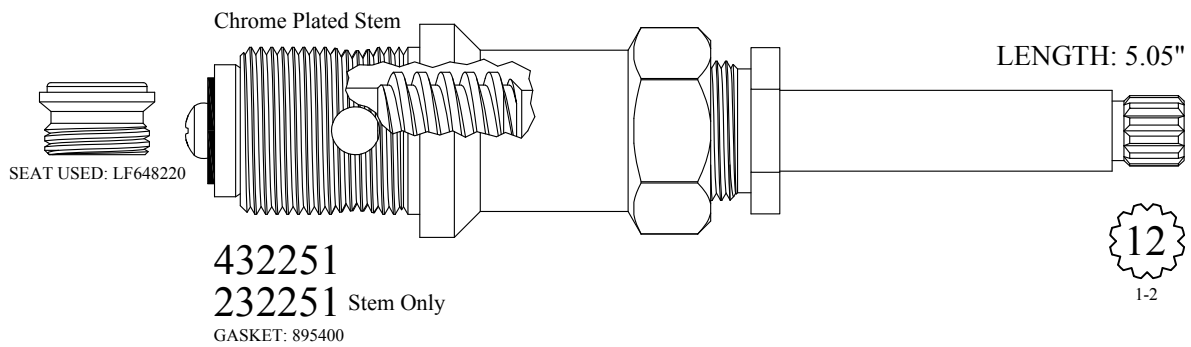
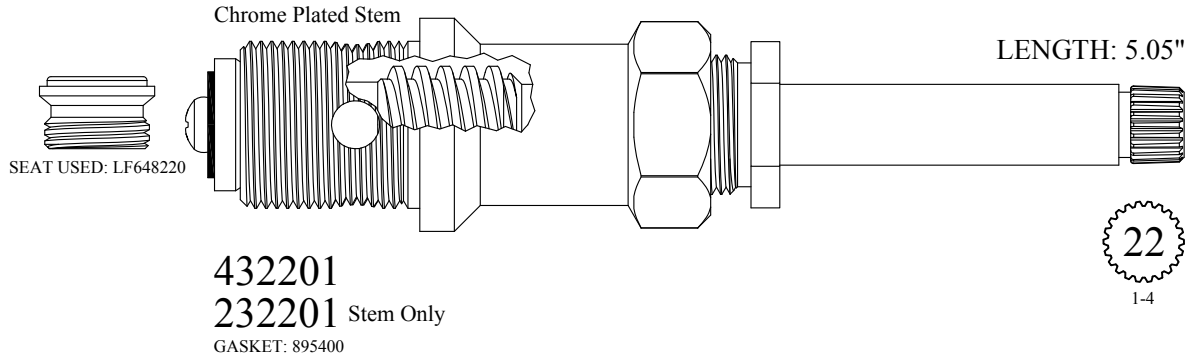

FOR AMERICAN STANDARD

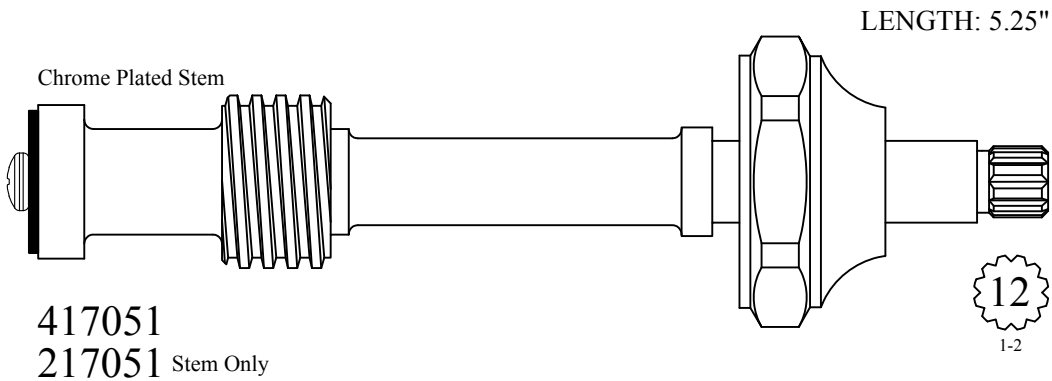
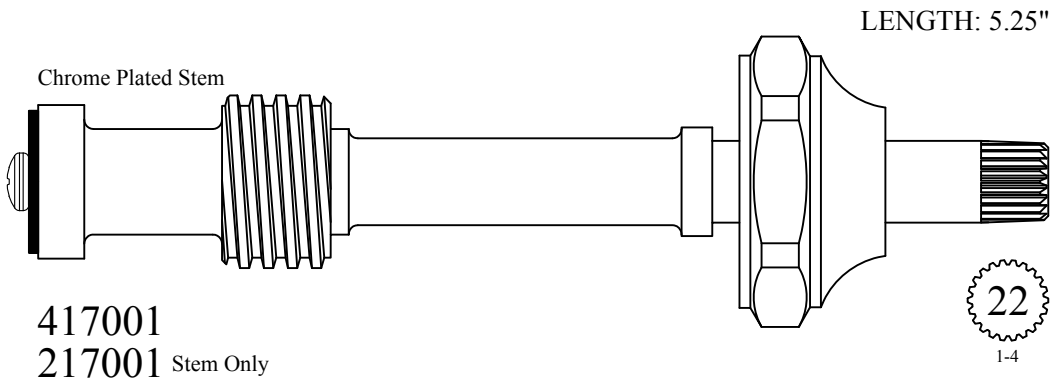
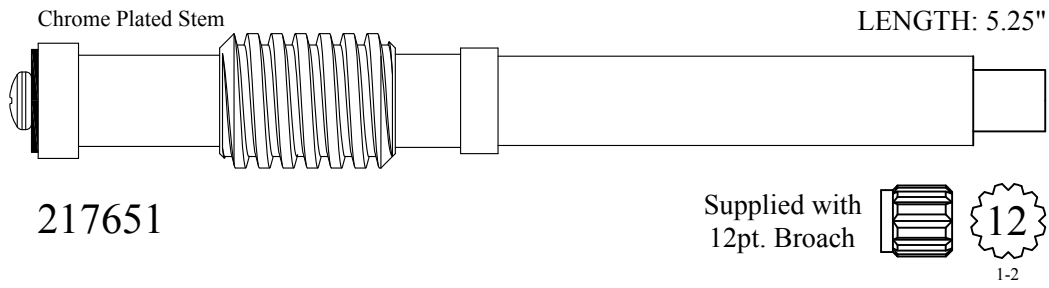
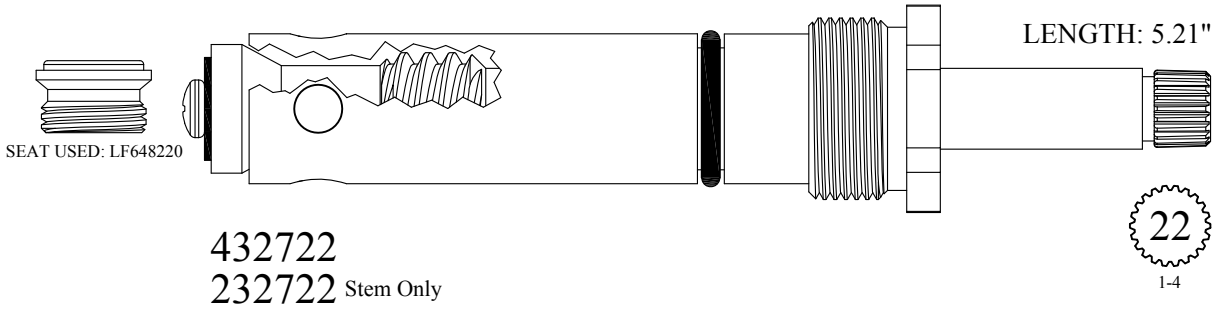

FOR AMERICAN STANDARD

Chrome Plated Stem

LENGTH: 5.30"

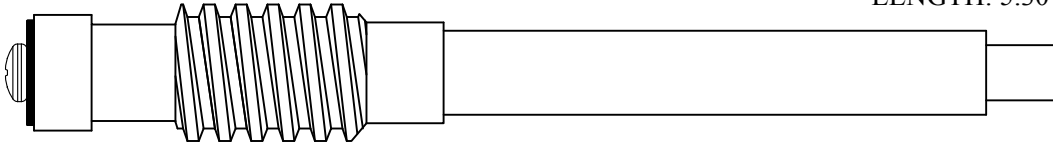

225151

Supplied with
12pt. Broach



1-2

Chrome Plated Stem

Also available less barrel
199651/ 199652

STEM LENGTH: 5.31"

USES BARREL:
LF647021/LF647022

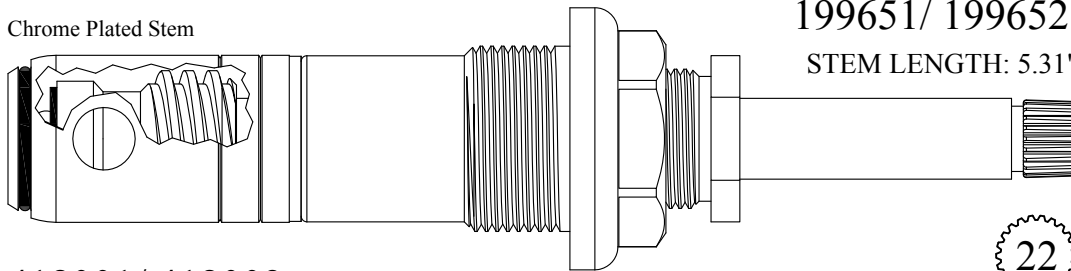

418001/ 418002

218001/ 218002 Stem Only

GASKET: 818000



1-4

Chrome Plated Stem

STEM LENGTH: 5.31"

USES BARREL:
LF647021/LF647022

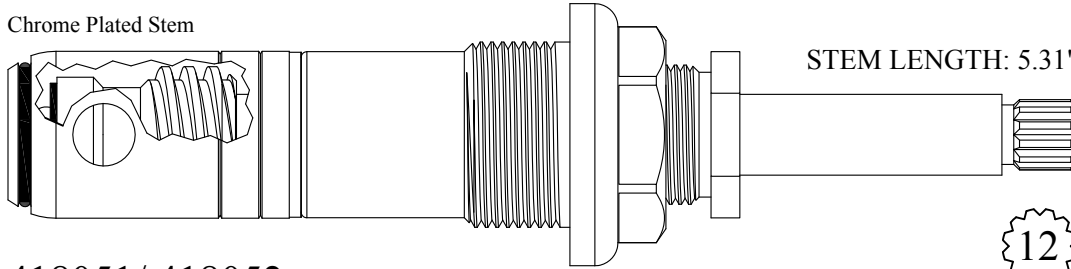

418051/ 418052

218051/ 218052 Stem Only

GASKET: 818000



1-2

Chrome Plated Stem

STEM LENGTH: 5.31"

USES BARREL:
LF647021/LF647022

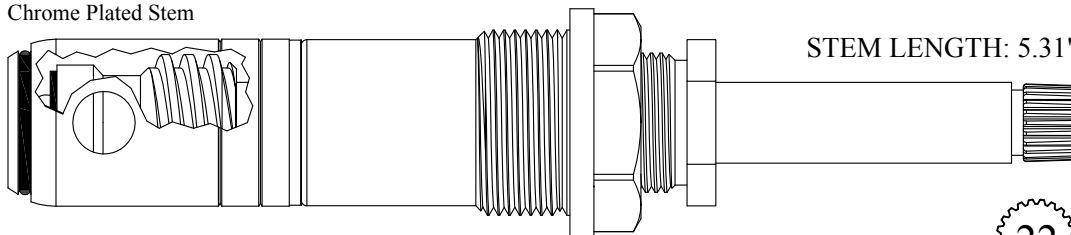

418011/ 418012

218001/ 218002 Stem Only

GASKET: 818000



1-4

FOR AMERICAN STANDARD

Chrome Plated Stem

USES BARREL:
LF647021/LF647022

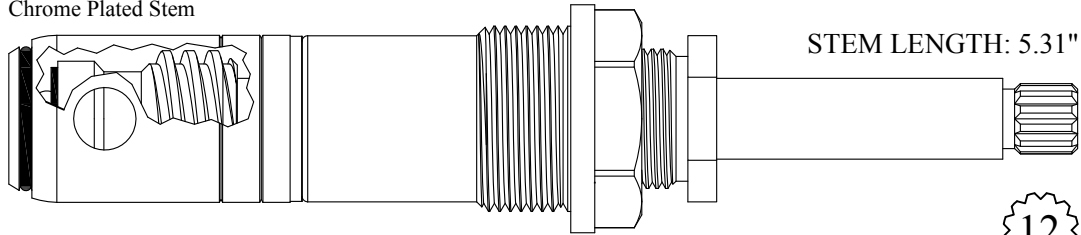

STEM LENGTH: 5.31"

418061/ 418062
218051/ 218052 Stem Only
GASKET: 818000

12
1-2

Chrome Plated Stem

USES BARREL:
LF647021/LF647022

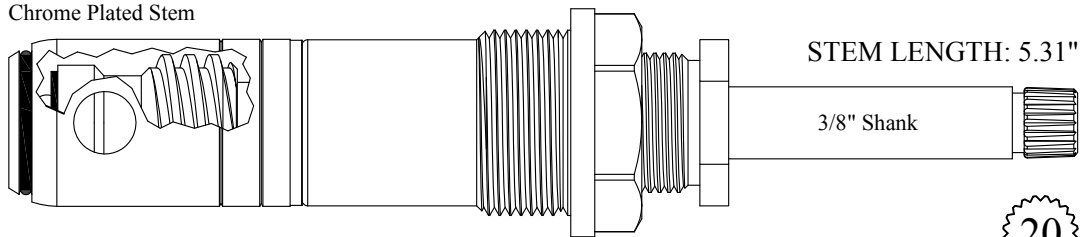

STEM LENGTH: 5.31"

3/8" Shank

418021/ 418022
218021/ 218022 Stem Only
GASKET: 818010

20
3-14

Chrome Plated Stem

USES BARREL:
LF647021/LF647022

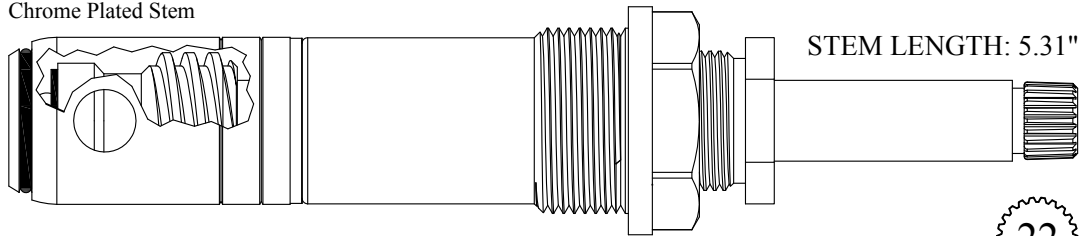

STEM LENGTH: 5.31"

418031/ 418032
218001/ 218002 Stem Only
GASKET: 818010

22
1-4

Chrome Plated Stem

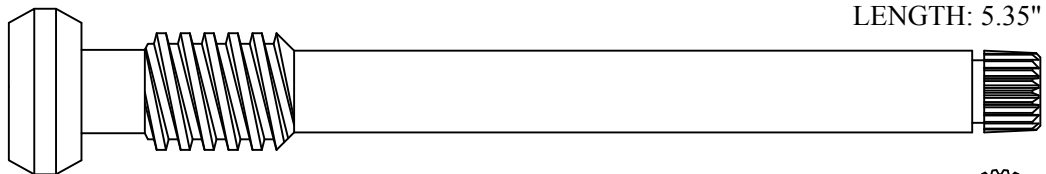

LENGTH: 5.35"

233531

22
1-4

FOR AMERICAN STANDARD

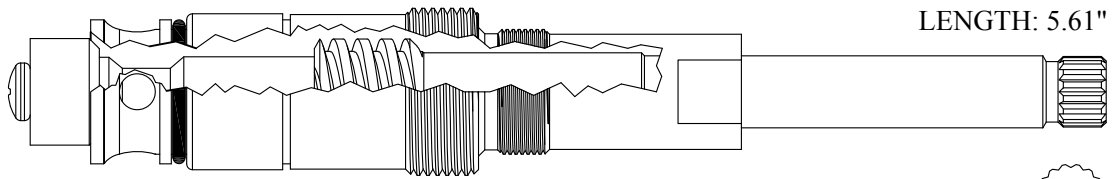

LENGTH: 5.61"

16

433801

233801 Stem Only

WAVE WASHER INCLUDED: 897110

Chrome Plated Stem

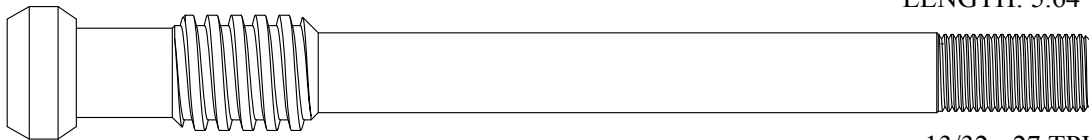

LENGTH: 5.64"

13/32 - 27 TPI

235641

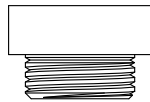

SEAT USED: 649090

Also available with seat & gasket included

435621

Also available less bonnet

151171

Also available less sleeve

435631

Chrome Plated Stem

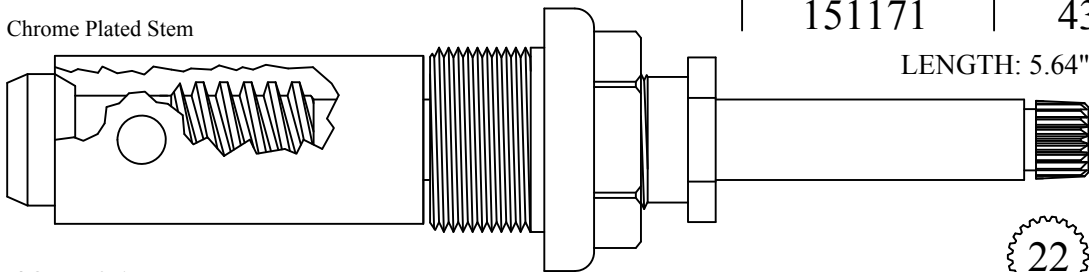

LENGTH: 5.64"

22

1-4

435701

235701 Stem Only

GASKET: 818000

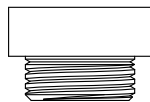

SEAT USED: 649090

Chrome Plated Stem

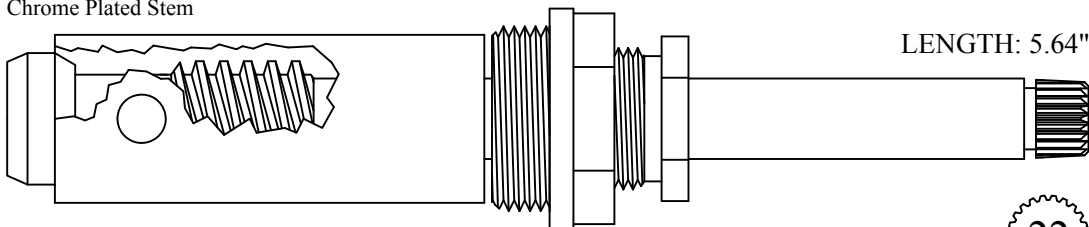

LENGTH: 5.64"

22

1-4

435711

235701 Stem Only

GASKET: 818010



SEAT USED: 649090

FOR AMERICAN STANDARD

Chrome Plated Stem

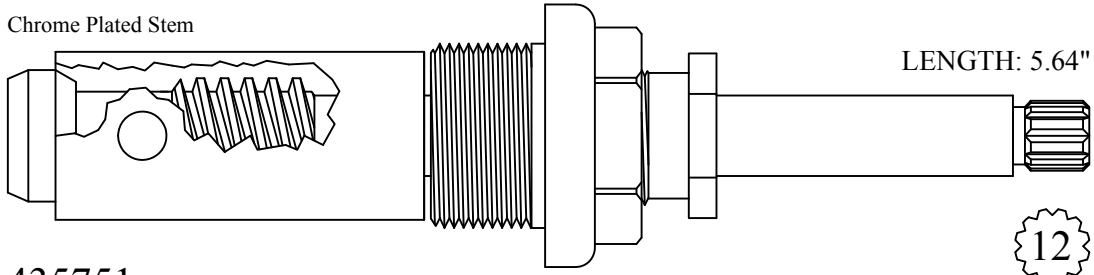

LENGTH: 5.64"

12
1-2

435751
235751 Stem Only
GASKET: 818000

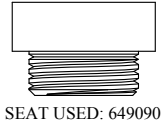

SEAT USED: 649090

Chrome Plated Stem

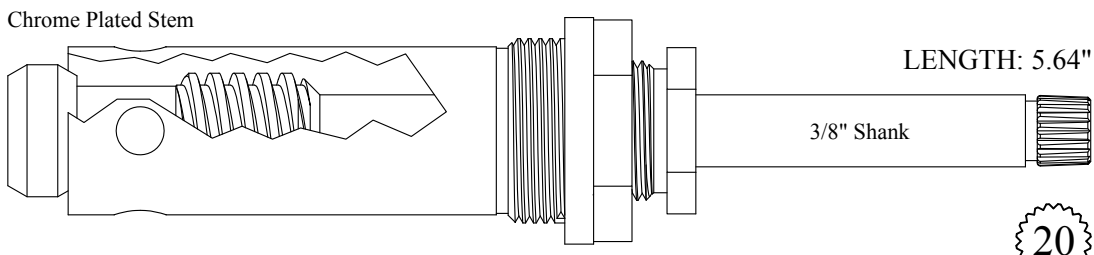

LENGTH: 5.64"

3/8" Shank

20
3-14

435611
235611 Stem Only
GASKET: 818010

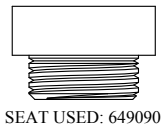

SEAT USED: 649090

Chrome Plated Stem

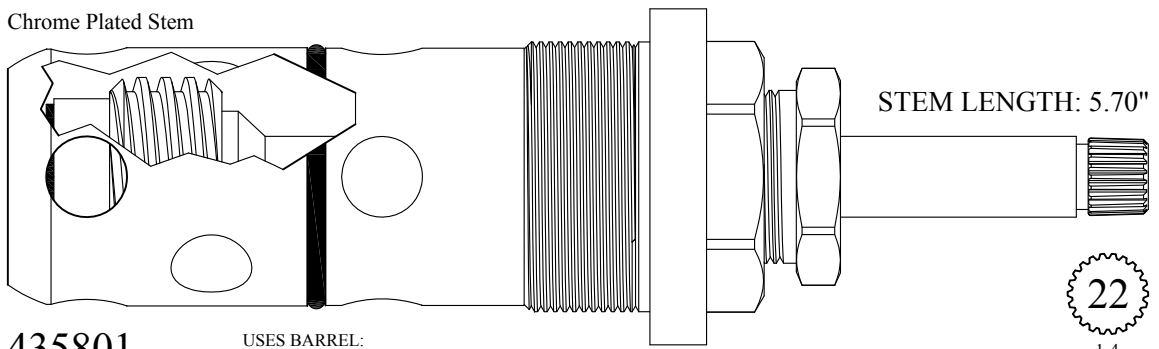

STEM LENGTH: 5.70"

22
1-4

435801
235801 Stem Only
USES BARREL: 635801

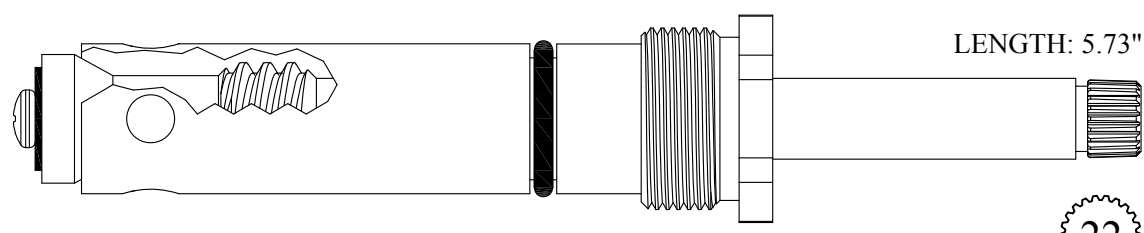

LENGTH: 5.73"

22
1-4

435312
235312 Stem Only

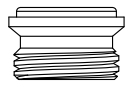

SEAT USED: LF648220

FOR AMERICAN STANDARD

Chrome Plated Stem



LENGTH: 5.75"

224641/ 224642

USES BARREL:
647081/647082



Chrome Plated Stem

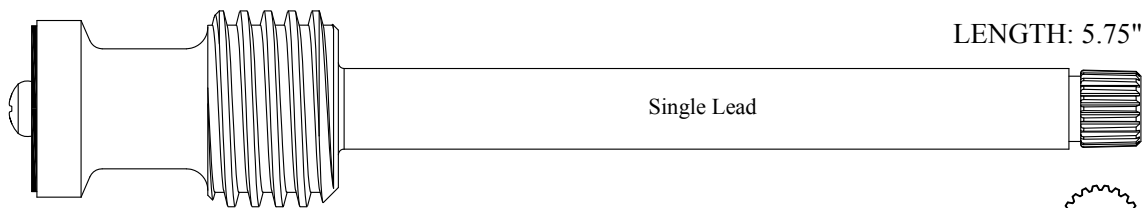

LENGTH: 5.75"

Single Lead

224611

USES BARREL:
647071



Chrome Plated Stem

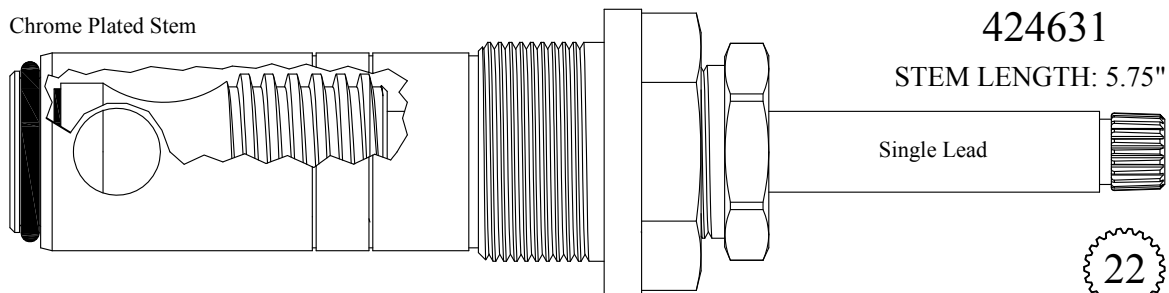

Also available less barrel

424631

STEM LENGTH: 5.75"

Single Lead

424601

USES BARREL:
647051

224601 Stem Only

GASKET: 824600



Chrome Plated Stem

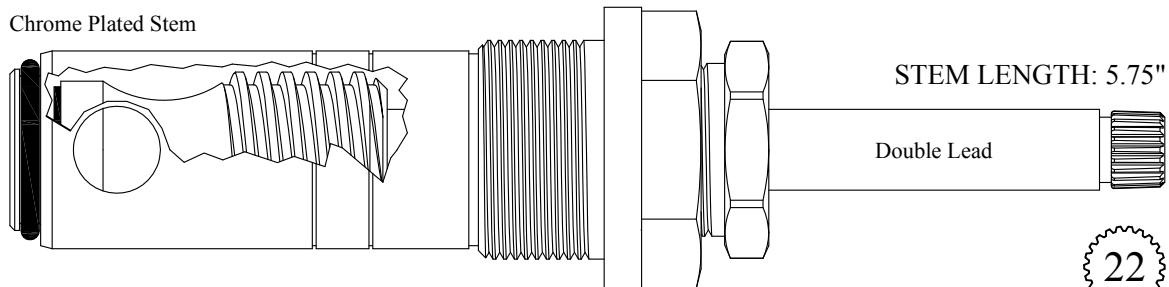

STEM LENGTH: 5.75"

Double Lead

424621/ 424622

USES BARREL:
647061 / 647062

224621/ 224622 Stem Only

GASKET: 824600



FOR AMERICAN STANDARD

Chrome Plated Stem

STEM LENGTH: 5.81"

425501/ 425502
225501/ 225502 Stem Only
GASKET: 818000

USES BARREL:
LF647021/LF647022

22
1-4

Chrome Plated Stem

STEM LENGTH: 5.81"

425511
225501 Stem Only
GASKET: 818010

USES BARREL:
LF647021

22
1-4

Chrome Plated Stem

STEM LENGTH: 5.88"

425711
225711 Stem Only

USES BARREL:
647051

22
1-4

Chrome Plated Stem

LENGTH: 6.13"

Single Lead

225701

USES BARREL:
647071

22
1-4

Send Your Orders To:

BARRY E.  SR. CO.

E-mail: orderdesk@barrywalter.com

Fax: 1.800.886.9831

Phone: 1.800.767.5552

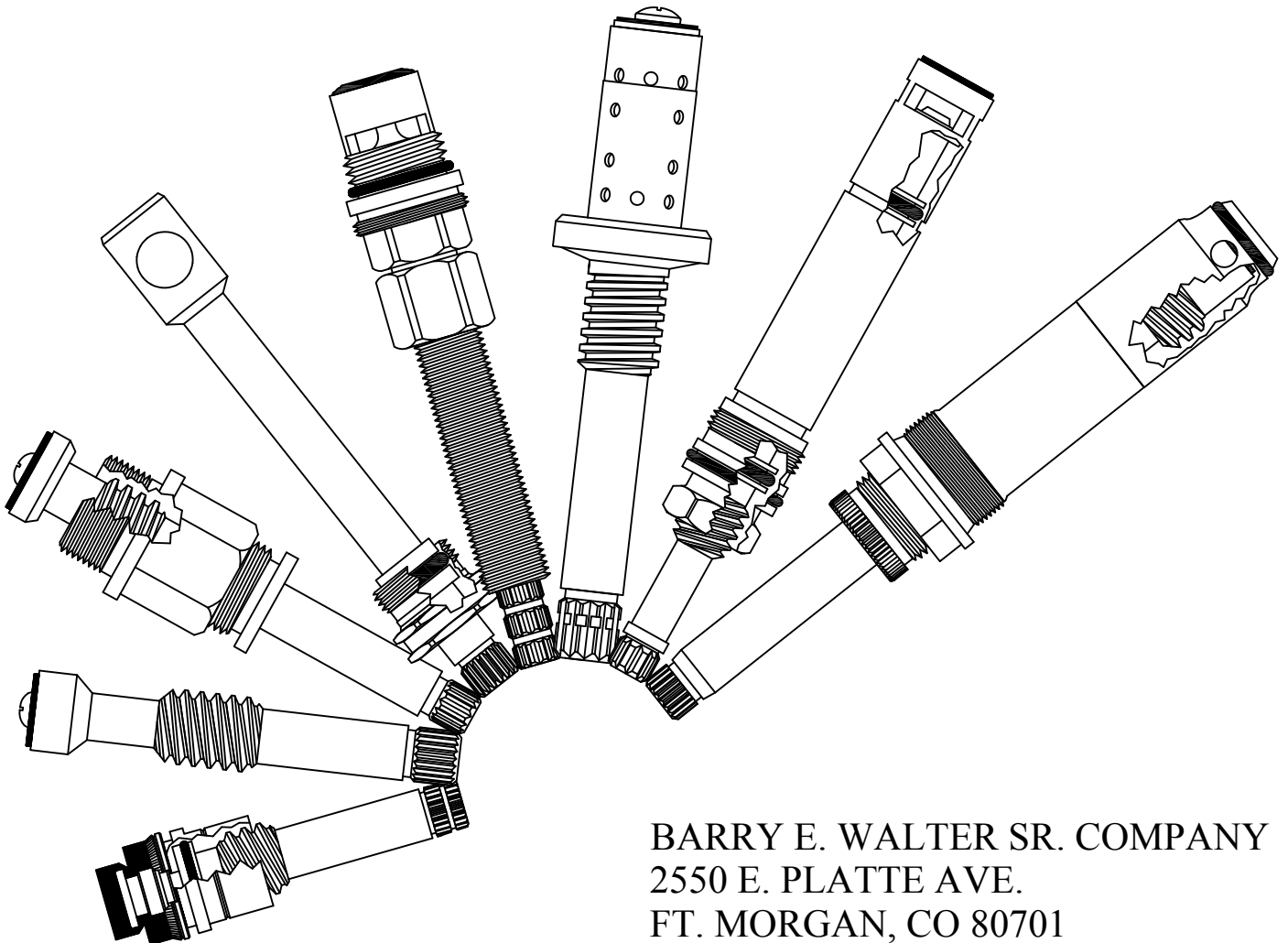

BARRY E. WALTER SR. COMPANY
2550 E. PLATTE AVE.
FT. MORGAN, CO 80701

*We are always adding
new parts. Check our
website for updates.*

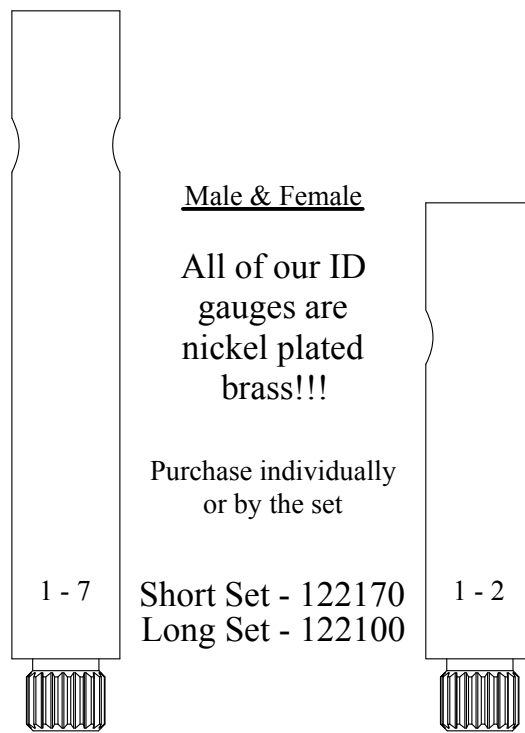

15 DIFFERENT BROACHES IN A SET

BARRY E.  SR. CO.

The logo features a stylized 'W' with a registered trademark symbol, flanked by a vertical bar on the left and a horizontal bar with a threaded end on the right.

FOR AMERICAN STANDARD

Chrome Plated Stem

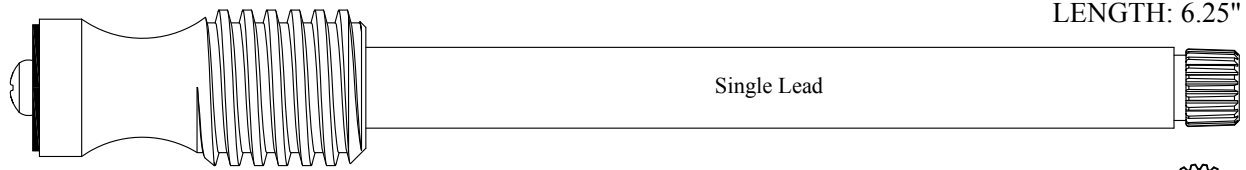

LENGTH: 6.25"

Single Lead

226781

USES BARREL:
647051



Chrome Plated Stem

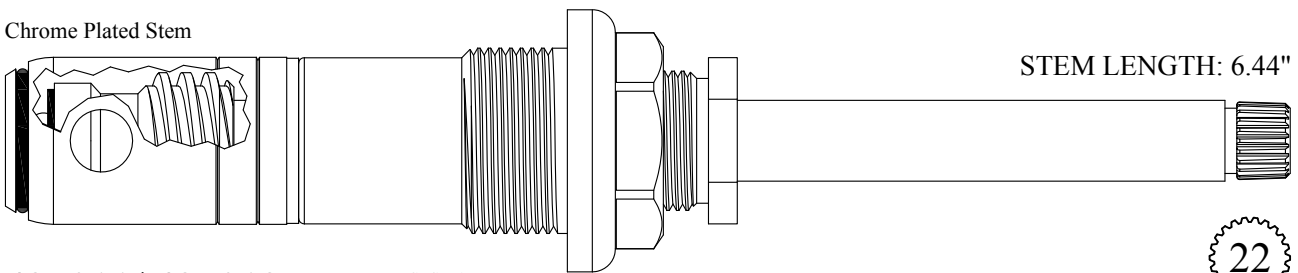

STEM LENGTH: 6.44"

427011/ 427012
227011/ 227012 Stem Only
GASKET: 818000

USES BARREL:
LF647021/LF647022



Chrome Plated Stem

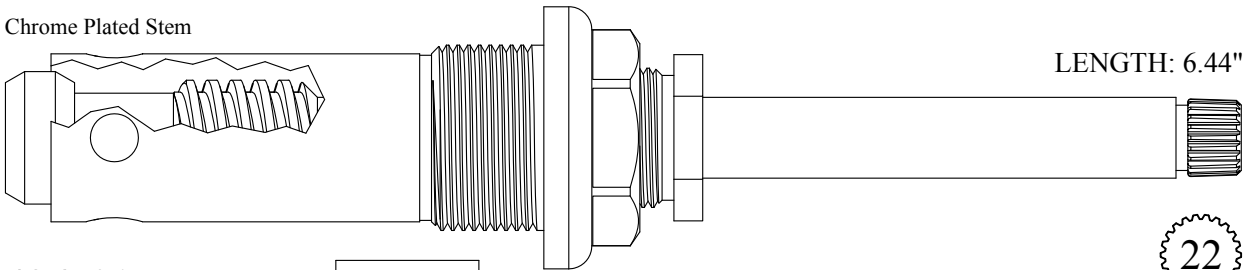

LENGTH: 6.44"

436501
236501 Stem Only
GASKET: 818000

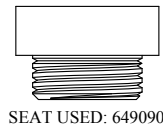

SEAT USED: 649090



Chrome Plated Stem

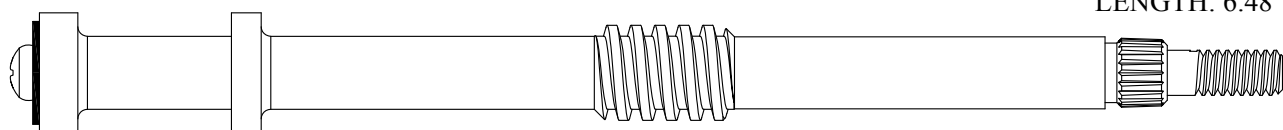

LENGTH: 6.48"

LF280511



FOR AMERICAN STANDARD

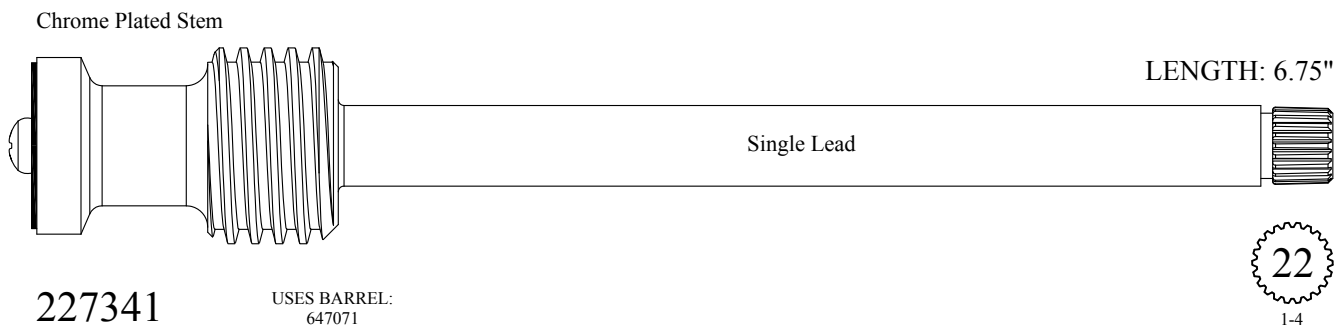
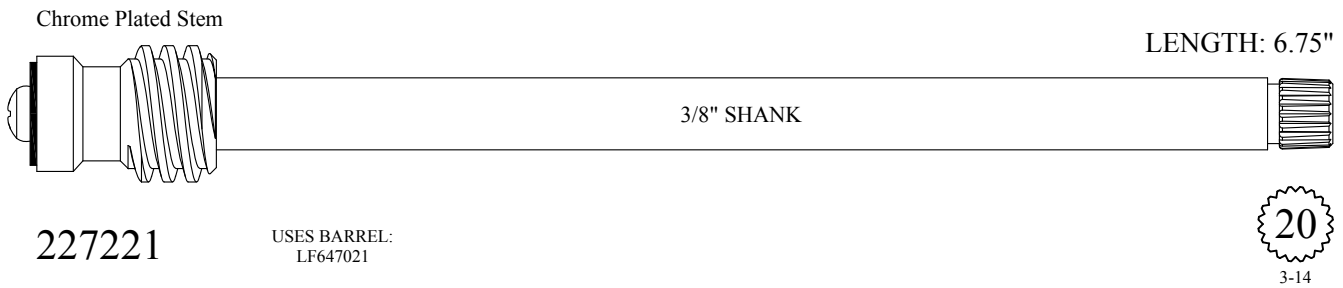
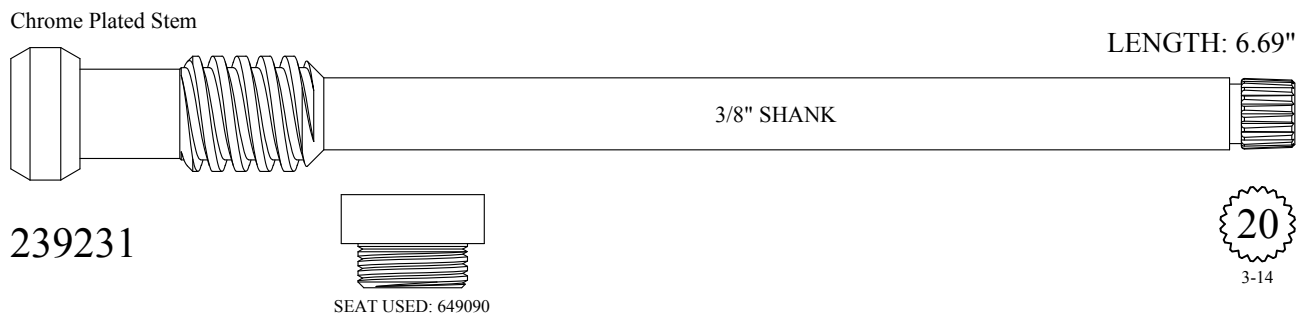
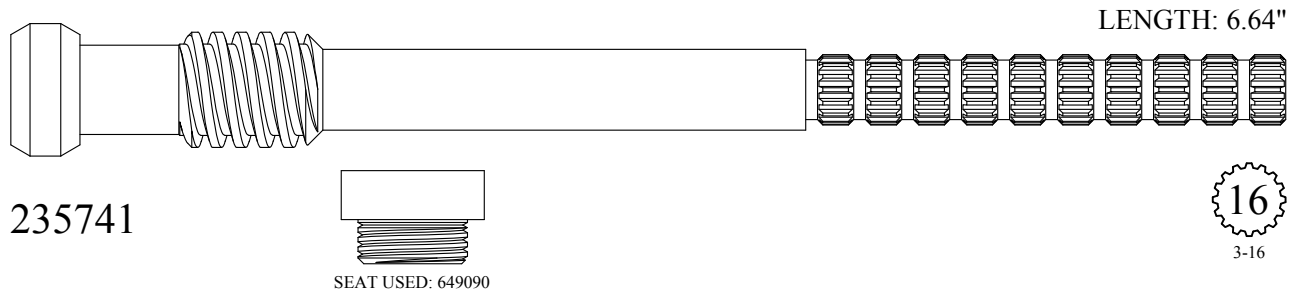

FOR AMERICAN STANDARD

Chrome Plated Stem

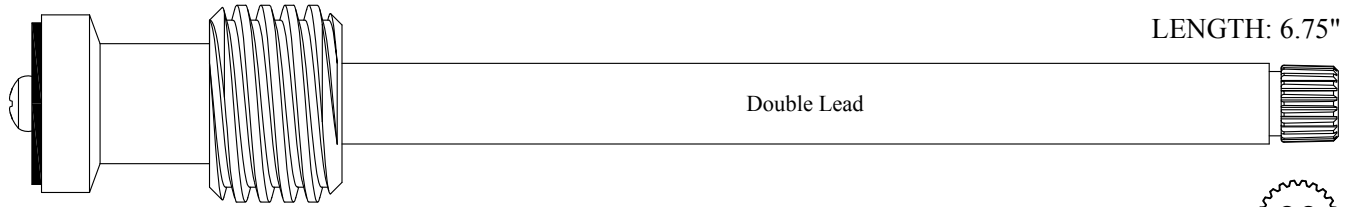

LENGTH: 6.75"

Double Lead

227351/ 227352

USES BARREL:
647081/647082



Chrome Plated Stem

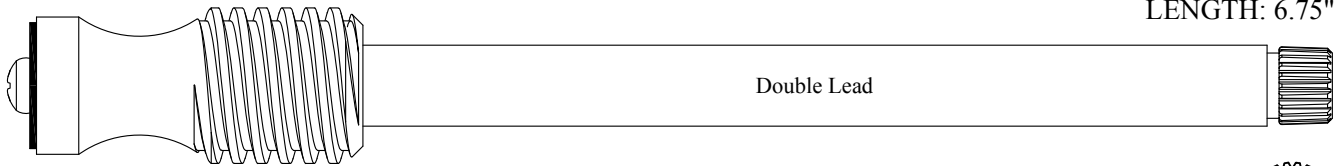

LENGTH: 6.75"

Double Lead

227361/ 227362

USES BARREL:
647061/647062



Chrome Plated Stem

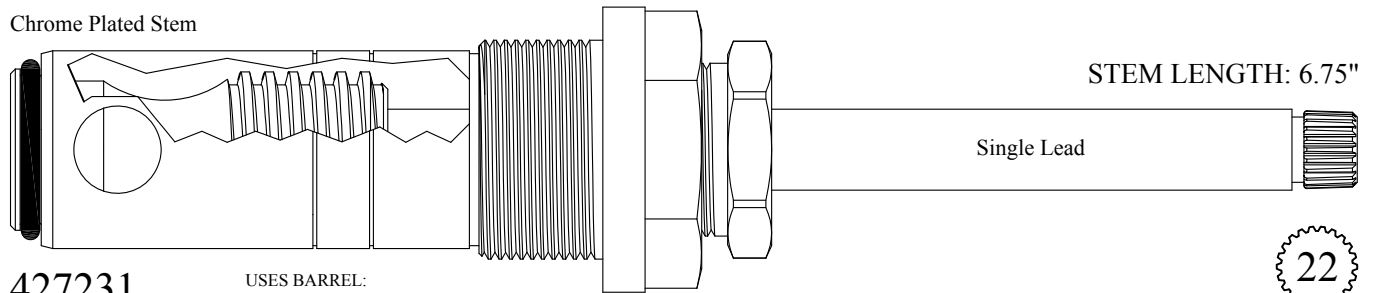

STEM LENGTH: 6.75"

Single Lead

427231

USES BARREL:
647051

227231 Stem Only

GASKET: 824600



Chrome Plated Stem

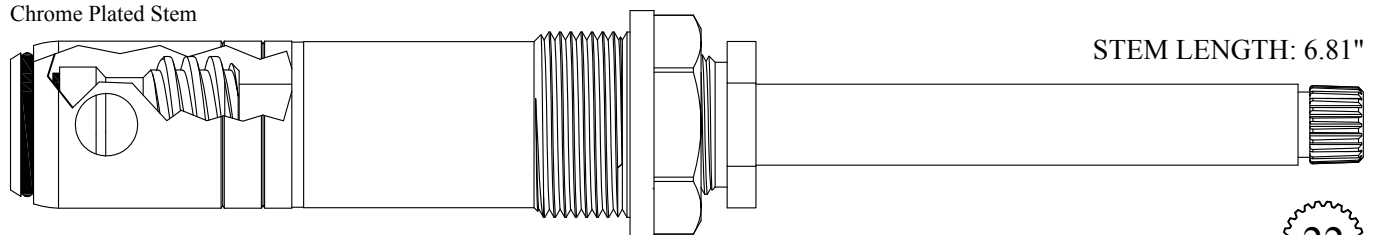

STEM LENGTH: 6.81"

427151

USES BARREL:
LF647021

227021 Stem Only

GASKET: 818010



FOR AMERICAN STANDARD

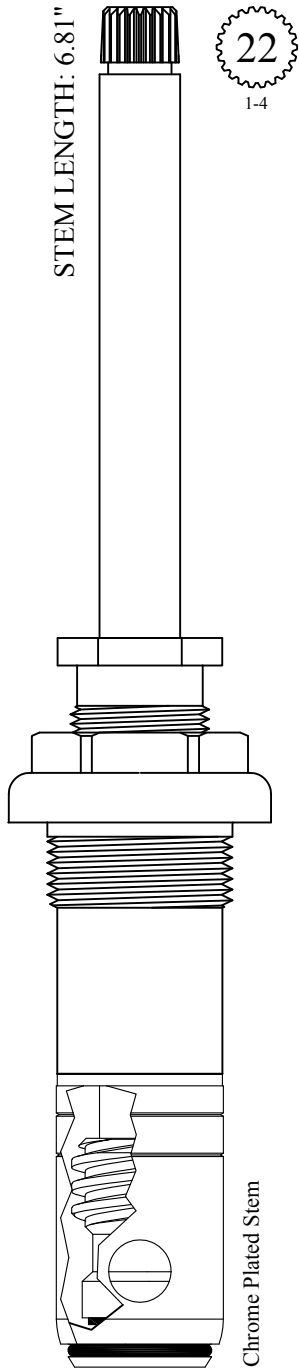

GASKET: 818000

427021

427022

227021 Stem Only

227022 Stem Only

USES BARREL:
LF647021/LF647022

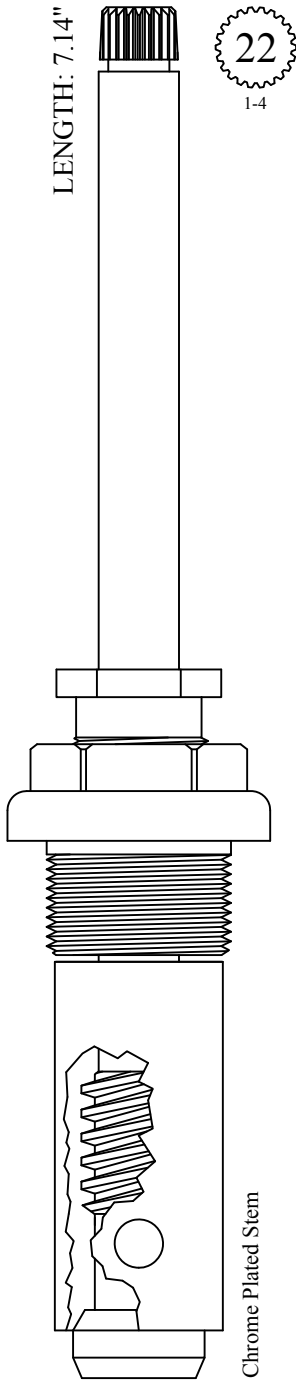

GASKET: 818000

435041

235041 Stem Only



SEAT USED: 649090

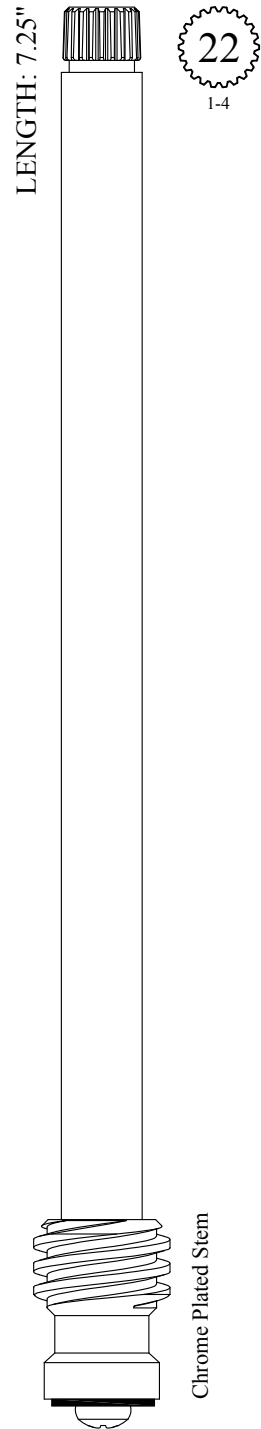

227611

USES BARREL:
LF647021

FOR AMERICAN STANDARD

LENGTH: 7.75"

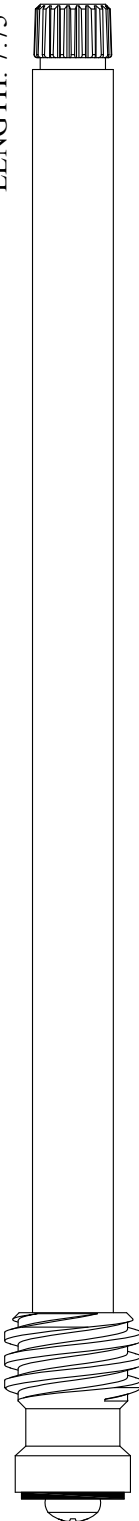

22
1-4

Chrome Plated Stem

227811
USES BARREL:
LF647021

LENGTH: 8.38"

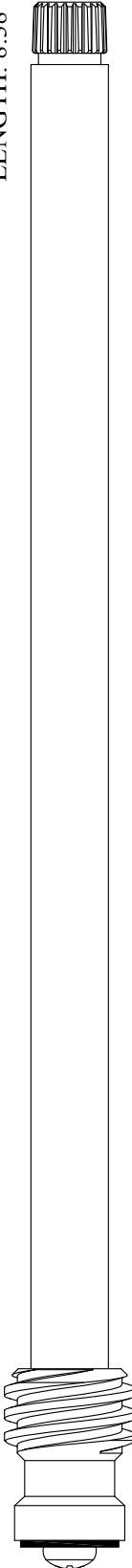

22
1-4

Chrome Plated Stem

228241
USES BARREL:
LF647021

LENGTH: 9.38"

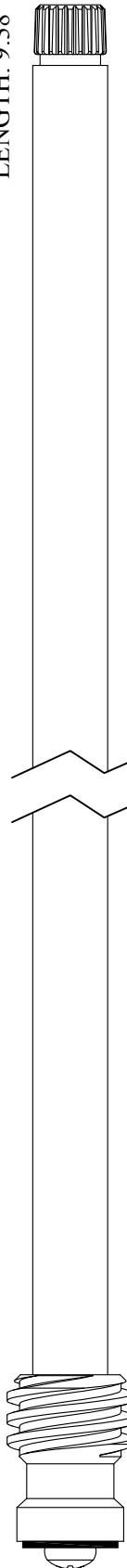

22
1-4

Chrome Plated Stem

228411
USES BARREL:
LF647021

FOR AMERICAN STANDARD

LENGTH: 9.75"
22
1-4

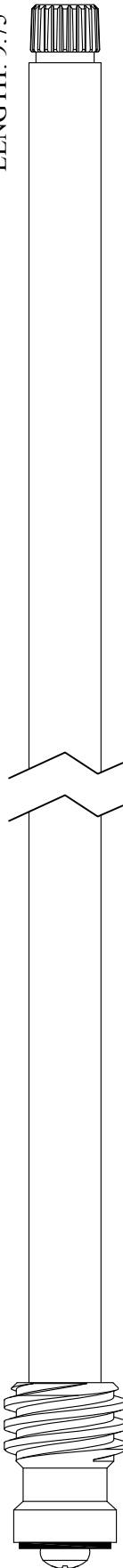

LENGTH: 10.75"
22
1-4

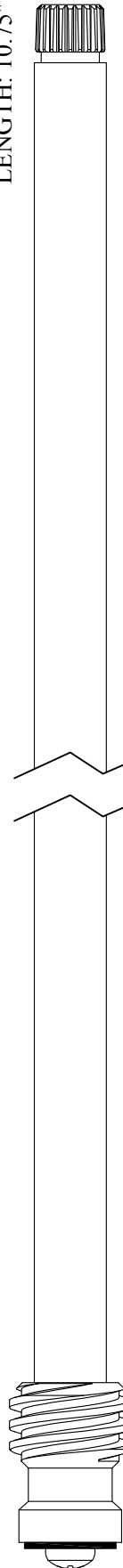

228431
USES BARREL:
LF647021

228611
USES BARREL:
LF647021

Send Your Orders To:

BARRY E.  SR. CO.

E-mail: orderdesk@barrywalter.com

Fax: 1.800.886.9831

Phone: 1.800.767.5552

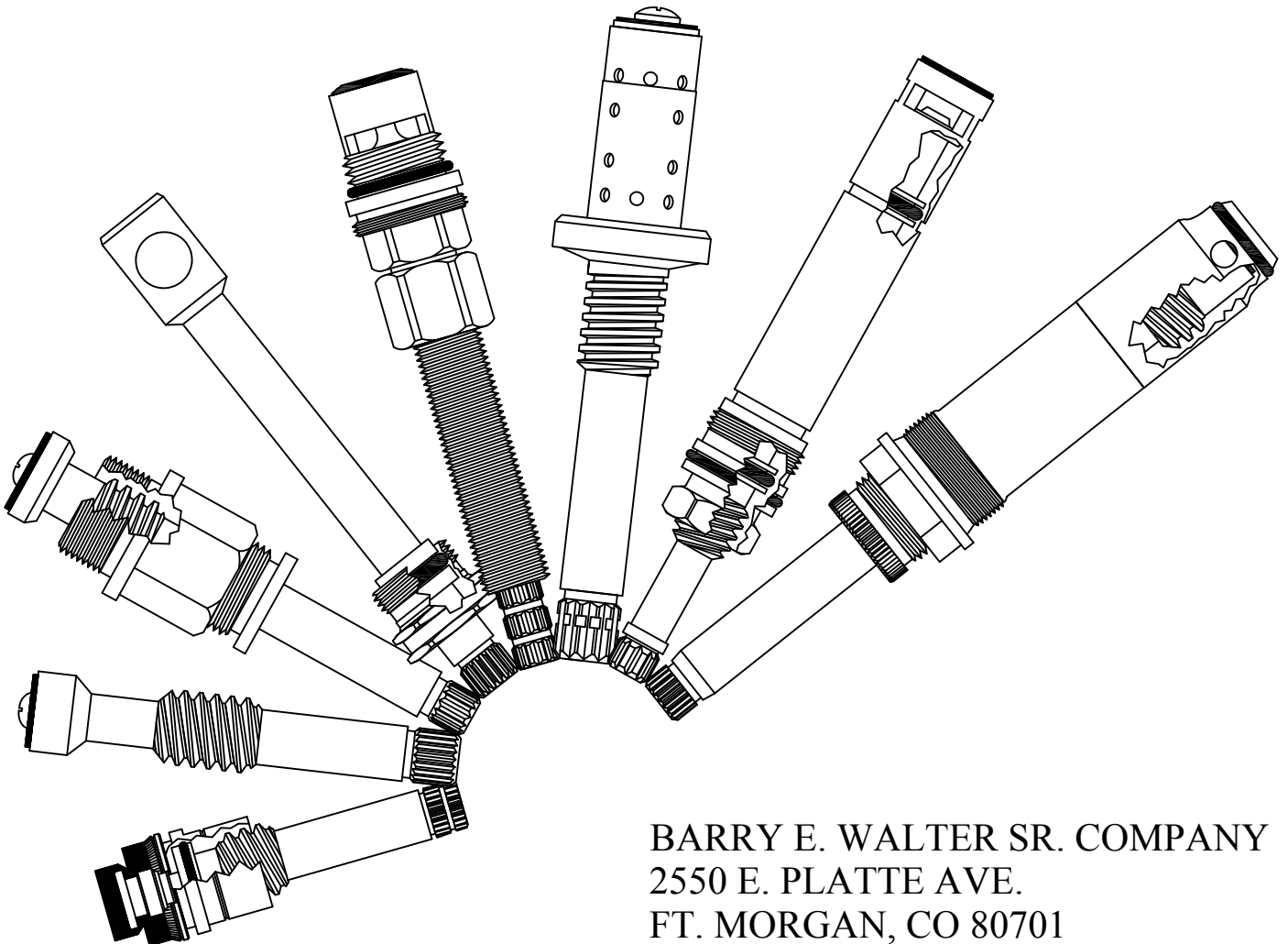

BARRY E. WALTER SR. COMPANY
2550 E. PLATTE AVE.
FT. MORGAN, CO 80701

FOR APEX

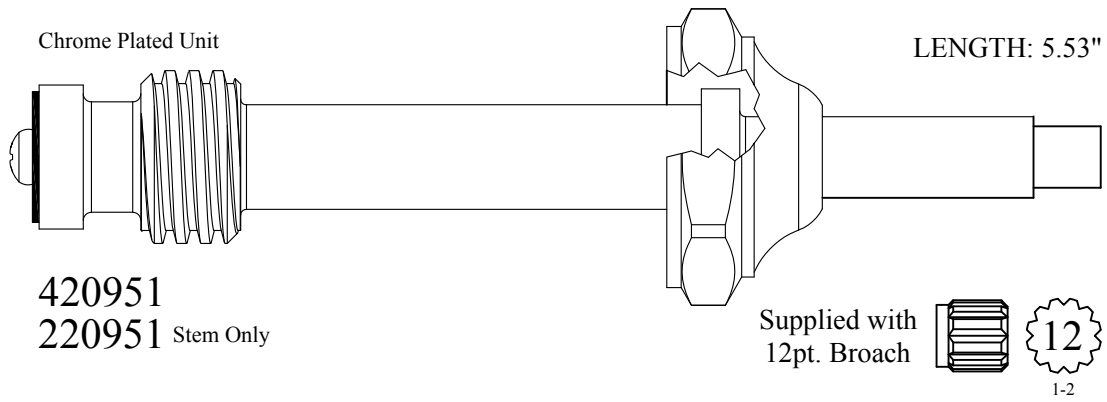

FOR AQUASOURCE

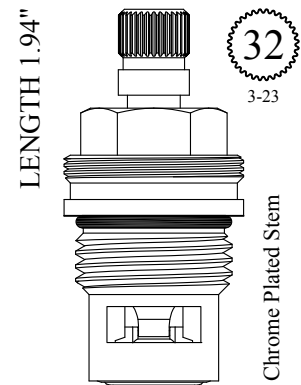

GASKET: 890170 O-RING INCLUDED
SEAL: 898500
DISC SET: 112530-PKG

LF457311
LF457312

FOR ARSELUX

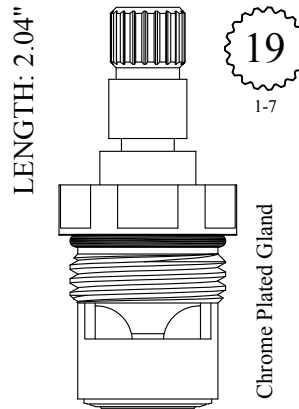

GASKET: 890170 O-RING INCLUDED
SEAL: 898510
DISC SET: 151380-PKG

LF461501
LF461502

FOR ARJO

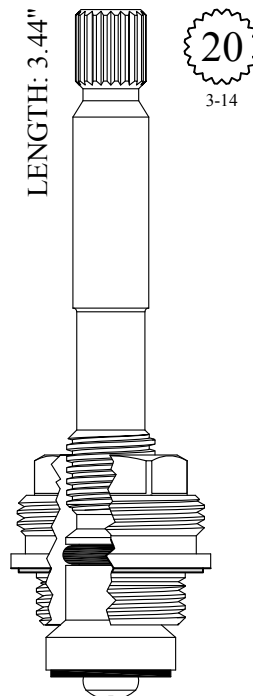

GASKET: 895160 INCLUDED

403071

FOR ARMONIA

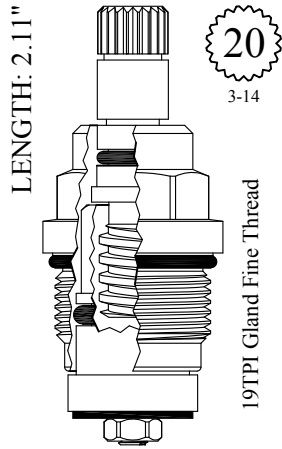

GASKET: 890180 O-RING INCLUDED

LF460172

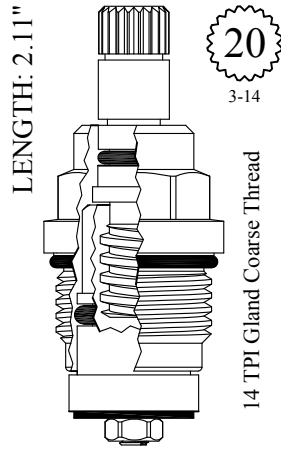

GASKET: 890180 O-RING INCLUDED

LF460182

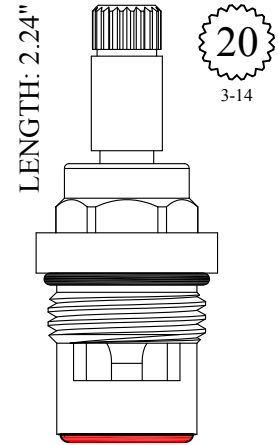

GASKET: 890170 O-RING INCLUDED
SEAL: 898570-R/B
DISC SET: 151380-PKG

LF461861
LF461862

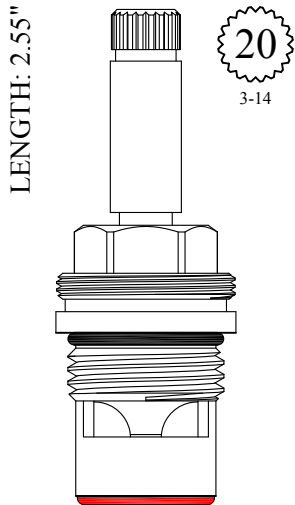

GASKET: 890170 O-RING INCLUDED
SEAL: 898570-R/B
DISC SET: 151380-PKG

LF462861
LF462862

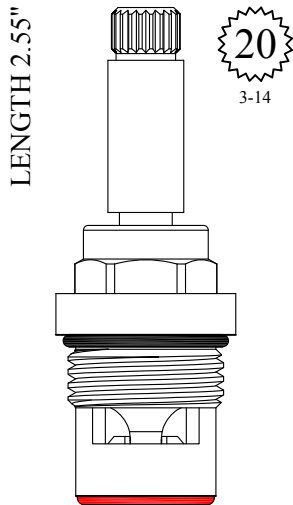

GASKET: 890170 O-RING INCLUDED
SEAL: 898570-R/B
DISC SET: 151380-PKG

LF462881
LF462882

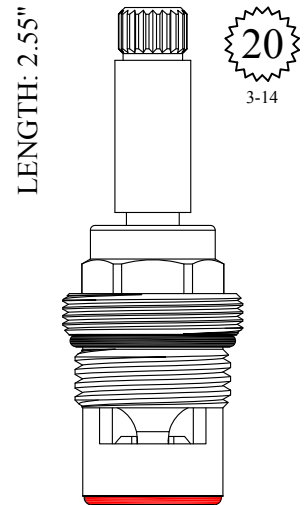

GASKET: 890170 O-RING INCLUDED
SEAL: 898570-R/B
DISC SET: 151380-PKG

LF462891
LF462892

FOR ARMONIA

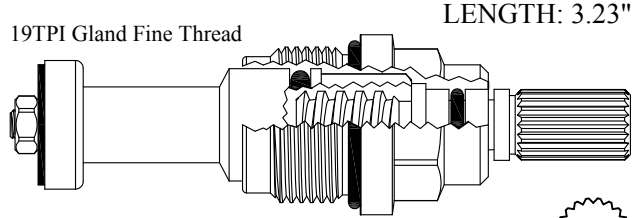

401822

GASKET: 890180 O-RING INCLUDED

20
3-14

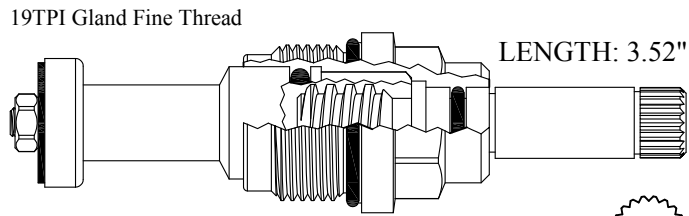

402532

GASKET: 890180 O-RING INCLUDED

20
3-14

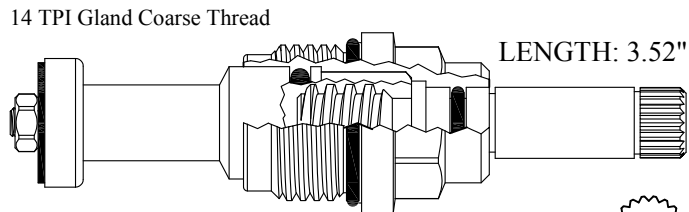

402542

GASKET: 890180 O-RING INCLUDED

20
3-14

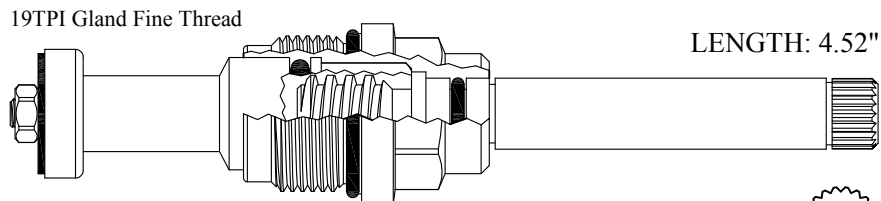

405942

GASKET: 890180 O-RING INCLUDED

20
3-14

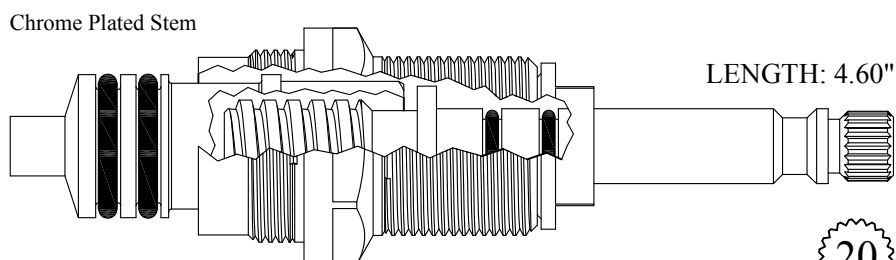

431441

GASKET: 895570 INCLUDED

20
3-14

FOR ARROWHEAD

LENGTH: 1.24"

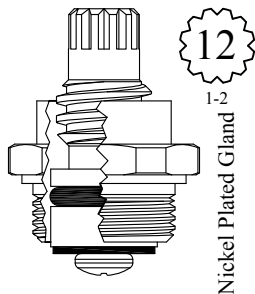

GASKET: 895100

LF450041
LF450042



SEAT USED: LF648230

LENGTH: 1.43"

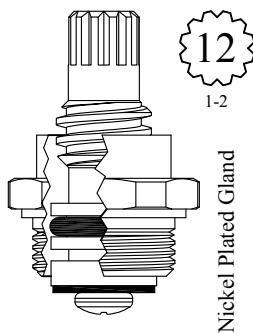

GASKET: 895100

LF452021
LF452022



SEAT USED: LF648230

LENGTH: 1.46"

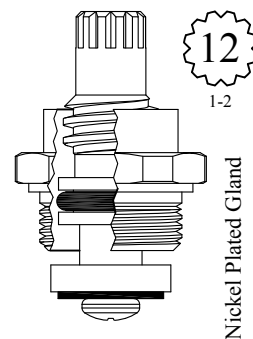

GASKET: 895100

LF450101
LF450102



SEAT USED: LF648230

LENGTH: 1.72"

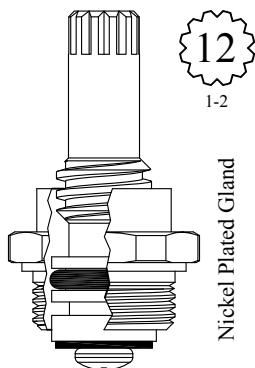

GASKET: 895100

LF454191
LF454192



SEAT USED: LF648230

LENGTH: 1.75"

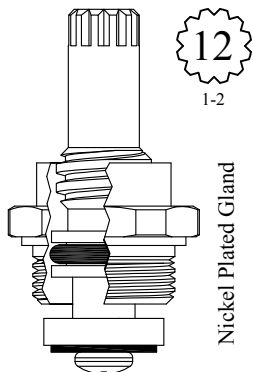

GASKET: 895100

LF454091
LF454092



SEAT USED: LF648230

LENGTH: 1.84"

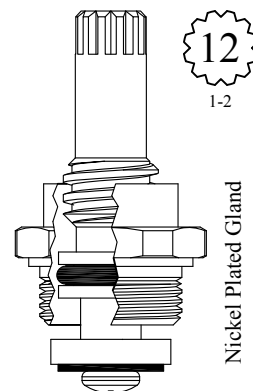

GASKET: 895100

LF457031
LF457032



SEAT USED: LF648230

FOR ARROWHEAD

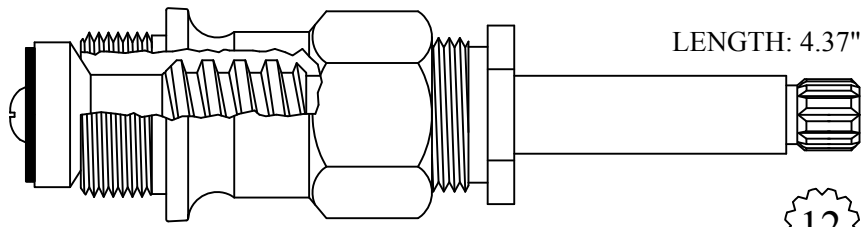

LENGTH: 4.37"

12
1-2

406411 Not Available, Use 415501

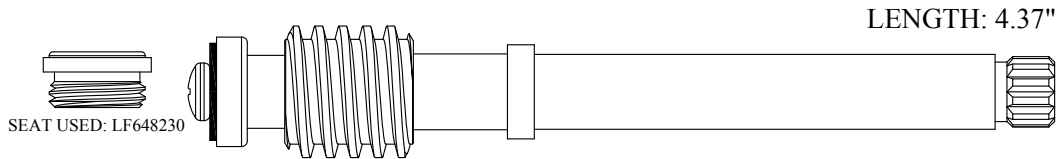

LENGTH: 4.37"

SEAT USED: LF648230

LF271101

12
1-2

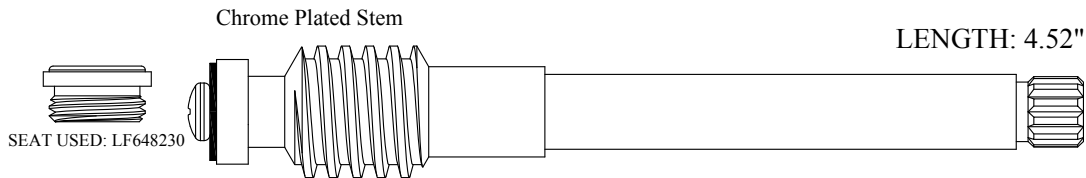

Chrome Plated Stem

LENGTH: 4.52"

SEAT USED: LF648230

LF274201

12
1-2

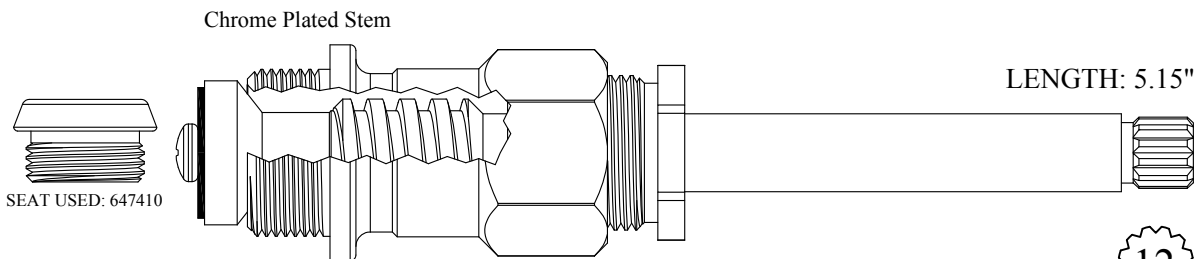

Chrome Plated Stem

LENGTH: 5.15"

SEAT USED: 647410

415501
215501 Stem Only
GASKET: 895400

12
1-2

FOR ARROWHEAD

Chrome Plated Stem

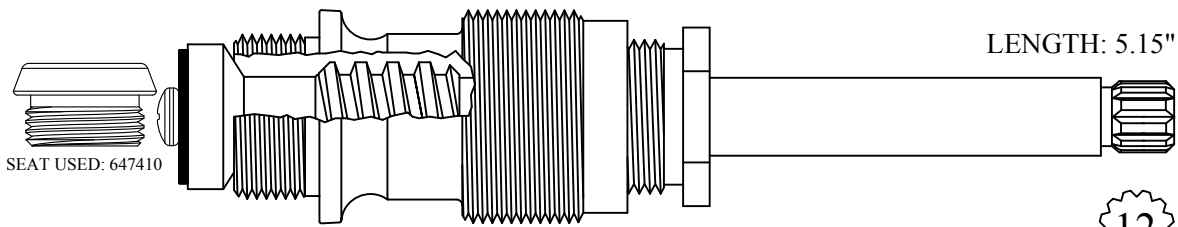

415521

215501 Stem Only

GASKET: 895400

Chrome Plated Stem

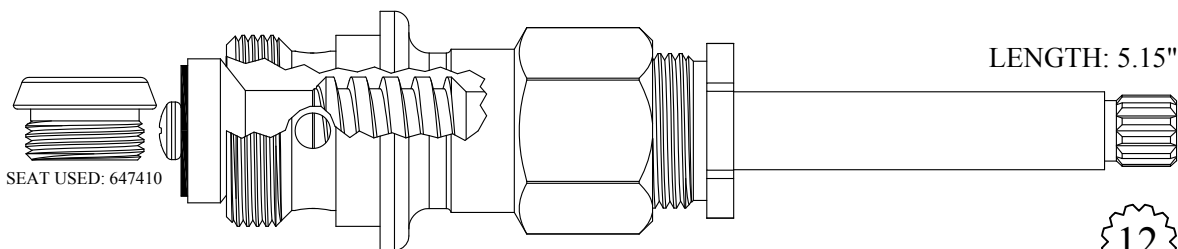

432401

215501 Stem Only

GASKET: 895550

LENGTH: 5.48"



LF280081

BARRY E.  WALTER SR. CO.

FOR ART F

Chrome Plated Stem

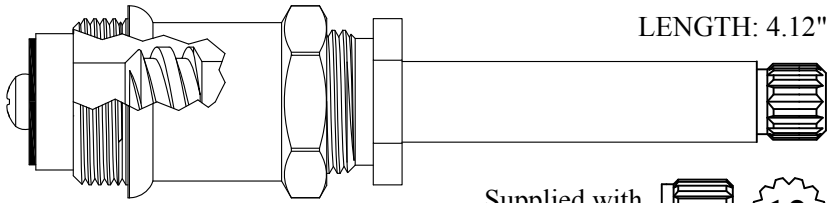

LENGTH: 4.12"

Supplied with
12pt. Broach

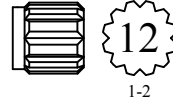

12
1-2

404661/ 404662
204661/ 204662 Stem Only
GASKET: 895400



SEAT USED: LF649430

Chrome Plated Stem

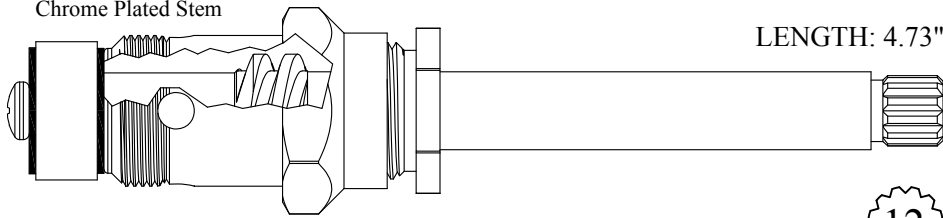

LENGTH: 4.73"

431362
GASKET: 895170

12
1-2

Chrome Plated Stem

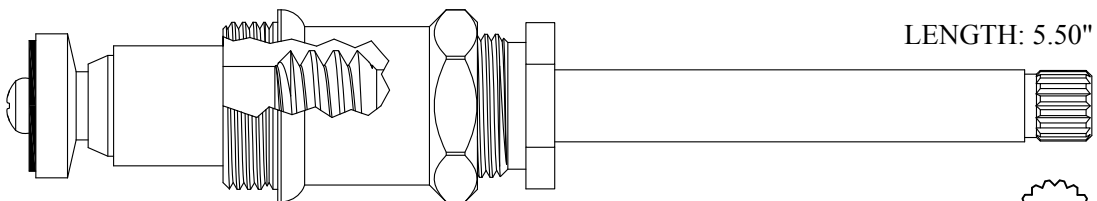

LENGTH: 5.50"

420501
220501 Stem Only
GASKET: 895400

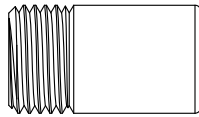

SEAT USED: 649260

16
1-6

Chrome Plated Stem

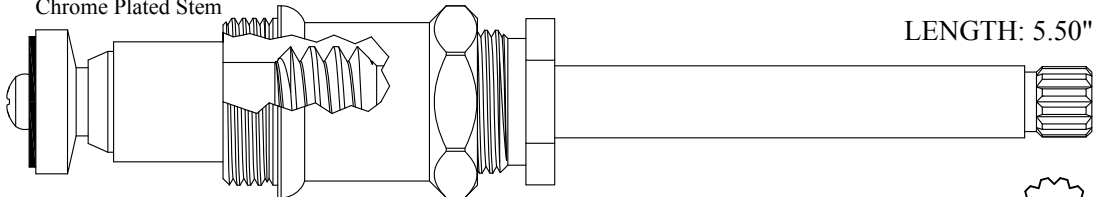

LENGTH: 5.50"

420551
220551 Stem Only
GASKET: 895400

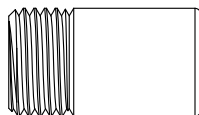

SEAT USED: 649260

12
1-2

FOR ART F

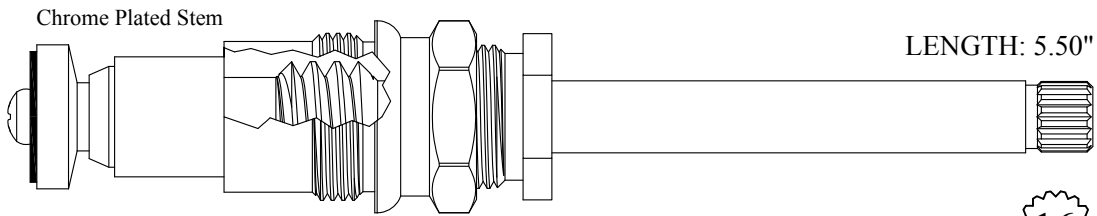

420511
220501 Stem Only
GASKET: 895400



16
1-6

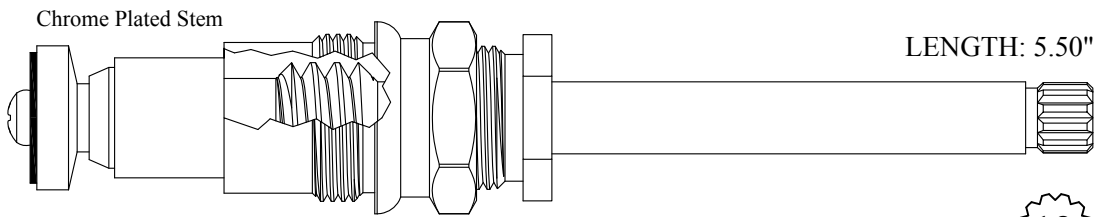

420561
220551 Stem Only
GASKET: 895400



12
1-2

Send Your Orders To:

BARRY E.  SR. CO.

E-mail: orderdesk@barrywalter.com

Fax: 1.800.886.9831

Phone: 1.800.767.5552

FOR ARTI DECO

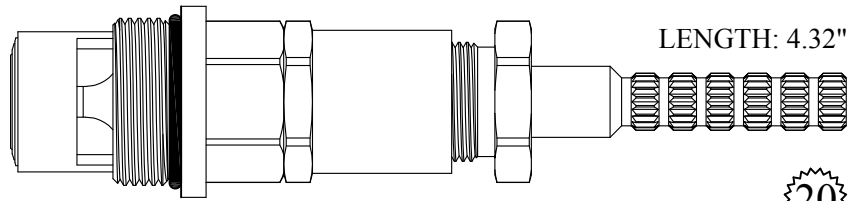

405221/ 405222

GASKET: 890170 O-RING INCLUDED
 SEAL: 898510-W
 DISC SET: 151380-PKG

20
 3-20

FOR ARTISTIC BRASS

LENGTH: 1.40"

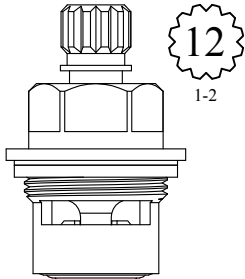

GASKET: 895100 INCLUDED
 SEAL: 898500
 DISC SET: 112530-PKG

LF450941
 LF450942

LENGTH: 1.53"

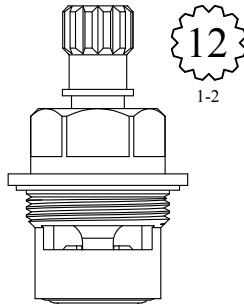

GASKET: 895100 INCLUDED
 SEAL: 898500
 DISC SET: 112530-PKG

LF451191
 LF451192

LENGTH 1.97"

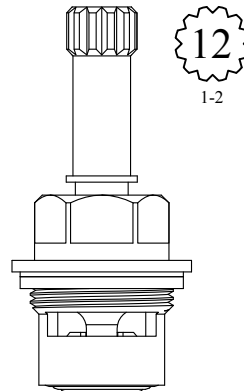

GASKET: 895100 INCLUDED
 SEAL: 898500
 DISC SET: 112530-PKG

LF458151
 LF458152

LENGTH 1.97"

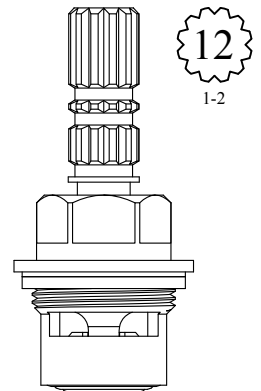

GASKET: 895100 INCLUDED
 SEAL: 898500
 DISC SET: 112530-PKG

LF458161
 LF458162

FOR ARTISTIC BRASS

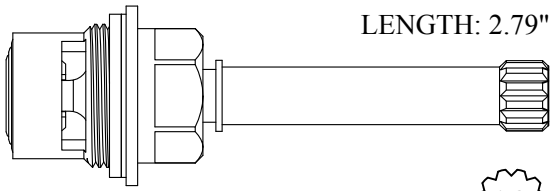

LENGTH: 2.79"

12
1-2

401661/ 401662

GASKET: 895100 INCLUDED
SEAL: 898500
DISC SET: 112530-PKG

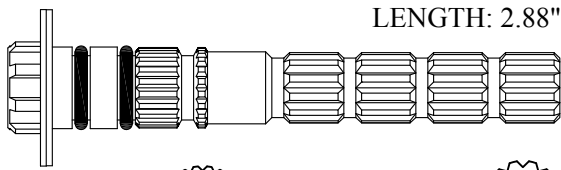

LENGTH: 2.88"

201540

20
2-4

12
1-2

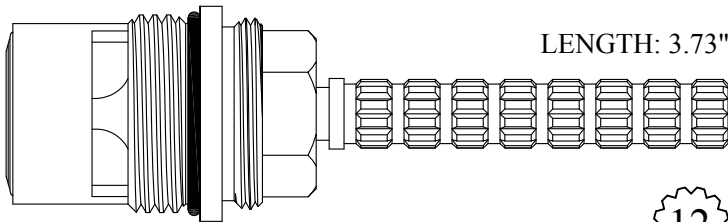

LENGTH: 3.73"

12
1-2

403041/ 403042

GASKET: 890210 O-RING INCLUDED
SEAL: 898520
DISC SET: 109850-PKG

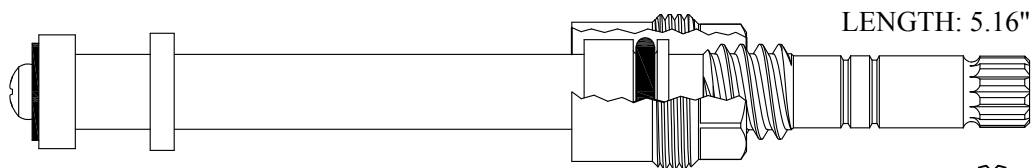

LENGTH: 5.16"

LF479501/ LF479502

GASKET: 895060



SEAT USED: LF648270

12
1-2

FOR ARTISTIC BRASS

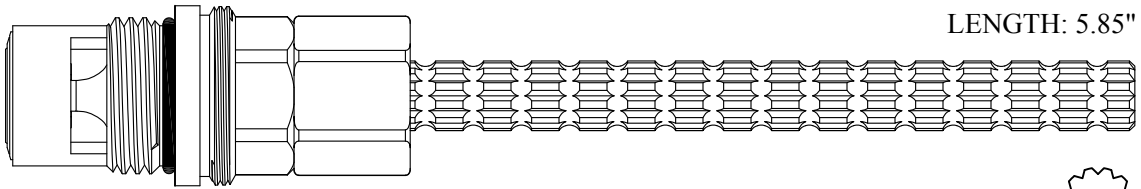

LENGTH: 5.85"

425721/ 425722

GASKET: 890170 O-RING INCLUDED
SEAL: 898510-W
DISC SET: 151380-PKG

12
1-2

Ceramic Conversion for 426911 / 426912

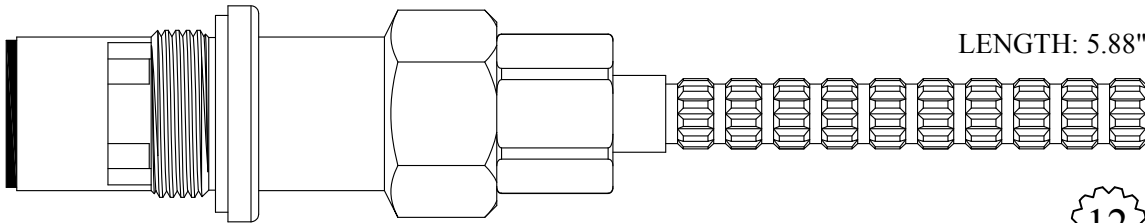

LENGTH: 5.88"

421691/ 421692

GASKET: 895390 INCLUDED
SEAL: 898550
DISC SET: 124290-PKG

12
1-2

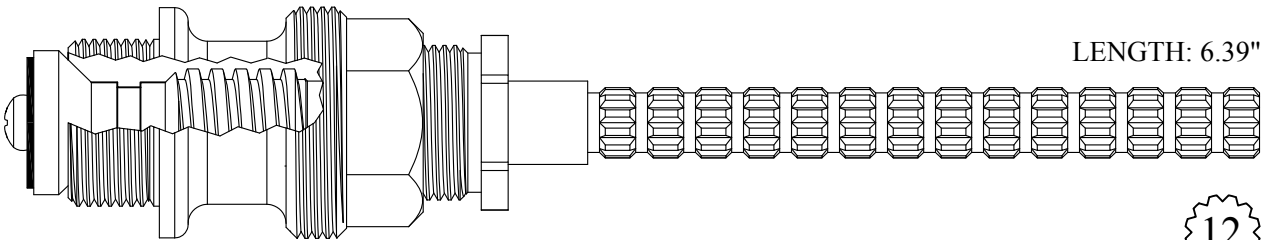

LENGTH: 6.39"

426911/ 426912

226911/ 226912 Stem Only

GASKET: 895400



SEAT USED: 648370

12
1-2

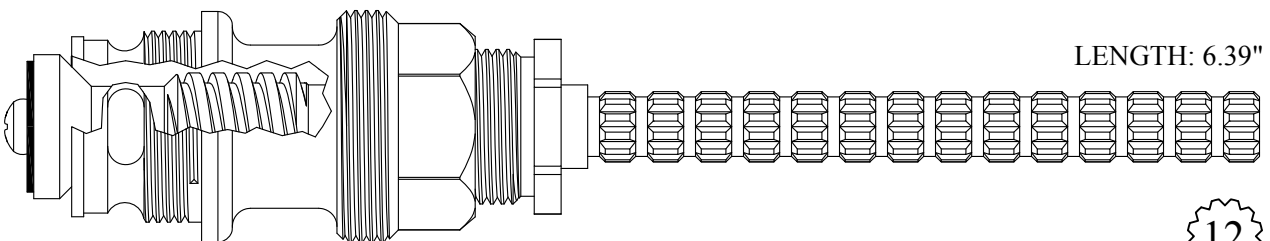

LENGTH: 6.39"

438831

238831 Stem Only

GASKET: 895550



SEAT USED: 648370

12
1-2

FOR ARTISTIC BRASS

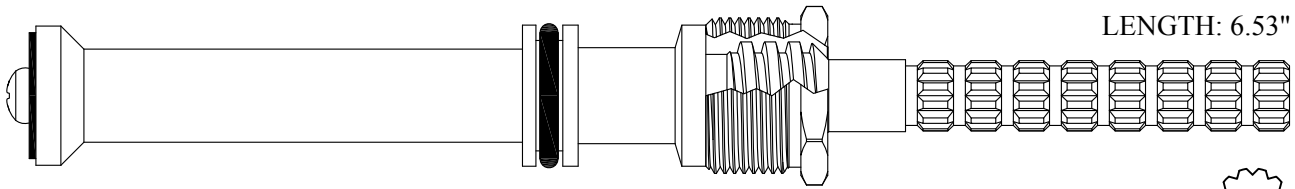

LENGTH: 6.53"

426941/ 426942



SEAT USED: LF648270

12
1-2

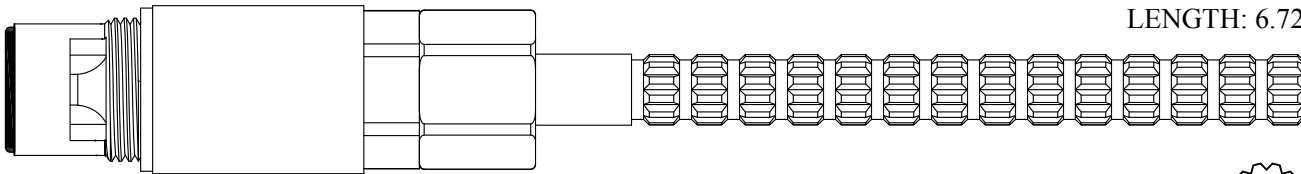

LENGTH: 6.72

427301/ 427302

GASKET: 895100 INCLUDED
SEAL: 898540
DISC SET: 112530-PKG

Also available with
16pt Harden Broach
427331 / 427332

16
3-16

12
1-2

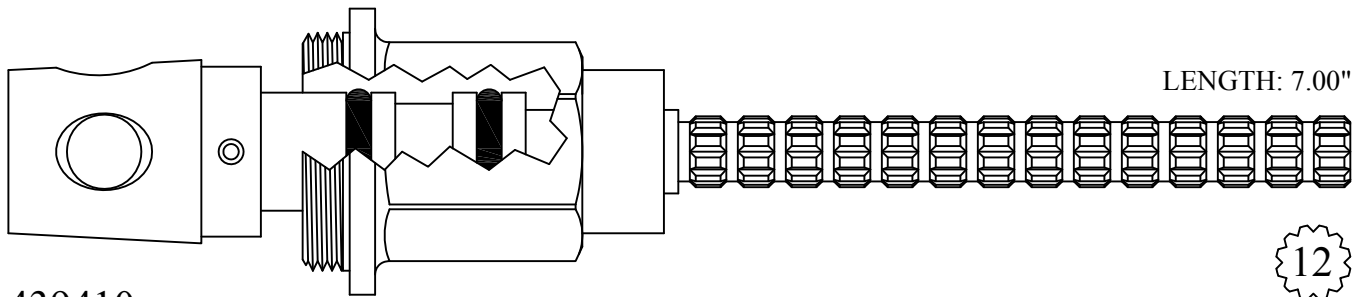

LENGTH: 7.00"

439410

239410 Stem Only

12
1-2

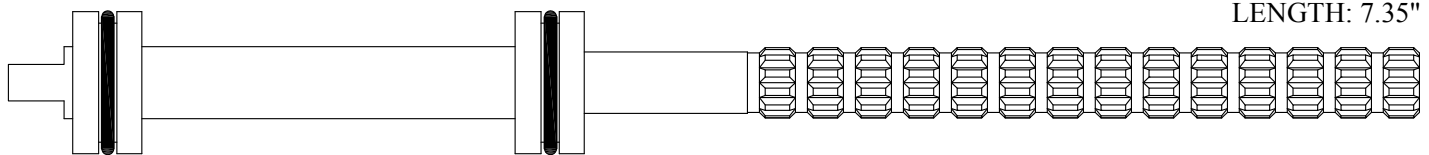

LENGTH: 7.35"

239690

12
1-2

FOR ATLAS

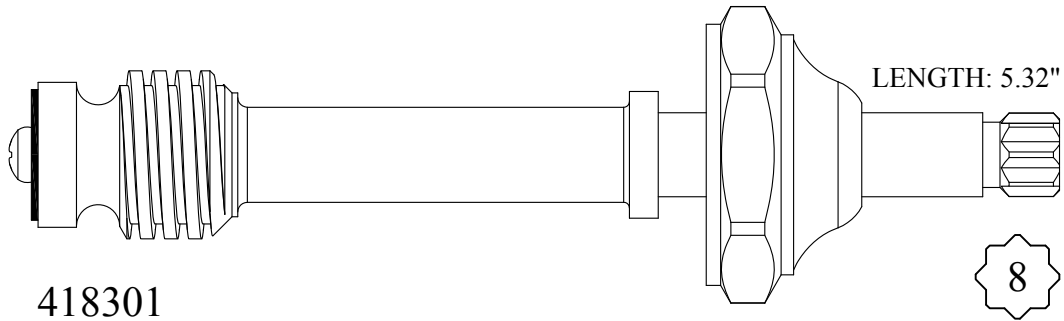

418301
218301 Stem Only

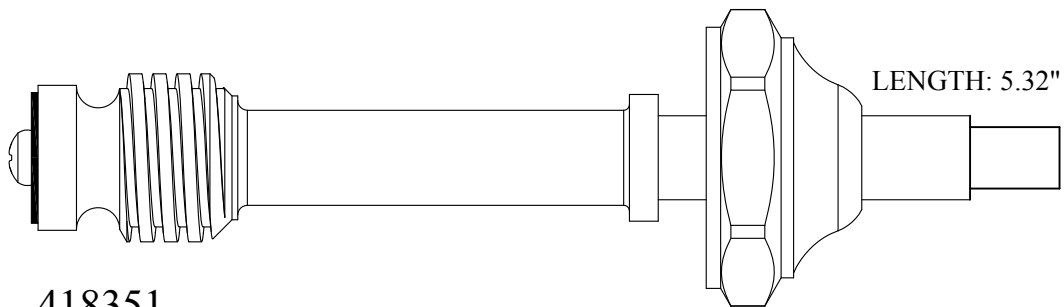

418351
218351 Stem Only

Supplied with
12pt. Broach



12
1-2

Send Your Orders To:

BARRY E.  ALTER  SR. CO.

E-mail: orderdesk@barrywalter.com

Fax: 1.800.886.9831

Phone: 1.800.767.5552

*We are always adding
new parts. Check our
website for updates.*

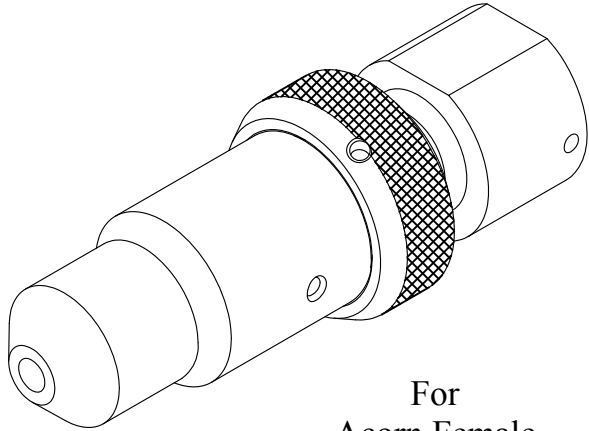

For
Acorn Female
OEM# 1174-001-001
123100: 2.5 GPM

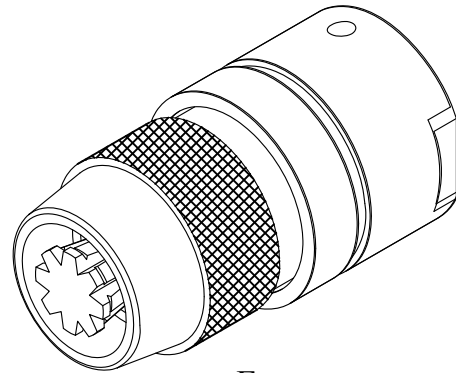

For
Symmons "Free-Flo" Rigid
OEM# 4-285F
112620: 2.5 GPM

MORE SHOWERHEADS AVAILABLE ONLINE

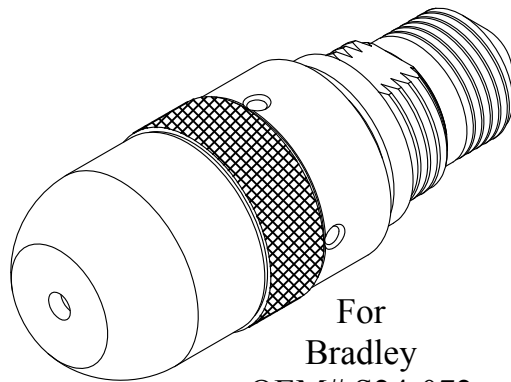

For
Bradley
OEM# S24-072
112450: 1.5 GPM
112130: 2.5 GPM
122380: 3.0 GPM

BARRY E.  ALTER  SR. CO.

Send Your Orders To:

BARRY E.  SR. CO.

E-mail: orderdesk@barrywalter.com

Fax: 1.800.886.9831

Phone: 1.800.767.5552



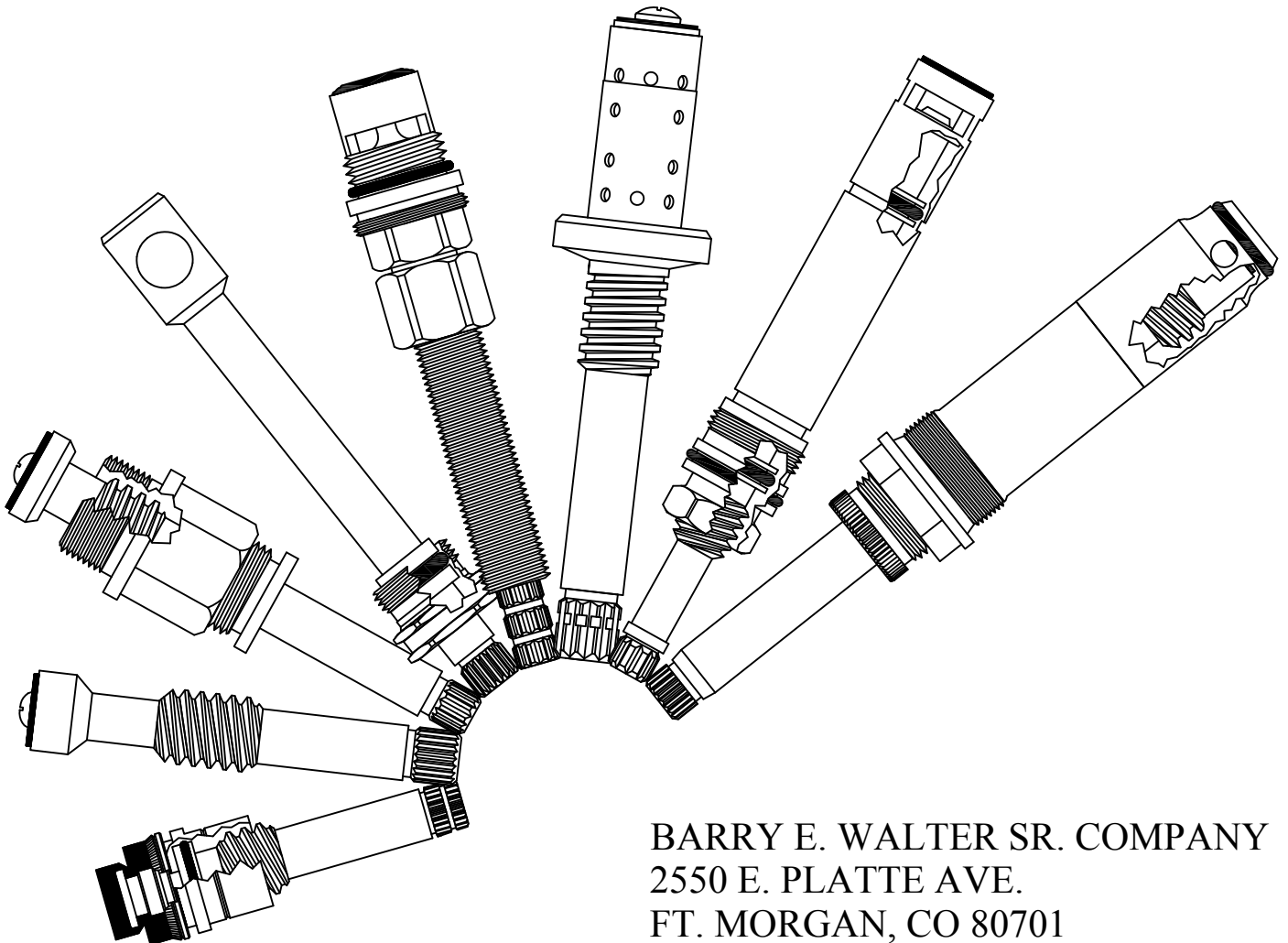

Quality Replacement Parts

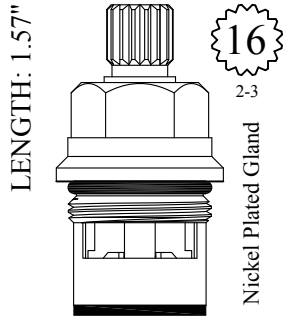

BARRY E. WALTER SR. COMPANY
2550 E. PLATTE AVE.
FT. MORGAN, CO 80701

FOR AUBURN BRASS



GASKET: 890160 O-RING INCLUDED
SEAL: 893030
DISC SET: 151380-PKG

LF450901
LF450902

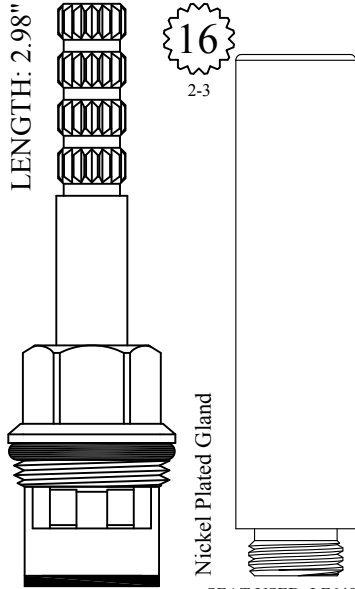

GASKET: 890160 O-RING INCLUDED
DISC SET: 151380-PKG

LF465451
LF465452

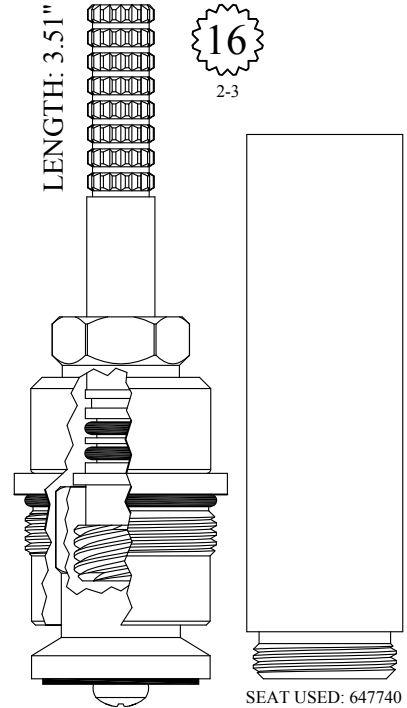

GASKET: 890200 O-RING INCLUDED

403021
403022

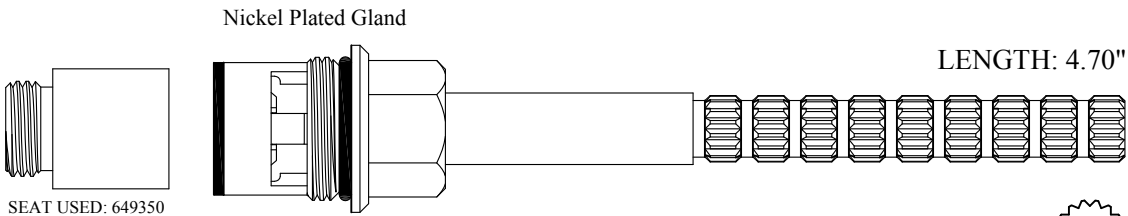

SEAT USED: 649350

404831/ 404832

GASKET: 890160 O-RING INCLUDED
DISC SET: 151380-PKG

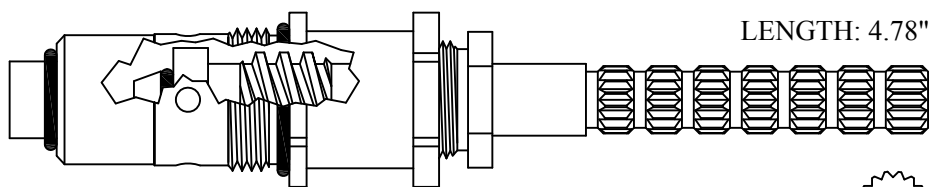

409921/ 409922

GASKET: 890160 O-RING INCLUDED

FOR AUBURN BRASS

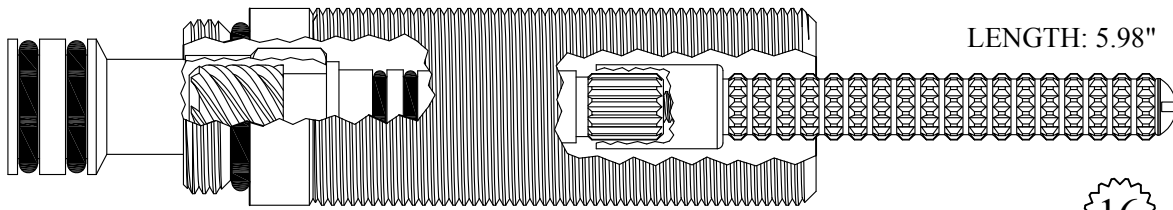

LENGTH: 5.98"

437611

GASKET: 891150 O-RING INCLUDED

16

2-3

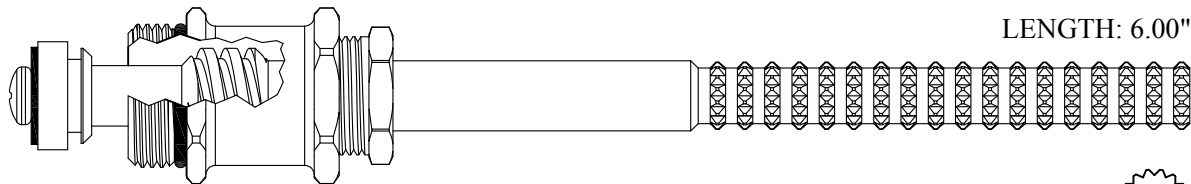

LENGTH: 6.00"

425811/ 425812

225811/ 225812 Stem Only

GASKET: 891150 O-RING INCLUDED



SEAT USED: LF647450

16

2-3

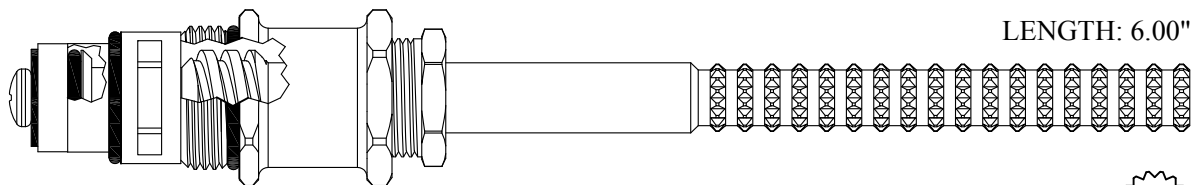

LENGTH: 6.00"

436611

225811 Stem Only

GASKET: 891150 O-RING INCLUDED



SEAT USED: LF647450

16

2-3

Nickel Plated Gland

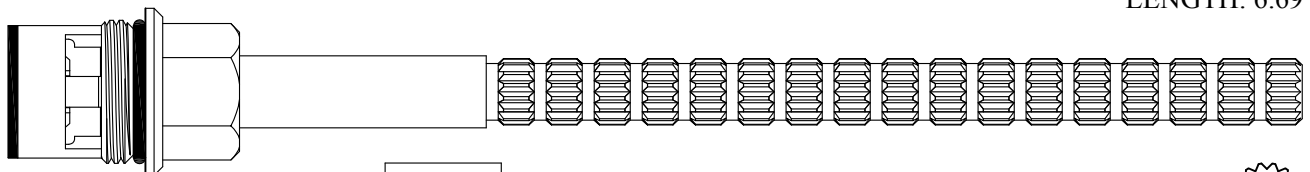

LENGTH: 6.69"

427601/ 427602

GASKET: 890160 O-RING INCLUDED

DISC SET: 151380-PKG

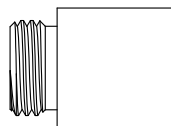

SEAT USED: 649350

16

2-3

FOR AVILION

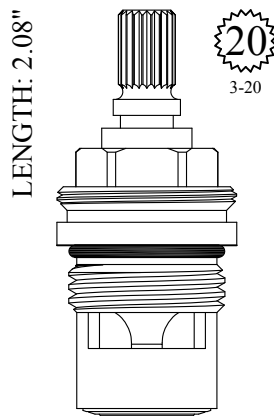

GASKET: 890170 O-RING INCLUDED
SEAL: 898510-W
DISC SET: 151380-PKG

LF459491
LF459492

FOR A.Y. McDONALD

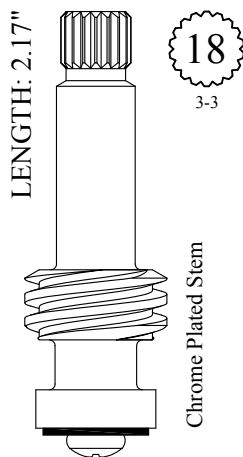

LF261161
LF261162

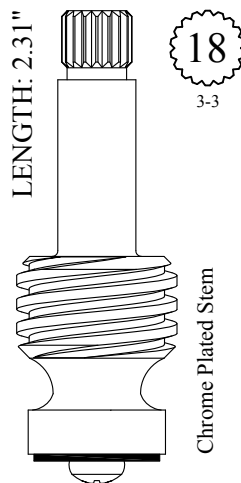

LF262341
LF262342

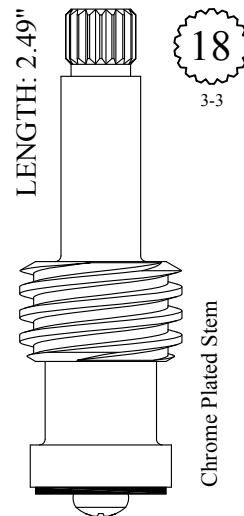

LF264281
LF264282

FOR A.Y. McDONALD

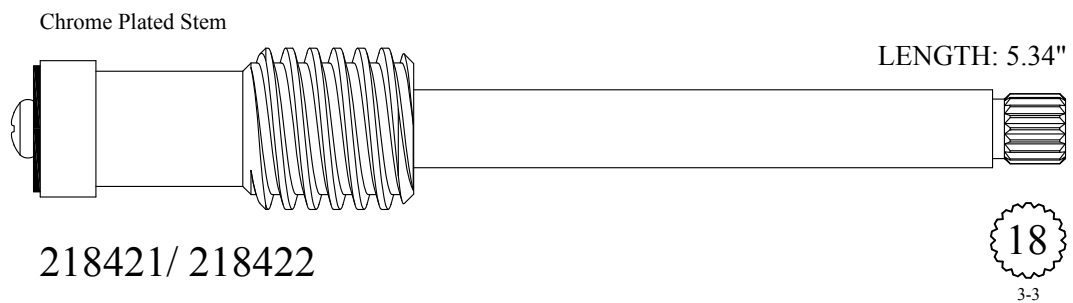
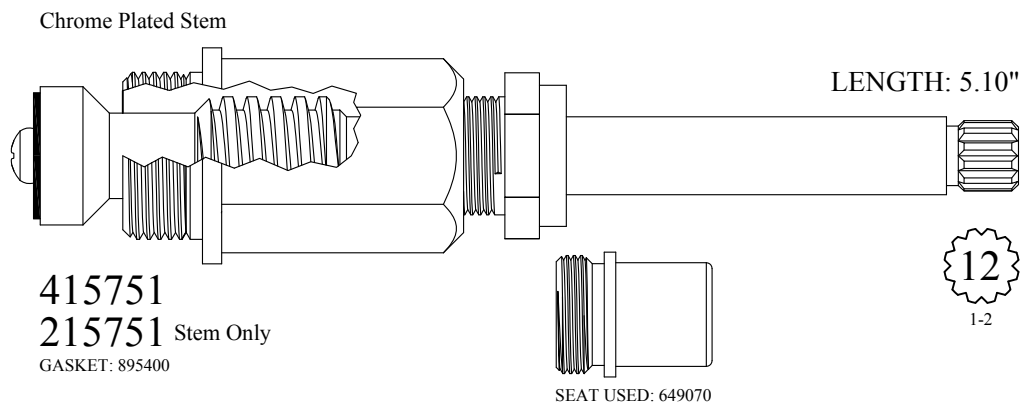
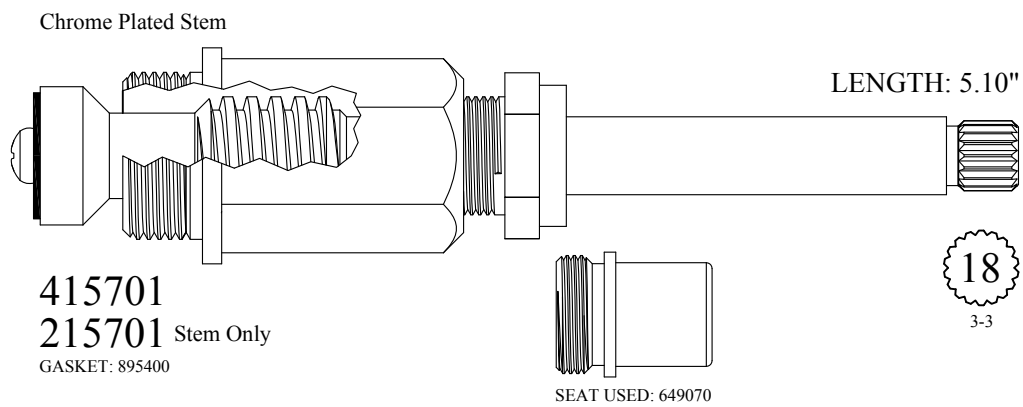
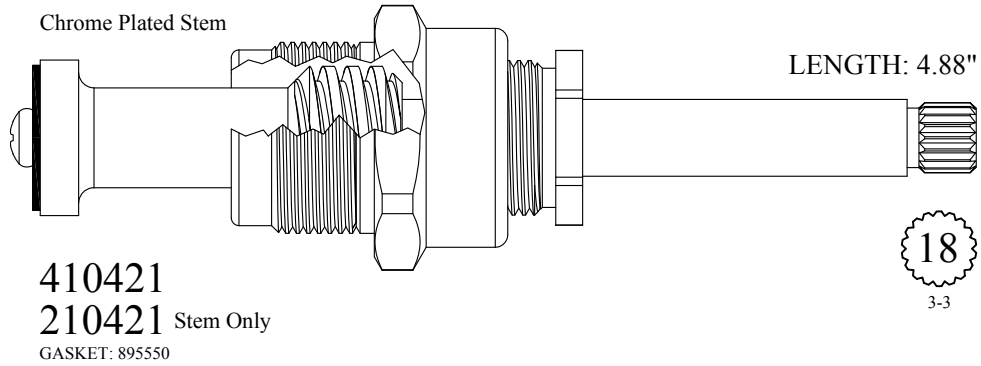

FOR BALOCCHI

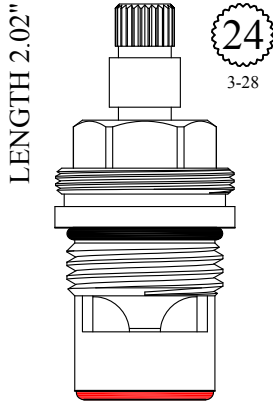

GASKET: 890170 O-RING INCLUDED
SEAL: 898570-R/B
DISC SET: 151380-PKG

LF459341
LF459342

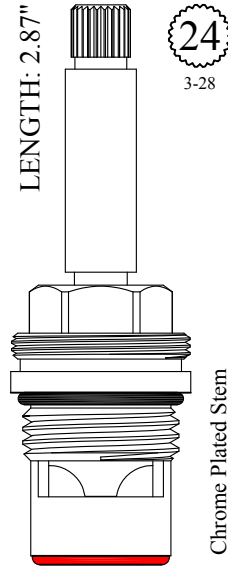

GASKET: 890170 O-RING INCLUDED
SEAL: 898570-R/B
DISC SET: 151380-PKG

LF465341
LF465342

FOR BARBER WILSON

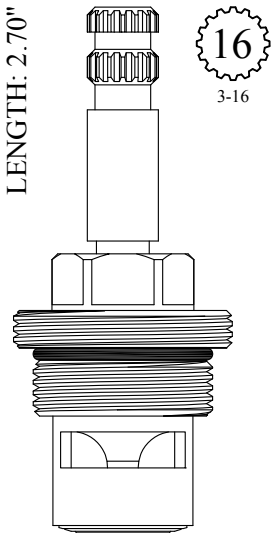

GASKET: 890190 O-RING INCLUDED
SEAL: 898510-W
DISC SET: 151380-PKG

LF464571
LF464572

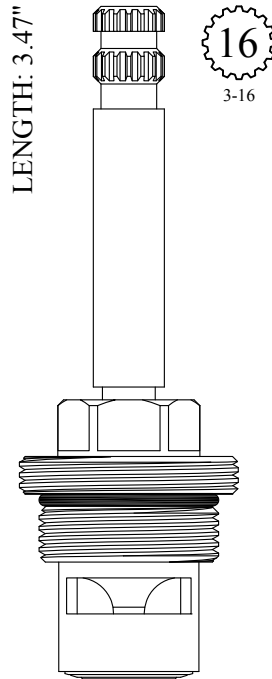

GASKET: 890190 O-RING INCLUDED
SEAL: 898510-W
DISC SET: 151380-PKG

LF468571
LF468572

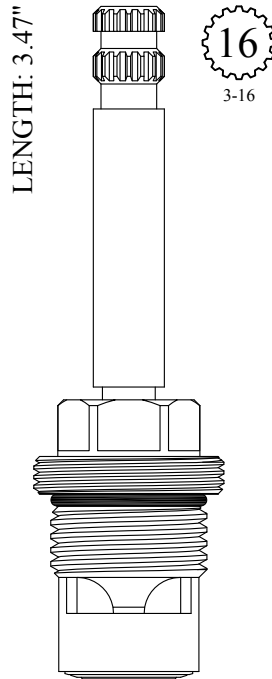

GASKET: 890170 O-RING INCLUDED
SEAL: 898510-W
DISC SET: 151380-PKG

LF468581
LF468582

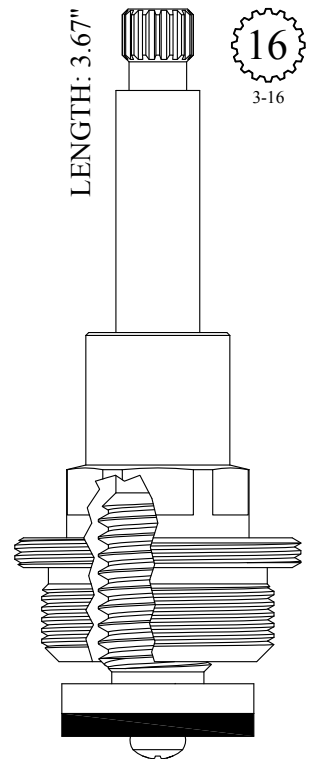

404541

FOR BARDES

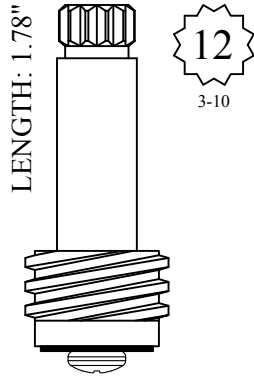

LF254001
LF254002

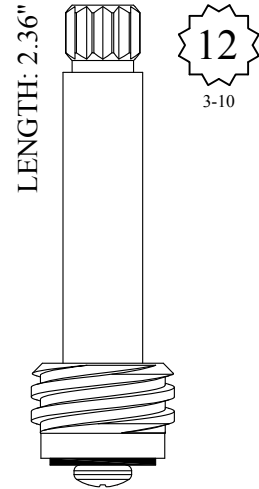

LF264241
LF264242

FOR BARNES

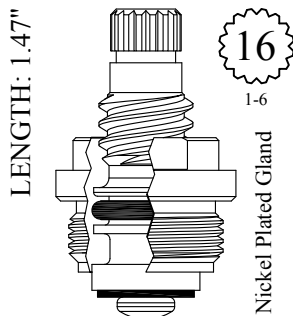

GASKET: 895100

LF452051
LF452052



SEAT USED: LF648350

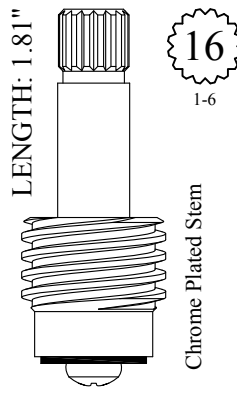

LF260131
LF260132



SEAT USED: LF648350

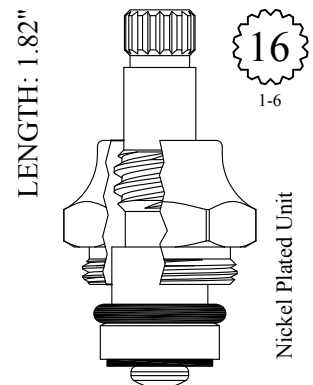

LF456051
LF456052



SEAT USED: LF648350

FOR BARNES

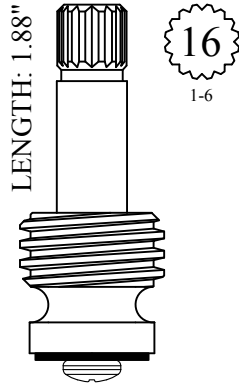

LF256101
LF256102



SEAT USED: LF648350

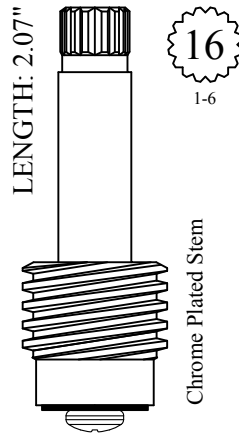

LF263101
LF263102

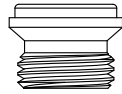

SEAT USED: LF648350

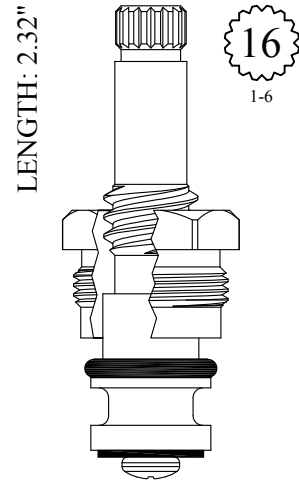

LF462061



SEAT USED: LF648350

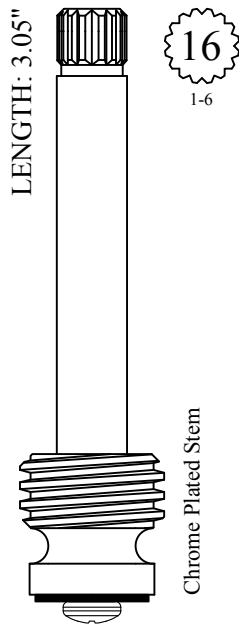

LF266121
LF266122

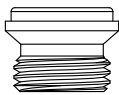

SEAT USED: LF648350

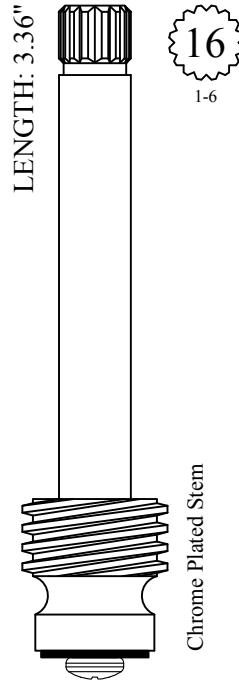

LF269121
LF269122

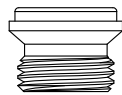

SEAT USED: LF648350

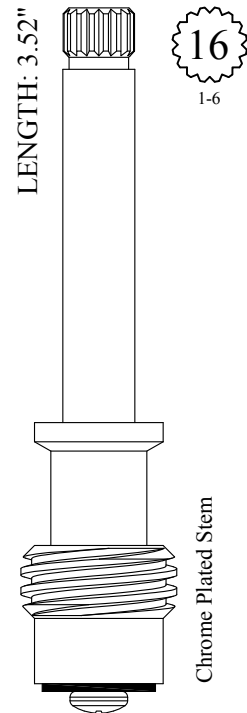

LF268001
LF268002



SEAT USED: LF648350

FOR BARNES

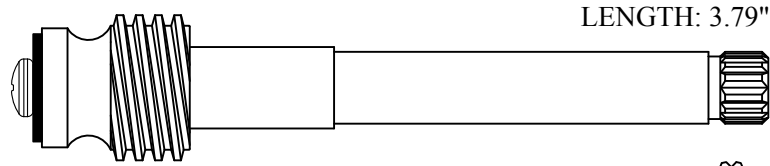

LF268141/ LF268142

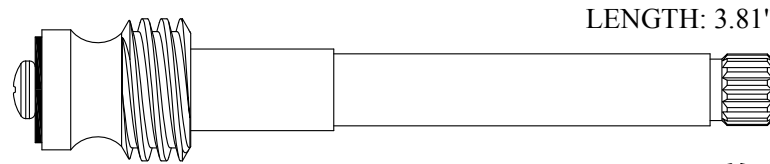

LF269061/ LF269062

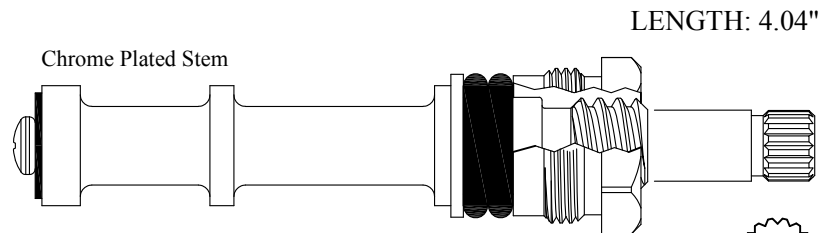

403711
203711 Stem Only

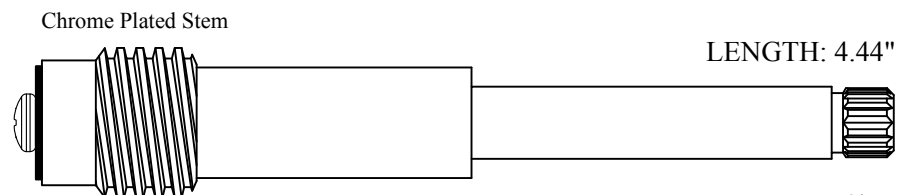

LF271031/ LF271032



FOR BARNES

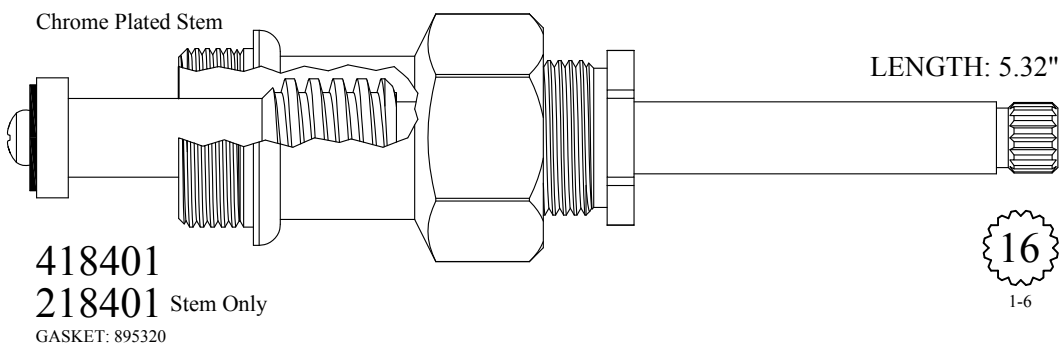
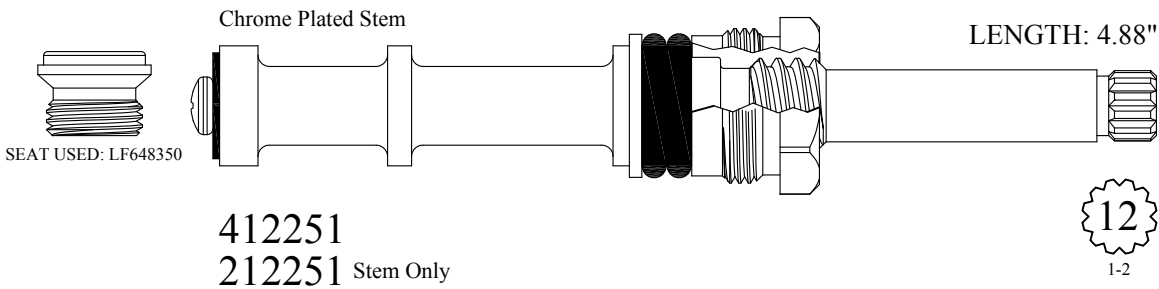
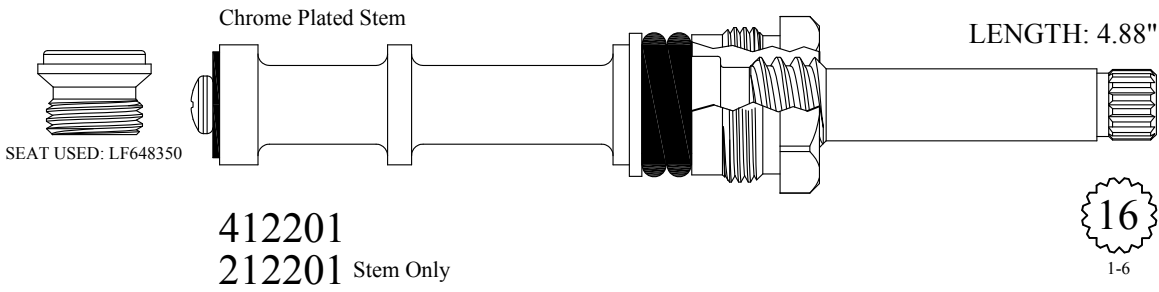
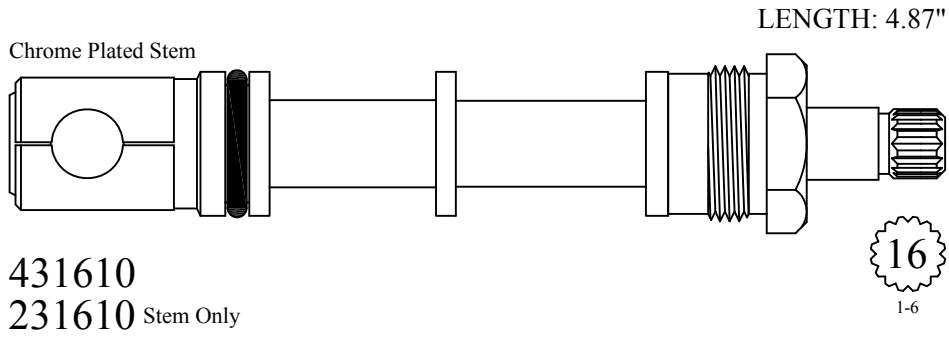

FOR BARNES

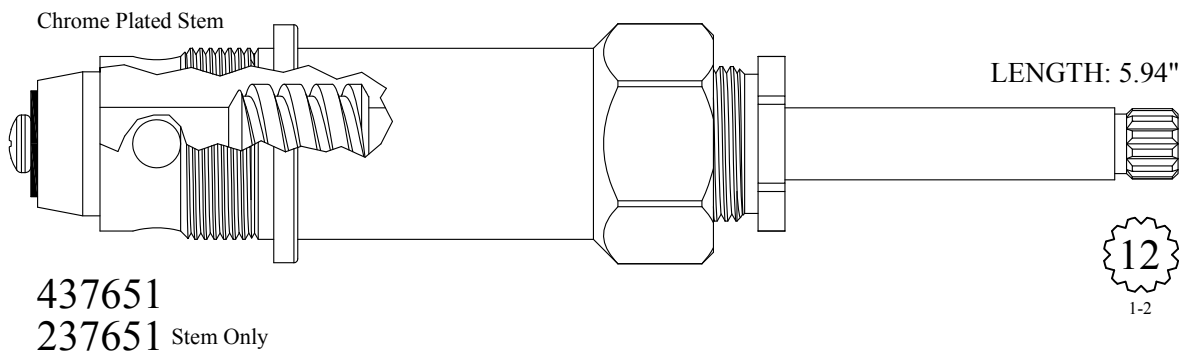
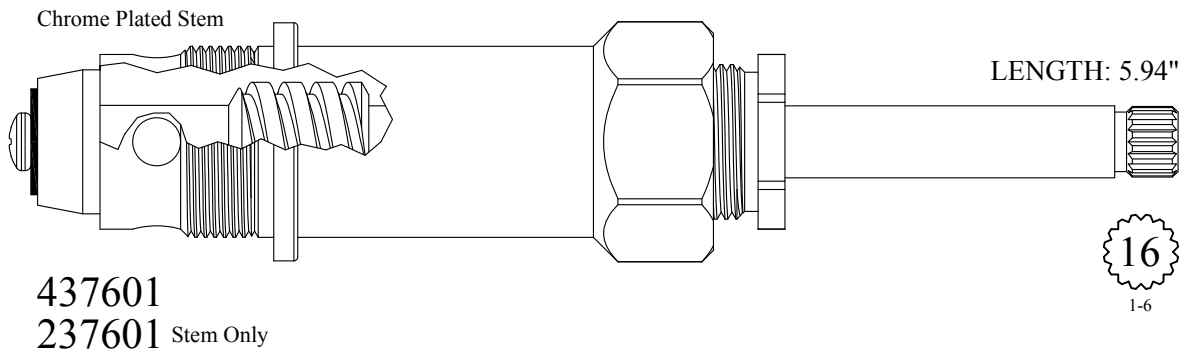
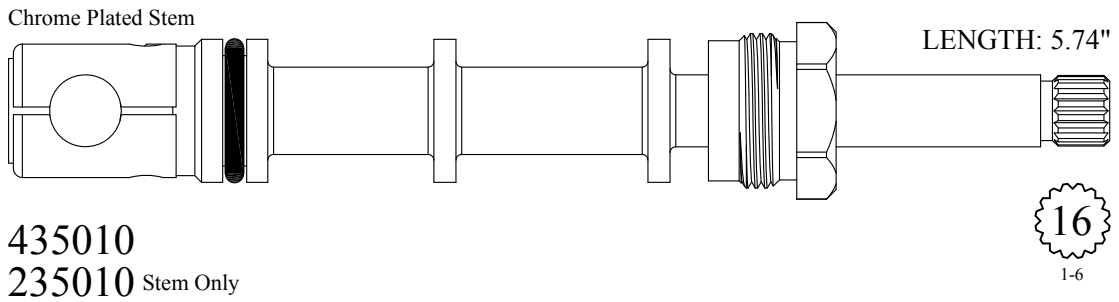
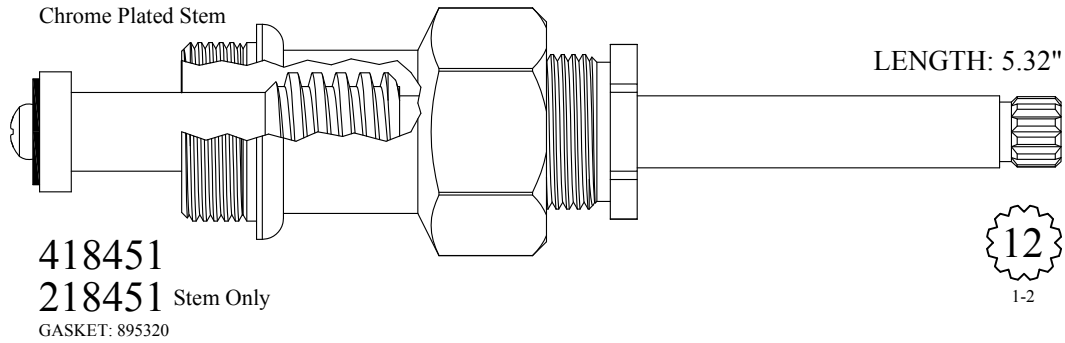

FOR BEAR BRAND

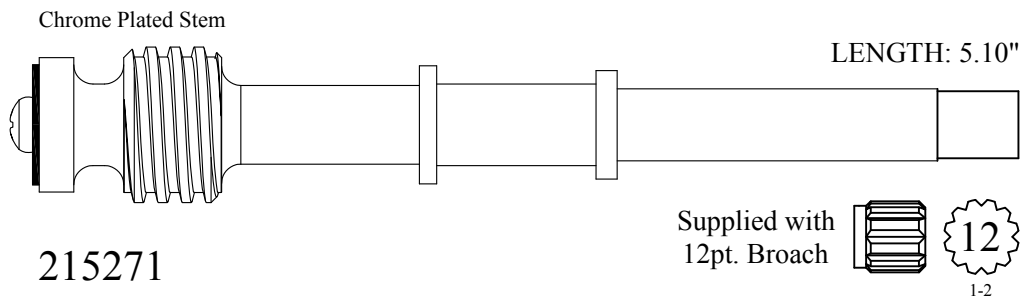
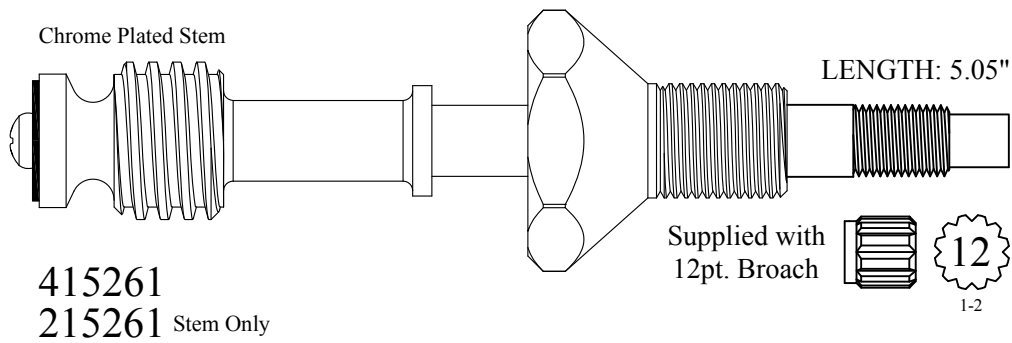
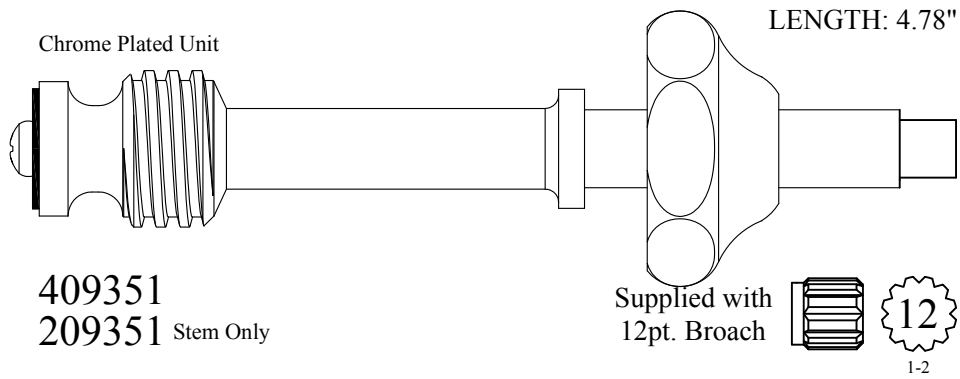

BARRY E.  WALTER  SR. CO.

FOR BELMONT

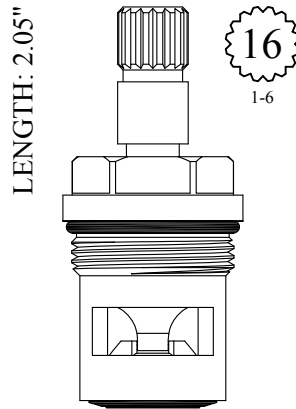

GASKET: 890170 O-RING INCLUDED
SEAL: 898510
DISC SET: 151380-PKG

LF459261
LF459262

FOR BELVEDERE

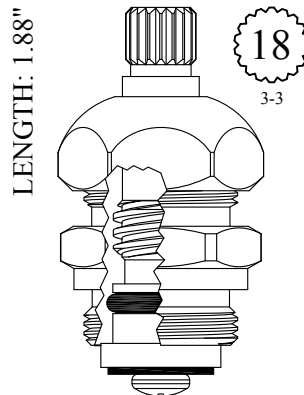

GASKET: 895150

LF456131
LF456132

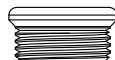

SEAT USED: LF648500

FOR BLOCK BRASS

Chrome Plated Stem

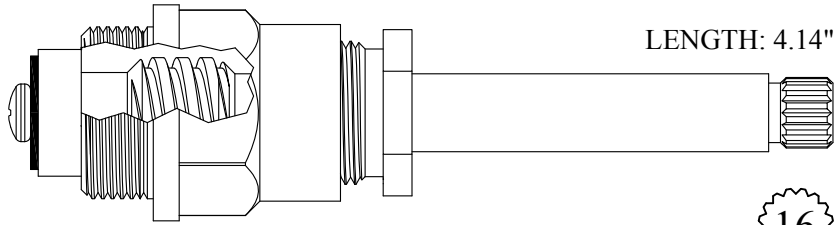

16
1-6

404701/ 404702
204701/ 204702 Stem Only
GASKET: 895290

Chrome Plated Stem

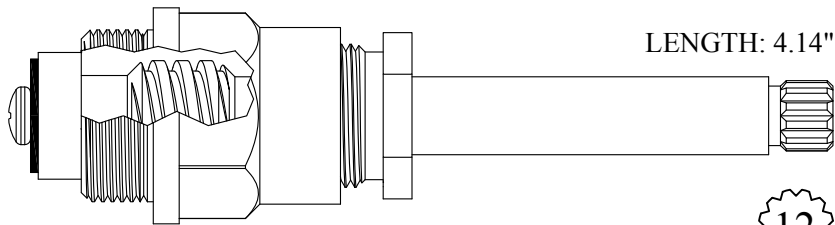

12
1-2

404751/ 404752
204751/ 204752 Stem Only
GASKET: 895290

Chrome Plated Stem

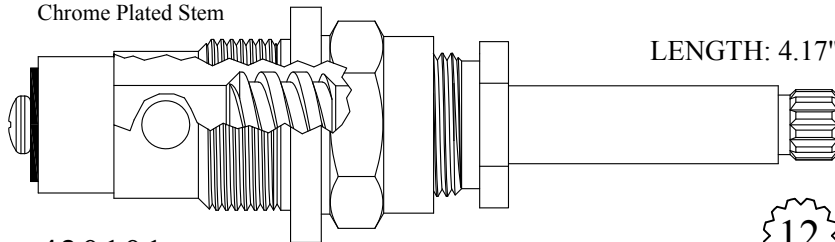

12
1-2

430101
230101 Stem Only
GASKET: 895290

Chrome Plated Stem

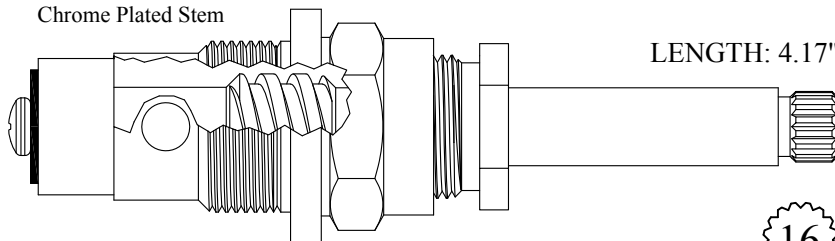

16
1-6

430211
230211 Stem Only
GASKET: 895290

FOR BLOCK BRASS

Chrome Plated Stem

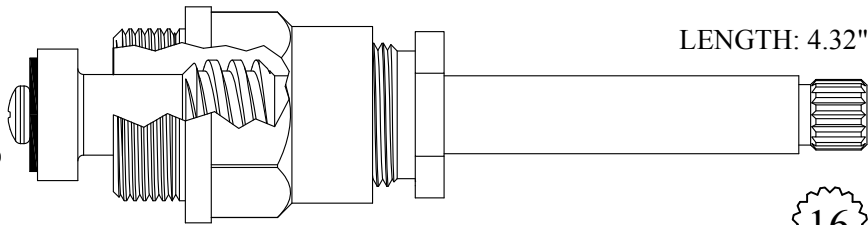

LENGTH: 4.32"

405801
205801 Stem Only
 GASKET: 895290



Chrome Plated Stem

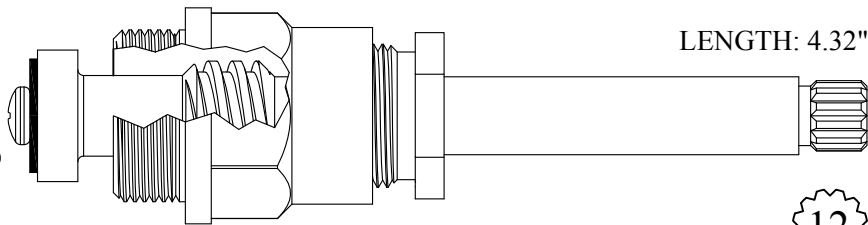

LENGTH: 4.32"

405851
205851 Stem Only
 GASKET: 895290



Chrome Plated Stem

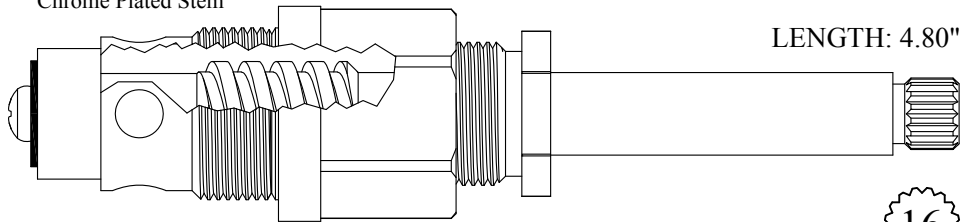

LENGTH: 4.80"

431041
231041 Stem Only
 GASKET: 895290



Chrome Plated Unit

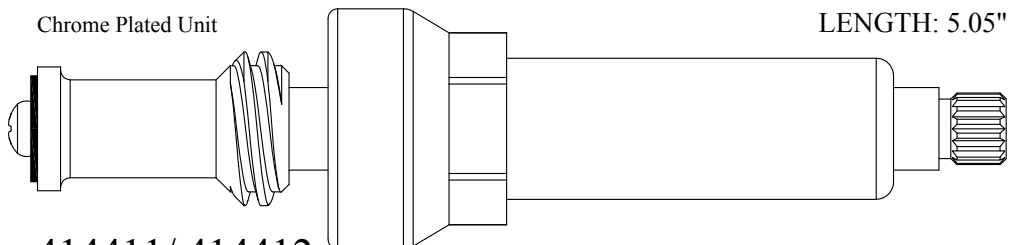

LENGTH: 5.05"

414411/ 414412
214411/ 214412 Stem Only

FOR BLOCK BRASS

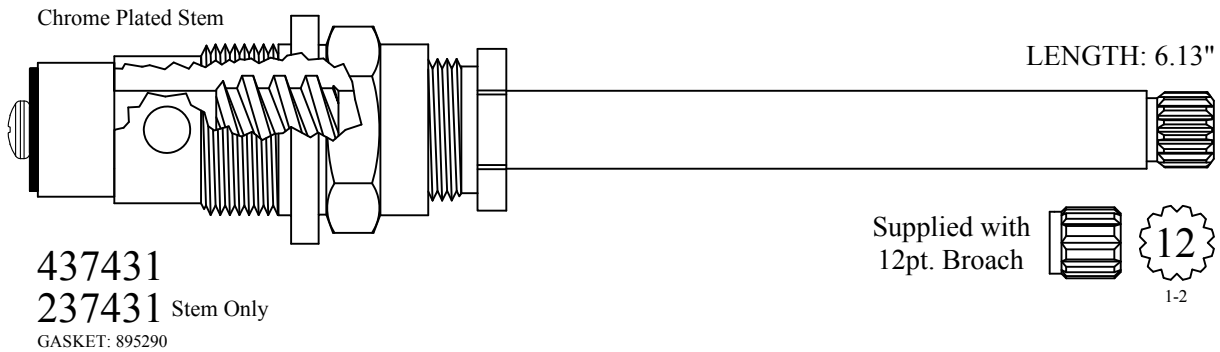

Send Your Orders To:

BARRY E.  WALTER  SR. CO.

E-mail: orderdesk@barrywalter.com

Fax: 1.800.886.9831

Phone: 1.800.767.5552

FOR BORG-WARNER

LENGTH: 1.56"
Chrome Plated Stem

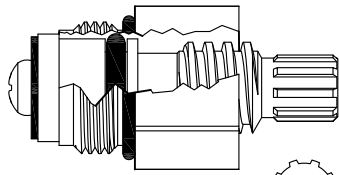

9

LF452861

GASKET: 890160 O-RING INCLUDED

LENGTH: 2.09"

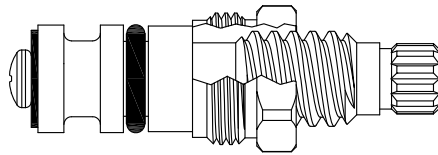

12
1-2

LF459091/ LF459092

LENGTH: 4.19"

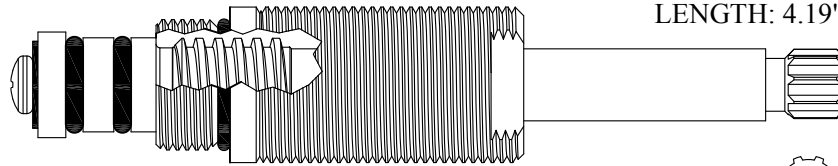

9

405011

LENGTH: 4.23"

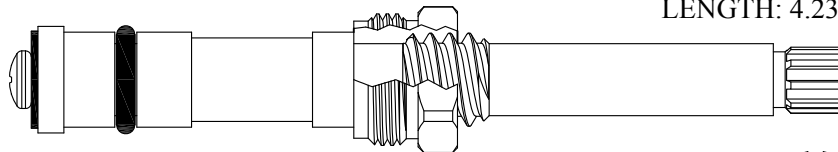

9

LF470801

LENGTH: 4.38"

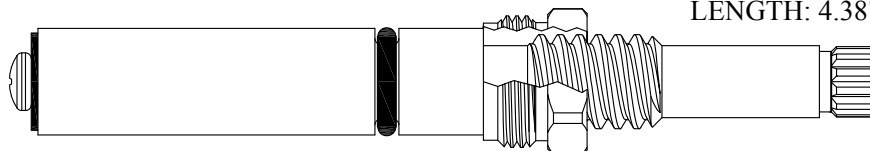

12
1-2

406311/ 406312

FOR BRADLEY

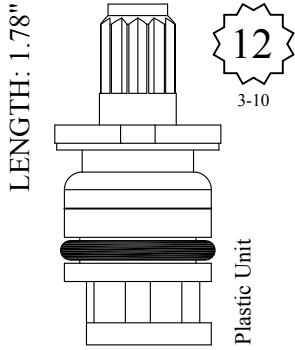

453201

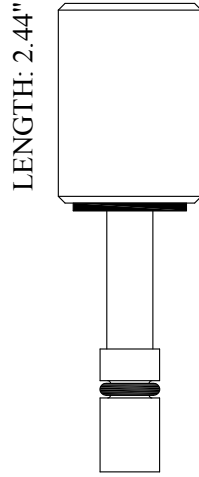

LF173770

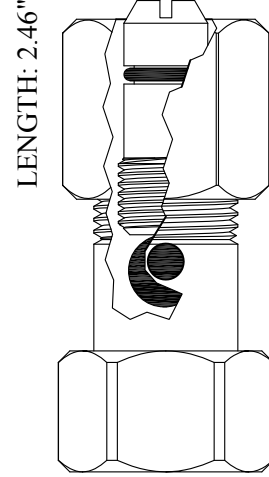

GASKET: 895100 INCLUDED

LF126480

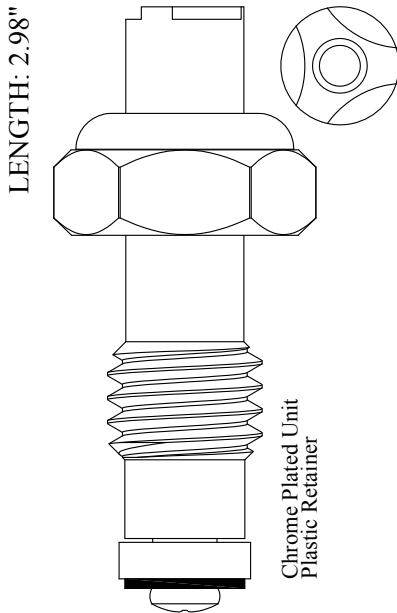

401731
201731 Stem Only

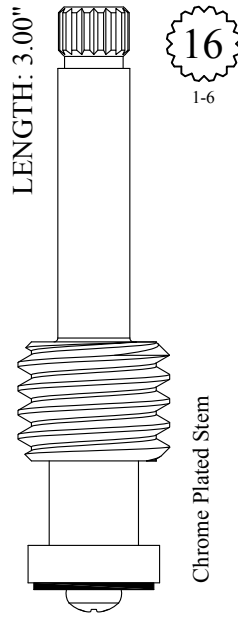

201841

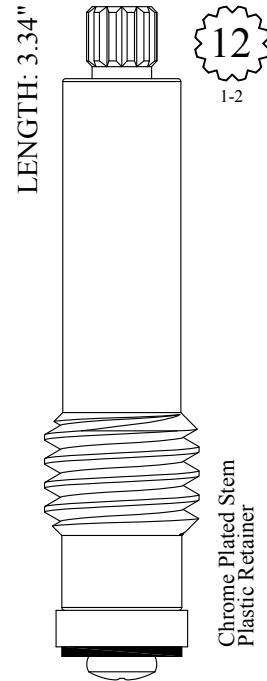

201771

FOR BRADLEY

Chrome Plated Stem

LENGTH: 3.38"

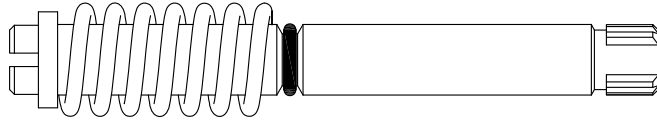

202690

Special 12pt Broach w/
2 splines missing on each
side to make an 8pt Broach

8

LENGTH: 4.50"

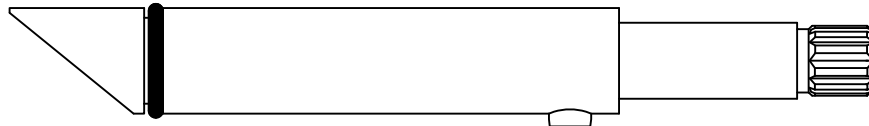

230620

12
3-10

LENGTH: 4.51"

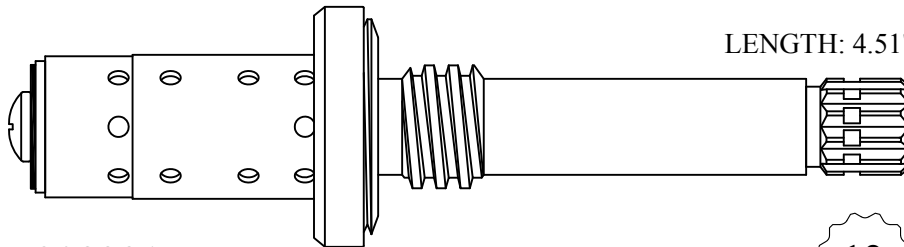

208331

12

LENGTH: 4.90"

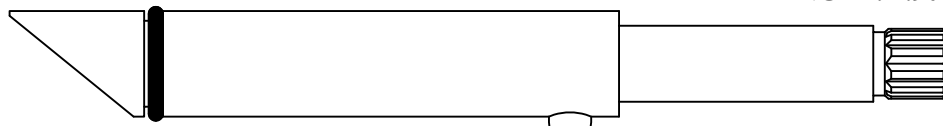

231530

12
3-10

FOR BRASSCRAFT

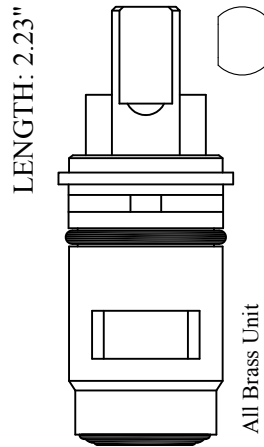

SEAL: 898510
 DISC SET: 124290-PKG
LF460721

FOR BRIGGS

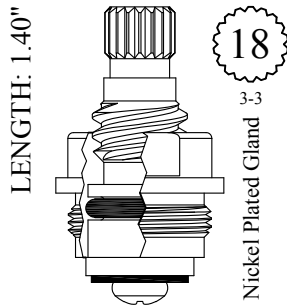

GASKET: 895100

LF452031
LF452032

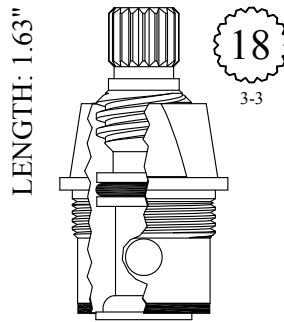

GASKET: 895100

LF453031
LF453032

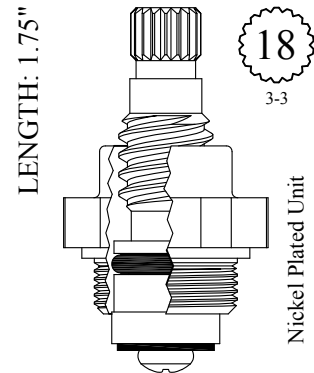

GASKET: 895100

LF454101
LF454102

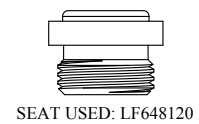

FOR BRIGGS

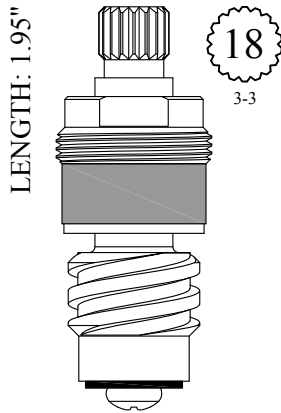

LF457131
 LF457132
 LF257131 Stem Only
 LF257132 Stem Only

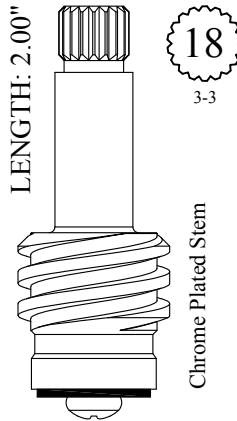
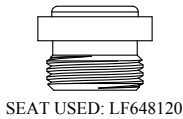

LF255181
 LF255182

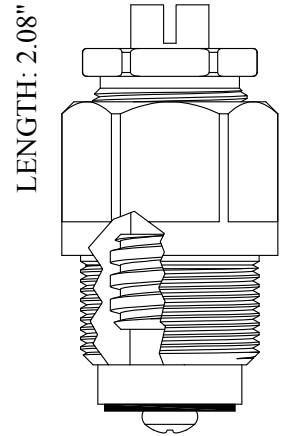

GASKET: 895370

401461
 201461 Stem Only

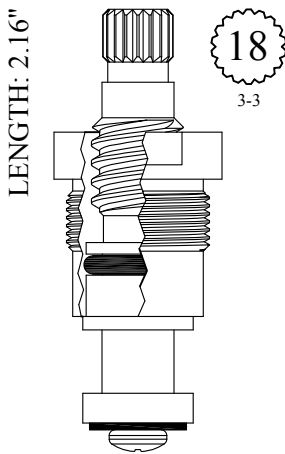
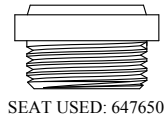

GASKET: 895100

LF461011
 LF461012

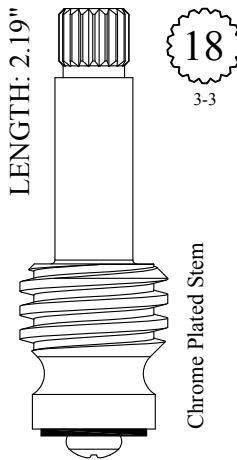

201221

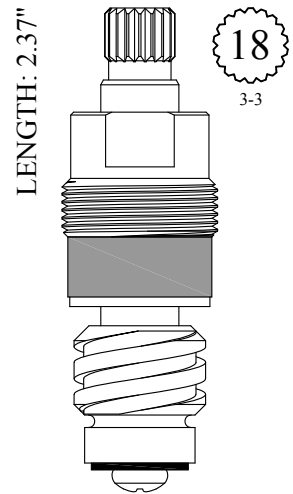

LF463111
 LF463112
 LF263111 Stem Only
 LF263112 Stem Only

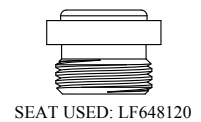

FOR BRIGGS

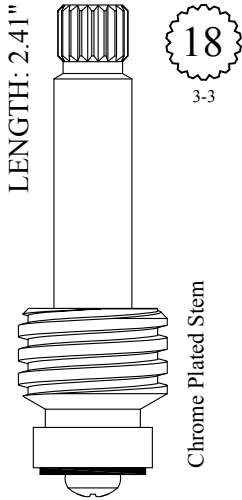

201231

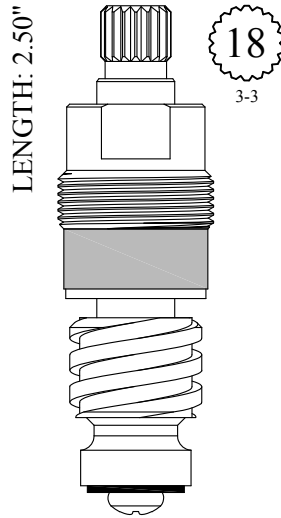

LF464031
 LF464032
 LF264031 Stem Only
 LF264032 Stem Only

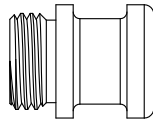

SEAT USED: LF648250

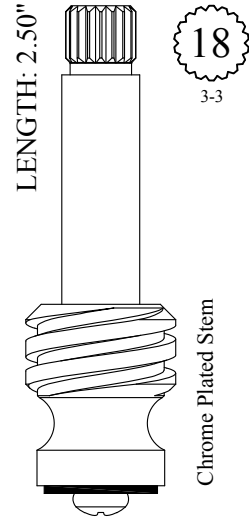

LF263161
 LF263162

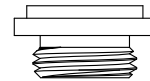

SEAT USED: LF648950

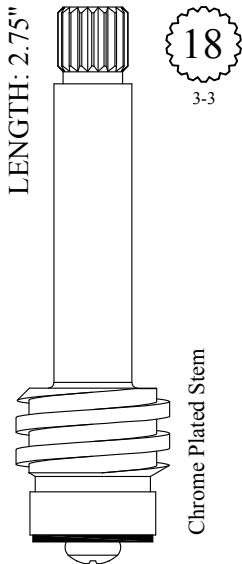

LF265201

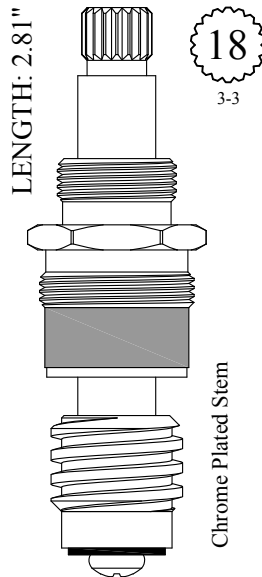

LF465271
 LF265271 Stem Only

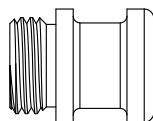

SEAT USED: LF648250

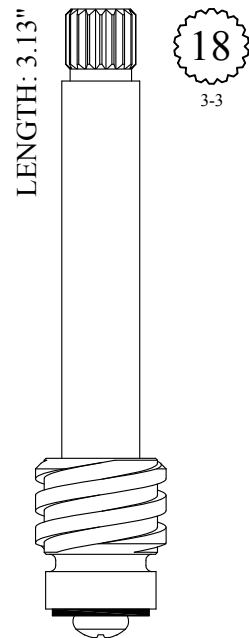

LF267061
 LF267062

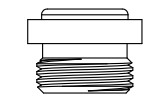

SEAT USED: LF648120

FOR BRIGGS

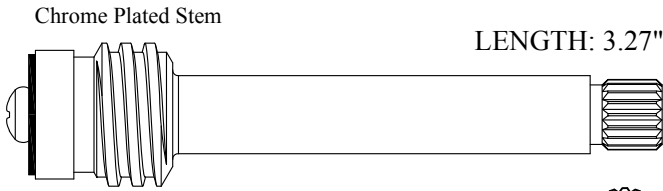

LF267121

18
3-3

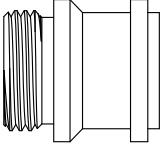

SEAT USED: 648630

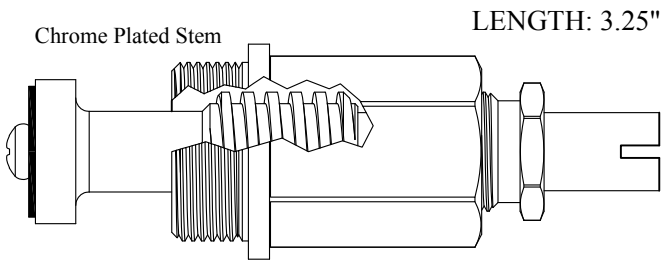

402611
202611 Stem Only
GASKET: 895370

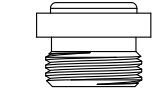

SEAT USED: LF648120

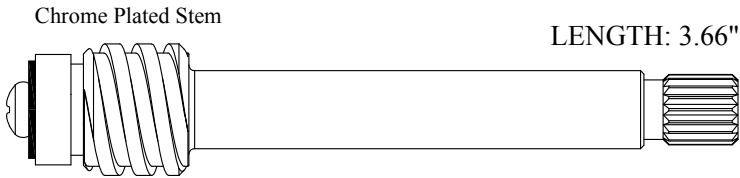

LF269151/ LF269152

18
3-3

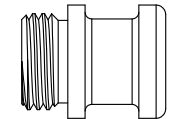

SEAT USED: LF648250

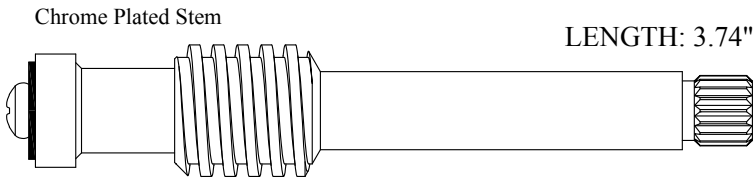

LF269141

18
3-3

FOR BRIGGS

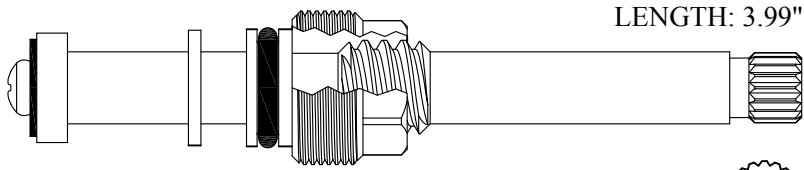

404111/ 404112

18
3-3

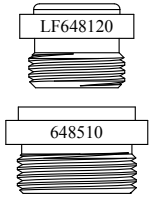

SEAT USED: 648510 or LF648120

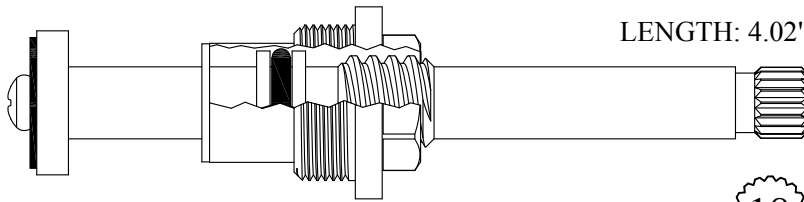

404101/ 404102

GASKET: 895150

18
3-3

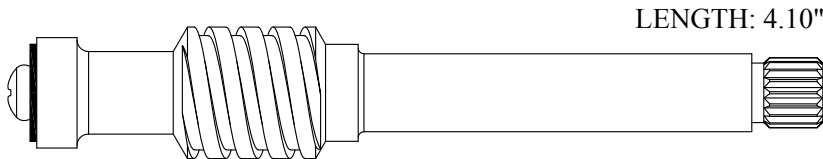
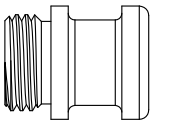

LF271011/ LF271012

18
3-3

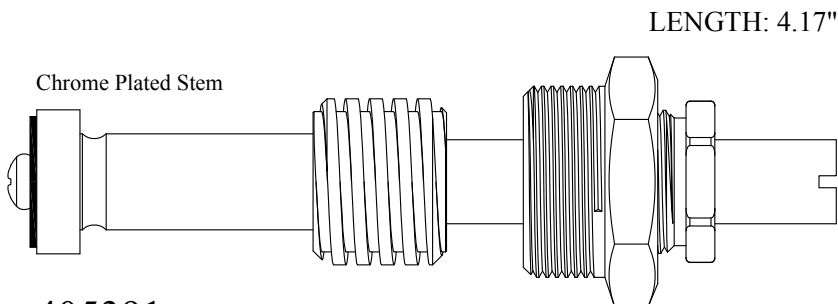

405391
205391 Stem Only
GASKET: 895340

Send Your Orders To:

BARRY E.  SR. CO.

E-mail: orderdesk@barrywalter.com

Fax: 1.800.886.9831

Phone: 1.800.767.5552



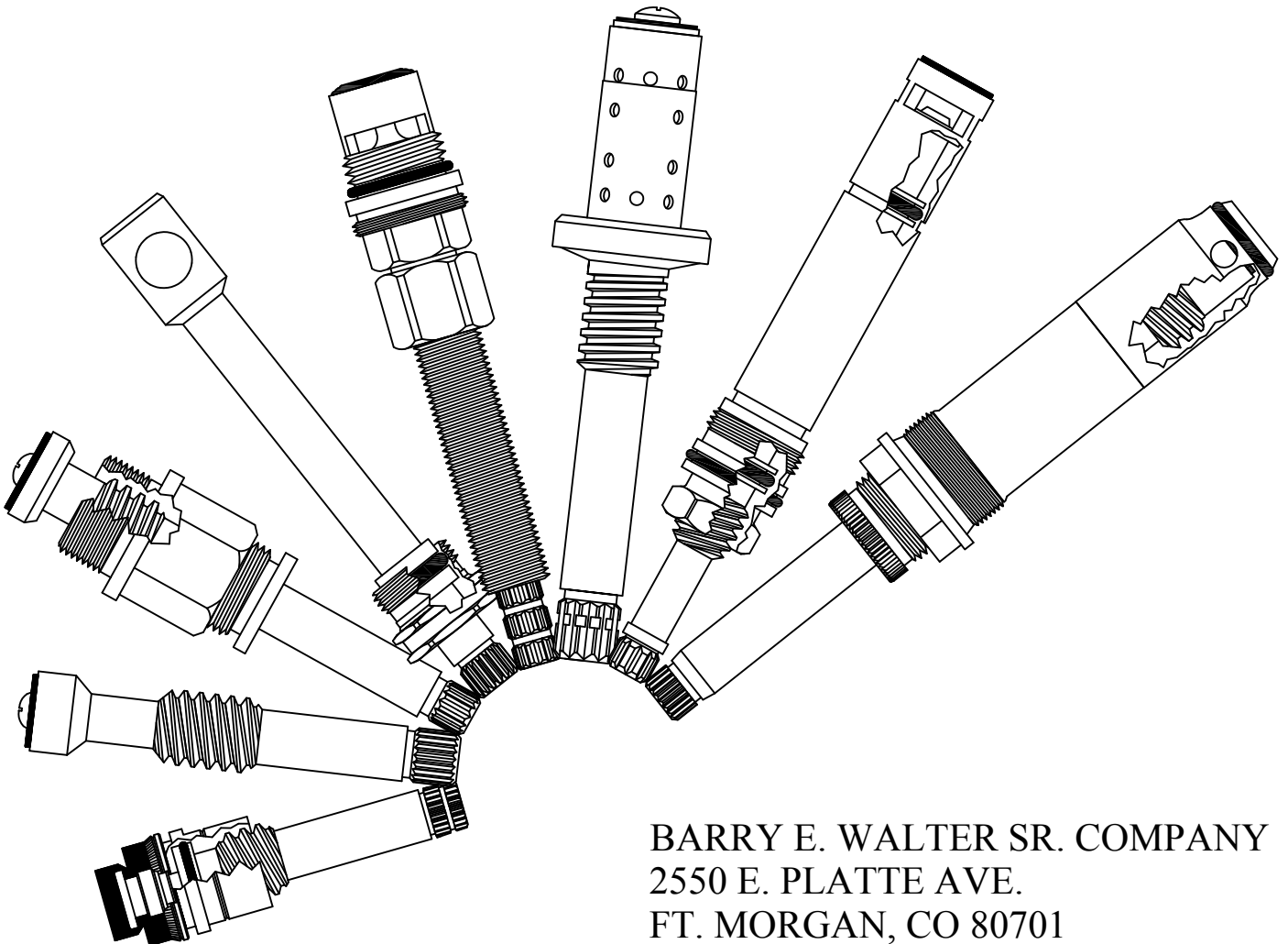

Quality Replacement Parts



BARRY E. WALTER SR. COMPANY
2550 E. PLATTE AVE.
FT. MORGAN, CO 80701

*We are always adding
new parts. Check our
website for updates.*

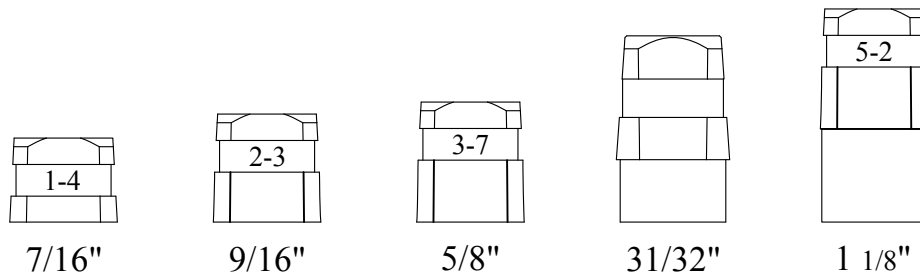
SOLID BRASS HANDLE SPUDS



AVAILABLE IN MANY DIFFERENT VARIATIONS,
CHECK THEM OUT ONLINE.

BARRY E.  ALTER  SR. CO.

FOR BRIGGS

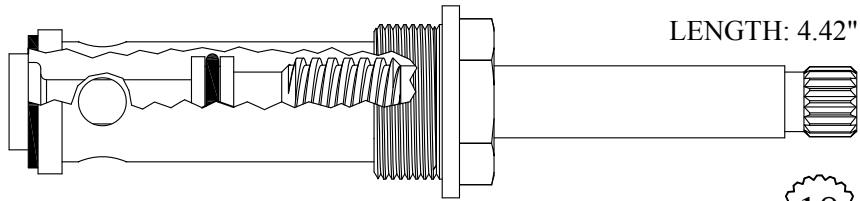

LENGTH: 4.42"

405902
GASKET: 895150

18
3-3

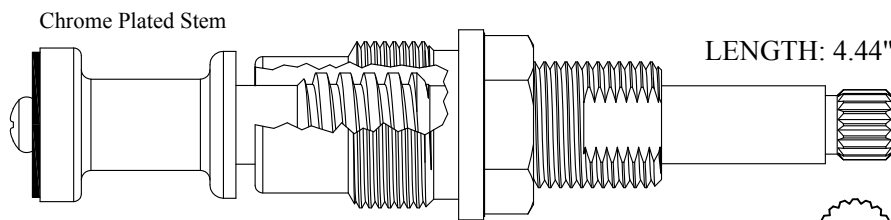

Chrome Plated Stem

LENGTH: 4.44"

LF471501
LF271501 Stem Only
GASKET: 895180

18
3-3

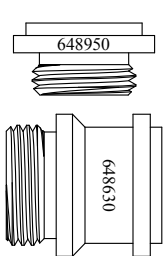

SEAT USED: 648950 or 648630

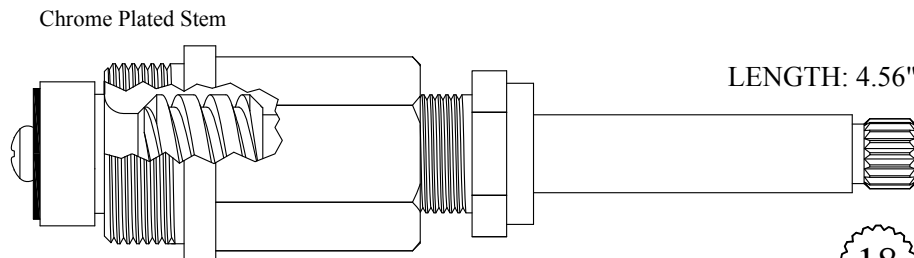

Chrome Plated Stem

LENGTH: 4.56"

407501/ 407502
207501/ 207502 Stem Only
GASKET: 895370

18
3-3

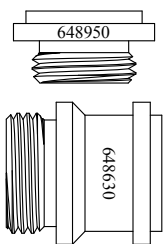

SEAT USED: 648950 or 648630

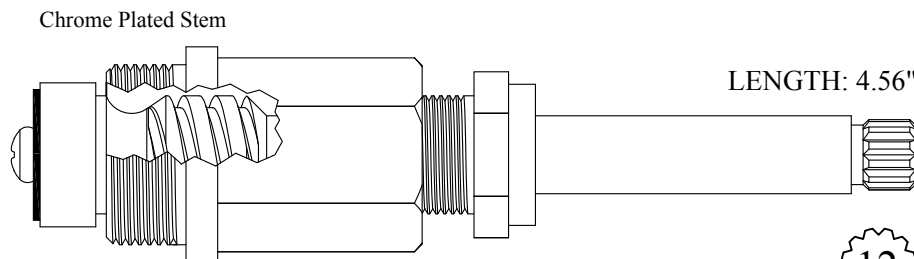

Chrome Plated Stem

LENGTH: 4.56"

407551/ 407552
207551/ 207552 Stem Only
GASKET: 895370

12
1-2

FOR BRIGGS

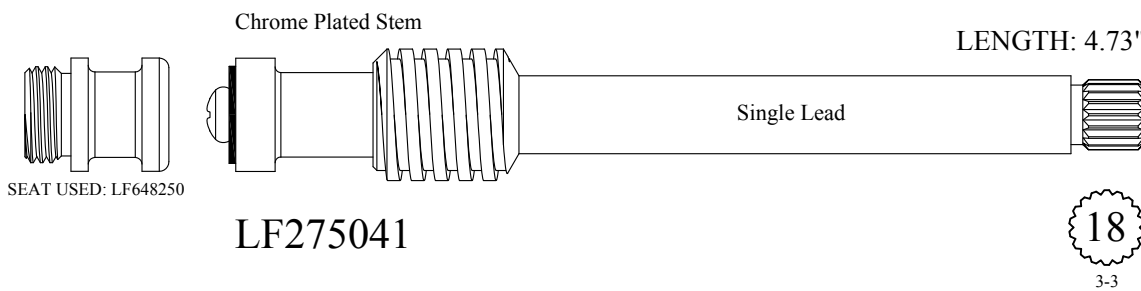
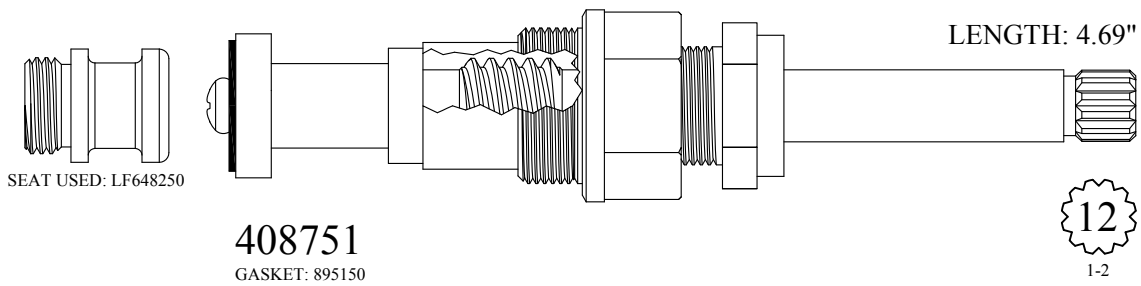
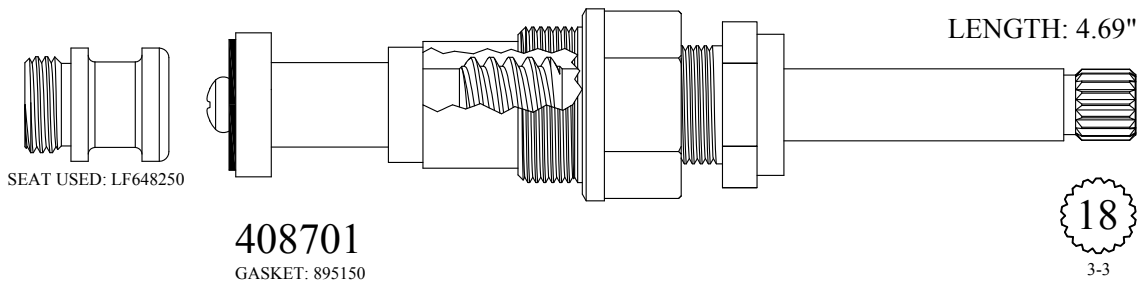
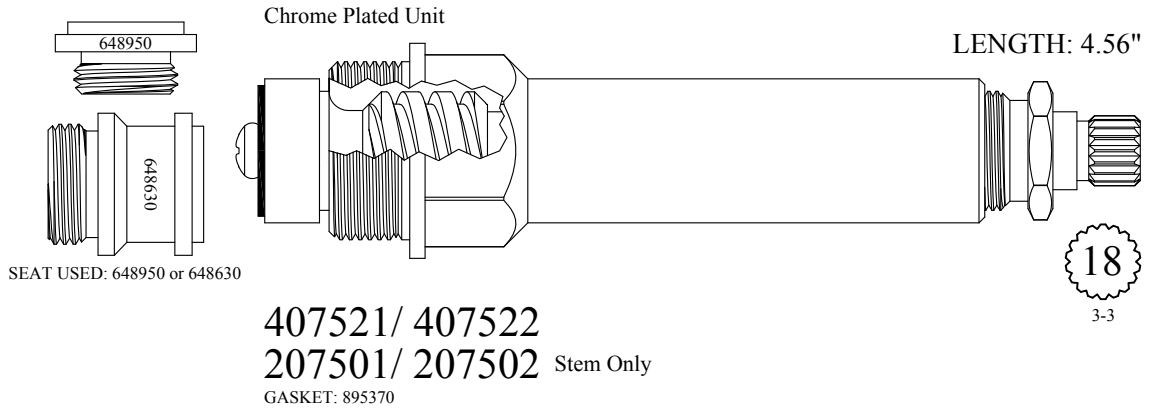

FOR BRIGGS

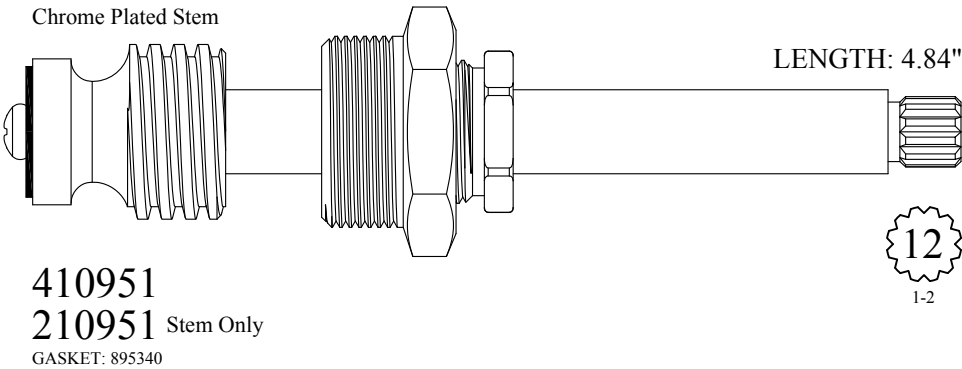
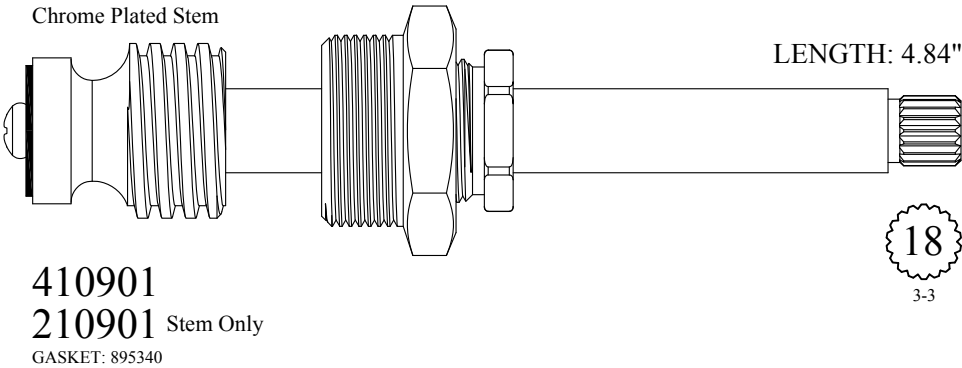
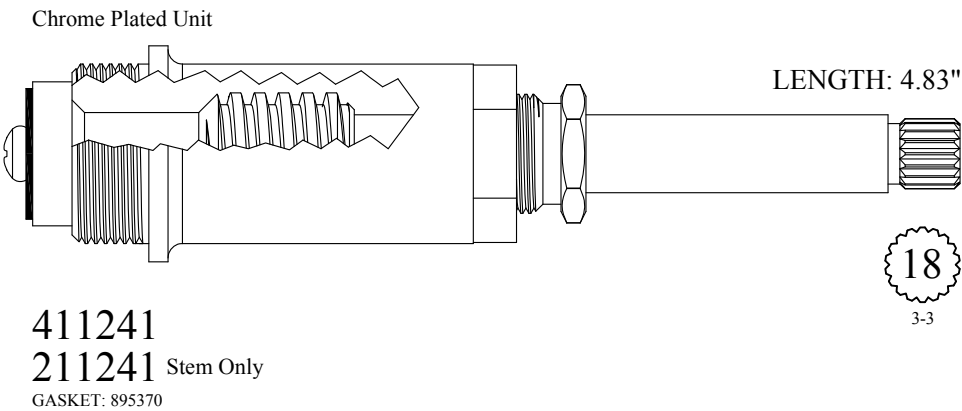
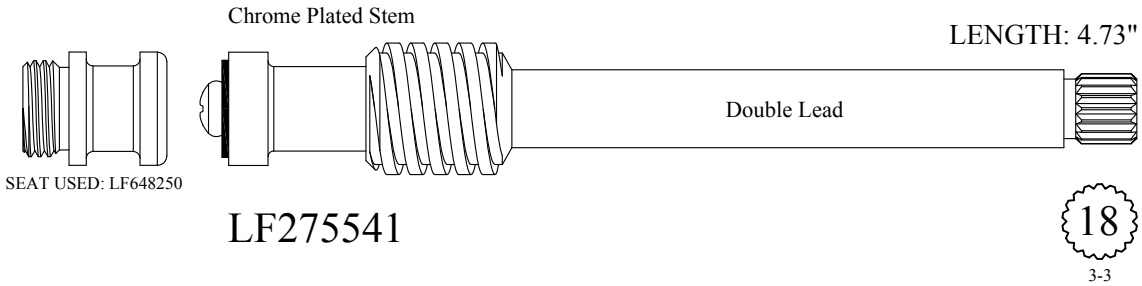

FOR BRIGGS

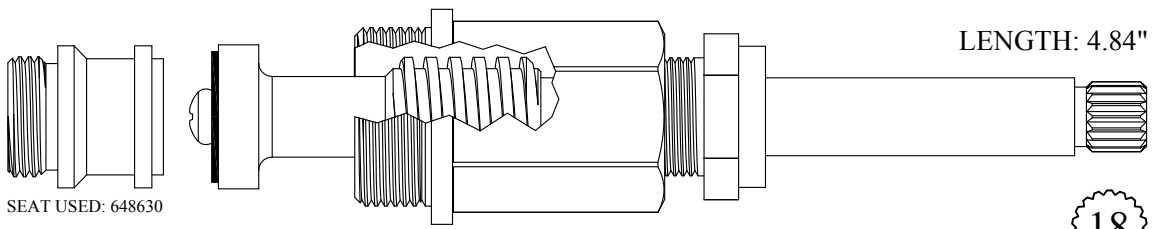

SEAT USED: 648630

LENGTH: 4.84"

411201
211201 Stem Only
 GASKET: 895370

18
 3-3

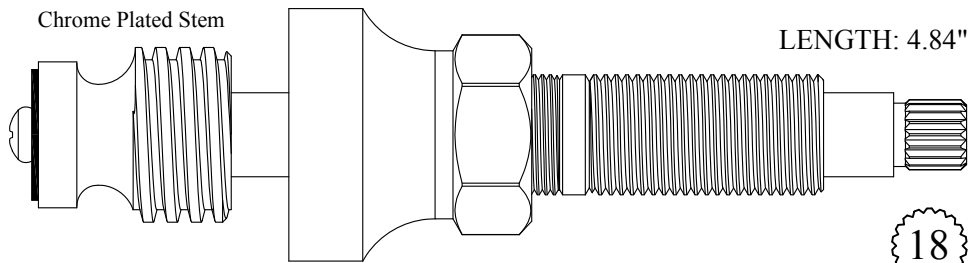

412101
210901 Stem Only

LENGTH: 4.84"

18
 3-3

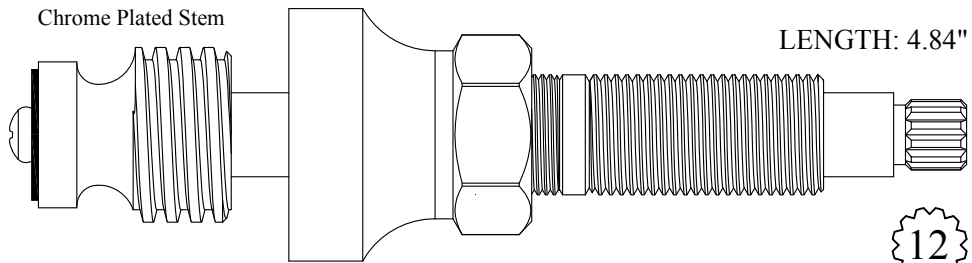

412151
210951 Stem Only

LENGTH: 4.84"

12
 1-2

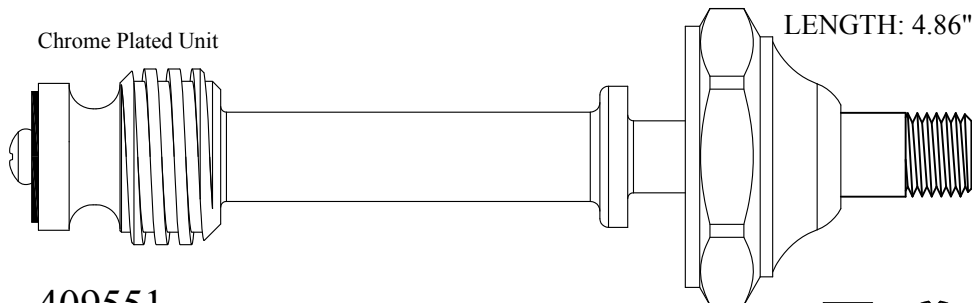

409551
209551 Stem Only

LENGTH: 4.86"

Supplied with
 12pt. Broach  12
 1-2

FOR BRIGGS

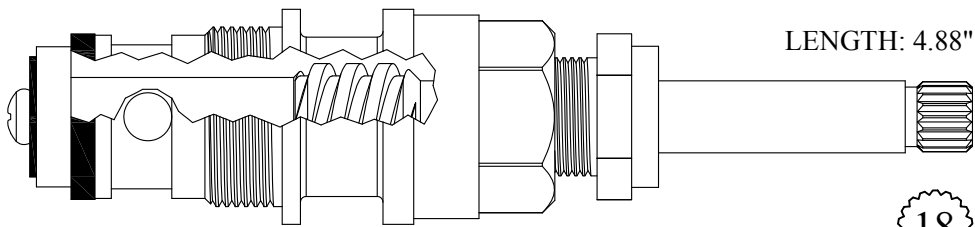

LENGTH: 4.88"

431502
231502 Stem Only
GASKET: 895370

18
3-3

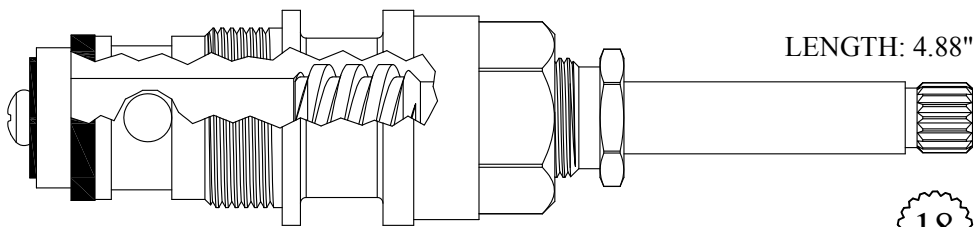

LENGTH: 4.88"

431512
231502 Stem Only
GASKET: 895370

18
3-3

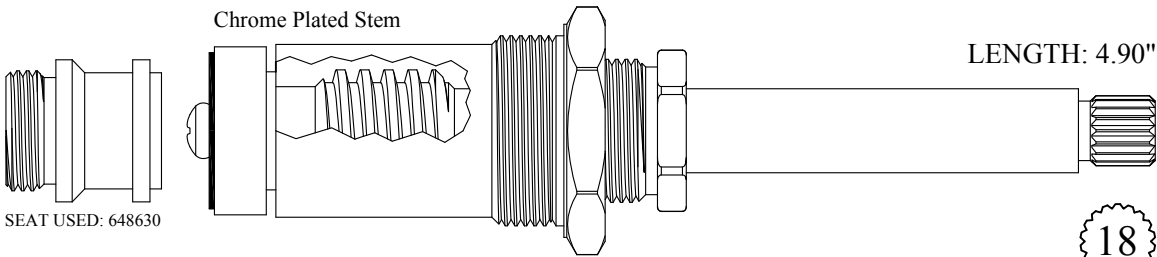

Chrome Plated Stem

LENGTH: 4.90"

SEAT USED: 648630

411401
211401 Stem Only
GASKET: 895340

18
3-3

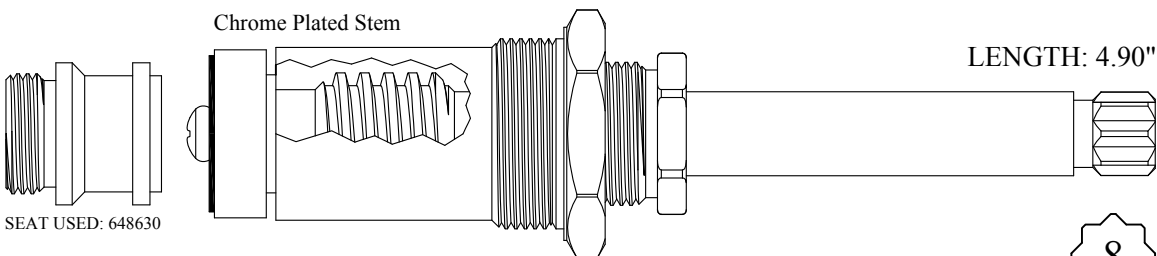

Chrome Plated Stem

LENGTH: 4.90"

SEAT USED: 648630

411411
211411 Stem Only
GASKET: 895340

8

FOR BRIGGS

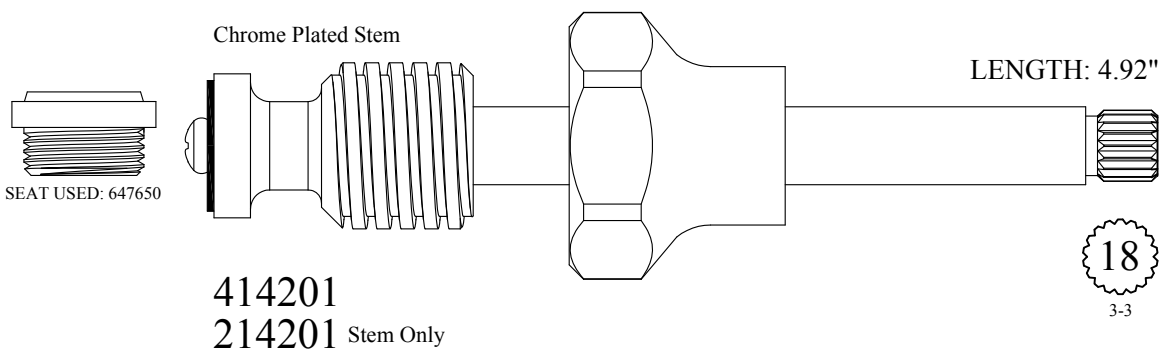
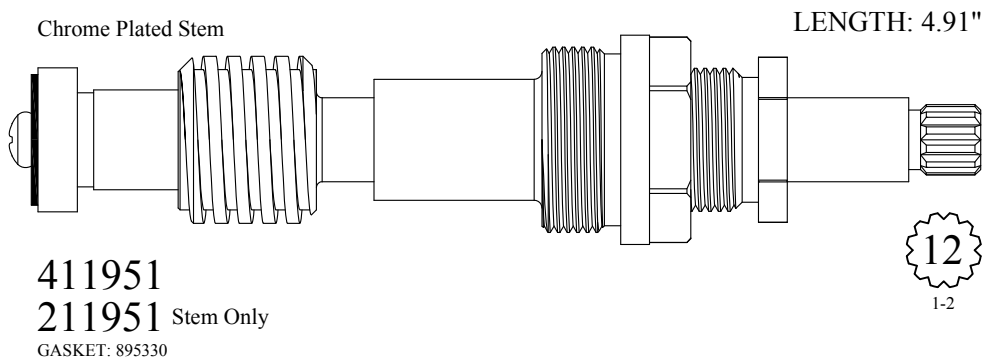
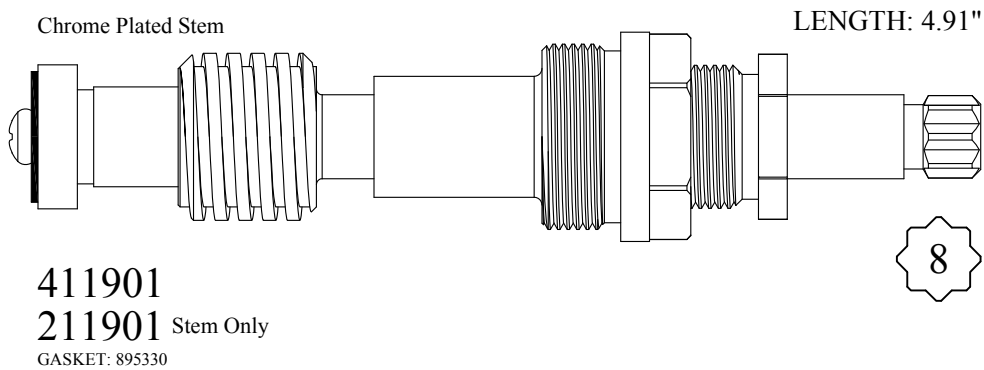
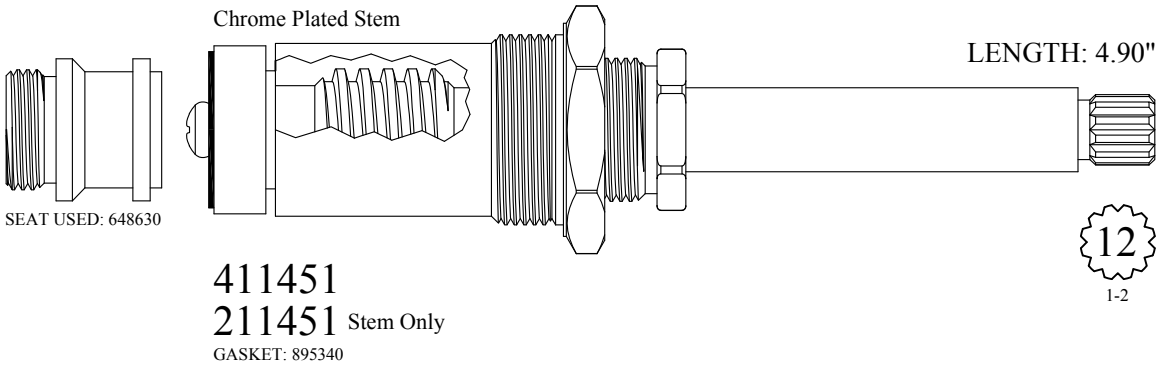

FOR BRIGGS

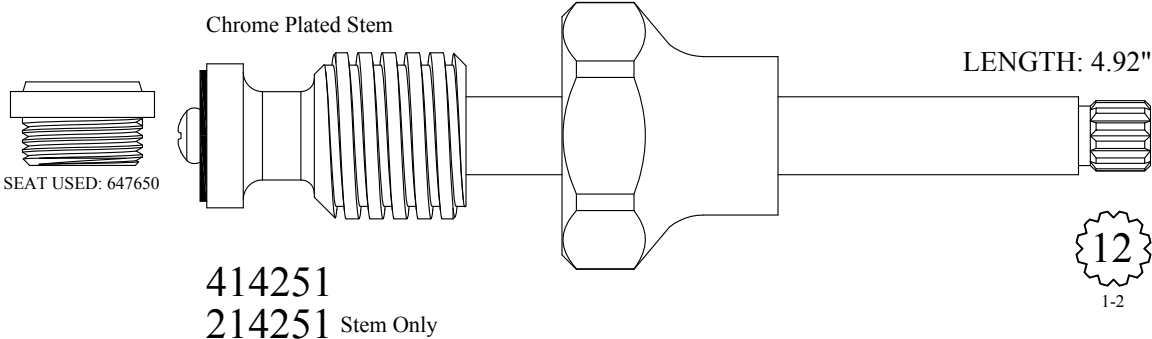

414251
214251 Stem Only

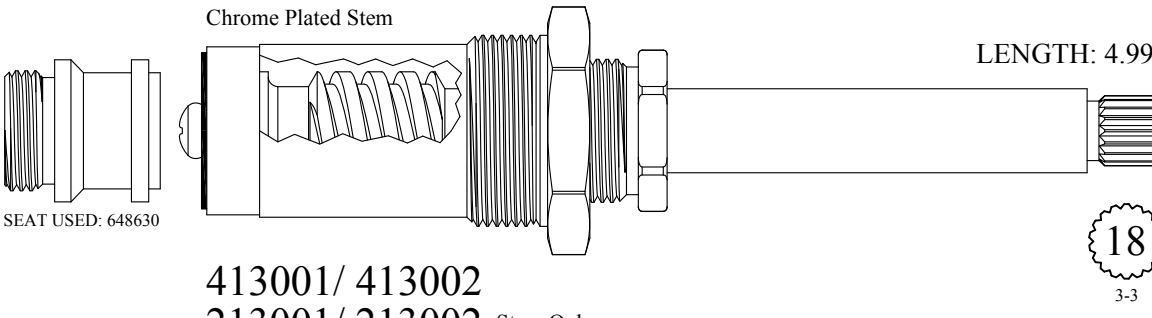

413001/ 413002
213001/ 213002 Stem Only
GASKET: 895340

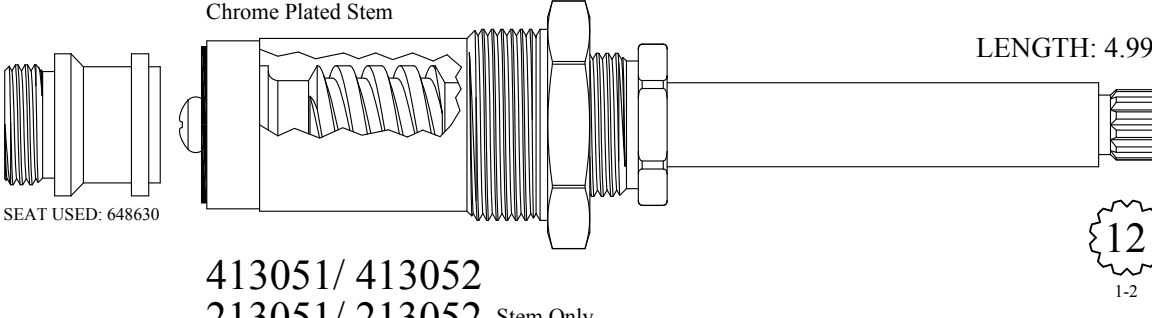

413051/ 413052
213051/ 213052 Stem Only
GASKET: 895340

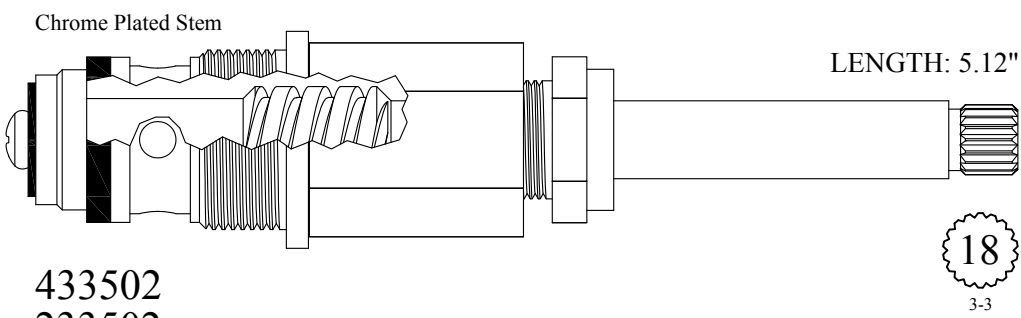

433502
233502 Stem Only
GASKET: 895370

FOR BRIGGS

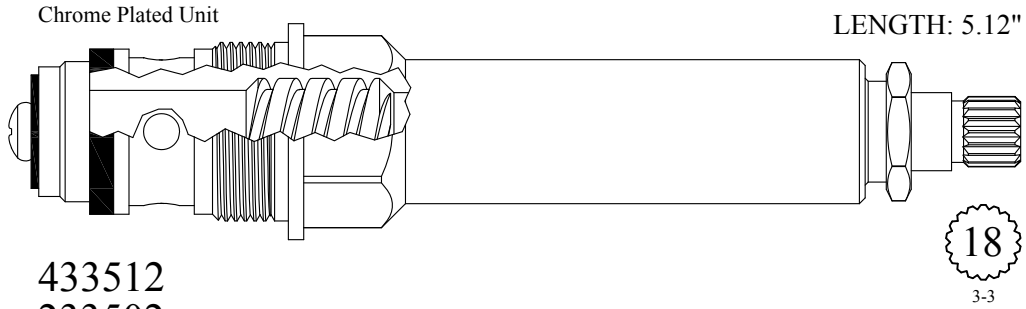

433512
233502 Stem Only
GASKET: 895370

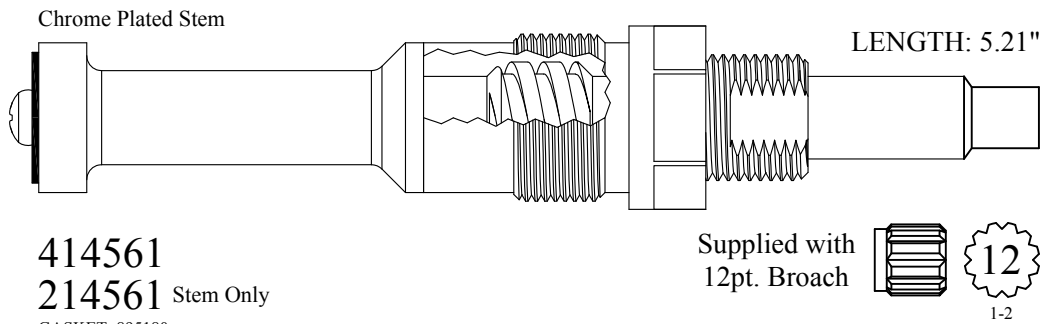

414561
214561 Stem Only
GASKET: 895180

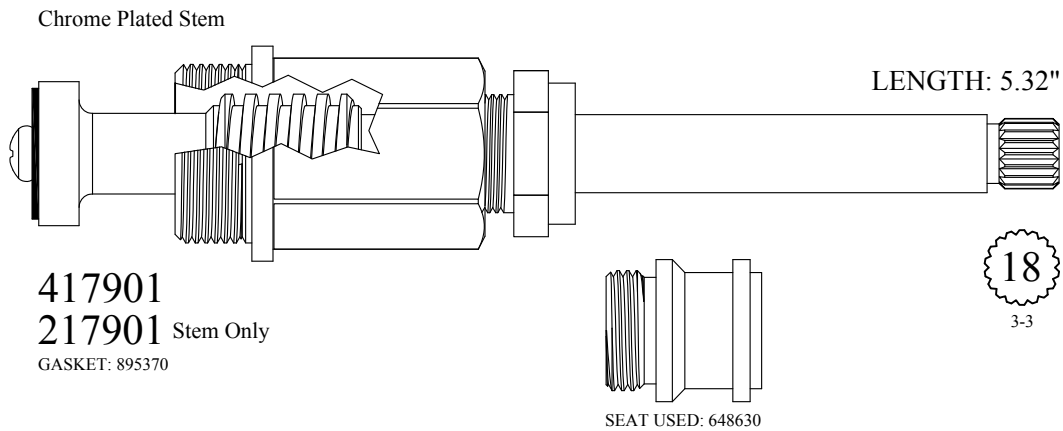

417901
217901 Stem Only
GASKET: 895370

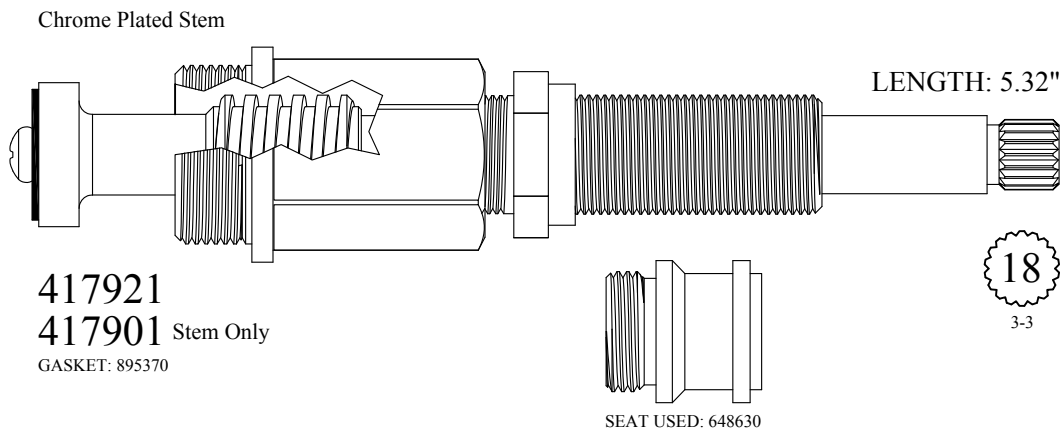

417921
417901 Stem Only
GASKET: 895370

FOR BRIGGS

Chrome Plated Unit
20 TPI Gland

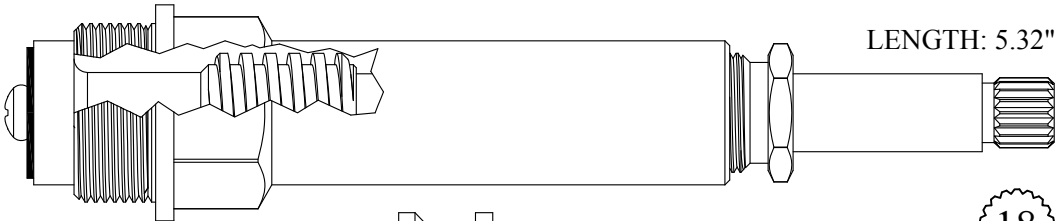

LENGTH: 5.32"

18
3-3

417911
217901 Stem Only
GASKET: 895370

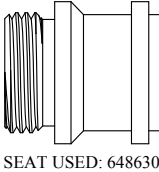

SEAT USED: 648630

Chrome Plated Unit
18 TPI Gland



LENGTH: 5.32"

18
3-3

417931
217901 Stem Only
GASKET: 895370

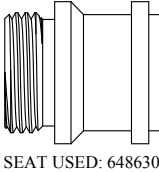

SEAT USED: 648630

Chrome Plated Stem

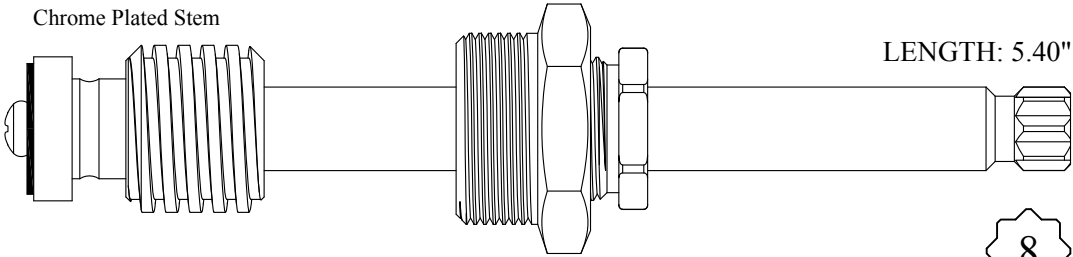

LENGTH: 5.40"

8

420611
220611 Stem Only
GASKET: 895340

Chrome Plated Stem

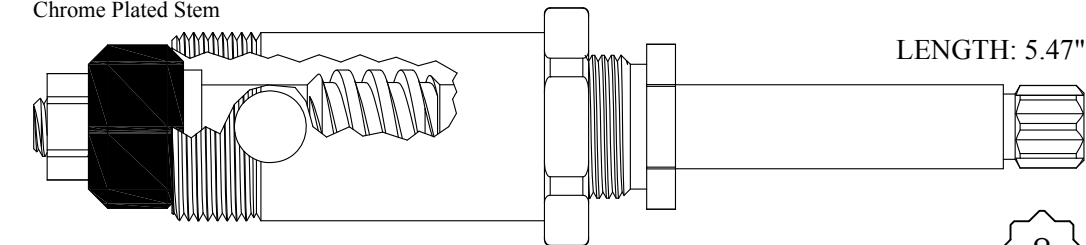

LENGTH: 5.47"

8

433701
233701 Stem Only
GASKET: 895340

FOR BRIGGS

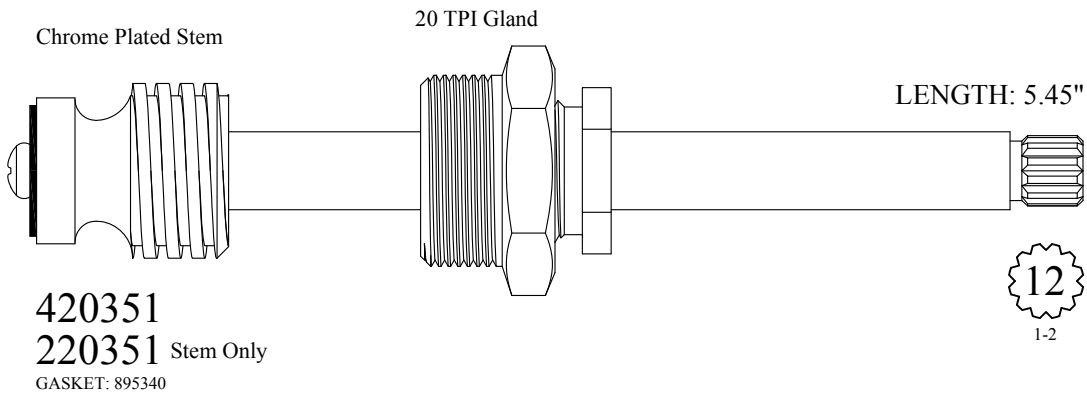
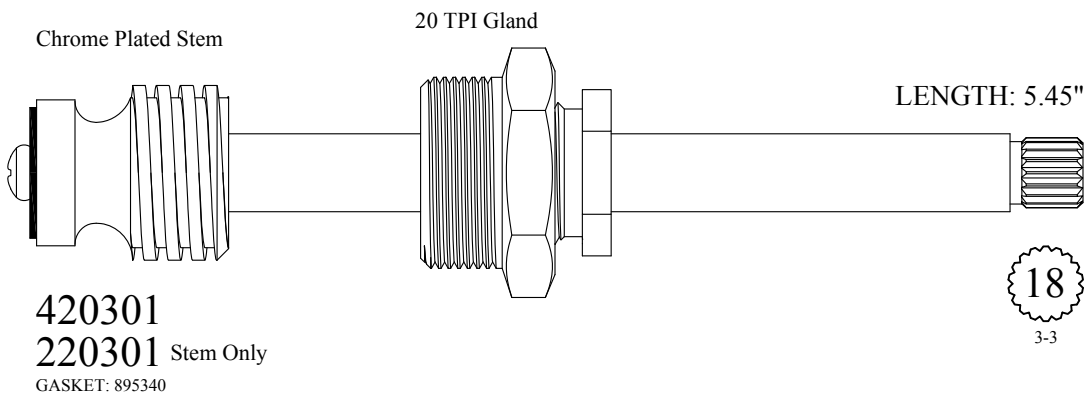
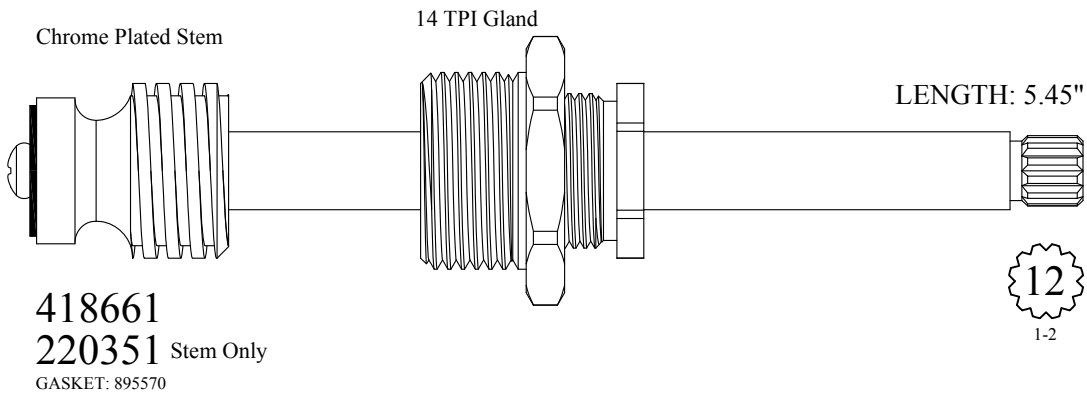
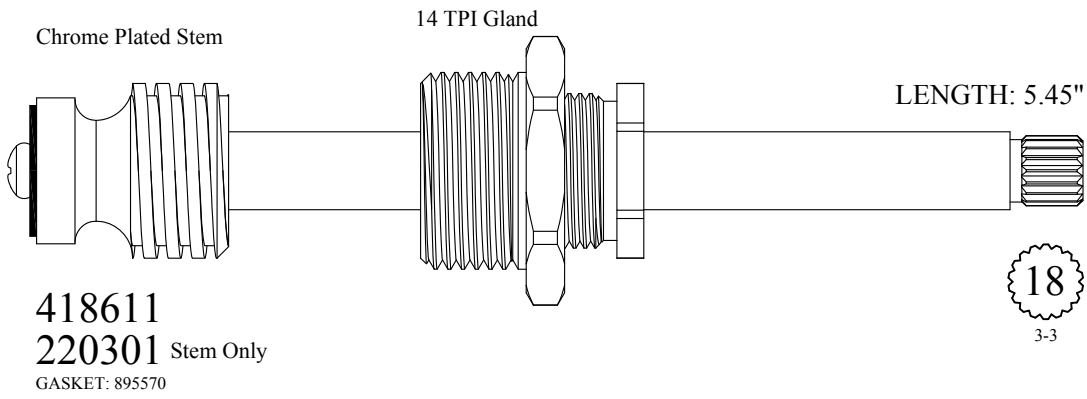

FOR BRIGGS

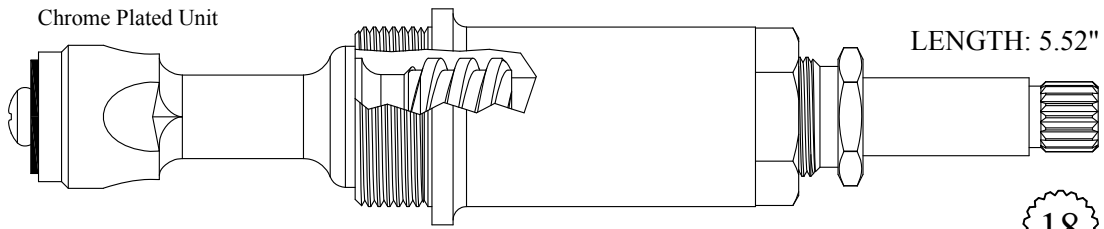

Chrome Plated Unit
433712
233712 Stem Only
 GASKET: 895370

LENGTH: 5.52"

18
 3-3

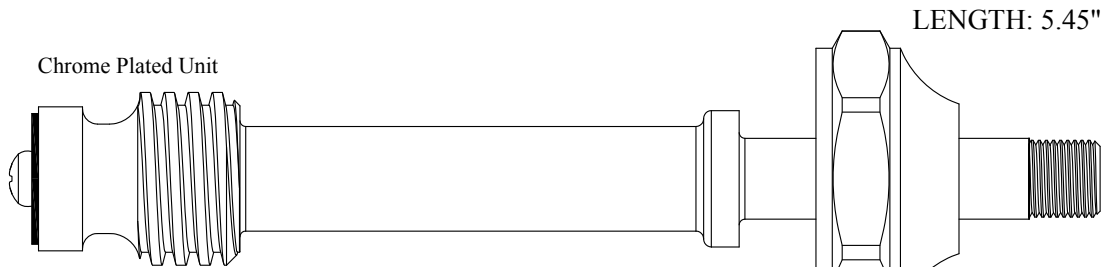

Chrome Plated Unit
421051
220951 Stem Only

LENGTH: 5.45"

Supplied with
 12pt. Broach

12
 1-2

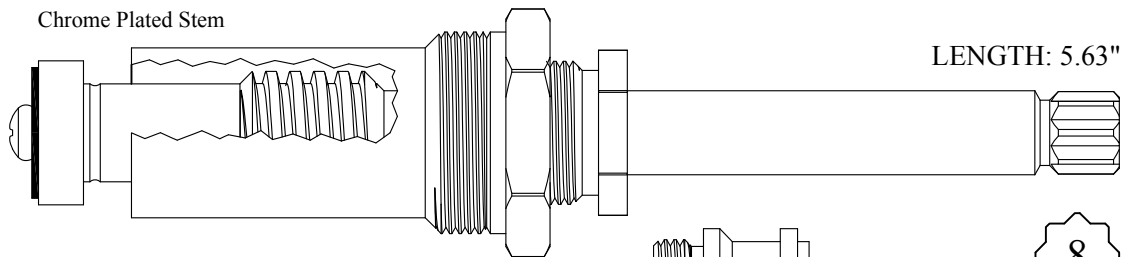

Chrome Plated Stem
422501
222501 Stem Only
 GASKET: 895340

LENGTH: 5.63"

8

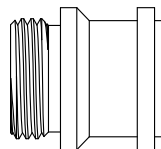

SEAT USED: 648630

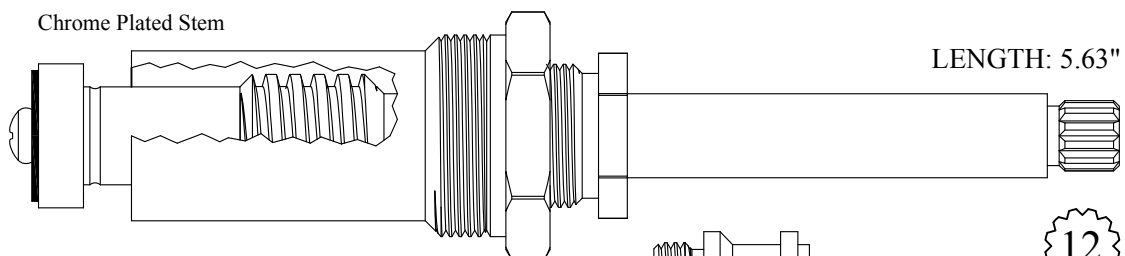

Chrome Plated Stem
422551
222551 Stem Only
 GASKET: 895340

LENGTH: 5.63"

12
 1-2

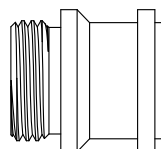

SEAT USED: 648630

FOR BRIGGS

Chrome Plated Stem

LENGTH: 5.68"

422801
222801 Stem Only
GASKET: 895340

SEAT USED: 648630

8

Chrome Plated Stem

LENGTH: 5.68"

422851
222851 Stem Only
GASKET: 895340

SEAT USED: 648630

12
1-2

Chrome Plated Unit

LENGTH: 5.68"

422811
222801 Stem Only

SEAT USED: 648630

8

Chrome Plated Stem

LENGTH: 5.70"

417851
217851 Stem Only

Supplied with
12pt. Broach

SEAT USED: 648630

12
1-2

FOR BRIGGS

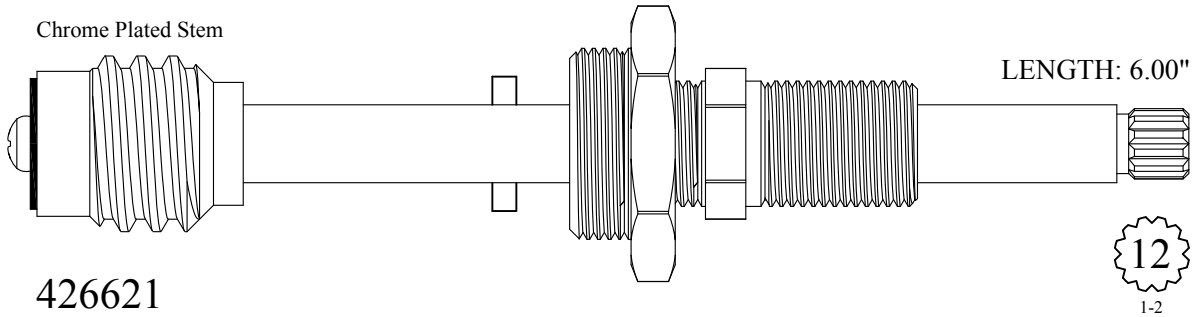

Chrome Plated Stem
426621
226621 Stem Only
 GASKET: 895550

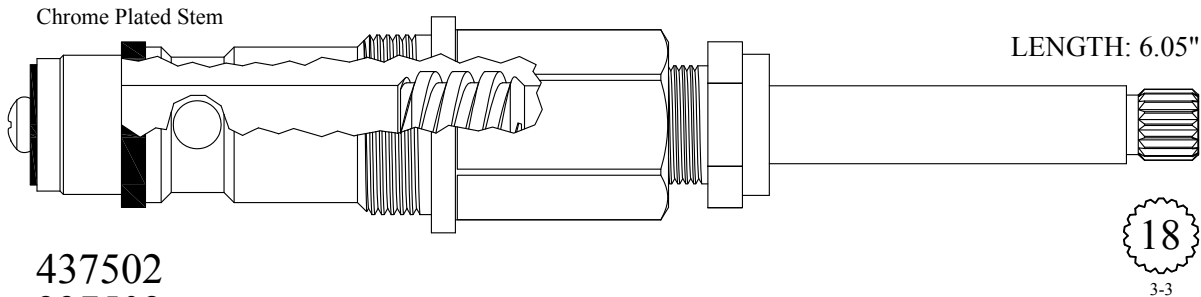

Chrome Plated Stem
437502
237502 Stem Only
 GASKET: 895370

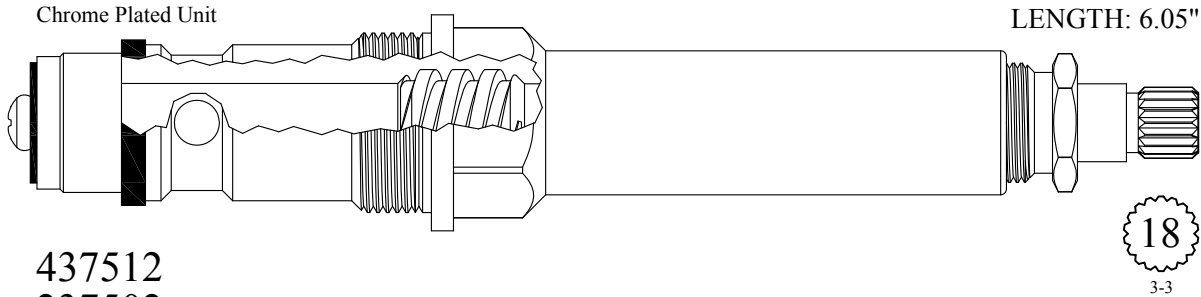

Chrome Plated Unit
437512
237502 Stem Only
 GASKET: 895370

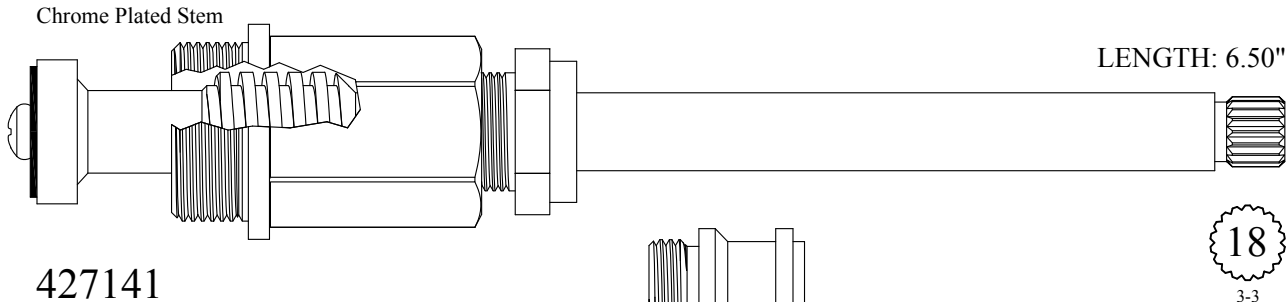

Chrome Plated Stem
427141
227141 Stem Only
 GASKET: 895370

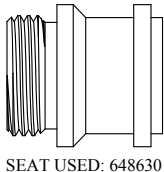

SEAT USED: 648630

FOR BRIGGS

Chrome Plated Stem

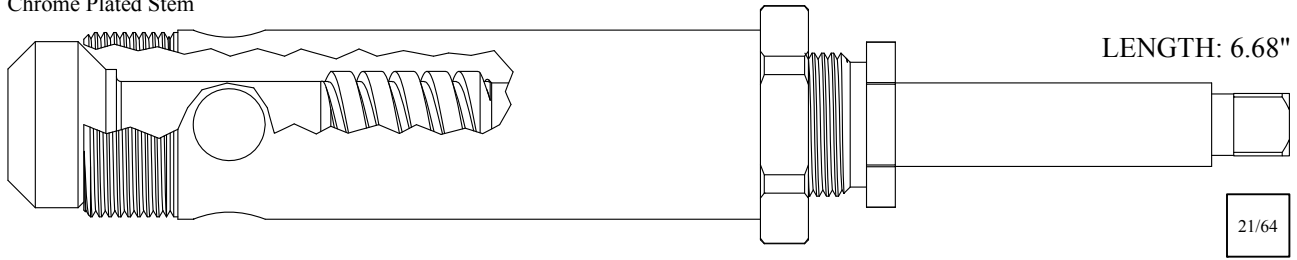

439201

239201 Stem Only

GASKET: 895340

Chrome Plated Stem

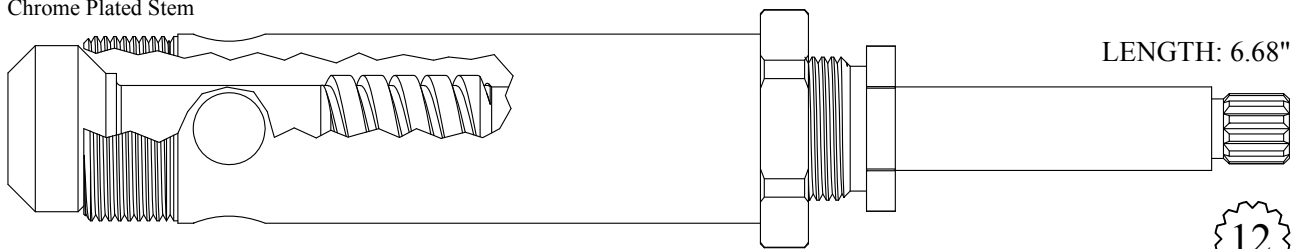

439251

239251 Stem Only

GASKET: 895340

Chrome Plated Stem

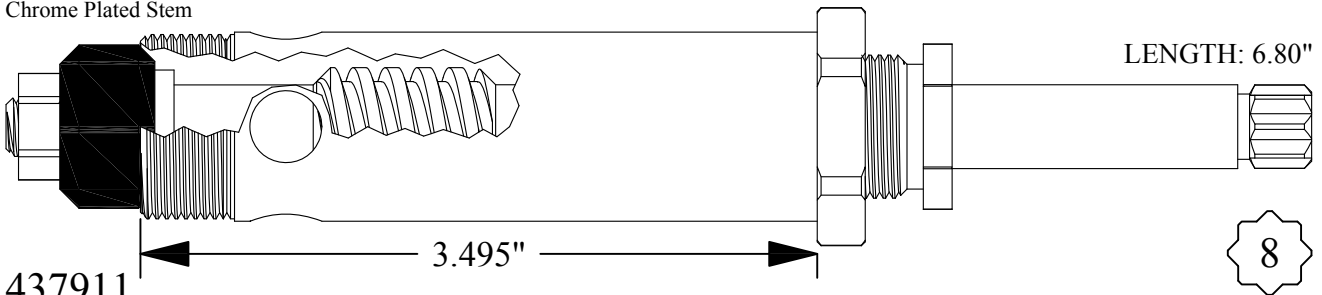

437911

237911 Stem Only

GASKET: 895340

Chrome Plated Stem

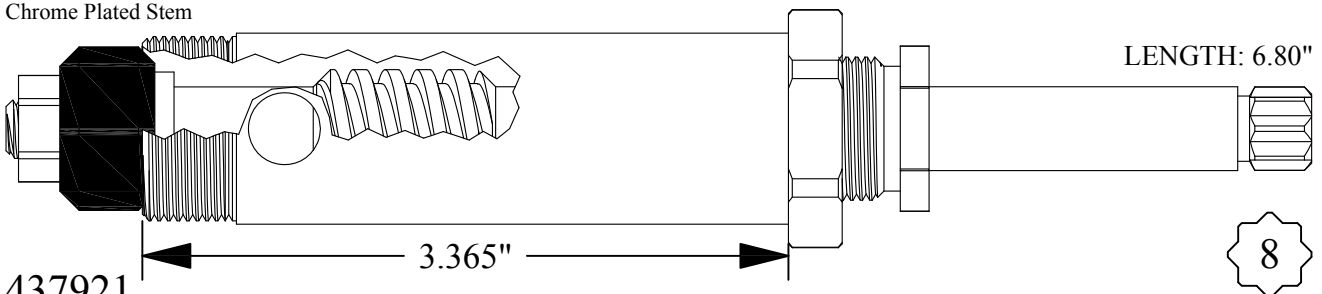

437921

237911 Stem Only

GASKET: 895340

FOR BRIGGS

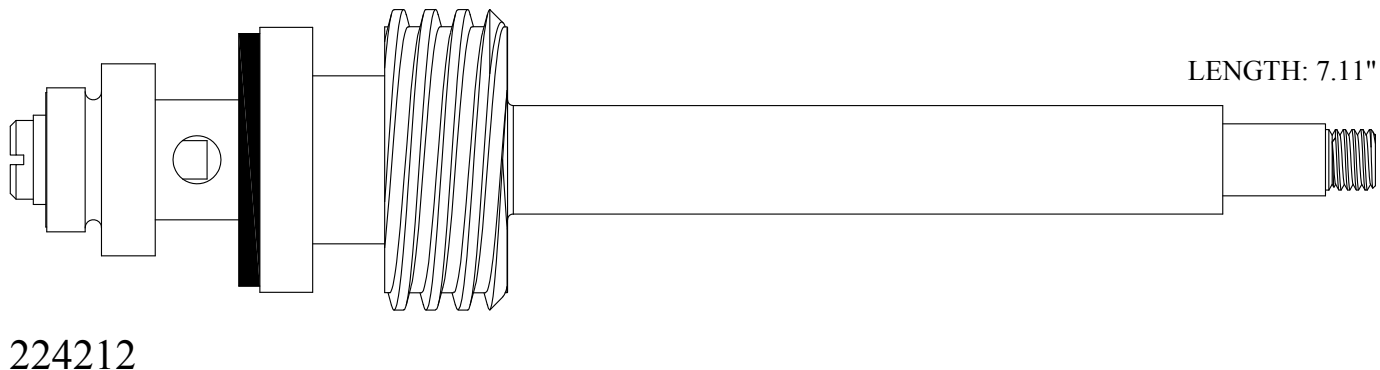
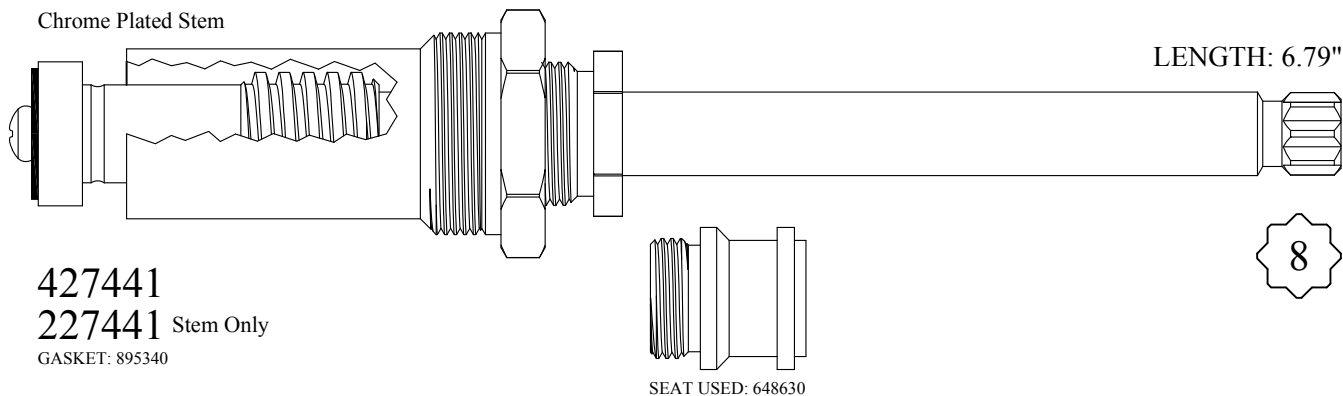

Send Your Orders To:

BARRY E.  ALTER  SR. CO.

E-mail: orderdesk@barrywalter.com

Fax: 1.800.886.9831

Phone: 1.800.767.5552

FOR BROADWAY

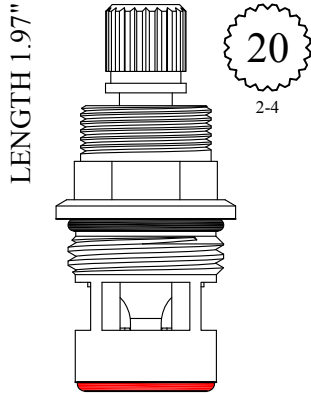

GASKET: 890170 O-RING INCLUDED
SEAL: 898570-R/B
DISC SET: 151380-PKG

LF457601
LF457602

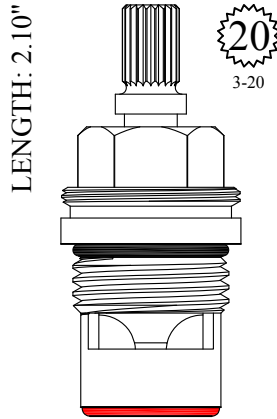

GASKET: 890170 O-RING INCLUDED
SEAL: 898570-R/B
DISC SET: 151380-PKG

LF459321
LF459322

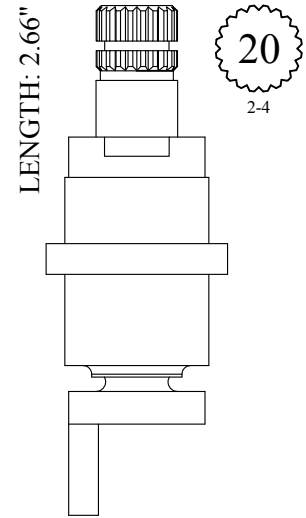

430540

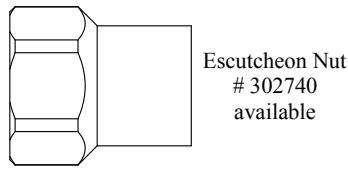

Escutcheon Nut
302740
available

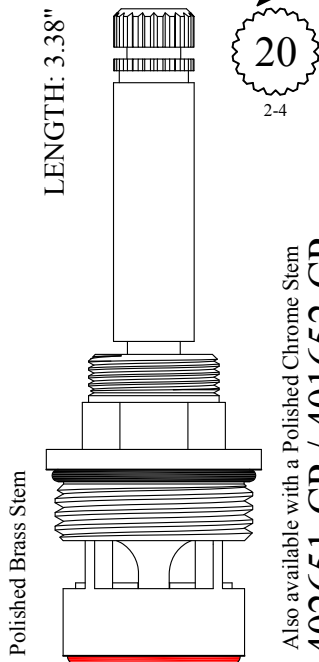

GASKET: 890210 O-RING INCLUDED
SEAL: 898610-R/B
DISC SET: 109850-PKG

402651
402652

Also available with a Polished Chrome Stem
402651-CP / 401652-CP

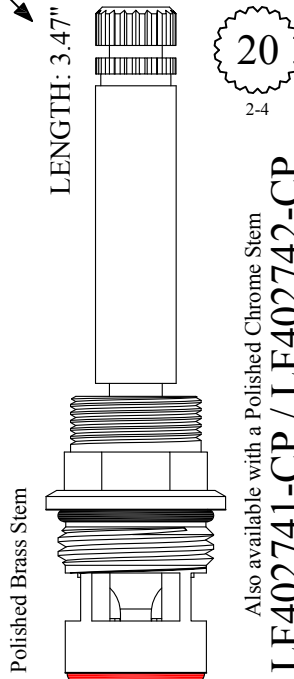

GASKET: 890170 O-RING INCLUDED
SEAL: 898570-R/B
DISC SET: 151380-PKG

LF402741
LF402742

Also available with a Polished Chrome Stem
LF402741-CP / LF402742-CP

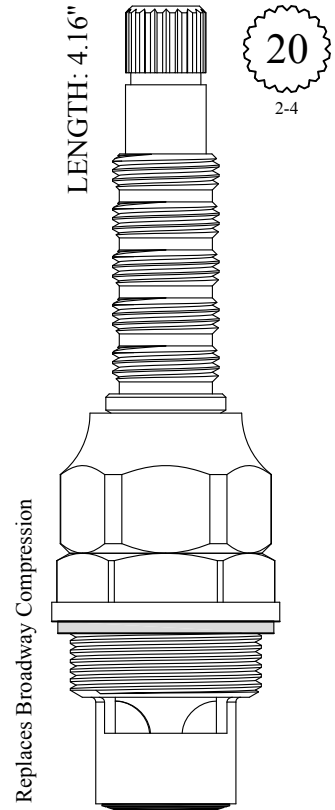

Replaces Broadway Compression

GASKET INCLUDED: 895550
SEAL: 898510
DISC SET: 151380-PKG

404621

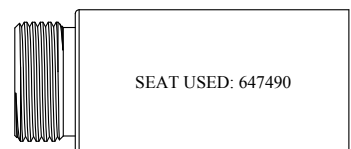

FOR BROADWAY

Polished Brass Stem

SEAT USED: 648180

LENGTH: 5.03"

20
2-4

414321/ 414322
214321/ 214322 Stem Only
GASKET: 895570

Also available with polished chrome plated stem
414321-CP/ 414322-CP
214321-CP/ 214322-CP Stem Only

Polished Brass Stem

SEAT USED: LF648930

LENGTH: 5.10"

20
2-4

LF478881/ LF478882
LF278881/ LF278882 Stem Only
GASKET INCLUDED: 890180

Also available with polished chrome plated stem
LF478881-CP/ LF478882-CP
LF278881-CP/ LF278882-CP Stem Only

Polished Brass Stem

SEAT USED: LF648930

LENGTH: 5.10"

20
2-4

LF478891/ LF478892
LF278891/ LF278892 Stem Only
GASKET INCLUDED: 890180

Also available with polished chrome plated stem
LF478891-CP/ LF478892-CP
LF278891-CP/ LF278892-CP Stem Only

Polished Brass Stem

LENGTH: 5.34"

20
2-4

433221
233221 Stem Only

Also available with polished chrome plated stem
433221-CP
233221-CP Stem Only

FOR BROADWAY

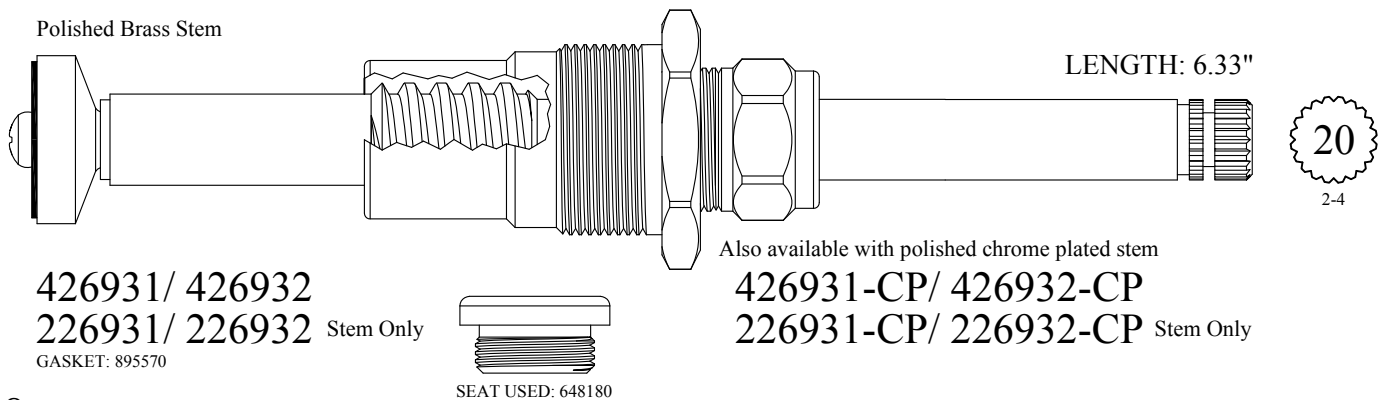
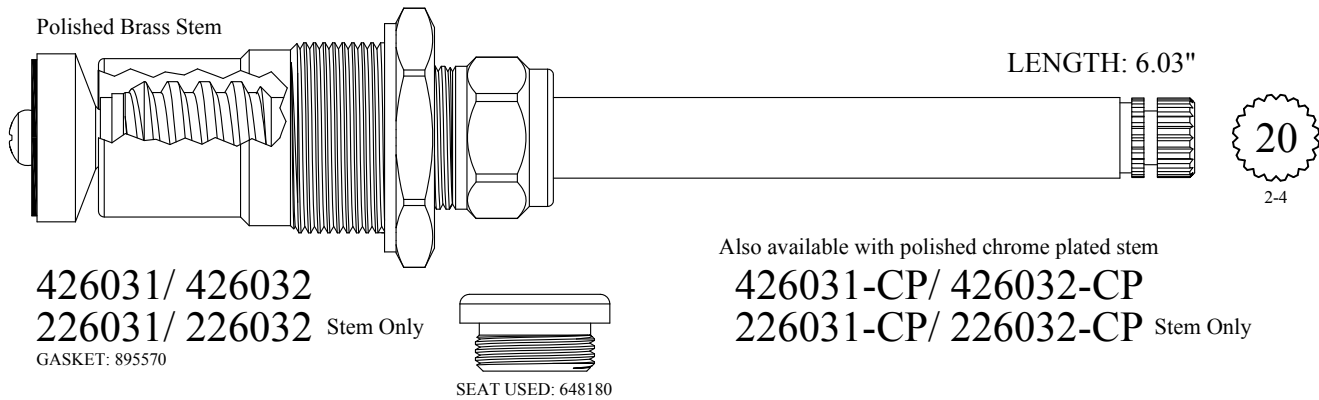
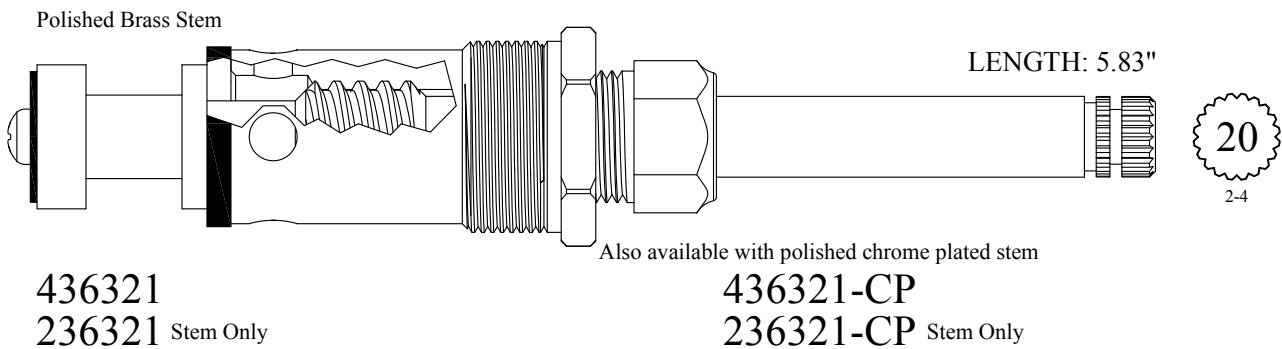
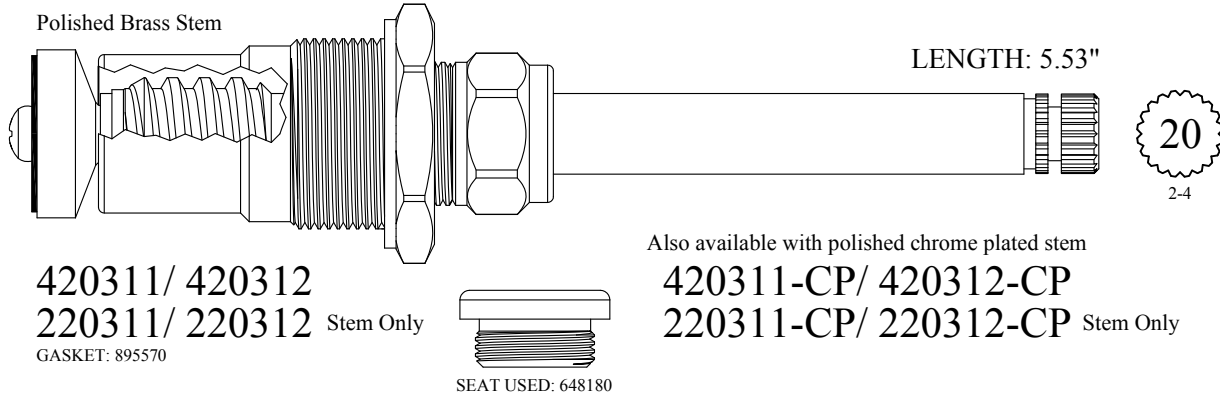

FOR BROADWAY

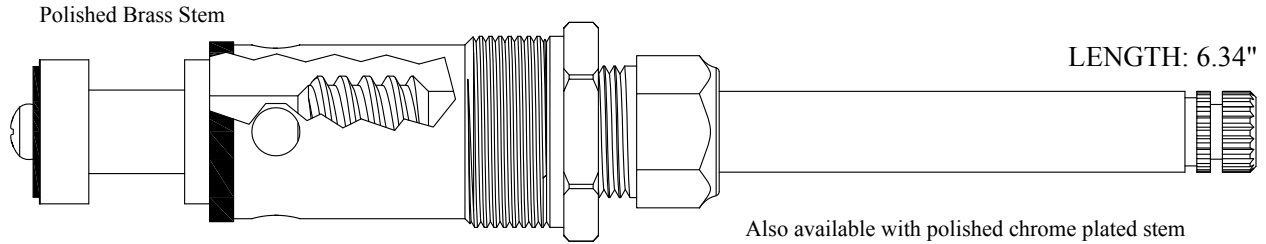

438311
238311 Stem Only

Also available with polished chrome plated stem
438311-CP
238311-CP Stem Only

20
2-4

Send Your Orders To:

BARRY E.  ALTER SR. CO.

E-mail: orderdesk@barrywalter.com

Fax: 1.800.886.9831

Phone: 1.800.767.5552

FOR BURLINGTON

LENGTH: 1.26"

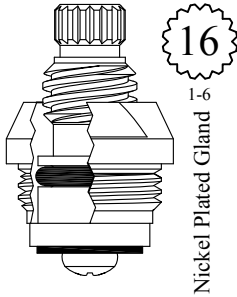

GASKET: 895100

LF450061
LF450062



SEAT USED: LF648700

LENGTH: 1.58"

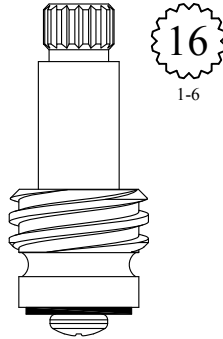

LF253061
LF253062



SEAT USED: LF648700

LENGTH: 1.80"

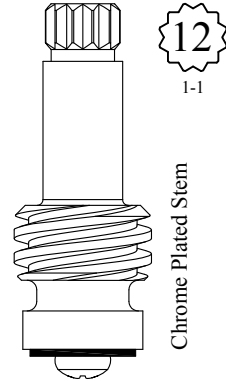

LF255111
LF255112

LENGTH: 1.88"

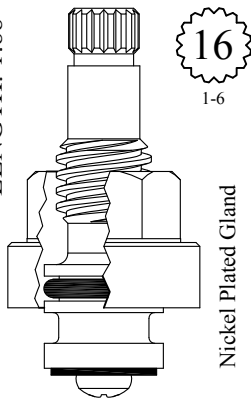

LF457011
LF457012



SEAT USED: LF648700

LENGTH: 2.00"

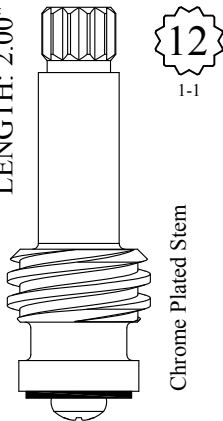

LF260071
LF260072

LENGTH: 2.35"

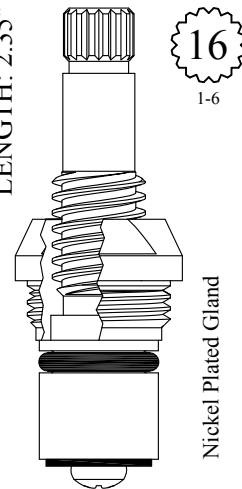

LF462111
LF462112



SEAT USED: LF648700

FOR BURLINGTON

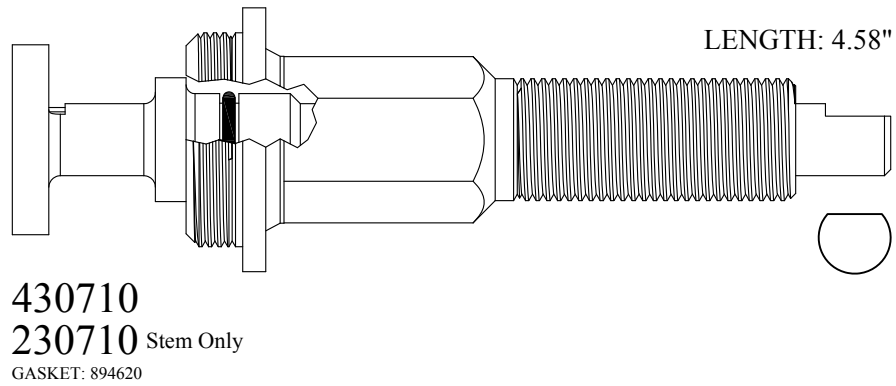
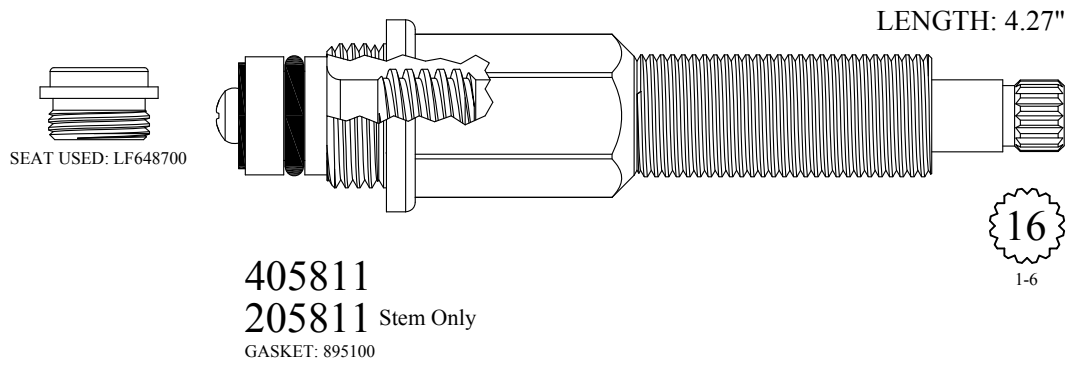
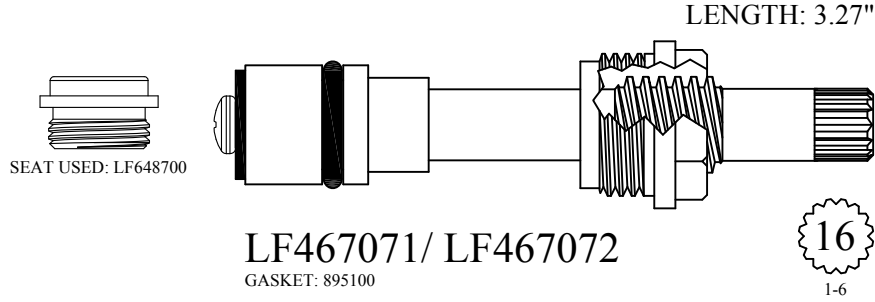

BARRY E.  SR. CO.

FOR CAL FAUCETS

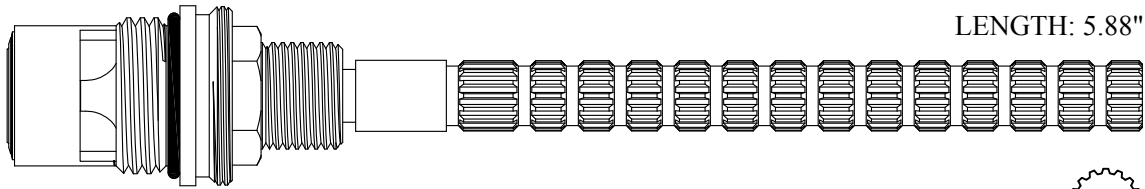

LENGTH: 5.88"

411291/ 411292

GASKET: 890170 O-RING INCLUDED
SEAL: 898510-W
DISC SET: 151380-PKG

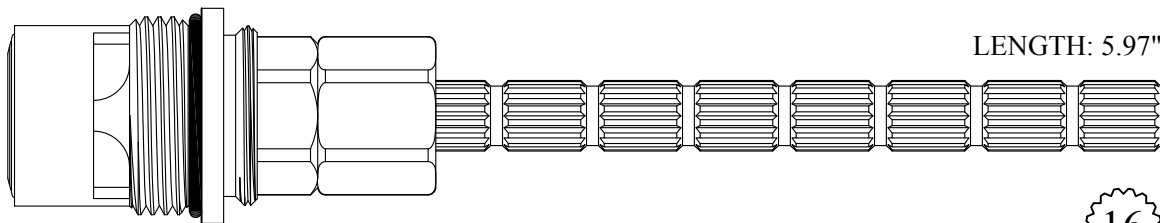

LENGTH: 5.97"

421661/ 421662

GASKET: 890210 O-RING INCLUDED
SEAL: 898520
DISC SET: 109850-PKG



Send Your Orders To:

BARRY E.  WALTER  SR. CO.

E-mail: orderdesk@barrywalter.com

Fax: 1.800.886.9831

Phone: 1.800.767.5552

FOR CALIFORNIA BRASS

Chrome Plated Stem

LENGTH: 2.33"

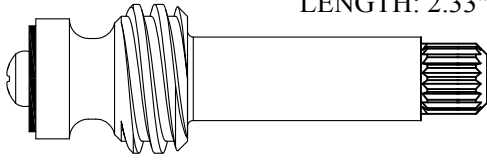

LF263141
LF263142

Supplied with
12pt. Broach



Chrome Plated Stem

LENGTH: 4.30"

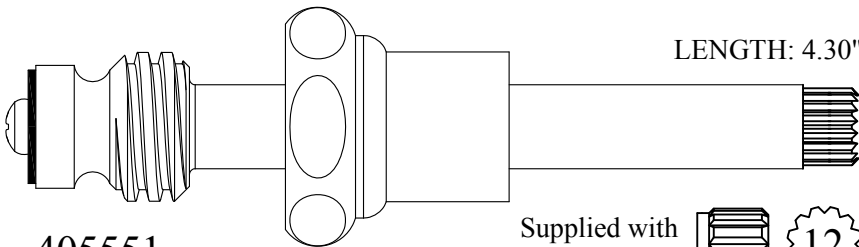

405551
205551 Stem Only

Supplied with
12pt. Broach



FOR HOT & COLD STEM USE PRICE PFISTER 405111/405112

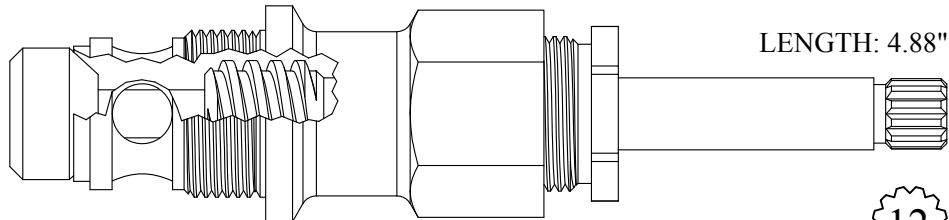

LENGTH: 4.88"

431701
231701 Stem Only

GASKET: 895400



FOR HOT & COLD STEM USE PRICE PFISTER 421601/421602

Chrome Plated Stem

LENGTH: 5.75"

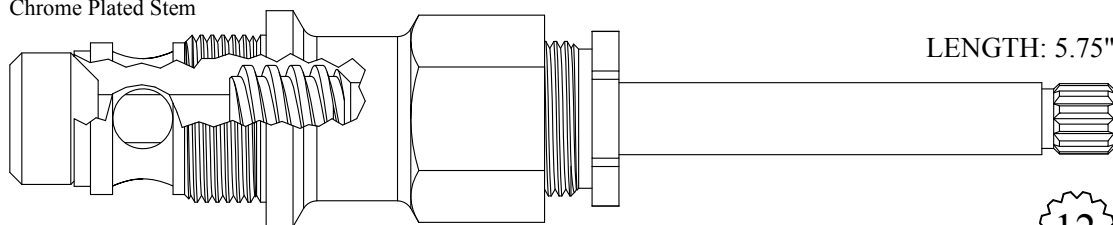

434801
234801 Stem Only

GASKET: 895400



FOR CAMBRIDGE

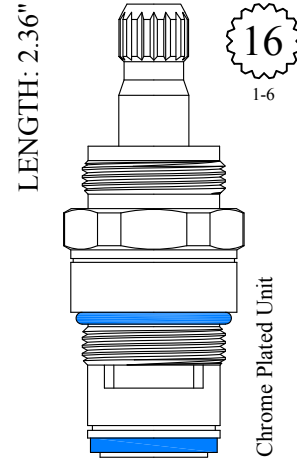
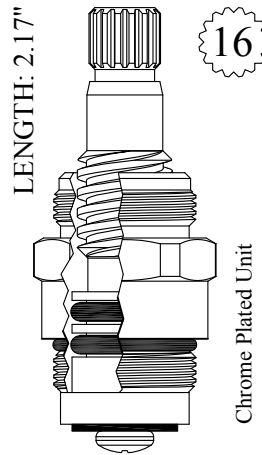
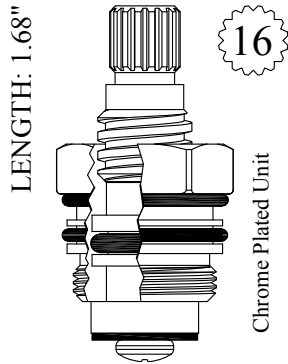

GASKET: 890170 O-RING INCLUDED

LF452961
LF452962

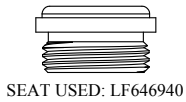

LF460291
LF460292

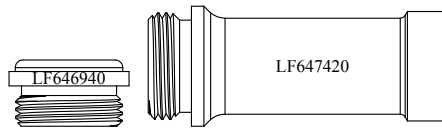

LF462711
LF462712

FOR CASE

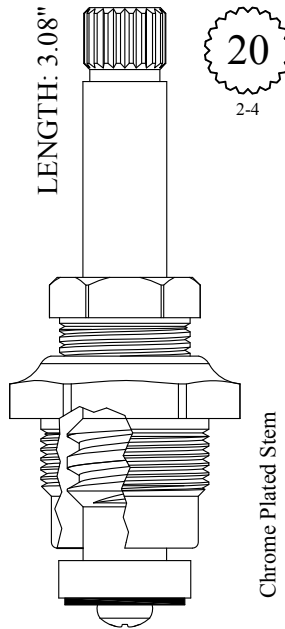

GASKET: 895290

LF467401
LF467402
LF267401 Stem Only
LF267402 Stem Only

Send Your Orders To:

BARRY E.  SR. CO.

E-mail: orderdesk@barrywalter.com

Fax: 1.800.886.9831

Phone: 1.800.767.5552



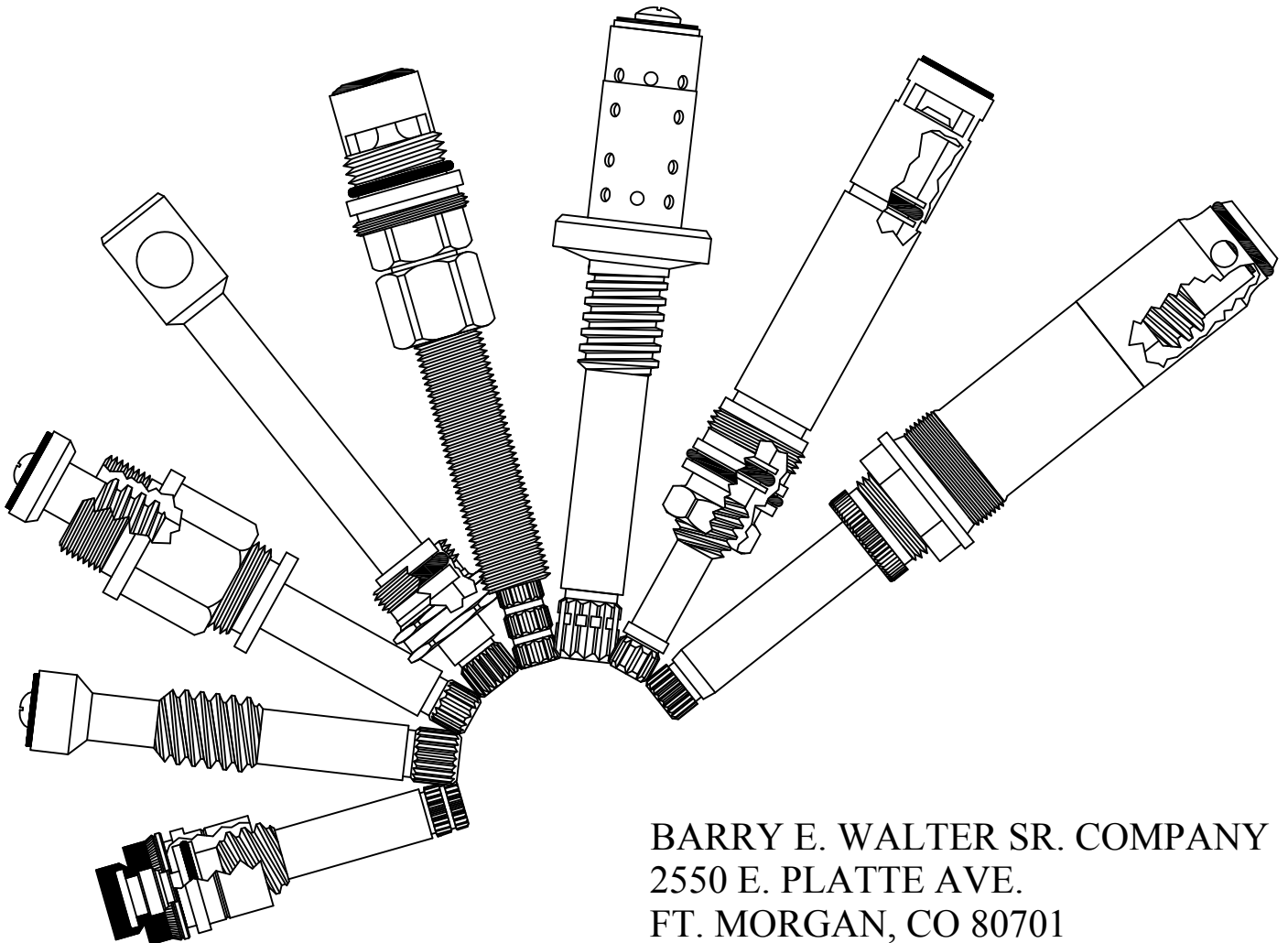

Quality Replacement Parts



BARRY E. WALTER SR. COMPANY
2550 E. PLATTE AVE.
FT. MORGAN, CO 80701

*We are always adding
new parts. Check our
website for updates.*

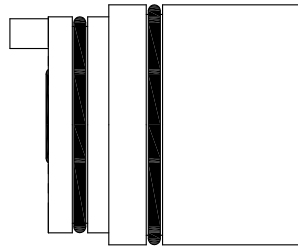
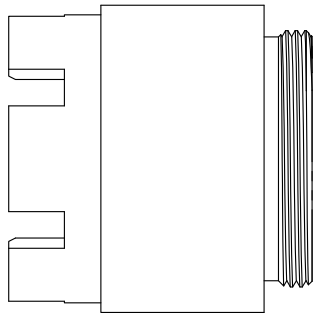
FOR AM STD RELIANT S/L CARTRIDGE EXTENSION KIT



160750

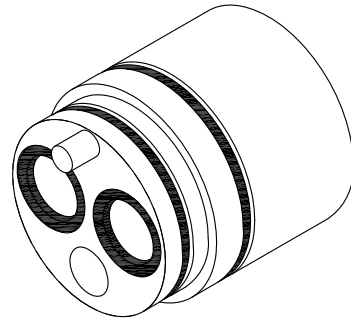

BARRY E.  ALTER  SR. CO.

FOR CENTRAL

LENGTH: 1.44"

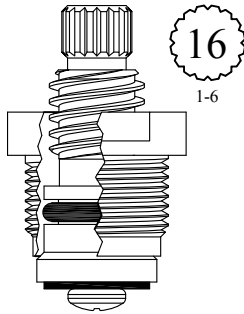

GASKET: 895100

LF451071
LF451072

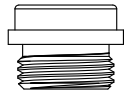

SEAT USED: LF648550

LENGTH: 1.50"

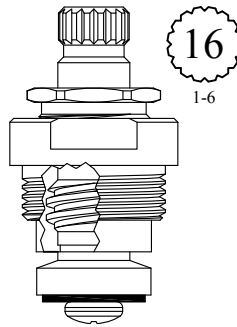

GASKET: 895100

LF452041
LF452042

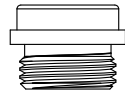

SEAT USED: LF648550

LENGTH: 1.72"

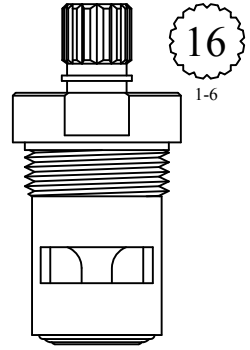

GASKET INCLUDED: 895270
SEAL: 898500
DISC SET: 112530-PKG

LF455901
LF455902

LENGTH: 1.88"

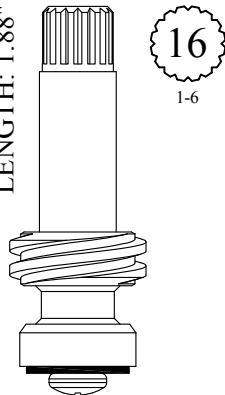

LF256111
LF256112

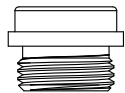

SEAT USED: LF648550

LENGTH: 2.00"

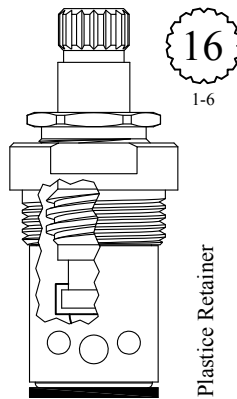

GASKET: 895100

LF453501
LF453502

LENGTH: 2.01"

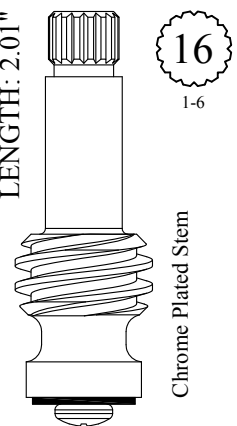

LF258081
LF258082

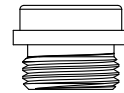

SEAT USED: LF648550

FOR CENTRAL

LENGTH: 2.13"

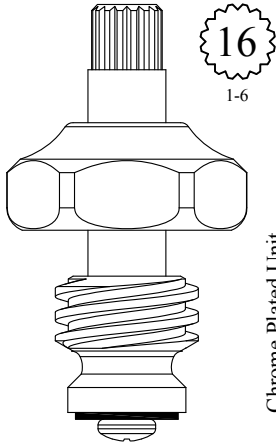

Chrome Plated Unit

LF460061
 LF460062
 LF260061 Stem Only
 LF260062 Stem Only

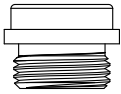

SEAT USED: LF648550

LENGTH: 2.30"

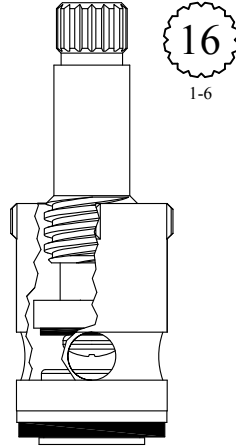

16
1-6

SEAT INCLUDED:
 LF647850

LF462051
 LF462052

LENGTH: 2.30"

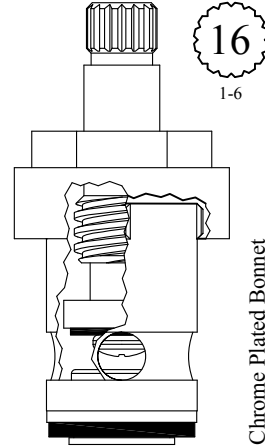

Chrome Plated Bonnet

SEAT INCLUDED:
 LF647850

LF462151
 LF462152

LENGTH: 2.38"

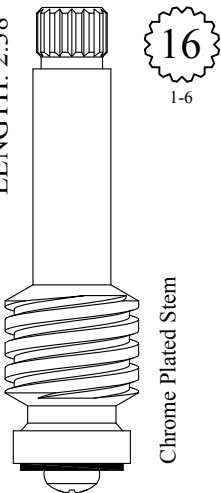

Chrome Plated Stem

LF263311
 LF263312

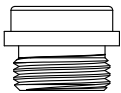

SEAT USED: LF648550

LENGTH: 2.40"

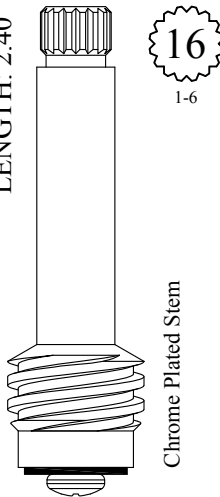

Chrome Plated Stem

LF263211
 LF263211

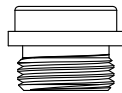

SEAT USED: LF648550

LENGTH: 2.42"

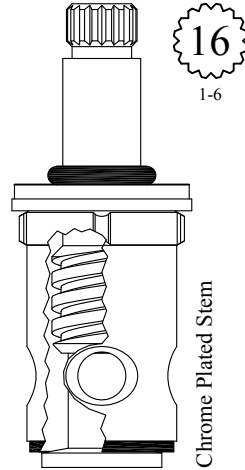

Chrome Plated Stem

LF463201
 LF463202

FOR CENTRAL

LENGTH: 2.42"

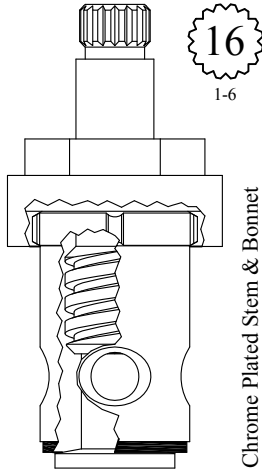

Chrome Plated Stem & Bonnet

LF463211
LF463212

LENGTH: 2.56"

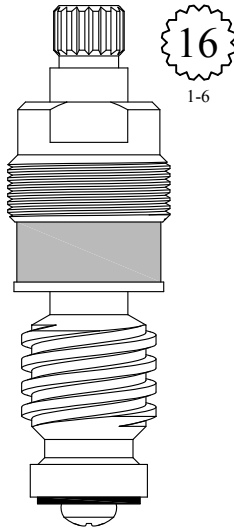

LF464101
LF464102
LF264101 Stem Only
LF264102 Stem Only



SEAT USED: LF648550

LENGTH: 2.65"

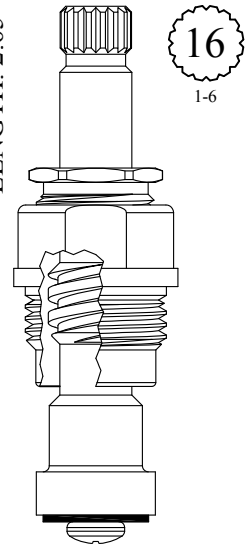

GASKET: 895100
LF464801
LF464802

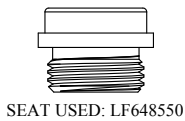

SEAT USED: LF648550

LENGTH: 2.66"

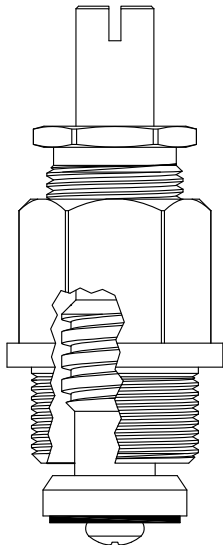

GASKET: 895400
401611
201611 Stem Only

LENGTH: 2.66"

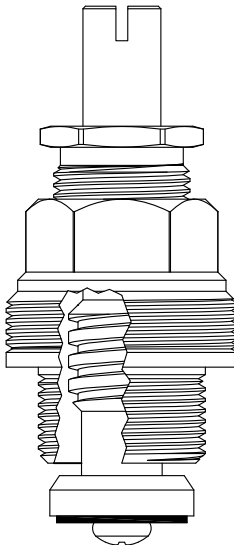

GASKET: 895400
401621
201611 Stem Only

LENGTH: 2.66"

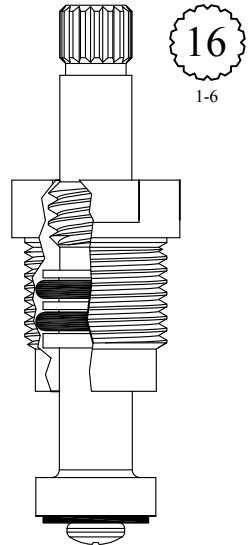

GASKET: 895100
LF464811
LF464812

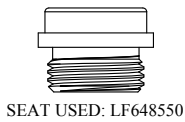

SEAT USED: LF648550

FOR CENTRAL

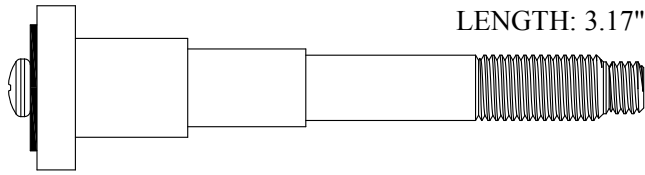

LF267150

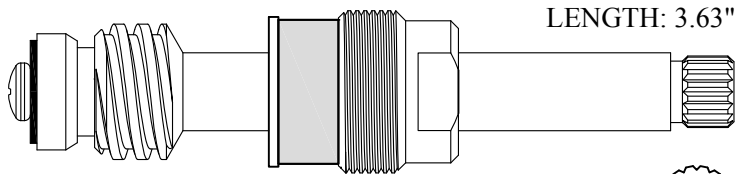

LF469021/ LF469022
LF269021/ LF269022 Stem Only

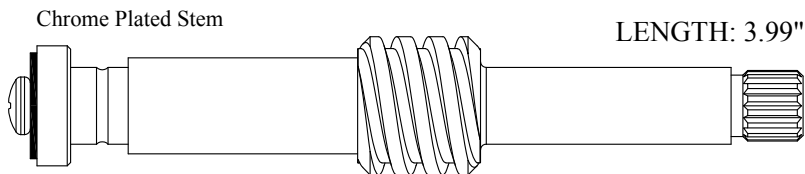

LF269201/ LF269202

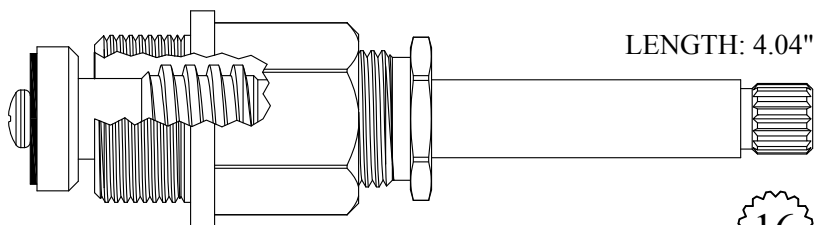
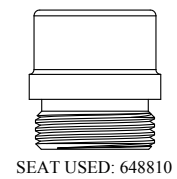

404401/ 404402
204401/ 204402 Stem Only
GASKET: 895400



FOR CENTRAL

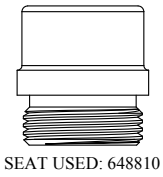

SEAT USED: 648810

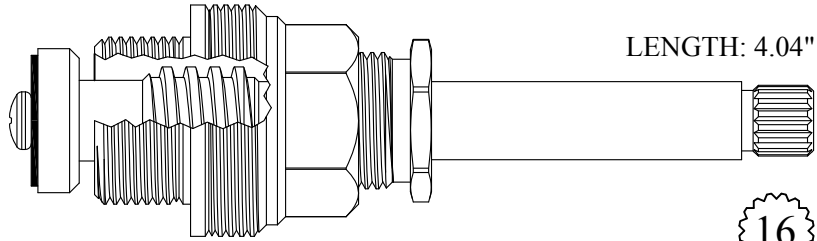

LENGTH: 4.04"

16
1-6

404411/ 404412
204401/ 204402 Stem Only
GASKET: 895400

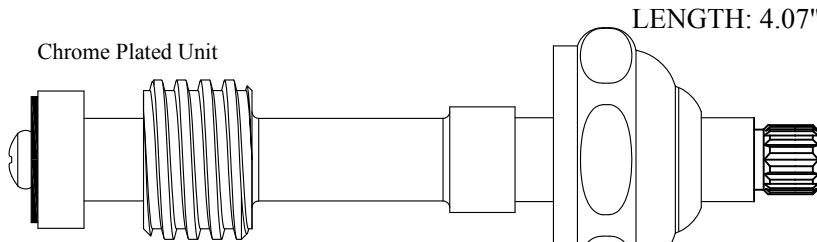

LENGTH: 4.07"

Chrome Plated Unit

404651

Supplied with
12pt. Broach

12
1-2

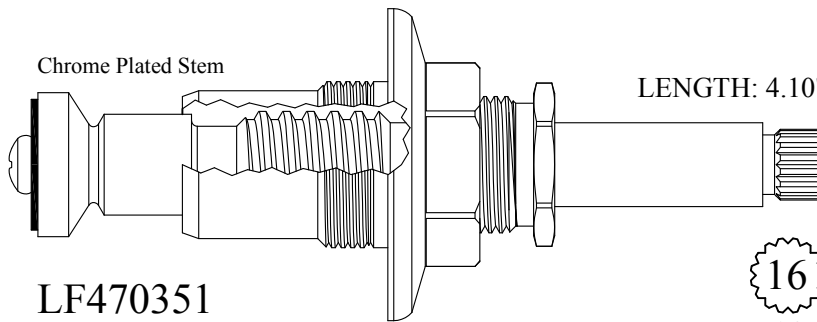

LENGTH: 4.10"

Chrome Plated Stem

LF470351

GASKET: 895410

16
1-6

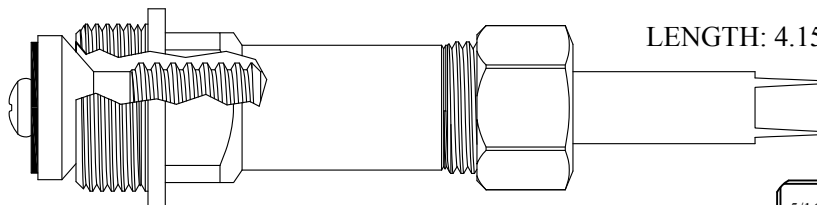

LENGTH: 4.15"

5/16

TAPERED

470771
GASKET: 895400

FOR CENTRAL

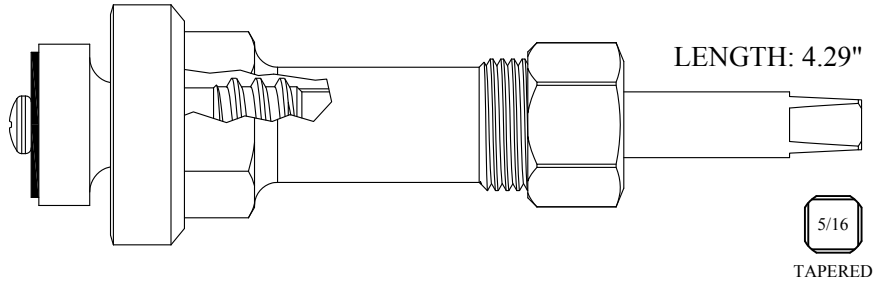

LENGTH: 4.29"

5/16
TAPERED

470751

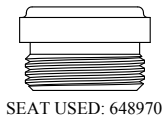

SEAT USED: 648970

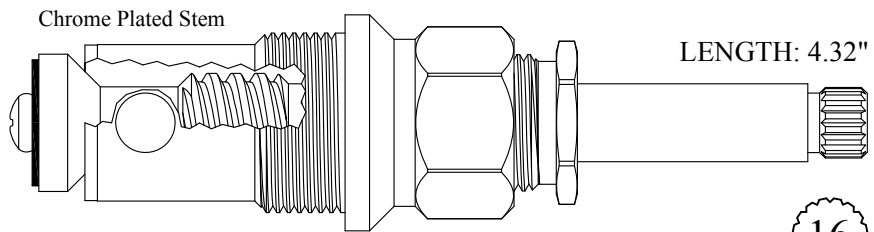

Chrome Plated Stem

LENGTH: 4.32"

16
1-6

430401
230401 Stem Only
GASKET: 895370

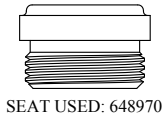

SEAT USED: 648970

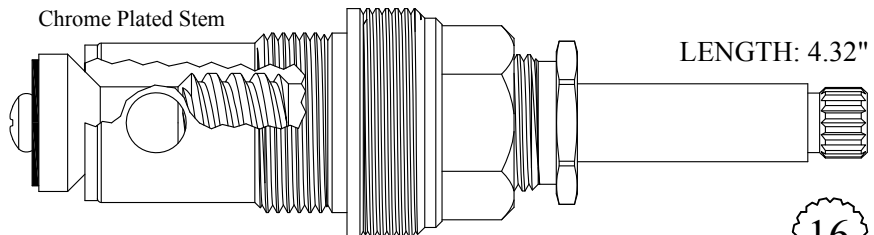

Chrome Plated Stem

LENGTH: 4.32"

16
1-6

430411
230401 Stem Only
GASKET: 895370

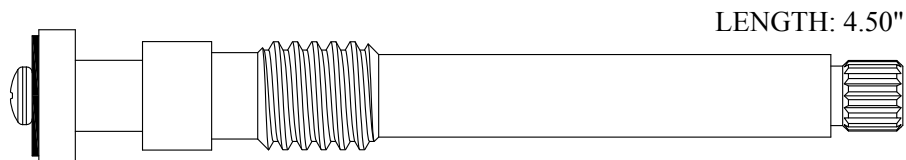

LENGTH: 4.50"

16
1-6

207221

FOR CENTRAL

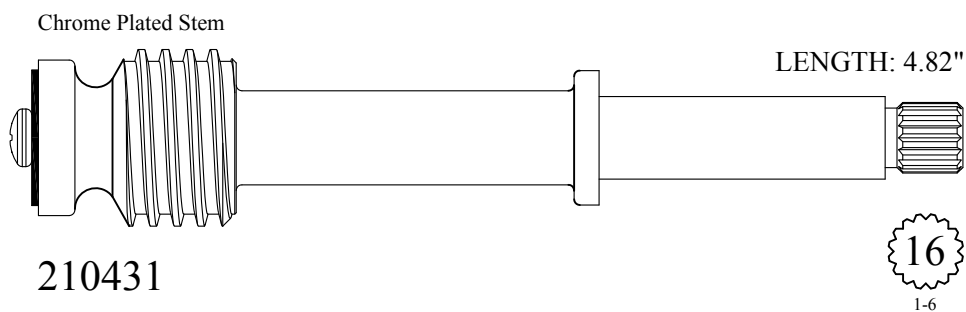
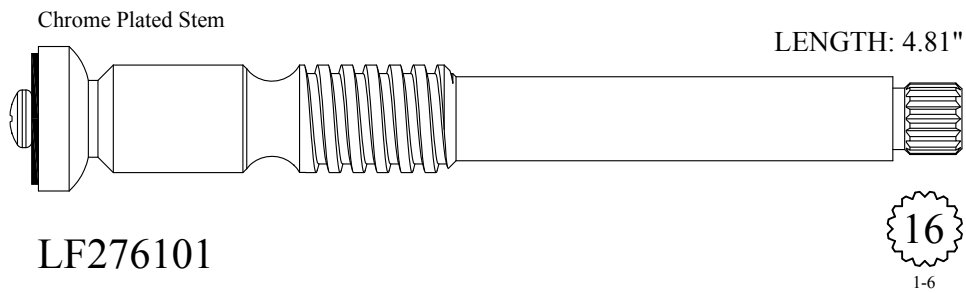
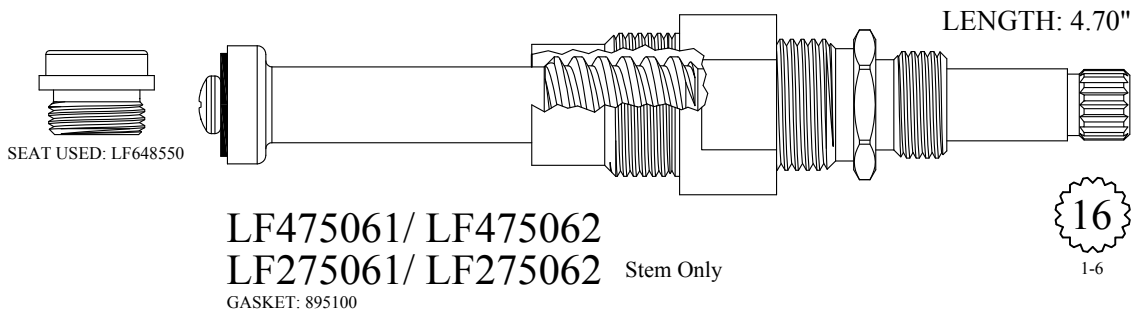
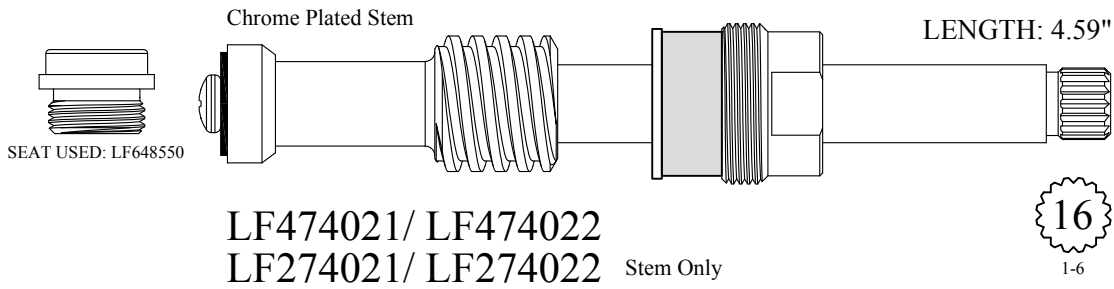

FOR CENTRAL

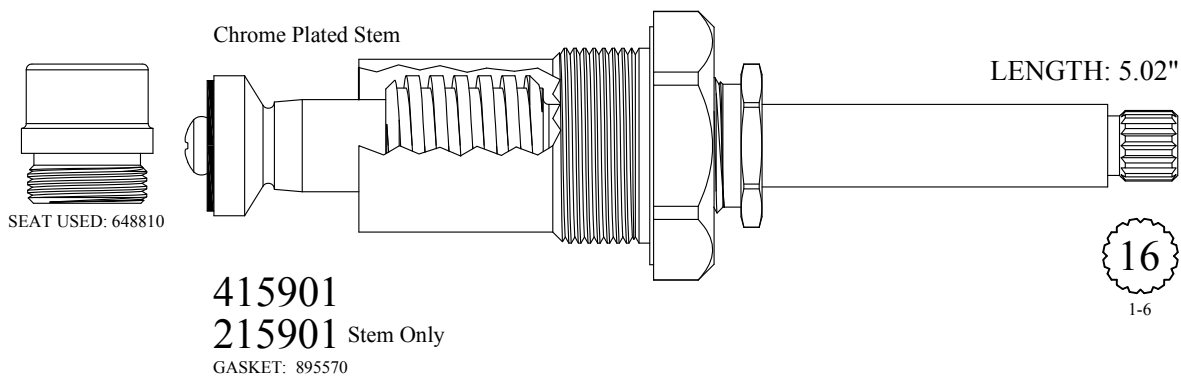
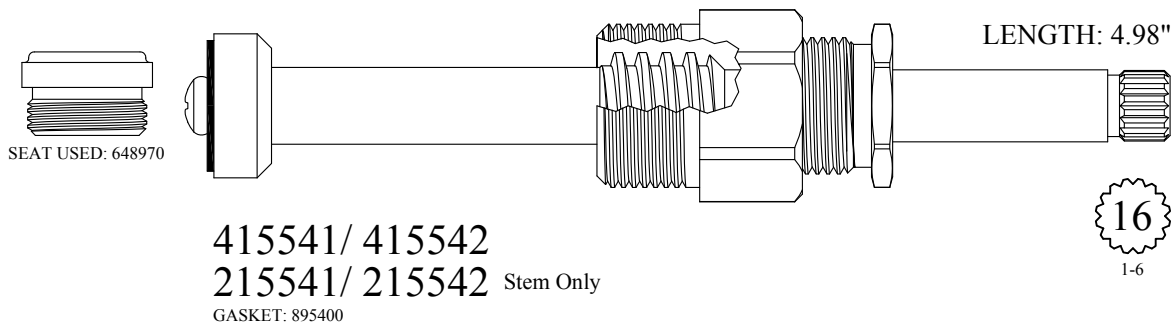
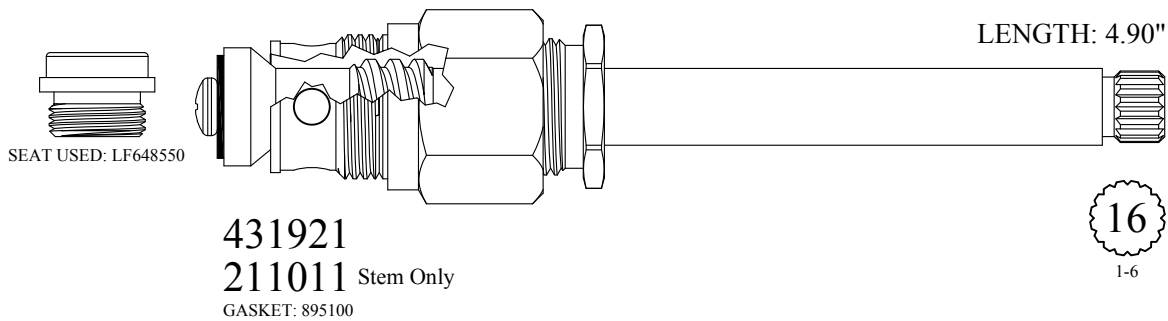
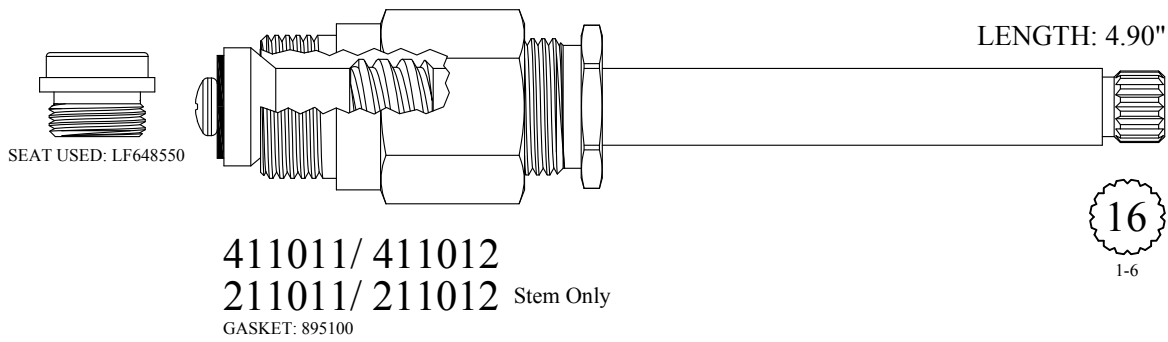

FOR CENTRAL

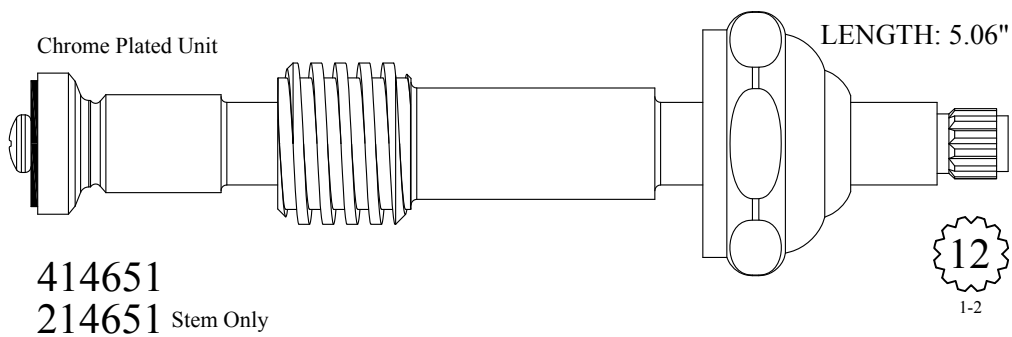
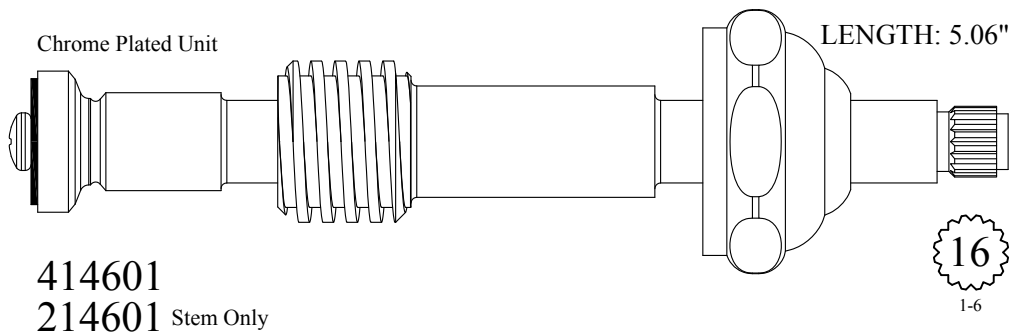
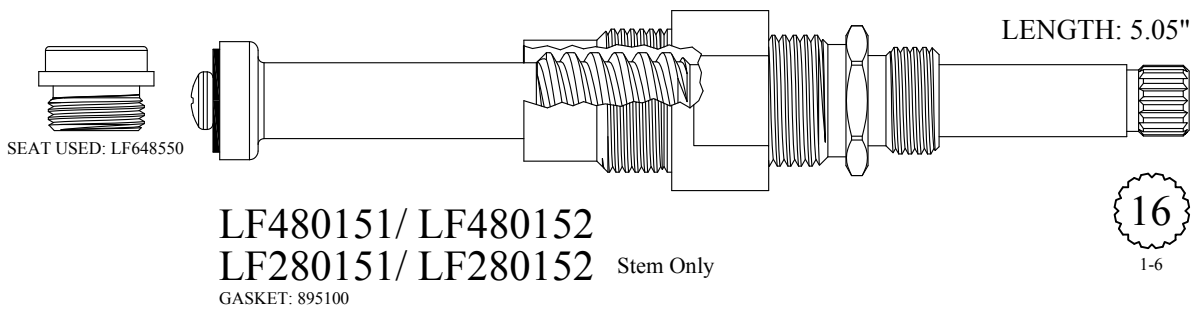
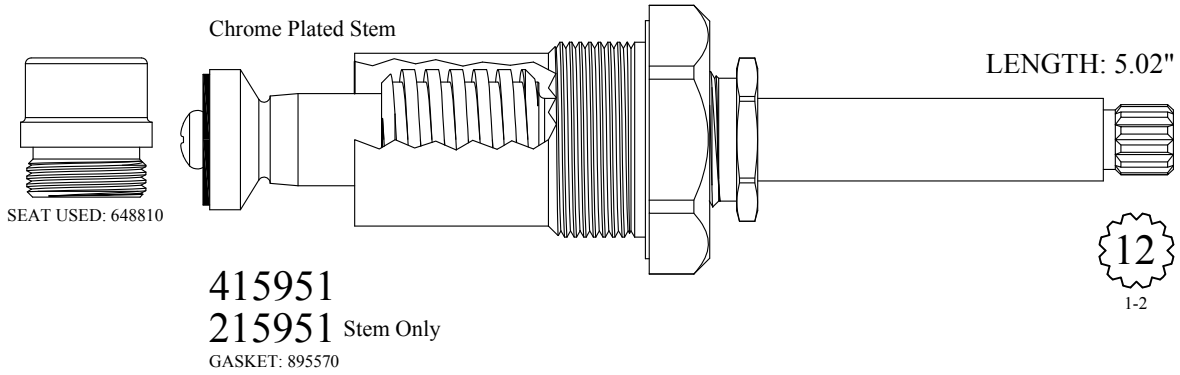

FOR CENTRAL

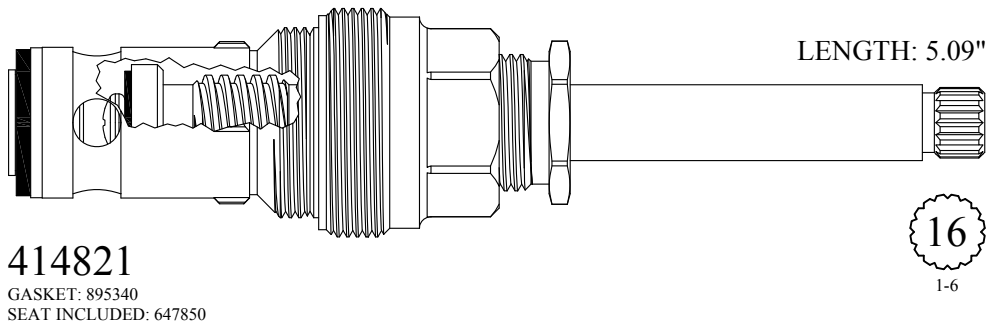
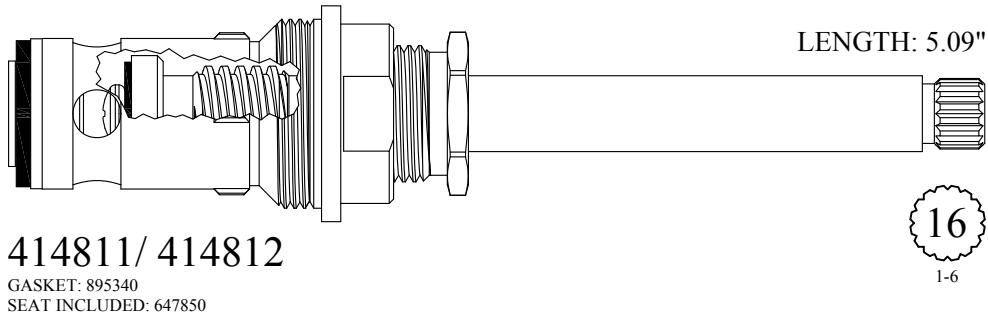
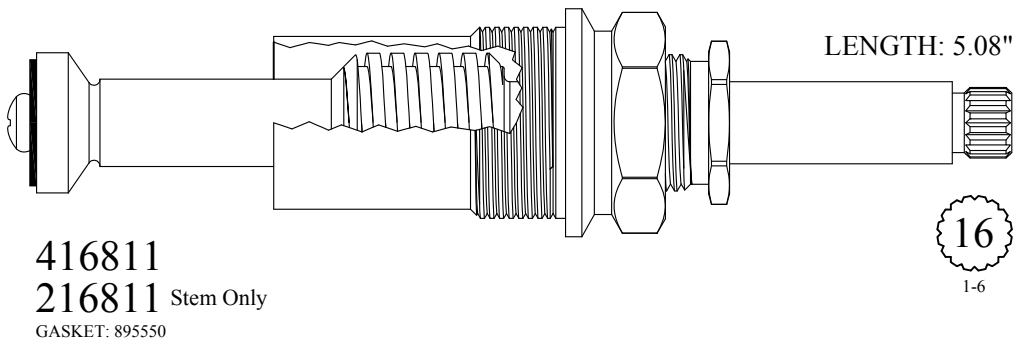
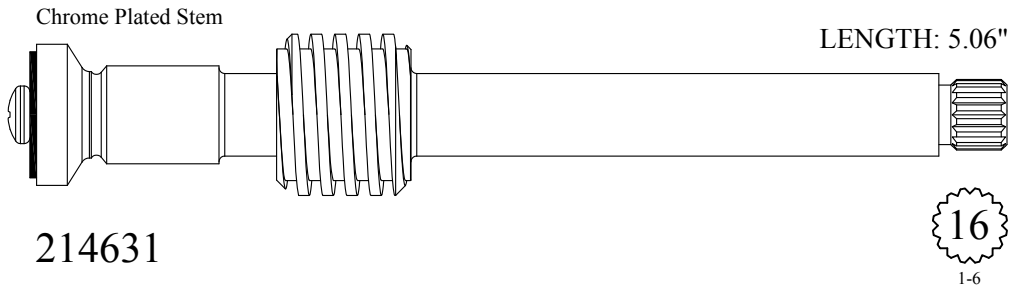

FOR CENTRAL

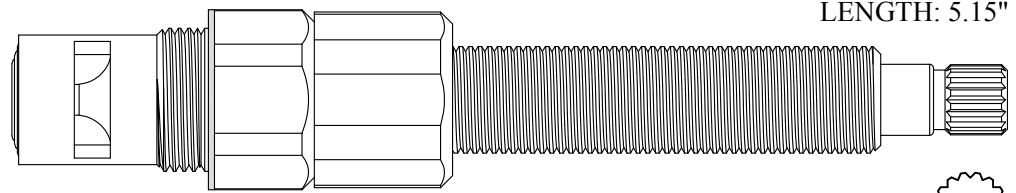

LENGTH: 5.15"

416821/ 416822

GASKET: 895270 INCLUDED
SEAL: 898500
DISC SET: 112530-PKG

16
1-6

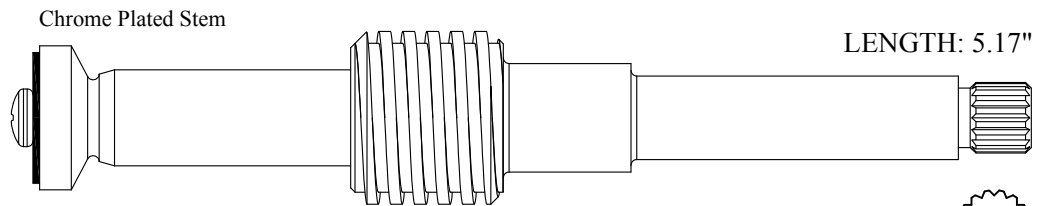

LENGTH: 5.17"

215621

16
1-6

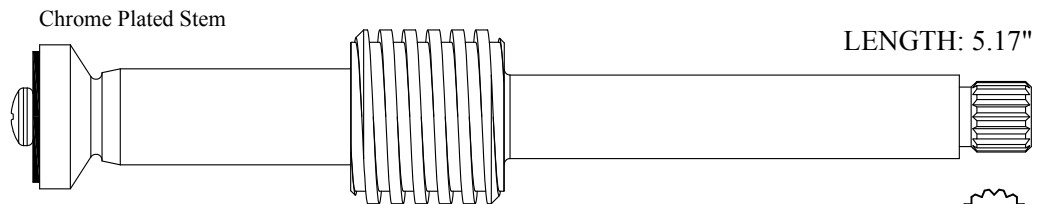

LENGTH: 5.17"

217811

16
1-6

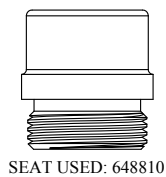

SEAT USED: 648810

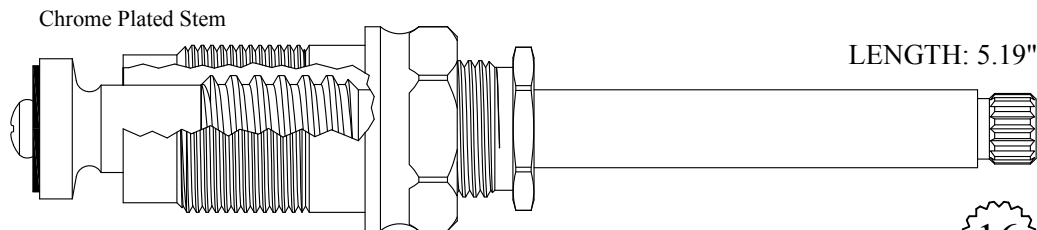

LENGTH: 5.19"

416801

216801 Stem Only

GASKET: 895400

16
1-6

FOR CENTRAL

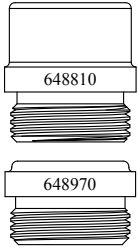

SEAT USED: 648810 or 648970

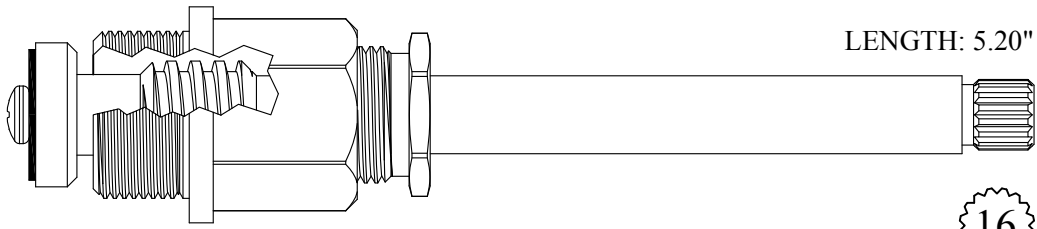

LENGTH: 5.20"

415801/ 415802
215801/ 215802 Stem Only
 GASKET: 895400

Also available with chrome plated stem

415831/ 415832
215821/ 215822 Stem Only

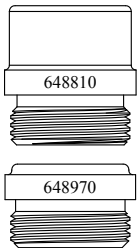

SEAT USED: 648810 or 648970

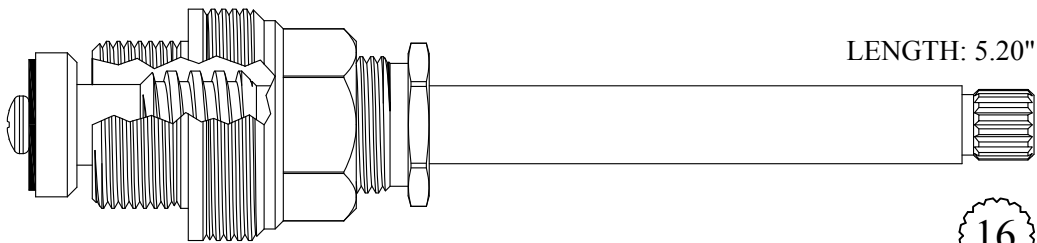

LENGTH: 5.20"

415811/ 415812
215801/ 215802 Stem Only
 GASKET: 895400

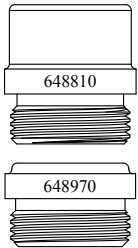

SEAT USED: 648810 or 648970

Chrome Plated Stem

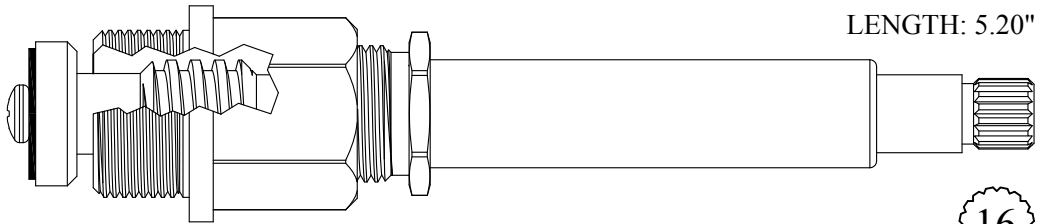

LENGTH: 5.20"

415821/ 415822
215821/ 215822 Stem Only
 GASKET: 895400

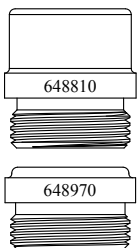

SEAT USED: 648810 or 648970

Chrome Plated Stem

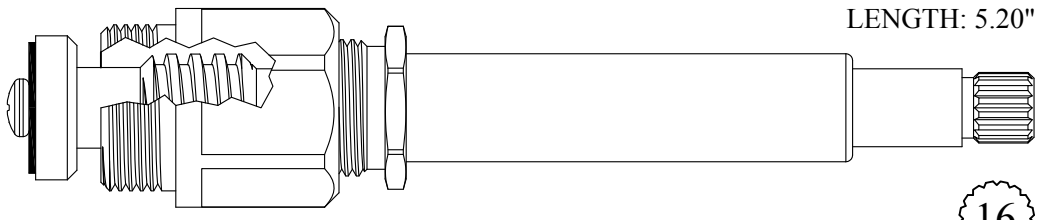

LENGTH: 5.20"

415841
215821 Stem Only
 GASKET: 895400



FOR CENTRAL

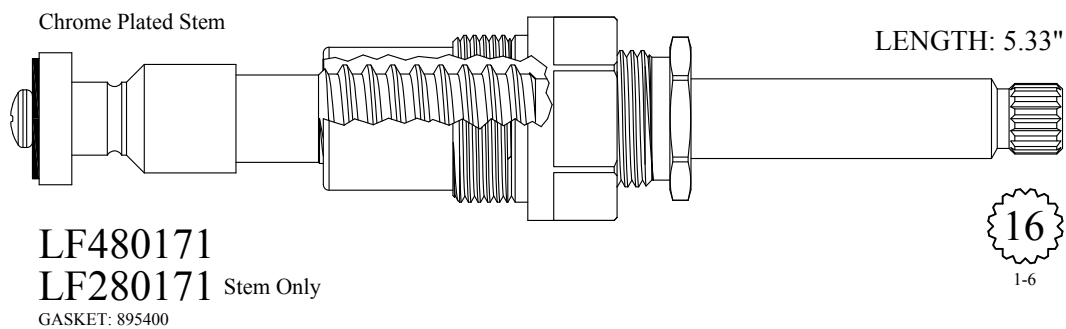
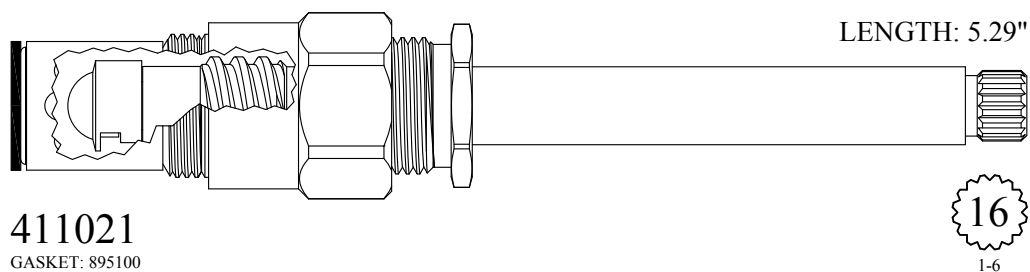
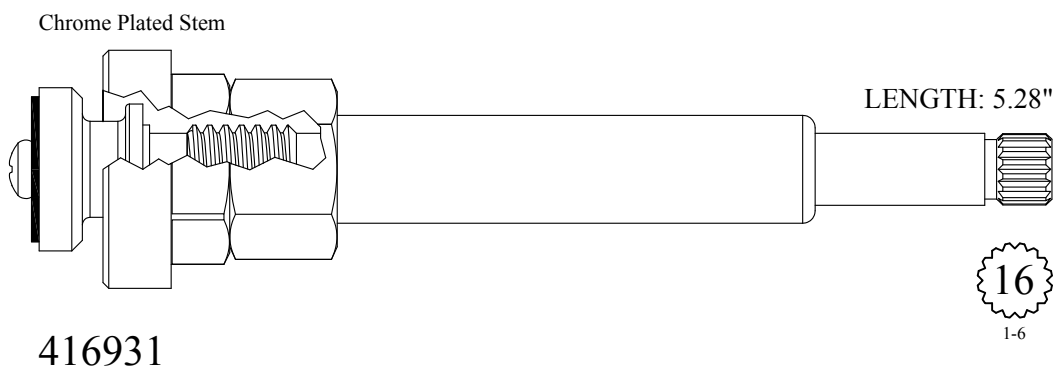
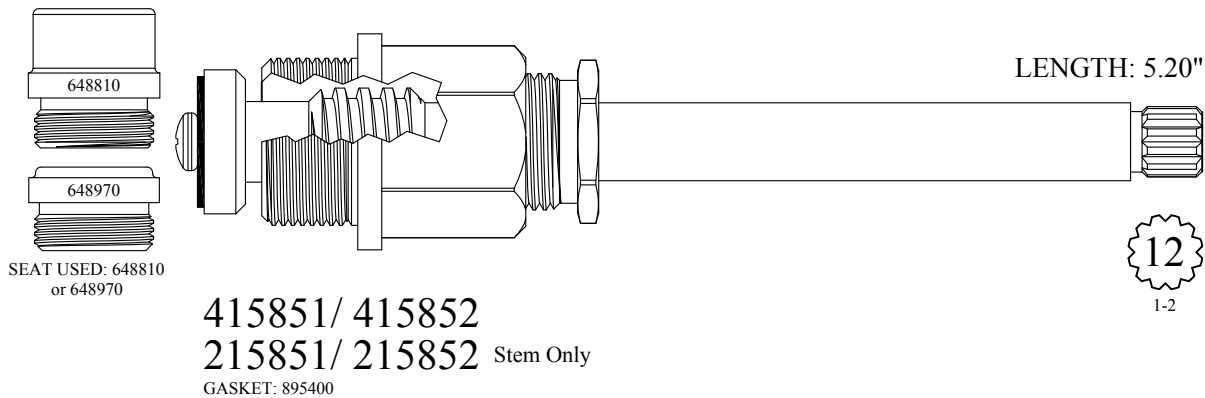

FOR CENTRAL

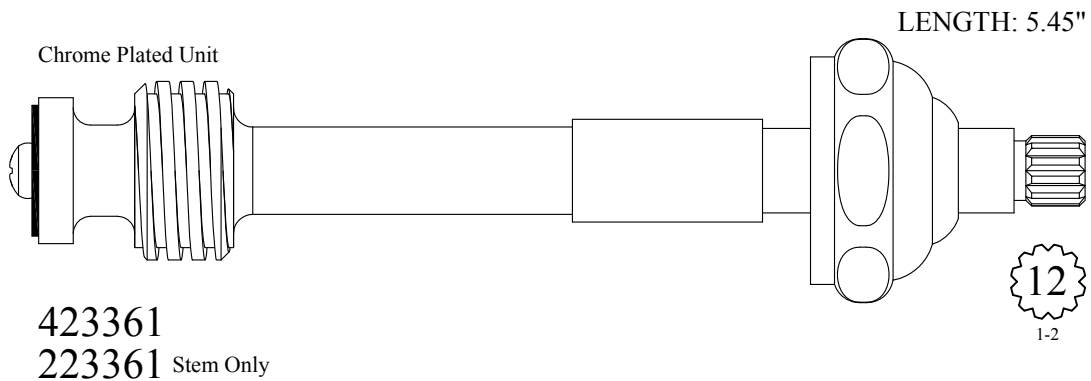
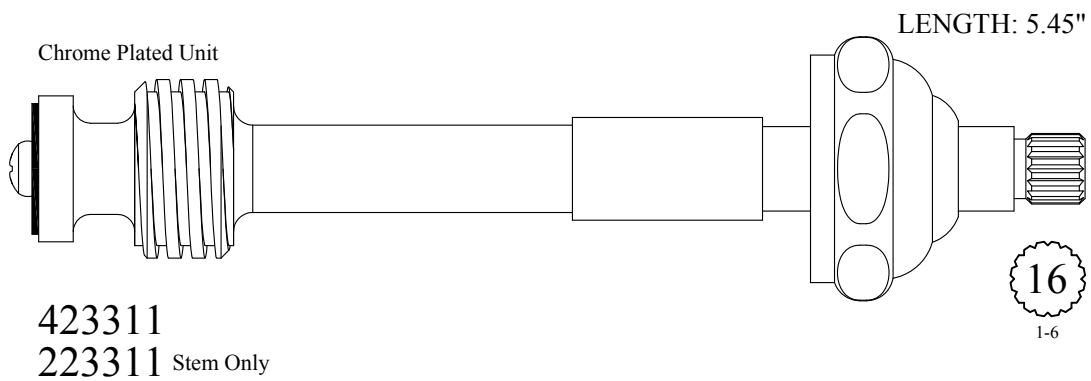
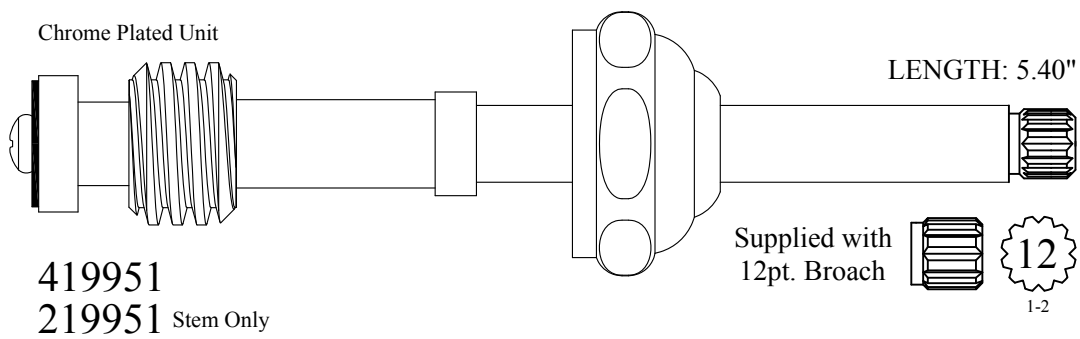
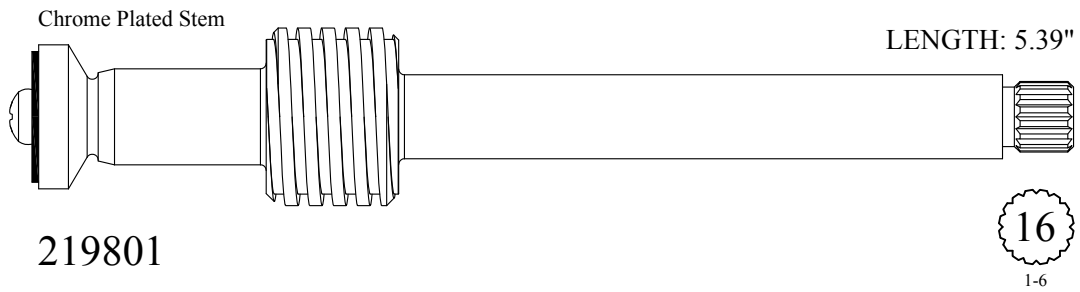

FOR CENTRAL



222201

16
1-6

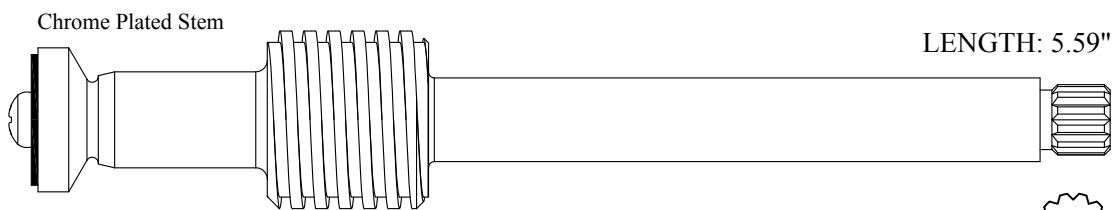

222251

12
1-2

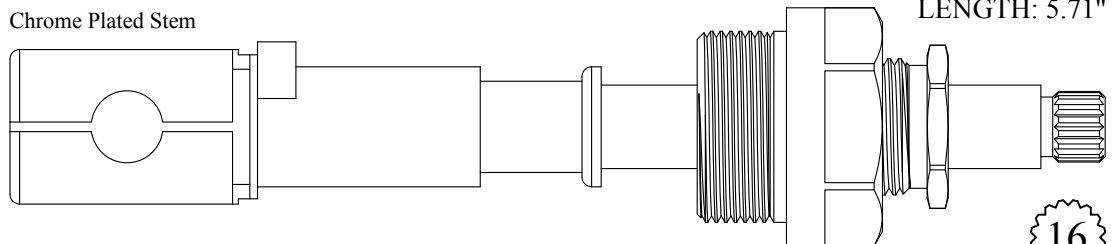

437410
237410 Stem Only
GASKET: 895550

16
1-6

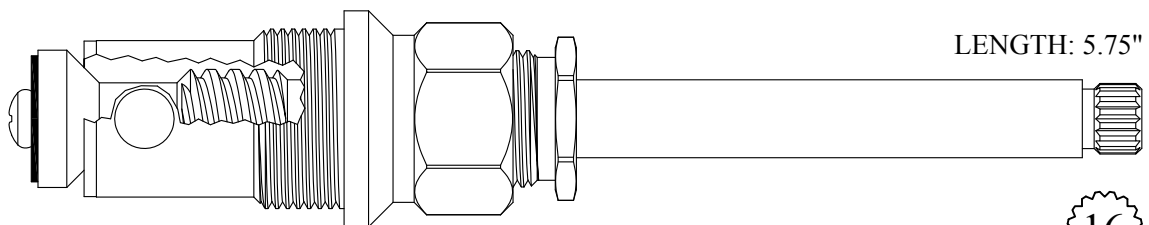

436101
236101 Stem Only
GASKET: 895370

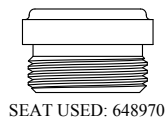

SEAT USED: 648970

16
1-6

FOR CENTRAL

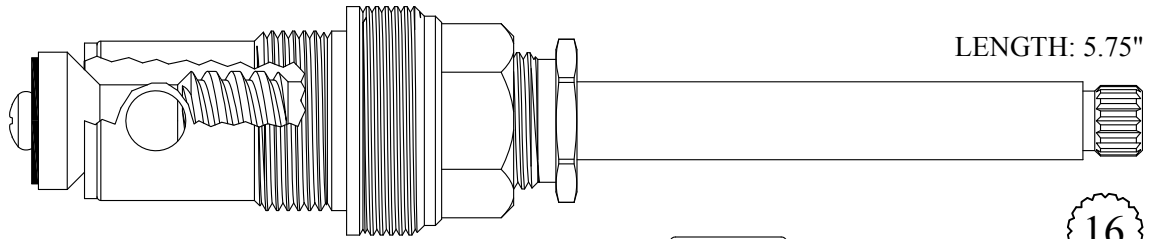

436111
236101 Stem Only
GASKET: 895370



16
1-6

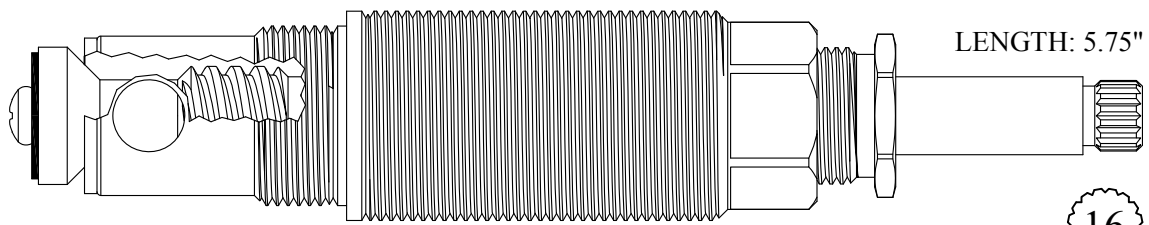

436141
236101 Stem Only
GASKET: 895370



16
1-6

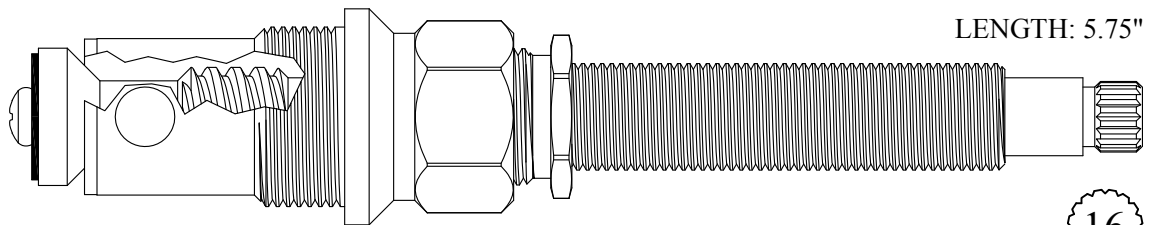

436161
236101 Stem Only
GASKET: 895370

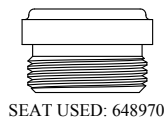

16
1-6

Chrome Plated Stem

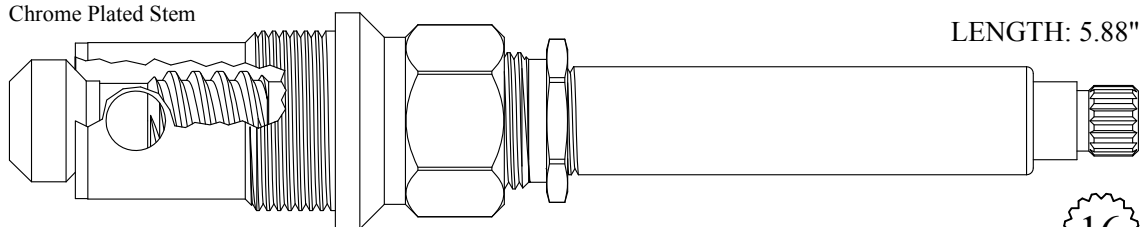

436121
236121 Stem Only
GASKET: 895370

16
1-6

FOR CENTRAL



426211/ 426212
226211/ 226212 Stem Only
GASKET: 895100



SEAT USED: LF648550

16
1-6

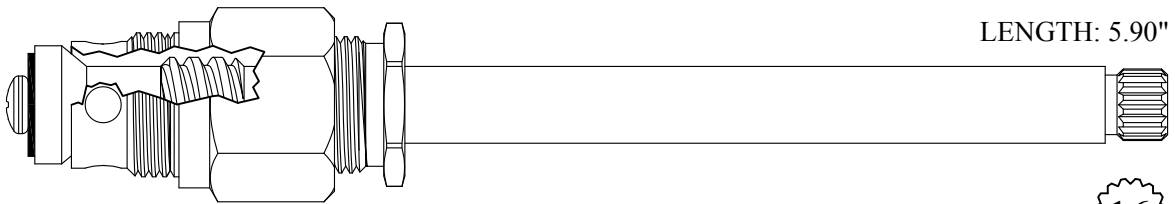

436231
226211 Stem Only
GASKET: 895100



SEAT USED: LF648550

16
1-6

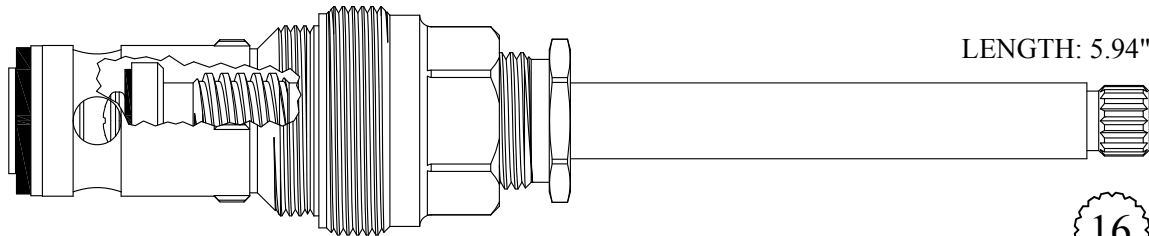

424711
GASKET: 895340
SEAT INCLUDED : 647850

16
1-6

Chrome Plated Unit

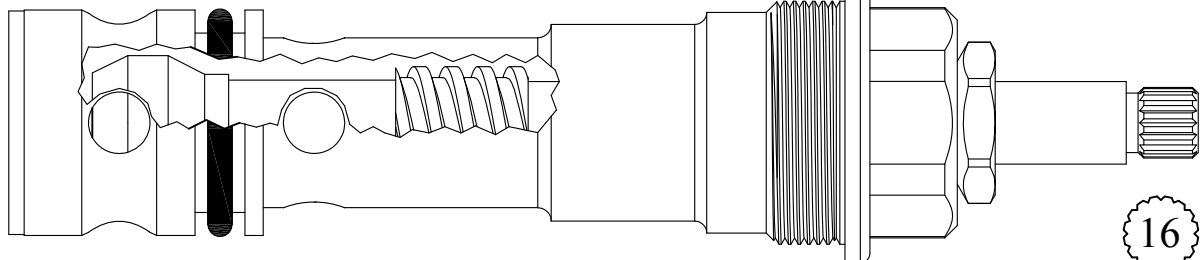

438671
238741 Stem Only

16
1-6

FOR CENTRAL

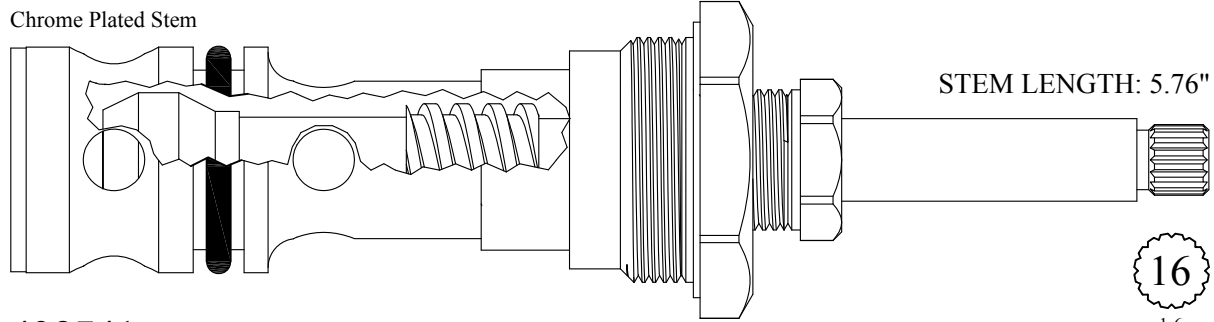

438741
238741 Stem Only

16
1-6

FOR CHASE

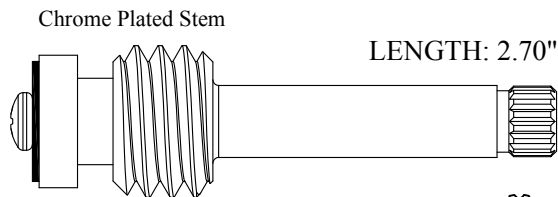

LF264171

16
1-6

FOR CHATSWORTH

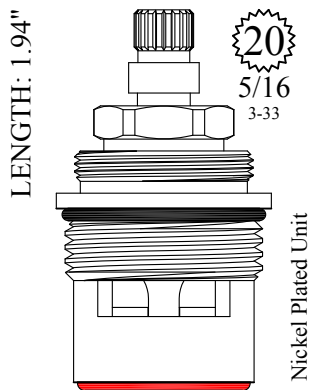

GASKET: 890210 O-RING INCLUDED
SEAL: 898610-R
DISC SET: 109850-PKG

400971
400972

FOR CHG

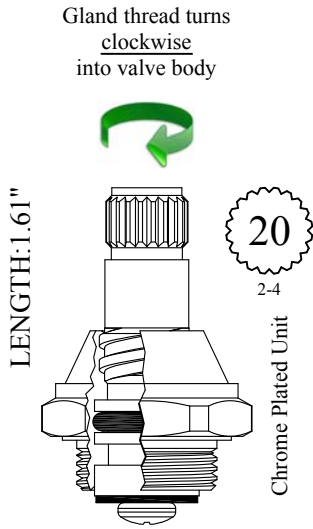

GASKET: 895100

LF455411
LF455412

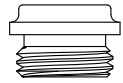

SEAT USED: LF648270

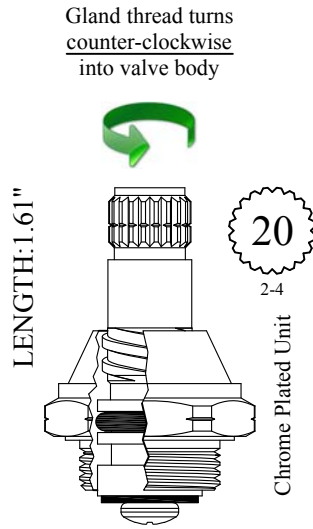

GASKET: 895100

LF455462

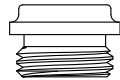

SEAT USED: LF648270

Gland thread turns clockwise into valve body

Knurled lock ring also available

952900

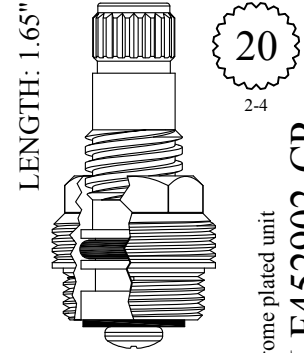

GASKET: 895100

LF452901
LF452902

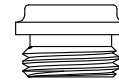

SEAT USED: LF648270

Also available as chrome plated unit

LF452901-CP/ LF452902-CP

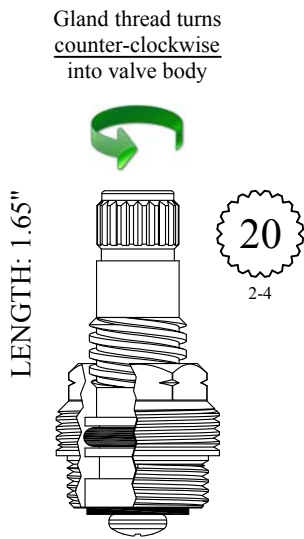

GASKET: 895100

LF452922

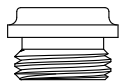

SEAT USED: LF648270

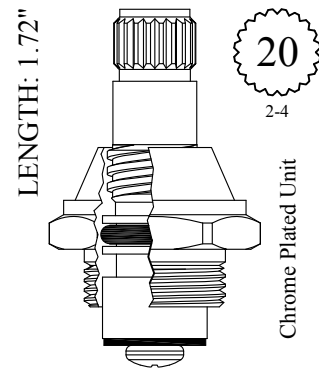

GASKET: 895100

LF455401
LF455402



SEAT USED: LF648270

FOR CHG

STEM LENGTH: 1.94"

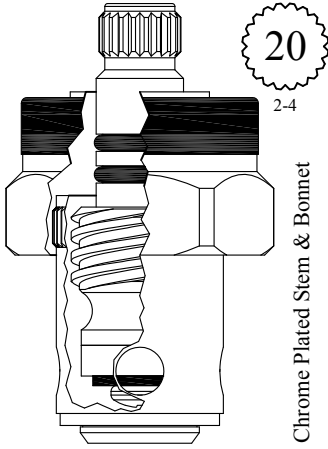

LF462571
LF462572

STEM LENGTH: 2.29"

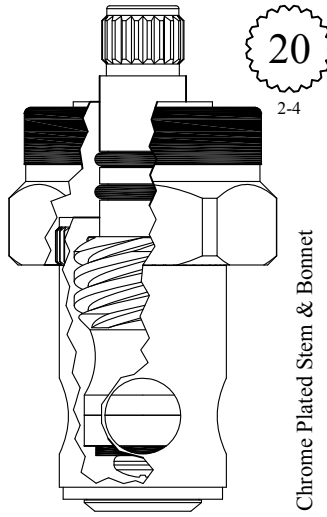

LF463921
LF463922

STEM LENGTH: 2.56"

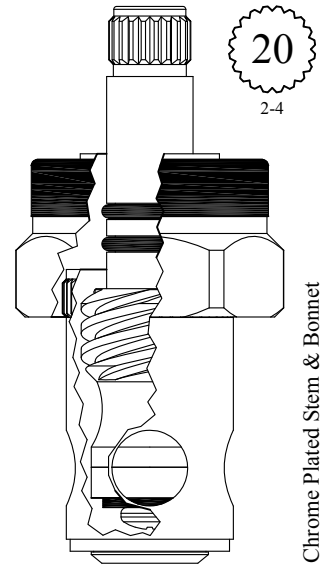

LF466481
LF466482

Send Your Orders To:

BARRY E.  SR. CO.

E-mail: orderdesk@barrywalter.com

Fax: 1.800.886.9831

Phone: 1.800.767.5552

FOR CHICAGO

CERAMIC 1/4 TURN

LENGTH: 2.09"

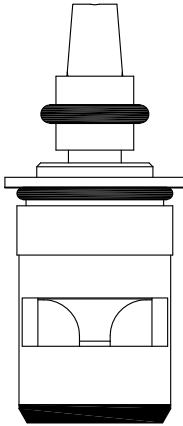

Nickel Plated Stem

GASKET: 890170 O-RING INCLUDED
SEAL: 898590
DISC SET: 151380-PKG

LF459411
LF459412

SLOW COMPRESSION

LENGTH: 2.65"

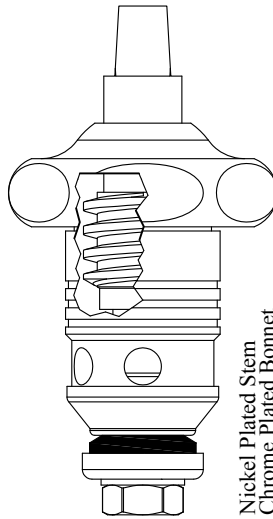

Nickel Plated Stem
Chrome Plated Bonnet

GASKET: 895200
SEAT INCLUDED: 648750

LF464991
LF464992

SLOW COMPRESSION

LENGTH: 2.65"

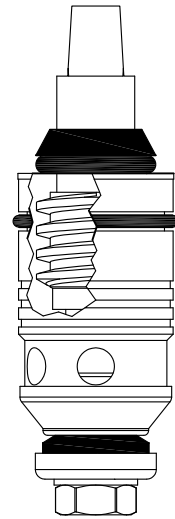

Nickel Plated Stem

GASKET: 895200
SEAT INCLUDED: 648750

LF465001
LF465002

QUATURN

LENGTH: 2.65"

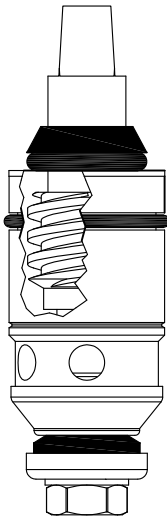

Nickel Plated Stem

GASKET INCLUDED: 895200
SEAT INCLUDED: 648750

LF465041
LF465042

QUATURN

LENGTH: 2.65"

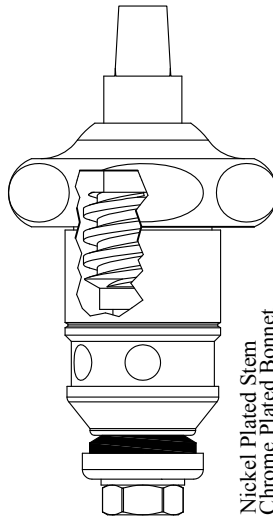

Nickel Plated Stem
Chrome Plated Bonnet

GASKET: 895200
SEAT INCLUDED: 648750

LF465051
LF465052

SLOW COMPRESSION
CONTROL-A-FLOW

LENGTH: 2.65"

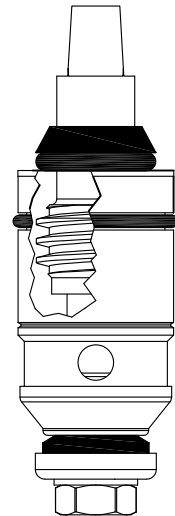

Nickel Plated Stem

GASKET: 895200
SEAT INCLUDED: 648750

LF465231
LF465232

FOR CHICAGO

QUATURN
CONTROL-A-FLOW

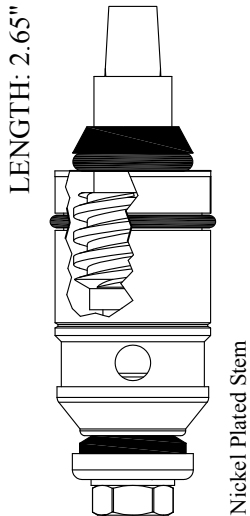

GASKET: 895200
SEAT INCLUDED: 648750

LF465241
LF465242

NEW STYLE
QUATURN

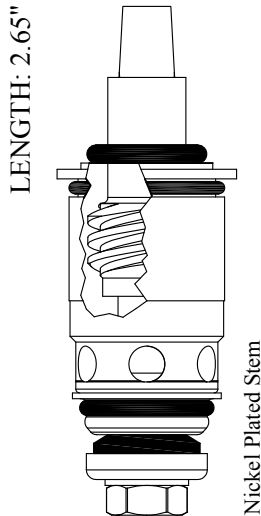

GASKET: 895200
SEAT INCLUDED: 648750

LF465221
LF465222

NEW STYLE
SLOW COMPRESSION

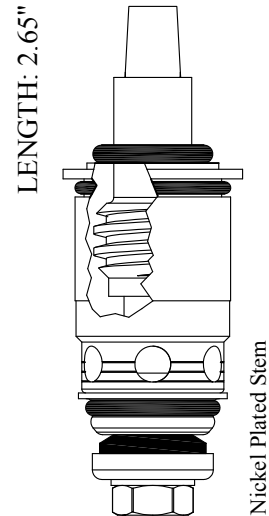

GASKET: 895200
SEAT INCLUDED: 648750

LF465281
LF465282

CERAMIC 1/4 TURN

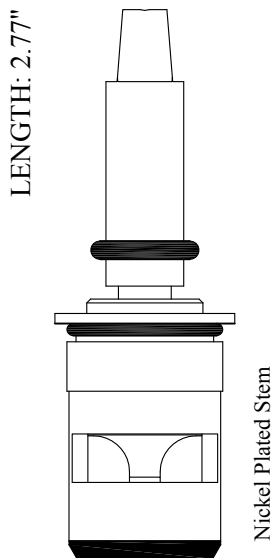

GASKET: 890170 O-RING INCLUDED
SEAL: 898590
DISC SET: 151380-PKG

LF465461
LF465462

QUATURN

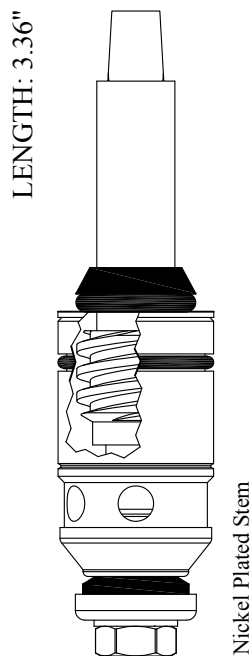

GASKET: 895200
SEAT INCLUDED: 648750

LF467091
LF467092

SLOW COMPRESSION

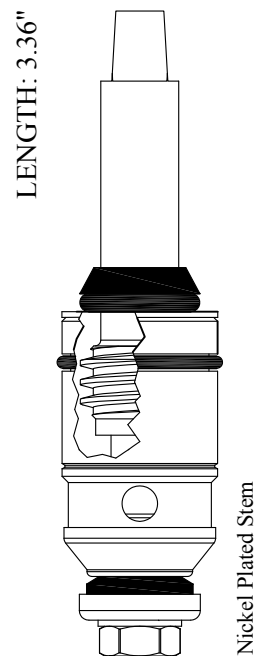

GASKET: 895200
SEAT INCLUDED: 648750

LF467101
LF467102

FOR CHICAGO

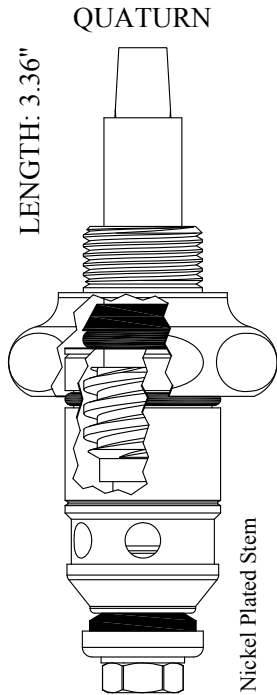

GASKET: 895200
SEAT INCLUDED: 648750

LF467181
LF467182

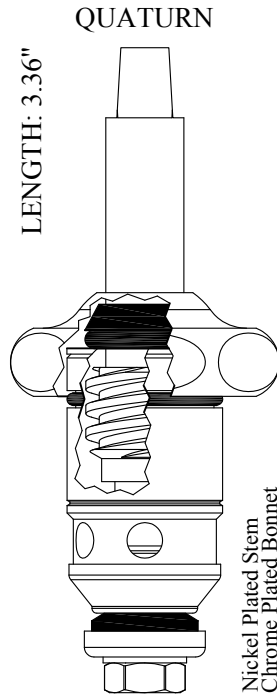

GASKET: 895200
SEAT INCLUDED: 648750

LF467191
LF467192

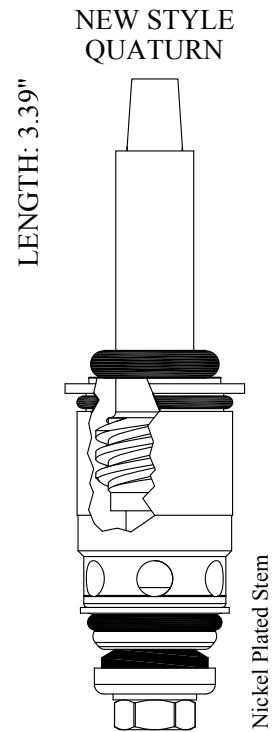

GASKET: 895200
SEAT INCLUDED: 648750

LF467131
LF467132

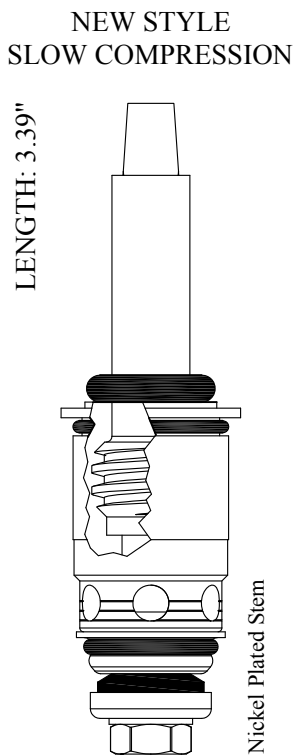

GASKET: 895200
SEAT INCLUDED: 648750

LF467221
LF467222

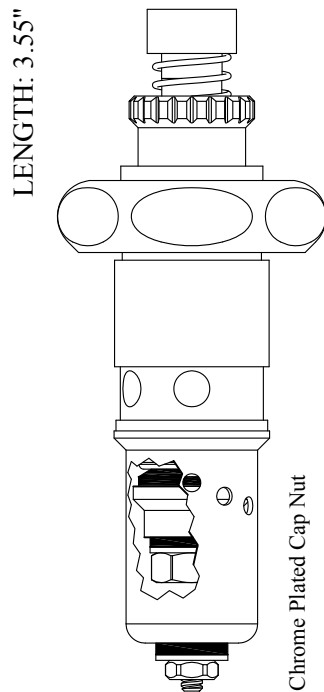

LF468320

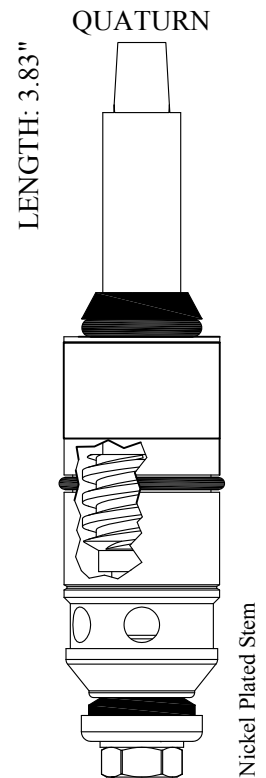

GASKET: 895200
SEAT INCLUDED: 648750

LF468901
LF468902

FOR CHICAGO

Nickel Plated Stem

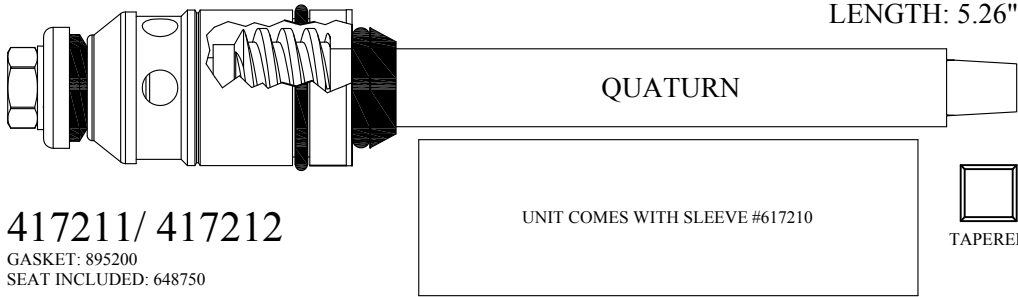

417211/ 417212

GASKET: 895200
SEAT INCLUDED: 648750

Nickel Plated Stem

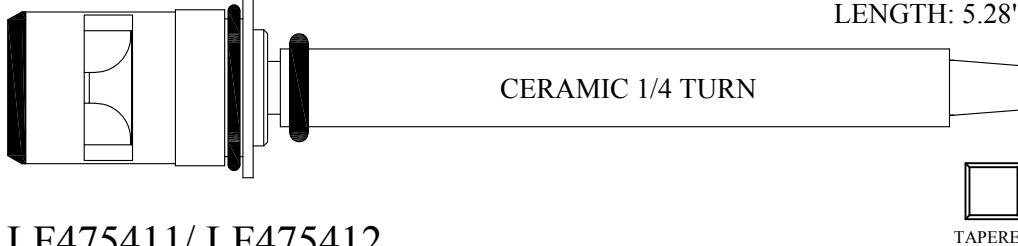

LF475411/ LF475412

GASKET: 890170 O-RING INCLUDED
SEAL: 898590
DISC SET: 151380-PKG

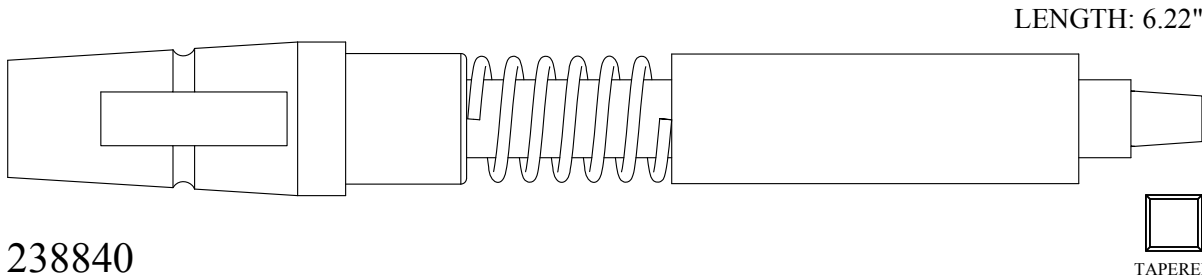

238840



Send Your Orders To:

BARRY E.  SR. CO.

E-mail: orderdesk@barrywalter.com

Fax: 1.800.886.9831

Phone: 1.800.767.5552



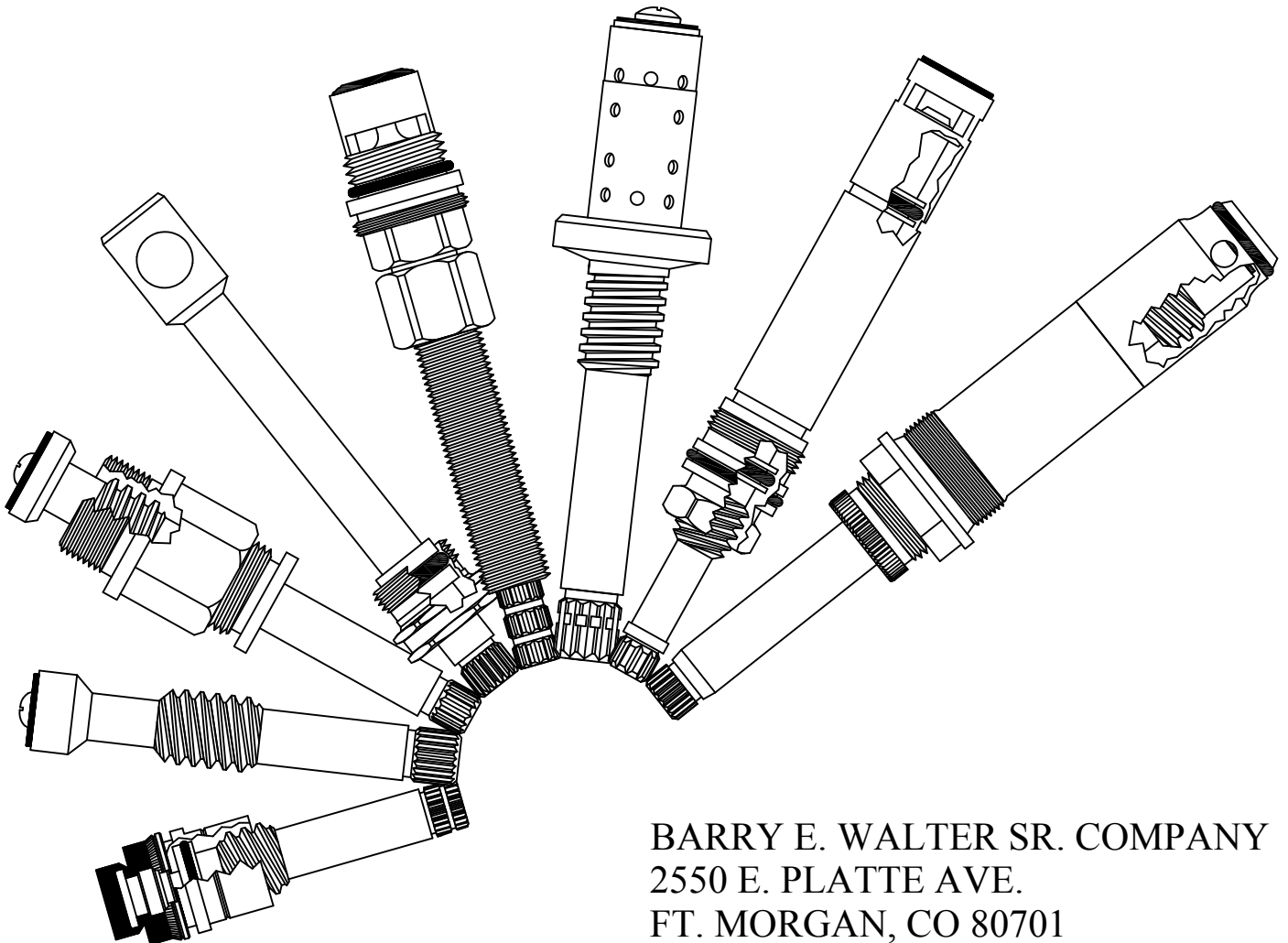

Quality Replacement Parts

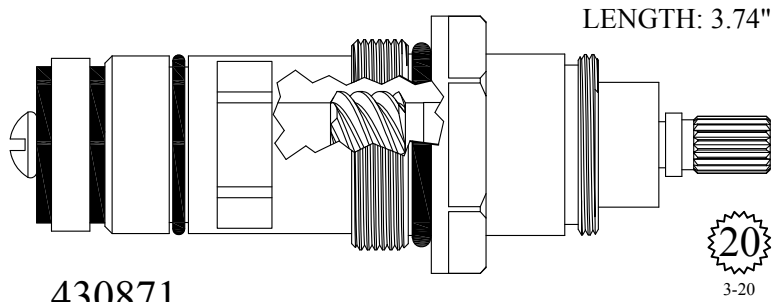

BARRY E. WALTER SR. COMPANY
2550 E. PLATTE AVE.
FT. MORGAN, CO 80701

FOR CIFIAL



430871

GASKET: 891180 O-RING INCLUDED

FOR CLEVELAND

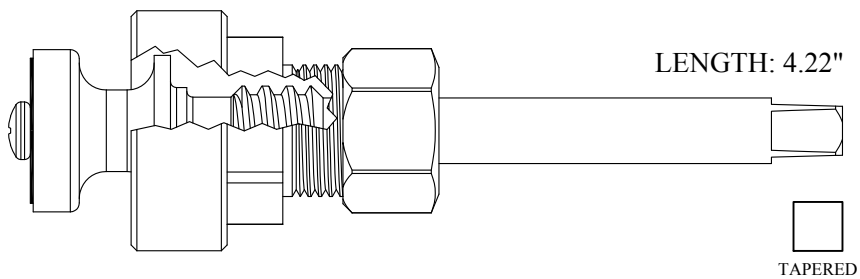

470791

FOR CONCINNITY

LENGTH: 0.94"

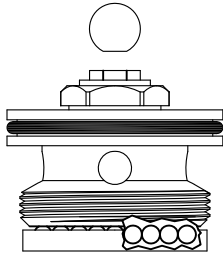

LF450111
LF450112

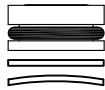

SEAT USED: 647140

LENGTH: 1.19"

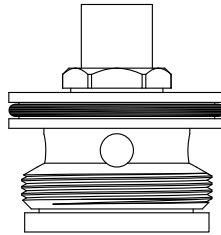

LF450161
LF450162

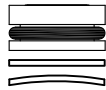

SEAT USED: 647140

FOR CONCINNITY
LENGTH 2.04"

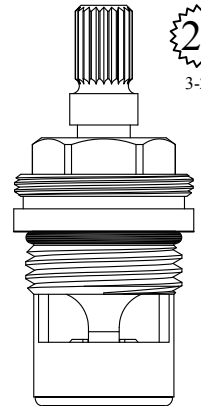

20
3-20

Chrome Plated Unit

GASKET: 890170 O-RING INCLUDED
SEAL: 898570-W
DISC SET: 151380-PKG

LF459231
LF459232

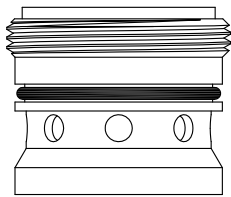

SEAT KIT USED: 106090

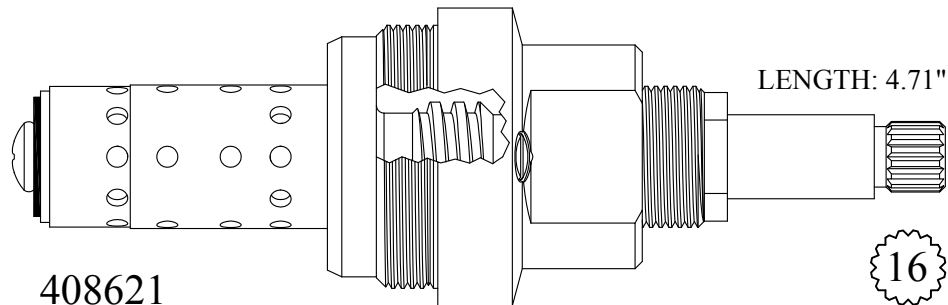

LENGTH: 4.71"

16
1-6

408621
208621 Stem Only
GASKET INCLUDED: 895500

FOR CONCINNITY

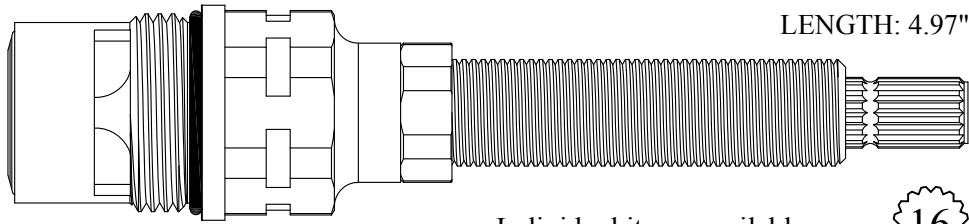

LENGTH: 4.97"

412031/ 412032

GASKET: 890210 O-RING INCLUDED
SEAL: 898520
DISC SET: 109850-PKG

Individual items available
Stem Ext. 3-1/4": #102960
Ext. Adap. Screw: #103310

16
1-6

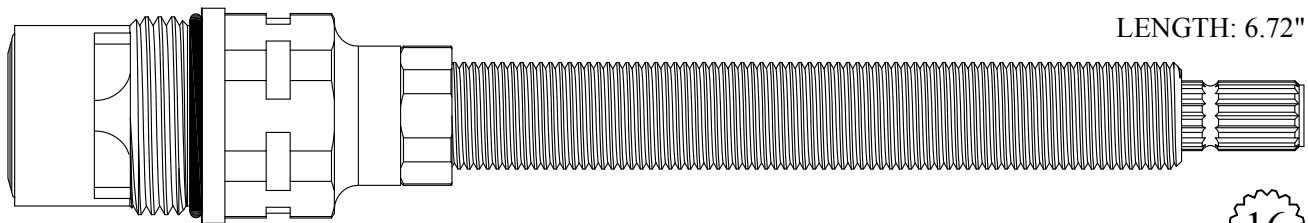
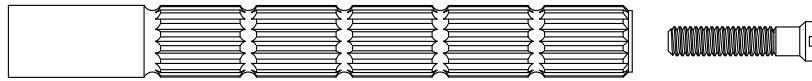

LENGTH: 6.72"

428031/ 428032

GASKET: 890210 O-RING INCLUDED
SEAL: 898520
DISC SET: 109850-PKG

Individual items available
Stem Ext. 5.00": #136050
Ext. Adap. Screw: #103310

16
1-6

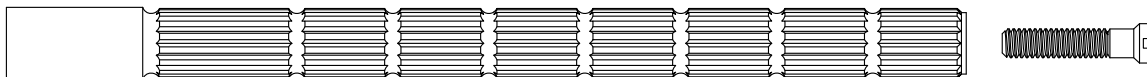

FOR COYNE DELANEY

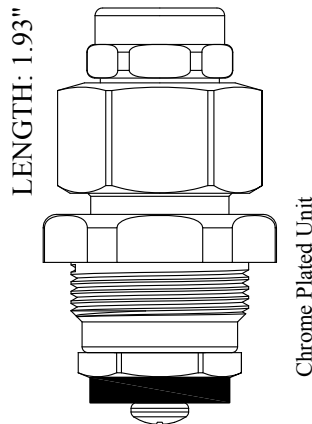

LENGTH: 1.93"

Chrome Plated Unit

GASKET INCLUDED: 895370

460302

FOR CRANE

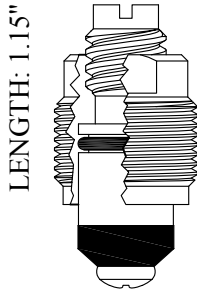

LENGTH: 1.15"

400201
200201 Stem Only

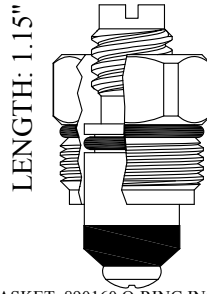

LENGTH: 1.15"

GASKET: 890160 O-RING INCLUDED
400211
200201 Stem Only

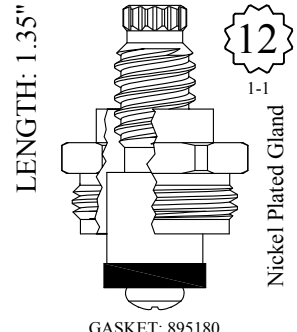

LENGTH: 1.35"

GASKET: 895180
400411
400412

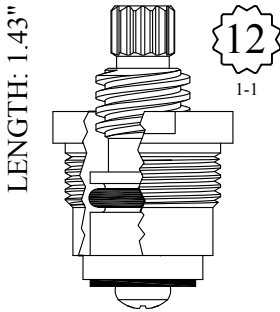

LENGTH: 1.43"

GASKET: 895180
LF451021
LF451022

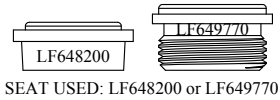

SEAT USED: LF648200 or LF649770

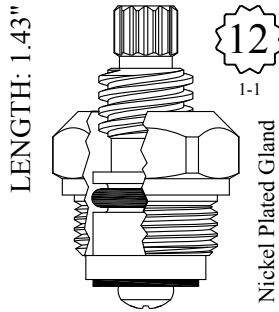

LENGTH: 1.43"

GASKET: 895100
LF451061
LF451062



SEAT USED: LF649430

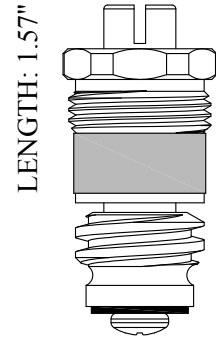

LENGTH: 1.57"

452821
252821 Stem Only

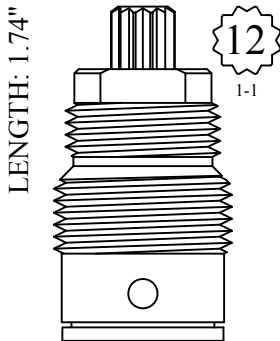

LENGTH: 1.74"

GASKET: 895250
LF453300

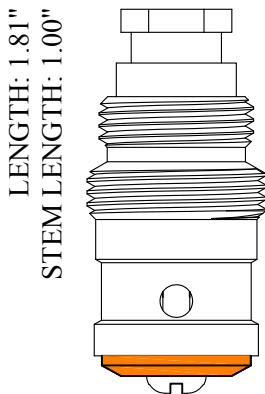

LENGTH: 1.81"
STEM LENGTH: 1.00"

GASKET: 895250
LF458700
LF258700 Stem Only



STEM LENGTH: 0.87"

Shorter version stem available
LF103990

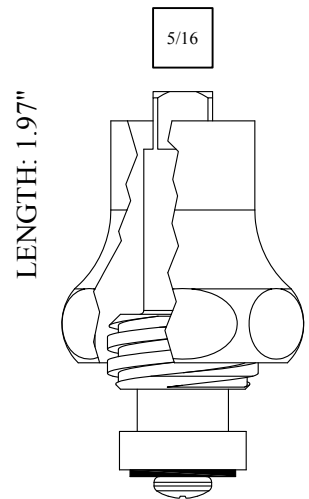

LENGTH: 1.97"

461541
261541 Stem Only

Also available with chrome plated bonnet
461541-CP

FOR CRANE

CERAMIC CONVERSION FOR DIAL-EZE
LENGTH: 2.08"

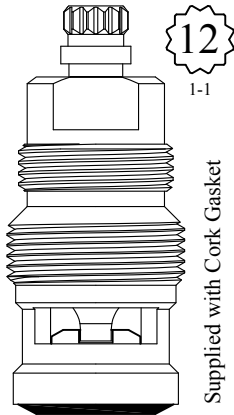

GASKET: 895250 INCLUDED
DISC SET: 151380-PKG

LF459521
LF459522

Supplied with Cork Gasket

LENGTH: 2.13"

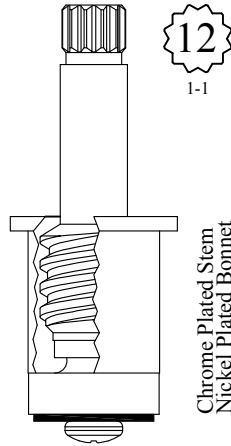

Chrome Plated Stem
Nickel Plated Bonnet

LF460041
LF460042

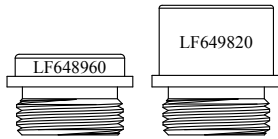

SEAT USED: LF648960 or LF649820

LENGTH: 2.20"

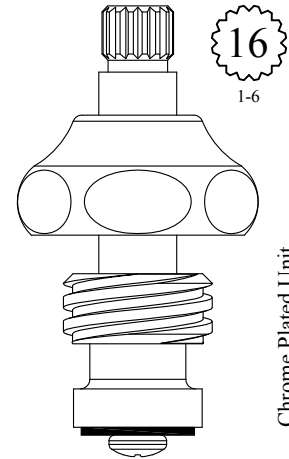

Chrome Plated Unit

LF461041
LF461042
LF261041 Stem Only
LF261042 Stem Only

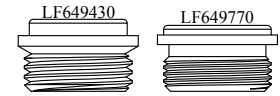

SEAT USED: LF649430 or LF649770

LENGTH: 2.27"

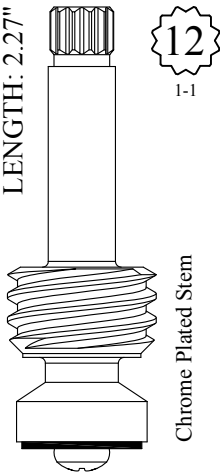

Chrome Plated Stem

LF261151
LF261152

LENGTH: 2.31"

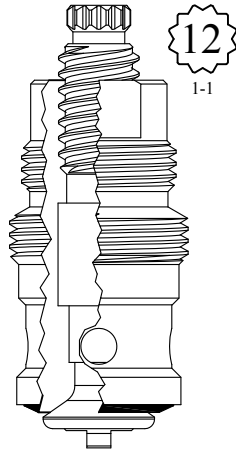

GASKET: 895250

LF462011
LF462012
LF262011 Stem Only
LF262012 Stem Only

LENGTH: 2.32"

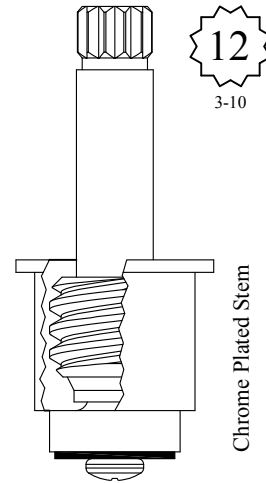

Chrome Plated Stem

LF462131
LF262131 Stem Only

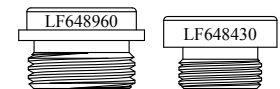

SEAT USED: LF648960 or LF648430

FOR CRANE

LENGTH: 2.35"

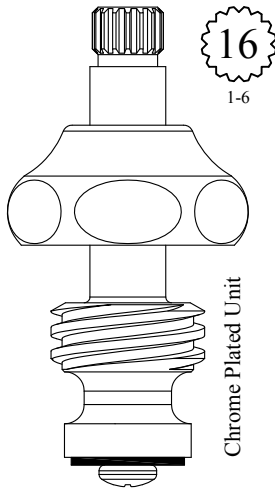

Chrome Plated Unit

LF461931
LF261931 Stem Only

LENGTH: 2.39"

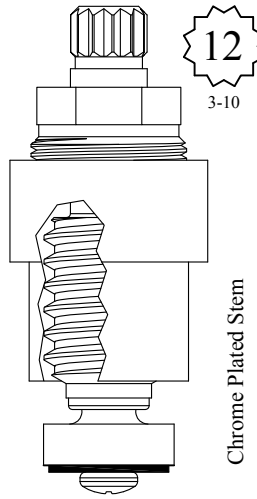

Chrome Plated Stem

LF462611
LF462612



SEAT USED: LF649920

LENGTH: 2.40"

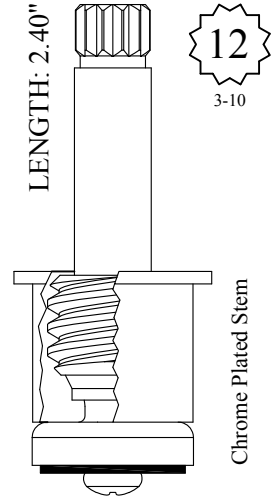

Chrome Plated Stem

LF462071
LF462072



SEAT USED: LF648340

LENGTH: 2.45"

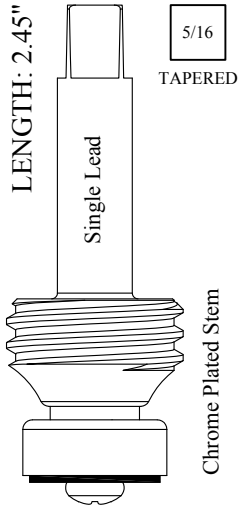

Chrome Plated Stem

LF263401

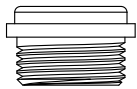

SEAT USED: LF648340

LENGTH: 2.45"

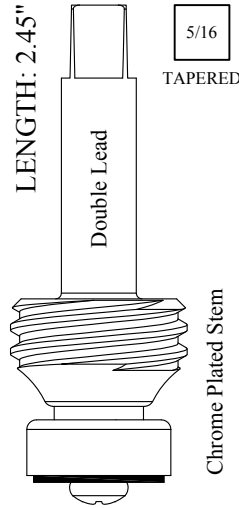

Chrome Plated Stem

LF263411
LF263412

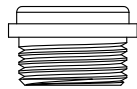

SEAT USED: LF648340

LENGTH: 2.66"

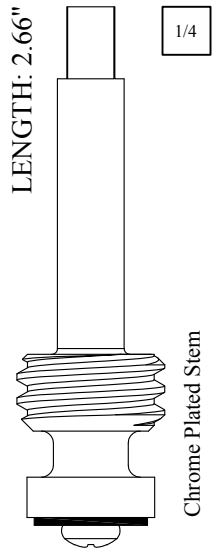

Chrome Plated Stem

LF264461

FOR CRANE

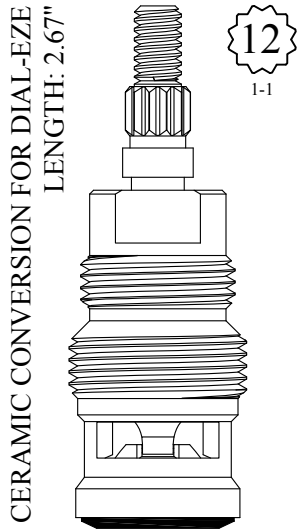

CERAMIC CONVERSION FOR DIAL-EZE
LENGTH: 2.67"

GASKET: 895250 INCLUDED
DISC SET: 151380-PKG

LF464311
LF464312

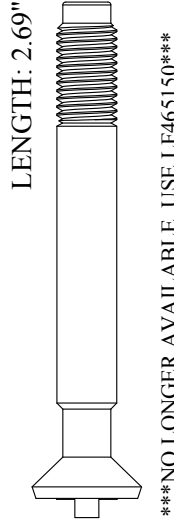

LENGTH: 2.69"

NO LONGER AVAILABLE, USE LF465150

LF265140

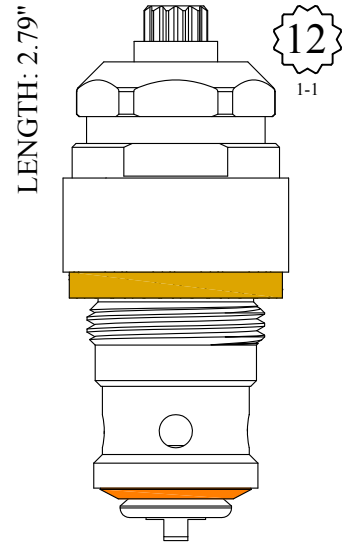

LENGTH: 2.79"

LF456090
LF256090 Stem Only

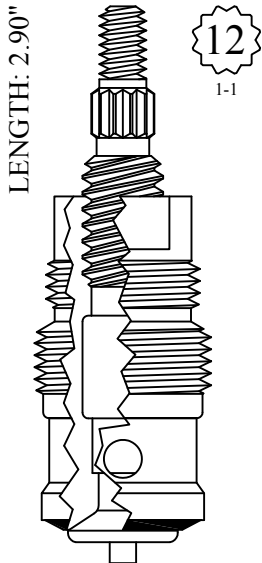

LENGTH: 2.90"

GASKET: 895250

LF465121
LF465122
LF265121 Stem Only
LF265122 Stem Only

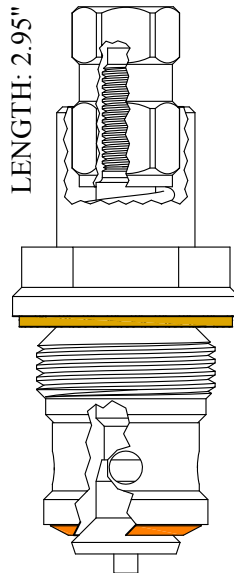

LENGTH: 2.95"

GASKET: 895250 INCLUDED

LF465150
LF265150 Stem Only

Chrome Plated Sleeve

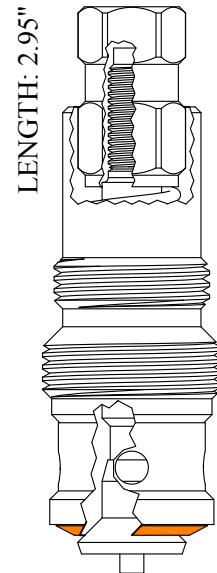

LENGTH: 2.95"

GASKET: 895250 INCLUDED

LF465160
LF265150 Stem Only

FOR CRANE

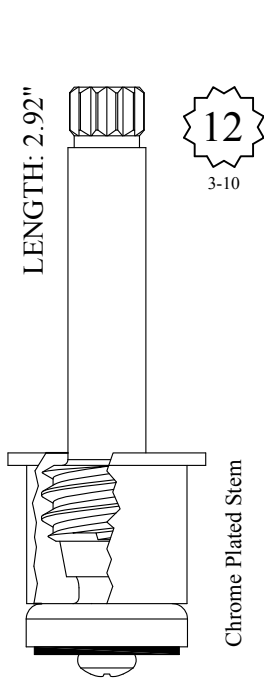

LF466051
LF466052

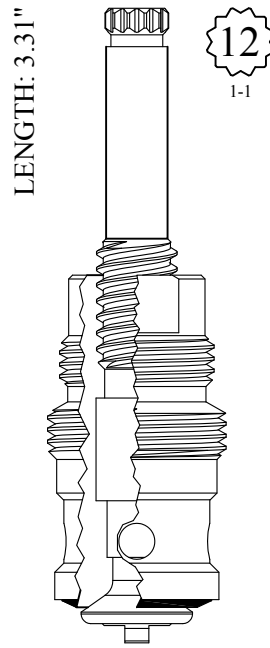

GASKET: 895250

402431
402432

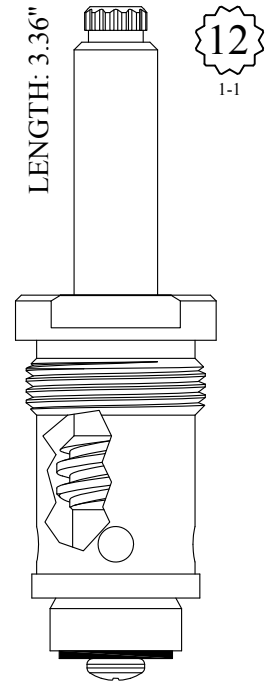

430631



SEAT USED: LF648340

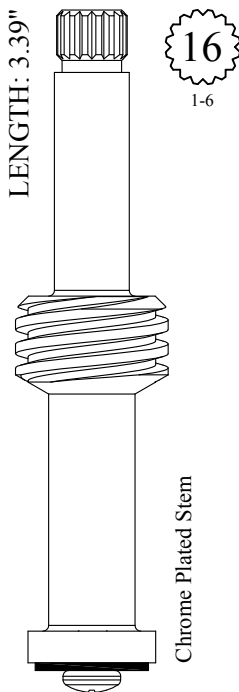

LF268091
LF268092

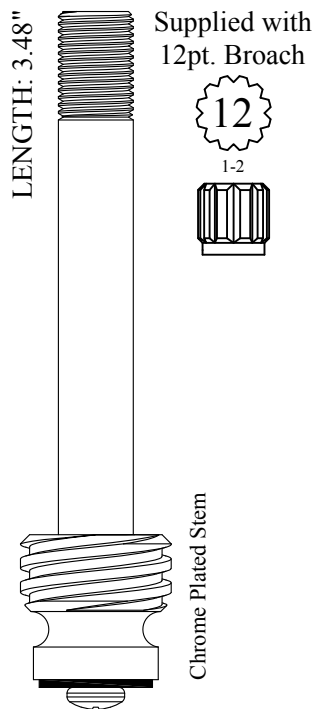

LF267161

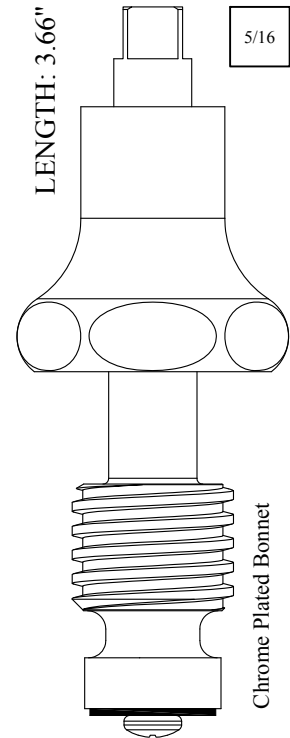

403121
203121 Stem Only

FOR CRANE

LENGTH: 3.52"



SEAT USED: LF648340

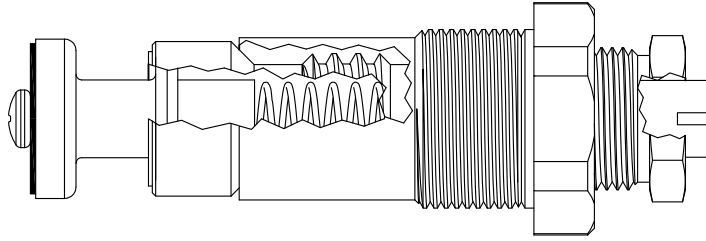

402731
202731 Stem Only
 GASKET: 895370

LENGTH: 4.05"

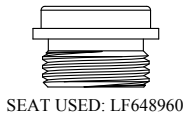

SEAT USED: LF648960

Chrome Plated Stem

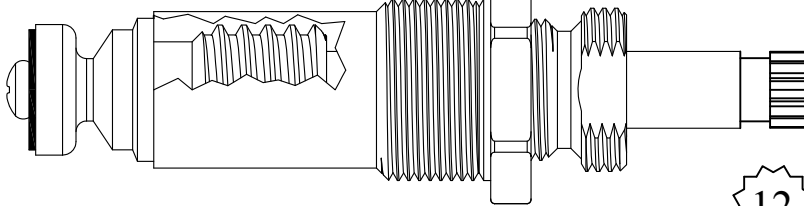

LF470211
 GASKET: 895320



3-10

LENGTH: 4.05"

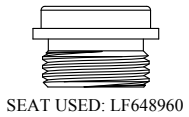

SEAT USED: LF648960

Chrome Plated Stem

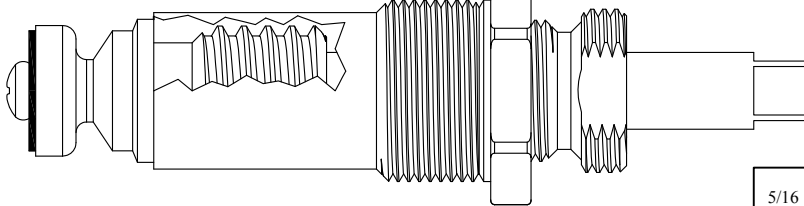

LF470221
 GASKET: 895320

5/16

LENGTH: 4.21"

Chrome Plated Unit

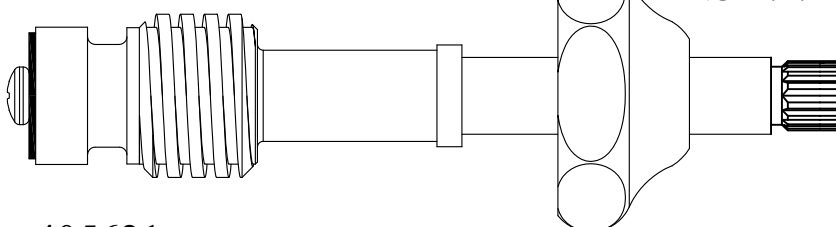

405621
205621 Stem Only

Supplied with
 12pt. Broach



1-2

FOR CRANE



SEAT USED: LF648340

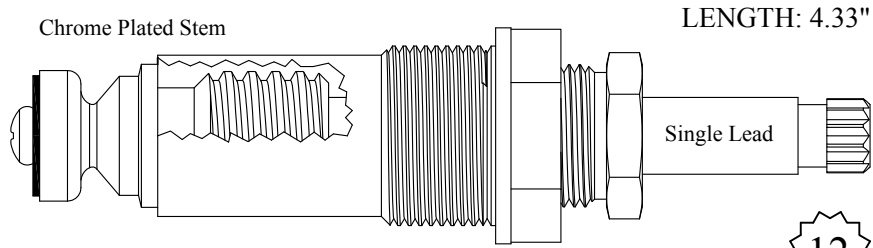

LF471041
LF271041 Stem Only
 GASKET: 895370

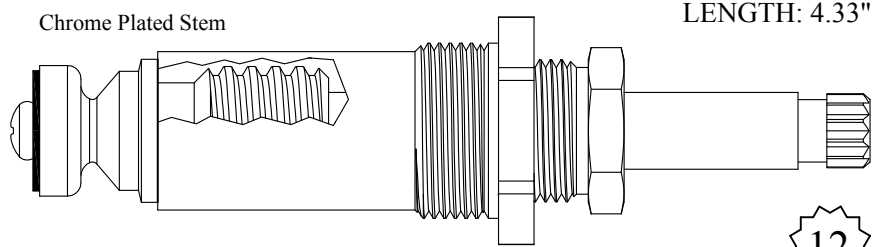

Not Available, Use LF471041



SEAT USED: LF648960

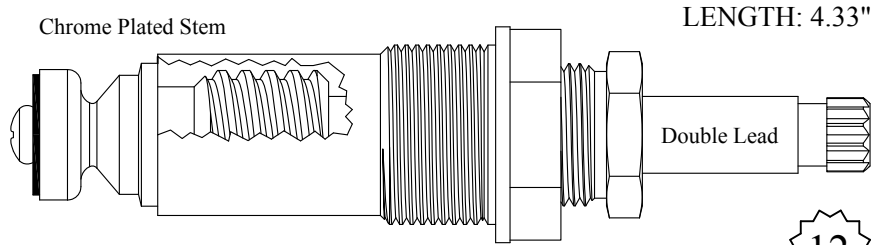

LF471141/ LF471142
LF271141/ LF271142 Stem Only
 GASKET: 895370



SEAT USED: LF648960

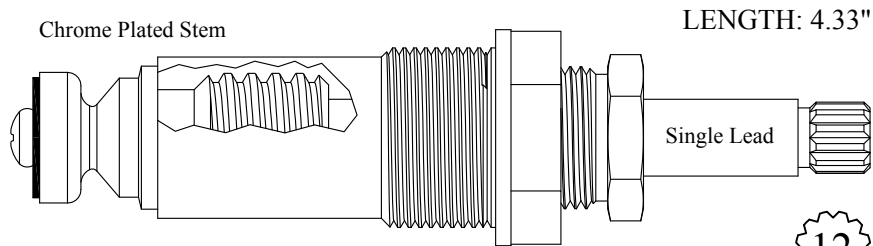

LF471121
LF271121 Stem Only
 GASKET: 895370



FOR CRANE

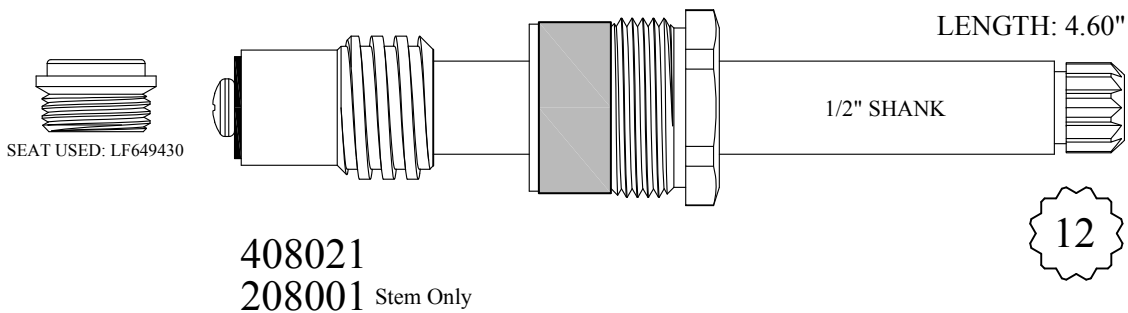
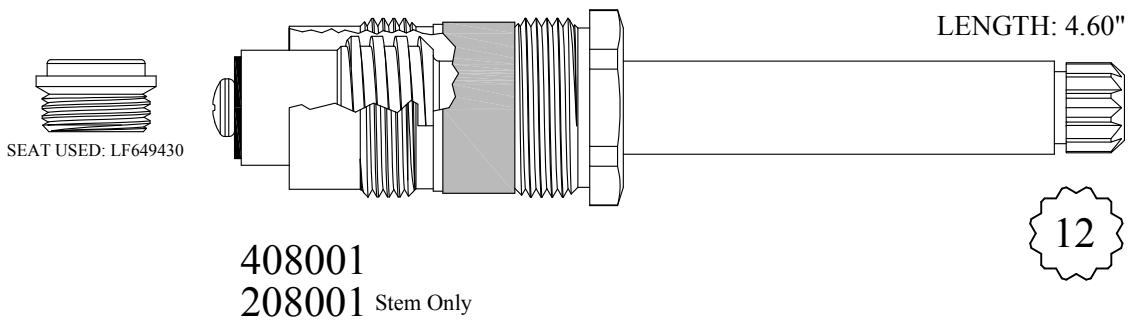
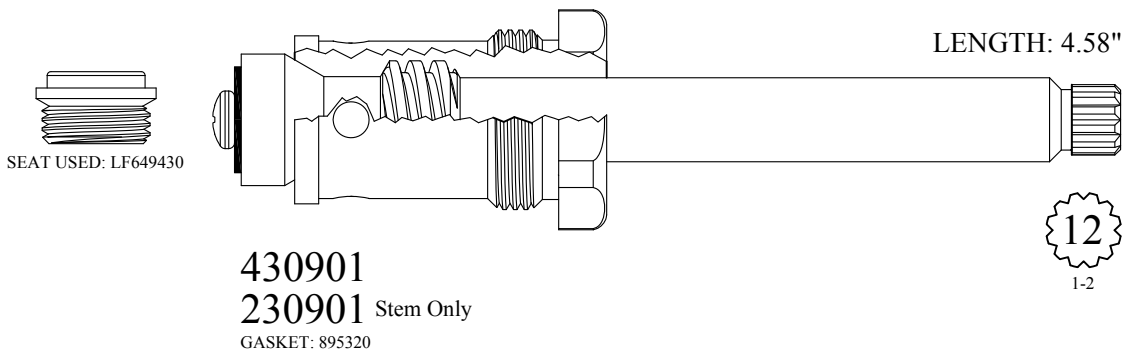
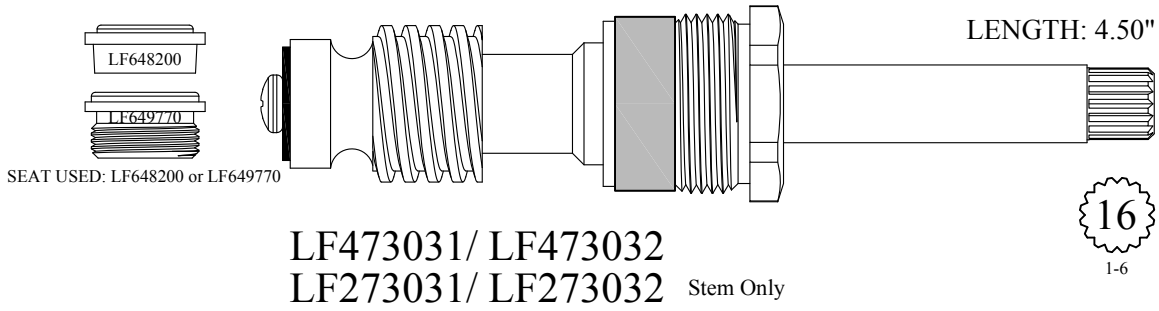

FOR CRANE



SEAT USED: LF649430

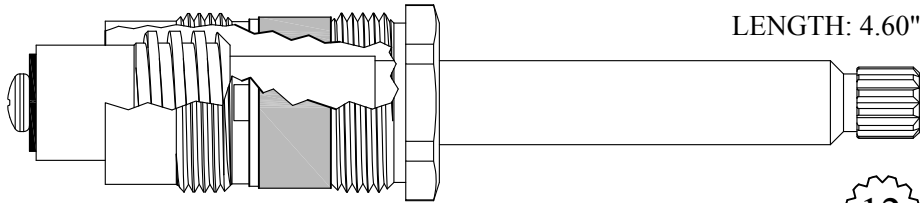

LENGTH: 4.60"

408301/ 408302
208301/ 208302 Stem Only



SEAT USED: LF649430

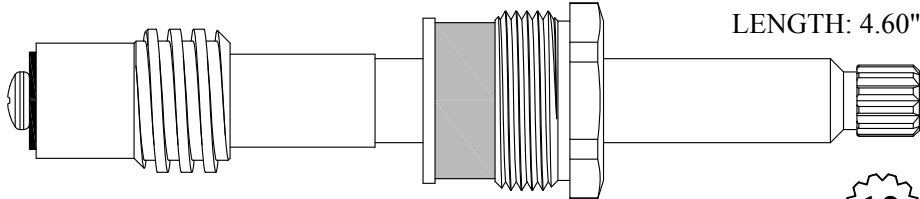

LENGTH: 4.60"

LF408321/ LF408322
LF208301/ LF208302 Stem Only } For Lavatory



SEAT USED: LF649430

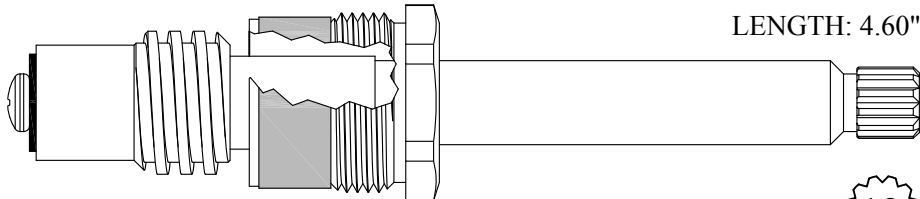

LENGTH: 4.60"

408321/ 408322
208301/ 208302 Stem Only } For Shower



SEAT USED: LF649430

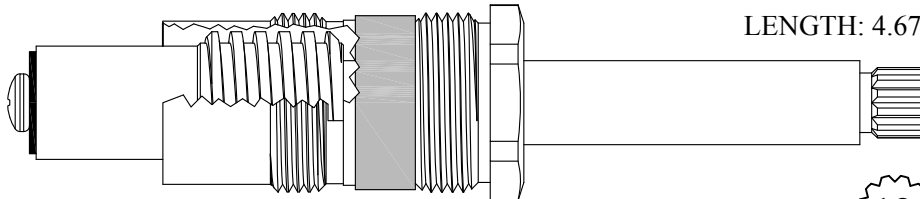

LENGTH: 4.67"

408201
208201 Stem Only



SEAT USED: LF649430

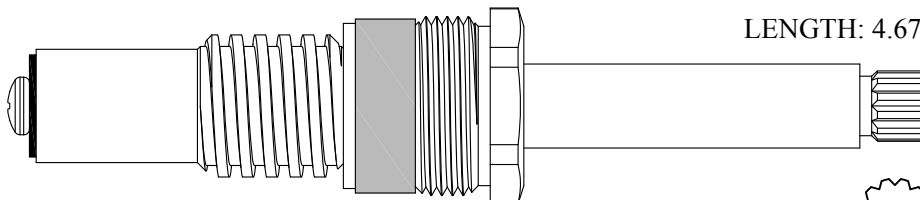

LENGTH: 4.67"

408211
208201 Stem Only
GASKET: INCLUDED



FOR CRANE

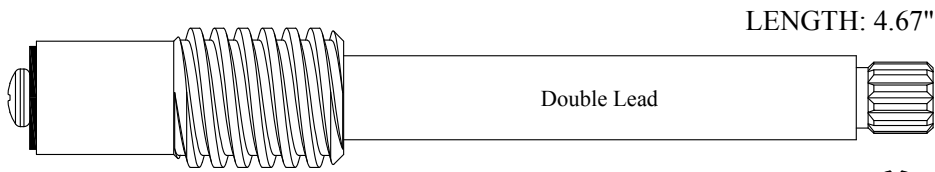

231031

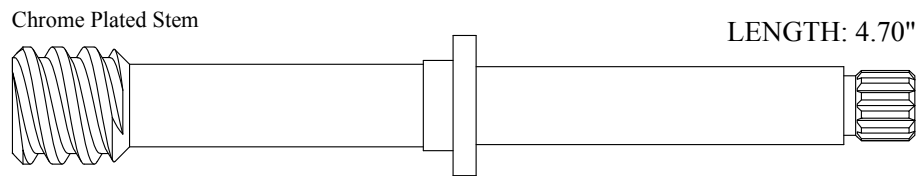

208961

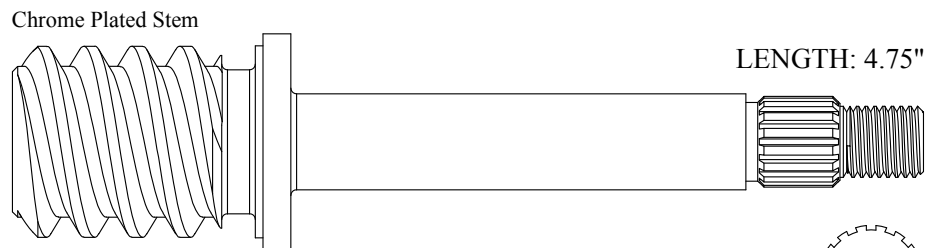

212511

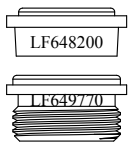
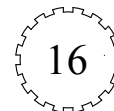

SEAT USED:
LF648200
or LF649770

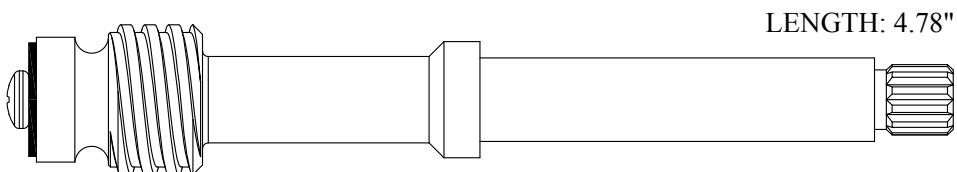

LF275031/ LF275032



FOR CRANE

LENGTH: 4.92"

Chrome Plated Bonnet

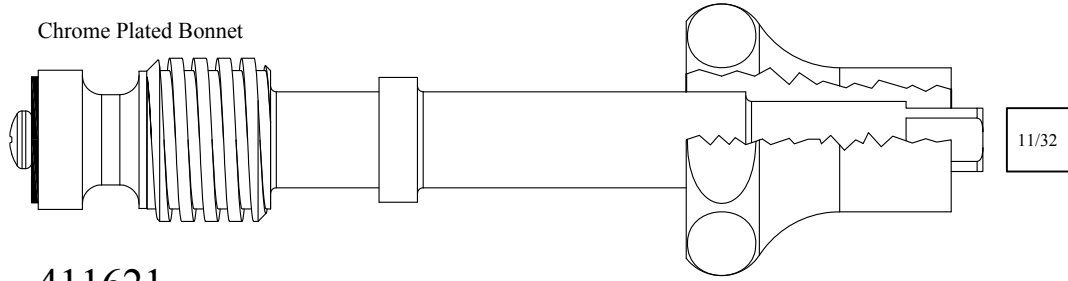

411621
211621 Stem Only

LENGTH: 4.93"

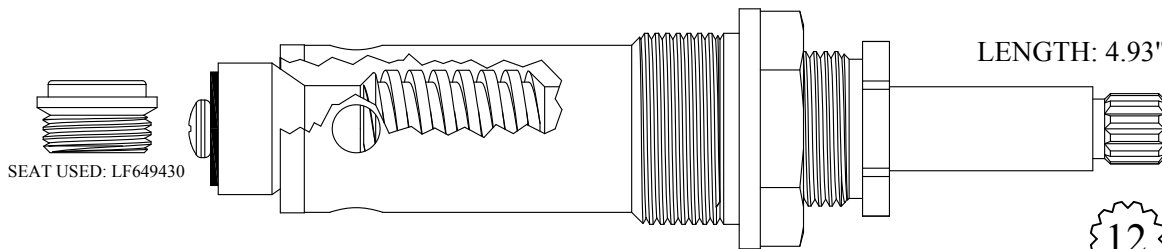

431901
231901 Stem Only
GASKET: 895550

LENGTH: 5.00"

Chrome Plated Stem

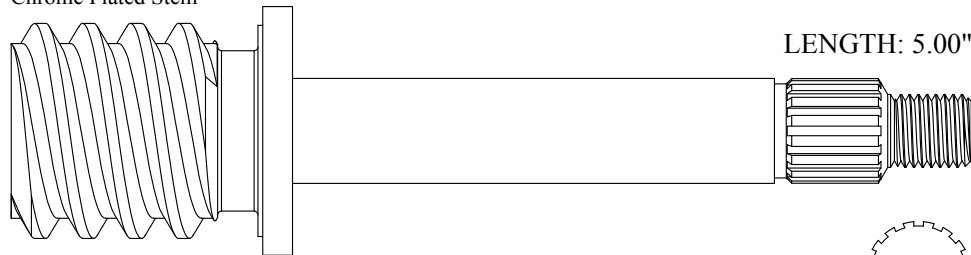

212581

LENGTH: 5.10"

Chrome Plated Stem

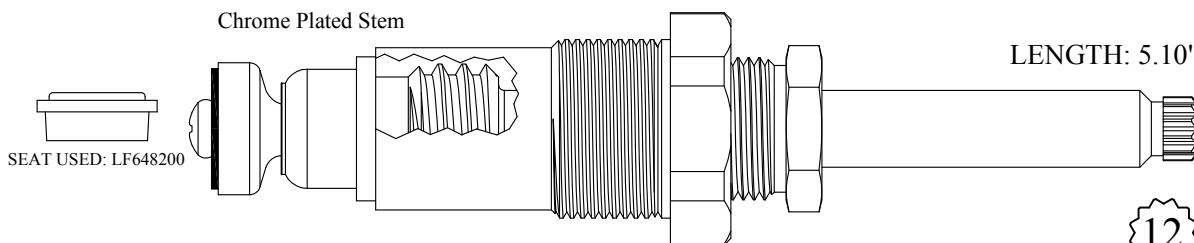

415911
215911 Stem Only

FOR CRANE

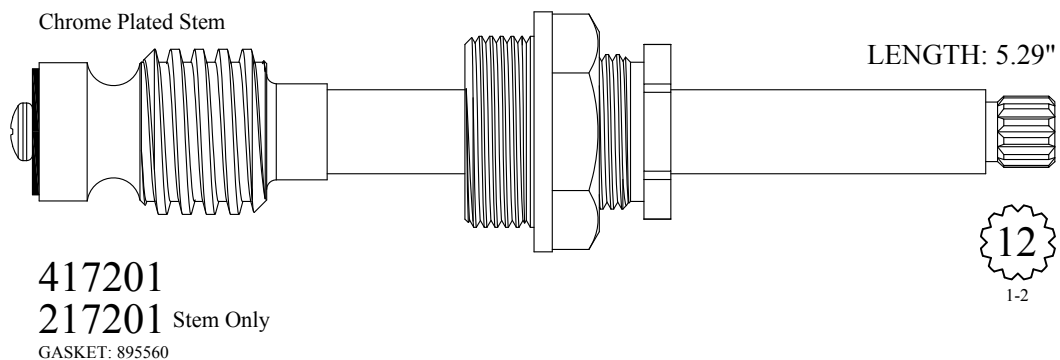
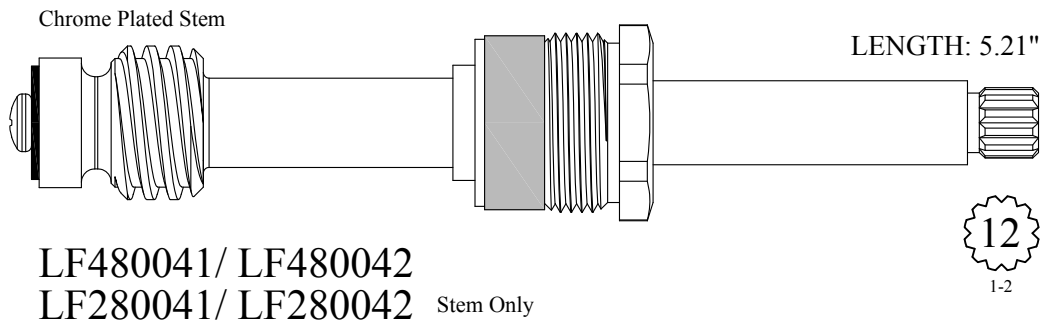
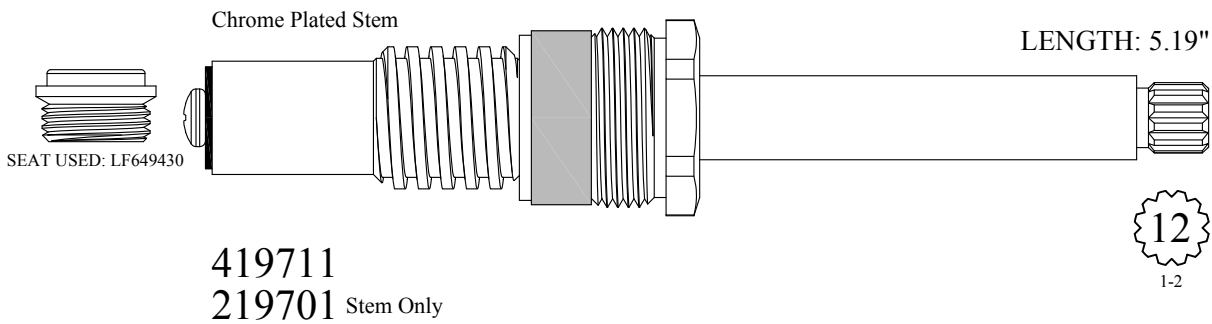
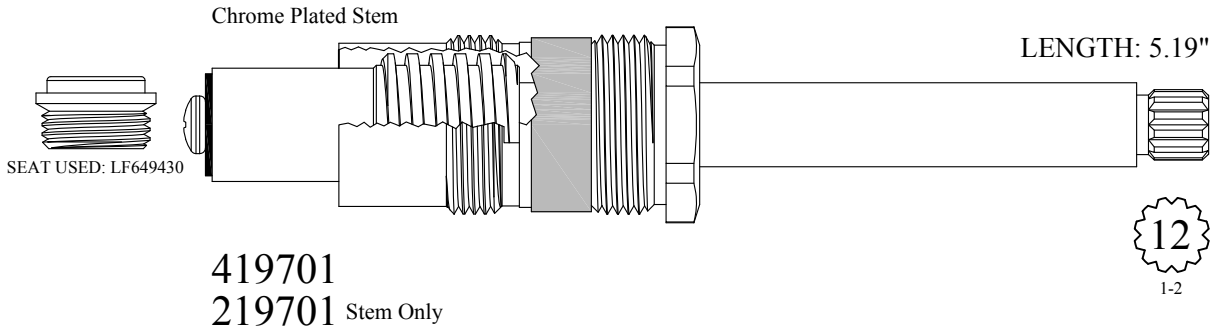

FOR CRANE

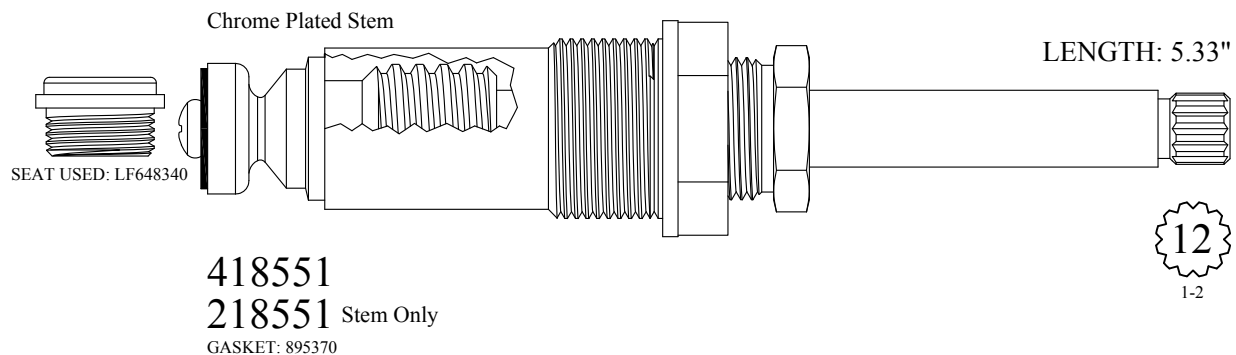
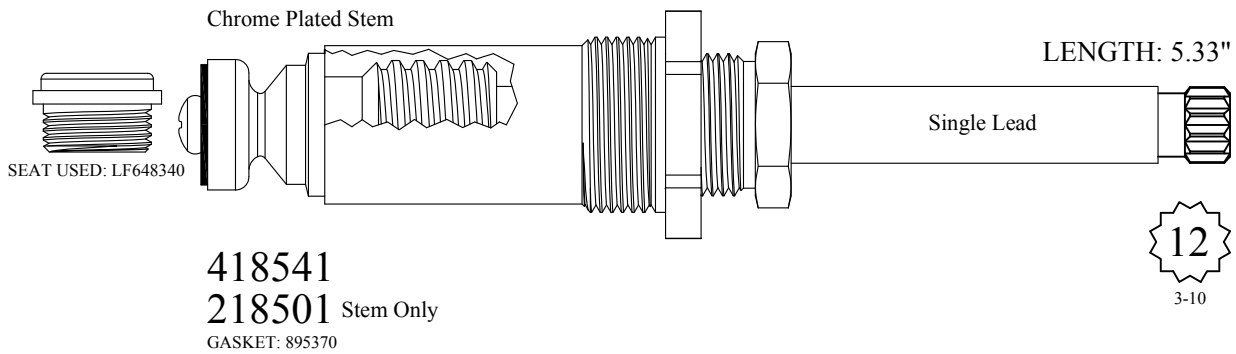
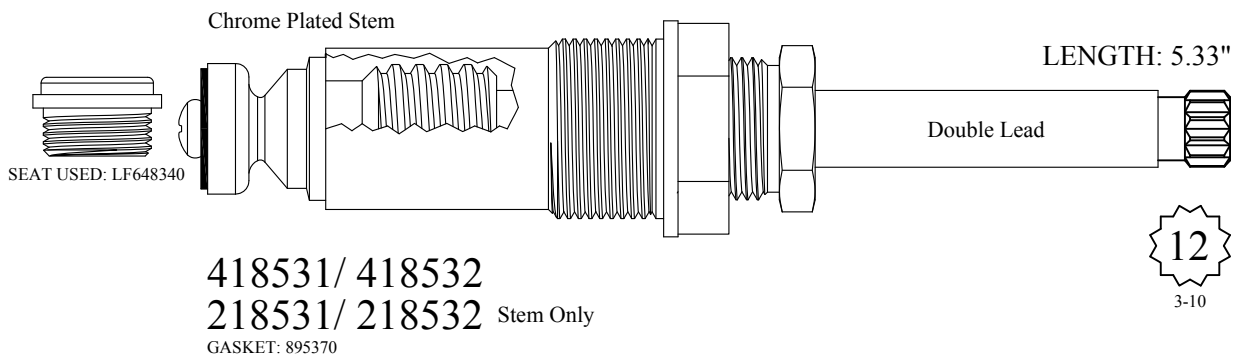
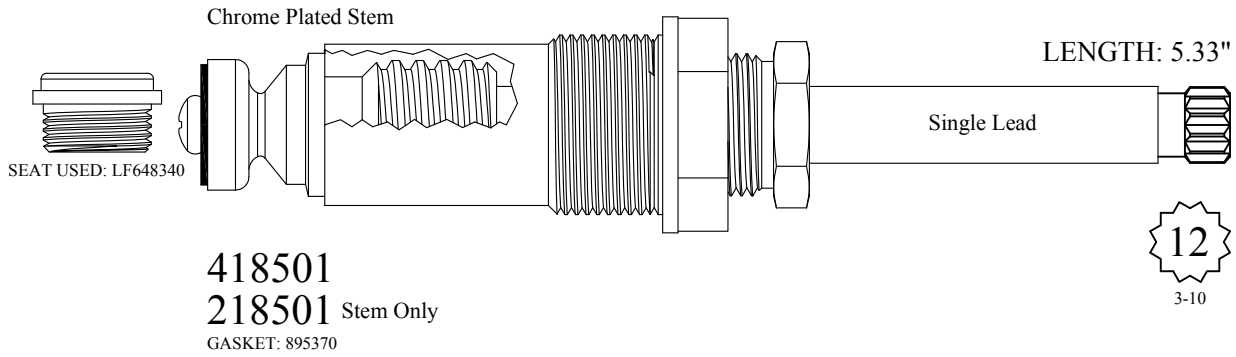

FOR CRANE

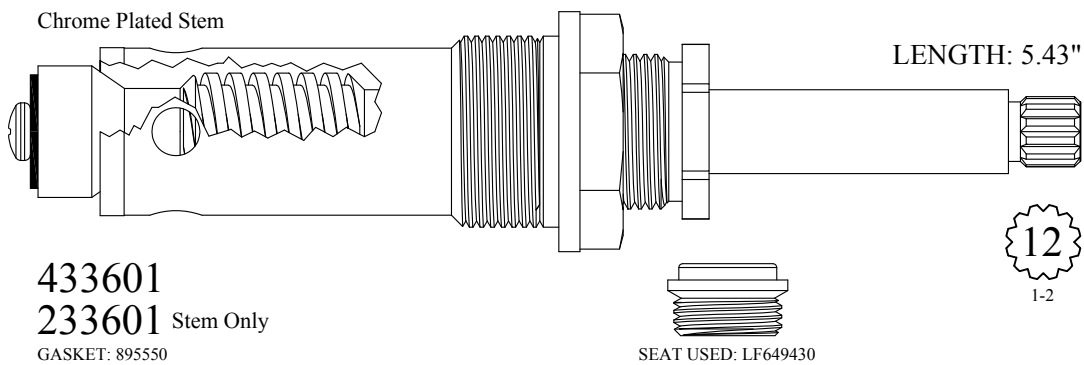
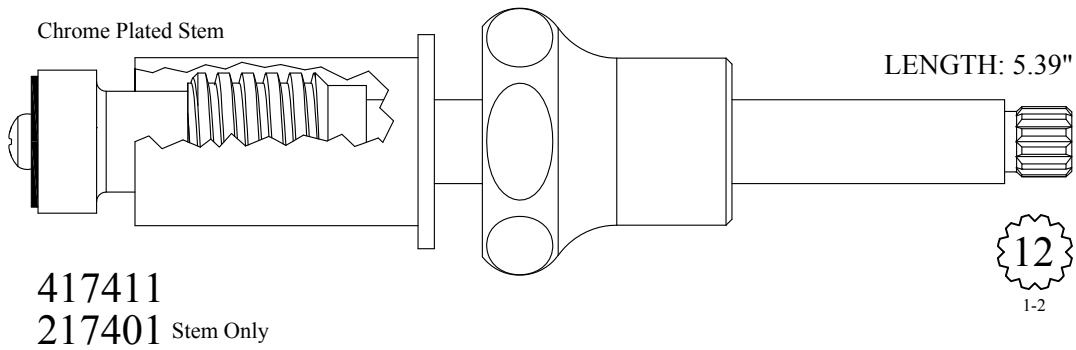
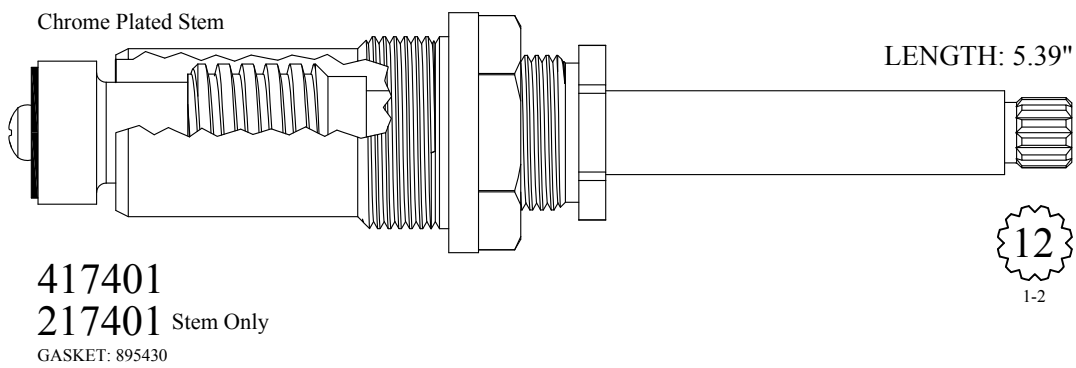
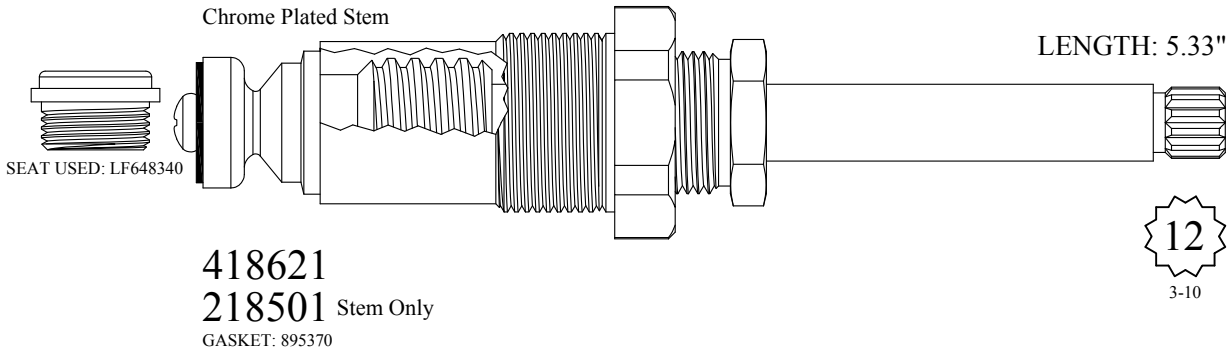

FOR CRANE

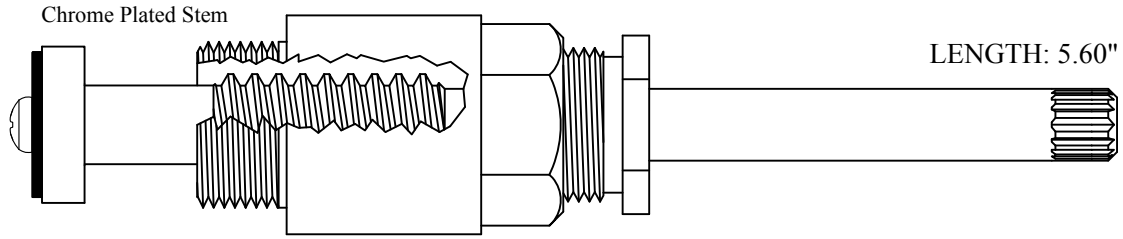

Not Available, Use 423151

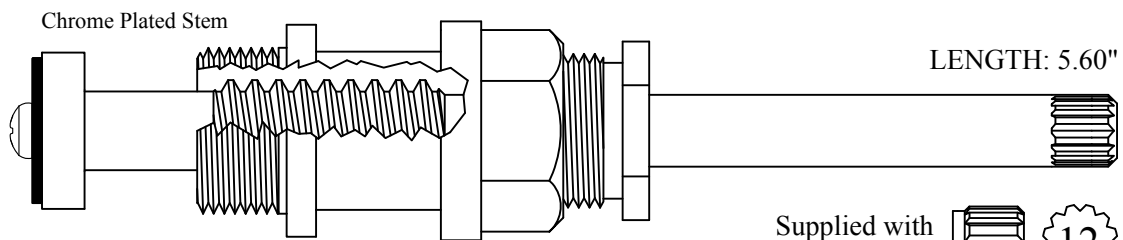

423151
223151 Stem Only
GASKET: 895400

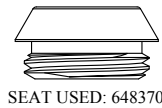

Supplied with
12pt. Broach

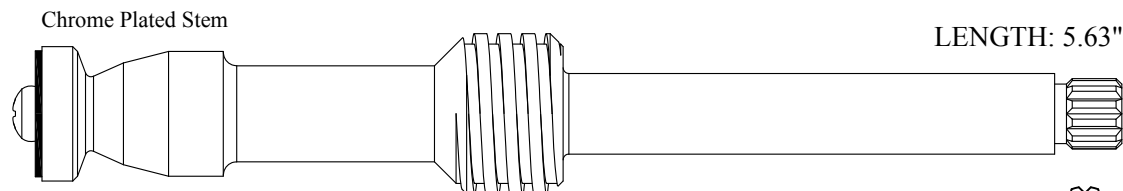
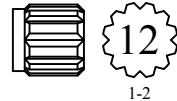

222651



BARRY E.  WALTER  SR. CO.

FOR CRANE

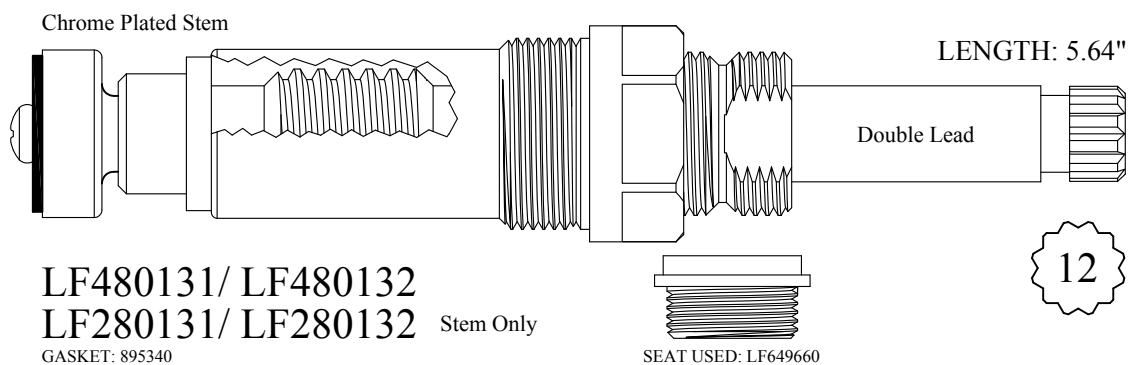
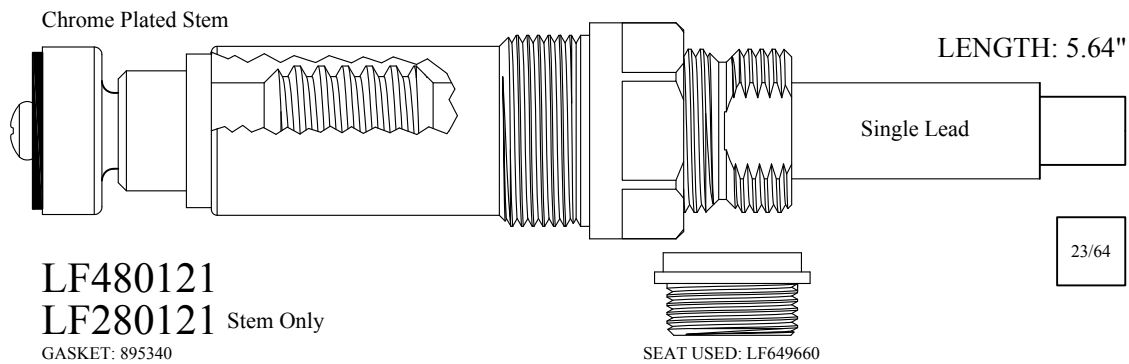
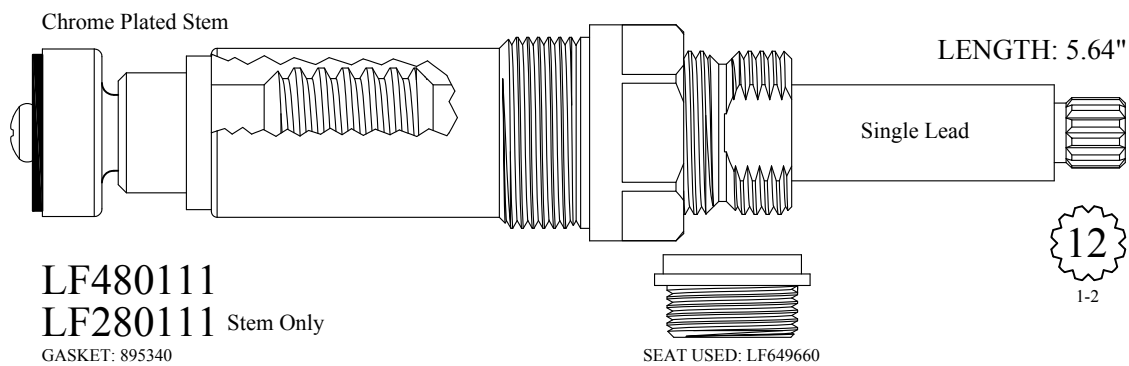
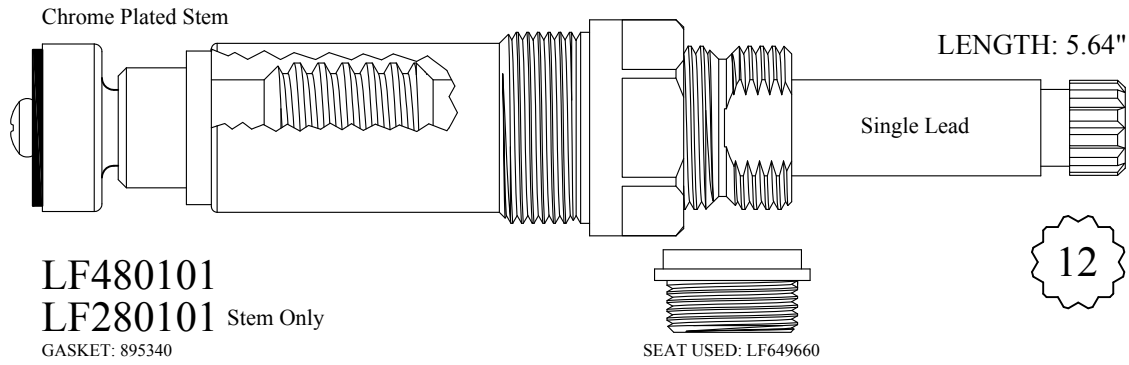

FOR CRANE

Chrome Plated Stem

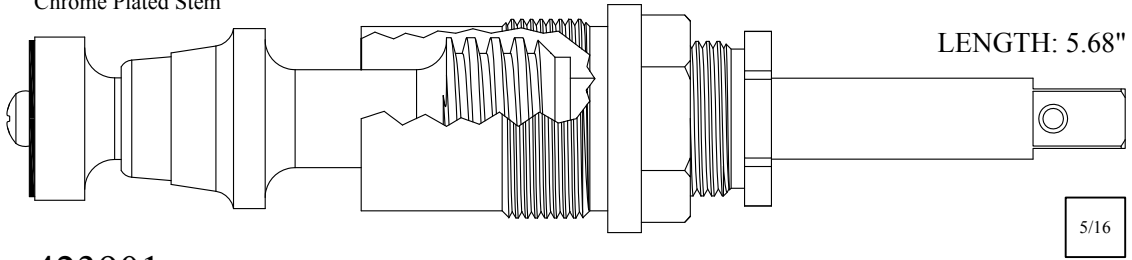

LENGTH: 5.68"

5/16

423901

223901 Stem Only

GASKET: 895440

Chrome Plated Stem

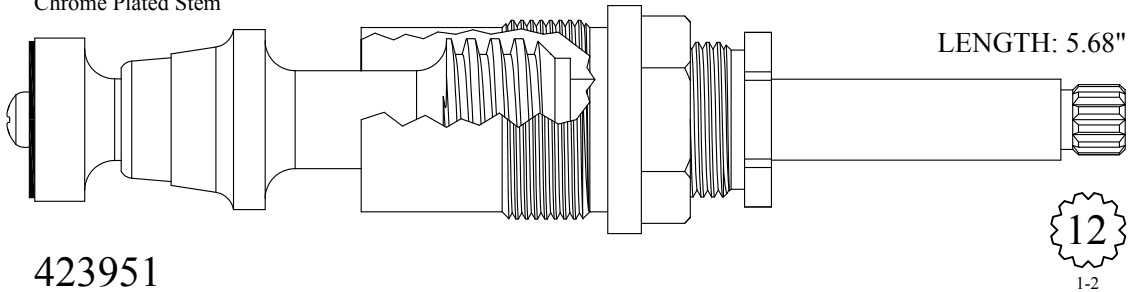

LENGTH: 5.68"

12
1-2

423951

223951 Stem Only

GASKET: 895440

Chrome Plated Stem

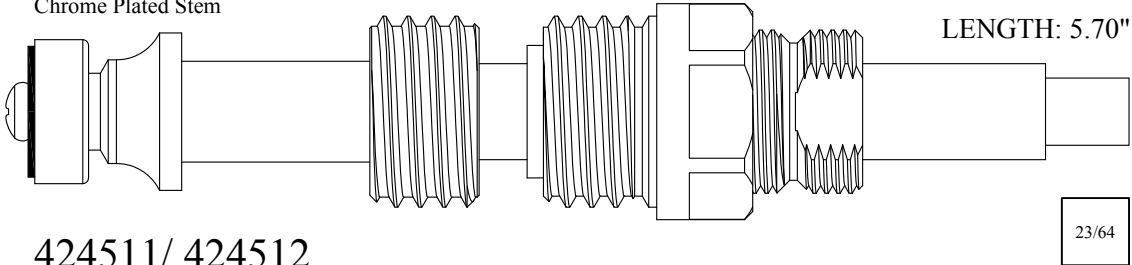

LENGTH: 5.70"

23/64

424511/ 424512

224511/ 224512 Stem Only

GASKET: 895340

Chrome Plated Stem

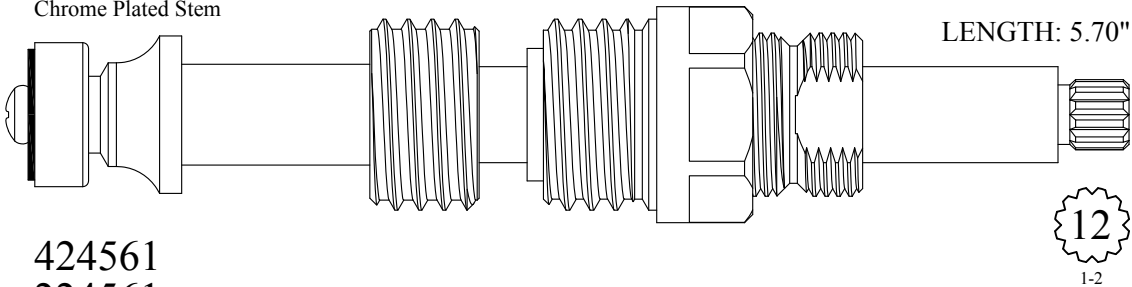

LENGTH: 5.70"

12
1-2

424561

224561 Stem Only

GASKET: 895340

FOR CRANE

Chrome Plated Stem

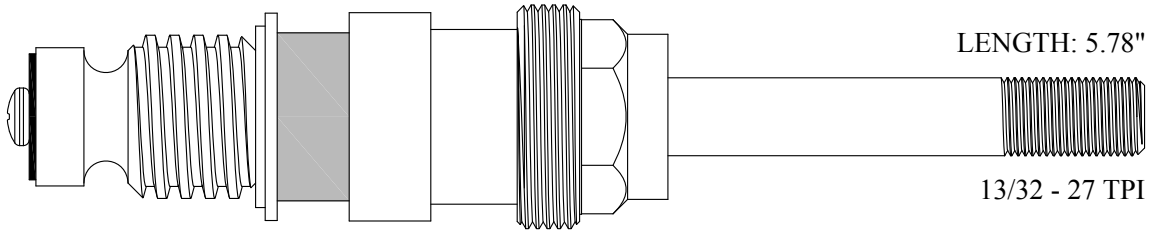

422301
222301 Stem Only

Chrome Plated Stem

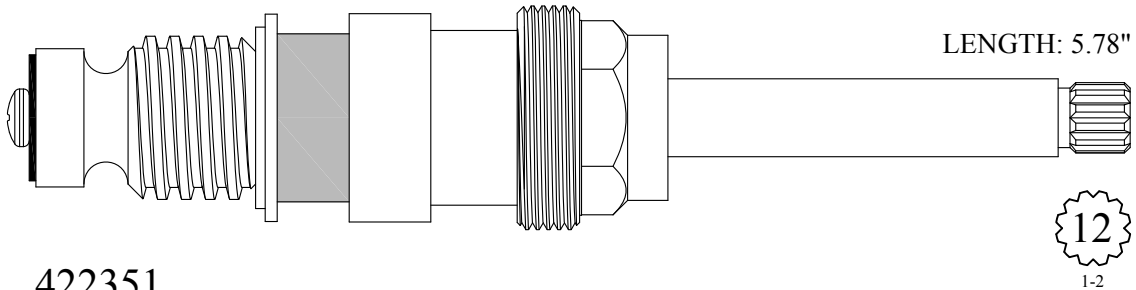

422351
222351 Stem Only

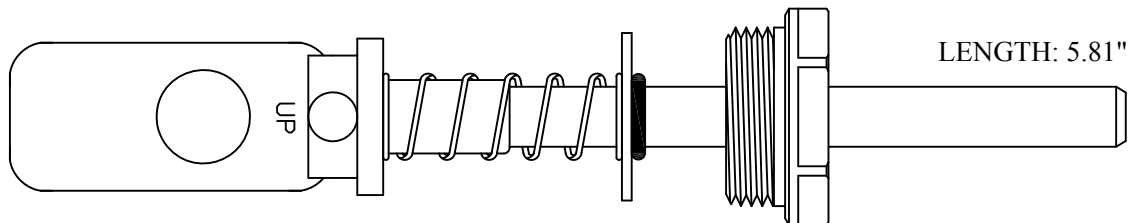

436000
236000 Stem Only
GASKET: 895370 INCLUDED

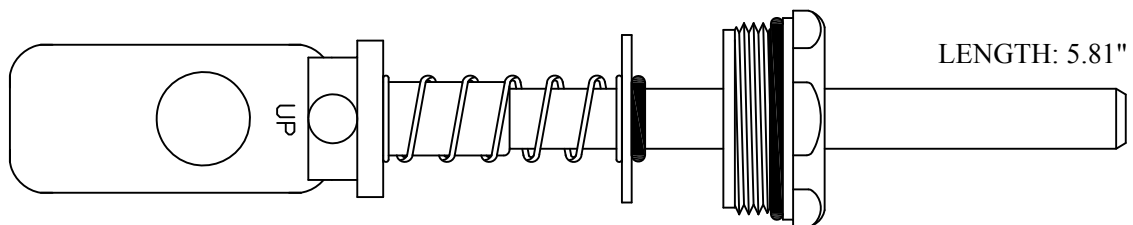
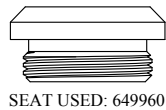

436010
236000 Stem Only
GASKET: 890210 O-RING INCLUDED

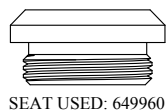

FOR CRANE

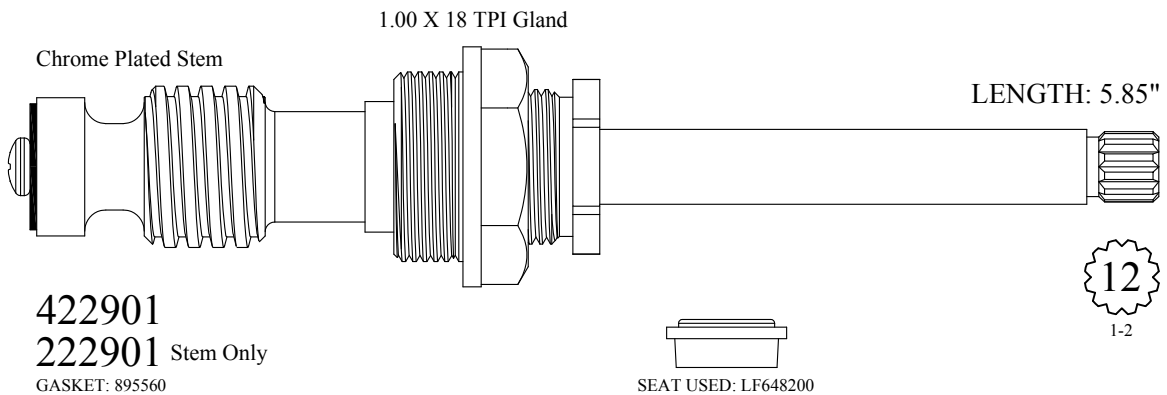
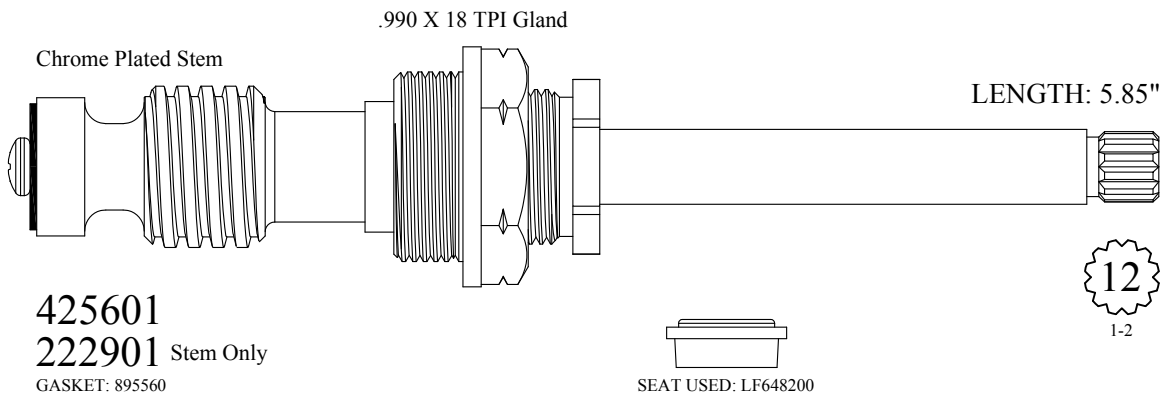
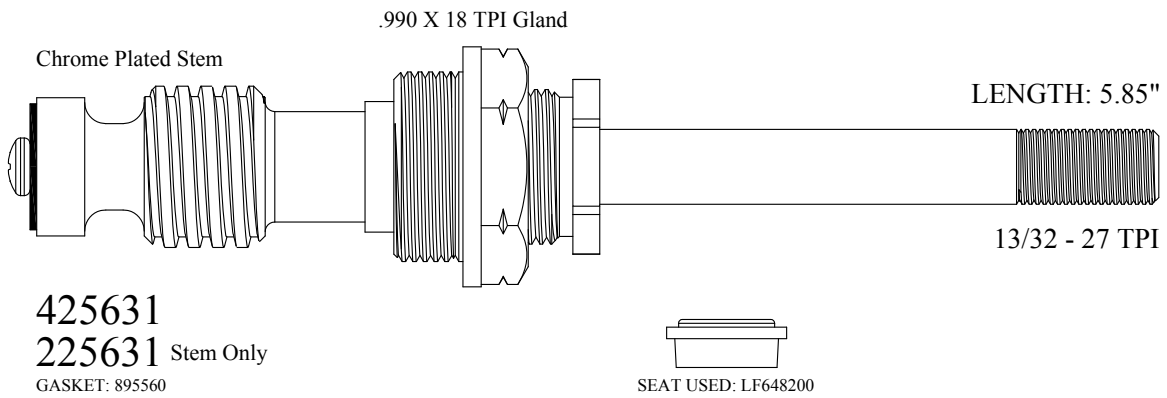
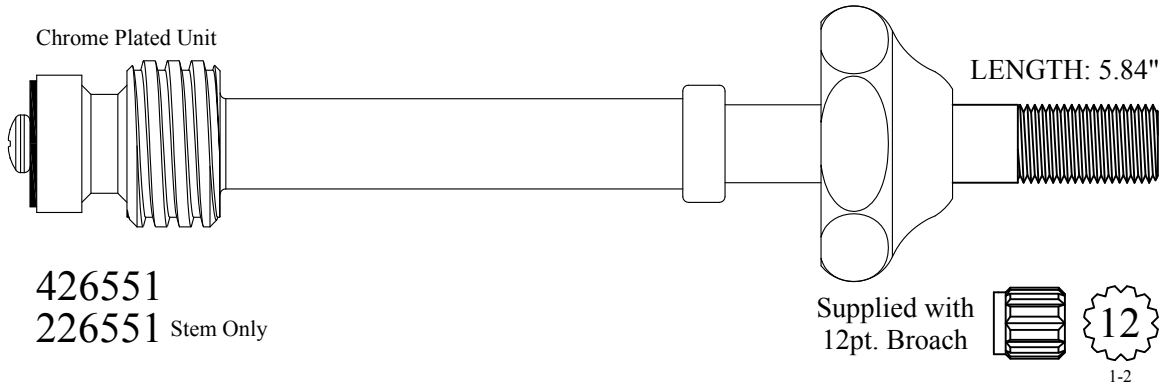

FOR CRANE

LENGTH: 5.95"

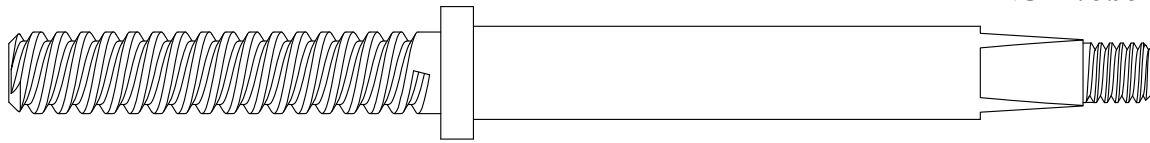

281522

Chrome Plated Stem

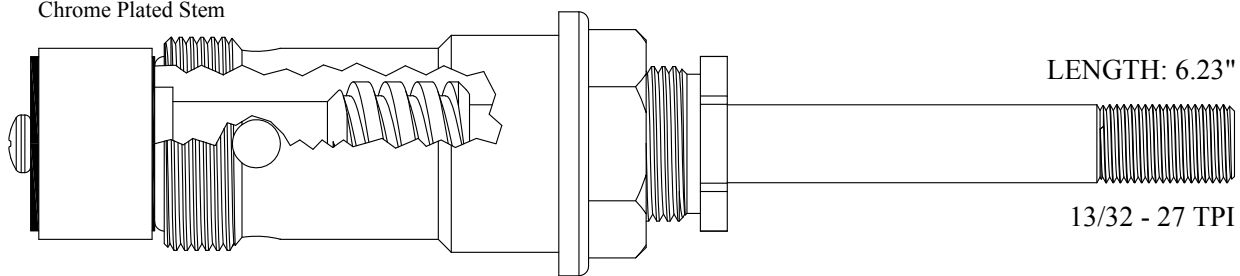

LENGTH: 6.23"

13/32 - 27 TPI

438601

238601 Stem Only

GASKET: 895450

Chrome Plated Stem

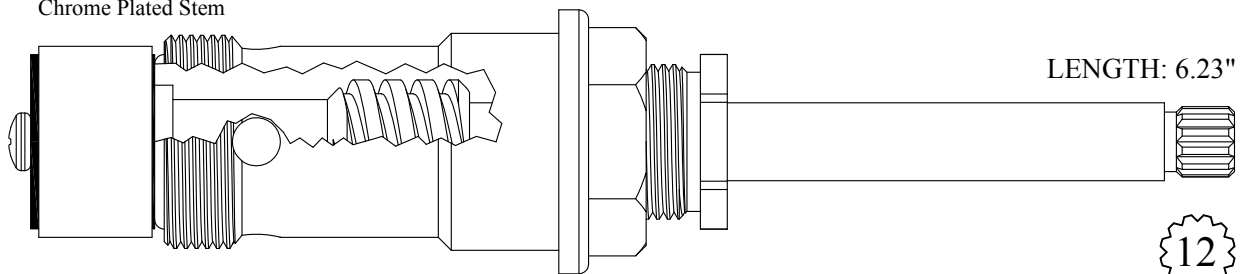

LENGTH: 6.23"

12
1-2

438651

238651 Stem Only

GASKET: 895450

Chrome Plated Stem

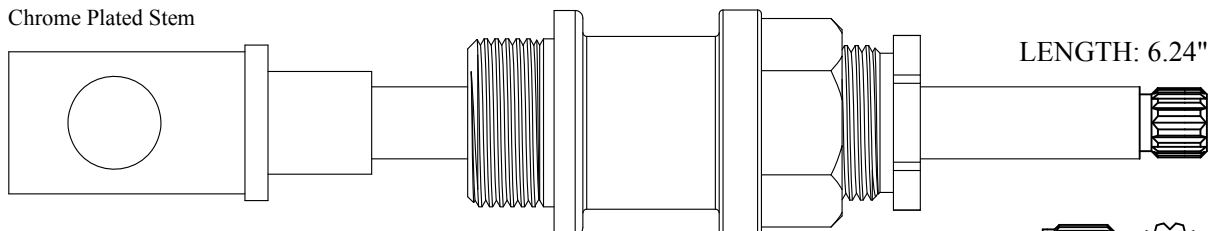

LENGTH: 6.24"

Supplied with
12pt. Broach

12
1-2

438550

238550 Stem Only

GASKET: 895400

Send Your Orders To:

BARRY E.  SR. CO.

E-mail: orderdesk@barrywalter.com

Fax: 1.800.886.9831

Phone: 1.800.767.5552



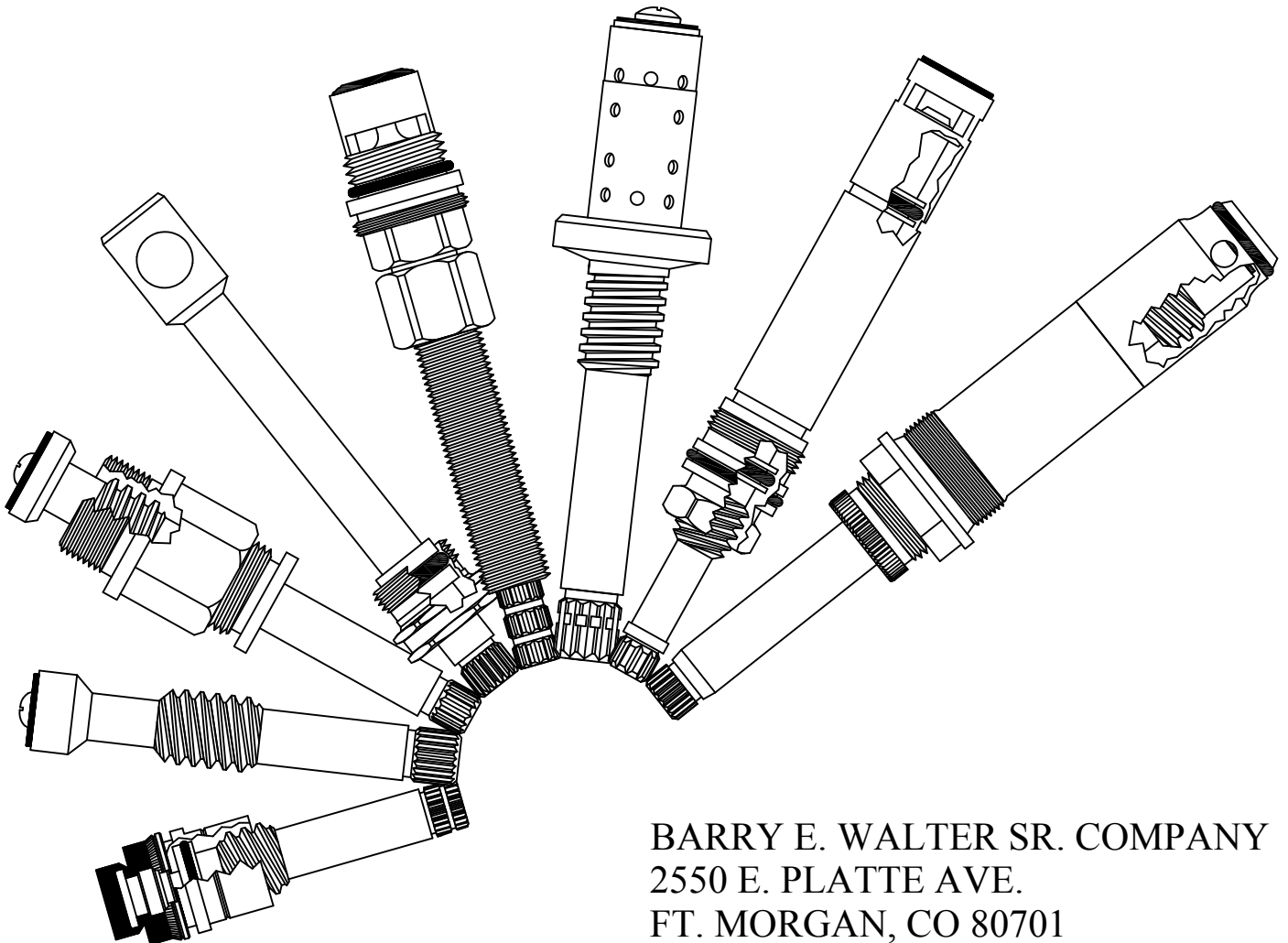

Quality Replacement Parts

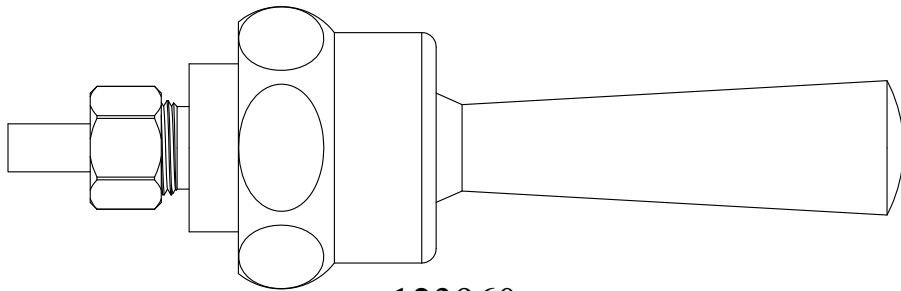

BARRY E. WALTER SR. COMPANY
2550 E. PLATTE AVE.
FT. MORGAN, CO 80701

*We are always adding
new parts. Check our
website for updates.*



123960
Replaces:
OEM# F35A

BARRY E.  ALTER  SR. CO.

FOR CRANE

Chrome Plated Stem

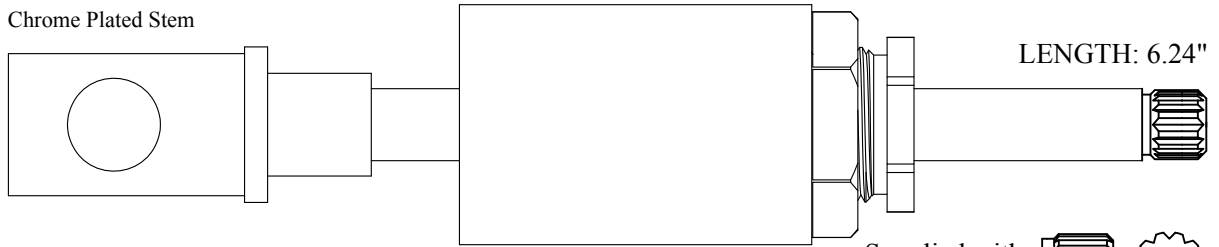

LENGTH: 6.24"

438850
238850 Stem Only

Supplied with
12pt. Broach



1-2

Chrome Plated Stem

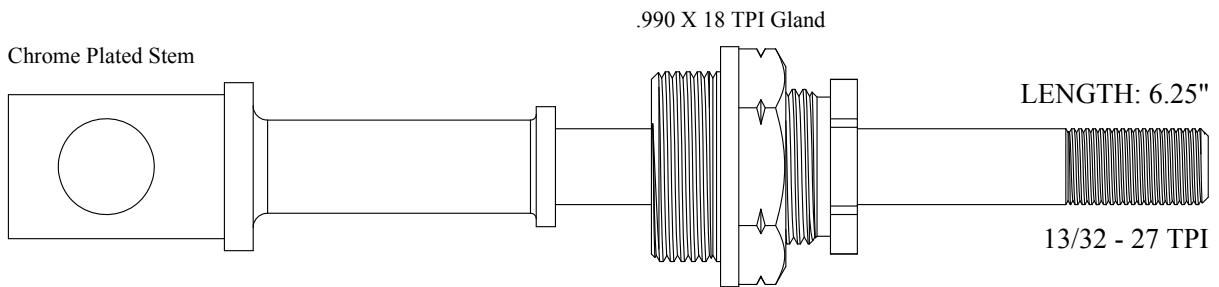

.990 X 18 TPI Gland

LENGTH: 6.25"

438430
238430 Stem Only
GASKET: 895560

13/32 - 27 TPI

Chrome Plated Stem

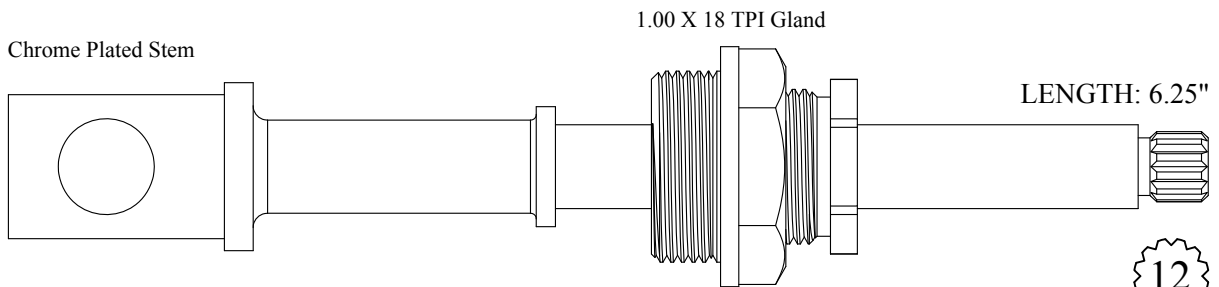

1.00 X 18 TPI Gland

LENGTH: 6.25"

438400
238400 Stem Only
GASKET: 895560



1-2

Chrome Plated Unit

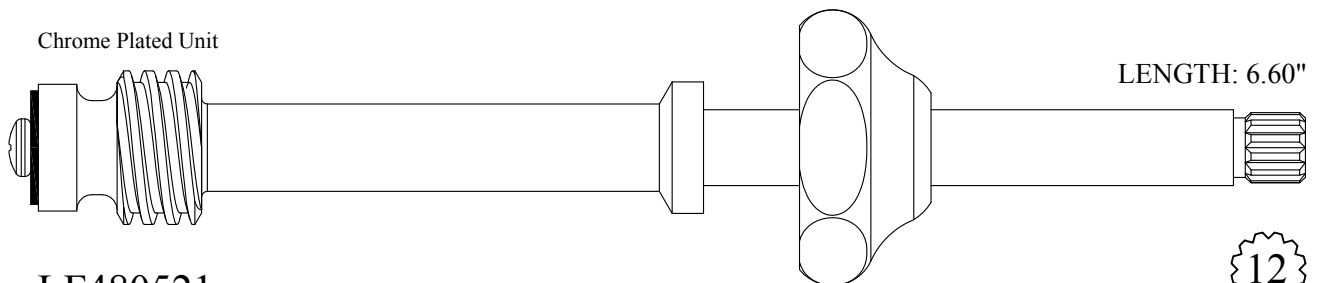

LENGTH: 6.60"

LF480521
LF280521 Stem Only



1-2

FOR CRANE

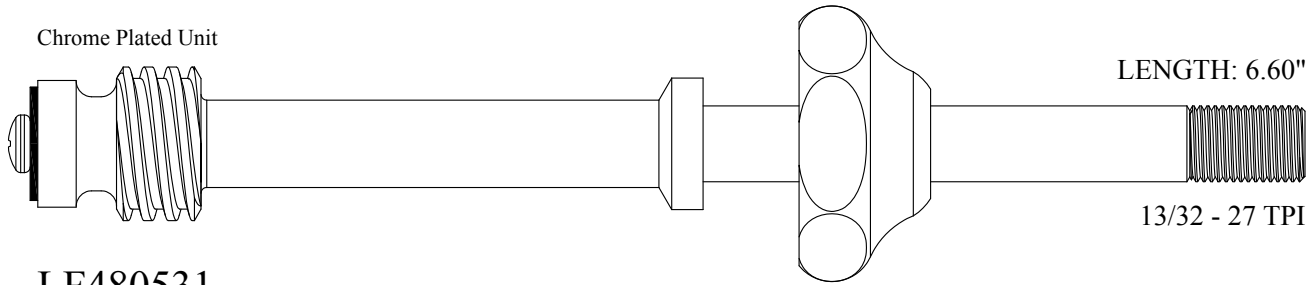

LF480531
LF280531 Stem Only

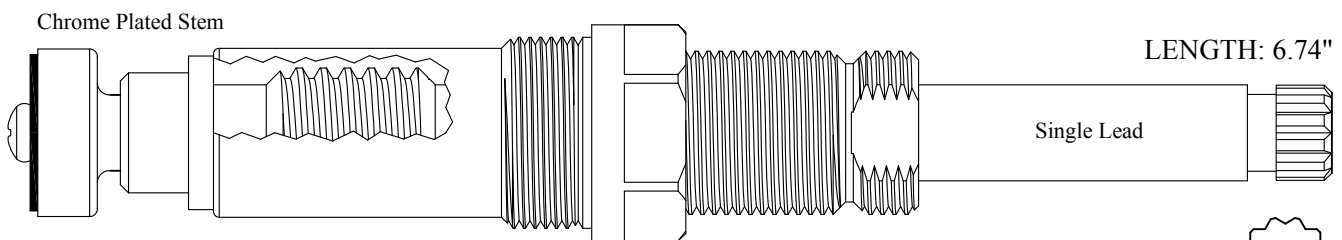

427001
227001 Stem Only
GASKET: 895340

SEAT USED: LF649660

12

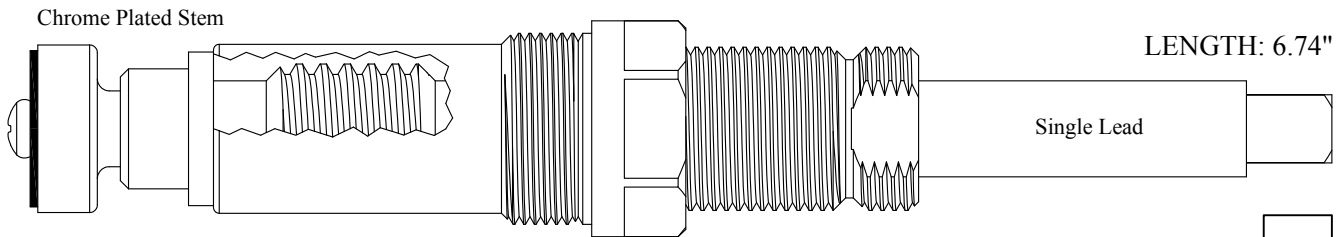

427031
227031 Stem Only
GASKET: 895340

SEAT USED: LF649660

23/64

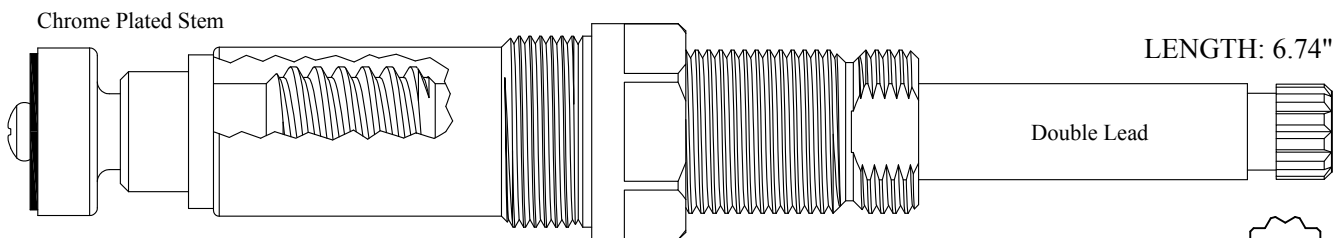

427041/ 427042
227041/ 227042 Stem Only
GASKET: 895340

SEAT USED: LF649660

12

FOR CRANE

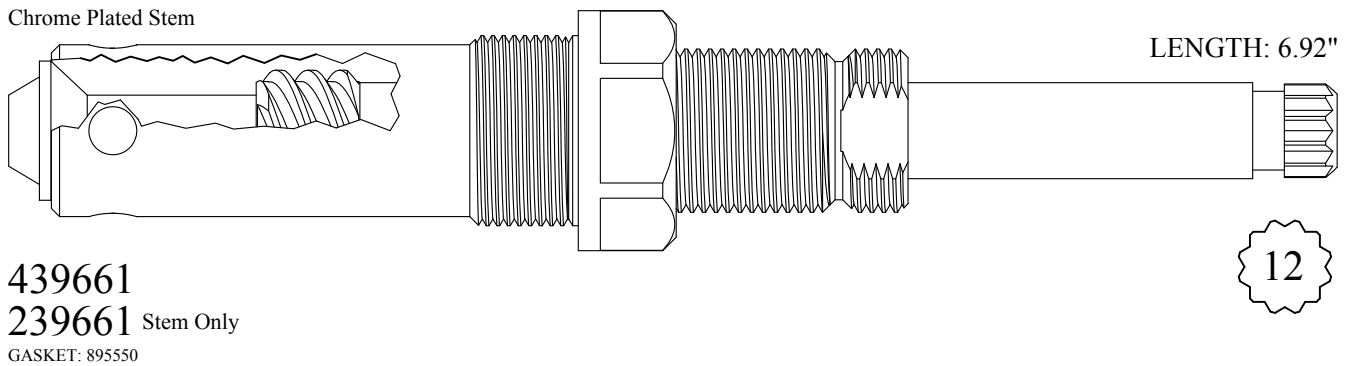
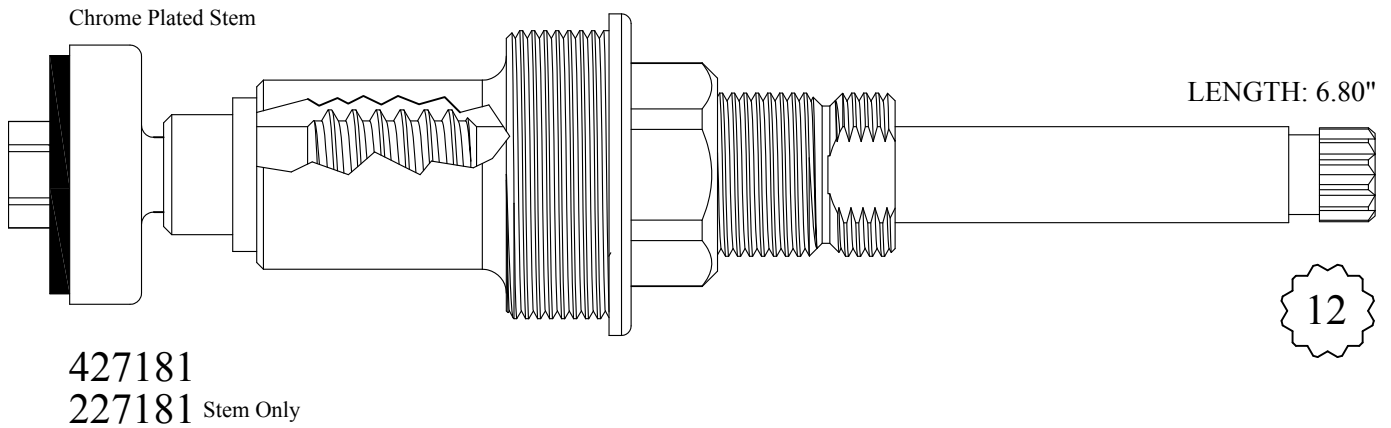
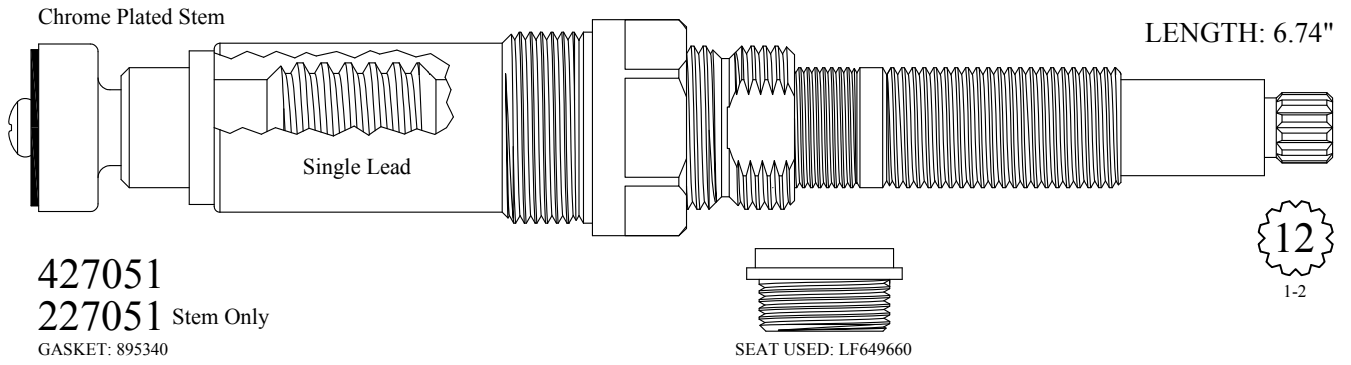

BARRY E.  ALTER SR. CO.

FOR CRANE

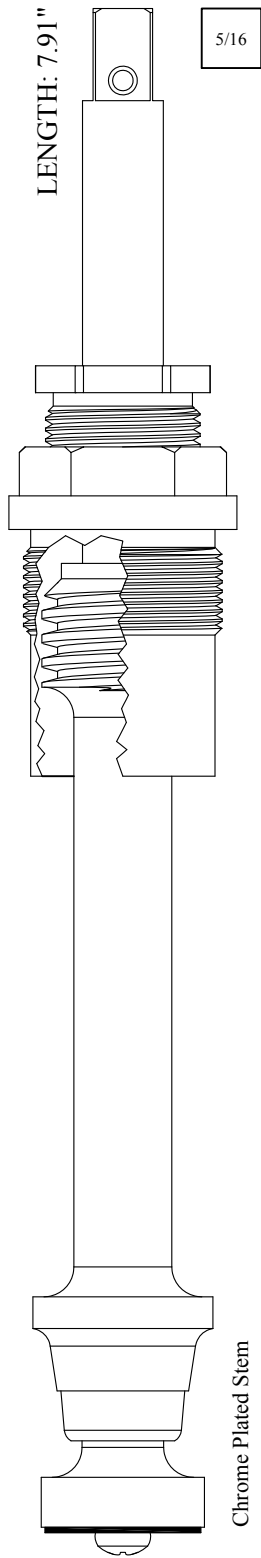

GASKET: 895560

428001
228001 Stem Only

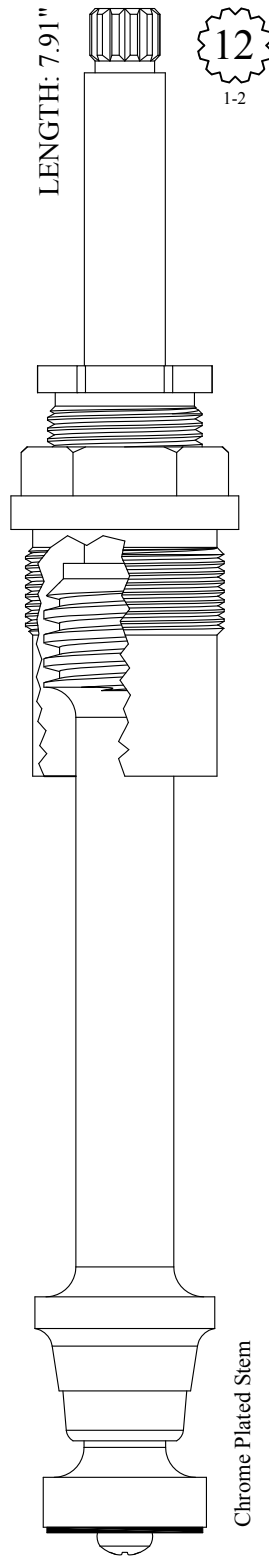

GASKET: 895560

428051
228051 Stem Only

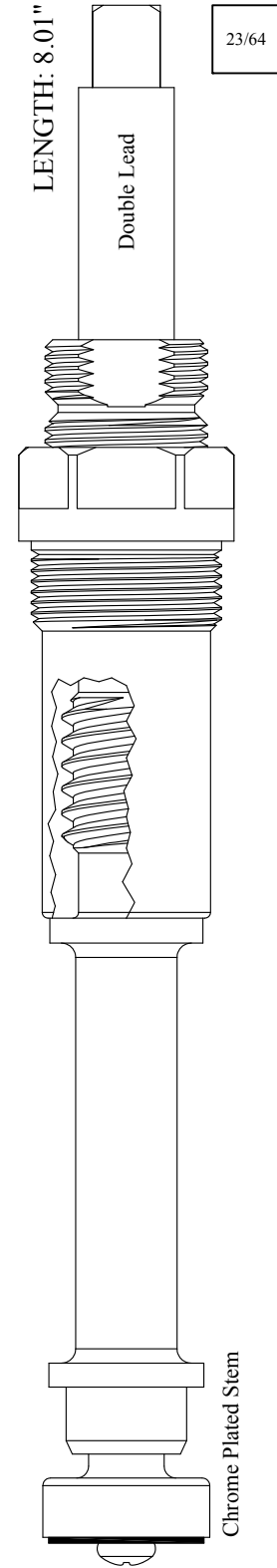

GASKET: 895550

LF480911
LF480912
LF280911 Stem Only
LF280912 Stem Only

FOR CRANE

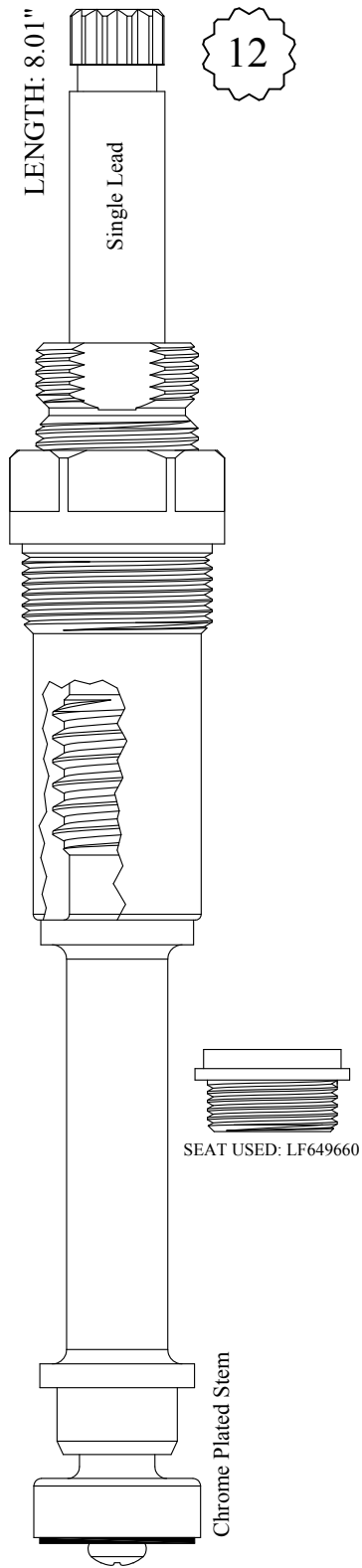

GASKET: 895340

LF480991
LF280991 Stem Only

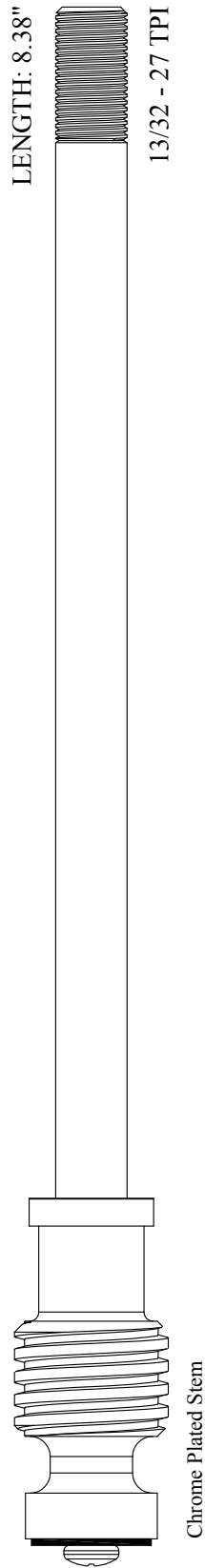

227101

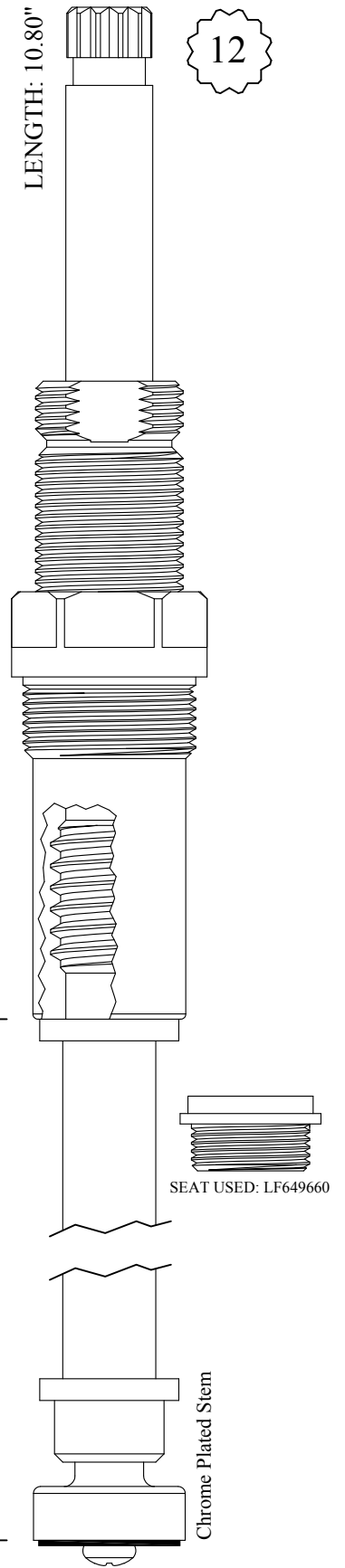

GASKET: 895340

428501
228501 Stem Only

FOR CUTHBERT

LENGTH: 1.80"

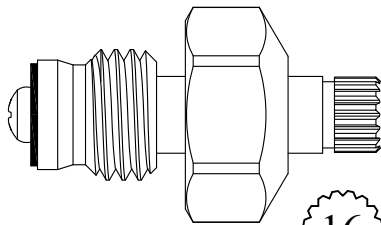

LF456971
LF256971 Stem Only

FOR DANFOSS

Old Style - Automatic

LENGTH: 3.59"

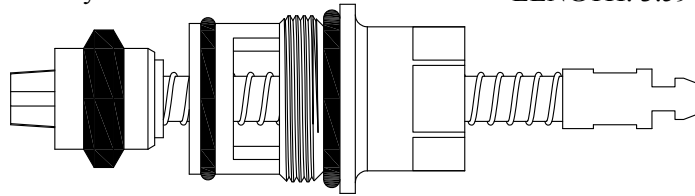

430790

GASKET: 894120 O-RING INCLUDED

New Style - Manual

LENGTH: 3.76"

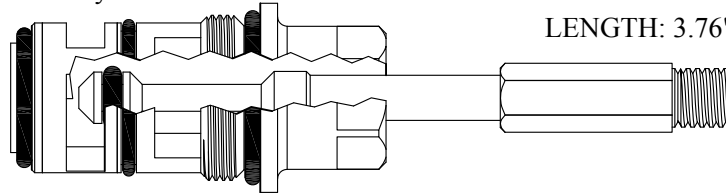

430850

GASKET: 894120 O-RING INCLUDED

Old Style - Automatic with Brass Link

LENGTH: 4.09"

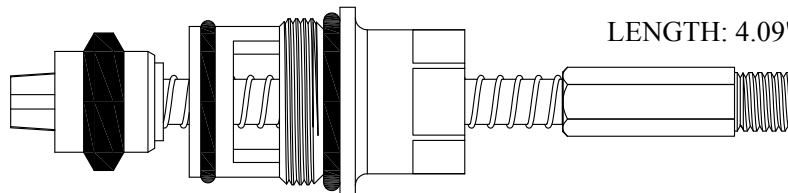

431130

GASKET: 894120 O-RING INCLUDED

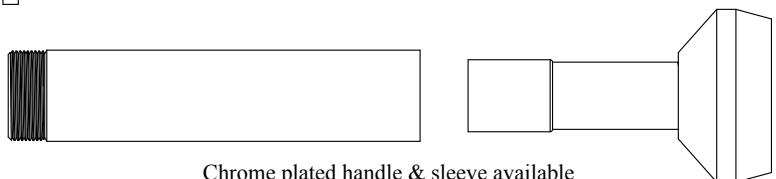

Chrome plated handle & sleeve available

128540

FOR DELTA

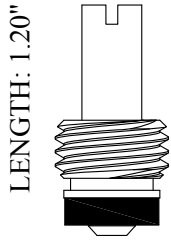

LENGTH: 1.20"

200141

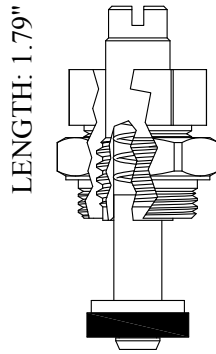

LENGTH: 1.79"

GASKET: 895060 INCLUDED

400151

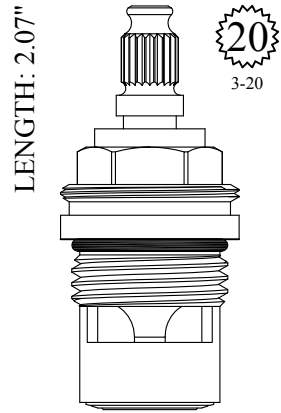

LENGTH: 2.07"

20
3-20

GASKET: 890170 O-RING INCLUDED
SEAL: 898510-W
DISC SET: 151380-PKG

LF459191
LF459192

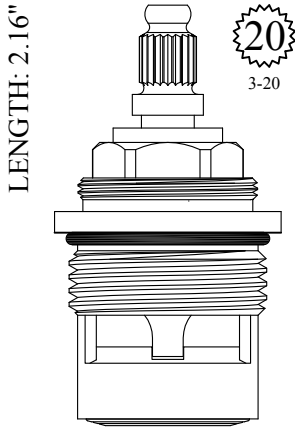

LENGTH: 2.16"

20
3-20

SEAL: 898520
DISC SET: 109850-PKG

401101
401102

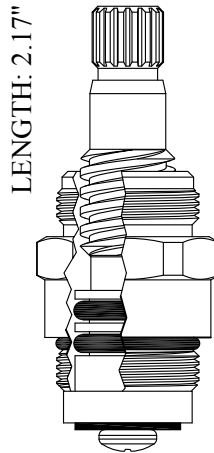

LENGTH: 2.17"

GASKET: 890160

LF460291
LF460292

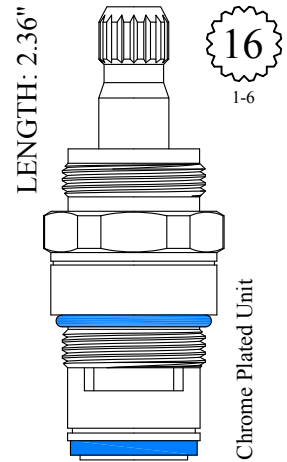

LENGTH: 2.36"

16
1-6

Chrome Plated Unit

LF462711
LF462712

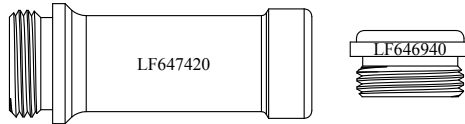

SEAT USED: LF647420 or LF646940

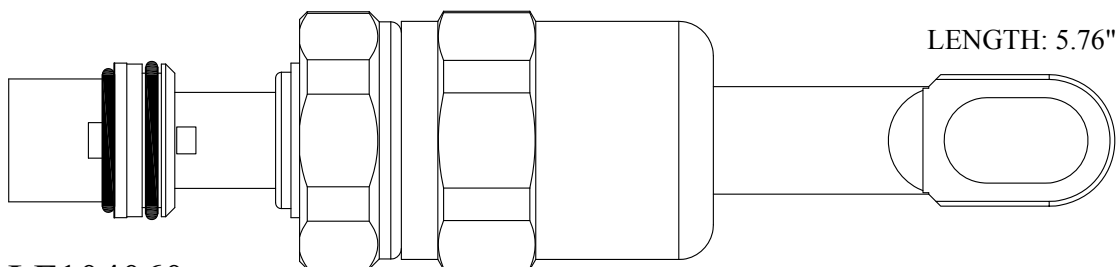

LENGTH: 5.76"

LF104060

FOR DICK BROTHERS

LENGTH: 1.45"

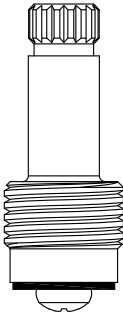

16
1-6

LF253011
LF253012



SEAT USED: LF649760

LENGTH: 1.59"

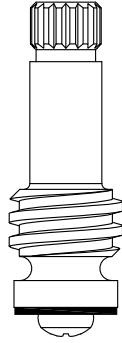

16
1-6

LF253161
LF253162

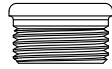

SEAT USED: LF649760

LENGTH: 1.60"

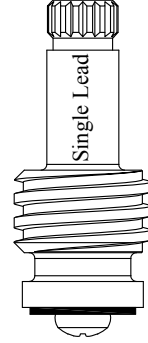

16
1-6

LF252251

LENGTH: 1.60"

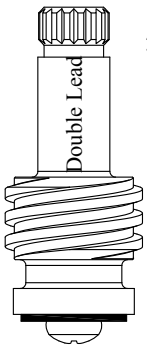

16
1-6

LF253151
LF253152

LENGTH: 1.62"

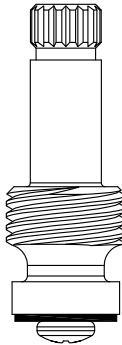

16
1-6

LF252151
LF252152



SEAT USED: LF649760

LENGTH: 1.80"

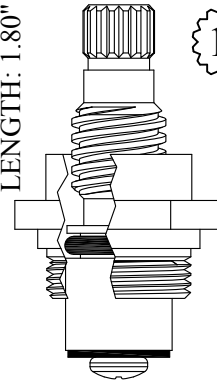

16
1-6

Chrome Plated Gland

GASKET: 895100

LF457071
LF457072

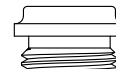

SEAT USED: LF648270

FOR DICK BROTHERS

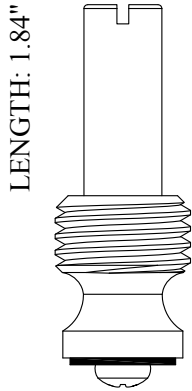

LF257001

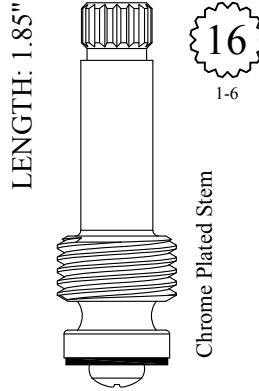

LF257061
LF257062

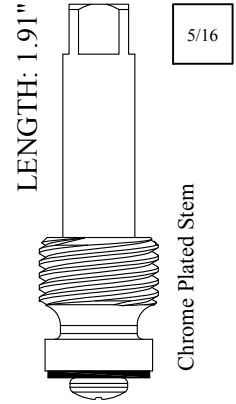

258211

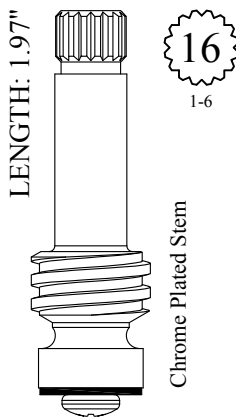

LF257271
LF257272

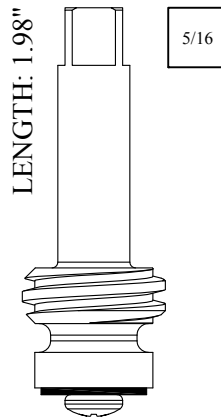
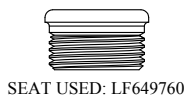

LF256711

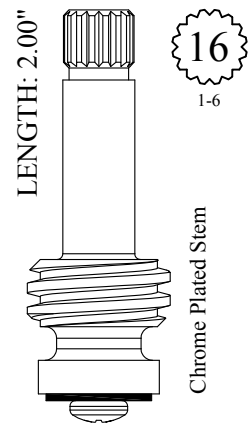

LF256701
LF256702



FOR DICK BROTHERS

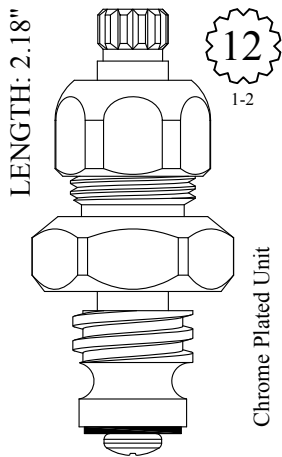

LF459901
LF259901 Stem Only

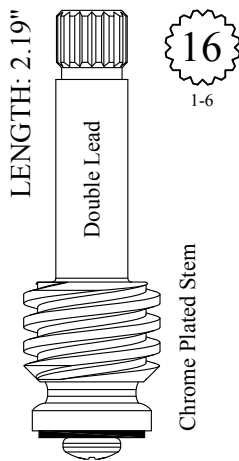

LF258111
LF258112

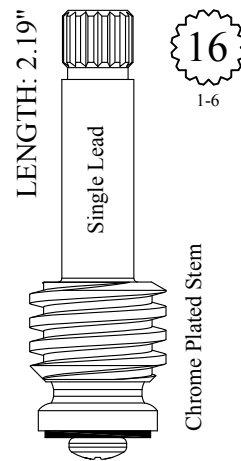

LF261061
LF261062

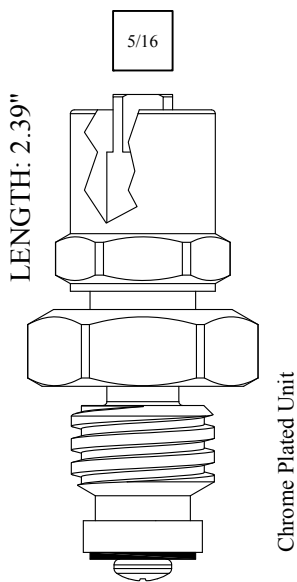
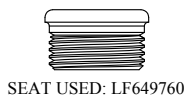

LF463091
LF263091 Stem Only

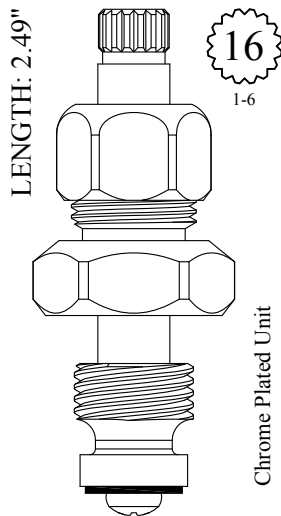

LF463841
LF463842
LF263841 Stem Only
LF263842 Stem Only

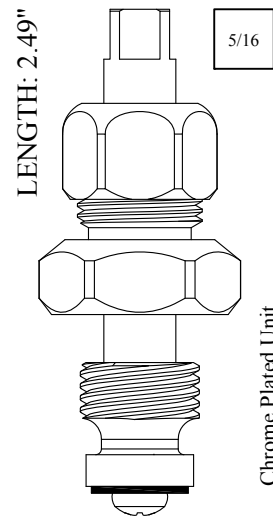

LF463851
LF263851 Stem Only

FOR DICK BROTHERS

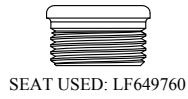

Chrome Plated Stem

LENGTH: 3.56"

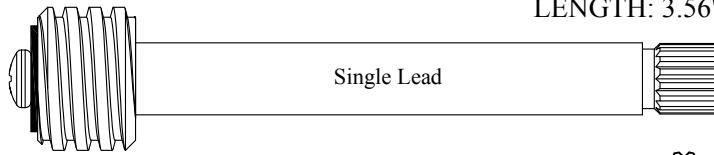

LF268211/ LF268212

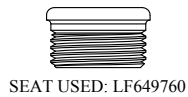

Chrome Plated Stem

LENGTH: 3.56"

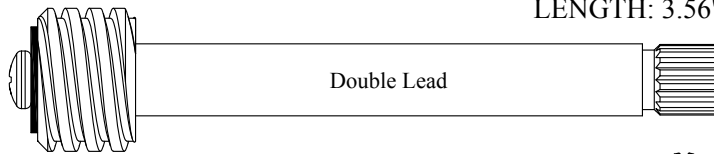

LF269031/ LF269032

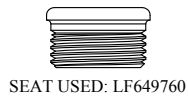

Chrome Plated Stem

LENGTH: 3.57"

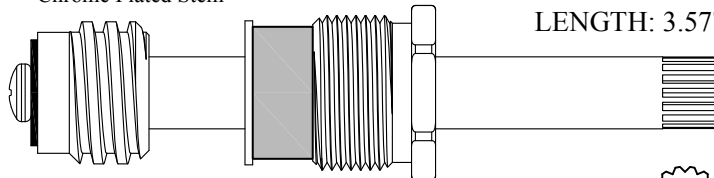

403011/ 403012
203011/ 203012 Stem Only

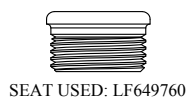

Chrome Plated Stem

LENGTH: 3.58"

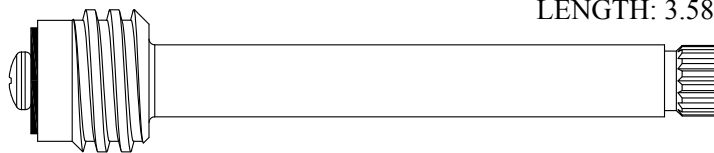

LF269091/ LF269092



FOR DICK BROTHERS



SEAT USED: LF649010

Chrome Plated Stem

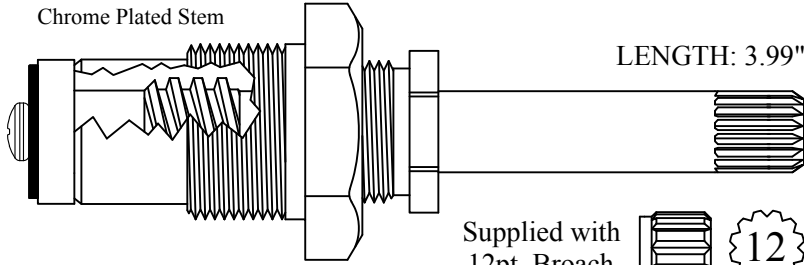

LENGTH: 3.99"

403961

GASKET: 895370

Supplied with
12pt. Broach



1-2

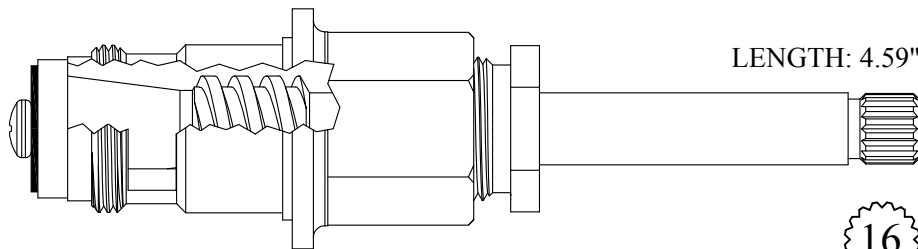

LENGTH: 4.59"

430611

230611 Stem Only

GASKET: 895350



1-6

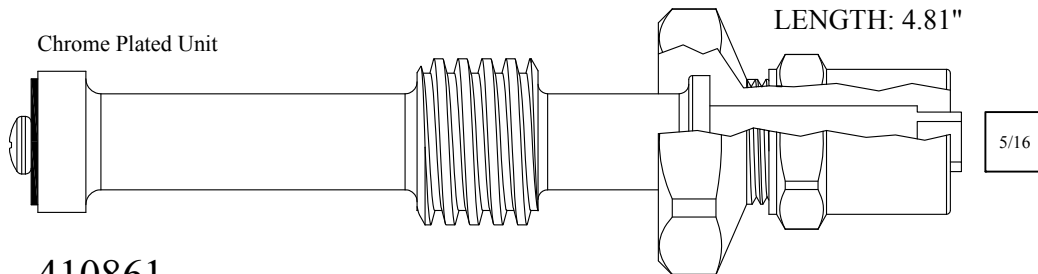

Chrome Plated Unit

LENGTH: 4.81"

410861

210861 Stem Only

GASKET: 895400 INCLUDED

5/16



SEAT USED: LF649760

Chrome Plated Stem

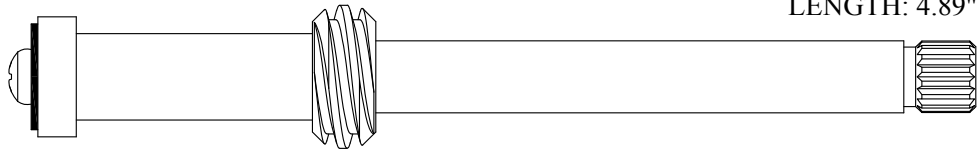

LENGTH: 4.89"

LF276311/ LF276312



1-6

FOR DICK BROTHERS

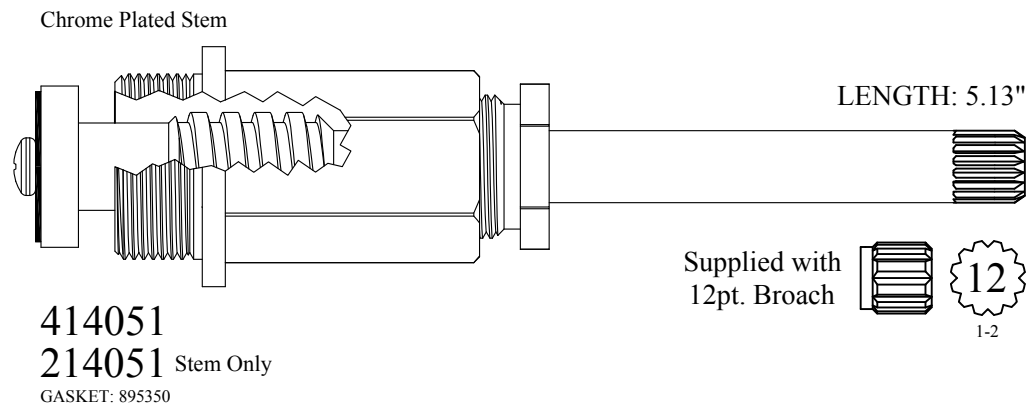
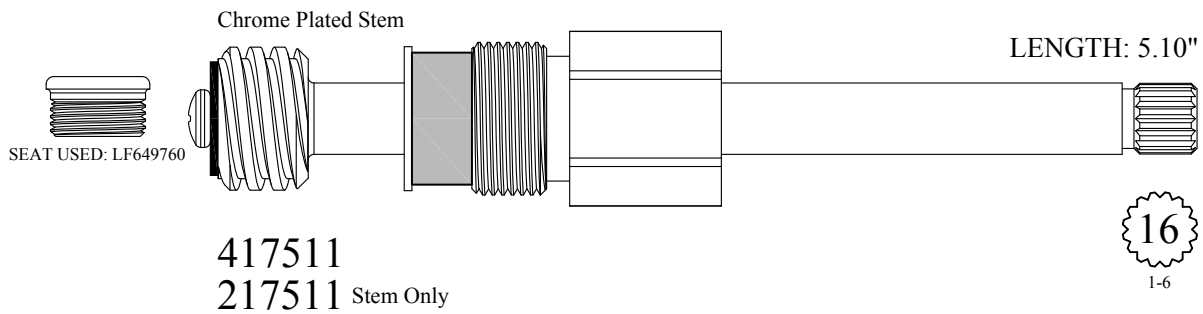
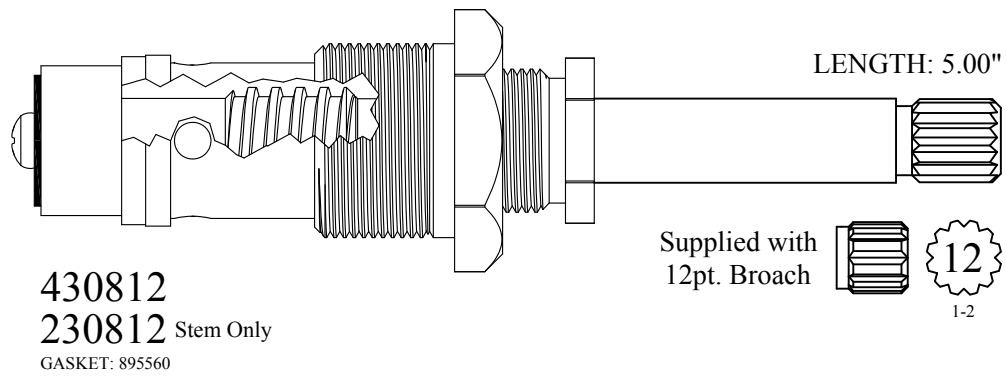
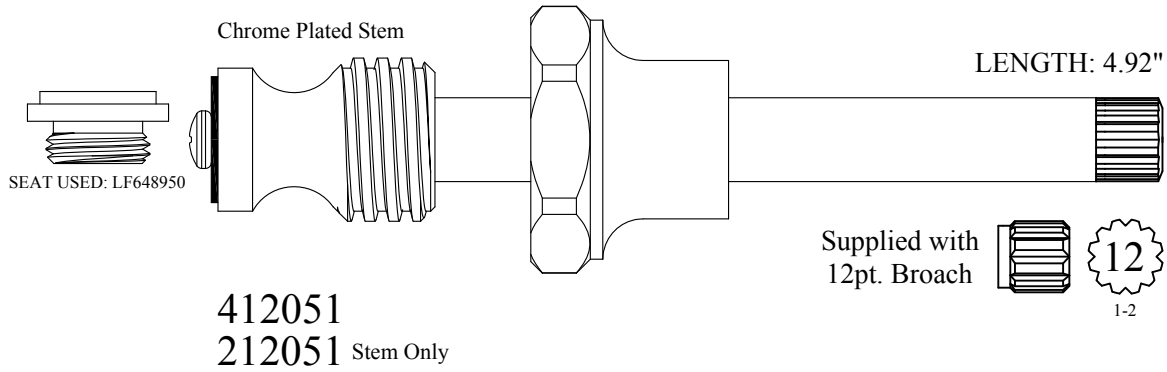

FOR DICK BROTHERS

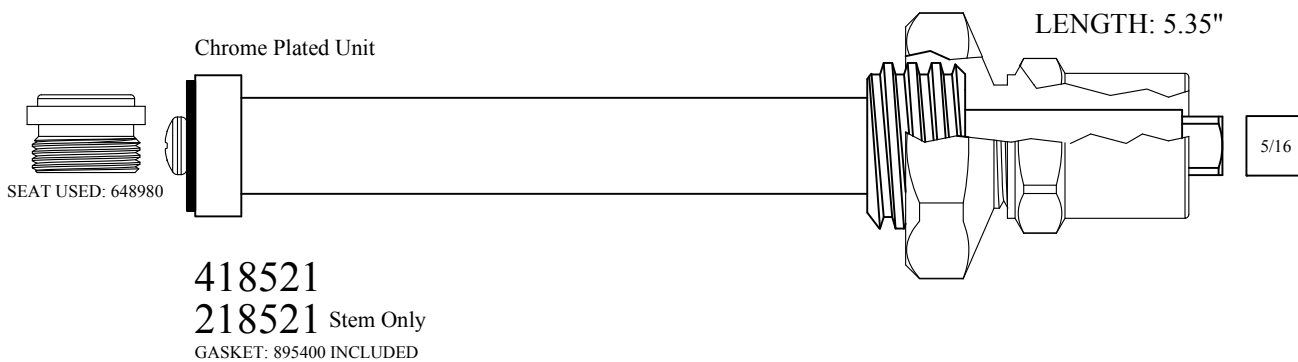
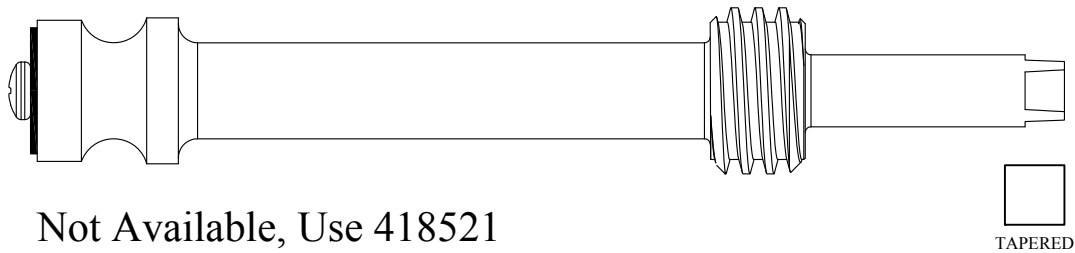
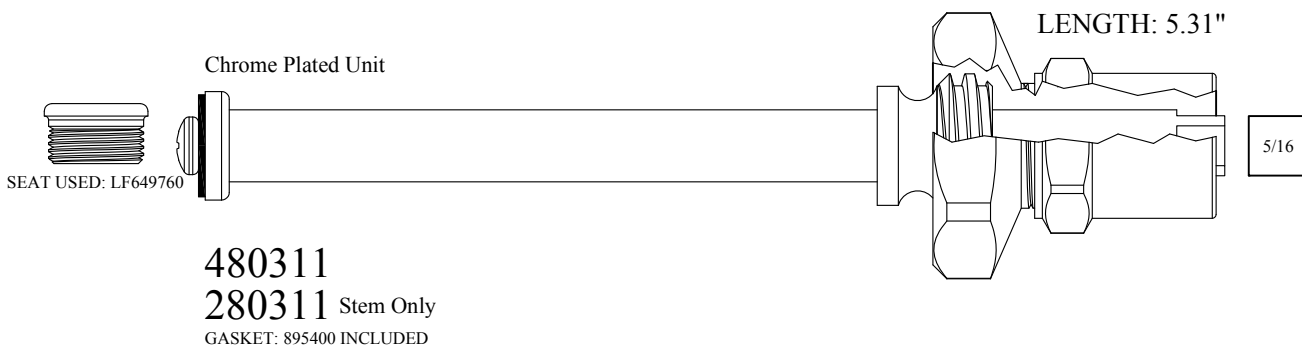
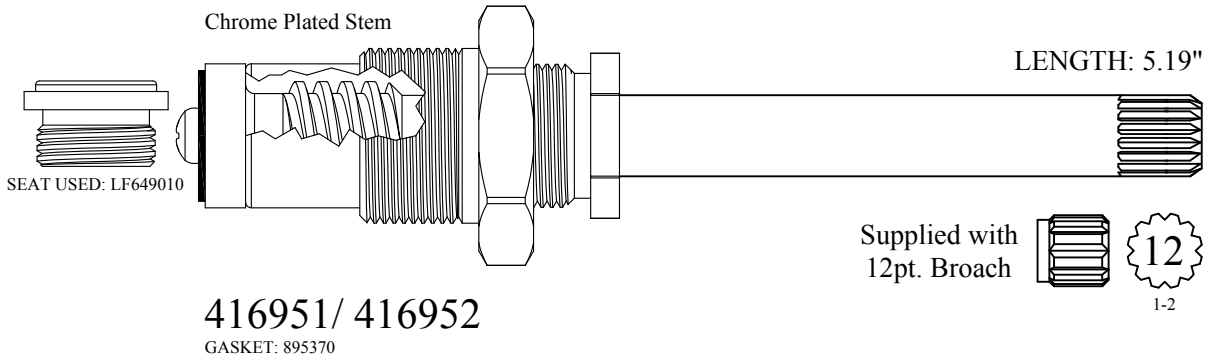

FOR DICK BROTHERS

Chrome Plated Stem

LENGTH: 5.41"

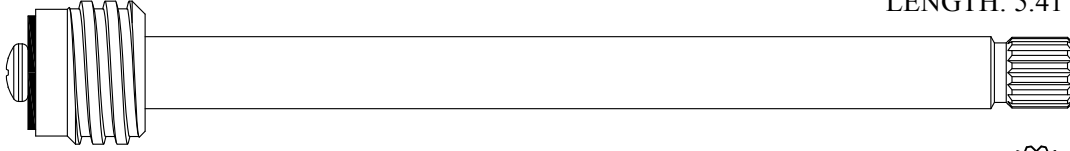

220411



SEAT USED: LF649760

16
1-6

Chrome Plated Stem

LENGTH: 5.63"

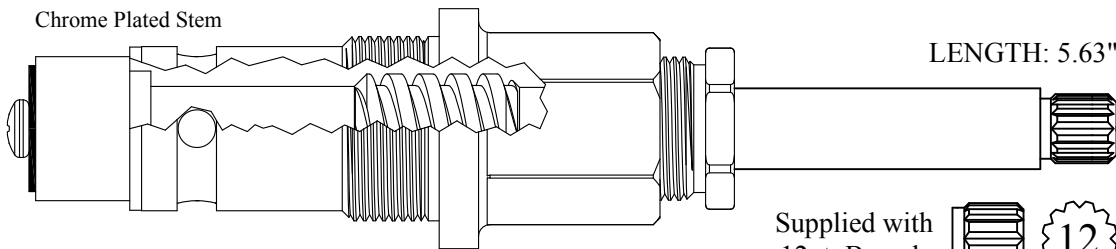

435351

235351 Stem Only

GASKET: 895350

Supplied with
12pt. Broach



12
1-2

Chrome Plated Stem

LENGTH: 5.71"

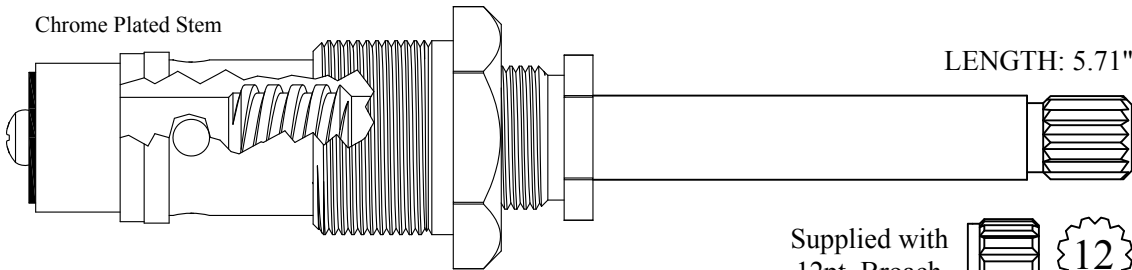

435732

Supplied with
12pt. Broach



12
1-2

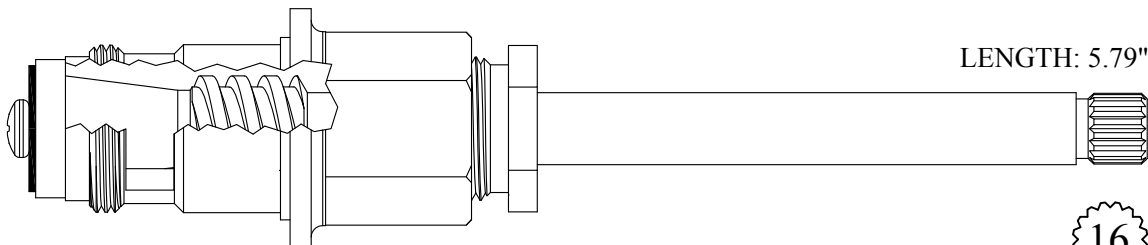

LENGTH: 5.79"

436301

236301 Stem Only

GASKET: 895350

16
1-6

FOR DICK BROTHERS

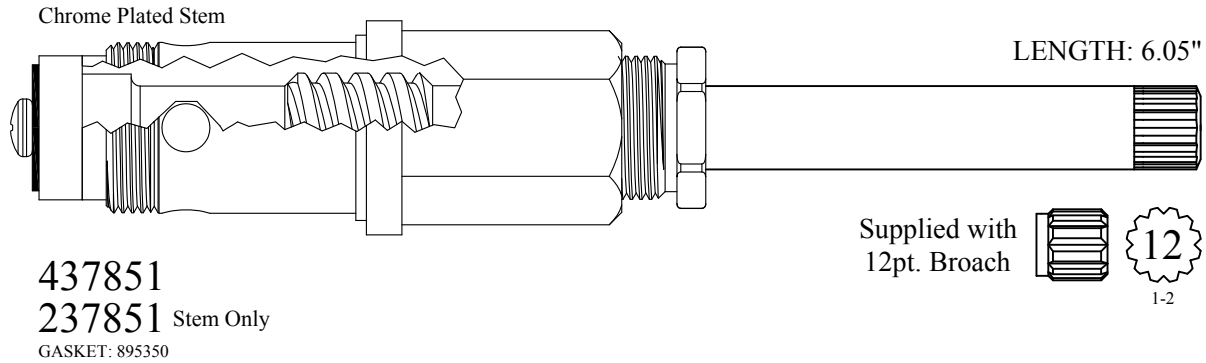

Send Your Orders To:

BARRY E.  WALTER  SR. CO.

E-mail: orderdesk@barrywalter.com

Fax: 1.800.886.9831

Phone: 1.800.767.5552

FOR DISHMASTER

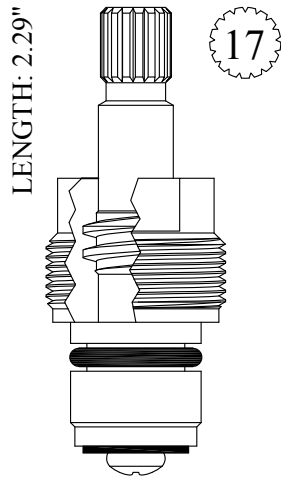

LF463051
LF463052



SEAT USED: LF649450

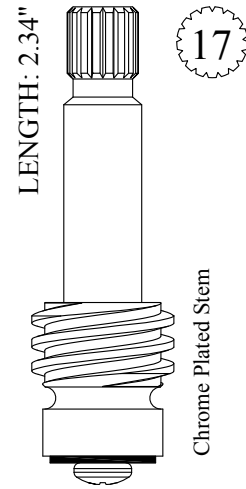

LF263191
LF263192

FOR DISNEY CRUISE

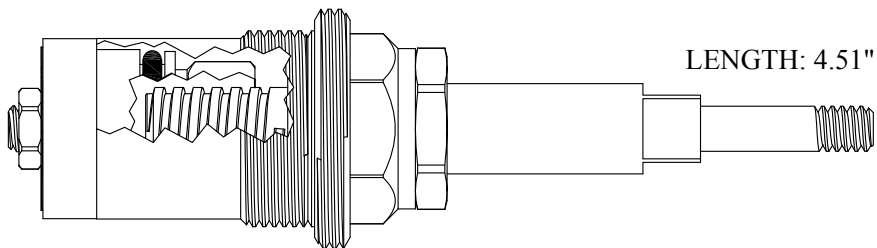

405722
GASKET: 895560

FOR DOBO

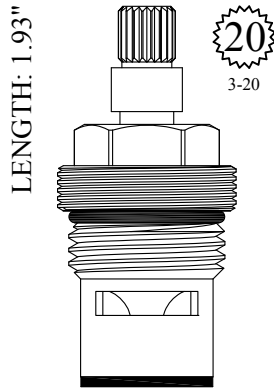

GASKET: 890170 O-RING INCLUDED
SEAL: 853030
DISC SET: 151380-PKG

LF456391
LF456392

FOR DOCOL

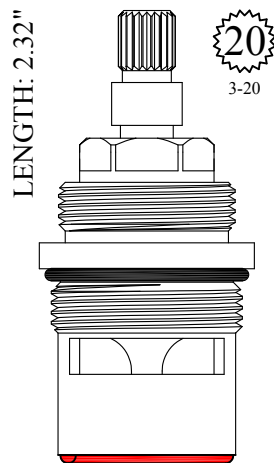

GASKET: 890210 O-RING INCLUDED
SEAL: 898610
DISC SET: 109850-PKG

401041
401042

FOR DOLLY TRIM

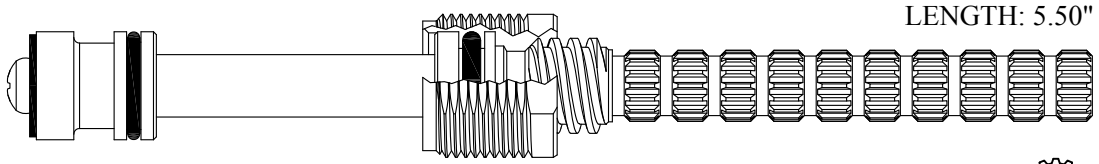

LENGTH: 5.50"

421511/ 421512

GASKET: 895400



SEAT USED: LF648670

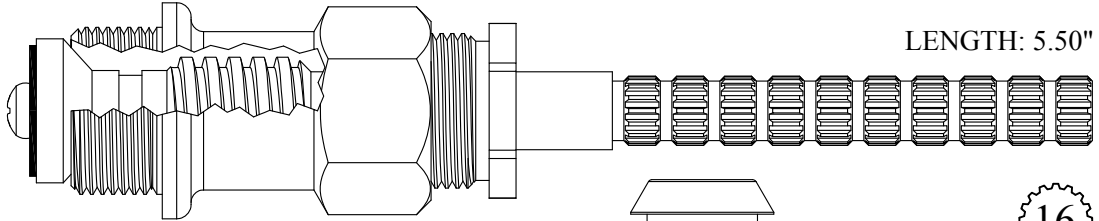

LENGTH: 5.50"

421621/ 421622

221621/ 221622 Stem Only

GASKET: 895400

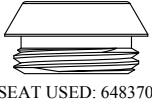

SEAT USED: 648370

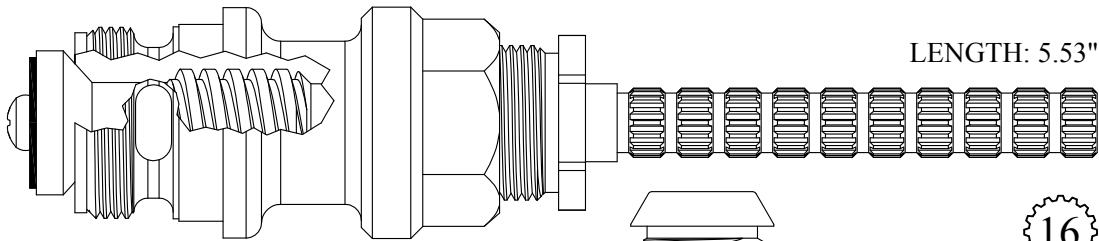

LENGTH: 5.53"

432021

234731 Stem Only

GASKET: 895560

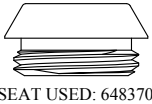

SEAT USED: 648370

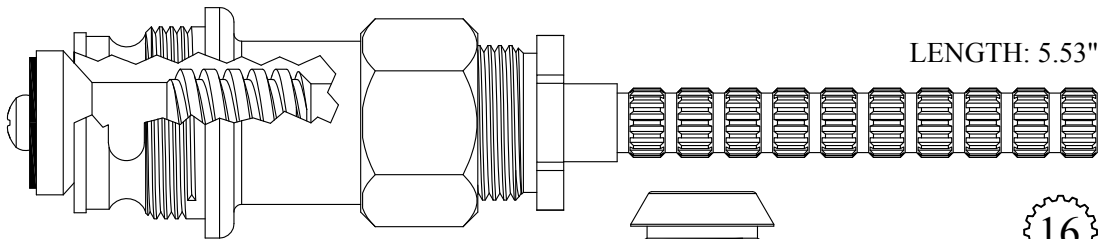

LENGTH: 5.53"

434731

234731 Stem Only

GASKET: 895550

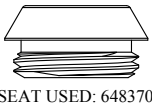

SEAT USED: 648370

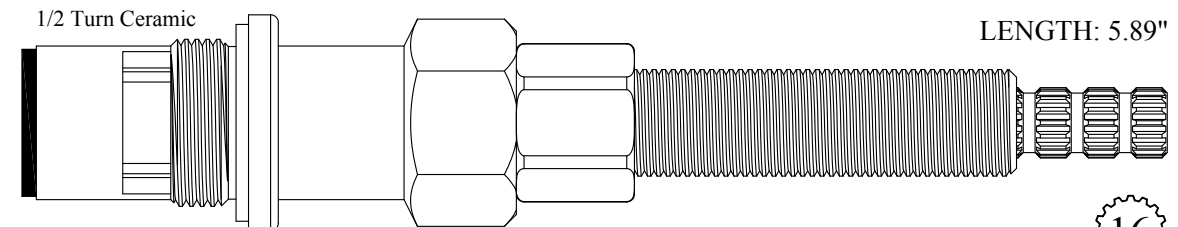

LENGTH: 5.89"

421641/ 421642

GASKET: 895390 INCLUDED

SEAL: 898550

DISC SET: 124290-PKG



FOR DOLLY TRIM

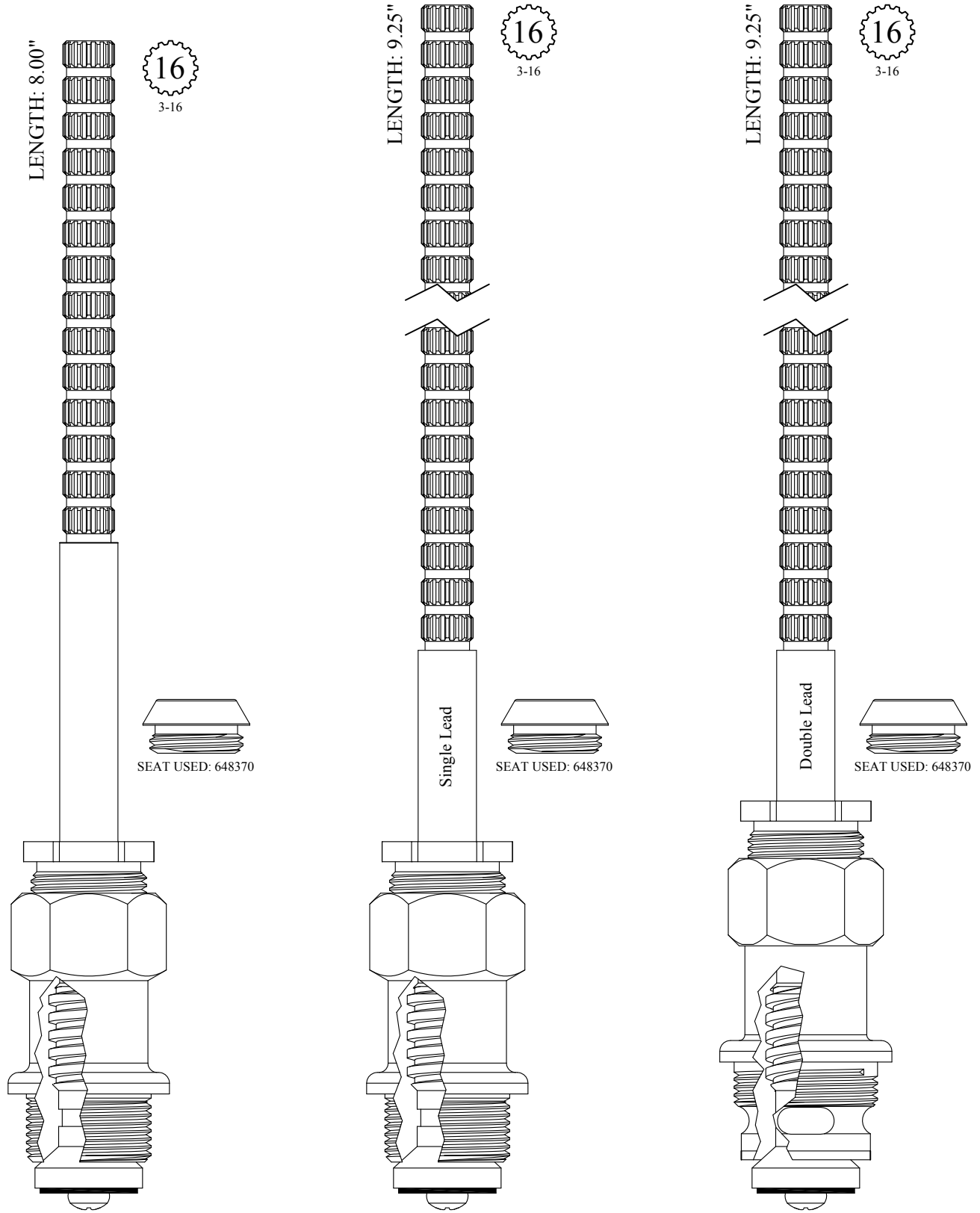

GASKET: 895400

428221

428222

228221 Stem Only

228222 Stem Only

GASKET: 895400

428391

428392

228391 Stem Only

228392 Stem Only

GASKET: 895550

439881

239881 Stem Only

FOR DOLPHIN

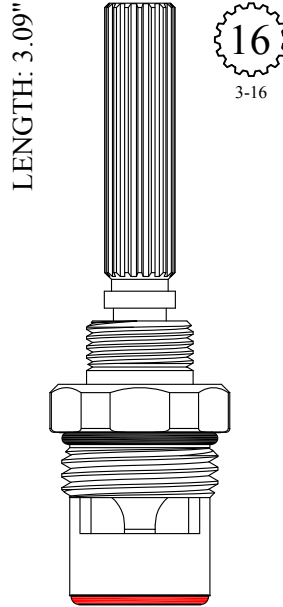

GASKET: 890170 O-RING INCLUDED
 SEAL: 898570-R/B
 DISC SET: 151380-PKG

LF466421
 LF466422

FOR DONNER

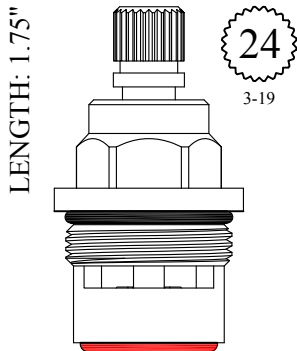

GASKET: 890180 O-RING INCLUDED
 SEAL: 898570-R/B
 DISC SET: 151380-PKG

LF455301
 LF455302

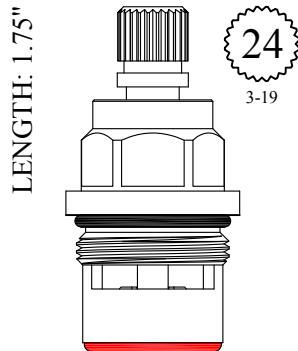

GASKET: 890170 O-RING INCLUDED
 SEAL: 898570-R/B
 DISC SET: 151380-PKG

LF455311
 LF455312

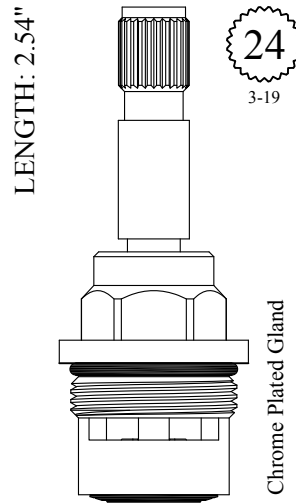

GASKET: 890180 O-RING INCLUDED
 SEAL: 898510
 DISC SET: 151380-PKG

LF464371
 LF464372

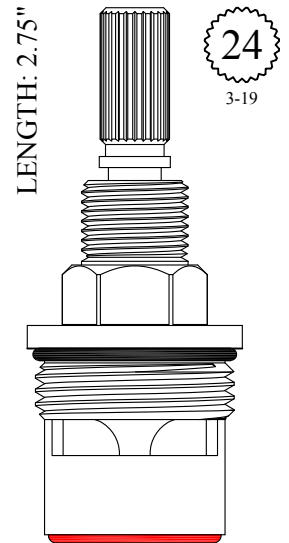

GASKET: 890210 O-RING INCLUDED
 SEAL: 898610-R/B
 DISC SET: 109850-PKG

401491
 401492

FOR DORF

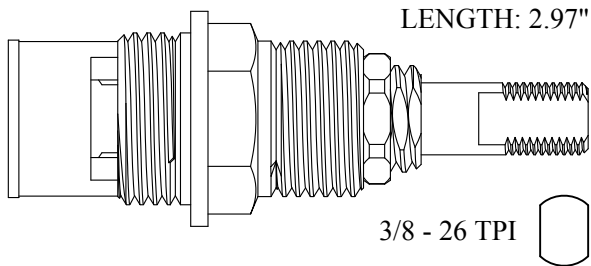

LF465941/ LF465942

DISC SET: 124290-PKG
GASKET: 895370 INCLUDED

Also available with Chrome Plated Stem
LF465941-CP / LF465942-CP

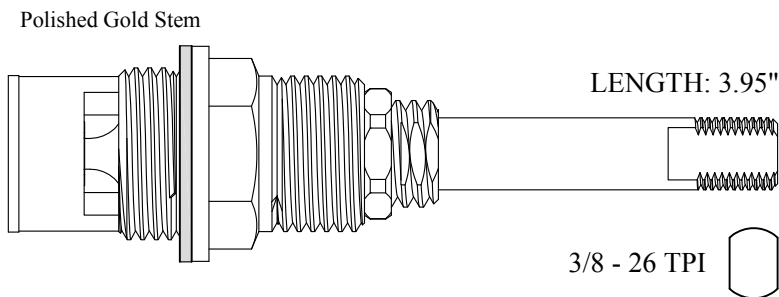

LF469301/ LF469302

DISC SET: 151380-PKG
GASKET: 895370 INCLUDED

Also available with a Polished Chrome Plated Stem
LF469301-CP / LF469302-CP

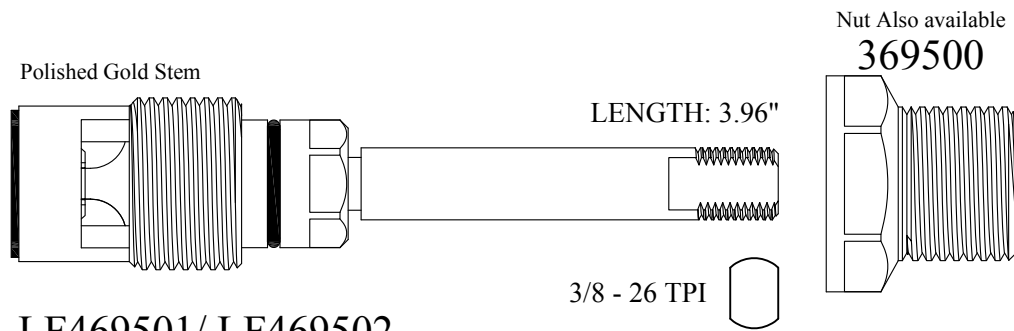

LF469501/ LF469502

DISC SET: 151380-PKG
GASKET: 895370

Also available with a Polished Chrome Plated Stem
LF469501-CP / LF469502-CP

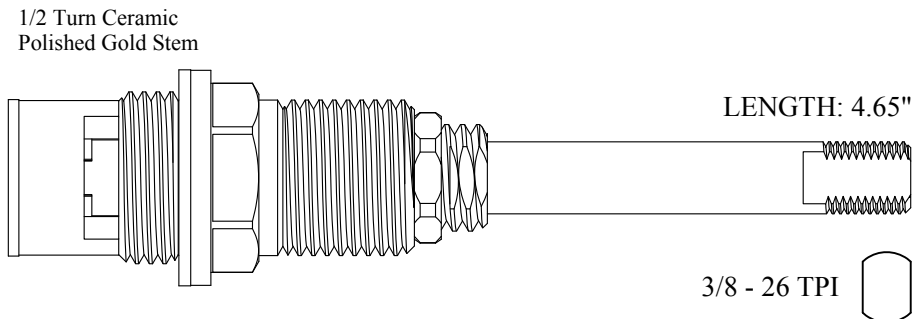

407941/ 407942

DISC SET: 124290-PKG
GASKET: 895370 INCLUDED

Also available with a Polished Chrome Plated Stem
407941-CP / 407942-CP

FOR DORF

1/2 Turn Ceramic
Polished Gold Stem

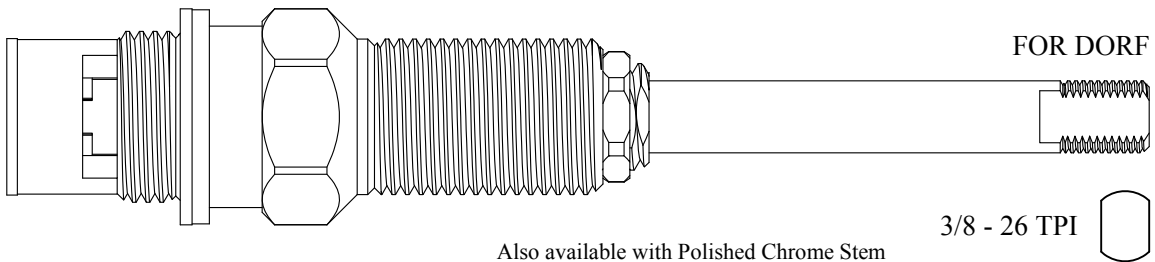

425941/ 425942

DISC SET: 124290-PKG
GASKET: 895370 INCLUDED

Also available with Polished Chrome Stem
425941-CP/ 425942-CP

1/4 Turn Ceramic
Polished Gold Stem

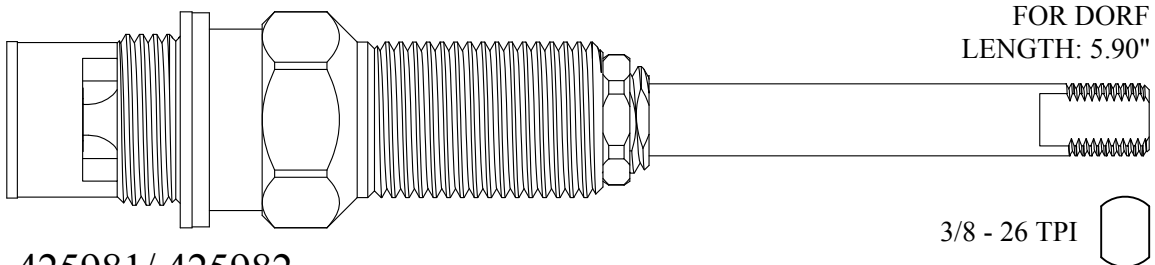

425981/ 425982

DISC SET: 151380-PKG
GASKET: 895370 INCLUDED

Chrome Plated Stem

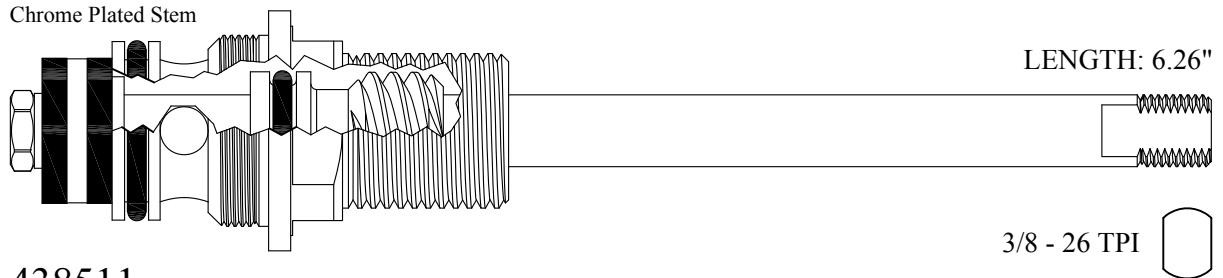

438511

GASKET: 895550

BARRY E.  SR. CO.

Send Your Orders To:

BARRY E.  SR. CO.

E-mail: orderdesk@barrywalter.com

Fax: 1.800.886.9831

Phone: 1.800.767.5552

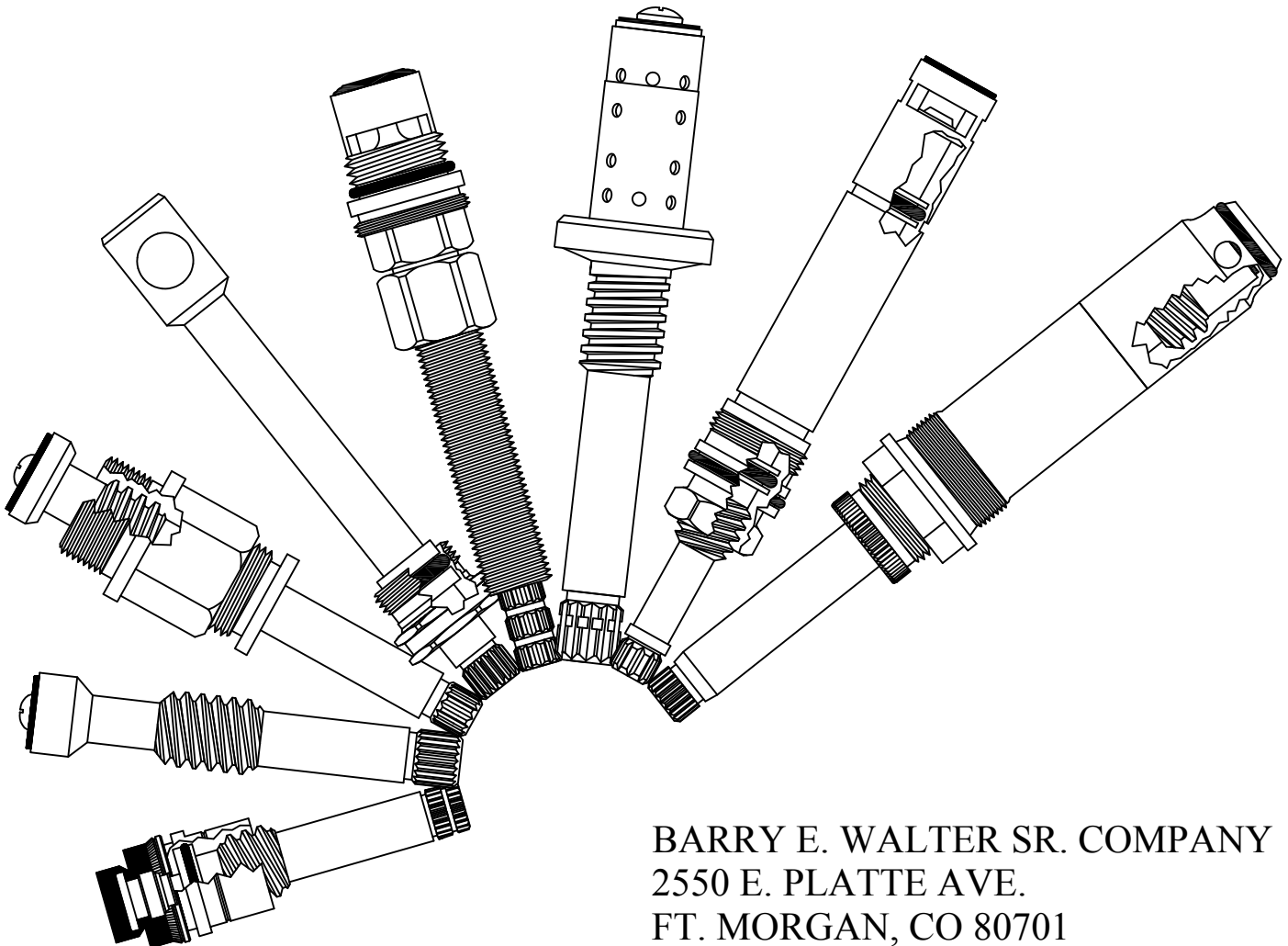

BARRY E. WALTER SR. COMPANY
2550 E. PLATTE AVE.
FT. MORGAN, CO 80701

*We are always adding new parts.
Check our website for updates.*

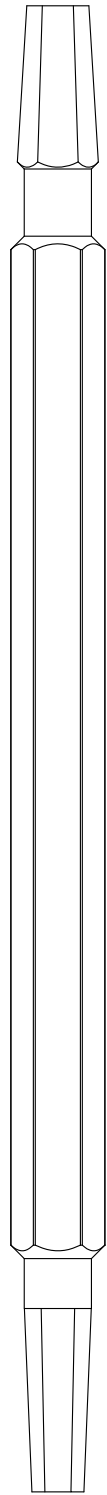

Hex Wrench

121580

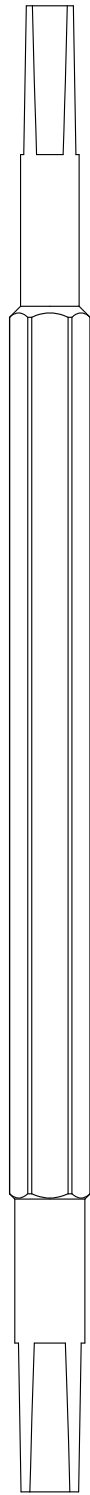

Small Square Wrench

121510

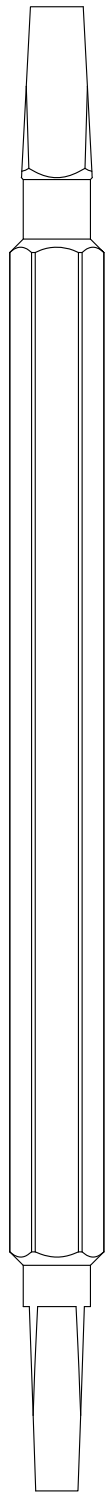

Large Square Wrench

121440

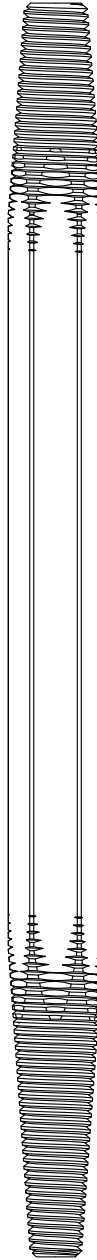

Easy-Out Wrench

134790

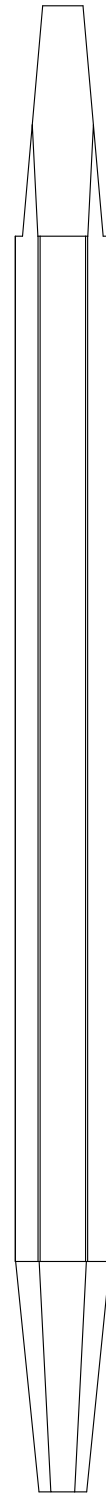

Squex Wrench

121650

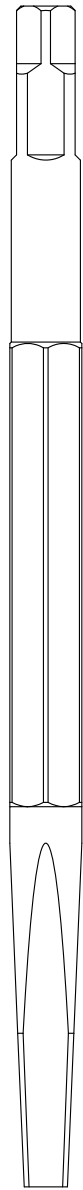

Mobile Home Wrench

192790

FOR DORNBRACHT

****ALL UNITS ON THIS PAGE COME WITH THE FOLLOWING:****

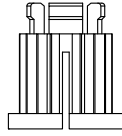

Comes with 20pt
Dornbracht adapter:
103200

LENGTH: 1.91"

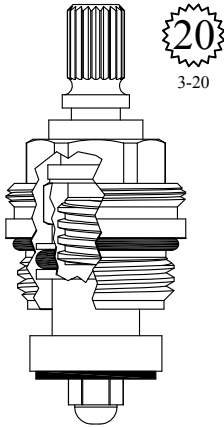

3-20

GASKET: 890170 O-RING INCLUDED

LF456362



SEAT USED: LF647110

LENGTH: 2.05"

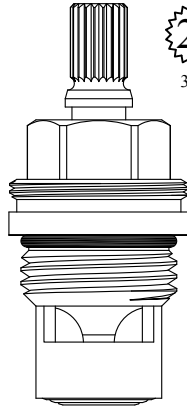

3-20

GASKET: 890170 O-RING INCLUDED

SEAL: 898500

DISC SET: 112530-PKG

LF459751
LF459752

LENGTH: 2.16"

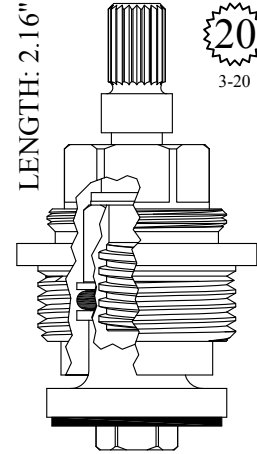

3-20

401082



SEAT USED: LF647120

LENGTH: 2.20"

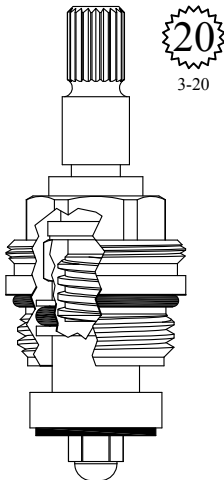

3-20

GASKET: 890170 O-RING INCLUDED

LF459512



SEAT USED: LF647110

LENGTH: 2.31"

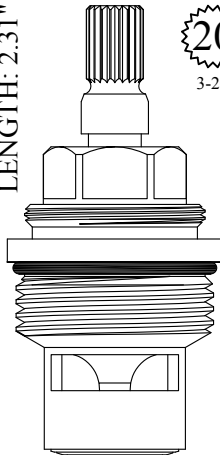

3-20

GASKET: 890210 O-RING INCLUDED

SEAL: 898510-W

DISC SET: 151380-PKG

401171
401172

LENGTH: 2.34"

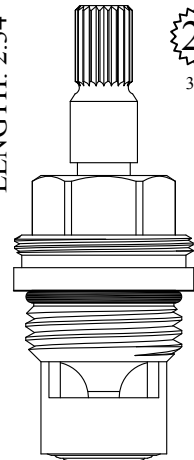

3-20

GASKET: 890170 O-RING INCLUDED

SEAL: 898500

DISC SET: 112530-PKG

LF462601
LF462602

FOR DORNBRACHT

SEAT USED: LF647110

FOR DORNBRACHT
LENGTH: 2.52"

LF463872
GASKET: 890170 O-RING INCLUDED

20
3-20

Comes with 20pt
Dornbracht adapter:
103200

SEAT USED: LF647120

LENGTH: 2.72"

401762
GASKET: 895560

20
3-20

Comes with 20pt
Dornbracht adapter:
103200

LENGTH: 2.86"

401691/ 401692
GASKET: 890210 O-RING INCLUDED
SEAL: 898510
DISC SET: 151380-PKG

20
3-20

Comes with 20pt
Dornbracht adapter:
103200

SEAT USED: LF647110

LENGTH: 3.24"

402242
GASKET: 890170 O-RING INCLUDED

20
3-20

Comes with 20pt
Dornbracht adapter:
103200

FOR DORNBRACHT

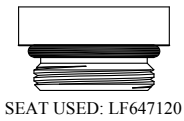

SEAT USED: LF647120

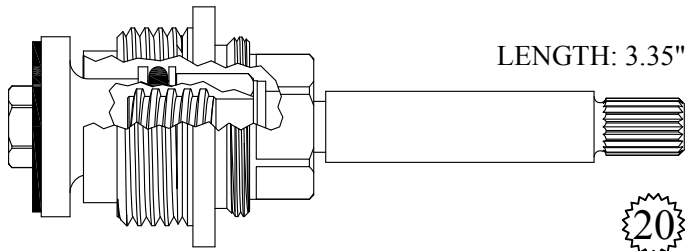

LENGTH: 3.35"

402752

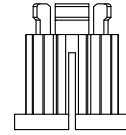

Comes with 20pt
Dornbracht adapter:
103200

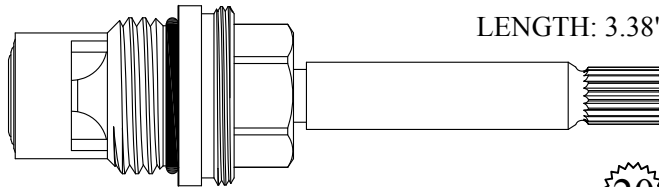

LENGTH: 3.38"

402601/ 402602

GASKET: 890170 O-RING INCLUDED
SEAL: 898500
DISC SET: 112530-PKG

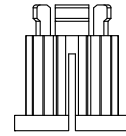

Comes with 20pt
Dornbracht adapter:
103200

Old Style - Automatic

LENGTH: 3.59"

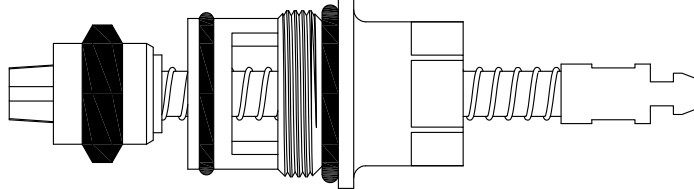

430790

GASKET: 894120 O-RING INCLUDED

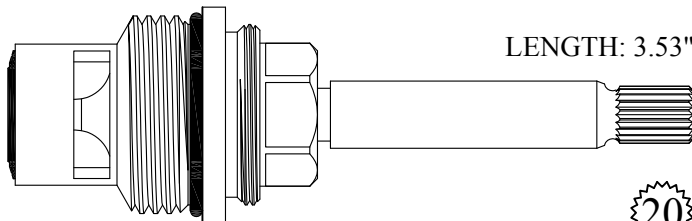

LENGTH: 3.53"

402861/ 402862

GASKET: 890210 O-RING INCLUDED
SEAL: 898510
DISC SET: 151380-PKG

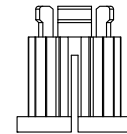

Comes with 20pt
Dornbracht adapter:
103200

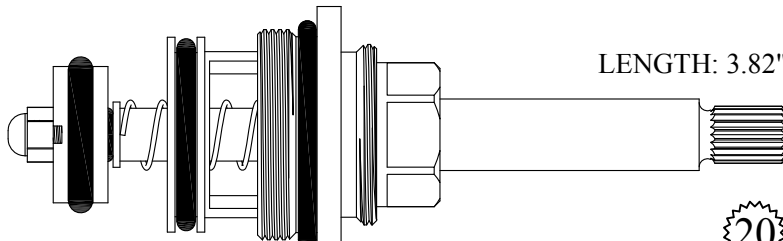

LENGTH: 3.82"

431630

GASKET: 891200 O-RING INCLUDED

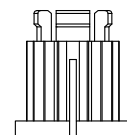

Comes with 20pt
Dornbracht adapter:
103200

FOR DORNBRACHT

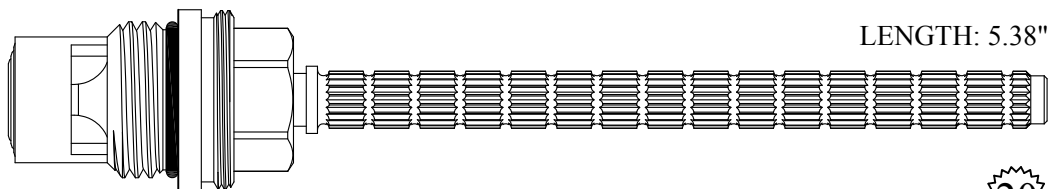

LENGTH: 5.38"

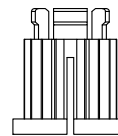

20

Comes with 20pt
Dornbracht adapter:
103200

421161/ 421162

GASKET: 890170 O-RING INCLUDED
SEAL: 898500
DISC SET: 112530-PKG

20
3-20

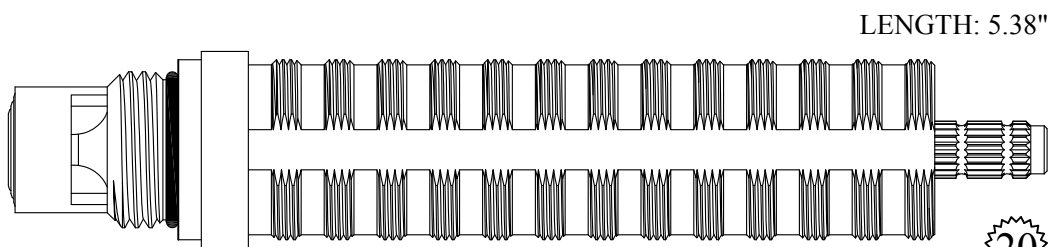

LENGTH: 5.38"

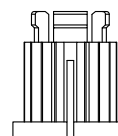

20

Comes with 20pt
Dornbracht adapter:
103200

421161-EN/ 421162-EN

GASKET: 890170 O-RING INCLUDED
SEAL: 898500
DISC SET: 112530-PKG

Escutcheon Nipple available separately
125080

20
3-20

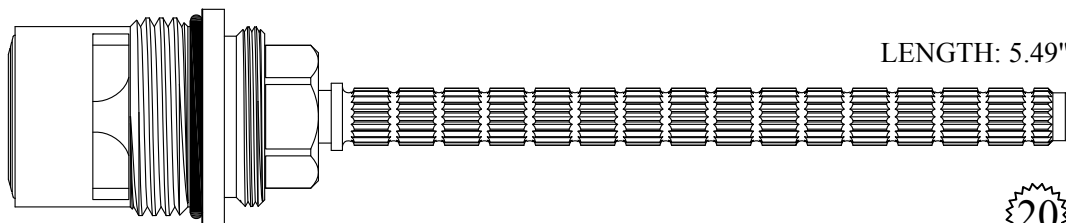

LENGTH: 5.49"

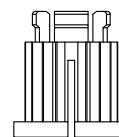

20

Comes with 20pt
Dornbracht adapter:
103200

422601/ 422602

GASKET: 890210 O-RING INCLUDED
SEAL: 898520
DISC SET: 109850-PKG

20
3-20

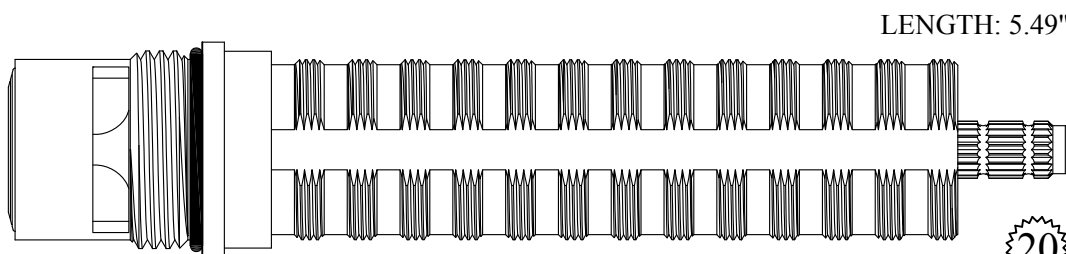

LENGTH: 5.49"

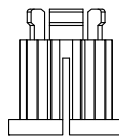

20

Comes with 20pt
Dornbracht adapter:
103200

422601-EN/ 422602-EN

GASKET: 890210 O-RING INCLUDED
SEAL: 898520
DISC SET: 109850-PKG

Escutcheon Nipple available separately
125080

20
3-20

FOR DWYER

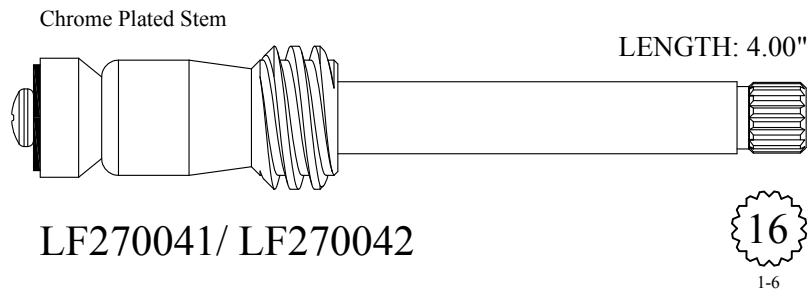

FOR EAST RIVER

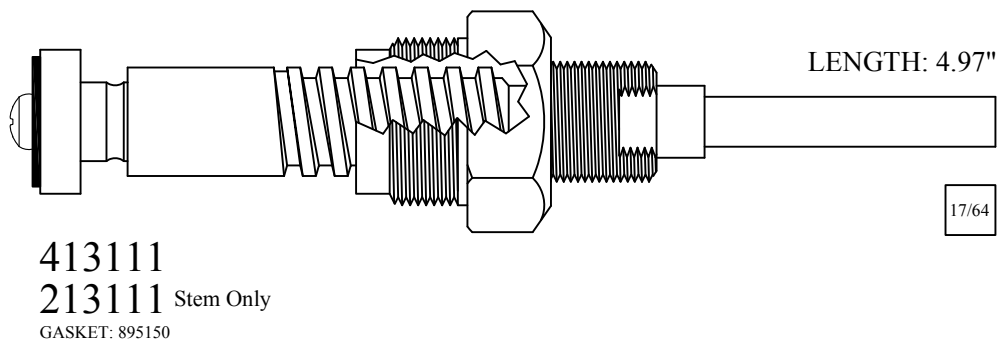
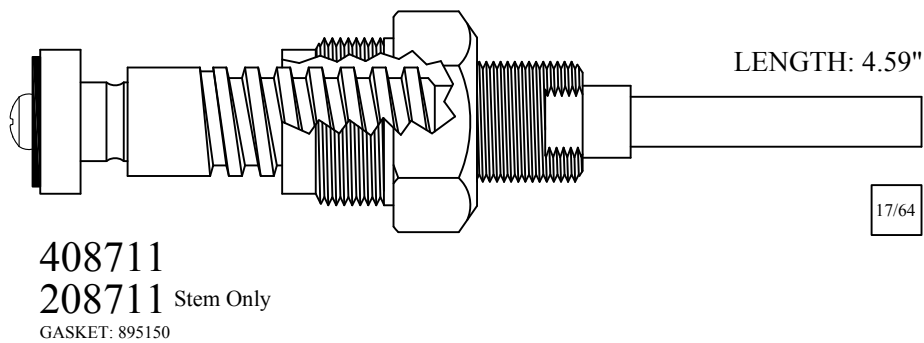

FOR EAST RIVER

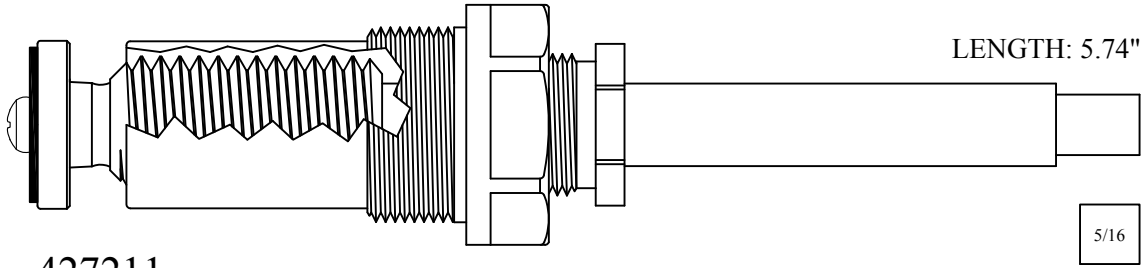

427211
227211 Stem Only
GASKET: 895540

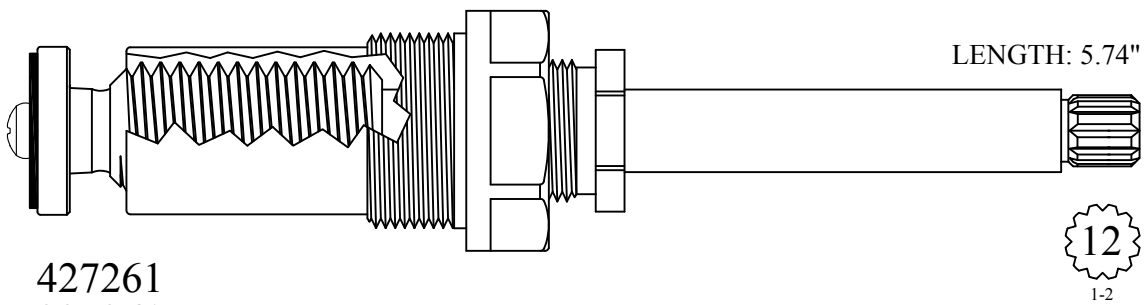

427261
227261 Stem Only
GASKET: 895540

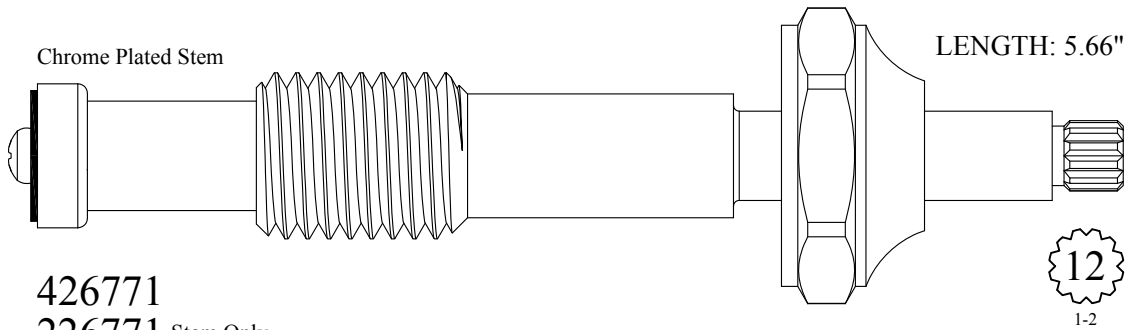

Chrome Plated Stem
426771
226771 Stem Only

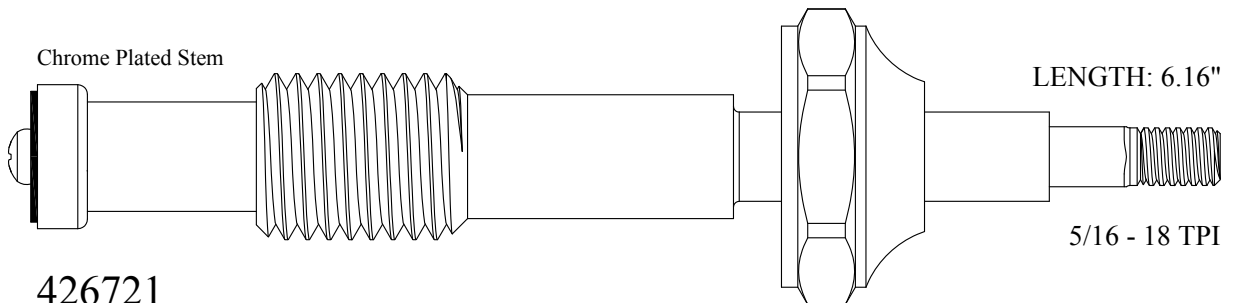

Chrome Plated Stem
426721
226721 Stem Only

FOR ELECTROWAY

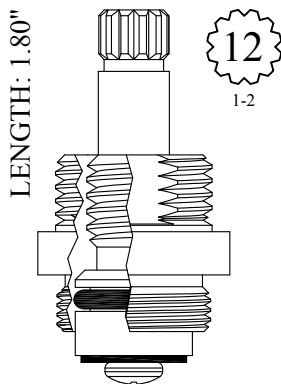

LF457141
LF457142

FOR ELIZABETHAN CLASSICS

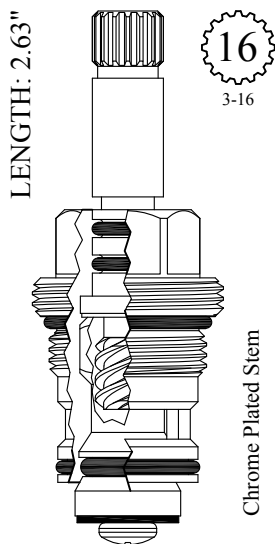

GASKET: 890180 O-RING INCLUDED

430881

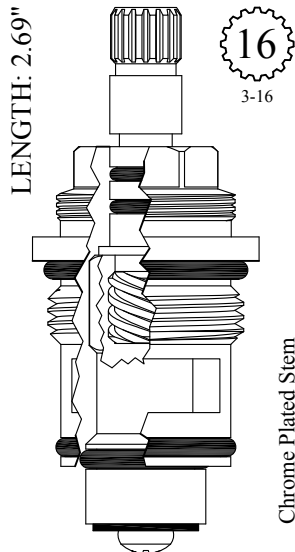

GASKET: 890180 O-RING INCLUDED

431052

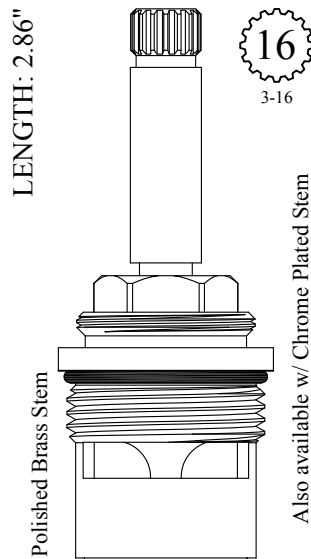

GASKET: 890210 O-RING INCLUDED
SEAL: 898520
DISC SET: 109850-PKG

401891
401892

Also available w/ Chrome Plated Stem
401891-CP / 401892-CP

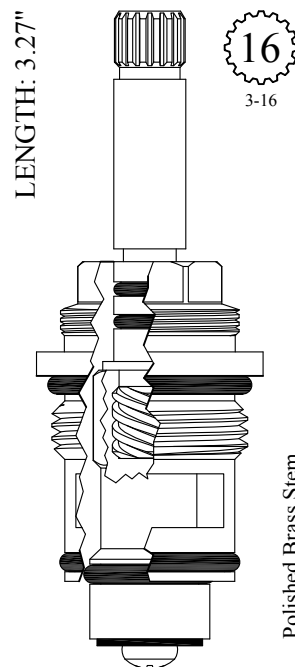

GASKET: 890180 O-RING INCLUDED

431552

FOR ELJER

LENGTH: 1.16"

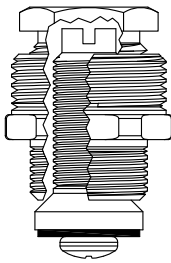

GASKET: 895060

400101

LENGTH: 1.19"

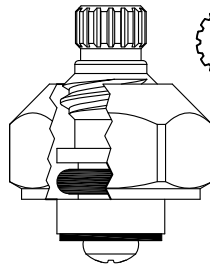

16

3-15

Nickel Plated Gland

LF450031
LF450032

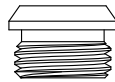

SEAT USED: LF648320

LENGTH: 1.25"

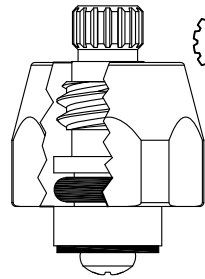

16

3-15

Nickel Plated Gland

LF450231
LF450232

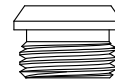

SEAT USED: LF648320

LENGTH: 1.25"

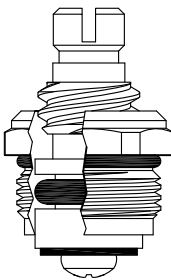

GASKET: 890160 O-RING INCLUDED

400131

LENGTH: 1.25"

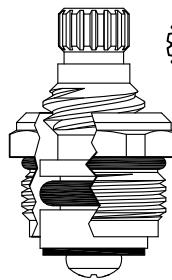

16

3-15

GASKET: 890160 O-RING INCLUDED

LF450851
LF450852

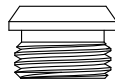

SEAT USED: LF648320

LENGTH: 1.25"

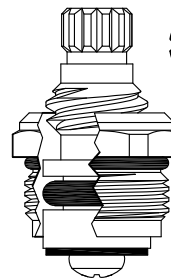

12

1-2

GASKET: 890160 O-RING INCLUDED

LF450861
LF450862

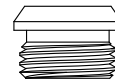

SEAT USED: LF648320

LENGTH: 1.38"

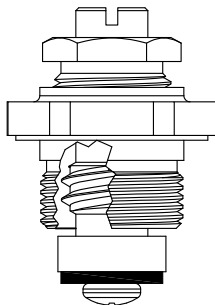

GASKET: 895100

400331
200331

LENGTH: 1.44"

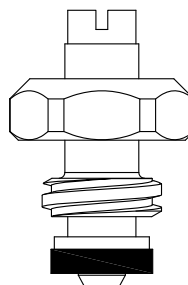

400251

LENGTH: 1.62"

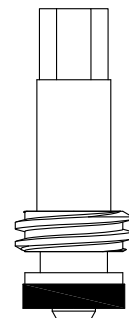

200351

FOR ELJER

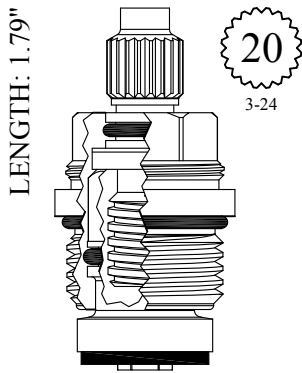

GASKET: 890170 O-RING INCLUDED

LF455962

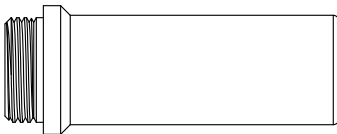

SEAT USED: LF647430

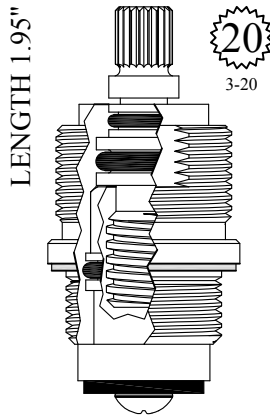

GASKET: 895160 INCLUDED

LF457242

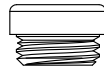

SEAT USED: LF647690

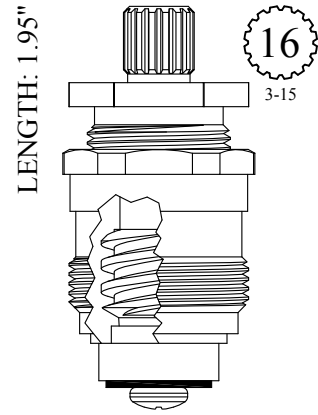

GASKET: 895120

LF458101

LF458102

LF258101 Stem Only

LF258102 Stem Only



SEAT USED: LF648160

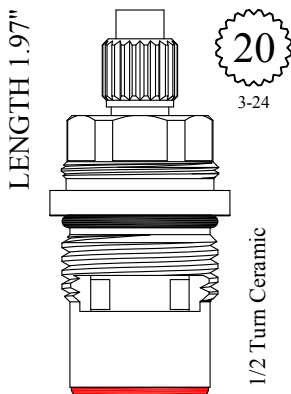

GASKET: 890170 O-RING INCLUDED
SEAL: 898570-R/B
DISC SET: 124290-PKG

LF457361

LF457362

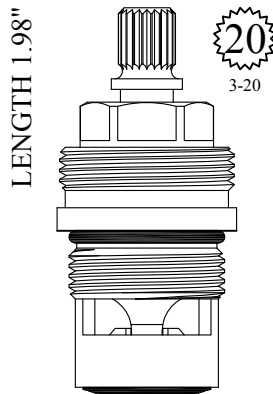

GASKET: 890170 O-RING INCLUDED
SEAL: 898510
DISC SET: 151380-PKG

LF457701

LF457702

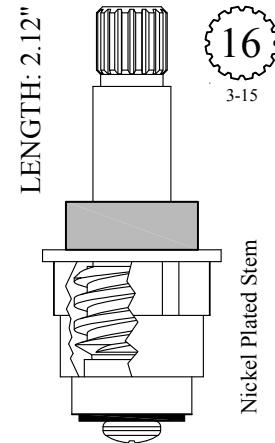

LF460091

LF460092

LF260091 Stem Only

LF260092 Stem Only



SEAT USED: LF648160

FOR ELJER

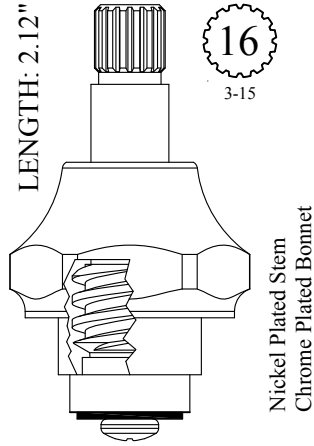

Nickel Plated Stem
Chrome Plated Bonnet

LF460191
LF460192
LF260091 Stem Only
LF260092 Stem Only

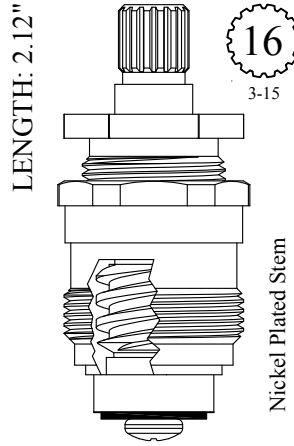

Nickel Plated Stem

GASKET: 895120

LF460111
LF460112
LF260091 Stem Only
LF260092 Stem Only

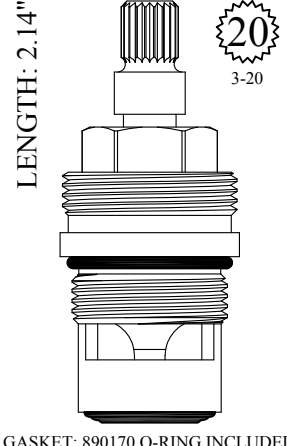

GASKET: 890170 O-RING INCLUDED
SEAL: 898510
DISC SET: 151380-PKG

LF459571
LF459572

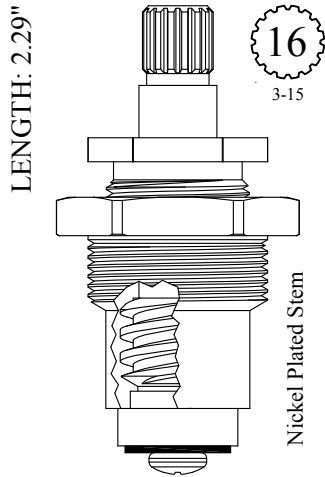

Nickel Plated Stem

GASKET: 895330

LF463071
LF463072
LF263071 Stem Only
LF263072 Stem Only

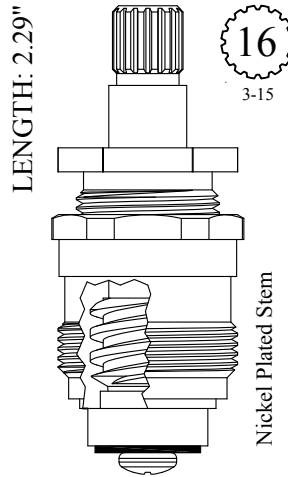

Nickel Plated Stem

GASKET: 895120

LF463171
LF463172
LF263071 Stem Only
LF263072 Stem Only

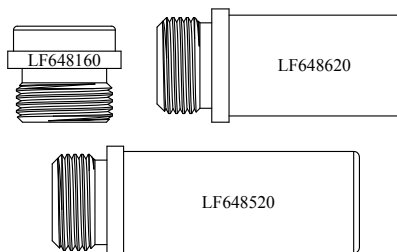

SEATS USED: LF648160, LF648520 & LF648620

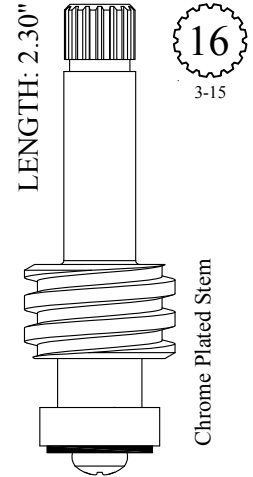

Chrome Plated Stem

LF260201
LF260202

FOR ELJER

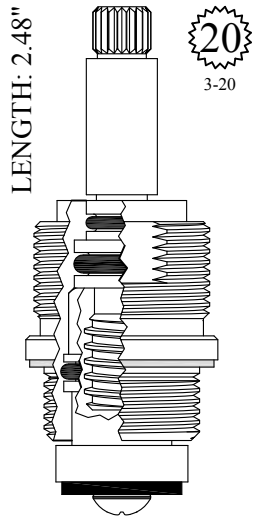

GASKET: 895160 INCLUDED

401342



SEAT USED: LF647690

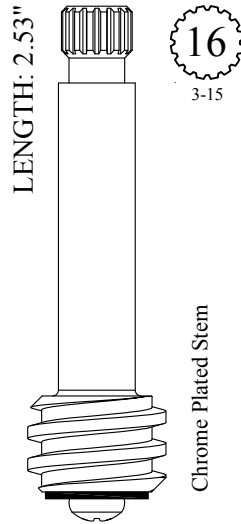

LF265171

Chrome Plated Stem

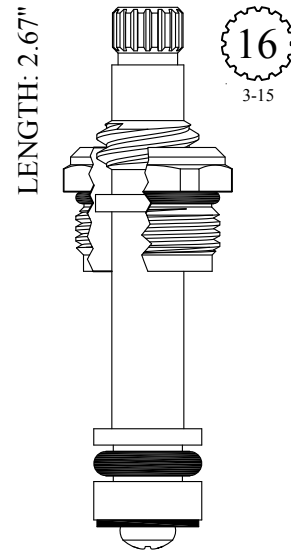

GASKET: 890160 O-RING INCLUDED

LF465381



SEAT USED: LF648320

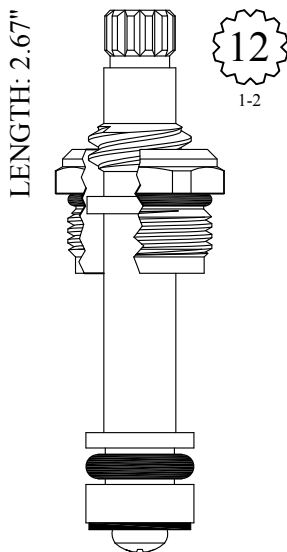

GASKET: 890160 O-RING INCLUDED

LF465391
LF465392



SEAT USED: LF648320

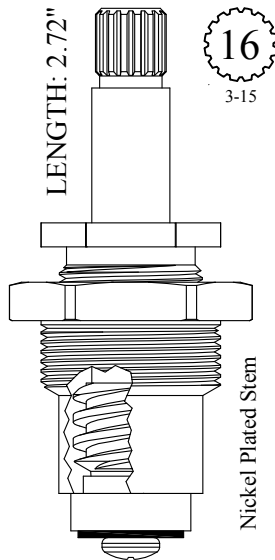

GASKET: 895330

LF465071
LF465072
LF265071 Stem Only
LF265072 Stem Only

Nickel Plated Stem



SEAT USED: LF648160

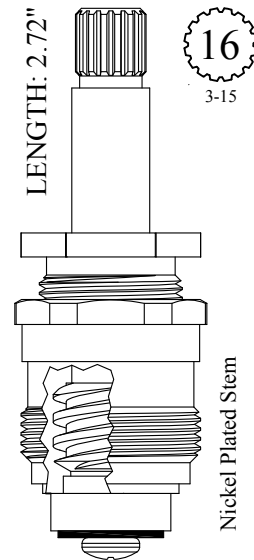

GASKET: 895120

LF465571
LF465572
LF265071 Stem Only
LF265072 Stem Only

Nickel Plated Stem



SEAT USED: LF648160

FOR ELJER

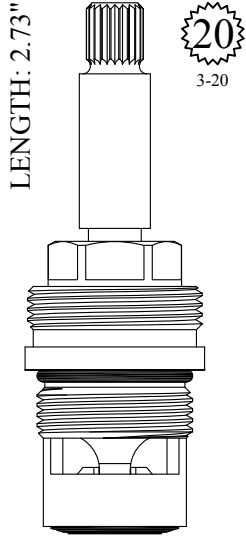

GASKET: 890170 O-RING INCLUDED
SEAL: 898510
DISC SET: 151380-PKG

LF464921
LF464922

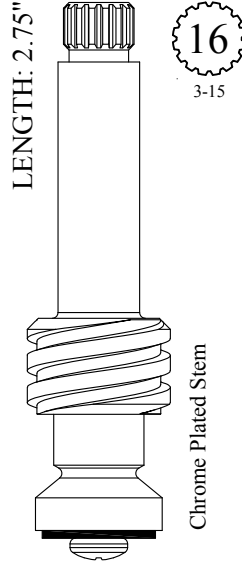

LF265601
LF265602

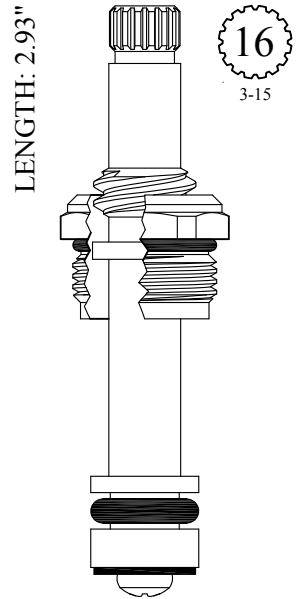

GASKET: 890160 O-RING INCLUDED

LF465801
LF465802



SEAT USED: LF648320

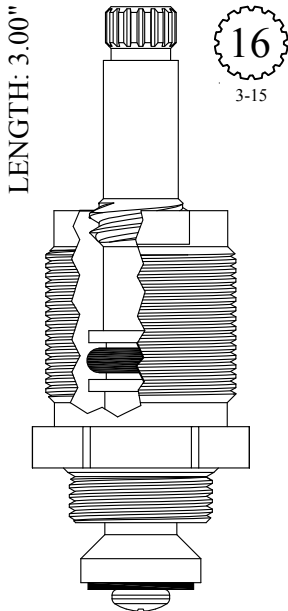

GASKET: 895100

401741
401742



SEAT USED: LF648320

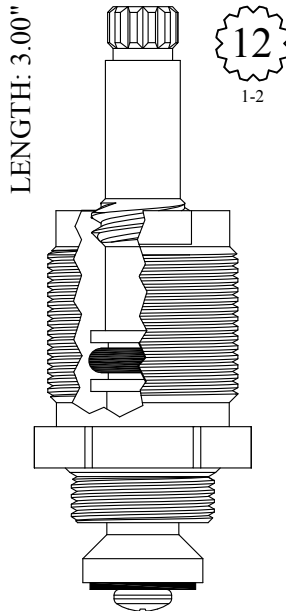

GASKET: 895100

401791
401792

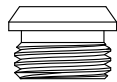

SEAT USED: LF648320

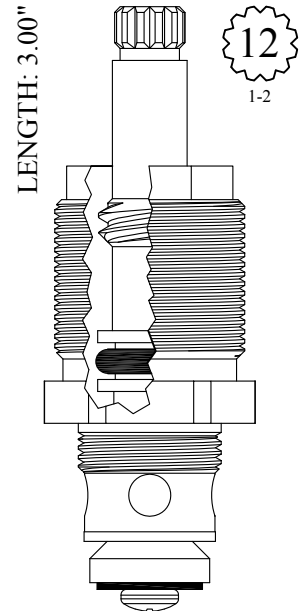

GASKET: 895100

430271

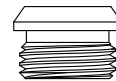

SEAT USED: LF648320

FOR ELJER



SEAT USED: LF648320

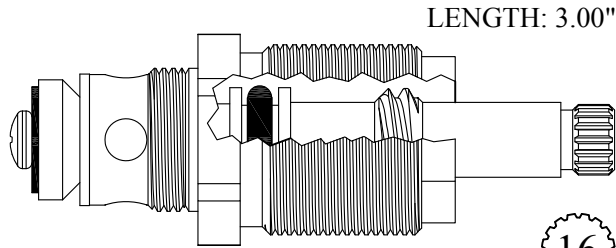

LENGTH: 3.00"

430281
GASKET: 895100



SEAT USED: LF647690

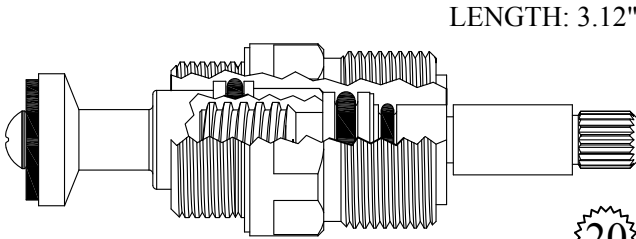

LENGTH: 3.12"

402012
GASKET: 895160 INCLUDED



Also available with polished brass stem

LF467111-PB/ LF467112-PB
LF267111-PB/ LF267112-PB Stem Only

Chrome Plated Stem

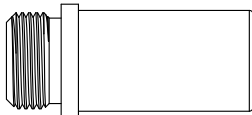

SEAT USED: LF648620

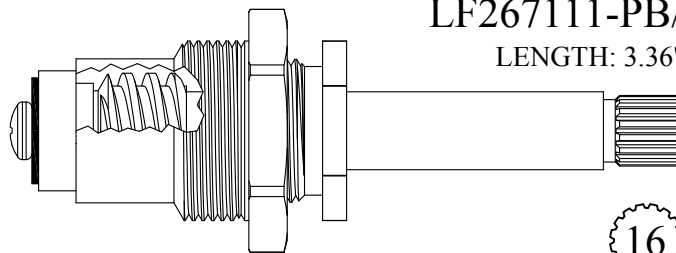

LENGTH: 3.36"

LF467111/ LF467112
LF267111/ LF267112 Stem Only
GASKET: 895330



Also available with polished brass stem

LF467611-PB/ LF467612-PB
LF267611-PB/ LF267612-PB Stem Only

Chrome Plated Stem

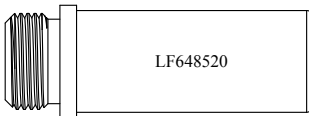

LF648520

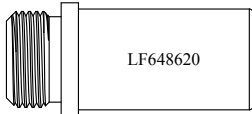

LF648620

SEAT USED: LF648520 or LF648620

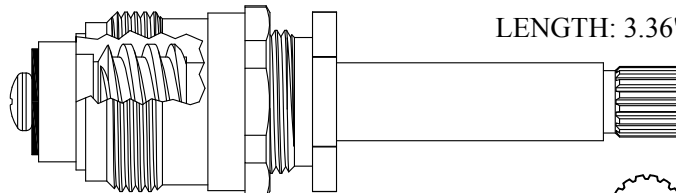

LENGTH: 3.36"

LF467611/ LF467612
LF267111/ LF267112 Stem Only
GASKET: 895120



FOR ELJER

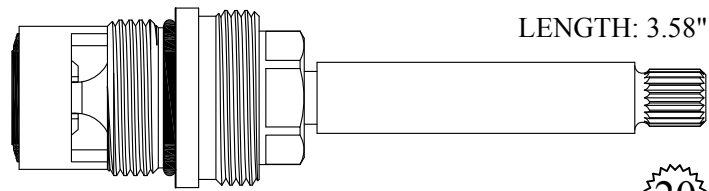

LENGTH: 3.58"

402911/ 402912

GASKET: 890170 O-RING INCLUDED
SEAL: 898510
DISC SET: 151380-PKG

20
3-20



SEAT USED: LF648320

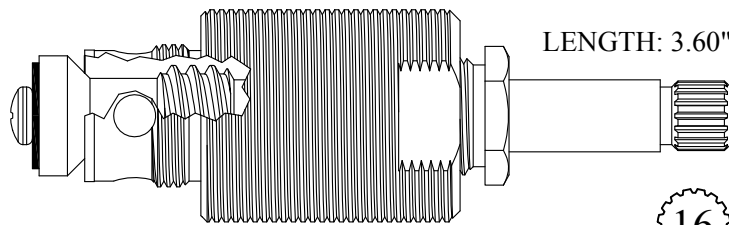

LENGTH: 3.60"

430131

GASKET: 895100

16
3-15



SEAT USED: LF647690

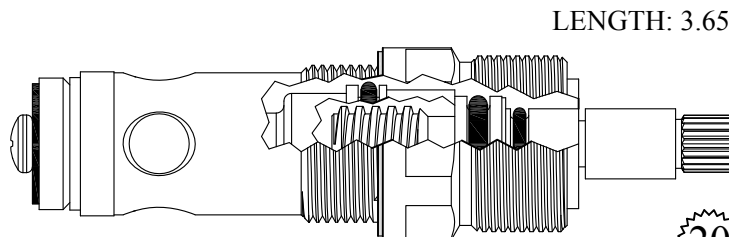

LENGTH: 3.65"

430192

GASKET: 895160 INCLUDED

20
3-20



SEAT USED: LF647690

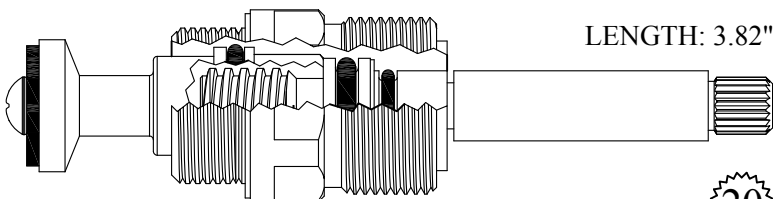

LENGTH: 3.82"

403232

GASKET: 895160 INCLUDED

20
3-20

FOR ELJER



SEAT USED: LF648160

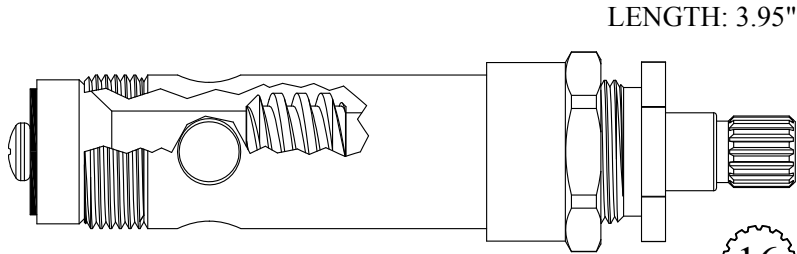

LENGTH: 3.95"

430431
230431 Stem Only
 GASKET: 895150

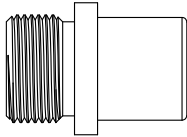

SEAT USED: LF649640

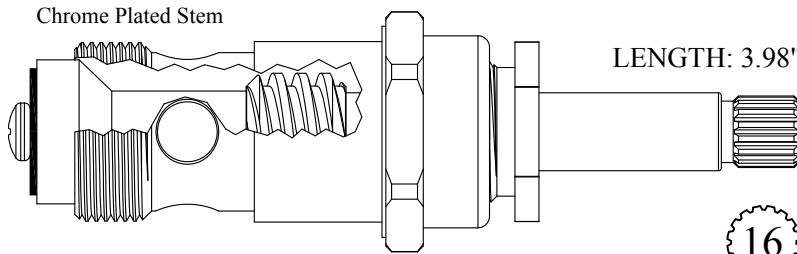

Chrome Plated Stem

LENGTH: 3.98"

430251
230251 Stem Only
 GASKET: 895320



Also available with polished brass stem
404001-PB/ 404002-PB
204001-PB/ 204002-PB Stem Only

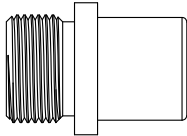

SEAT USED: LF649640

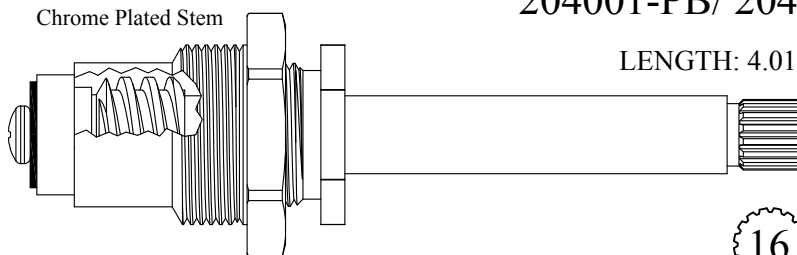

Chrome Plated Stem

LENGTH: 4.01"

404001/ 404002
204001/ 204002 Stem Only
 GASKET: 895330

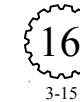

Also available with polished brass stem
404021-PB/ 404022-PB
204001-PB/ 204002-PB Stem Only



SEAT USED: LF648620

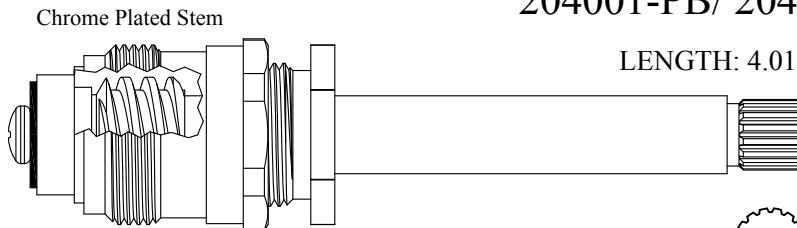

Chrome Plated Stem

LENGTH: 4.01"

404021/ 404022
204001/ 204002 Stem Only
 GASKET: 895120



FOR ELJER

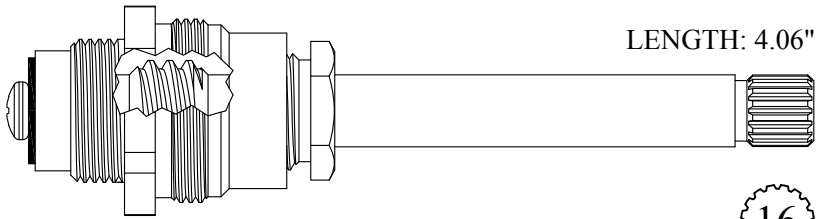

404211
204221 Stem Only
 GASKET: 895100

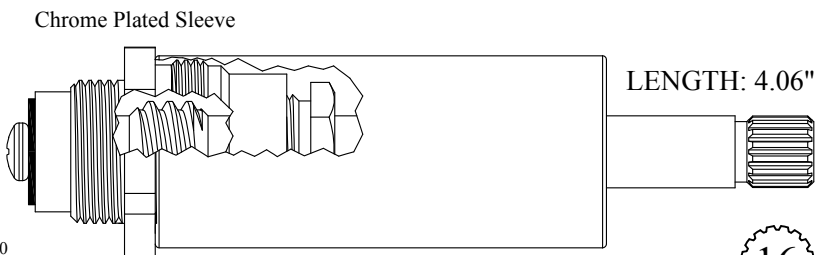
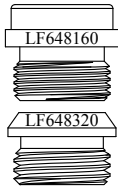

404221 / 404222
204221 / 204222 Stem Only
 GASKET: 895100

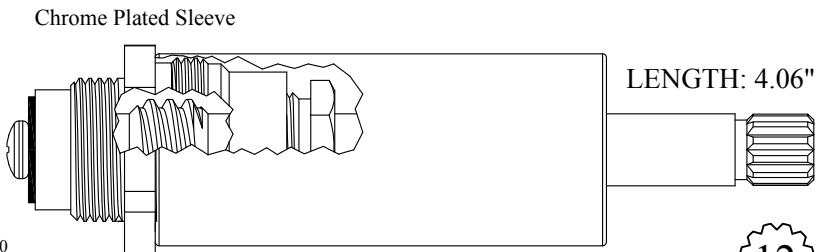
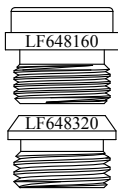

404241 / 404242
204241 / 204242 Stem Only
 GASKET: 895100

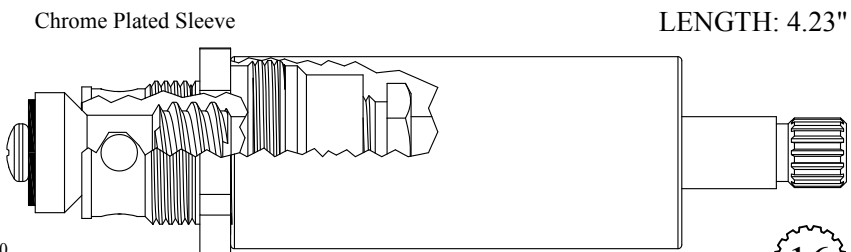
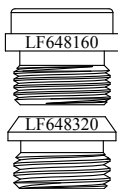

430221
230221 Stem Only
 GASKET: 895100



FOR ELJER

Chrome Plated Sleeve LENGTH: 4.23"

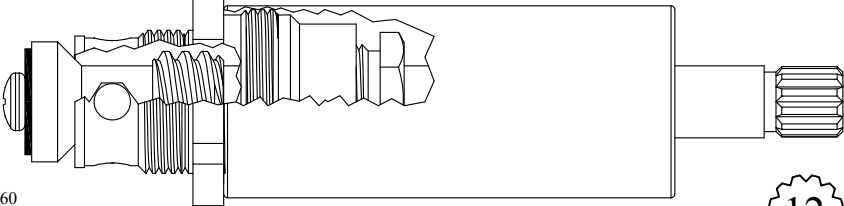

SEAT USED: LF648160 or LF648320

LF648160
LF648320

430341
230341 Stem Only
GASKET: 895100

12
1-2

SEAT USED: LF647690

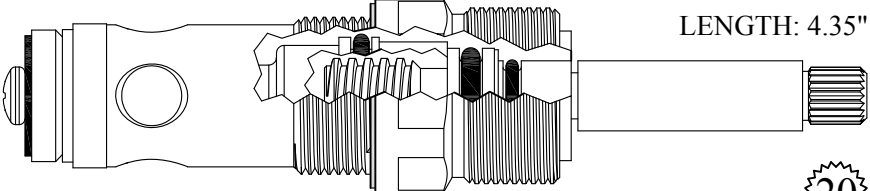

LENGTH: 4.35"

430552
GASKET INCLUDED: 895160

20
3-20

Chrome Plated Stem

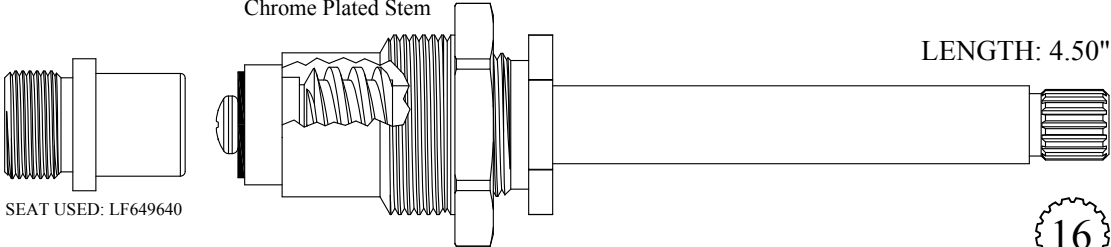

SEAT USED: LF649640

LENGTH: 4.50"

411211/ 411212
211211/ 211212 Stem Only
GASKET: 895330

16
3-15

Chrome Plated Stem

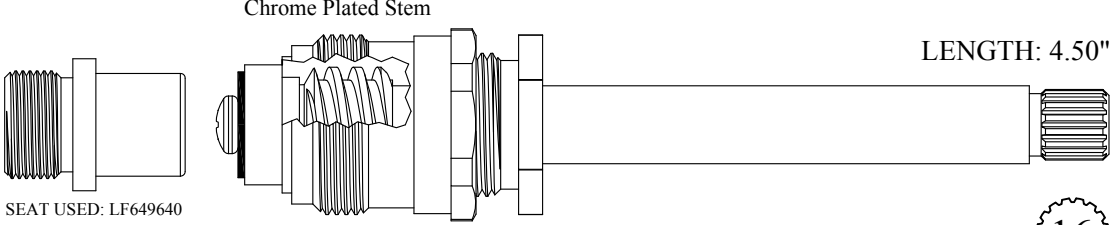

SEAT USED: LF649640

LENGTH: 4.50"

411231/ 411232
211211/ 211212 Stem Only
GASKET: 895120

16
3-15

FOR ELJER

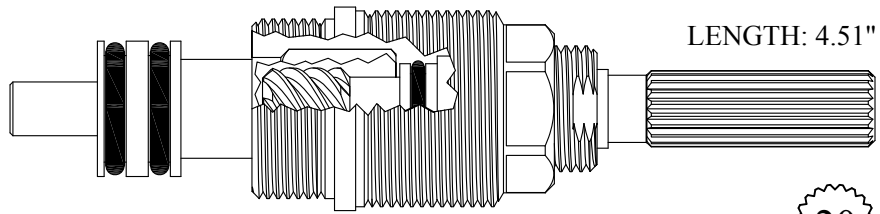

LENGTH: 4.51"

432071

GASKET: 895300

20
3-24



SEAT USED: LF648320
or LF648160



LENGTH: 4.55"

407831/ 407832

207801/ 207802 Stem Only

GASKET: 895100

16
3-15

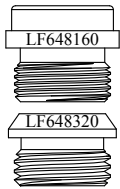

SEAT USED: LF648320
or LF648160

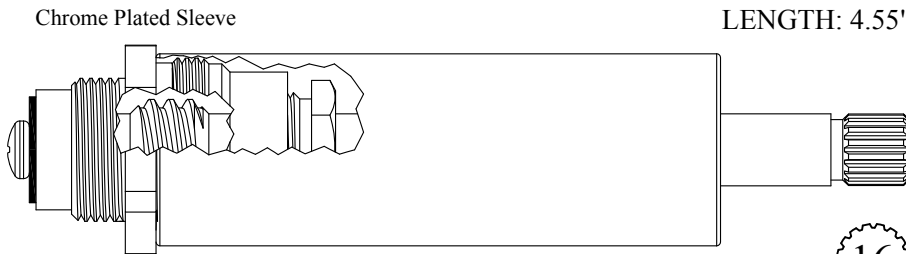

Chrome Plated Sleeve

LENGTH: 4.55"

407801/ 407802

207801/ 207802 Stem Only

GASKET: 895100

16
3-15

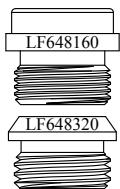

SEAT USED: LF648320
or LF648160

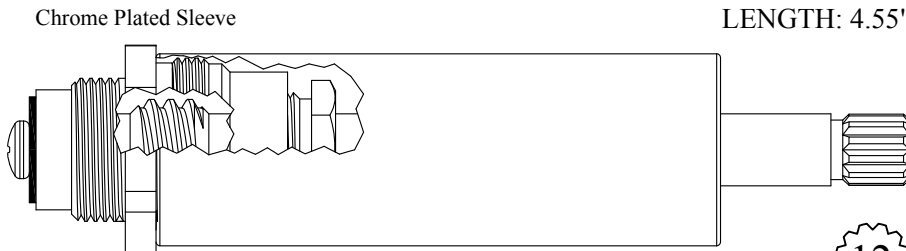

Chrome Plated Sleeve

LENGTH: 4.55"

407851/ 407852

207851/ 207852 Stem Only

GASKET: 895100

12
1-2

FOR ELJER

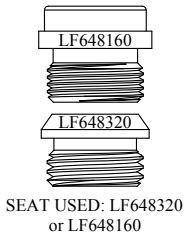

SEAT USED: LF648320
or LF648160

Chrome Plated Gland

LENGTH: 4.55"



407821/ 407822
207801/ 207802 Stem Only

GASKET: 895100

Plastic Plunger End

LENGTH 4.65"

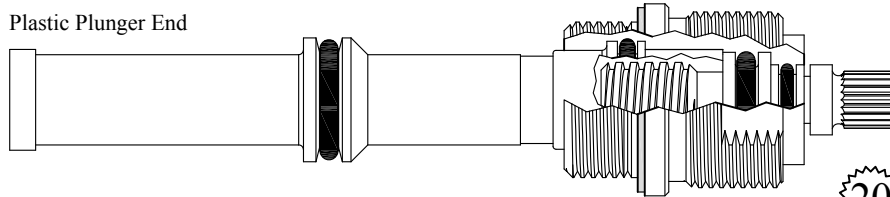

432822

GASKET: 895160 INCLUDED

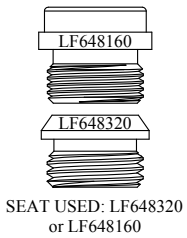

SEAT USED: LF648320
or LF648160

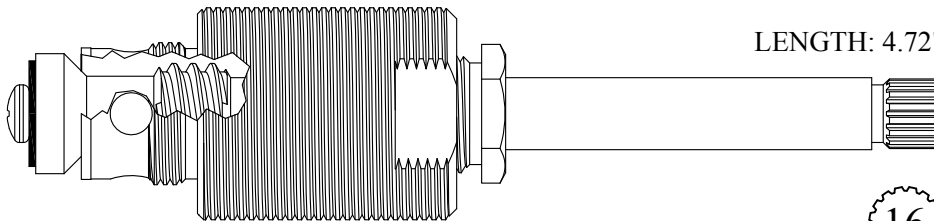

LENGTH: 4.72"



430321
231001 Stem Only

GASKET: 895100

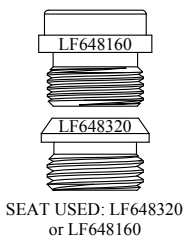

SEAT USED: LF648320
or LF648160

Chrome Plated Sleeve

LENGTH: 4.72"

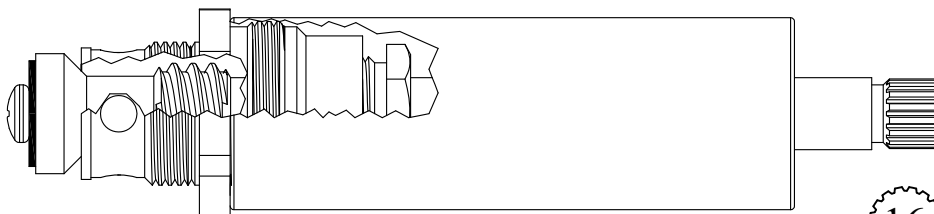

431001
231001 Stem Only

GASKET: 895100

FOR ELJER

Chrome Plated Gland

LENGTH: 4.72"



431021
231001 Stem Only
 GASKET: 895100

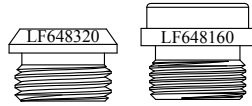

SEAT USED: LF648320 or LF648160

16
 3-15

Chrome Plated Stem

LENGTH: 4.79"

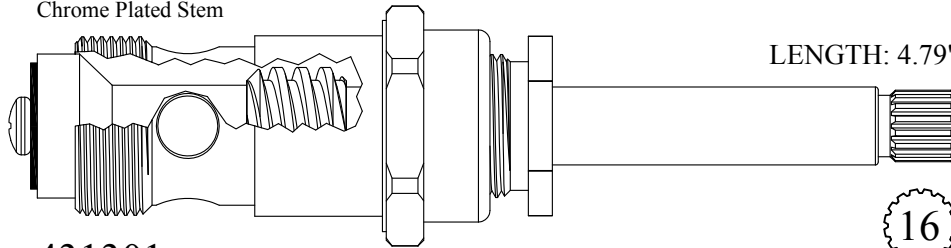

431301
231301 Stem Only
 GASKET: 895320

Also available with
 Polished Brass stem

431301-PB
231301-PB Stem Only

12
 1-2

Also available with 12pt broach

431351
231351 Stem Only

16
 3-15

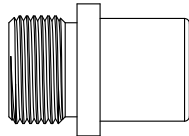

SEAT USED: LF649640

Chrome Plated Stem

LENGTH: 4.79"

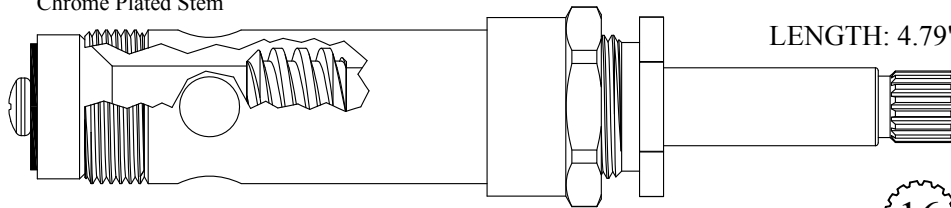

431321
231301 Stem Only
 GASKET: 895150

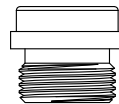

SEAT USED: LF648160

16
 3-15

Chrome Plated Stem

LENGTH: 5.00"

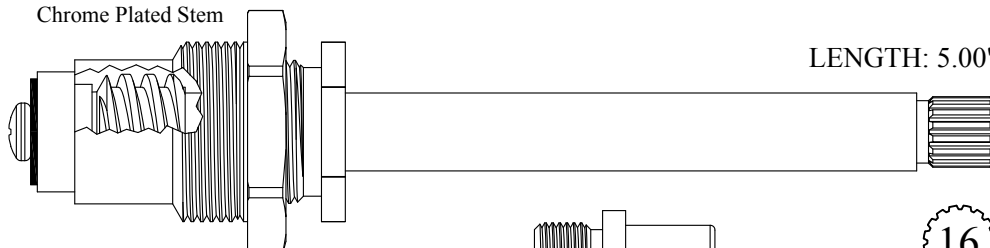

415511/ 415512
215511/ 215512 Stem Only
 GASKET: 895330

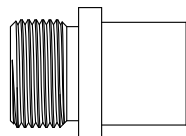

SEAT USED: LF649640

16
 3-15

FOR ELJER

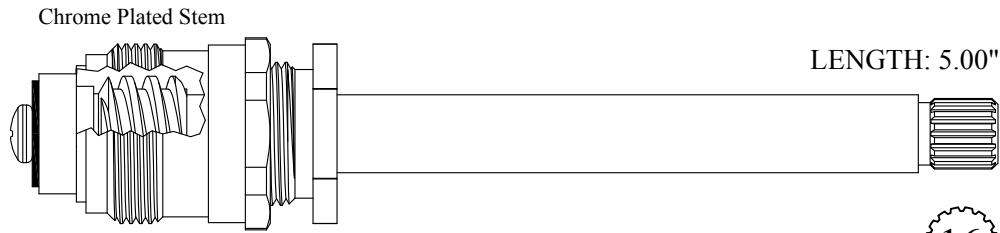

415531/ 415532
215511/ 215512 Stem Only
GASKET: 895120

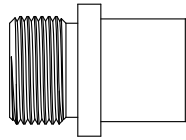

16
3-15

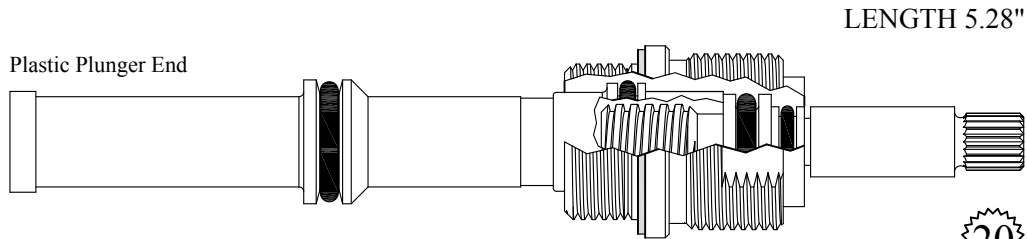

433432
GASKET: 895160 INCLUDED

20
3-20

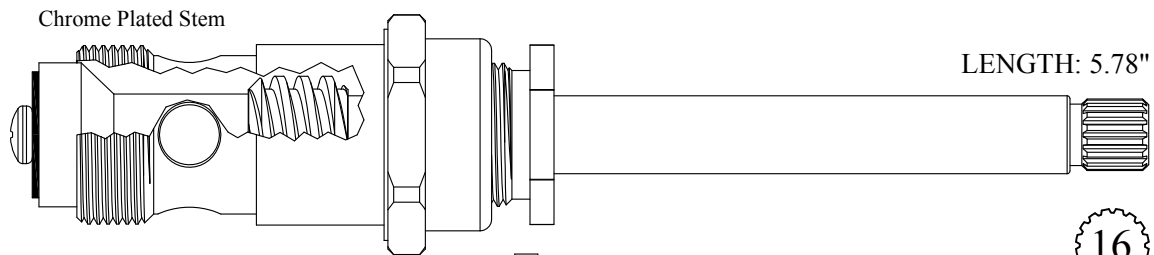

435811
235811 Stem Only
GASKET: 895350

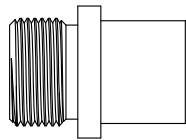

16
3-15

BARRY E.  ALTER SR. CO.

FOR ELK

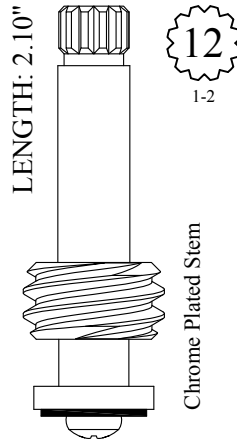

LF261101
LF261102

FOR EMCO

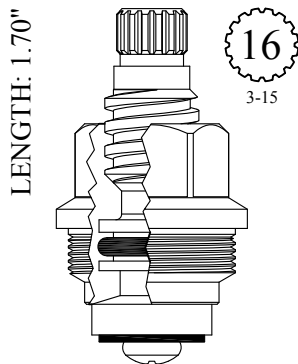

GASKET: 895180

LF452701
LF452702

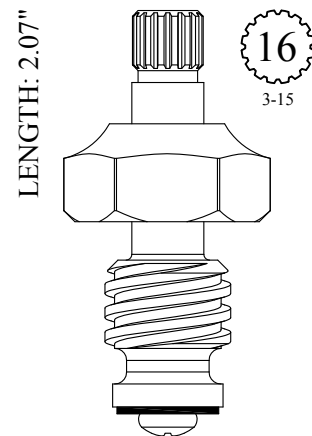

LF184561
LF184631 Stem Only

Send Your Orders To:

BARRY E.  SR. CO.

E-mail: orderdesk@barrywalter.com

Fax: 1.800.886.9831

Phone: 1.800.767.5552

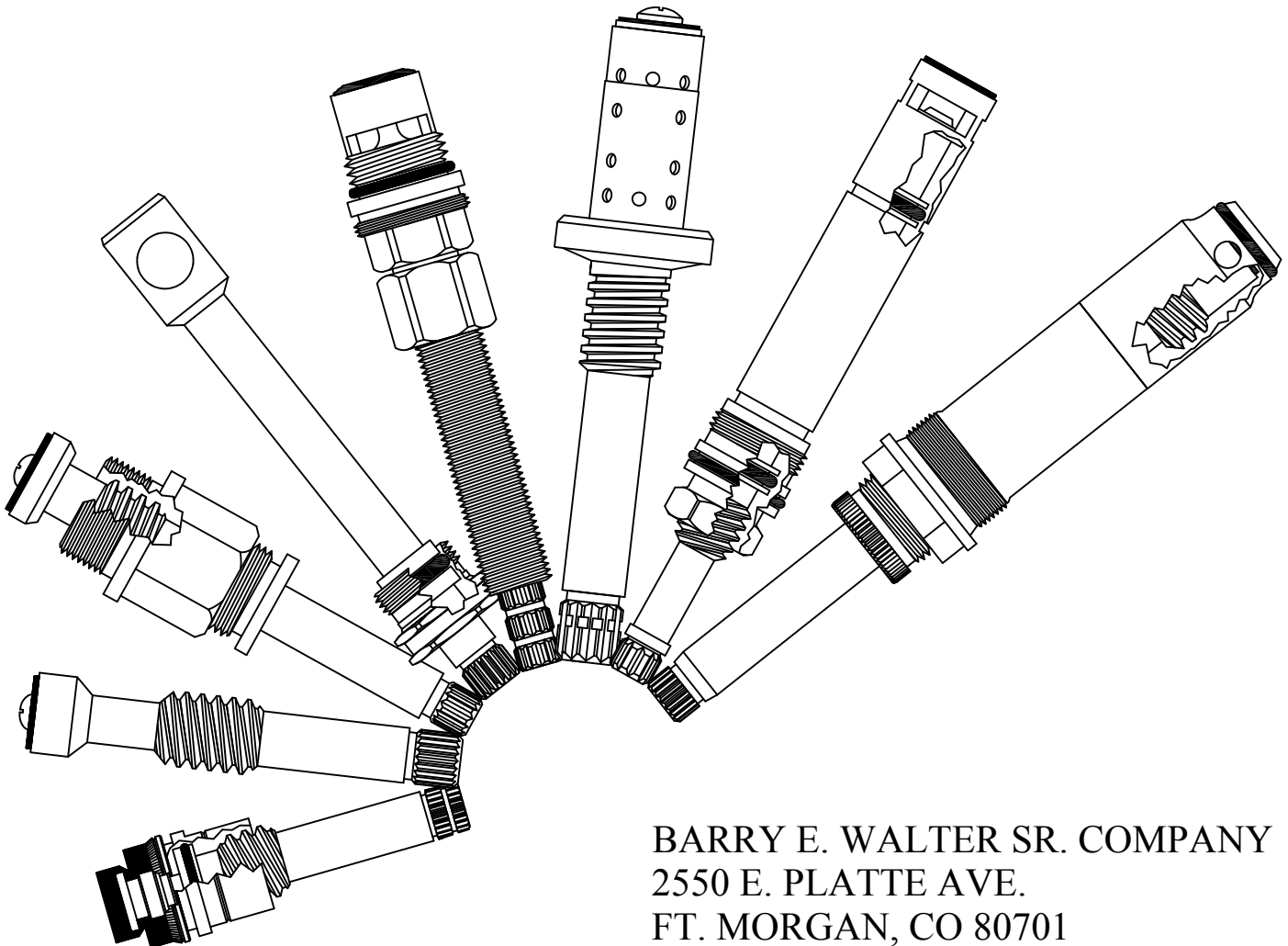

BARRY E. WALTER SR. COMPANY
2550 E. PLATTE AVE.
FT. MORGAN, CO 80701

*We are always adding
new parts. Check our
website for updates.*

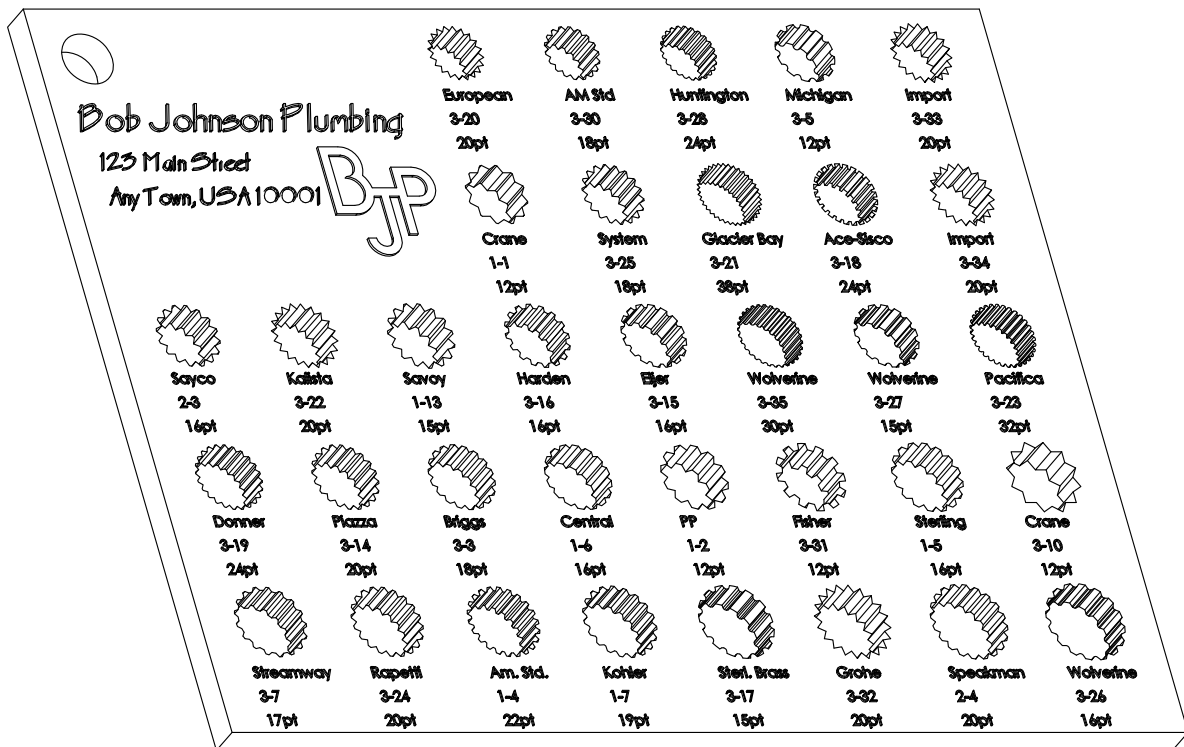

PART # 113740

BARRY E.  SR. CO.

FOR EMPIRE

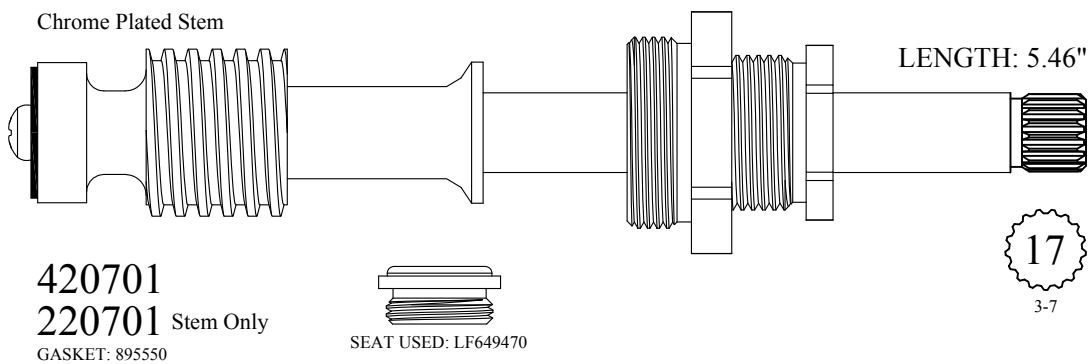
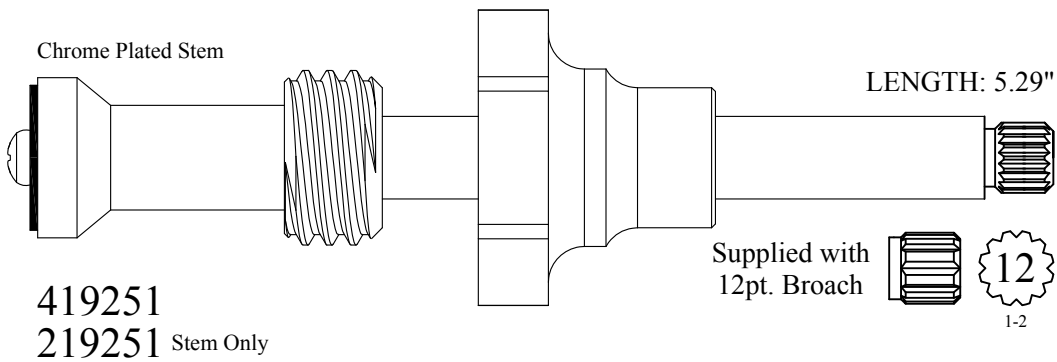
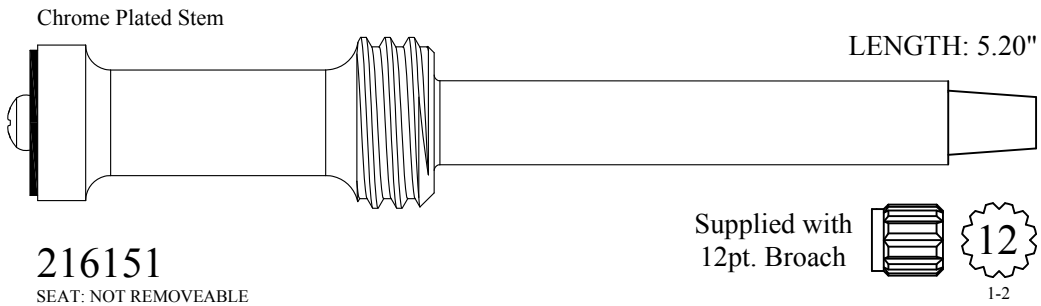
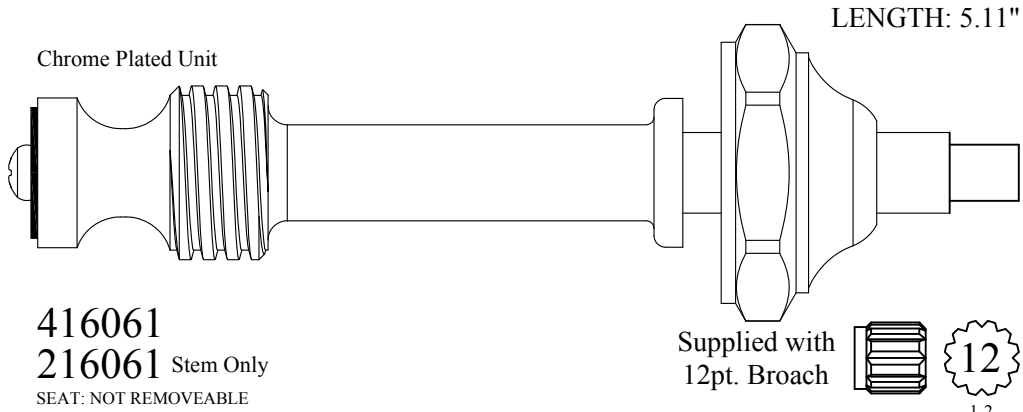

FOR EMPIRE

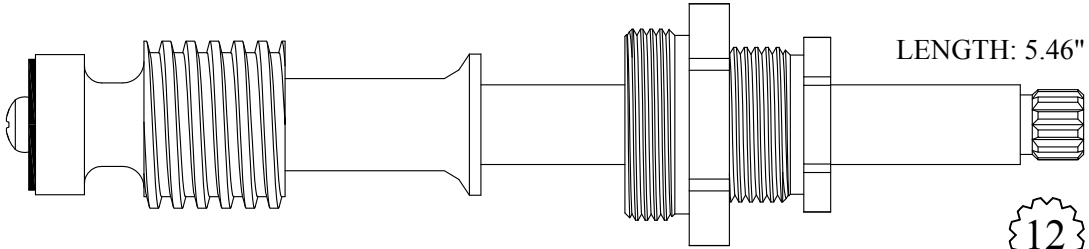

420751
220751 Stem Only
 GASKET: 895550

SEAT USED: LF649470

12
1-2

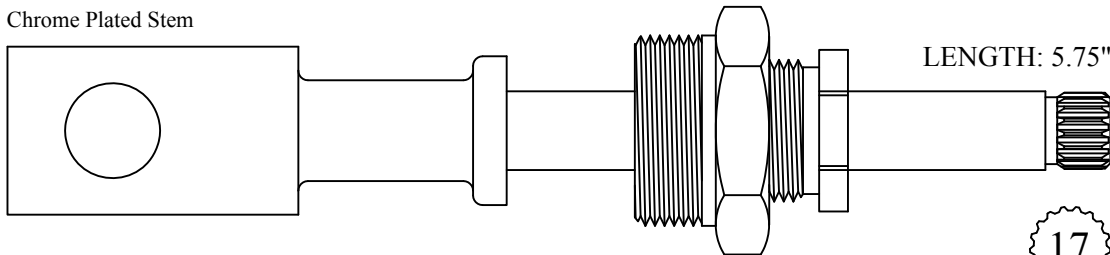

436220
236220 Stem Only
 GASKET: 895550

17
3-7

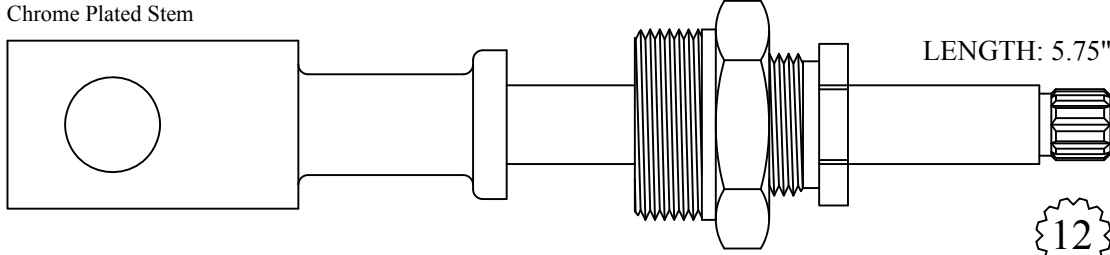

436270
236270 Stem Only
 GASKET: 895550

12
1-2

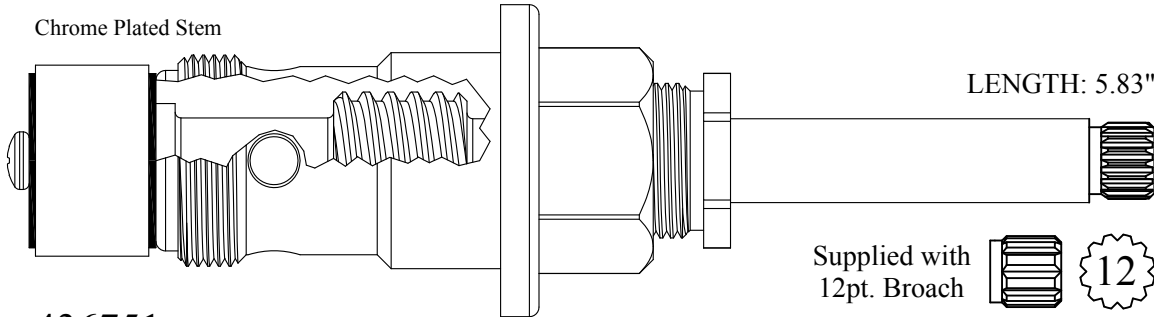

436751
236751 Stem Only
 GASKET: 895450

Supplied with
12pt. Broach

12
1-2

FOR ENTERPRISE

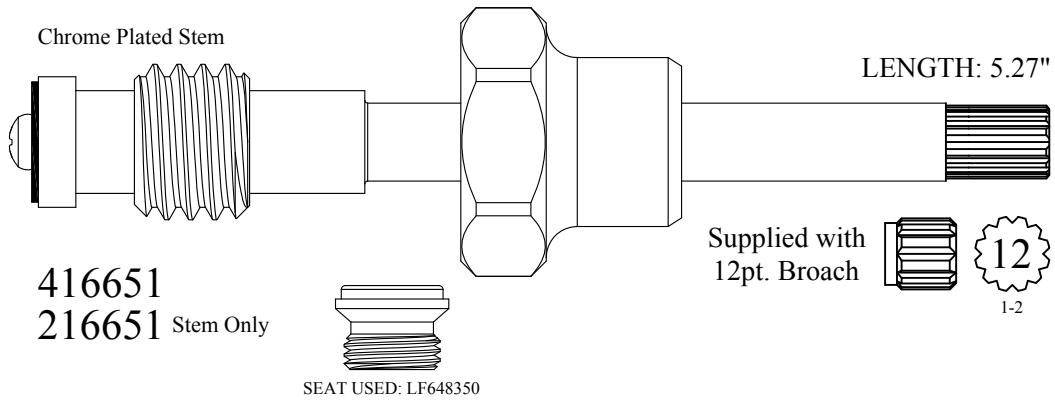

FOR FANTINI

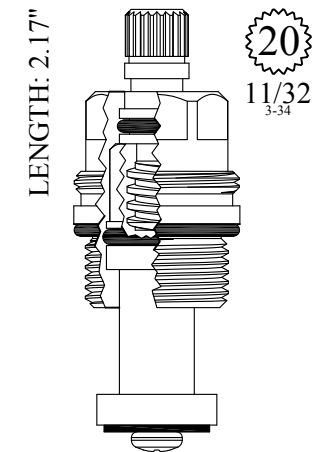

GASKET: 890170 O-RING INCLUDED

LF463332

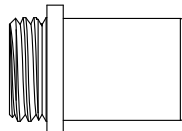

SEAT USED: LF647210

FOR FEDERAL HUBER

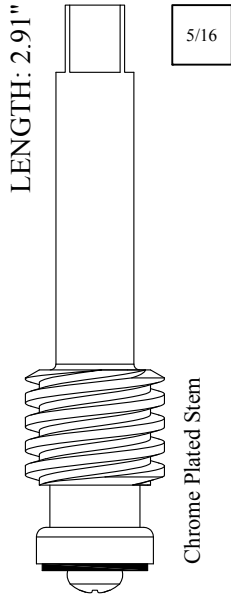

LF266021
LF266022

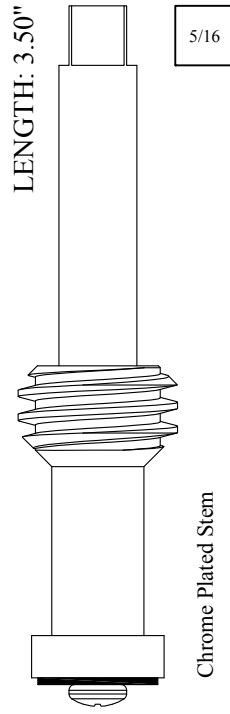

202801

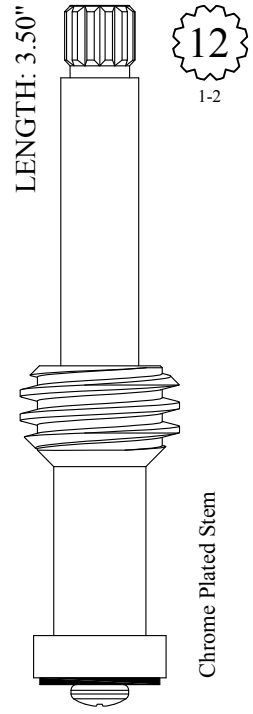

202851

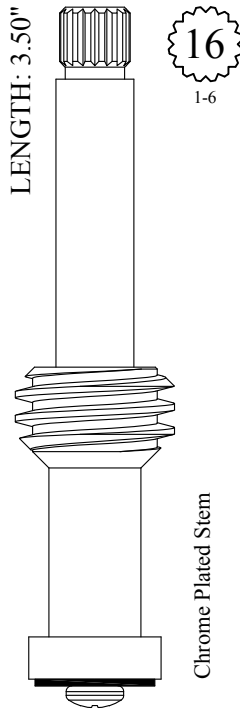

202871

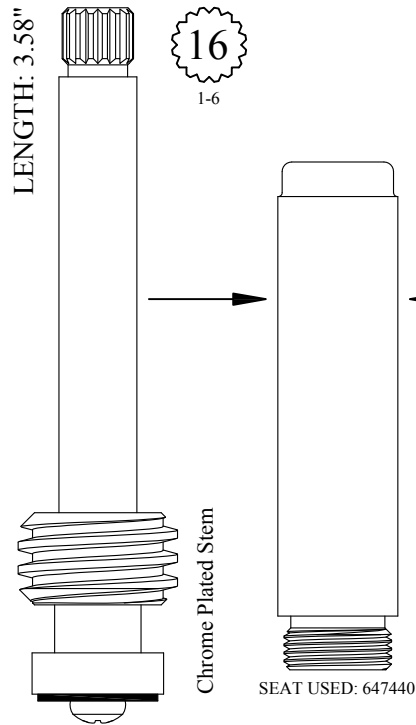

203101

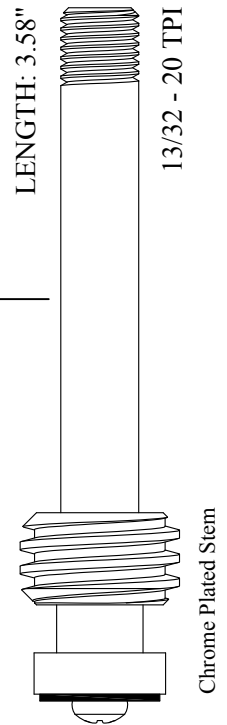

203111

FOR FEDERAL HUBER

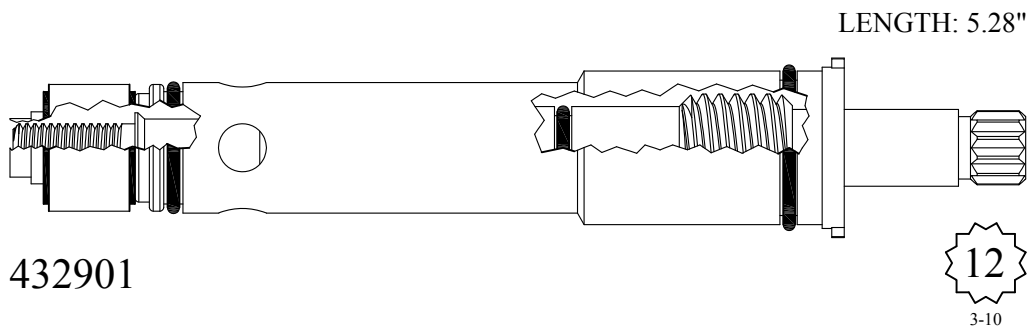
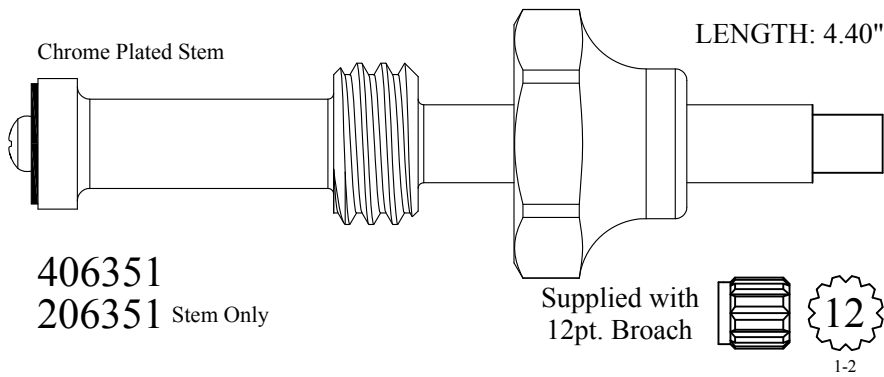
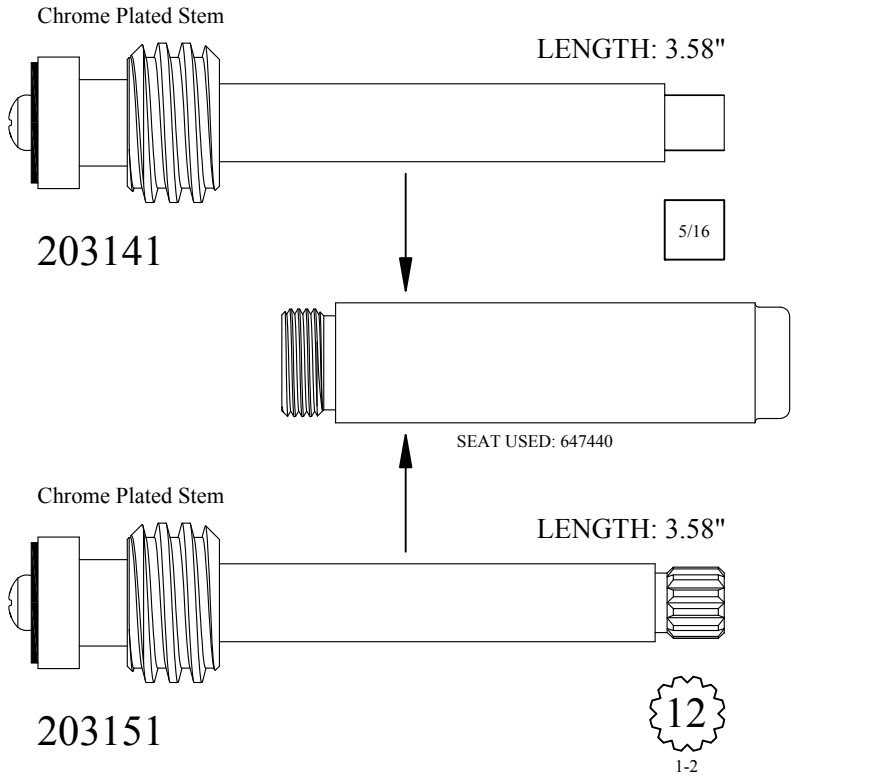

FOR FEDERAL HUBER

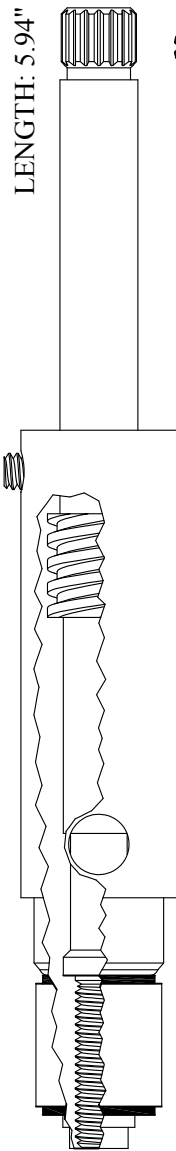

436441

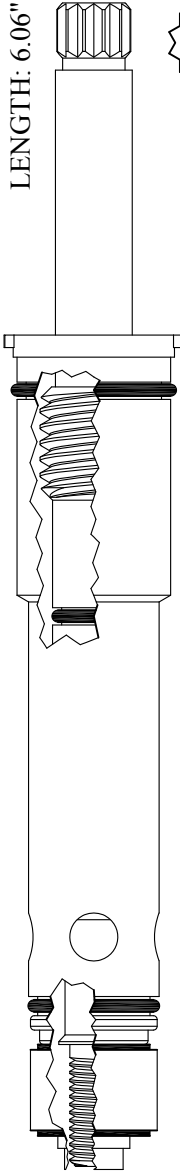

437011

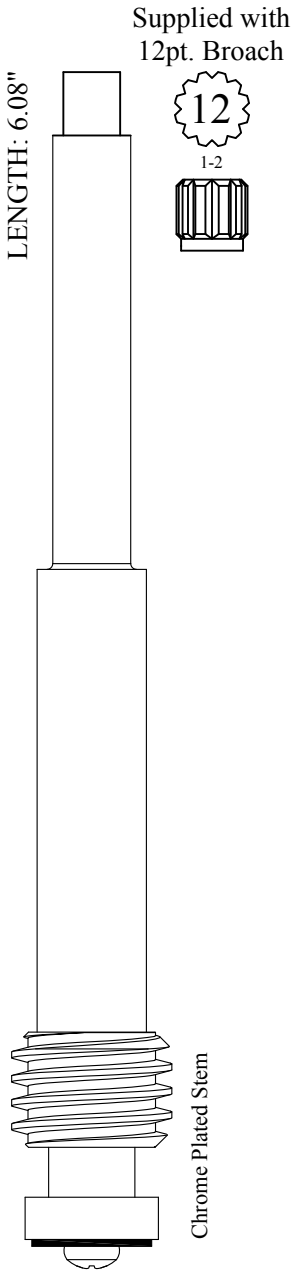

226631

FOR FEDERAL HUBER

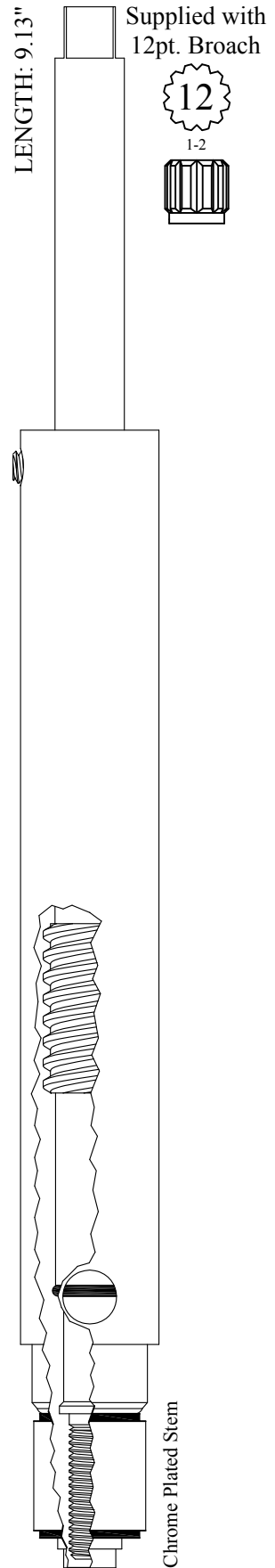
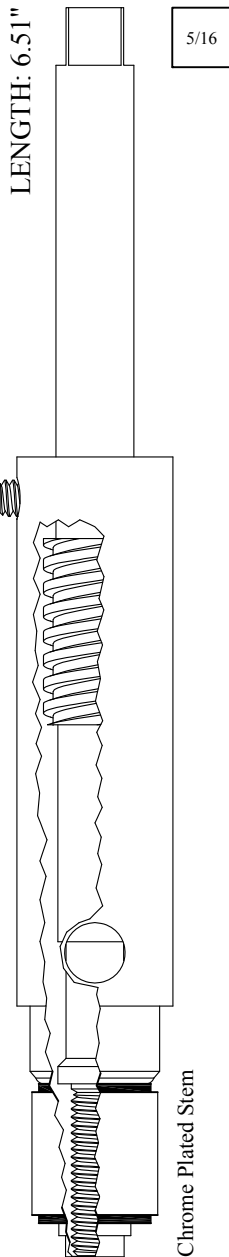

FOR FIAT

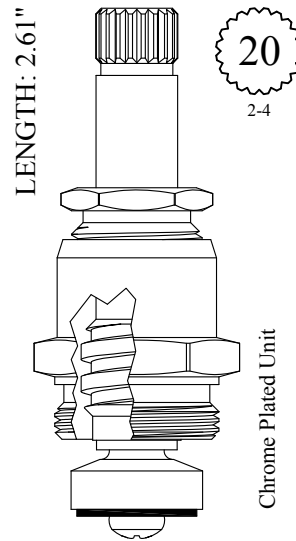

GASKET: 895400

LF464201

Send Your Orders To:

BARRY E.  SR. CO.

E-mail: orderdesk@barrywalter.com

Fax: 1.800.886.9831

Phone: 1.800.767.5552

FOR FISHER

Also available with handle ABRFI32601

LF462201-32601

LF462202-32601

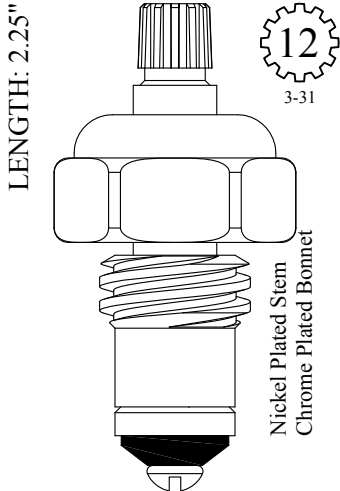

GASKET: INCLUDED

LF462201

LF462202

LF262201 Stem Only

LF262202 Stem Only

LENGTH: 2.29"

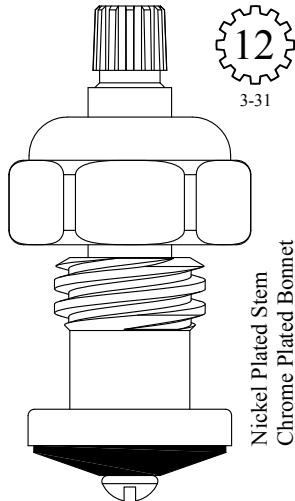

GASKET: INCLUDED

LF462221

LF462222

LF262221 Stem Only

LF262222 Stem Only

Also available with handle ABRFI32601

LF462031-32601

LF462032-32601

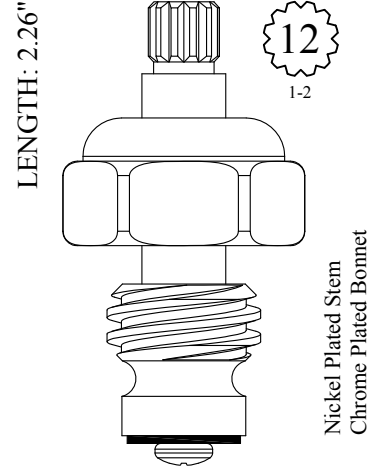

LF462031

LF462032

LF262031 Stem Only

LF262032 Stem Only

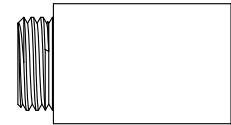

SEAT USED: LF649380

Also available with handle ABRFI32601

LF462211-32601

LF462212-32601

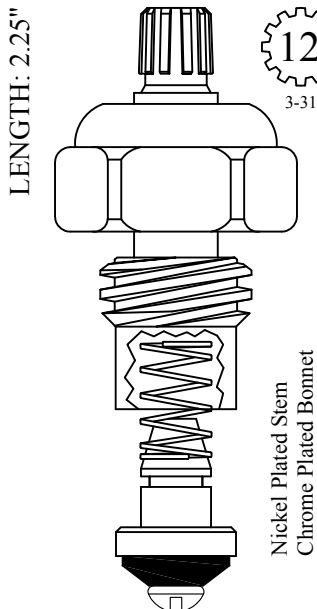

LF462211

LF462212

LF262211 Stem Only

LF262212 Stem Only

LENGTH: 2.25"

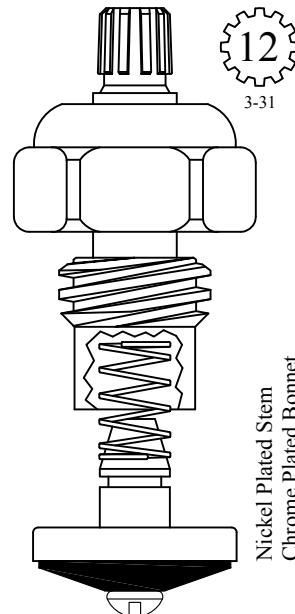

LF462231

LF462232

LF262231 Stem Only

LF262232 Stem Only

FOR FISHER

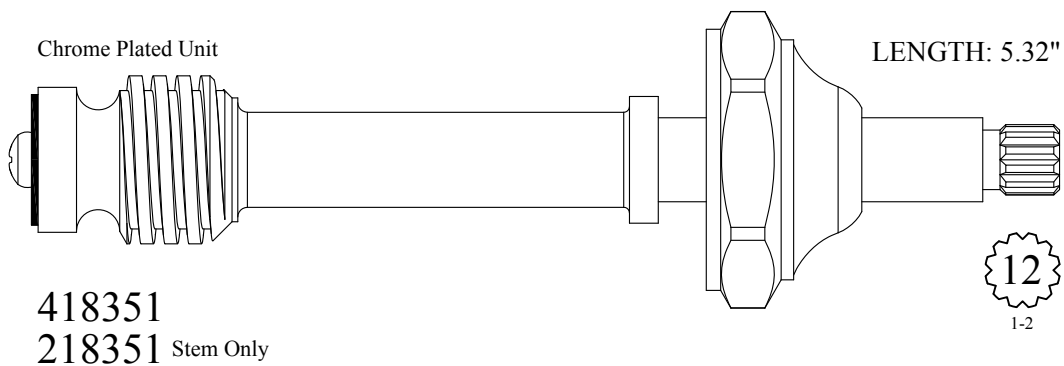
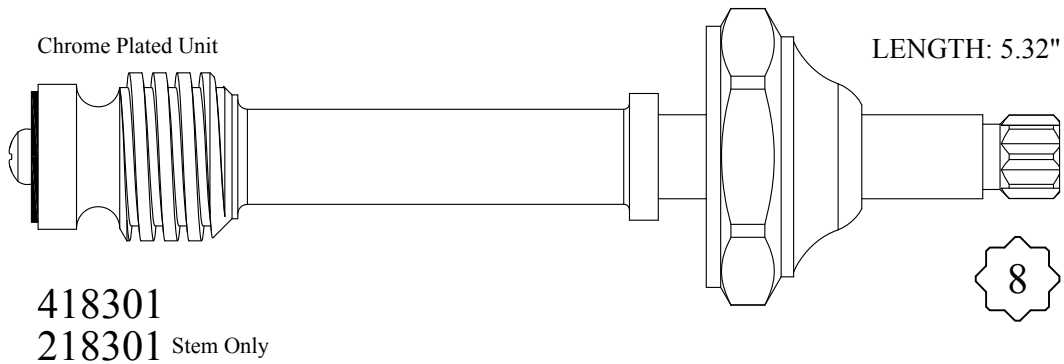

Send Your Orders To:

BARRY E.  ALTER  SR. CO.

E-mail: orderdesk@barrywalter.com

Fax: 1.800.886.9831

Phone: 1.800.767.5552

FOR FOREMOST

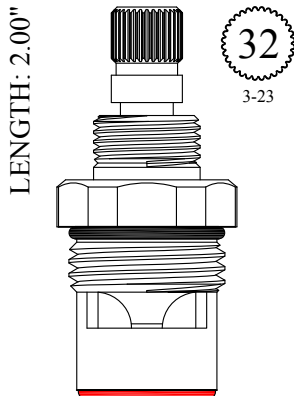

GASKET: 890170 O-RING INCLUDED
 SEAL: 898580-R/B
 DISC SET: 151380-PKG

LF459271
 LF459272

FOR FOREST

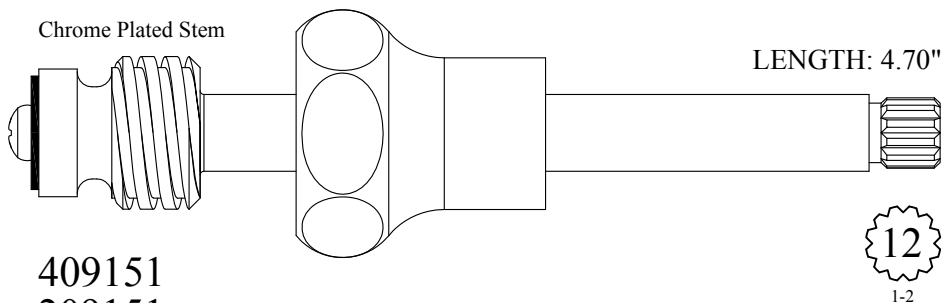

409151
 209151 Stem Only

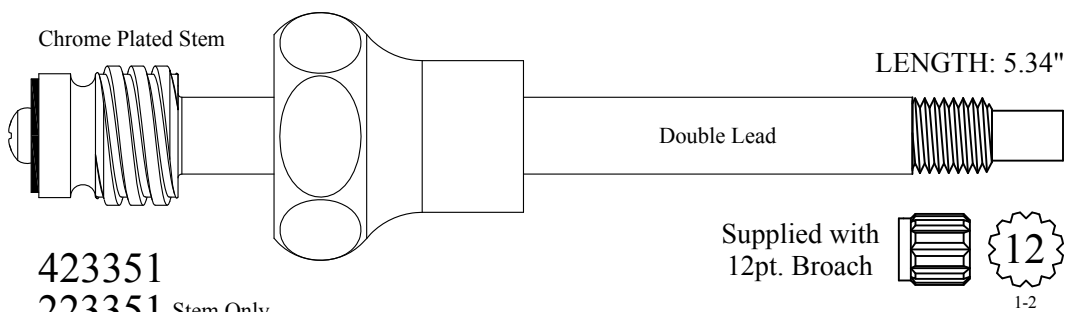

423351
 223351 Stem Only

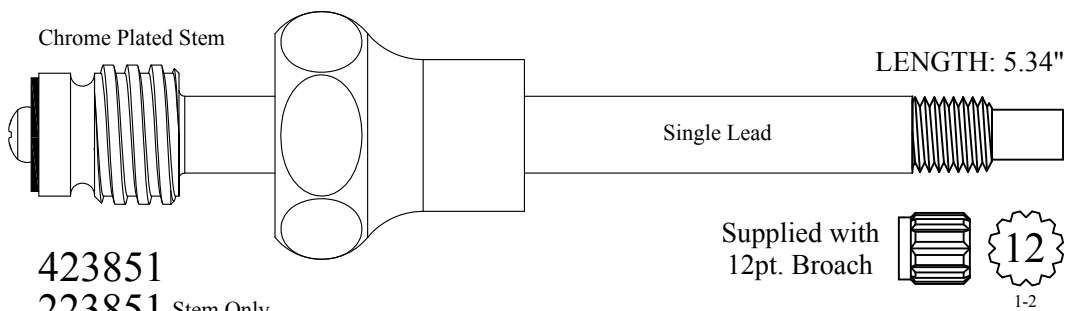

423851
 223851 Stem Only

FOR FRANKE

LENGTH: 2.03"

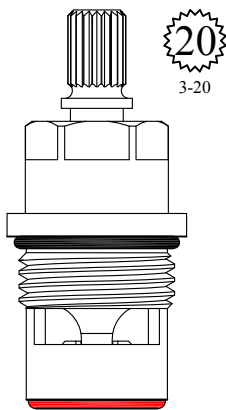

GASKET: 890170 O-RING INCLUDED
SEAL: 898570-R/B
DISC SET: 151380-PKG

LF458941
LF458942

LENGTH: 2.08"

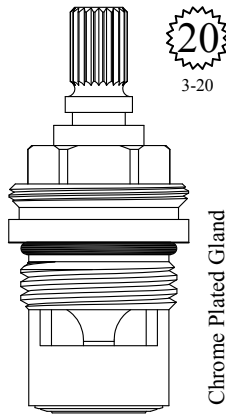

GASKET: 890170 O-RING INCLUDED
SEAL: 898510-W
DISC SET: 151380-PKG

LF459491
LF459492

LENGTH: 2.08"

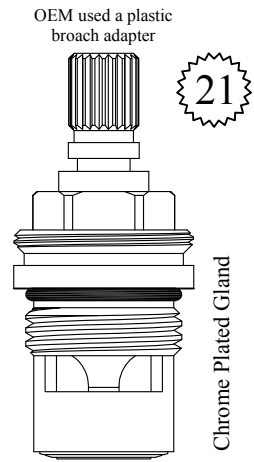

GASKET: 890170 O-RING INCLUDED
SEAL: 898510-W
DISC SET: 151380-PKG

LF459541
LF459542

Send Your Orders To:

BARRY E.  SR. CO.

E-mail: orderdesk@barrywalter.com

Fax: 1.800.886.9831

Phone: 1.800.767.5552

FOR GERBER

LENGTH: 1.19"

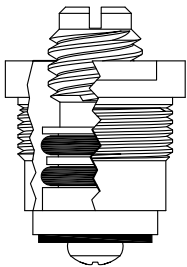

GASKET: 895150

400381

LENGTH: 1.45"

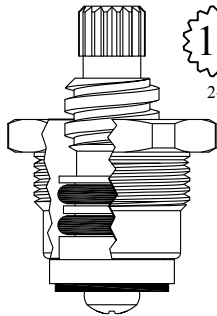

16
2-3

GASKET: 895150

LF451051
LF451052



SEAT USED: LF649150

LENGTH: 1.45"

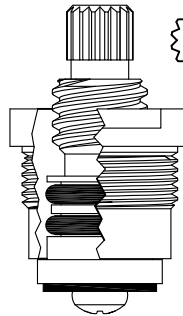

16
2-3

GASKET: 895150

LF451251
LF451252

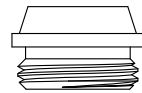

SEAT USED: LF649150

LENGTH: 1.65"

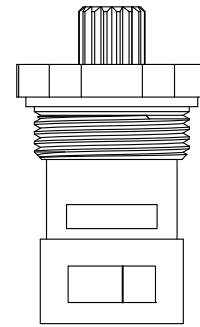

16
2-3

GASKET: 895150

LF453171
LF453172

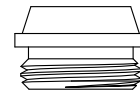

SEAT USED: LF649150

Plastic Stem

LENGTH: 1.75"

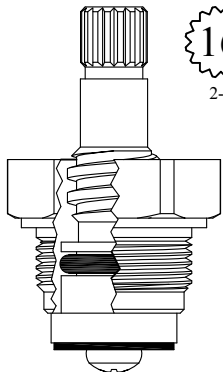

16
2-3

Nickel Plated Gland

GASKET: 895150

LF453111
LF453112

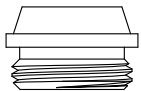

SEAT USED: LF649150

LENGTH: 1.76"

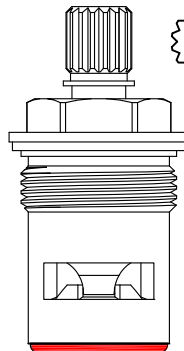

16
2-3

GASKET: 895140 INCLUDED
SEAL: 898570-R/B
DISC SET: 151380-PKG

LF455951
LF455952

LENGTH: 1.83"

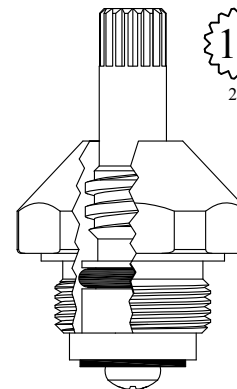

16
2-3

GASKET: 895150

LF454131
LF454132

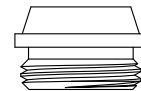

SEAT USED: LF649150

Nickel Plated Unit

FOR GERBER

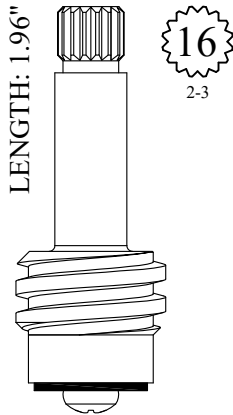

LF259021
LF259022

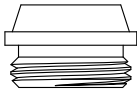

SEAT USED: LF649150

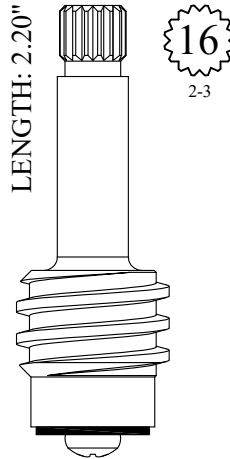

LF261111
LF261112

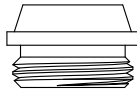

SEAT USED: LF649150

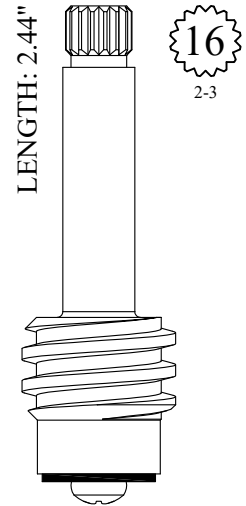

LF263121
LF263122

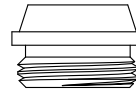

SEAT USED: LF649150

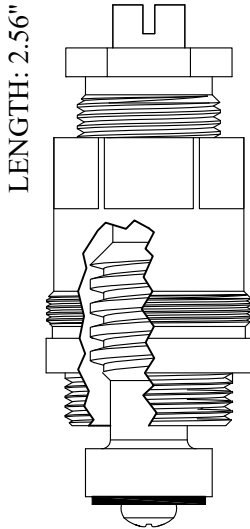

GASKET: 895400

401241
201241 Stem Only

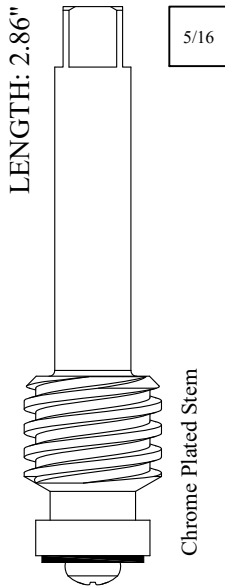

LF266211
LF266212

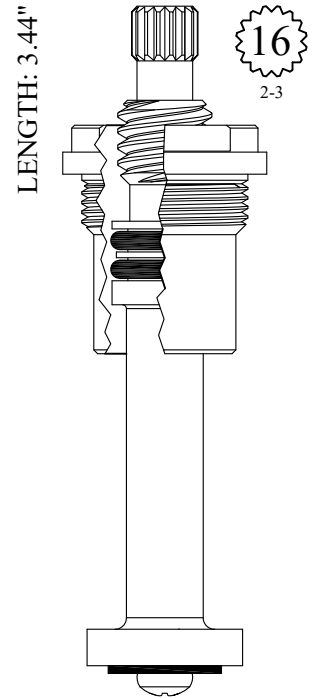

GASKET: 895180

402771
402772

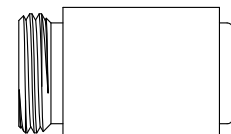

SEAT USED: LF649140

FOR GERBER

Old Style - Automatic

LENGTH: 3.59"

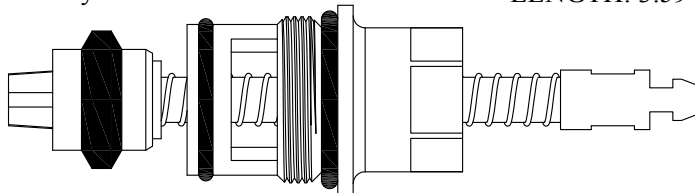

430790

GASKET: 894120 O-RING INCLUDED

Old Style - Automatic with Brass Link

LENGTH: 3.76"

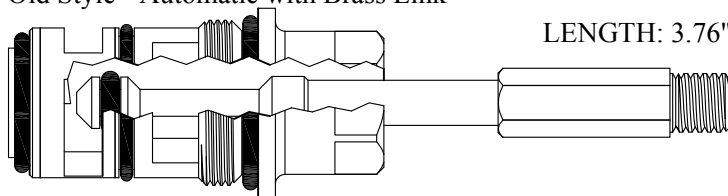

430850

GASKET: 894120 O-RING INCLUDED

New Style - Manual

LENGTH: 4.09"

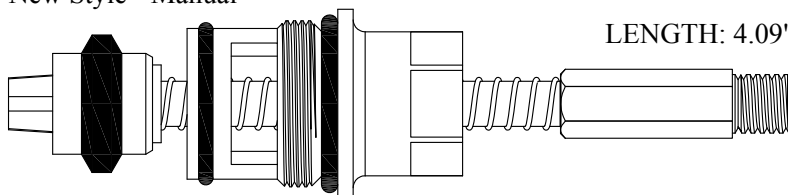

431130

GASKET: 894120 O-RING INCLUDED

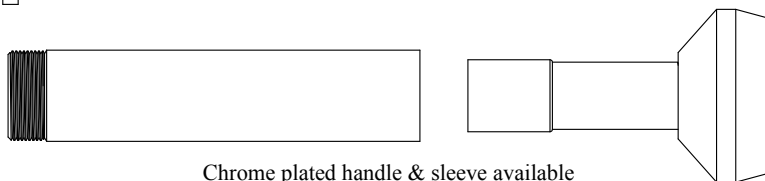

Chrome plated handle & sleeve available

128540

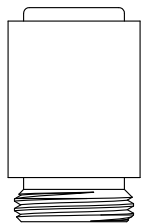

SEAT USED: LF649140

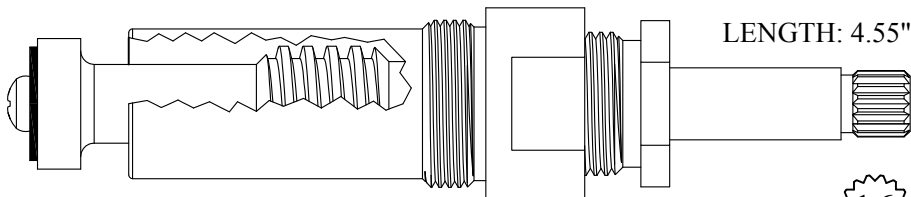

LENGTH: 4.55"

LF473041/ LF473042

LF273041/ LF273042 Stem Only

GASKET: 895180

16

2-3

FOR GERBER

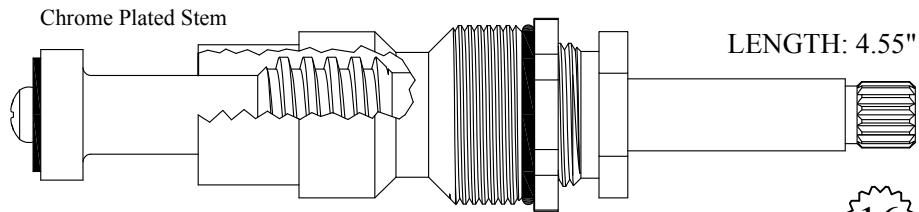
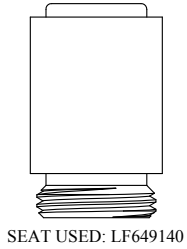

LF477021/ LF477022
LF277021/ LF277022 Stem Only
GASKET: 890190 O-RING INCLUDED

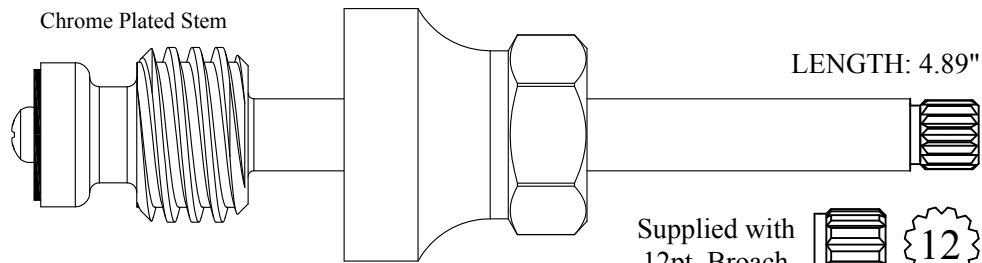

413951
213951 Stem Only

Supplied with
12pt. Broach

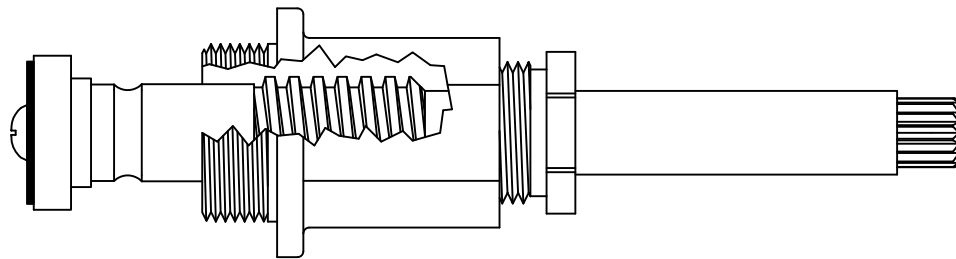

Old Style, Use 413601

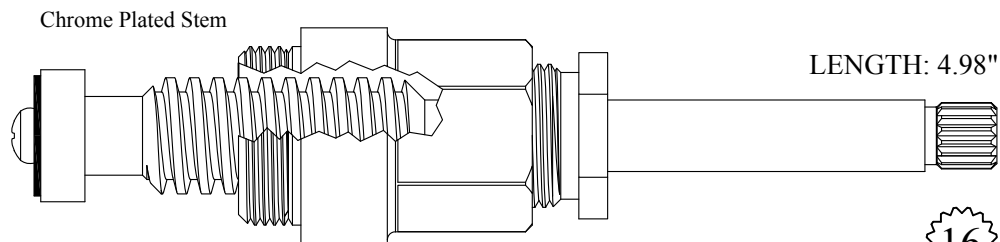
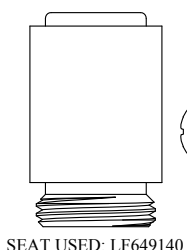

413601
213601 Stem Only
GASKET: 895370



FOR GERBER

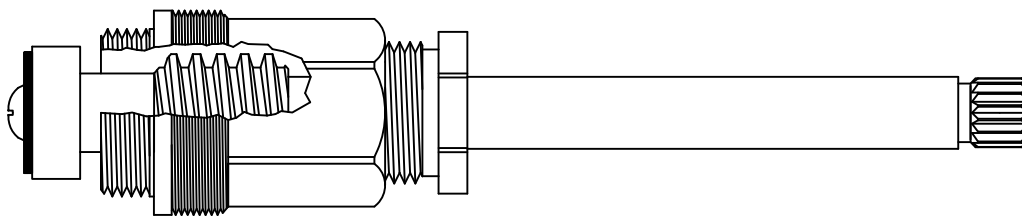

Old Style, Use 413301 or 413301-CP

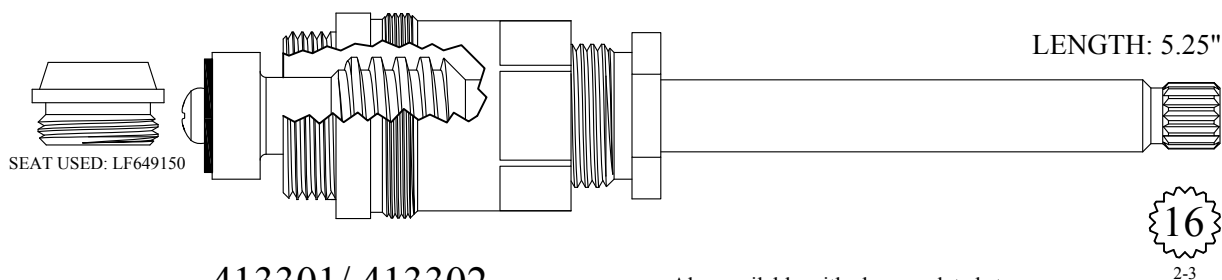

413301/ 413302
213301/ 213302 Stem Only
GASKET: 895400

Also available with chrome plated stem
413301-CP

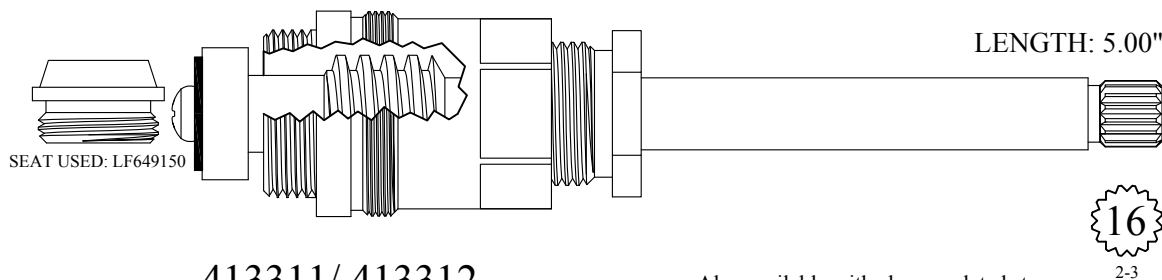

413311/ 413312
213311/ 213312 Stem Only
GASKET: 895400

Also available with chrome plated stem
413311-CP/ 413312-CP
213311-CP/ 213312-CP Stem Only

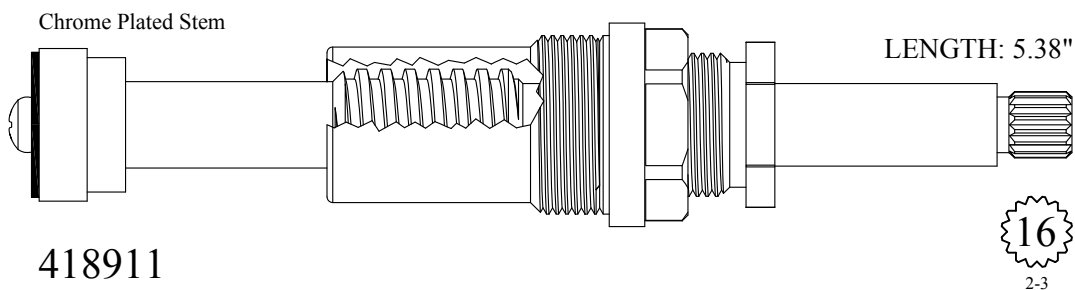

418911
218911 Stem Only
GASKET: 895300

FOR GERBER

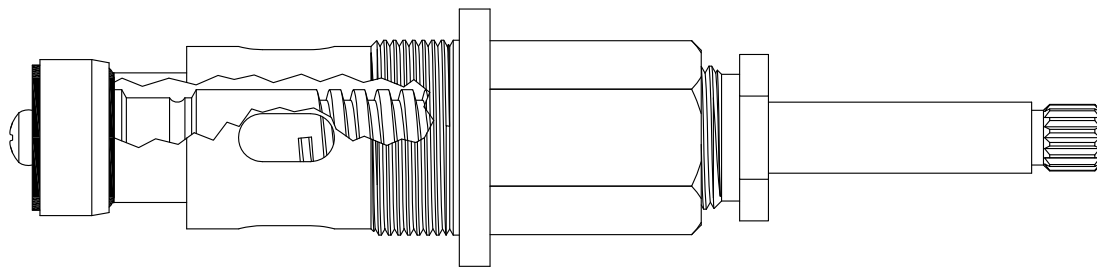
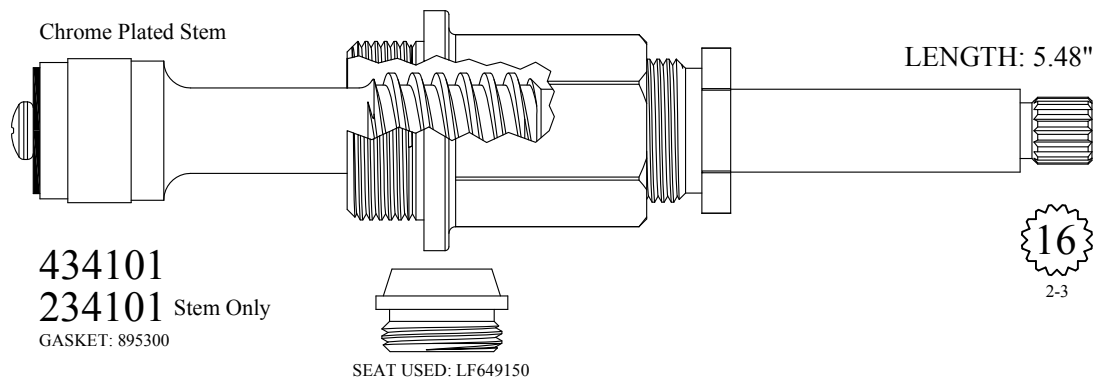
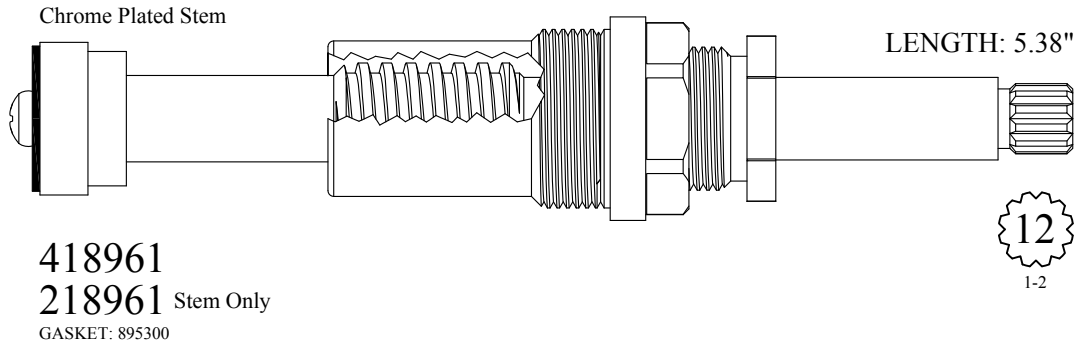

Old Style, Use 434401 or 236411 stem only

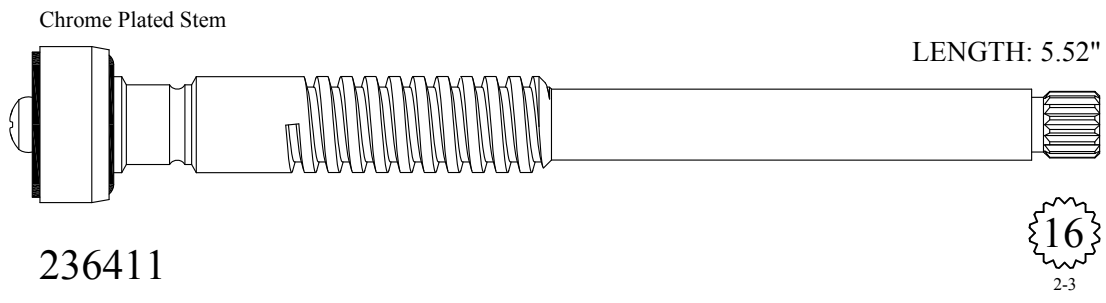

FOR GERBER

1/2 Turn Ceramic

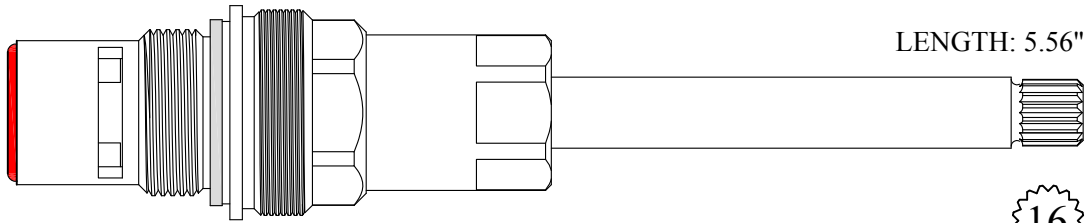

LENGTH: 5.56"

16
2-3

422411/ 422412

GASKET: 895180 INCLUDED
SEAL: 898570-R/B
DISC SET: 124290-PKG

Chrome Plated Stem

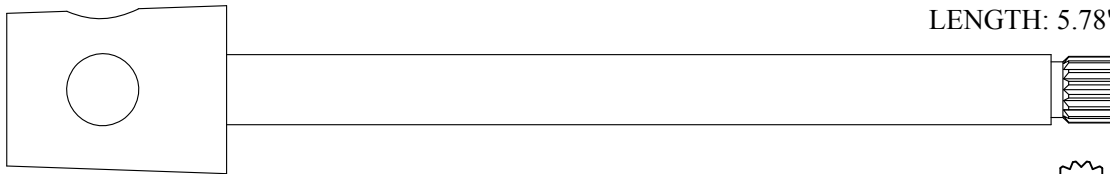

LENGTH: 5.78"

16
2-3

235900

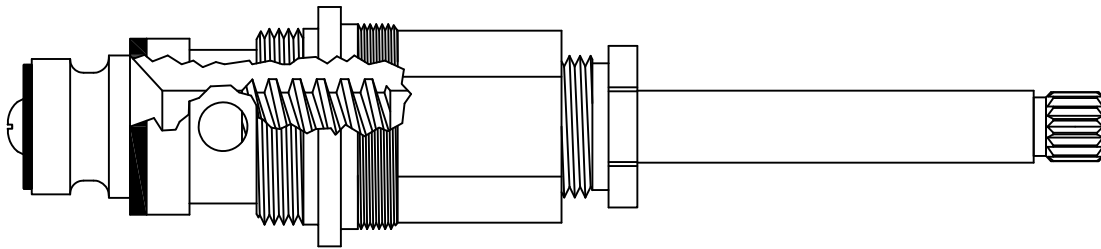

Old Style, Use 433401

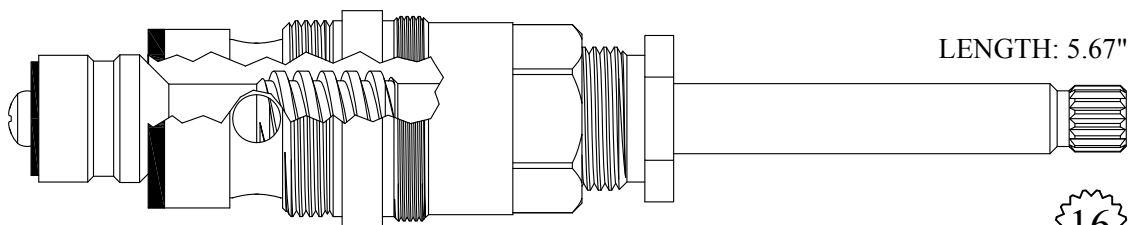

LENGTH: 5.67"

16
2-3

433401

233401 Stem Only

GASKET: 895560

Also available with chrome plated stem

433441

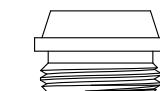

SEAT USED: LF649150

FOR GERBER

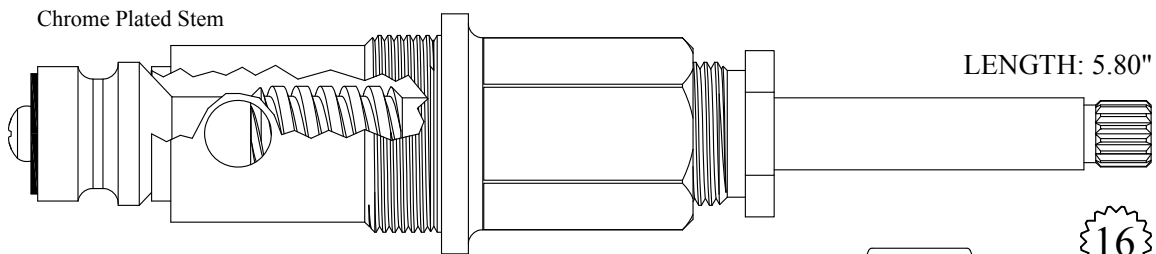

434401
234401 Stem Only
GASKET: 895560



16
2-3

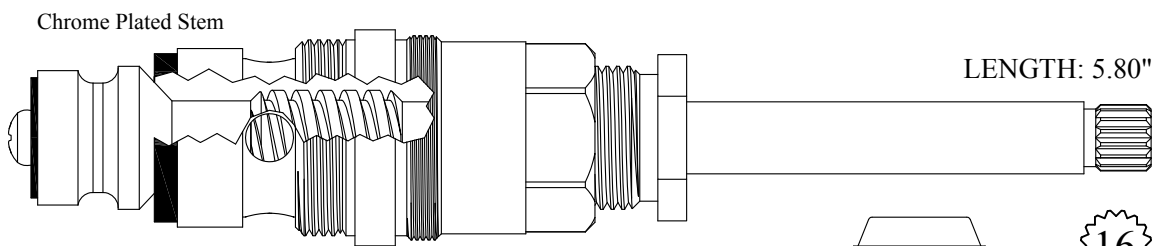

434411
234401 Stem Only
GASKET: 895560



16
2-3

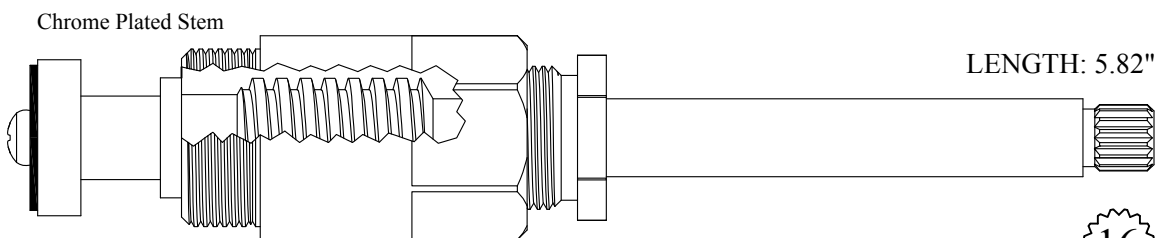

424411
224411 Stem Only
GASKET: 895400

16
2-3

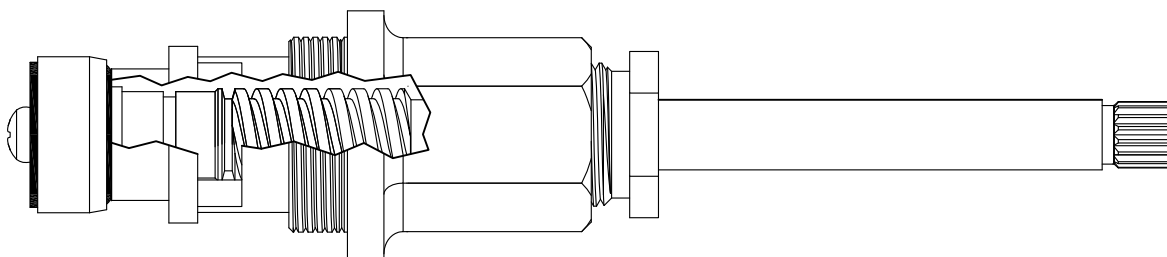

Old Style, Use 433441 or 236401 stem only



236401

16
2-3

FOR GLACIER BAY

LENGTH: 1.58"

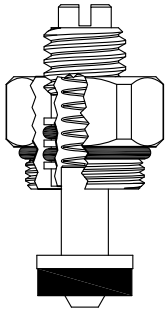

GASKET: 890150 O-RING INCLUDED

400231

LENGTH: 1.87"

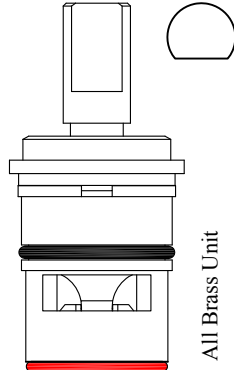

GASKET: 890170 O-RING INCLUDED
SEAL: 898580-R/B
DISC SET: 151380-PKG

LF456341
LF456342

LENGTH: 1.88"

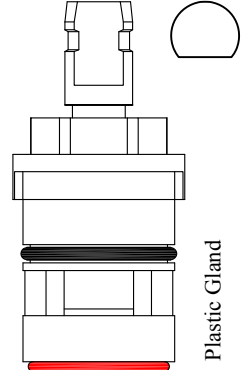

GASKET: 890170 O-RING INCLUDED
SEAL: 898580-R
DISC SET: 115520-PKG

LF456201
LF456202

LENGTH: 1.88"

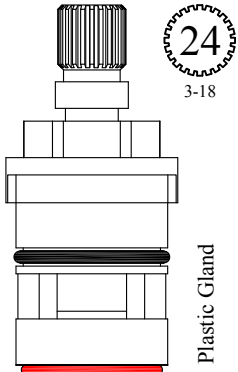

GASKET: 890170 O-RING INCLUDED
SEAL: 898580-R
DISC SET: 115520-PKG

LF456231
LF456232

LENGTH: 1.91"

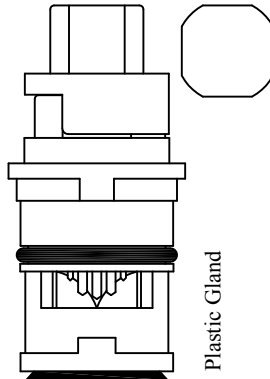

GASKET: 890170 O-RING INCLUDED
SEAL: 898510
DISC SET: 151380-PKG

LF456351
LF456352

LENGTH: 1.95"

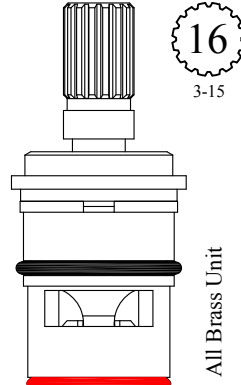

GASKET: 890170 O-RING INCLUDED
SEAL: 898580-R/B
DISC SET: 151380-PKG

LF457611
LF457612

LENGTH 2.00"

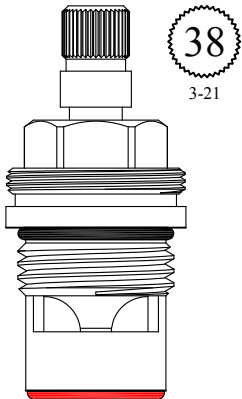

GASKET: 890170 O-RING INCLUDED
SEAL: 898570-R/B
DISC SET: 151380-PKG

LF458341
LF458342

LENGTH: 2.17"

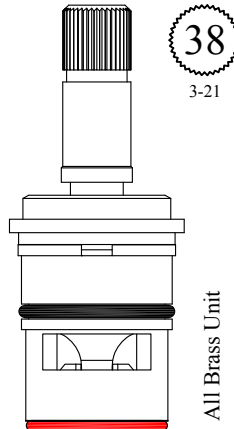

GASKET: 890170 O-RING INCLUDED
SEAL: 898580-R/B
DISC SET: 151380-PKG

LF460611
LF460612

LENGTH: 2.54"

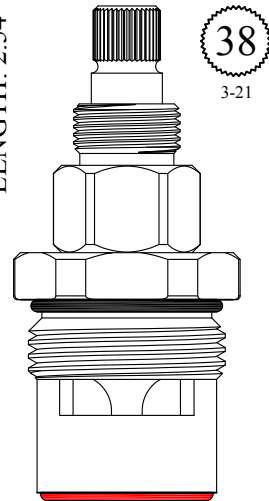

GASKET: 890200 O-RING INCLUDED
SEAL: 898610-R/B
DISC SET: 109850-PKG

401421
401422

FOR GLAUBER SALTER

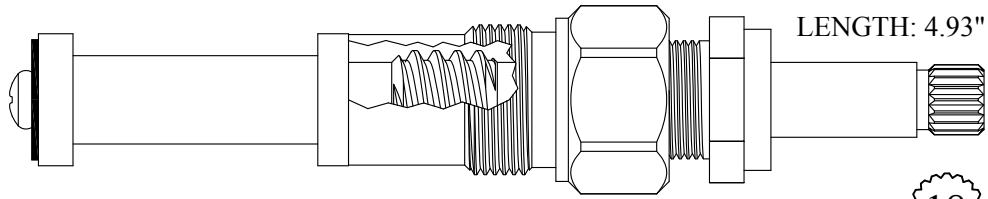

LENGTH: 4.93"

LF476501
LF276501 Stem Only

18
3-3

Chrome Plated Stem

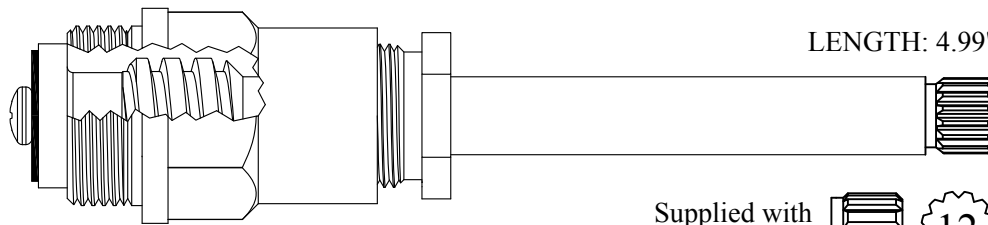

LENGTH: 4.99"

412451
212451 Stem Only
GASKET: 895370

Supplied with
12pt. Broach



12
1-2

Chrome Plated Stem

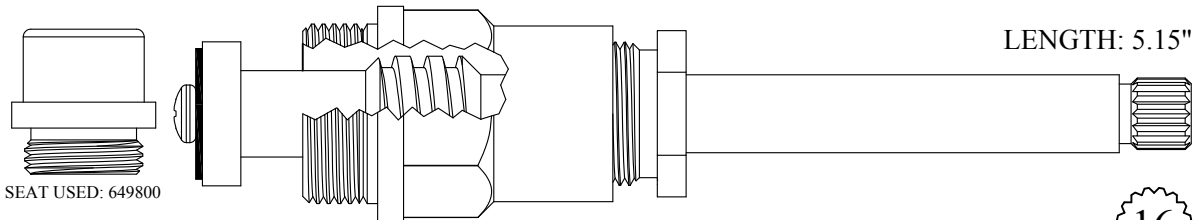

LENGTH: 5.15"

SEAT USED: 649800

415001
215001 Stem Only
GASKET: 895370

16
1-6

Chrome Plated Stem

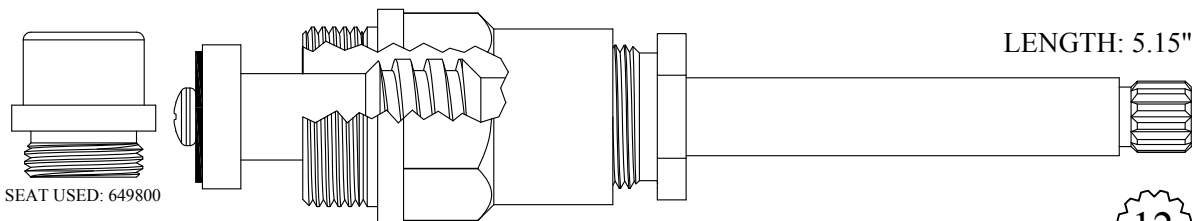

LENGTH: 5.15"

SEAT USED: 649800

415051
215051 Stem Only
GASKET: 895370

12
1-2

FOR GLAUBER SALTER

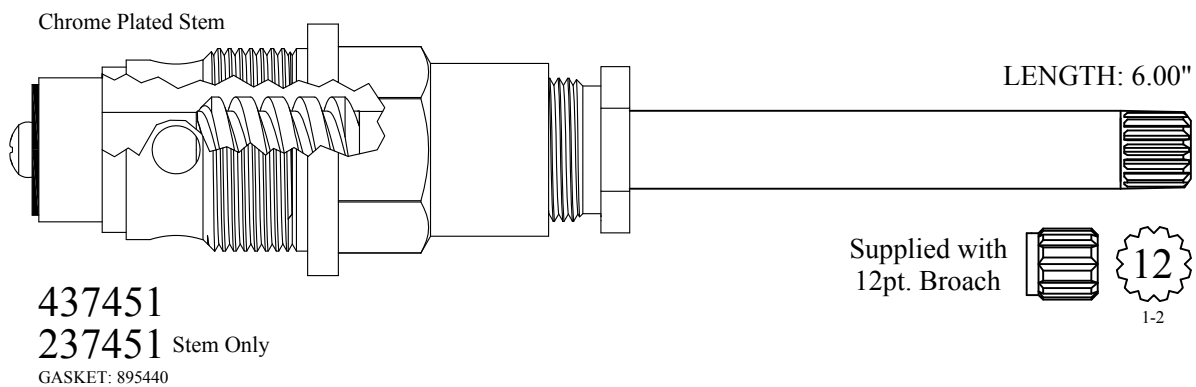
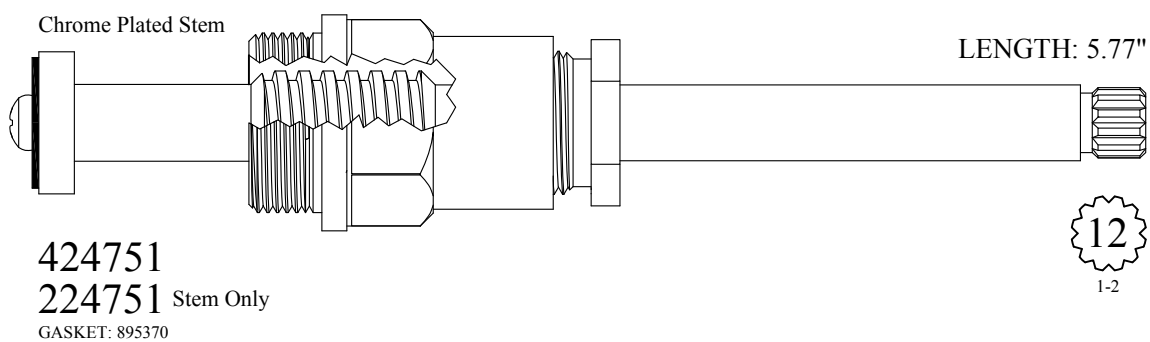
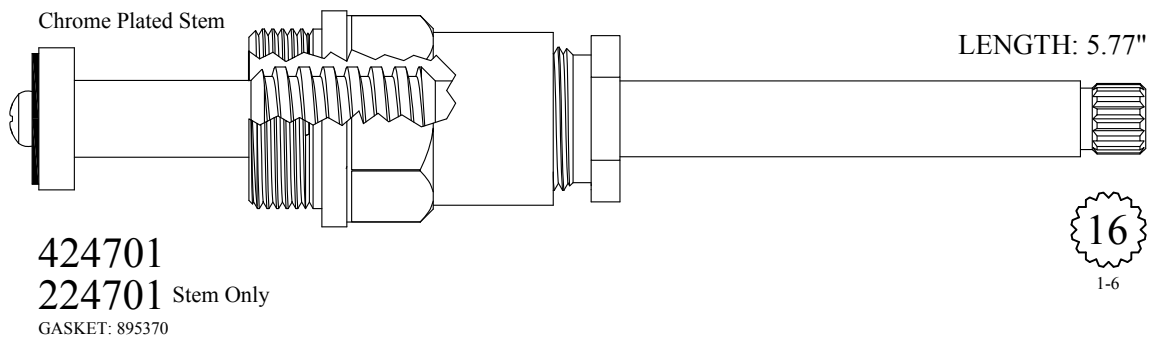

BARRY E.  WALTER  SR. CO.

Send Your Orders To:

BARRY E.  SR. CO.

E-mail: orderdesk@barrywalter.com

Fax: 1.800.886.9831

Phone: 1.800.767.5552

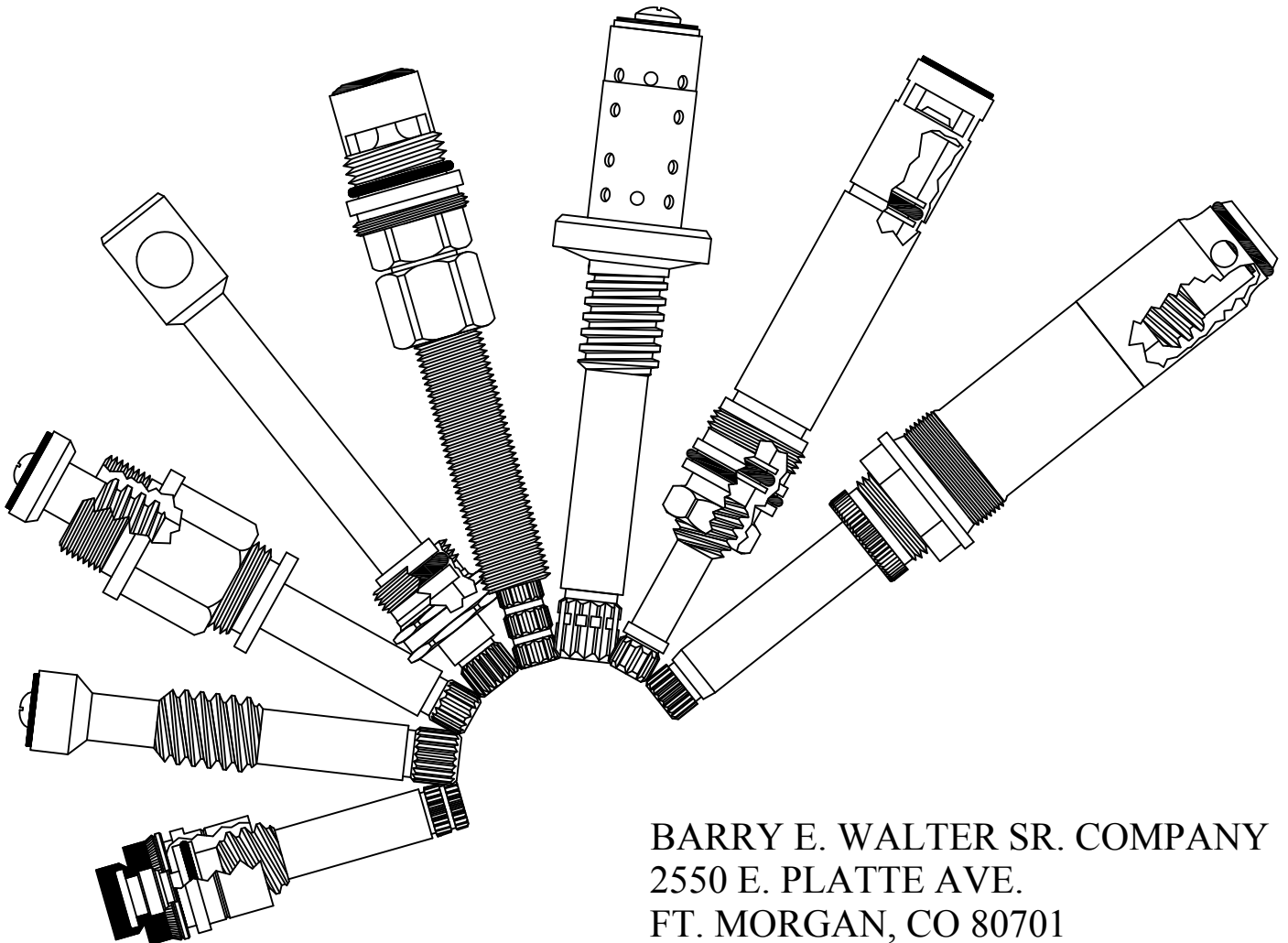

BARRY E. WALTER SR. COMPANY
2550 E. PLATTE AVE.
FT. MORGAN, CO 80701

We are always adding new parts. Check our website for updates.

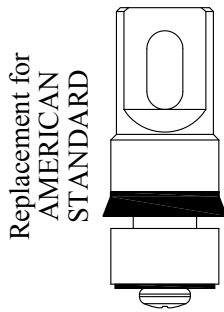

640010
OEM# 8339-07
SEAT: 649370

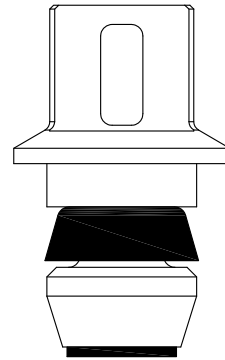

640320
OEM# 50
SEAT: 647980

**CHECK OUT OUR WEBSITE
FOR MORE BALLCOCK PLUNGERS**

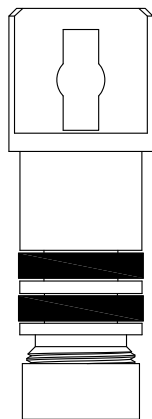

640300
OEM# 41 5/8"

Replacement for
UNIVERSAL
RUNDLE

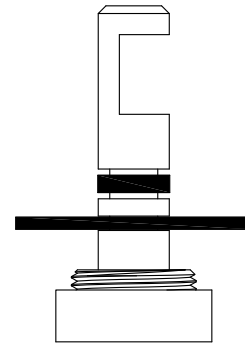

640400
OEM# A369
SEAT: 647830

BARRY E.  ALTER  SR. CO.

FOR GLAUBER WEST COAST

STEM LENGTH: 3.65"

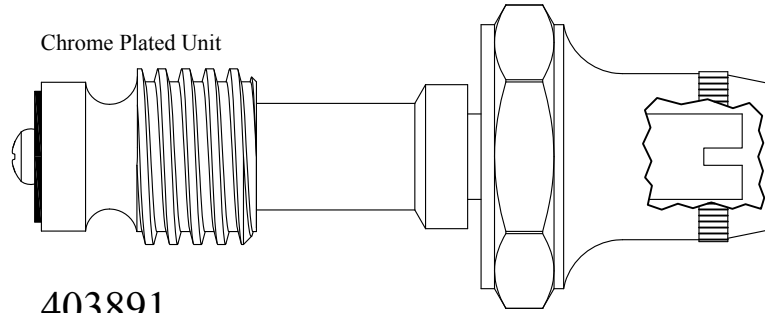

403891
203891 Stem Only

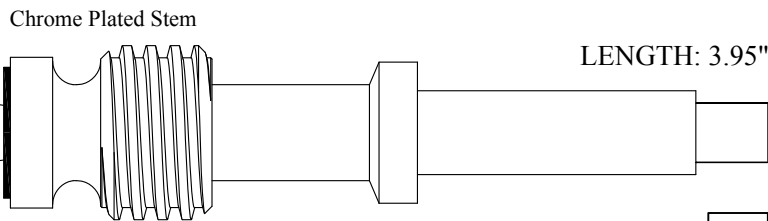

203901

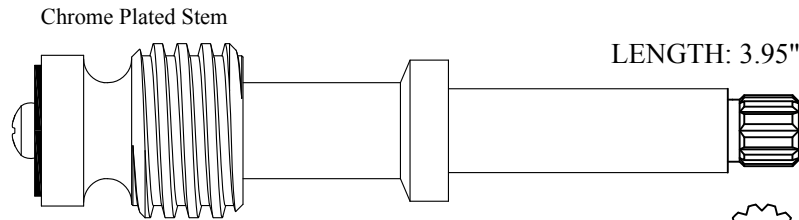

203951

1-2

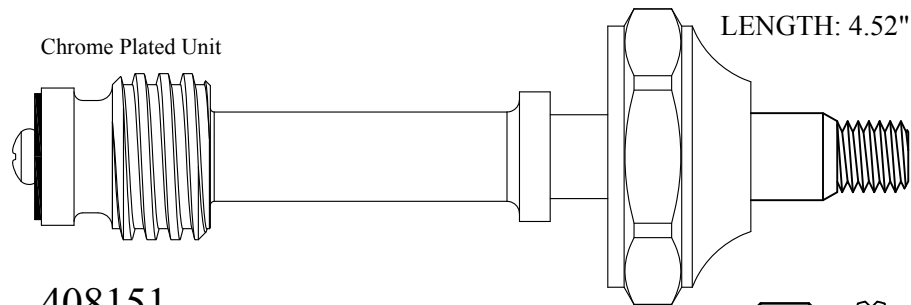

408151
208151 Stem Only

Supplied with
12pt. Broach



1-2

FOR GLAUBER WEST COAST

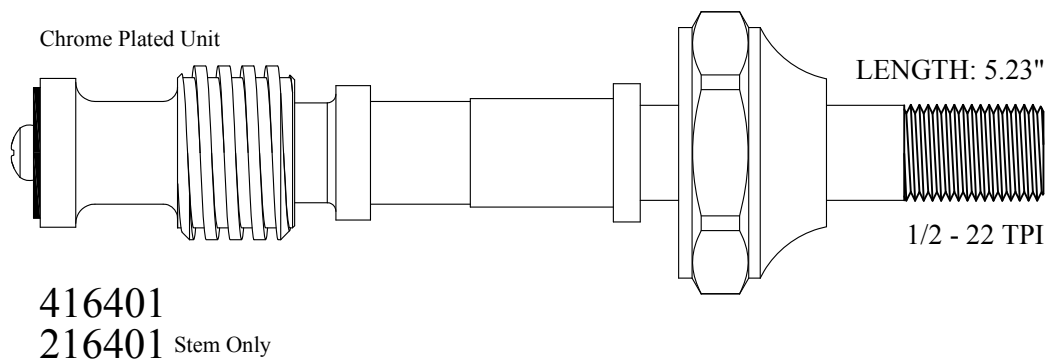
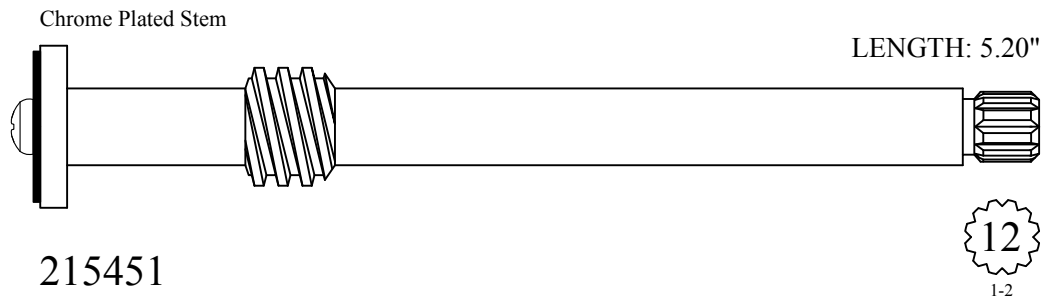
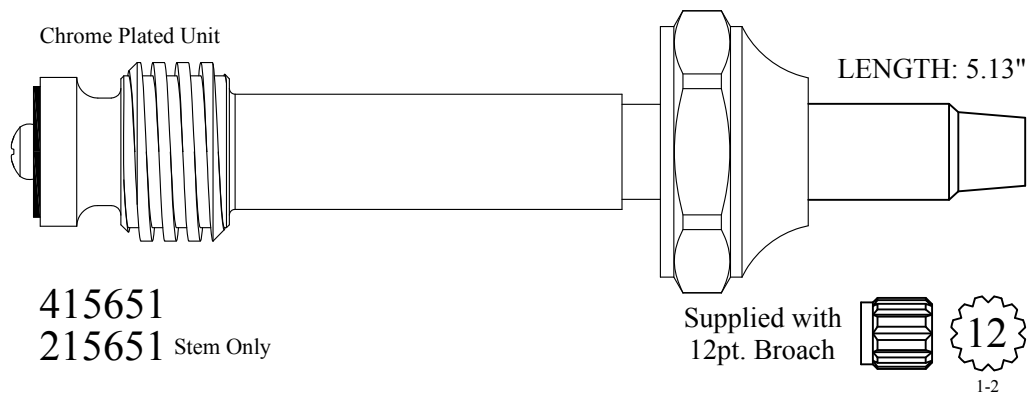
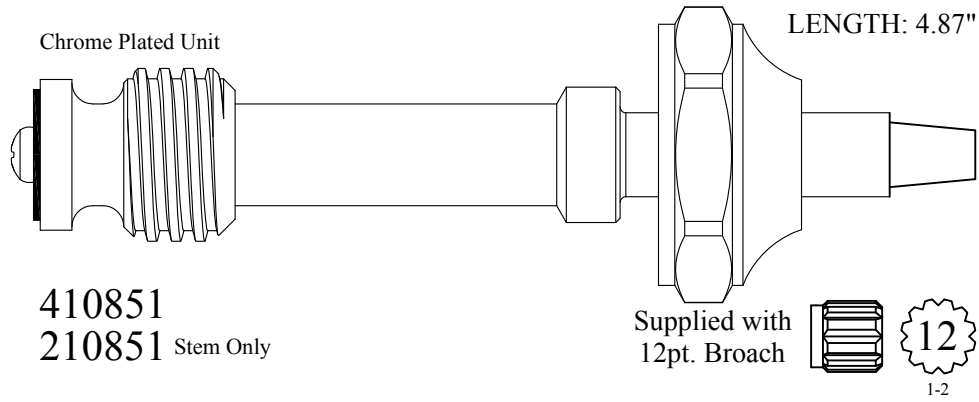

FOR GLAUBER WEST COAST

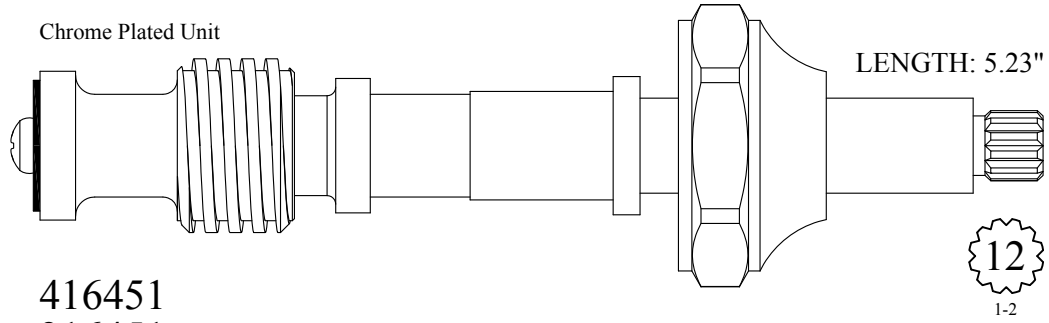

416451
216451 Stem Only

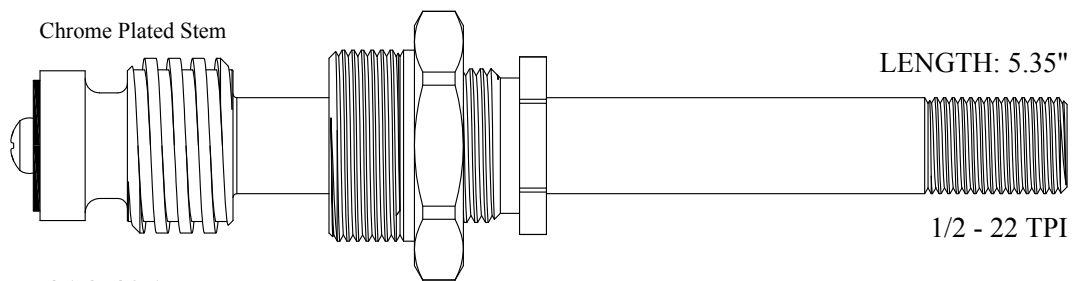

418601
218601 Stem Only
GASKET: 895570

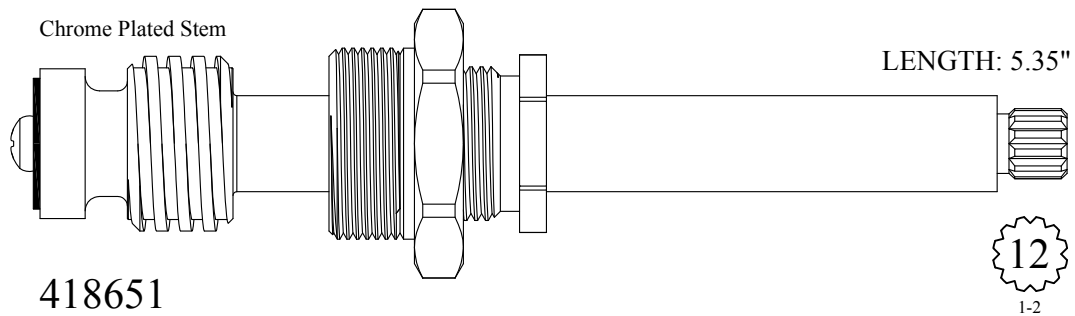

418651
218651 Stem Only
GASKET: 895570

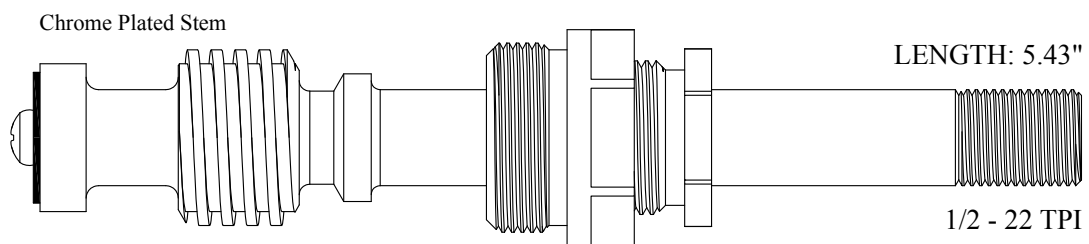

422401
222401 Stem Only
GASKET: 895550

FOR GLAUBER WEST COAST

Chrome Plated Stem

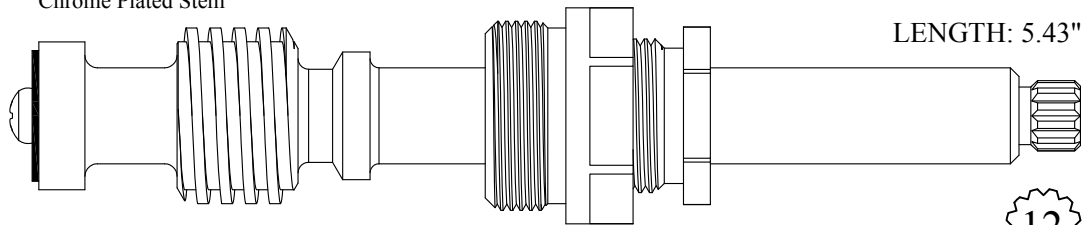

LENGTH: 5.43"



422451
222451 Stem Only
GASKET: 895550

Chrome Plated Stem

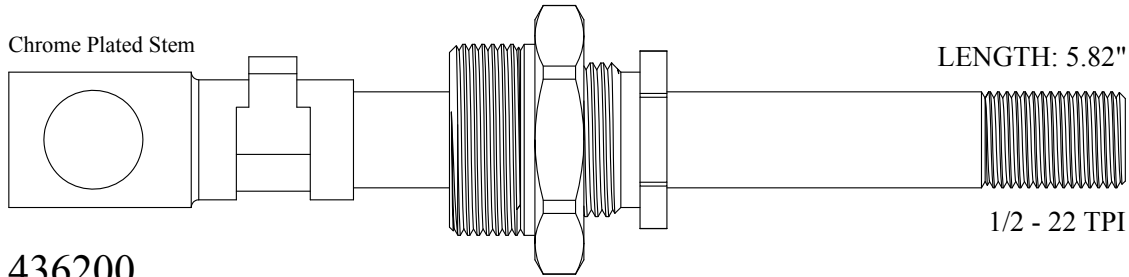

LENGTH: 5.82"

1/2 - 22 TPI

436200
236200 Stem Only
GASKET: 895570

Chrome Plated Stem

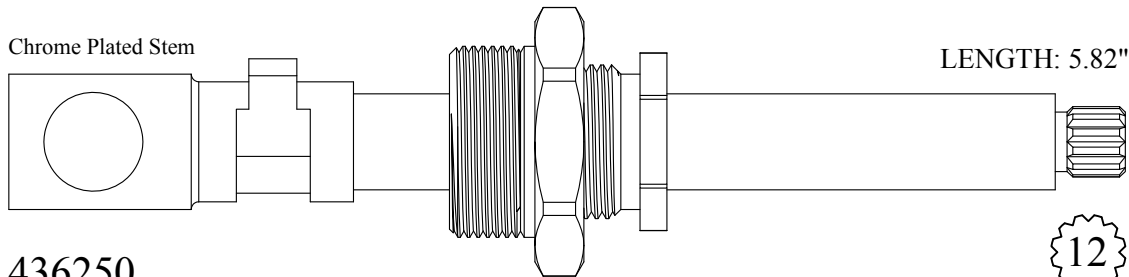

LENGTH: 5.82"



436250
236250 Stem Only
GASKET: 895570

Chrome Plated Stem

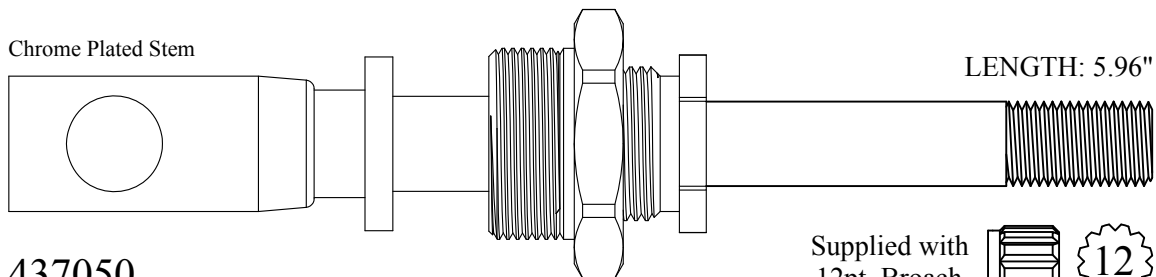

LENGTH: 5.96"

Supplied with
12pt. Broach



437050
237050 Stem Only
GASKET: 895570

Chrome Plated Stem

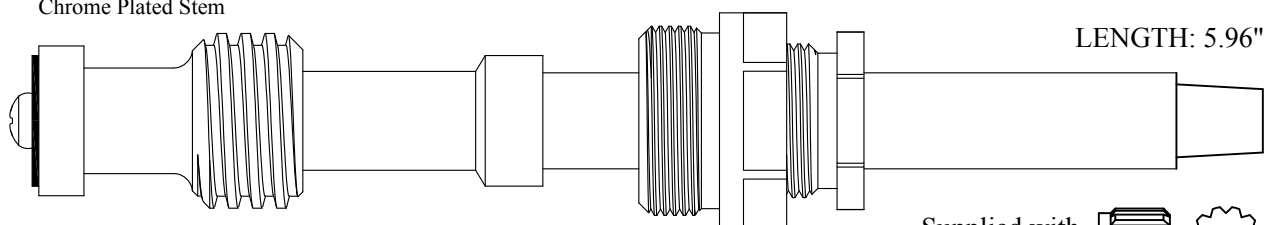

LENGTH: 5.96"

Supplied with
12pt. Broach



424351
224351 Stem Only
GASKET: 895550

FOR GOETZ

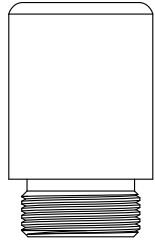

SEAT USED: 648920

Chrome Plated Stem

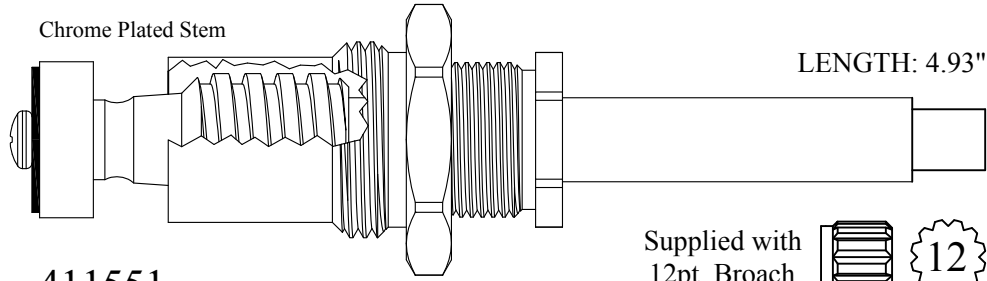

LENGTH: 4.93"

411551
211551 Stem Only
 GASKET: 895560

Supplied with
 12pt. Broach



1-2

Chrome Plated Unit

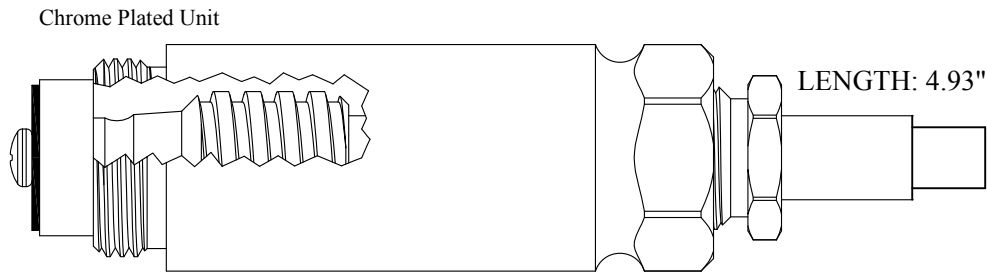

LENGTH: 4.93"

411561
211551 Stem Only
 GASKET: 895560

Supplied with
 12pt. Broach



1-2

Chrome Plated Unit

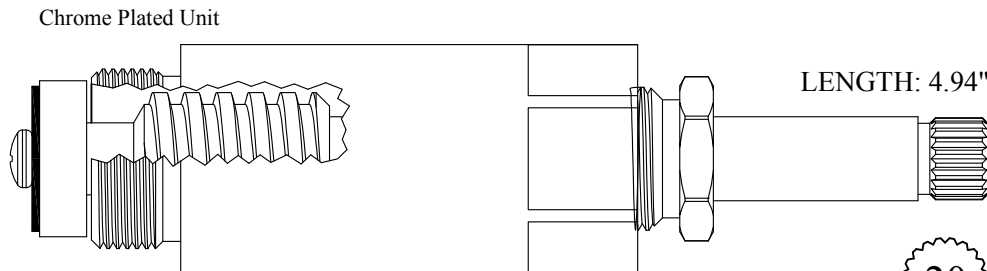

LENGTH: 4.94"

412211
212211 Stem Only
 GASKET: 895370



2-4

Chrome Plated Unit

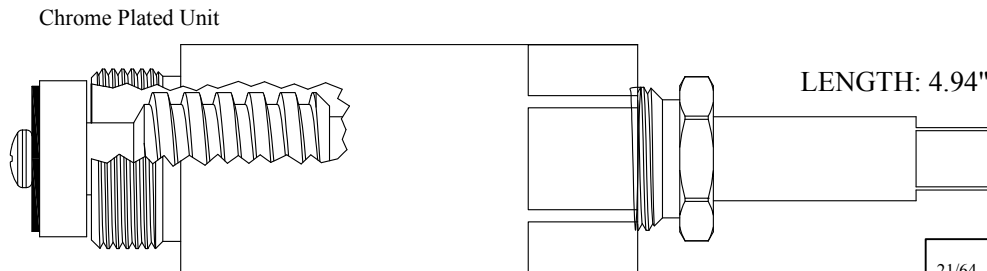

LENGTH: 4.94"

412221
212221 Stem Only
 GASKET: 895370

21/64

FOR GOETZ

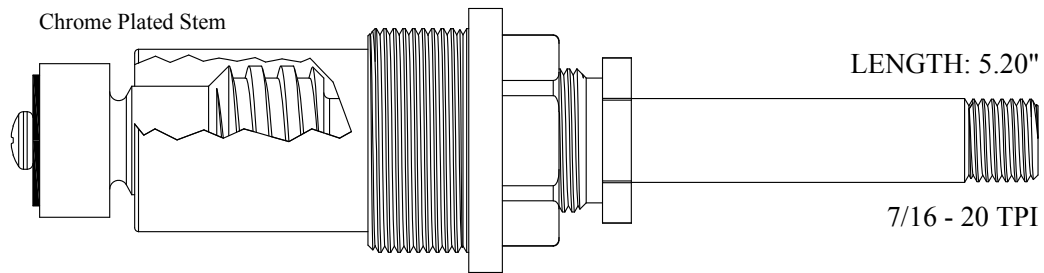

416861
216861 Stem Only

FOR GRAND HAVEN

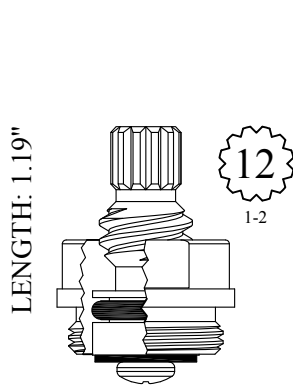

GASKET: 895160

LF450021



SEAT USED: LF649270

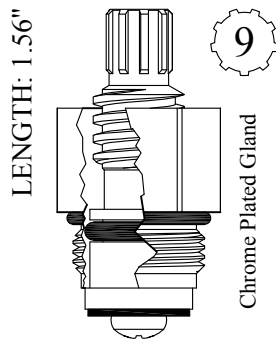

GASKET: 890160 O-RING INCLUDED

LF452861



SEAT USED: LF649050

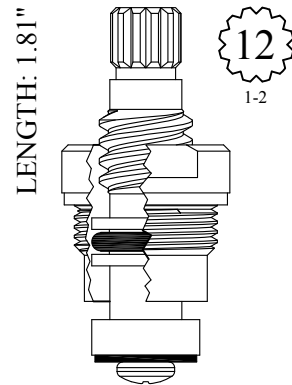

GASKET: 895100

LF456071
LF456072



SEAT USED: LF649270

FOR GRAND HAVEN

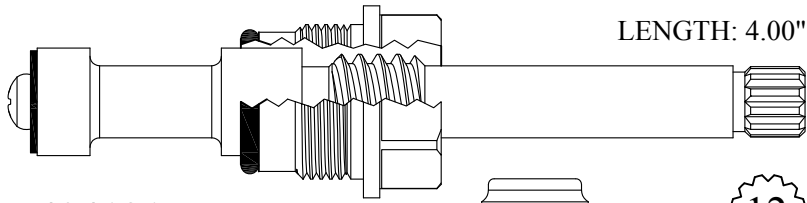

404121
GASKET: 895150

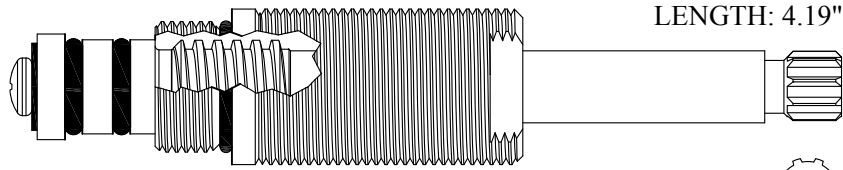
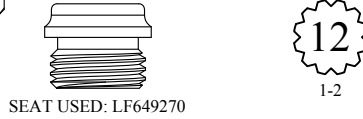

405011
GASKET: 890150 O-RING INCLUDED

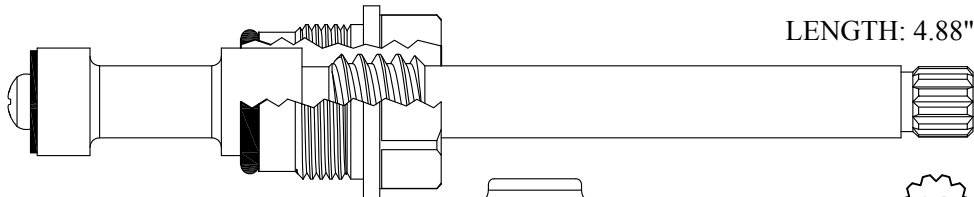

410761
GASKET: 895150

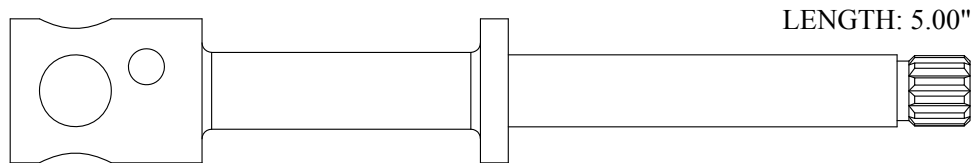

232220

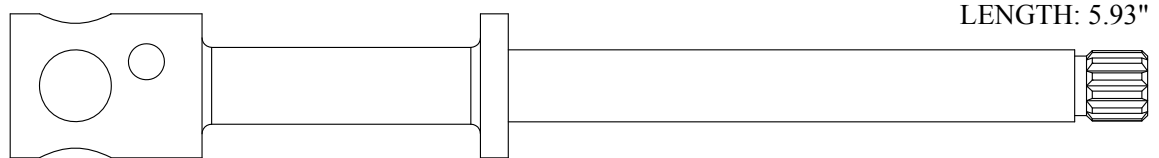

236310



FOR GROHE

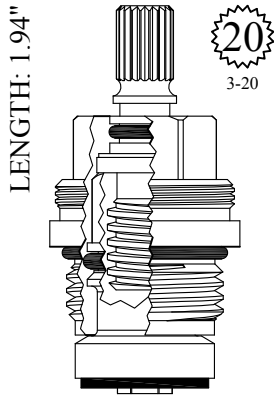

GASKET: 890170 O-RING INCLUDED

LF457282



SEAT USED: LF647580

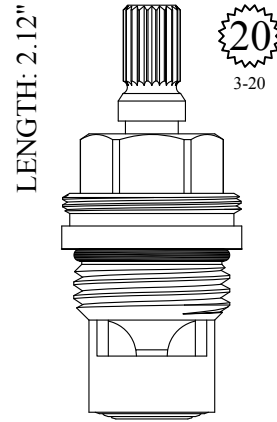

GASKET: 890170 O-RING INCLUDED

SEAL: 898500

DISC SET: 112530-PKG

LF459501

LF459502

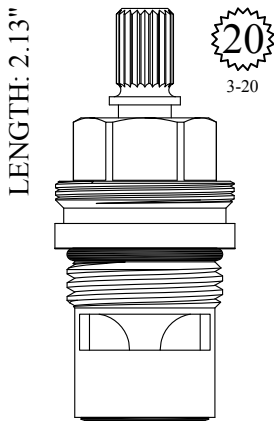

GASKET: 890170 O-RING INCLUDED

SEAL: 898510

DISC SET: 151380-PKG

LF459701

LF459702

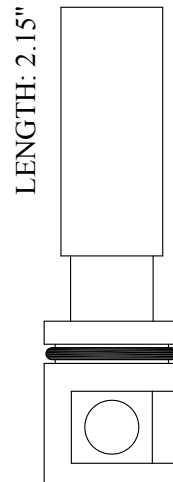

230650

FOR GROHE

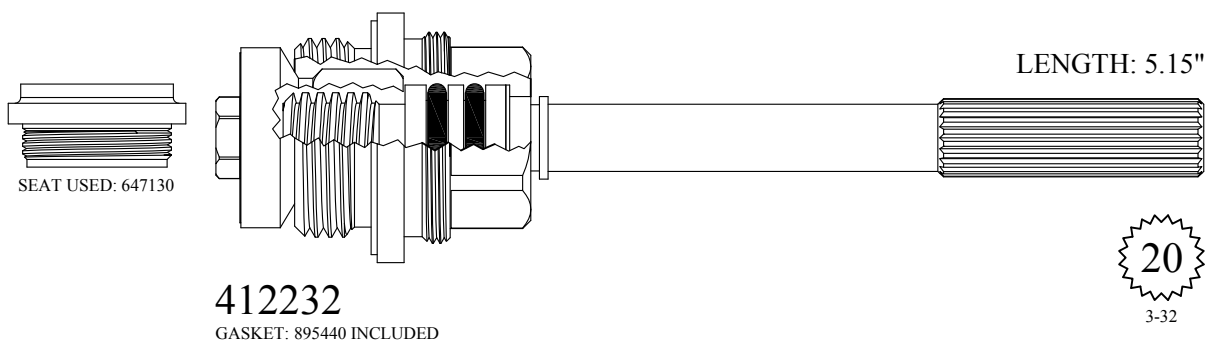
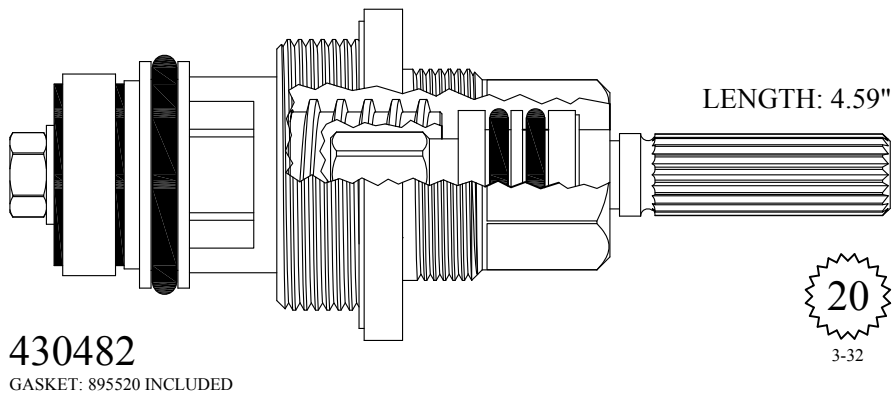
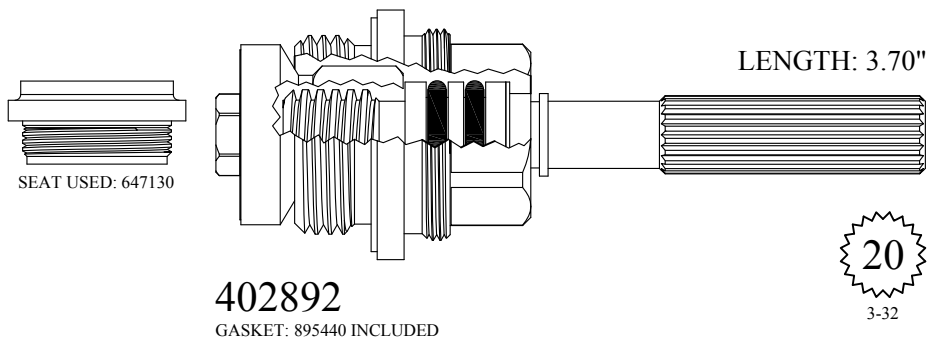
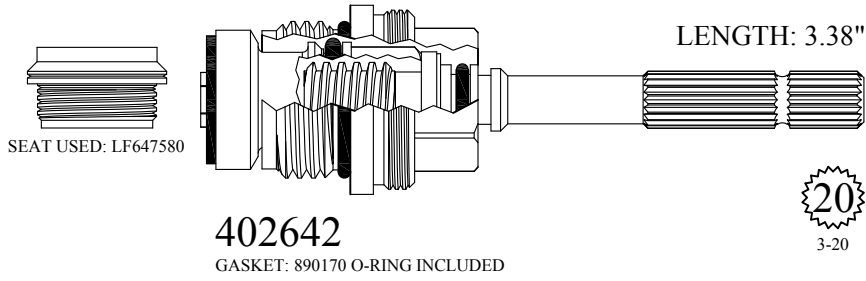

FOR HAJOCA

Chrome Plated Stem

LENGTH: 3.15"

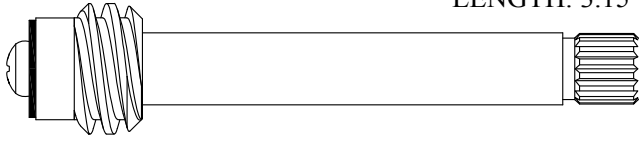

LF266511



Chrome Plated Stem

LENGTH: 4.81"

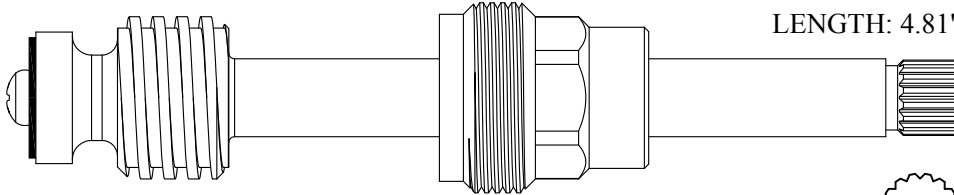

415321
215321 Stem Only



Chrome Plated Stem

LENGTH: 5.76"

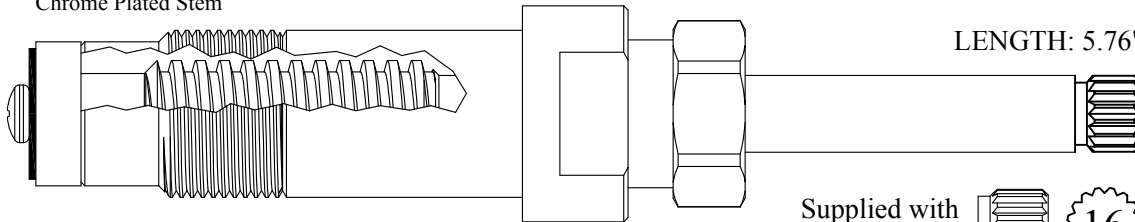

422021
222021 Stem Only
GASKET: 895400

Supplied with
12pt. Broach

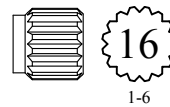

Chrome Plated Stem

LENGTH: 6.55"

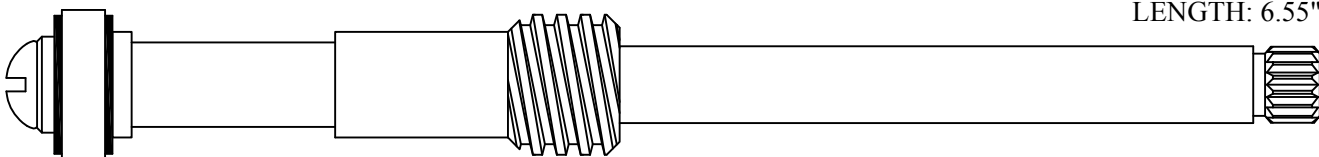

239601

Supplied with
12pt. Broach

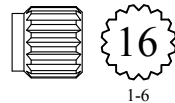

FOR HARCRAFT

LENGTH: 1.45"

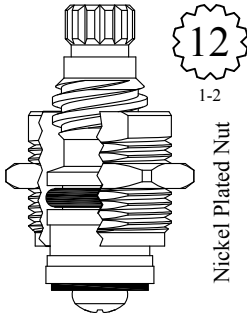

Nickel Plated Nut

GASKET: 895040

LF451101

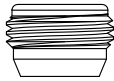

SEAT USED: LF648670

LENGTH: 1.45"

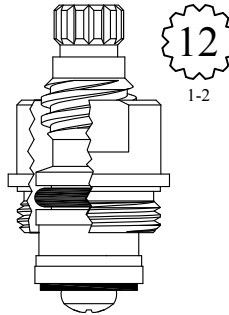

GASKET: 895100

LF451241
LF451242

LENGTH: 1.67"

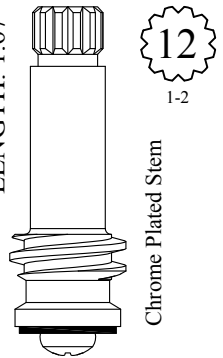

Chrome Plated Stem

LF254021
LF254022

LENGTH: 1.90"

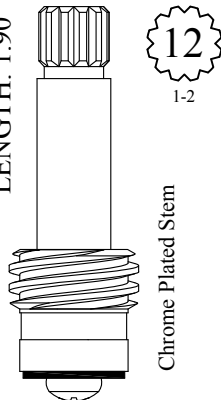

Chrome Plated Stem

LF257111
LF257112

LENGTH: 2.34"

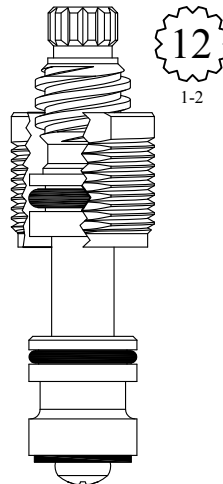

GASKET: 895040 INCLUDED

LF462091

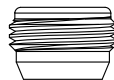

SEAT USED: LF648670

LENGTH: 2.44"

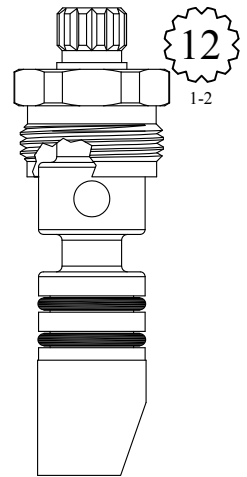

430040
230040 Stem Only

FOR HARCRAFT

LENGTH: 2.52"

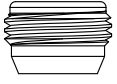

SEAT USED: LF648670

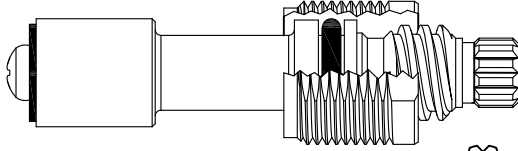

LF464021/ LF464022

GASKET: 895040 INCLUDED



LENGTH: 2.98"

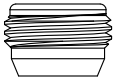

SEAT USED: LF648670

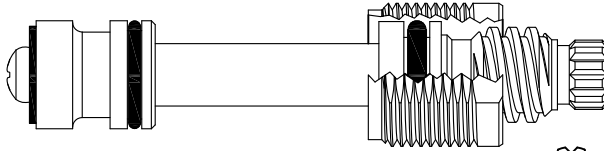

LF465411

GASKET: 895040 INCLUDED



LENGTH: 3.45"

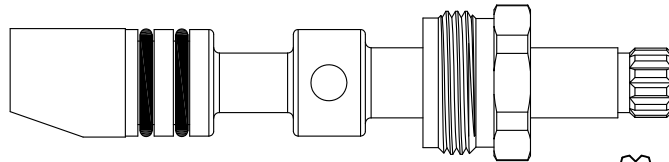

430140

230140 Stem Only



LENGTH: 3.46"

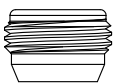

SEAT USED: LF648670

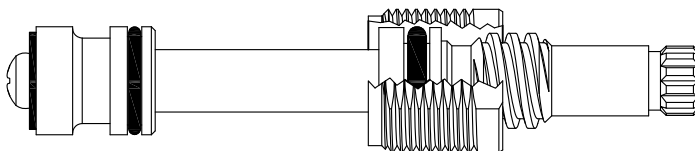

LF466131

LF266131 Stem Only

GASKET: 895040 INCLUDED



FOR HARCRAFT

Chrome Plated Stem

LENGTH: 3.88"

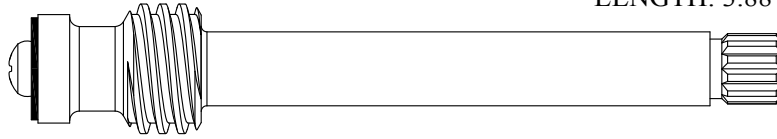

LF270011/ LF270012

12
1-2

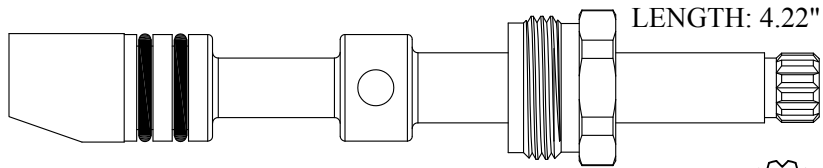

LENGTH: 4.22"

430200
230200 Stem Only

12
1-2



SEAT USED: LF648670

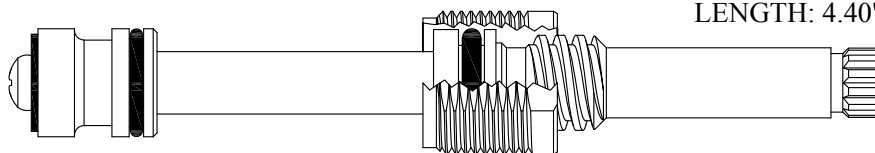

LENGTH: 4.40"

406001
GASKET: 895040 INCLUDED

12
1-2

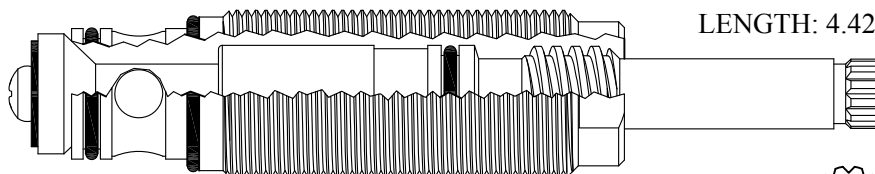

LENGTH: 4.42"

430501
203501 Stem Only
GASKET: 890170 O-RING INCLUDED

12
1-2

FOR HARCRAFT

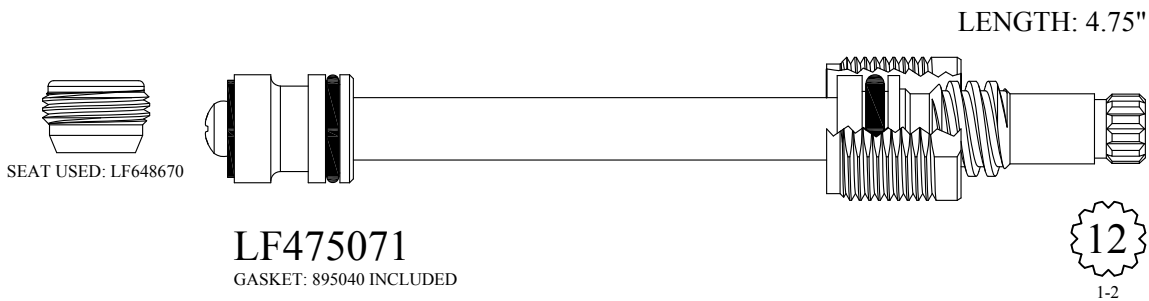
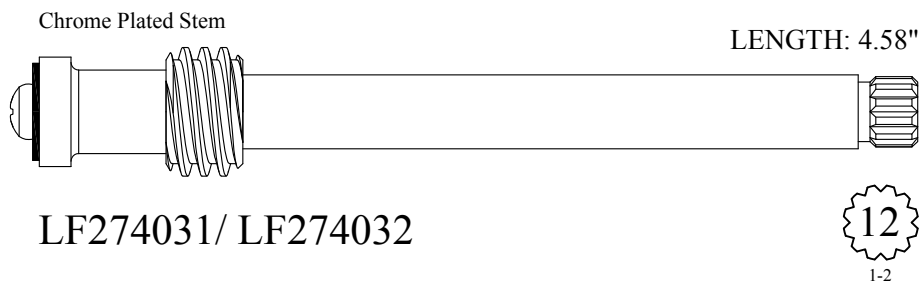
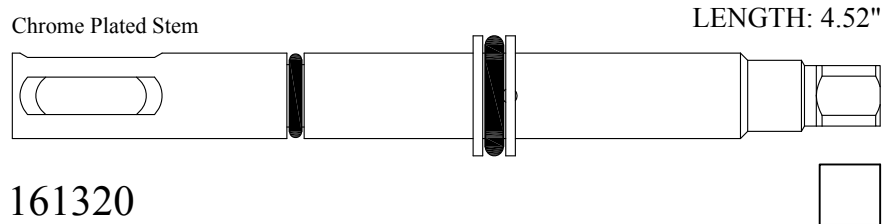
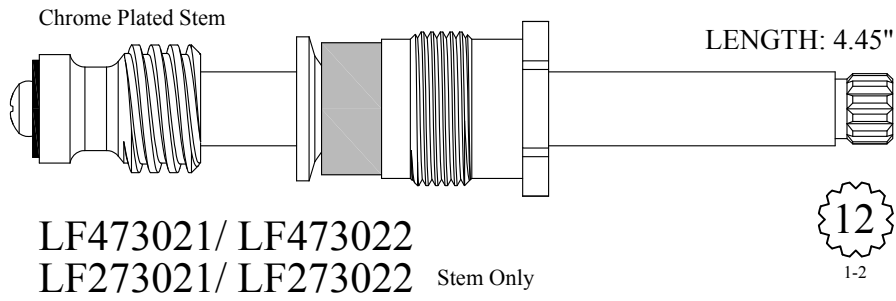

FOR HARCRAFT

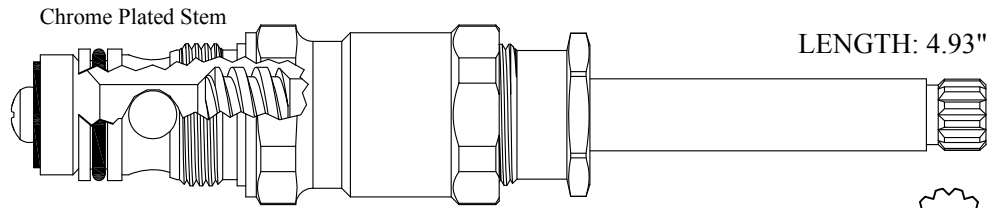

431801
231801 Stem Only
GASKET: 895100

12
1-2

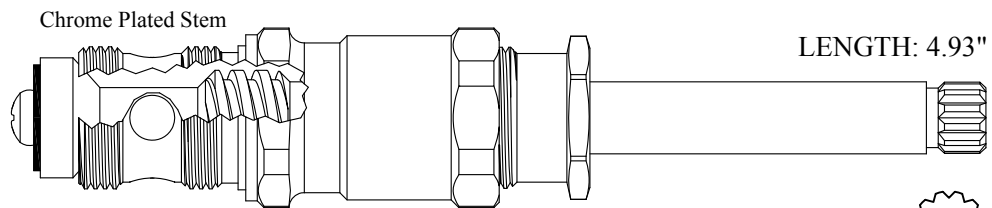

431811
231801 Stem Only
GASKET: 895100

12
1-2

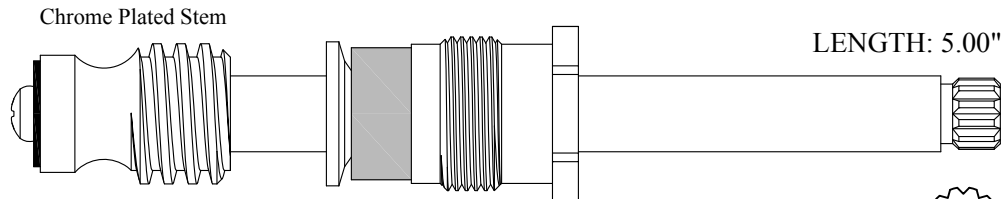

413501
213501 Stem Only

12
1-2

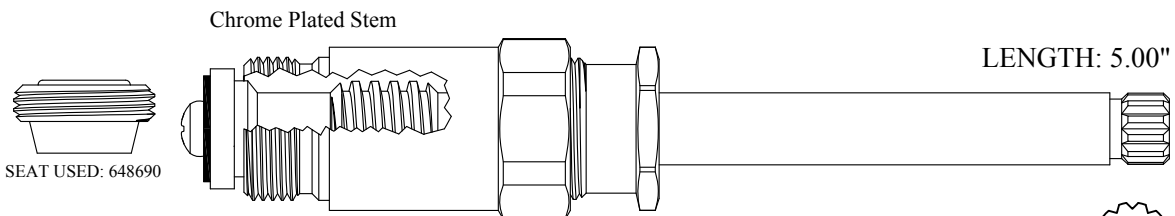

413701
213701 Stem Only
GASKET: 895100

12
1-2

FOR HARCRAFT

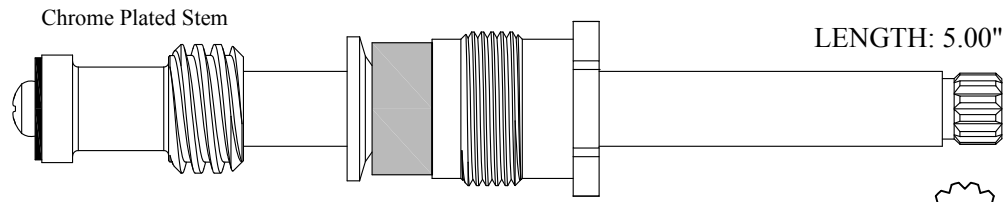

Chrome Plated Stem
 LF480011/ LF480012
 LF280011/ LF280012 Stem Only

12
 1-2

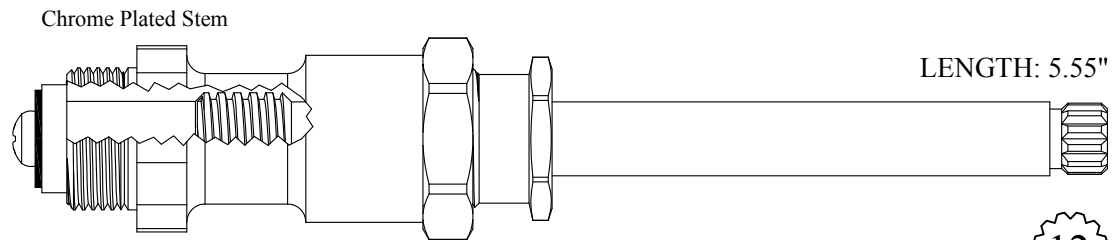

Chrome Plated Stem
 423001
 223001 Stem Only
 GASKET: 895100

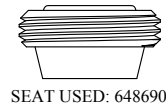

SEAT USED: 648690

12
 1-2

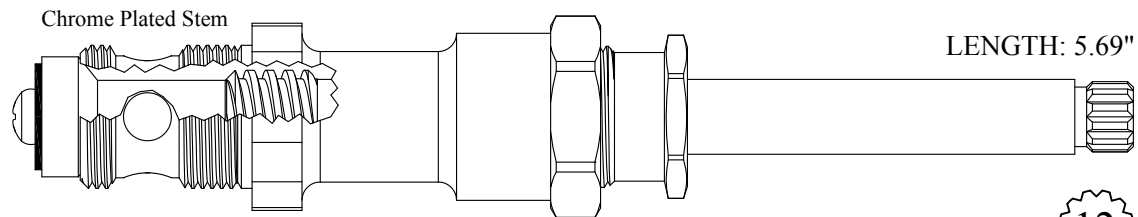

Chrome Plated Stem
 435721
 235721 Stem Only
 GASKET: 895100

12
 1-2

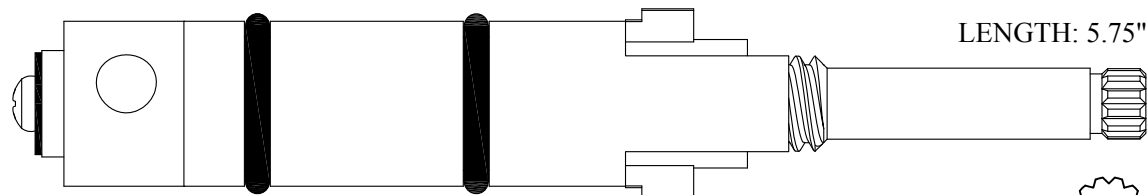

424221

12
 1-2

FOR HARDEN

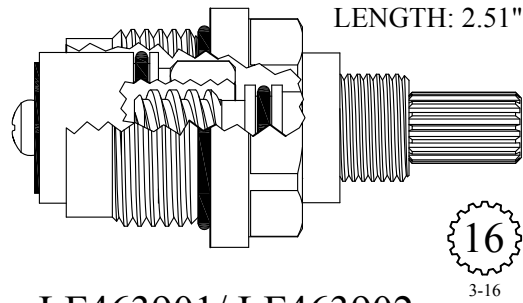

LF463901/ LF463902

GASKET: 890210 O-RING INCLUDED

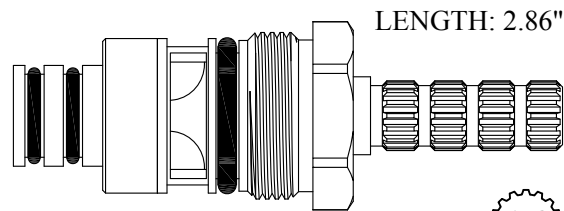

LF465401/ LF465402

GASKET: 891140 O-RING INCLUDED
DISC SET: 151380-PKG

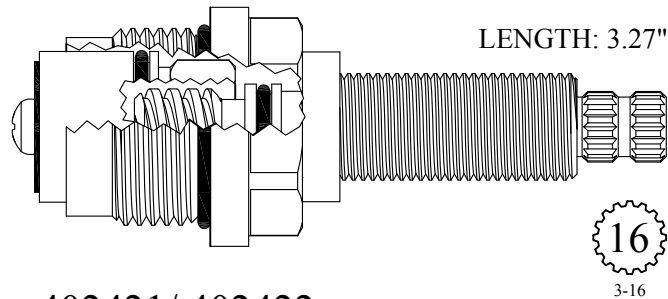

402421/ 402422

GASKET: 890210 O-RING INCLUDED

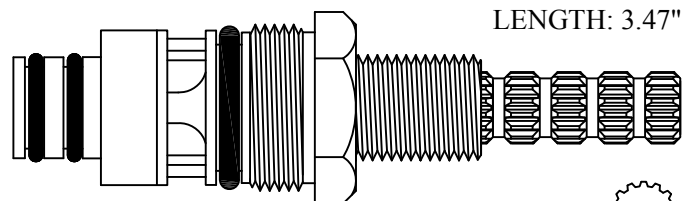

LF468201/ LF468202

GASKET: 891140 O-RING INCLUDED
DISC SET: 151380-PKG

FOR HARDEN

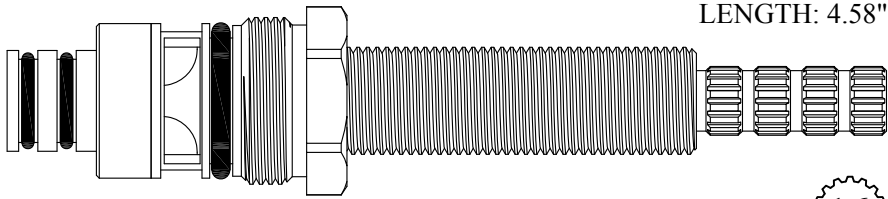

LENGTH: 4.58"

408011/ 408012

GASKET: 891140 O-RING INCLUDED
DISC SET: 151380-PKG

16
3-16

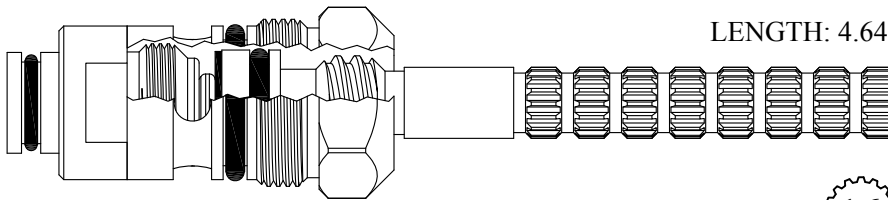

LENGTH: 4.64"

408031/ 408032

GASKET: 891140 O-RING INCLUDED

16
3-16

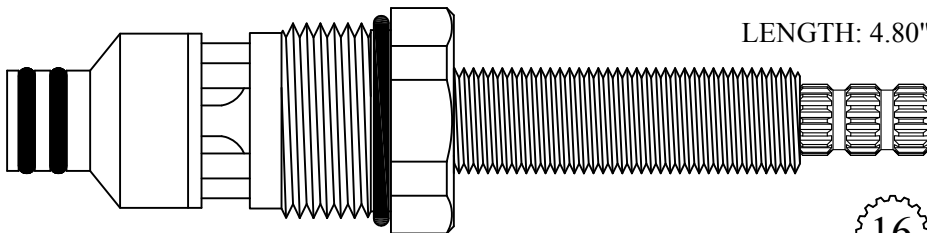

LENGTH: 4.80"

409931/ 409932

GASKET: 890210 O-RING INCLUDED
DISC SET: 151380-PKG

16
3-16

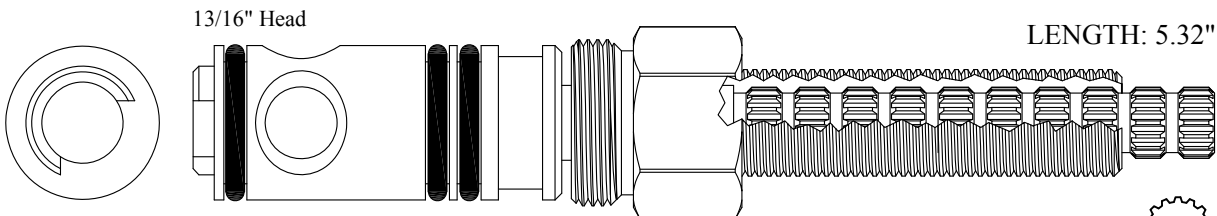

13/16" Head

LENGTH: 5.32"

432920

232920 Stem Only

16
3-16

FOR HARDEN

3/4" Head

LENGTH: 5.32"

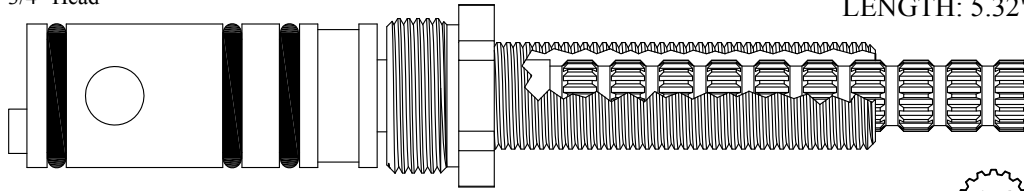

432930

232930 Stem Only

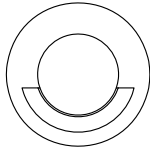

3-16

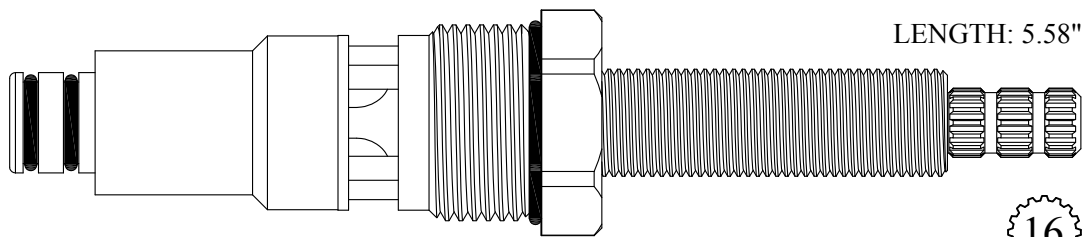

LENGTH: 5.58"

423931/ 423932

GASKET: 890210 O-RING INCLUDED
DISC SET: 151380-PKG



3-16

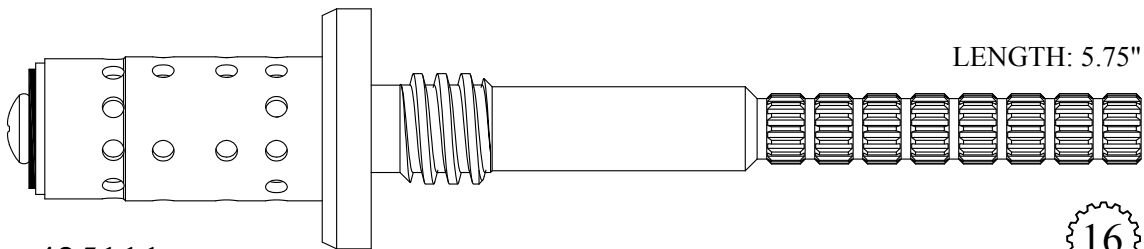

LENGTH: 5.75"

425111

225111 Stem Only

GASKET: 895500



3-16

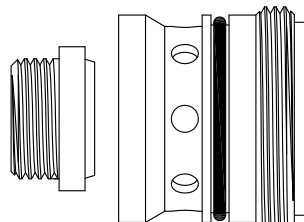

SEAT KIT USED: 106090

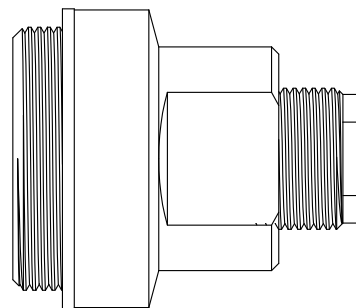

FOR HARDEN

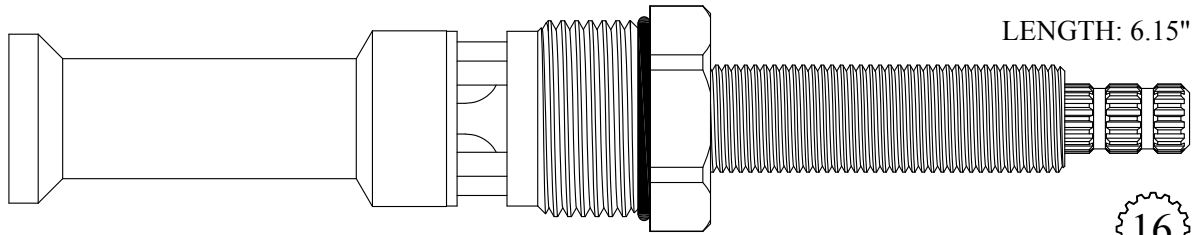

426411/ 426412

GASKET: 890210 O-RING INCLUDED
SEAL: 64705-07
DISC SET: 151380-PKG

16
3-16

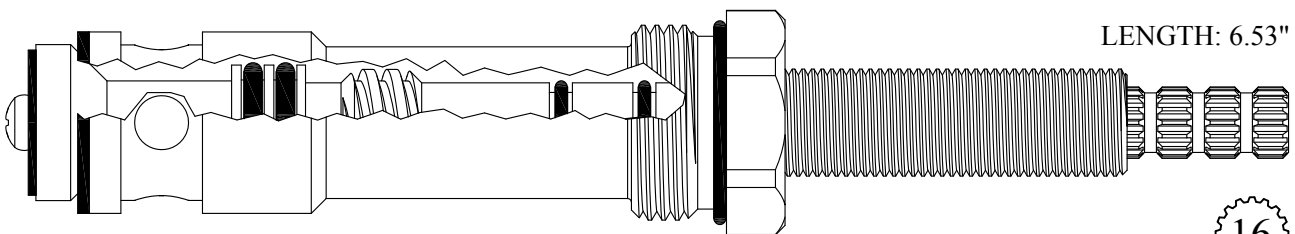

439141

GASKET: 891180 O-RING INCLUDED

16
3-16

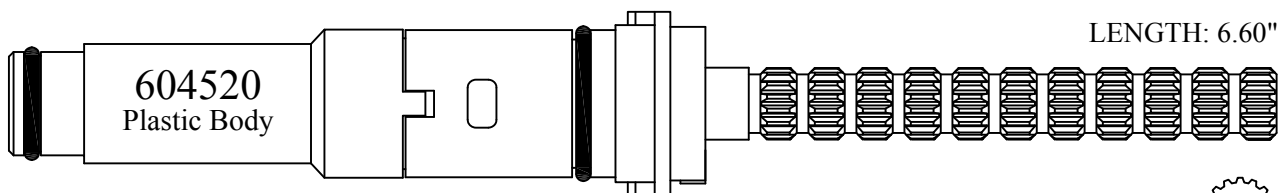

403941/ 403942

Available: Stem Only

203941

203942

16
3-16

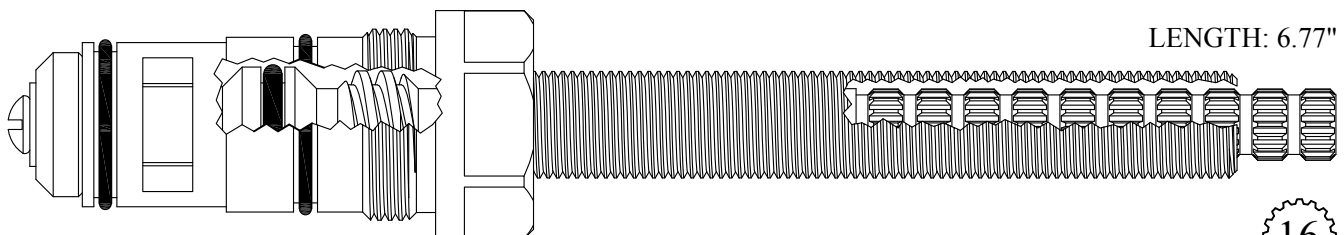

439221

16
3-16

FOR HARDEN

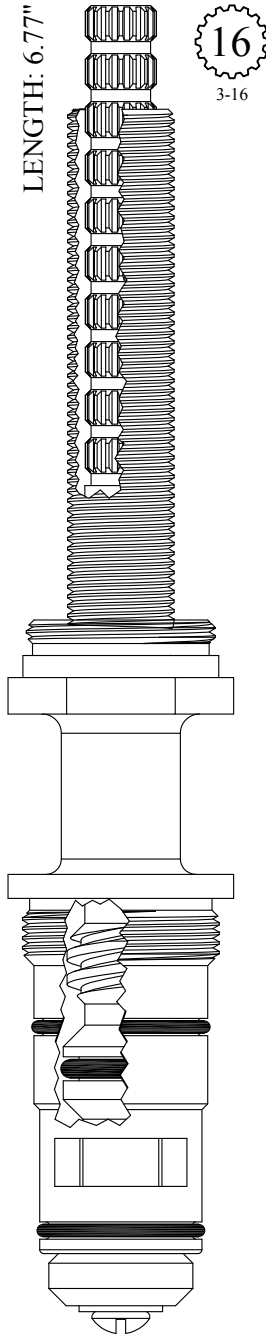

439241

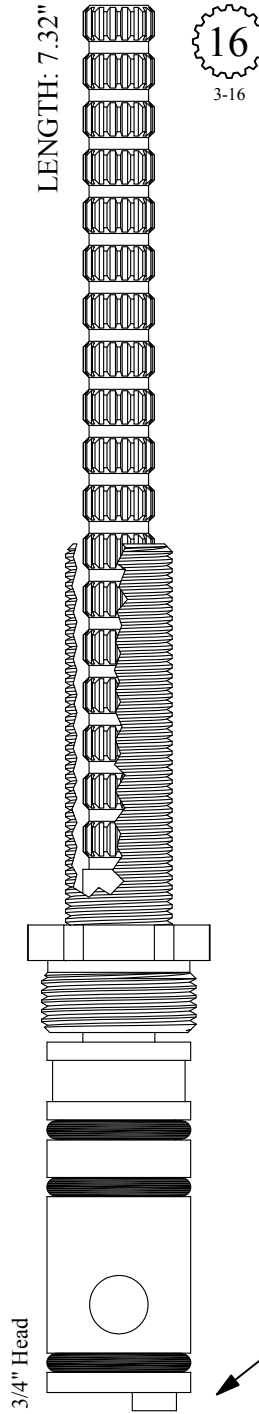

439730
239730 Stem Only

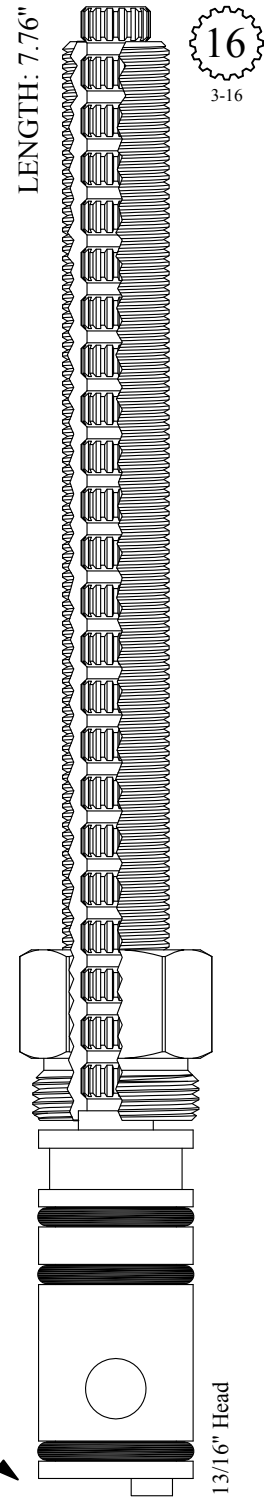

439760
239760 Stem Only

FOR HARDEN

LENGTH: 7.88"

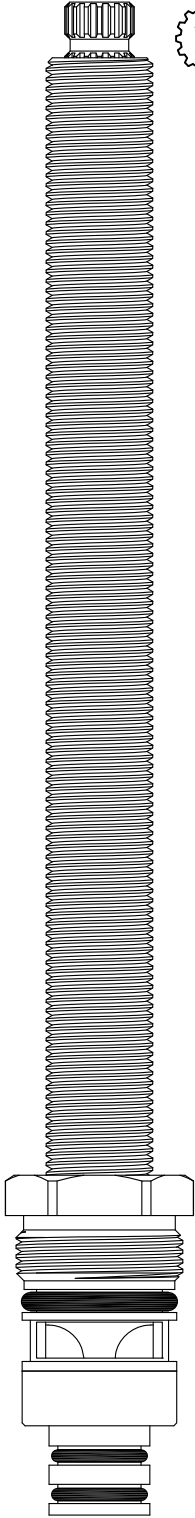

16
3-16

DISC SET: 151380-PKG

428201
428202

LENGTH: 8.18"

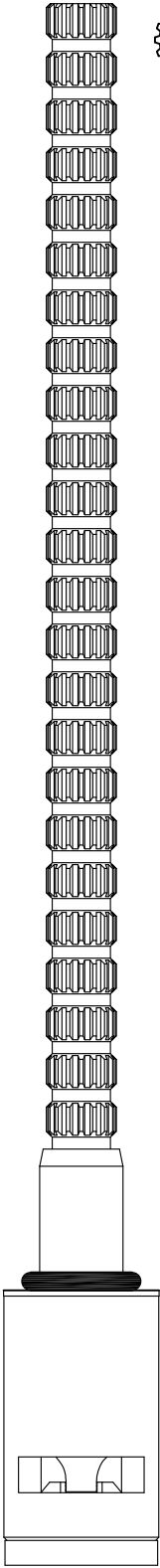

16
3-16

DISC SET: 151380-PKG

428211
428212

LENGTH: 8.28"

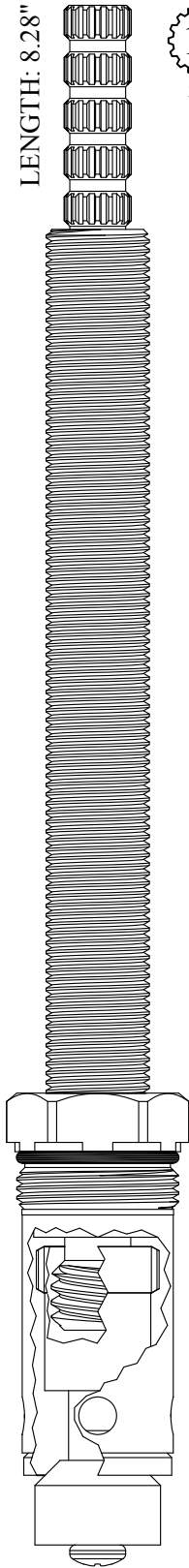

16
3-16

GASKET: 891140 O-RING INCLUDED

439722

FOR HARDEN

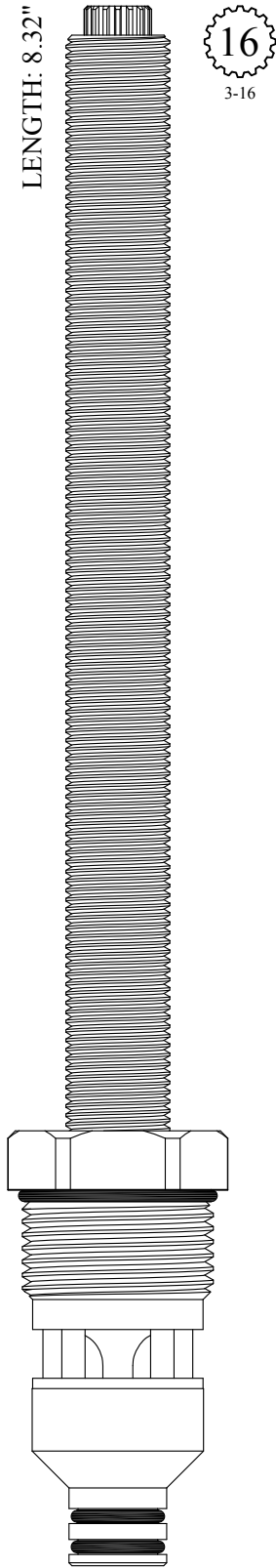

GASKET: 890210 O-RING INCLUDED
DISC SET: 151380-PKG

428111
428112

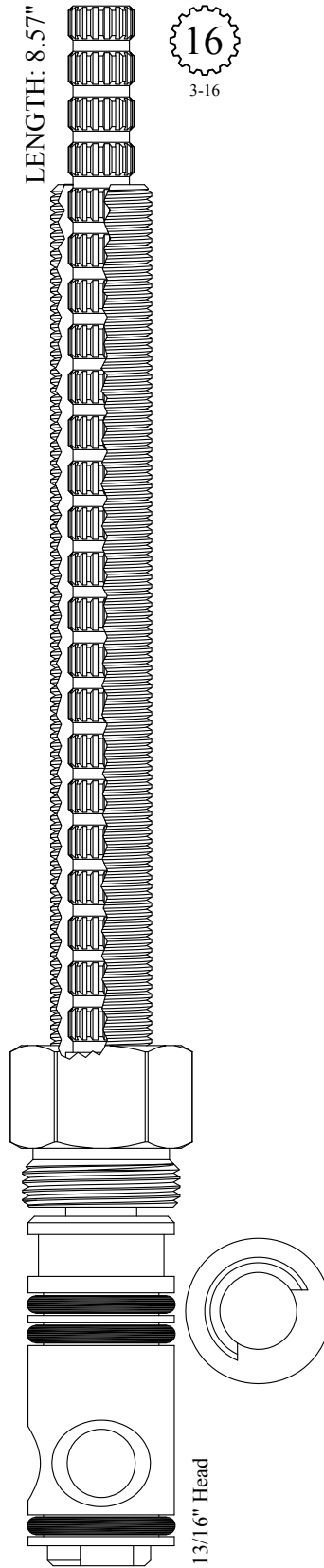

439740
239740 Stem Only

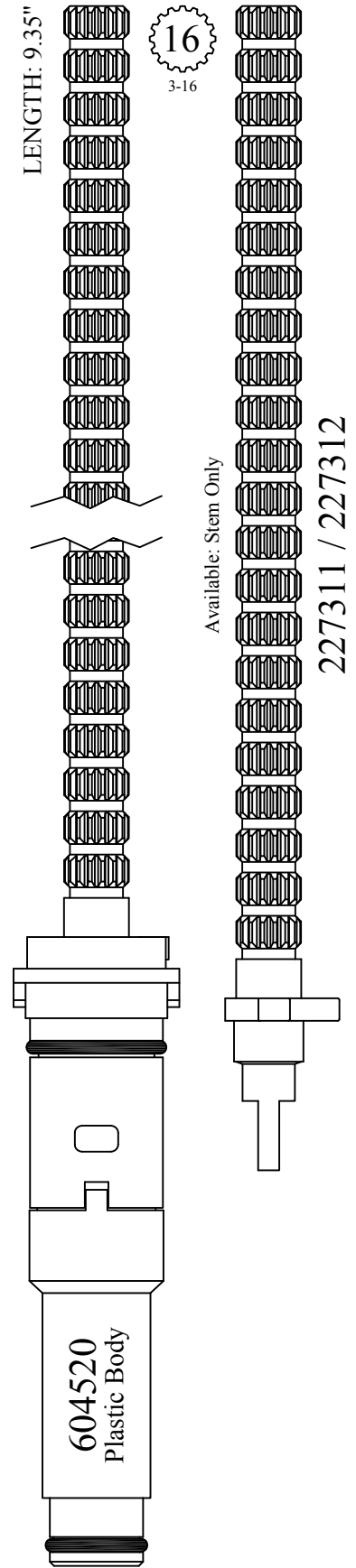

427311
427312

FOR HARDEN

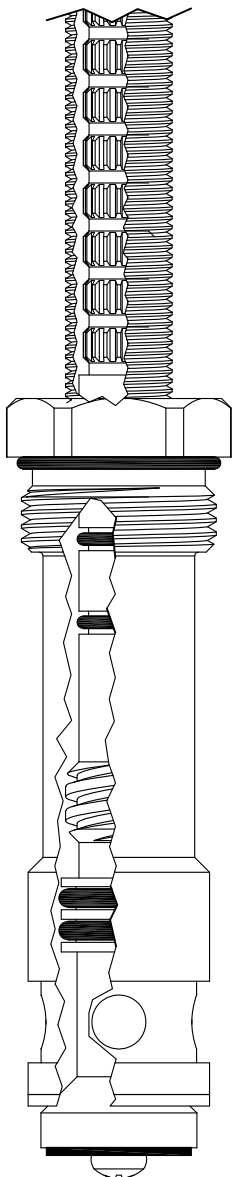
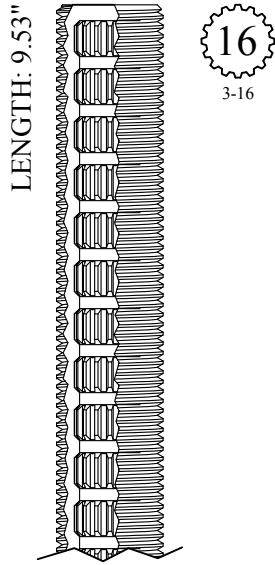

GASKET: 891180 O-RING INCLUDED

439911

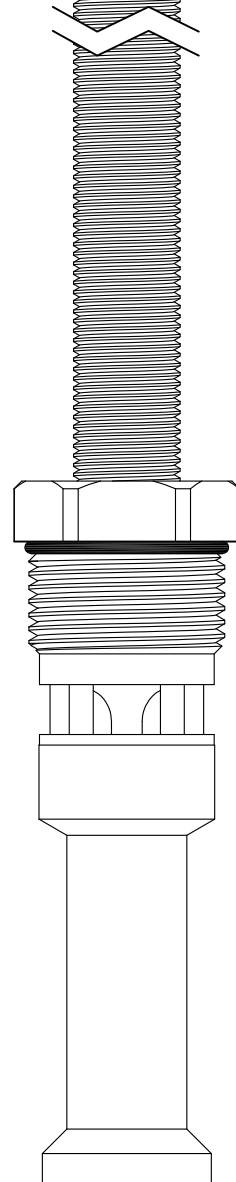
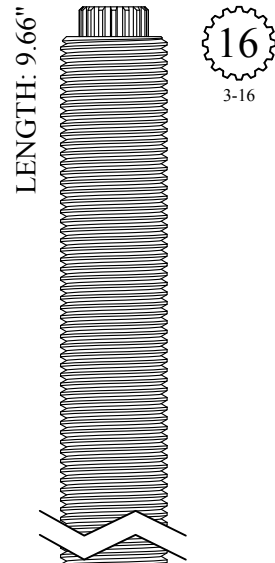

GASKET: 890210 O-RING INCLUDED
SEAL: 898510
DISC SET: 151380-PKG

428441
428442

Send Your Orders To:

BARRY E.  SR. CO.

E-mail: orderdesk@barrywalter.com

Fax: 1.800.886.9831

Phone: 1.800.767.5552



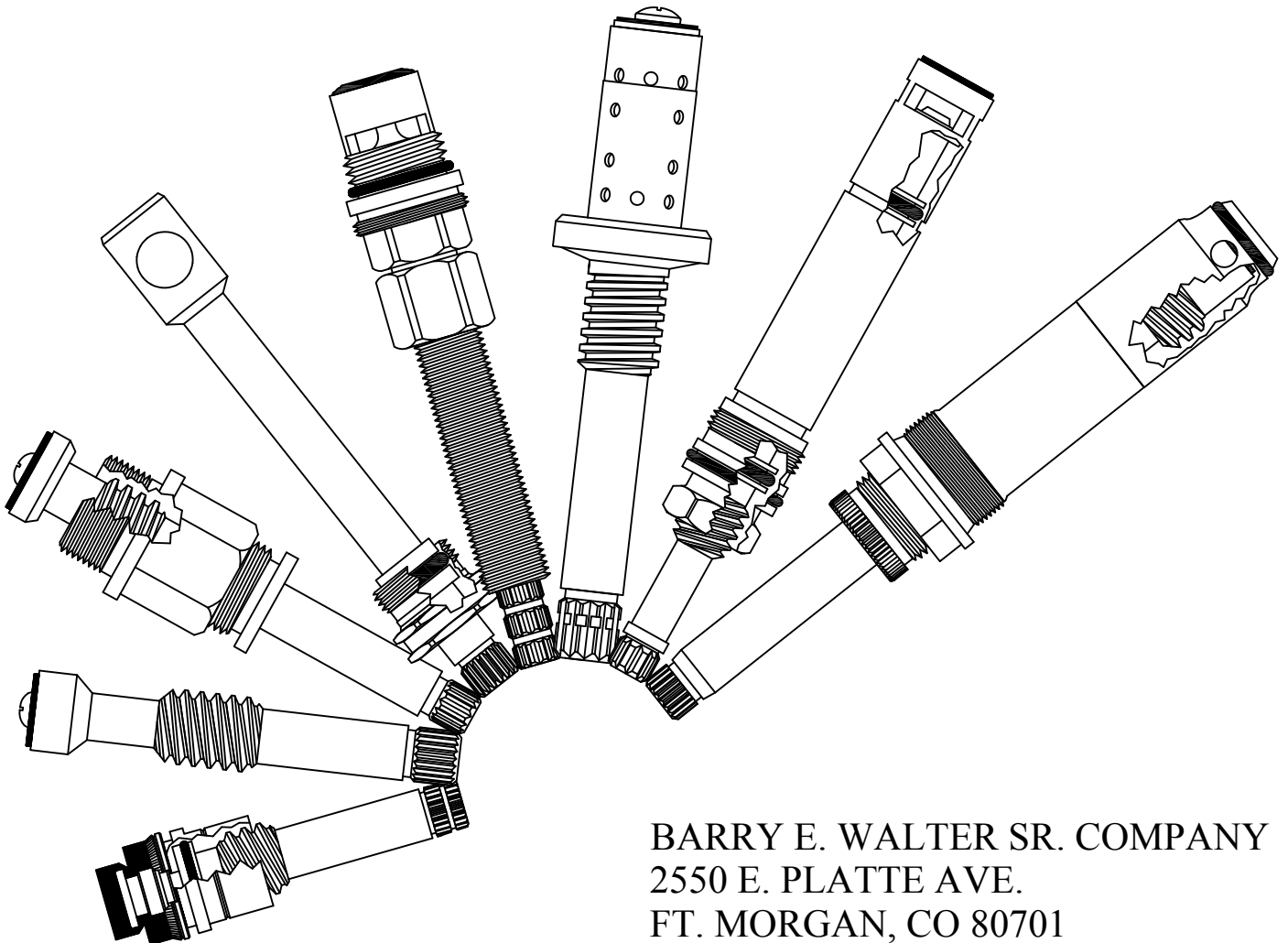

Quality Replacement Parts



BARRY E. WALTER SR. COMPANY
2550 E. PLATTE AVE.
FT. MORGAN, CO 80701

FOR HARRINGTON

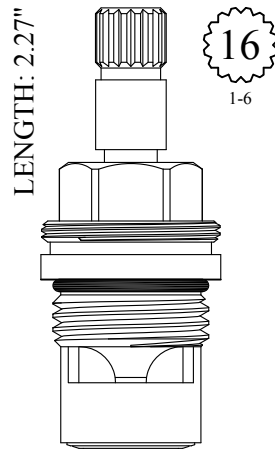
Packing Nut pictured for
identification purposes only



GASKET: 890170 O-RING INCLUDED
SEAL: 898510-W
DISC SET: 151380-PKG

LF462541
LF462542

FOR HASTINGS

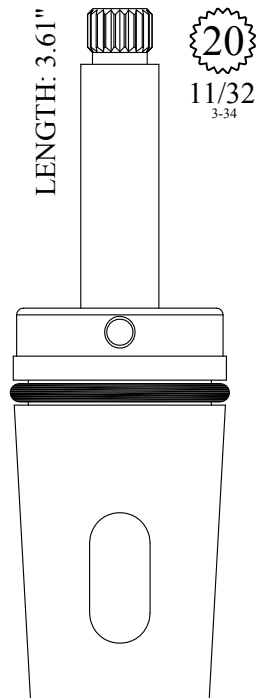

230580

FOR HAWS

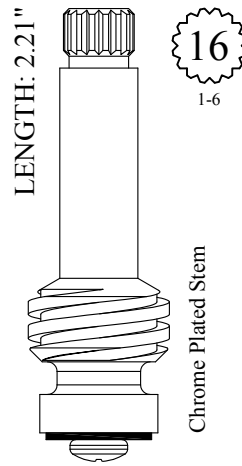

LF262161

FOR HELVEX

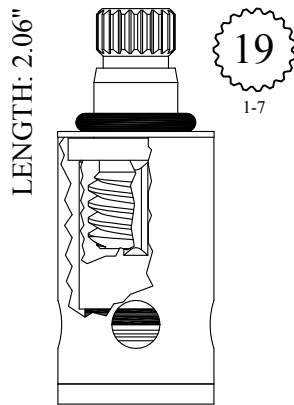

LF458992

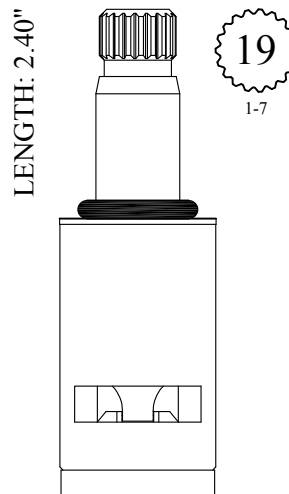

DISC SET: 151380-PKG

LF463801
LF463802

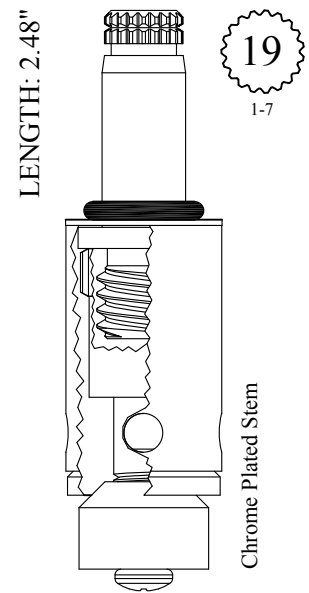

430992

FOR HUDSON

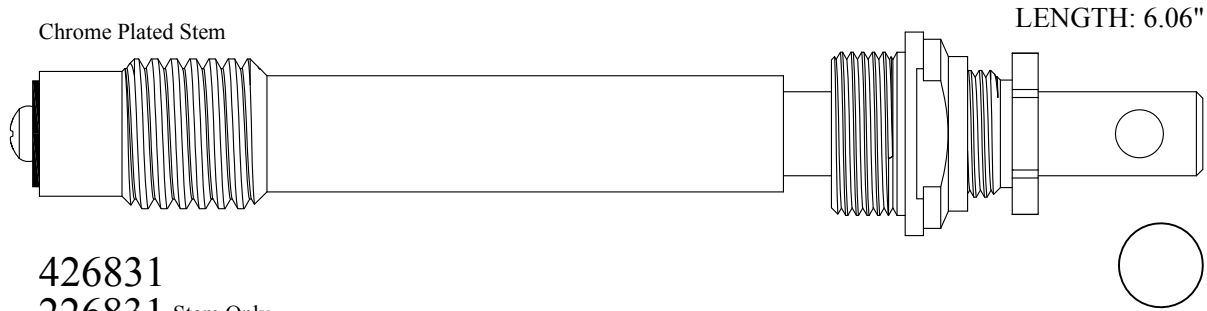

426831
226831 Stem Only
GASKET: 895180

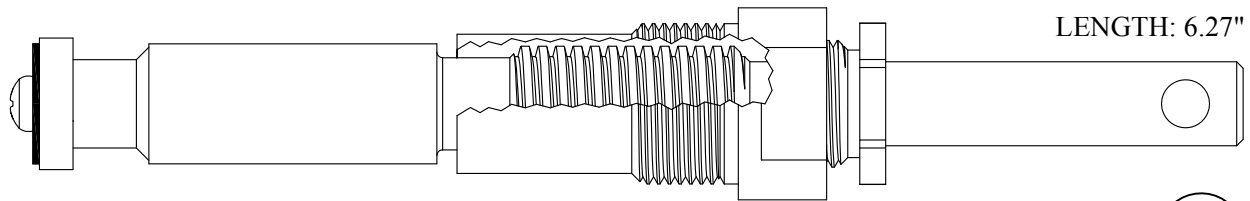

427121
227121 Stem Only
GASKET: 895380

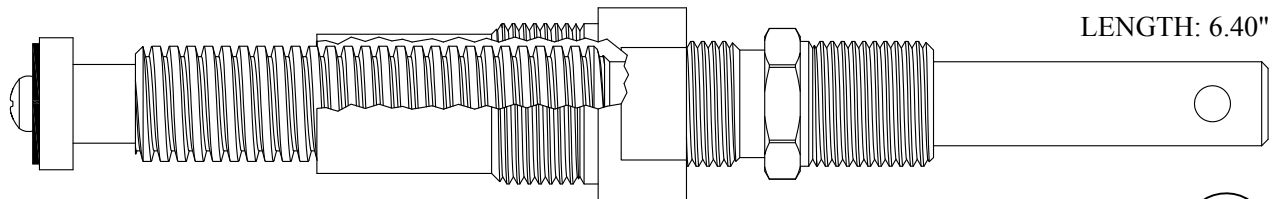

427131
227131 Stem Only
GASKET: 895380

FOR ILLINOIS

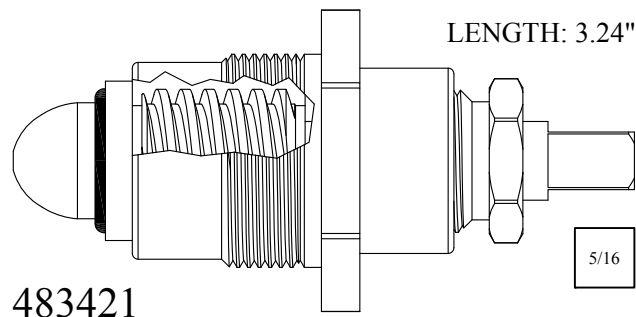

483421

FOR IMPORT

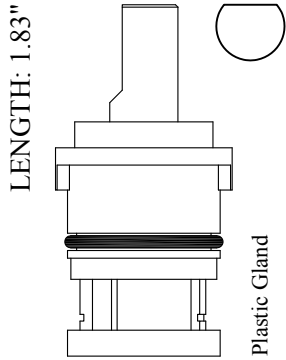

456211
456212

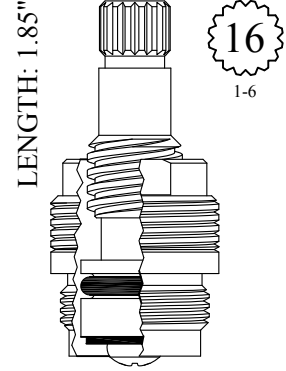
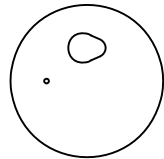

LF454051
LF454052

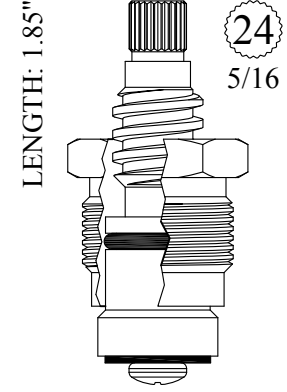

LF456141

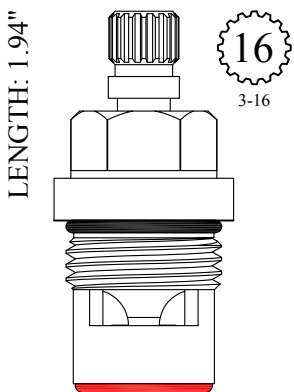

GASKET: 890170 O-RING INCLUDED
SEAL: 898570-R/B
DISC SET: 151380-PKG

LF458871
LF458872

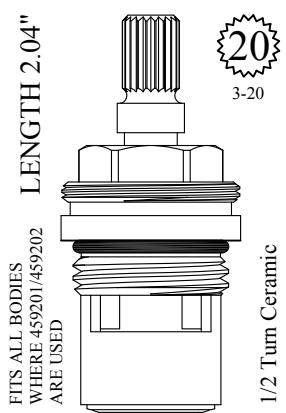

GASKET: 890170 O-RING INCLUDED
SEAL: 898510-W
DISC SET: 124290-PKG

LF459211
LF459212

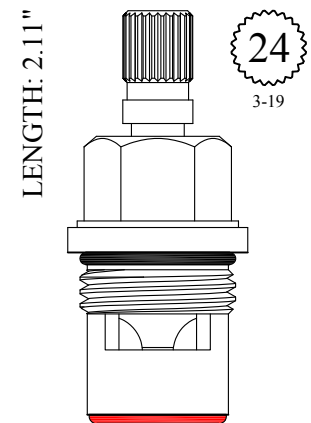

GASKET: 890170 O-RING INCLUDED
SEAL: 898570-R/B
DISC SET: 151380-PKG

LF459421
LF459422

FOR IMPORT

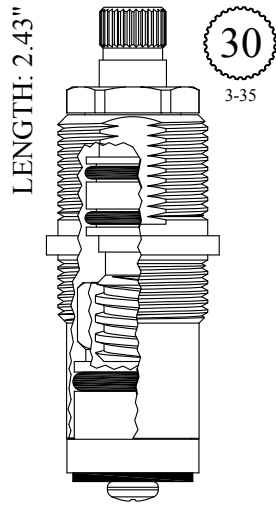

LF463302

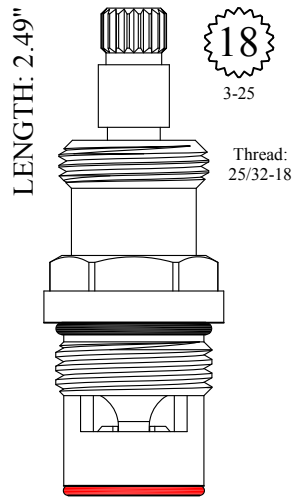

GASKET: 890170 O-RING INCLUDED
SEAL: 898580-R/B
DISC SET: 151380-PKG

LF401361
LF401362

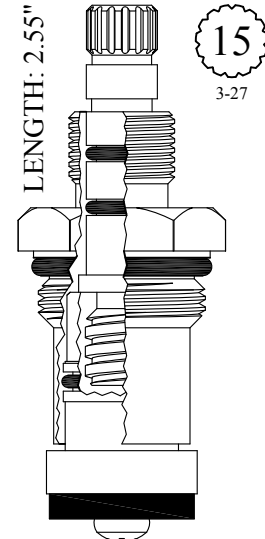

GASKET: 891160 INCLUDED

LF464391
LF464392

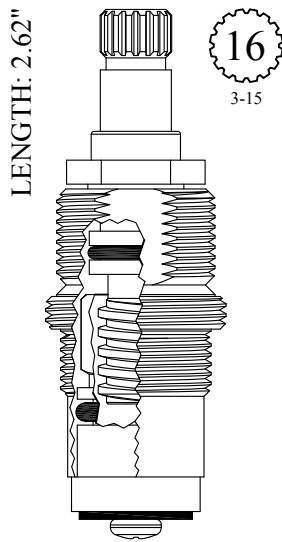

GASKET: 895140

LF464602

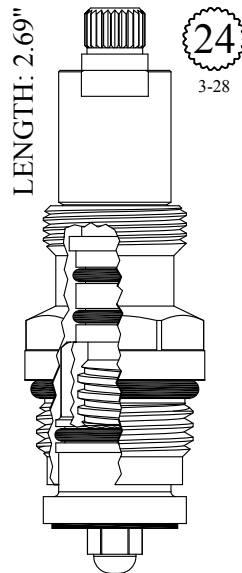

GASKET: 891150 INCLUDED

LF464712

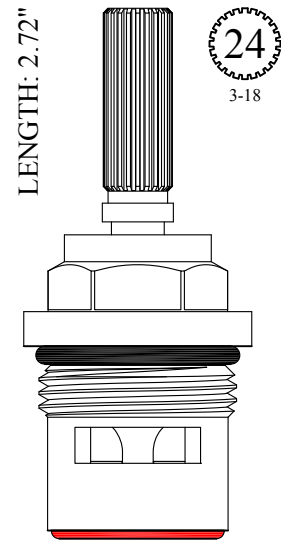

GASKET: 891180 O-RING INCLUDED
SEAL: 898610-R/B
DISC SET: 109850-PKG

401591
401592

FOR IMPORT

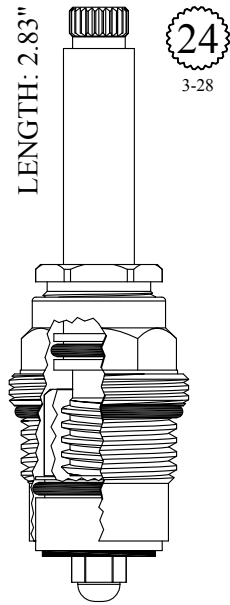

GASKET: 890180 INCLUDED

LF464962

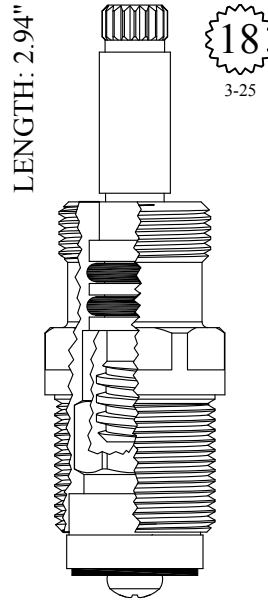

401722

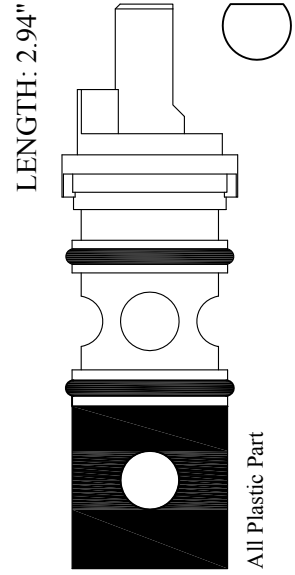

430160

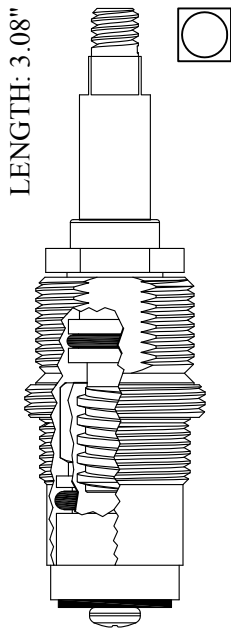

GASKET: 895160

LF466532

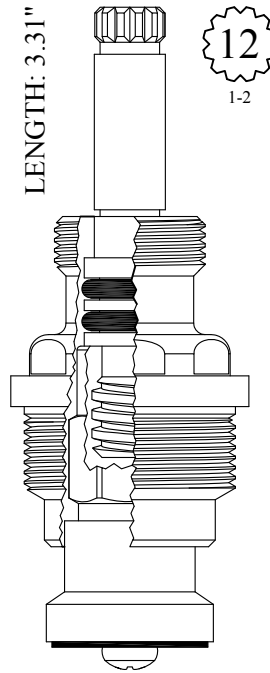

GASKET: 895450

402522

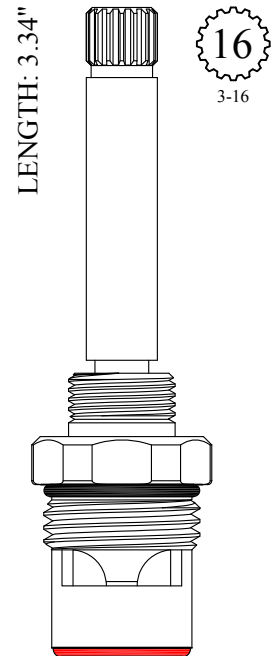

GASKET: 890170 O-RING INCLUDED
SEAL: 898570-R/B
DISC SET: 151380-PKG

LF402681
LF402682

FOR IMPORT

LENGTH: 3.35"

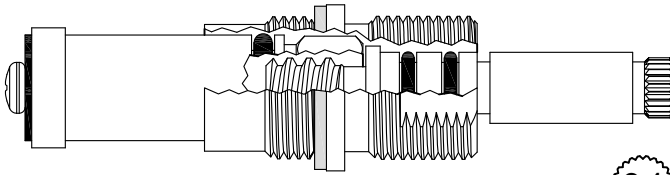

LF466822

GASKET: 895100

24

3-28

LENGTH: 4.47"

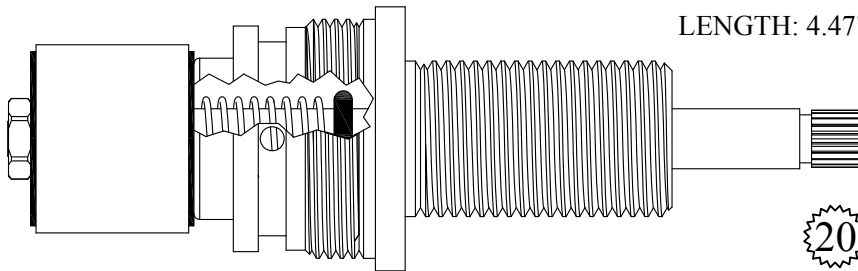

430490

20

3-20

BARRY E.  WALTER  SR. CO.

FOR INDIANA

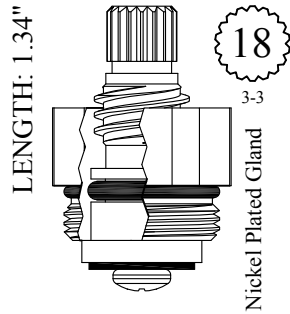

GASKET: 890170 O-RING INCLUDED

450971

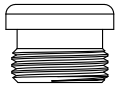

SEAT USED: LF648560

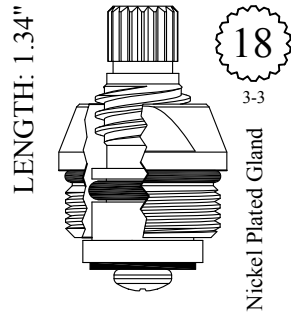

GASKET: 890170 O-RING INCLUDED

LF451011
LF451012

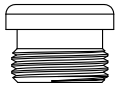

SEAT USED: LF648560

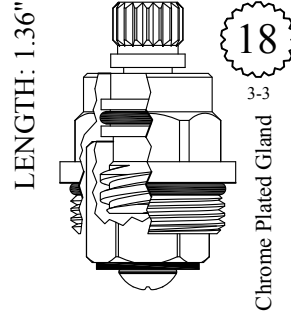

GASKET: 890170 O-RING INCLUDED

LF450501
LF450502

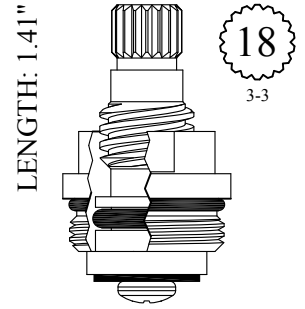

GASKET: 890170 O-RING INCLUDED

LF451121
LF451122

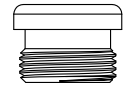

SEAT USED: LF648560

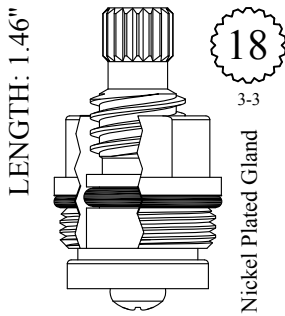

GASKET: 890180 O-RING INCLUDED

LF451141
LF451142

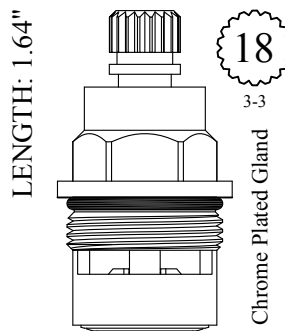

GASKET: 890170 O-RING INCLUDED
SEAL: 898510-W
DISC SET: 151380-PKG

LF451901
LF451902

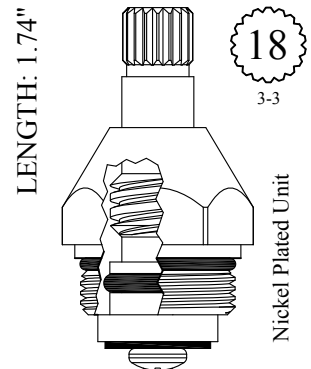

GASKET: 890170 O-RING INCLUDED

LF454031
LF454032

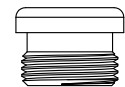

SEAT USED: LF648560

FOR INDIANA

LENGTH: 1.91"

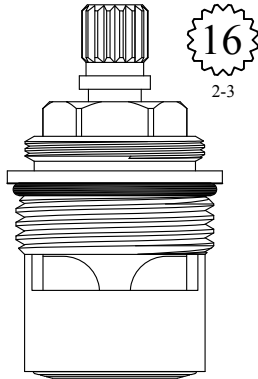

GASKET: 890210 O-RING INCLUDED
SEAL: 898520
DISC SET: 109850-PKG

400811
400812

LENGTH: 2.01"

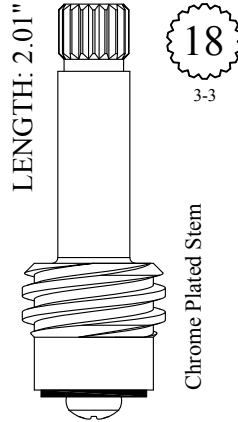

LF259031
LF259032



SEAT USED: LF648560

LENGTH: 2.28"

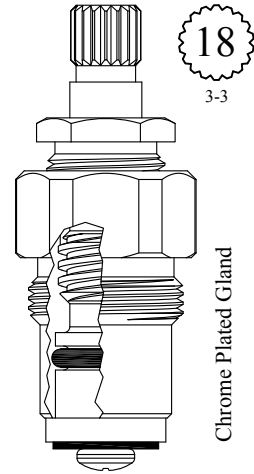

GASKET: 890170 O-RING INCLUDED

LF461951
LF461952

LENGTH: 2.41"

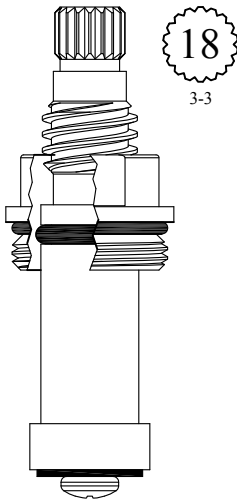

GASKET: 890170 O-RING INCLUDED

LF464131
LF464132



SEAT USED: LF648560

LENGTH: 2.69"

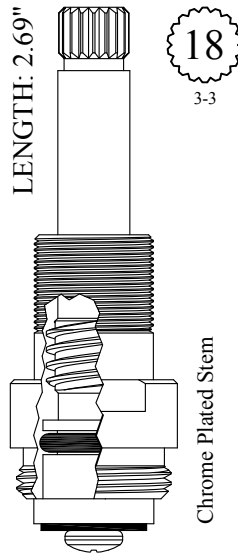

GASKET: 895150

LF465061
LF465062

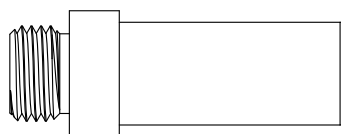

SEAT USED: LF649160

LENGTH: 2.95"

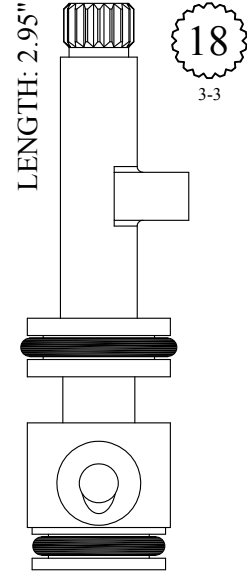

230030

FOR INDIANA

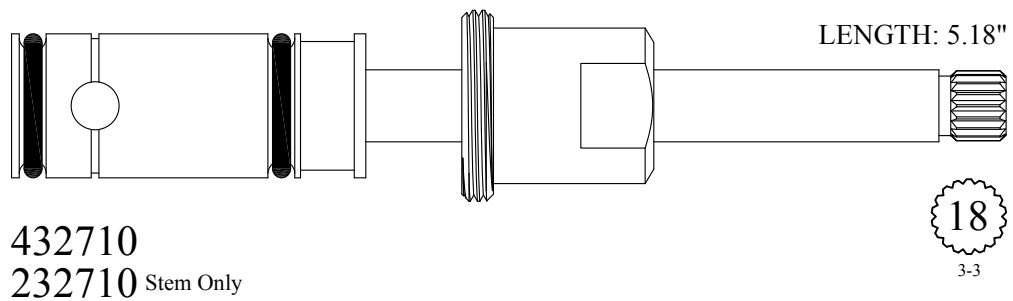
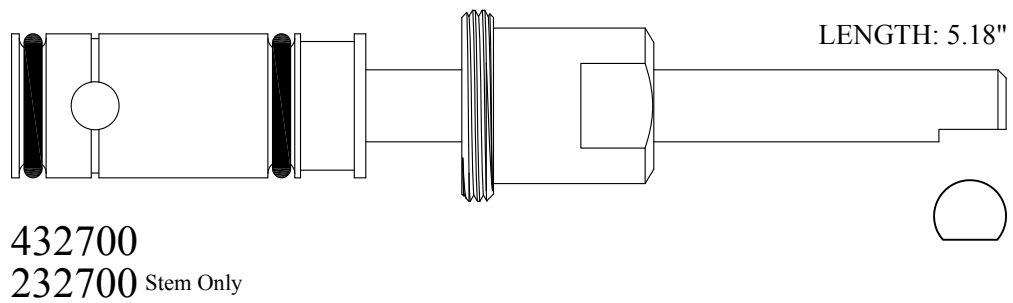
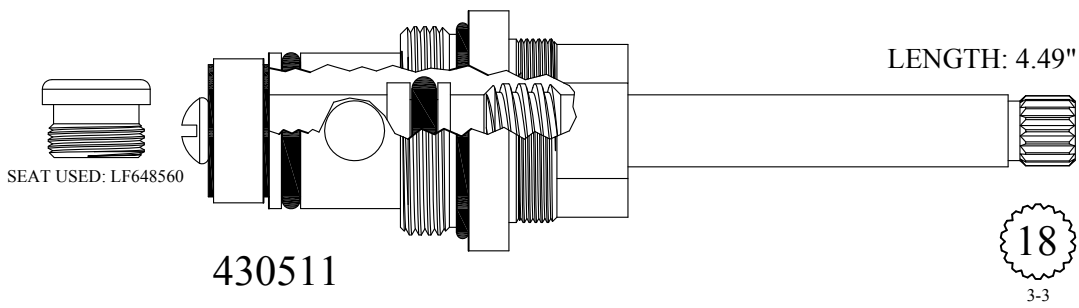
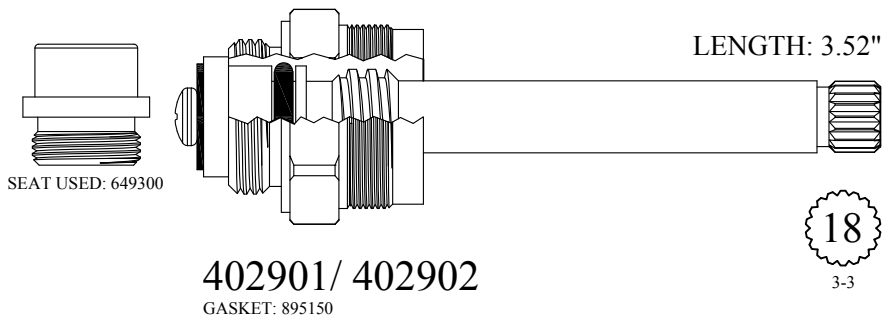

FOR INDIANA

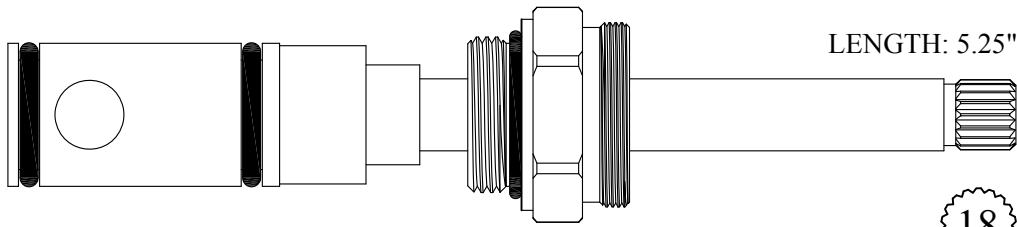

LENGTH: 5.25"

432730

232730 Stem Only

GASKET: 890180 O-RING INCLUDED

18
3-3

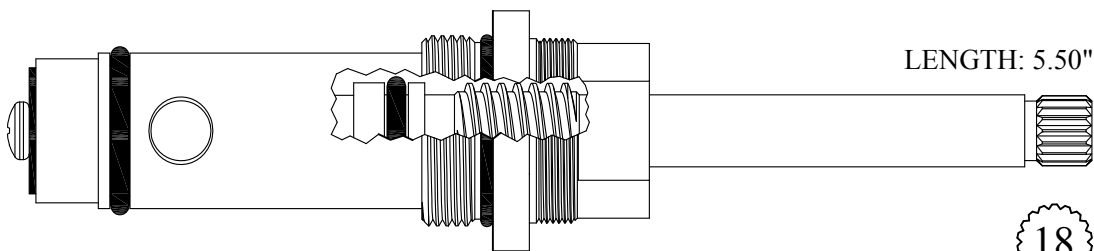

LENGTH: 5.50"

434301

GASKET: 890200 O-RING INCLUDED

18
3-3

Chrome Plated Stem

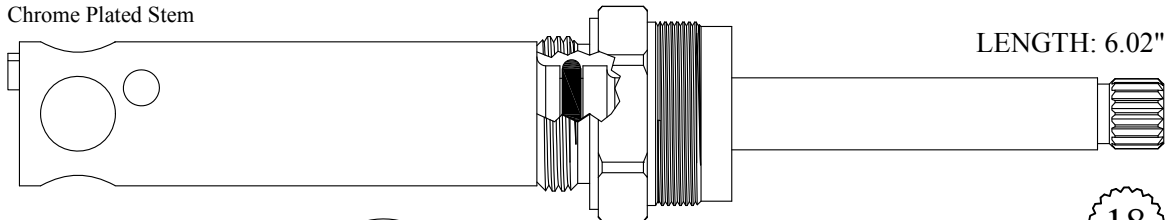

LENGTH: 6.02"

437700

237700 Stem Only

GASKET: 895150

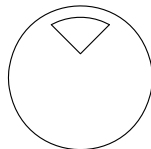

18
3-3

Chrome Plated Stem

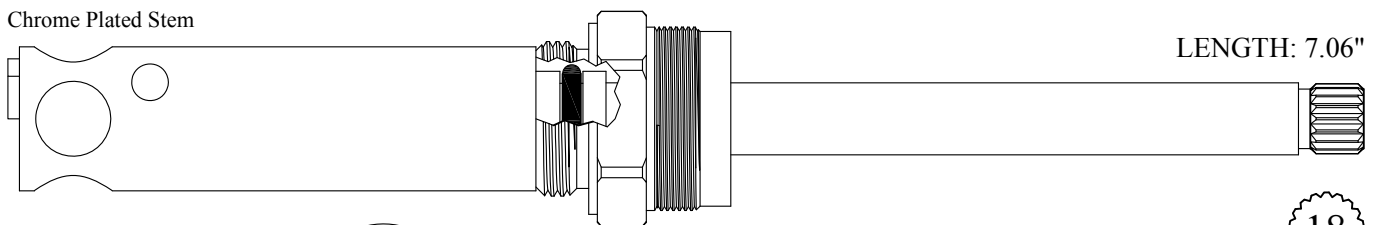

LENGTH: 7.06"

439520

239520 Stem Only

GASKET: 895150

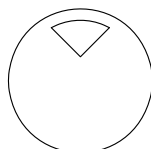

18
3-3

FOR I.W. INDUSTRIES

Wall and Deck Models

To identify a 4 or 5-Port Unit, look down the stem from the broach end at the dent bushing. Refer to the images below:

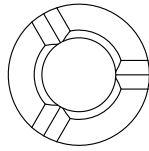

4-Port

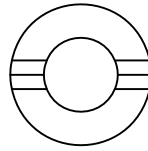

5-Port

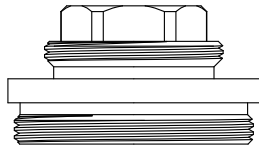

730560

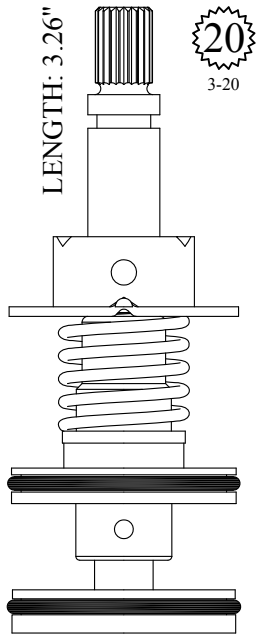

Wall Model	
4-Port	230560
5-Port	230570
W/ 730560 Bonnet	
4-Port	430560
5-Port	430570

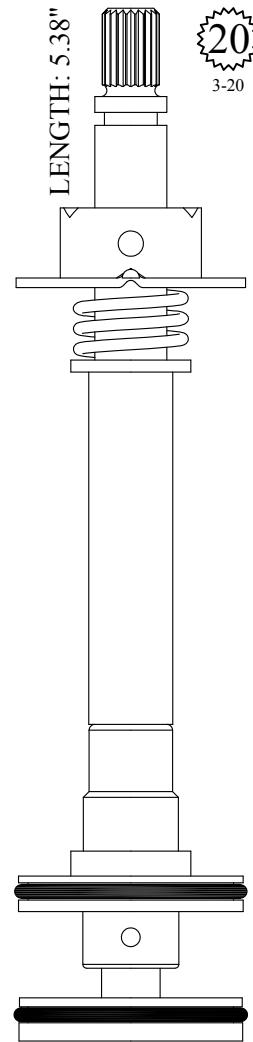

Deck Model	
4-Port	233980
5-Port	233990
W/ 730560 Bonnet	
4-Port	433980
5-Port	433990

FOR J.L. MOTT

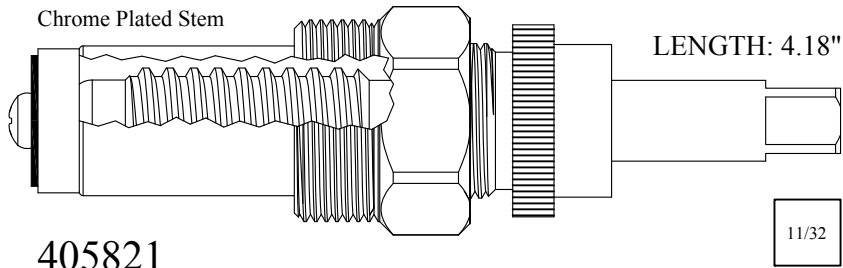

405821
205821 Stem Only
GASKET: 895160

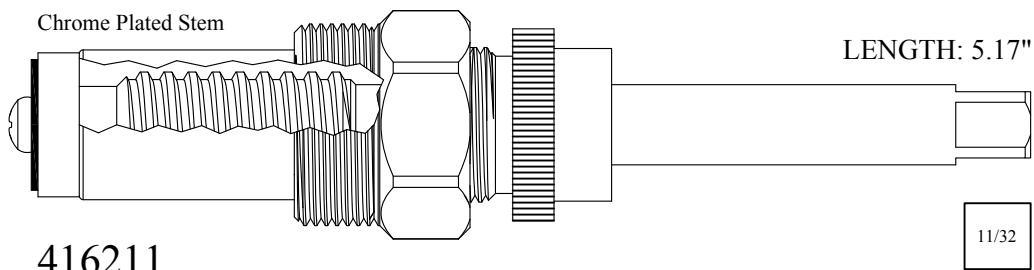

416211
216211 Stem Only
GASKET: 895160

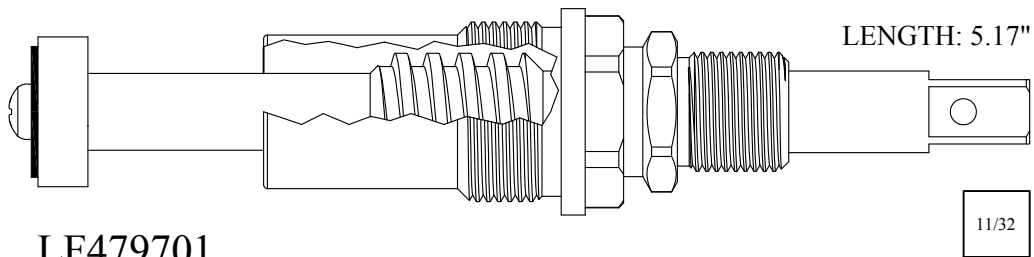

LF479701
LF279701 Stem Only
GASKET: 895320

BARRY E.  WALTER  SR. CO.

FOR JACLO

Chrome Plated Stem & Gland

LENGTH: 5.15"

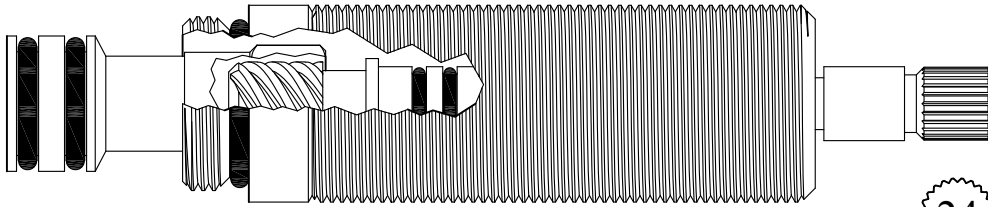

432431

GASKET: 891150 O-RING INCLUDED

24
3-19

Chrome Plated Stem & Gland

LENGTH: 5.15"

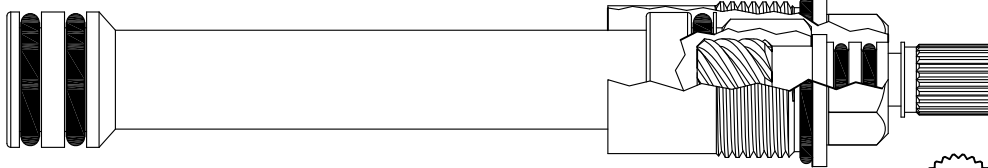

432511

GASKET: 890180 O-RING INCLUDED

24
3-19

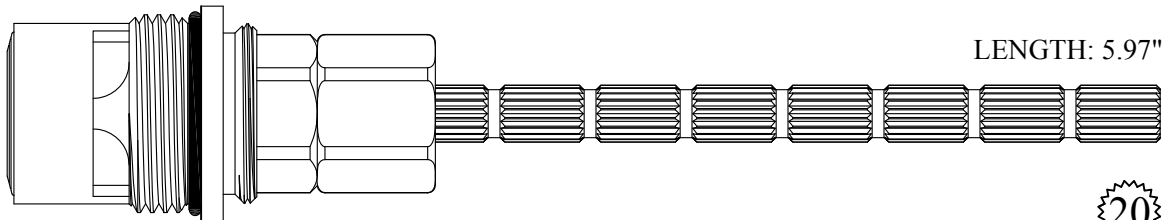

LENGTH: 5.97"

20
3-20

421681/ 421682

GASKET: 890210 O-RING INCLUDED
SEAL: 898520
DISC SET: 109850-PKG

Chrome Plated Gland

LENGTH: 7.15"

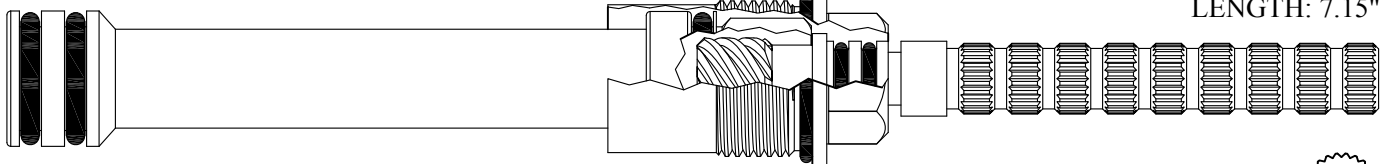

439421

GASKET: 890180 O-RING INCLUDED

24
3-19

FOR JACUZZI

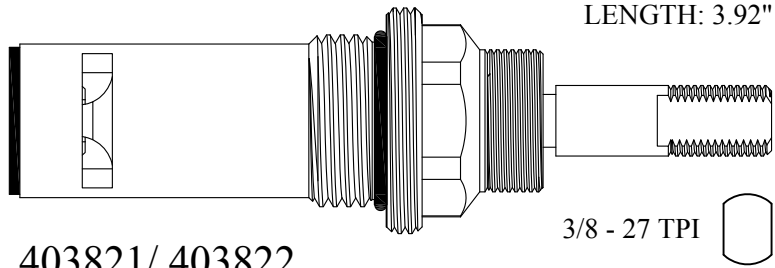

403821/ 403822

GASKET: 890190 O-RING INCLUDED
SEAL: 898550
DISC SET: 151380-PKG

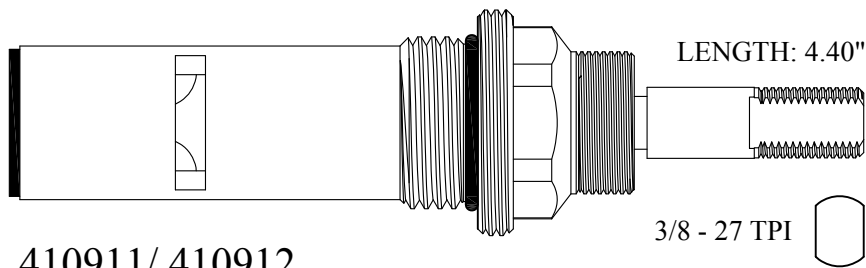

410911/ 410912

GASKET: 890190 O-RING INCLUDED
SEAL: 898550
DISC SET: 151380-PKG

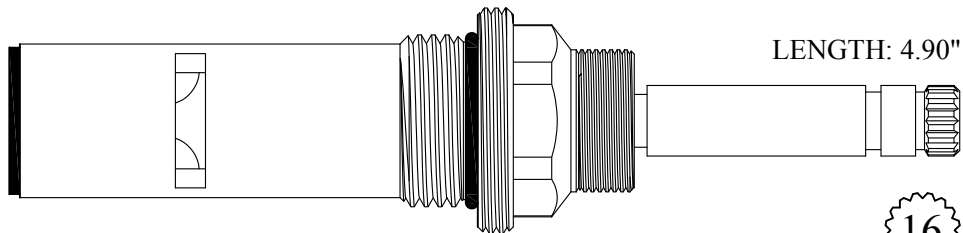

410921/ 410922

GASKET: 890190 O-RING INCLUDED
SEAL: 898550
DISC SET: 151380-PKG

16
1-6

BARRY E.  WALTER  SR. CO.

FOR JADO

LENGTH: 2.10"

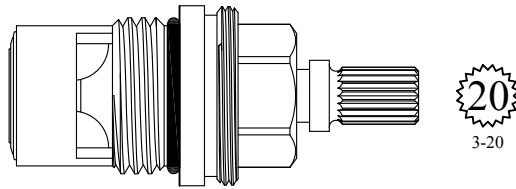

LF459301/ LF459302

GASKET: 890170 O-RING INCLUDED
SEAL: 898510-W
DISC SET: 151380-PKG

LENGTH: 2.22"

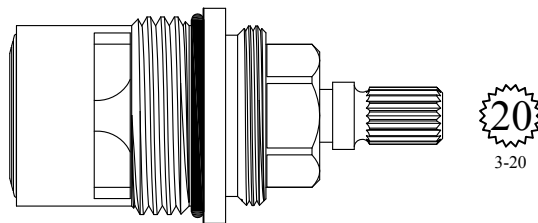

401161/ 401162

GASKET: 890210 O-RING INCLUDED
SEAL: 898520
DISC SET: 109850-PKG

LENGTH: 3.46"

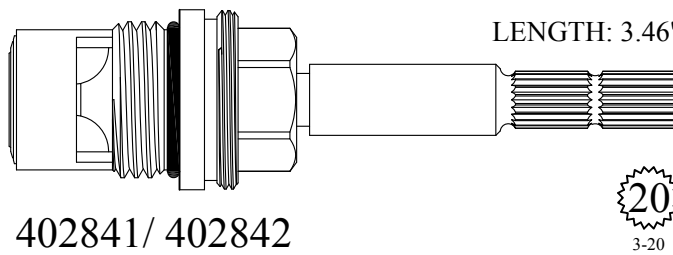

402841/ 402842

GASKET: 890170 O-RING INCLUDED
SEAL: 898510-W
DISC SET: 151380-PKG

LENGTH: 3.59"

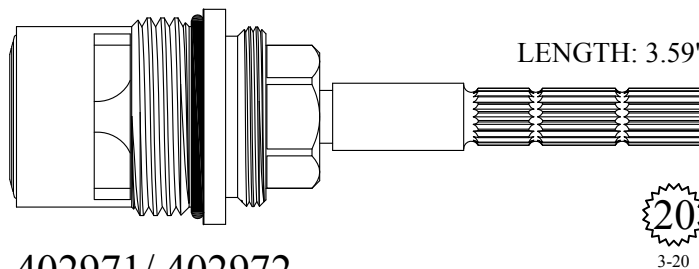

402971/ 402972

GASKET: 890210 O-RING INCLUDED
SEAL: 898520
DISC SET: 109850-PKG

FOR JAMECO

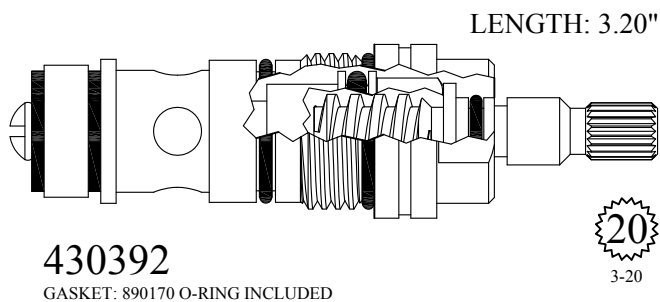

430392

GASKET: 890170 O-RING INCLUDED

20
3-20

FOR KALLISTA

Comes with handle screw:
899230

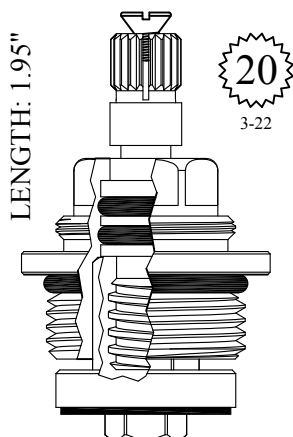

GASKET: 891180 O-RING INCLUDED

401072

Comes with handle screw:
899230

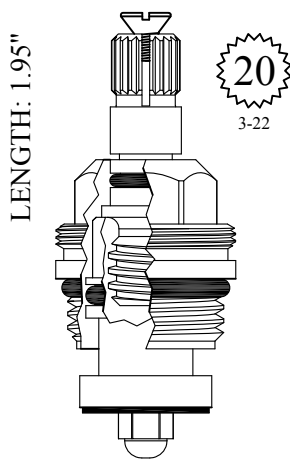

GASKET: 891150 O-RING INCLUDED

LF458502

Comes with handle screw:
899230

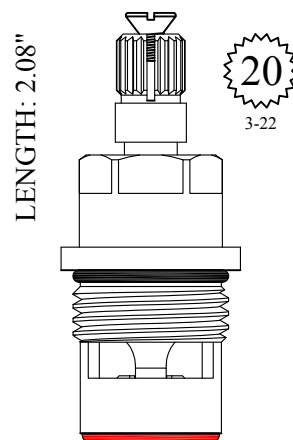

GASKET: 890170 O-RING INCLUDED
SEAL: 898570-R/B
DISC SET: 151380-PKG

LF459401
LF459402

FOR KALLISTA

Comes with handle screw:
899230

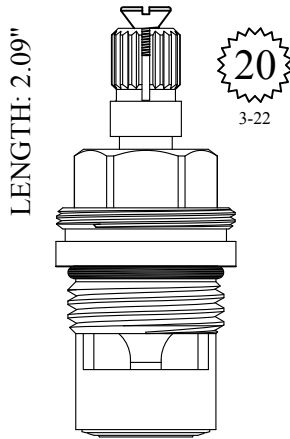

GASKET: 890170 O-RING INCLUDED
SEAL: 898510-W
DISC SET: 151380-PKG

LF459391
LF459392

Comes with handle screw:
899230

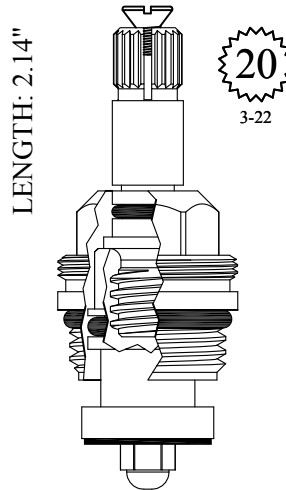

GASKET: 891150 O-RING INCLUDED

LF459801
LF459802

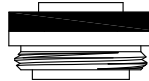

SEAT USED: LF648850-M

Comes with handle screw:
899230

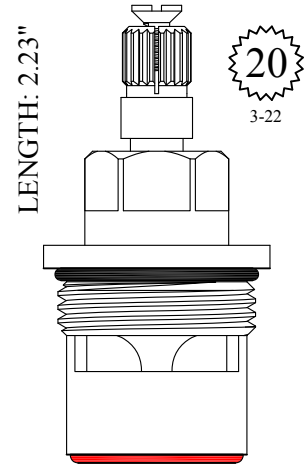

GASKET: 890210 O-RING INCLUDED
SEAL: 898610-R/B
DISC SET: 109850-PKG

401091
401092

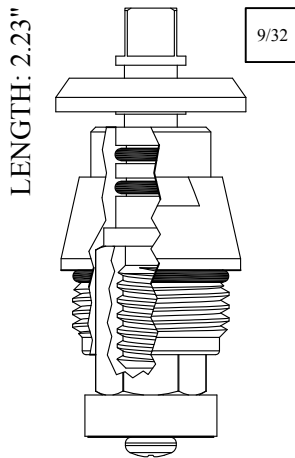

GASKET: 890170 O-RING INCLUDED

LF460652

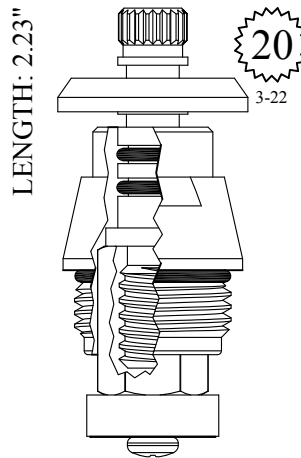

GASKET: 890170 O-RING INCLUDED

LF460672

Comes with handle screw:
899230

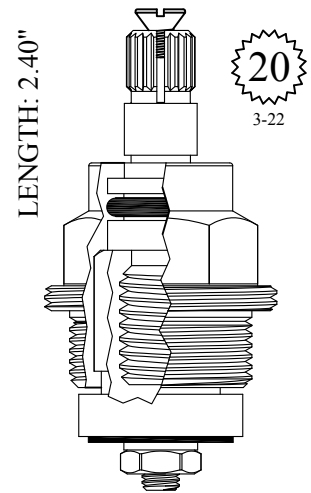

GASKET: 895350

LF463602

FOR KALLISTA

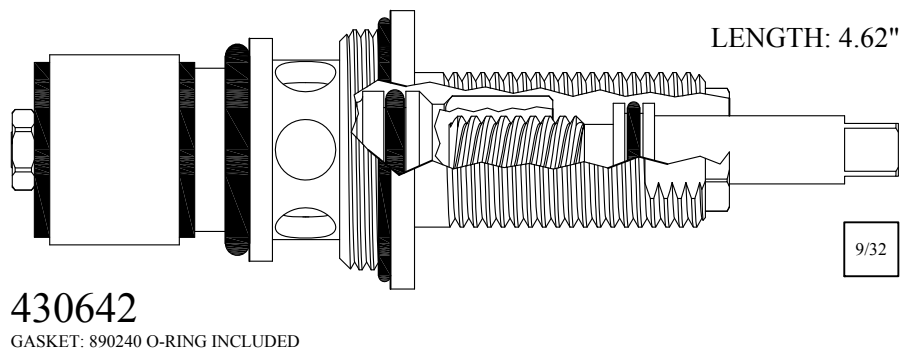
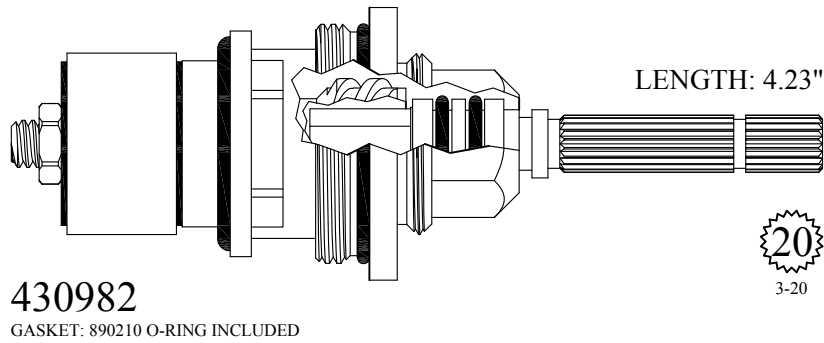
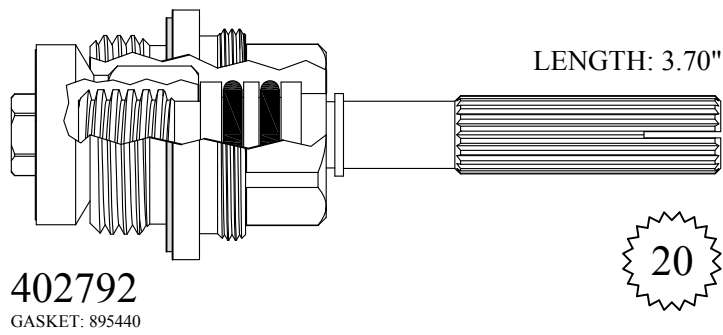
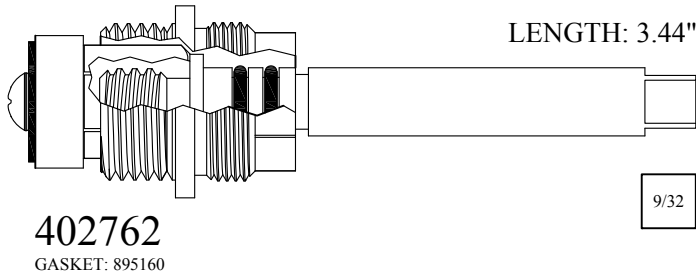

FOR KALLISTA

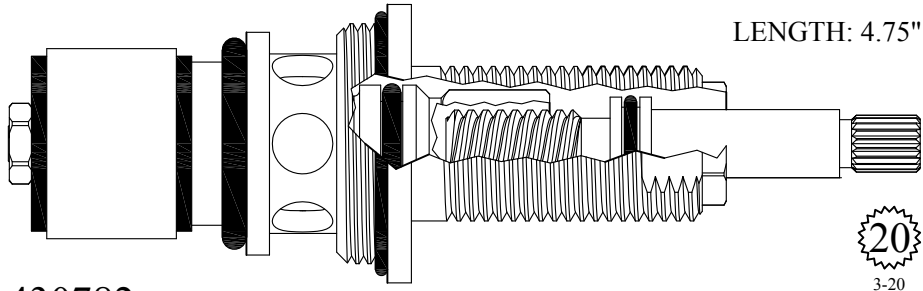

430782

GASKET: 890240 O-RING INCLUDED

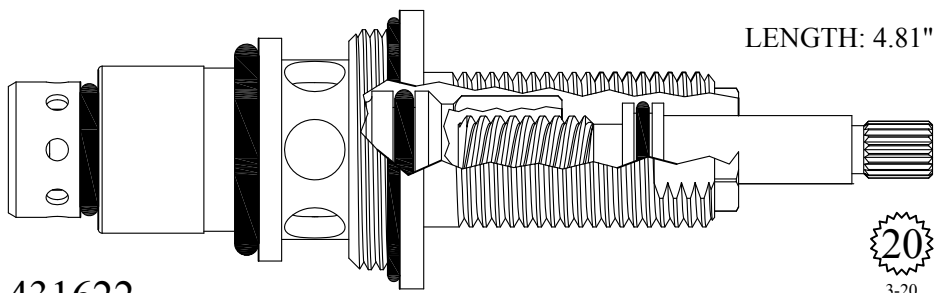

431622

GASKET: 890240 O-RING INCLUDED

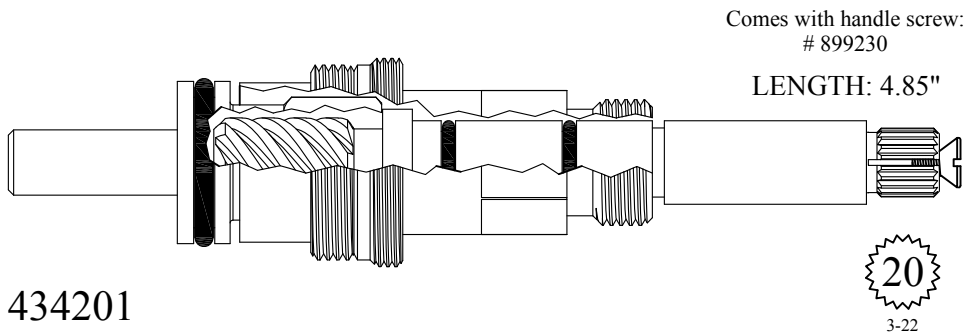

434201

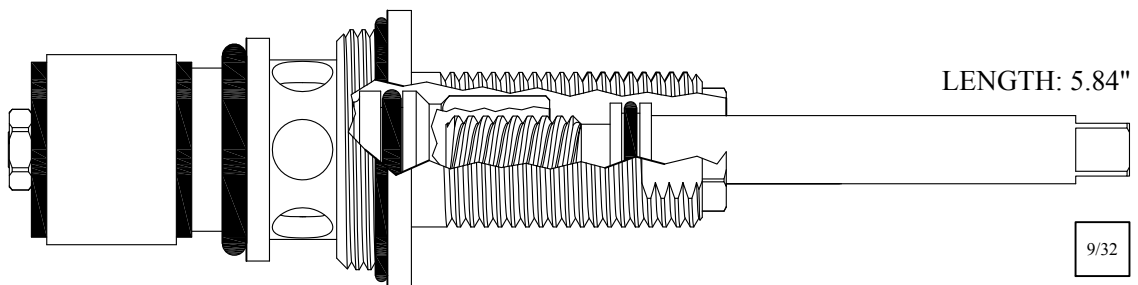

437112

GASKET: 890240 O-RING INCLUDED

FOR KALLISTA

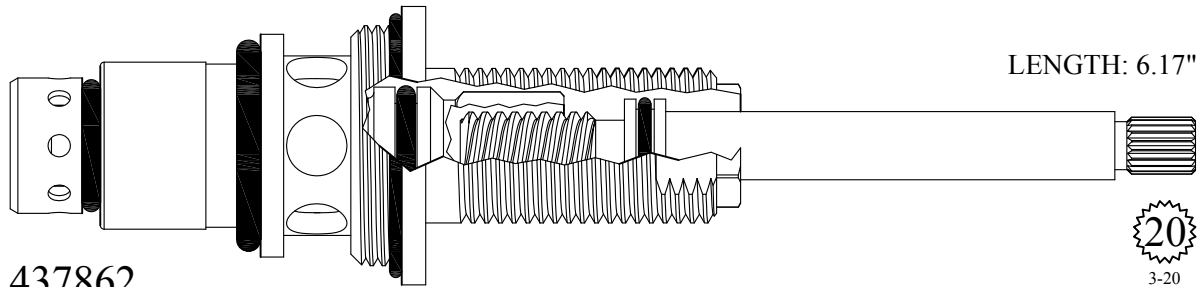

437862

GASKET: 890240 O-RNG INCLUDED

FOR KINGSBURY

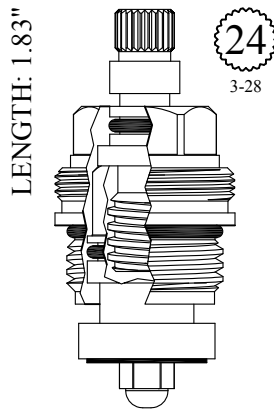

GASKET: 890170 O-RING INCLUDED

LF455972

FOR KINGSTON BRASS

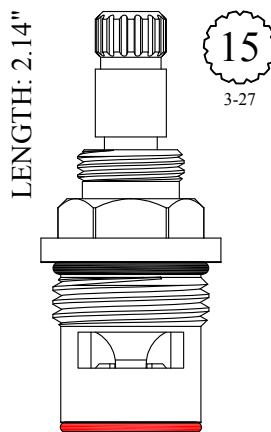

GASKET: 890170 O-RING INCLUDED

SEAL: 898580-R/B

DISC SET: 151380-PKG

LF459711

LF459712

Send Your Orders To:

BARRY E.  SR. CO.

E-mail: orderdesk@barrywalter.com

Fax: 1.800.886.9831

Phone: 1.800.767.5552

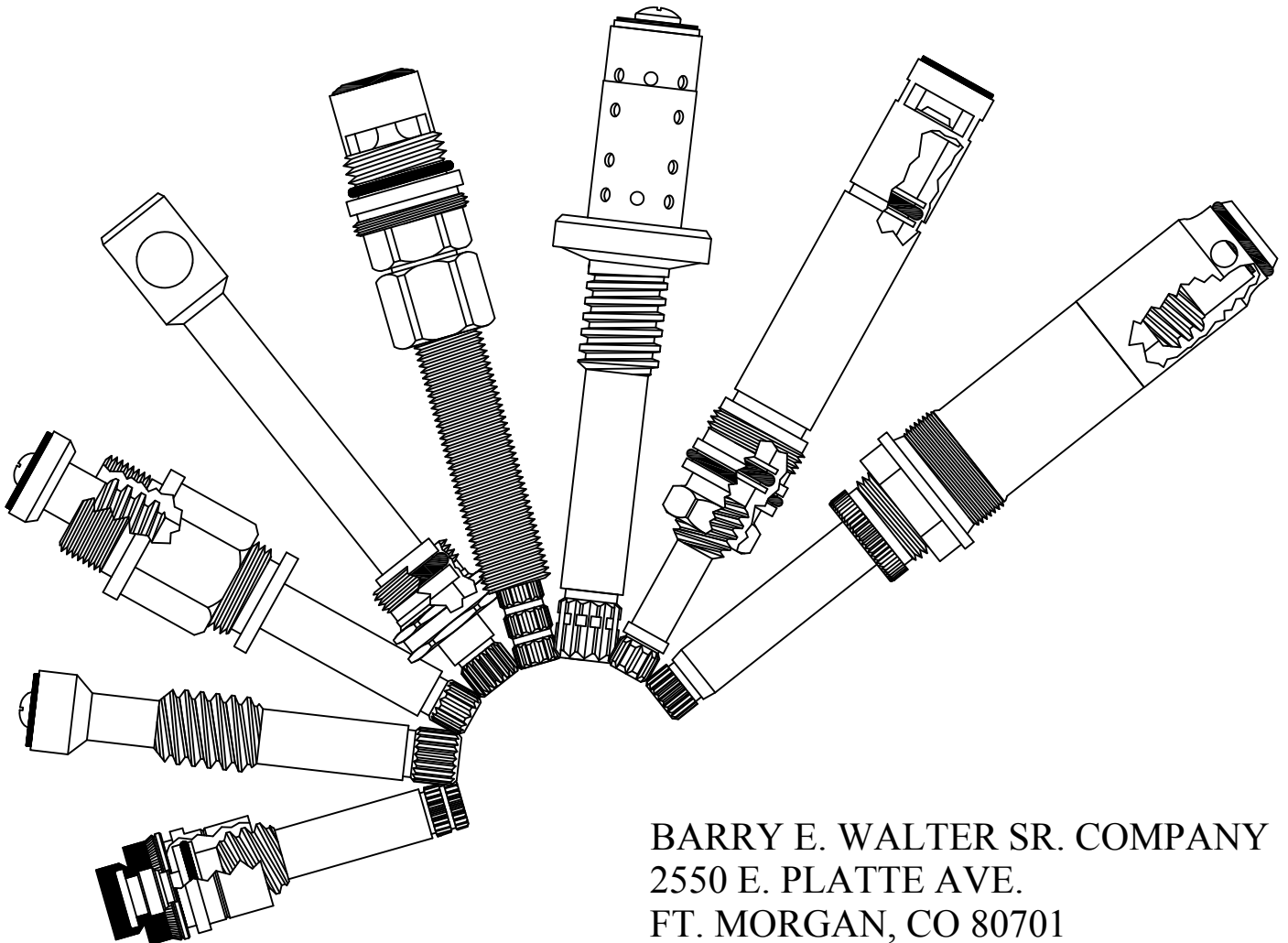

BARRY E. WALTER SR. COMPANY
2550 E. PLATTE AVE.
FT. MORGAN, CO 80701

*We are always adding
new parts. Check our
website for updates.*

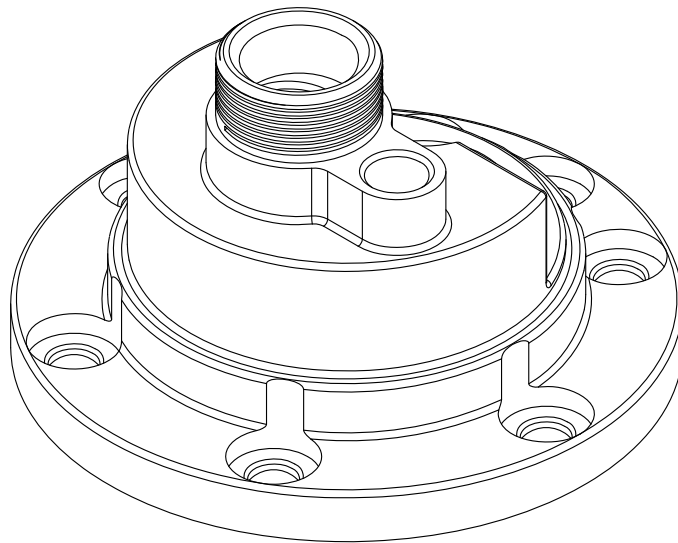

FOR SPEAKMAN G06-0021

BARRY E.  ALTER  SR. CO.

FOR KOHLER

LENGTH: 1.37"

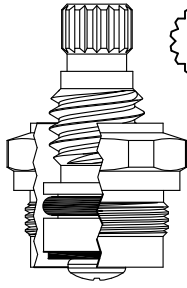

16

1-6
Nickel Plated Gland

GASKET: 895100

LF450051
LF450052



SEAT USED: LF648070

LENGTH: 1.80"

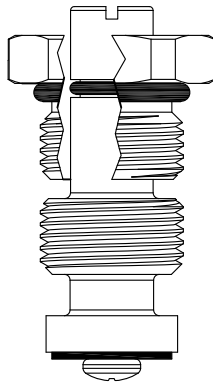

GASKET: 891140 O-RING INCLUDED

400921
200921 Stem Only

LENGTH: 1.94"

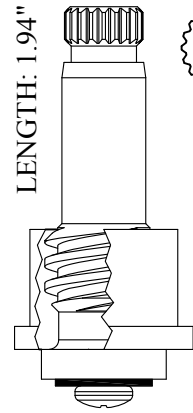

19

1-7

Chrome Plated Stem

LF458041
LF458042
LF258041 Stem Only
LF258042 Stem Only



SEAT USED: LF647230

LENGTH: 1.94"

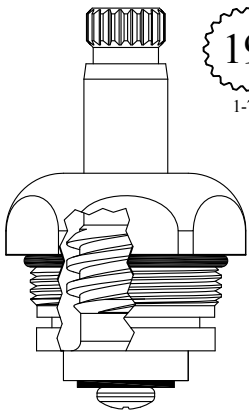

19

1-7

Chrome Plated Stem & Bonnet

GASKET: 890210 O-RING INCLUDED

LF458241
LF458242
LF258041 Stem Only
LF258042 Stem Only

LENGTH: 1.98"

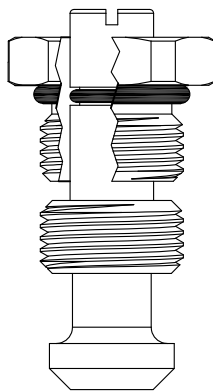

GASKET: 891140 O-RING INCLUDED

400911
200911 Stem Only

LENGTH: 2.00"

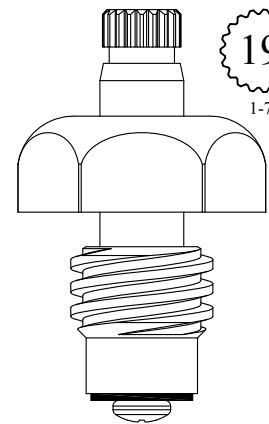

19

1-7

Chrome Plated Unit

LF459041
LF459042
LF259041 Stem Only
LF259042 Stem Only



SEAT USED: LF648730

FOR KOHLER

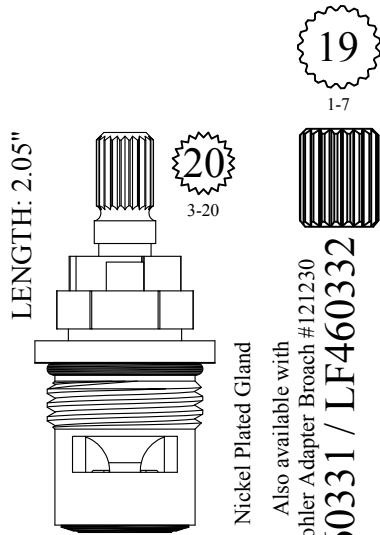

GASKET: 890170 O-RING INCLUDED
SEAL: 898510
DISC SET: 151380-PKG

LF459331
LF459332

Nickel Plated Gland
Also available with
19pt Kohler Adapter Broach #121230
LF460331 / LF460332

CERAMIC CONVERSION FOR LF459101/2
LENGTH: 2.12"

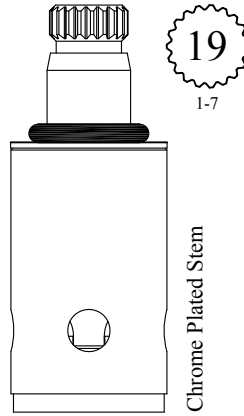

DISC SET: 151380-PKG

LF459601
LF459602

Chrome Plated Stem

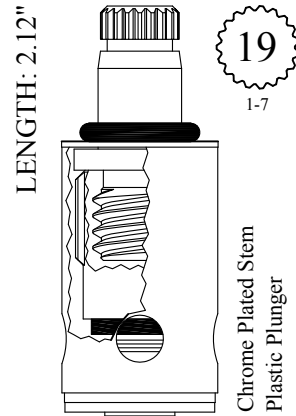

SEAT: LF649460 INCLUDED

LF459101
LF459102
LF259101 Stem Only
LF259102 Stem Only

Chrome Plated Stem
Plastic Plunger
Also available with
Brass Plunger

LF459101-B / LF459102-B

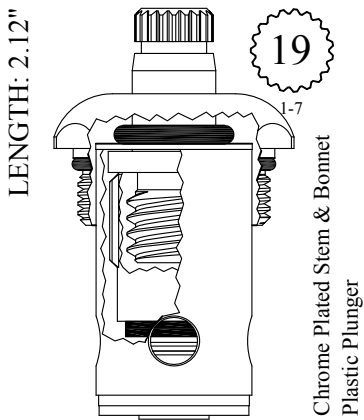

GASKET: 890210 O-RING INCLUDED
SEAT: LF649460 INCLUDED

LF459141
LF459142
LF259101 Stem Only
LF259102 Stem Only

Chrome Plated Stem & Bonnet
Plastic Plunger

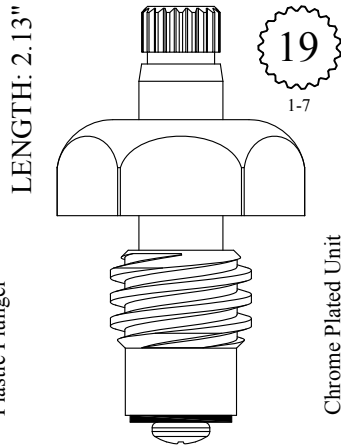

Chrome Plated Unit

LF460161
LF460162
LF260161 Stem Only
LF260162 Stem Only

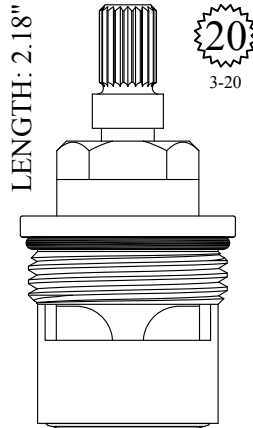

GASKET: 890210 O-RING INCLUDED
SEAL: 898520
DISC SET: 109850-PKG

401271
401272

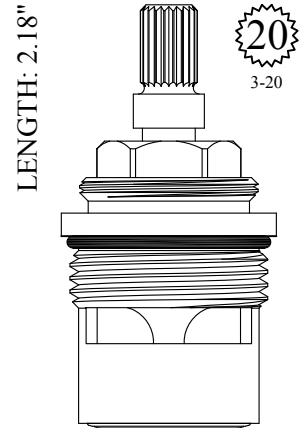

GASKET: 890210 O-RING INCLUDED
SEAL: 898520
DISC SET: 109850-PKG

401121
401122

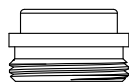

SEAT USED: LF648730

FOR KOHLER

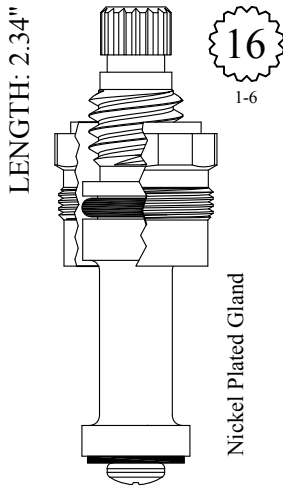

GASKET: 895060

LF462101
LF462102



SEAT USED: LF648070

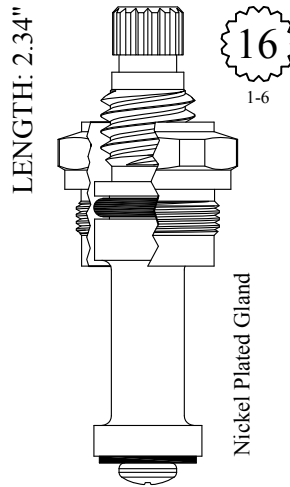

GASKET: 895060

LF462141
LF462142



SEAT USED: LF648070

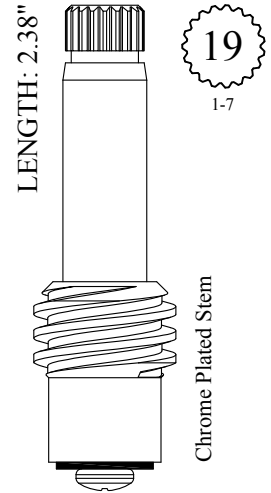

LF263151
LF263152



SEAT USED: LF647230

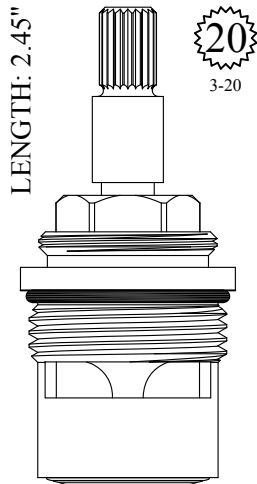

GASKET: 890210 O-RING INCLUDED
SEAL: 898520
DISC SET: 109850-PKG

401291
401292

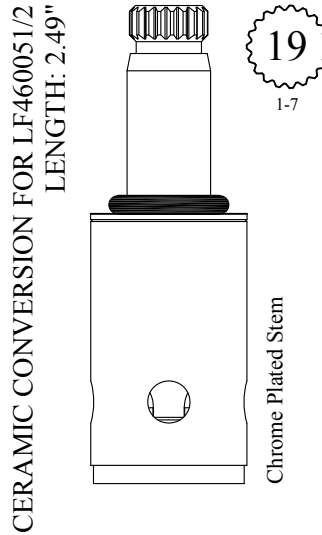

DISC SET: 151380-PKG

LF463811
LF463812

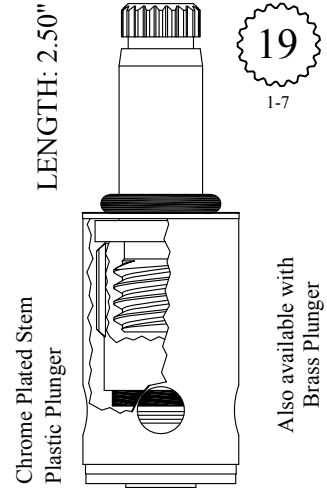

SEAT INCLUDED:
LF649460

LF460051
LF460052

LF260051 Stem Only
LF260052 Stem Only

LF460051-B / LF460052-B

FOR KOHLER

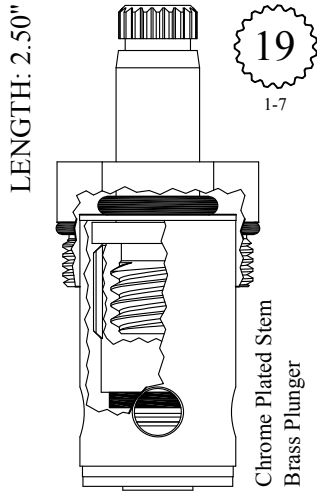

GASKET: 890210 O-RING INCLUDED
SEAT INCLUDED: LF649460

LF460251-B
LF460252-B
LF260051 Stem Only
LF260052 Stem Only

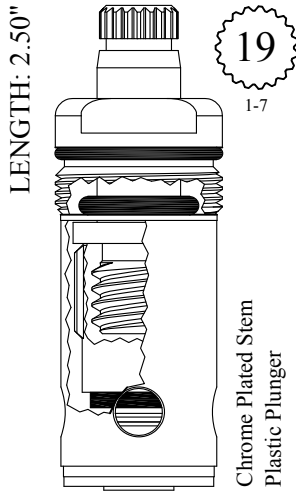

GASKET: 890180 O-RING INCLUDED
SEAT INCLUDED: LF649460

LF460261
LF460262
LF260051 Stem Only
LF260052 Stem Only

Also available with
Brass Plunger

LF460261-B / LF460262-B

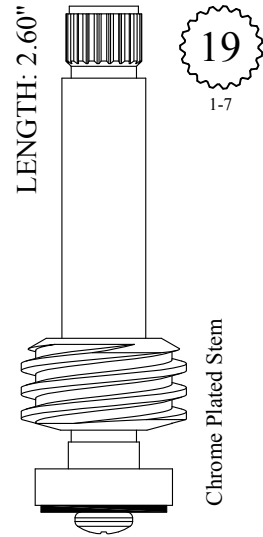

LF264321

Extension Available
#135000

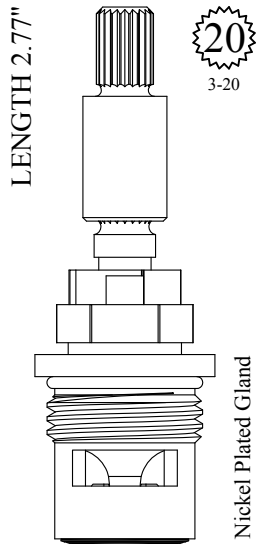

GASKET: 890170 O-RING INCLUDED
SEAL: 898510
DISC SET: 151380-PKG

LF464941

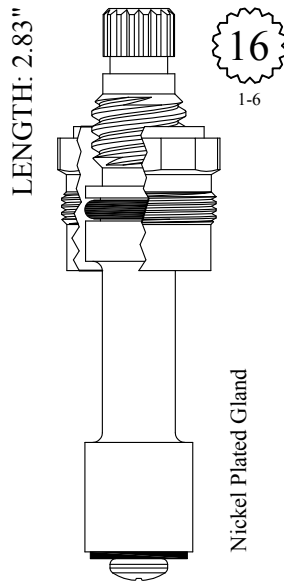

GASKET: 895060

LF465131
LF465132



SEAT USED: LF648070

Extension Available
#135000

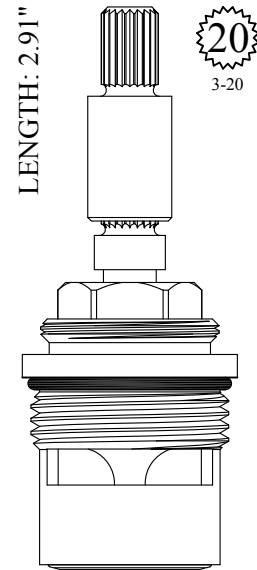

GASKET: 890210 O-RING INCLUDED
SEAL: 898520
DISC SET: 109850-PKG

401671
401672

FOR KOHLER

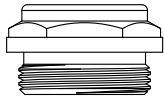

SEAT USED: 647220

Triple Lead

LENGTH: 3.05"

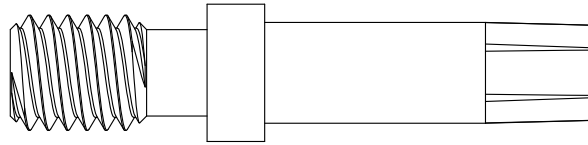

202171

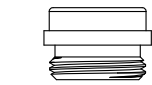
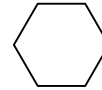

SEAT USED: LF649390

Chrome Plated Stem

LENGTH: 3.07"

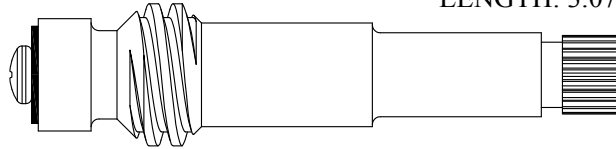

LF265651/ LF265652

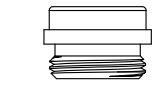

SEAT USED: LF649390

Chrome Plated Unit

LENGTH: 3.33"

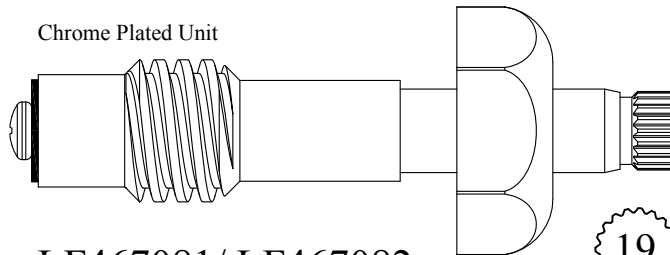

LF467081/ LF467082
LF267081/ LF267082

Stem Only

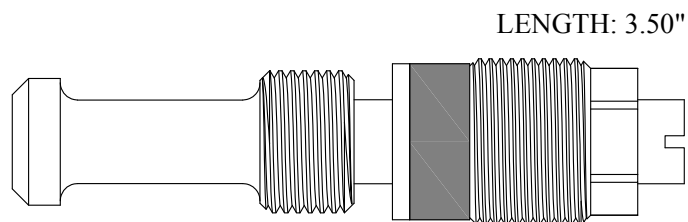

LENGTH: 3.50"

402991

202991 Stem Only

FOR KOHLER



SEAT USED: 647220

Triple Lead

LENGTH: 3.62"

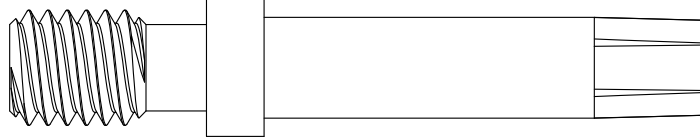

202941

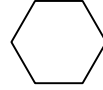

SEAT USED: LF648730

Chrome Plated Stem

LENGTH: 3.87"

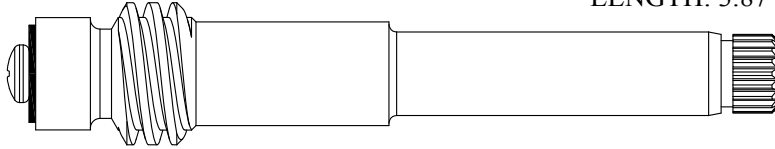

LF269081/ LF269082



1-7

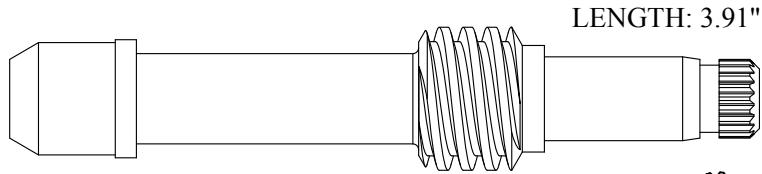

LENGTH: 3.91"

231151



1-7



SEAT USED: 647190

Triple Lead
Chrome Plated Stem

LENGTH: 3.95"

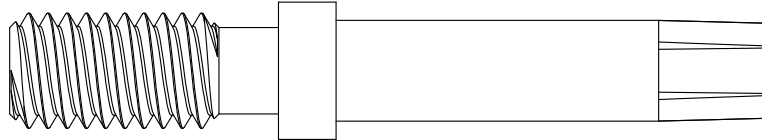

203211

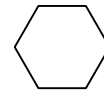

CERAMIC CONVERSION FOR KOHLER TREND
LENGTH: 4.24"

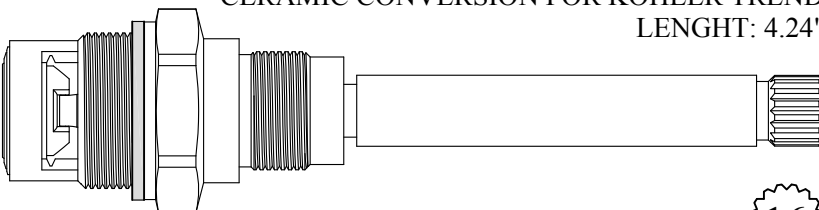

404821/ 404822

GASKET: 895150 INCLUDED
SEAL: 898510-W
DISC SET: 151380-PKG



1-6

FOR KOHLER

Chrome Plated Stem / Plastic Plunger

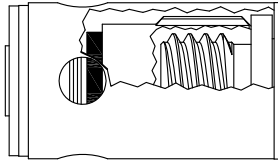

LENGTH: 4.24"



1-7

LF470701/ LF470702
LF270701/ LF270702 Stem Only
 SEAT INCLUDED: LF649460

Also available with Brass Plunger
LF470701-B / LF470702-B

Also available with Brass Plunger &
 Polished Gold stem

LF470701-PG / LF470702-PG
LF270701-PG / LF270702-PG Stem Only

Chrome Plated Stem / Plastic Plunger

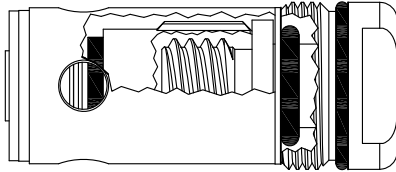

LENGTH: 4.24"



1-7

LF470711/ LF470712
LF270701/ LF270702 Stem Only
 GASKET: 890180 O-RING INCLUDED
 SEAT INCLUDED: LF649460

Also available with Brass Plunger
LF470711-B / LF470712-B

Also available with Brass Plunger &
 Polished Gold stem

LF470711-PG / LF470712-PG
LF270701-PG / LF270702-PG Stem Only

Chrome Plated Stem / Plastic Plunger

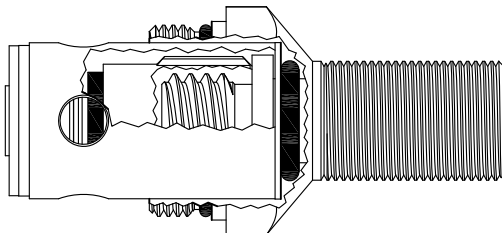

LENGTH: 4.24"



1-7

LF470721/ LF470722
LF270701/ LF270702 Stem Only
 GASKET: 890200 O-RING INCLUDED
 SEAT INCLUDED: LF649460

Also available with Brass Plunger
LF470721-B / LF470722-B

Also available with Brass Plunger &
 Polished Gold stem

LF470721-PG / LF470722-PG
LF270701-PG / LF270702-PG Stem Only

CERAMIC CONVERSION FOR KOHLER LF470701/2

Chrome Plated Stem

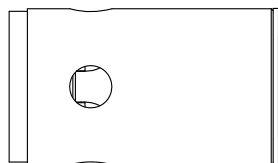

LENGTH: 4.25"



1-7

LF470741/ LF470742
 DISC SET: 151380-PKG

Also available with a Polished Gold Stem
LF470741-PG / LF470742-PG

FOR KOHLER



SEAT USED: LF648070

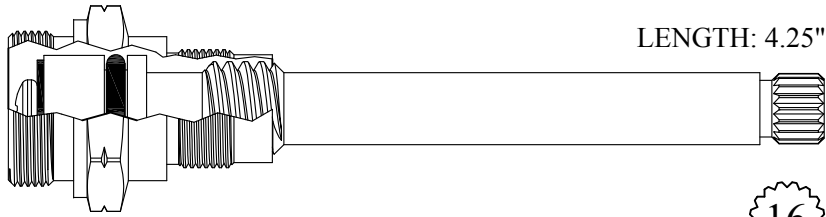

LENGTH: 4.25"

404331/ 404332
204201/ 204202 Stem Only
GASKET: 895150



SEAT USED: LF648070

Chrome Plated Escutcheon Tube #111460

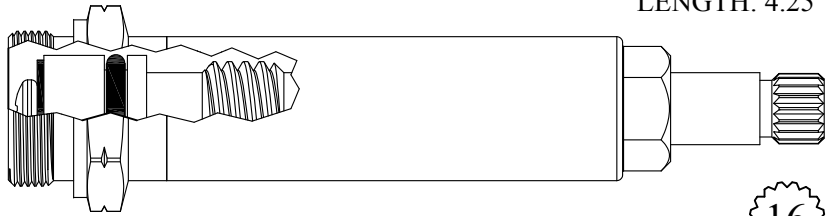

LENGTH: 4.25"

404201/ 404202
204201/ 204202 Stem Only
GASKET: 895150



SEAT USED: LF648070

Plastic Escutcheon Nipple #119040

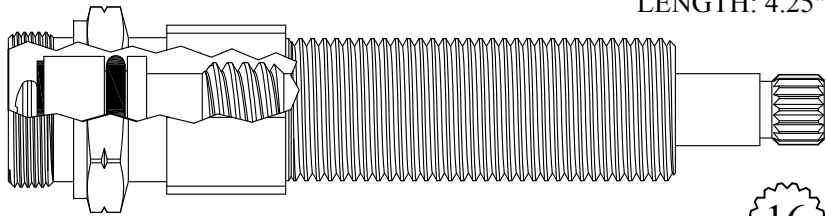

LENGTH: 4.25"

404231/ 404232
204201/ 204202 Stem Only
GASKET: 895150



Quadruple Lead
Chrome Plated Stem

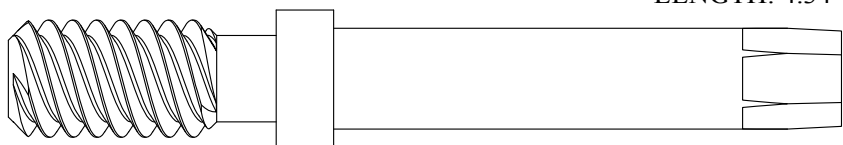

LENGTH: 4.34"

206161

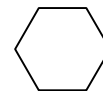

FOR KOHLER

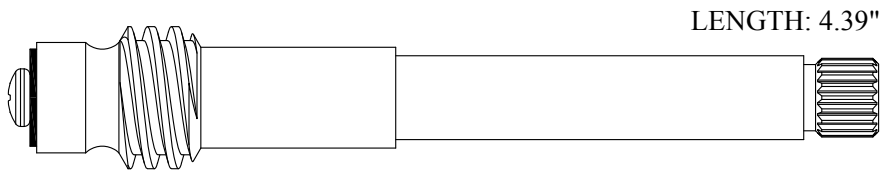

LENGTH: 4.39"

LF273361/ LF273362

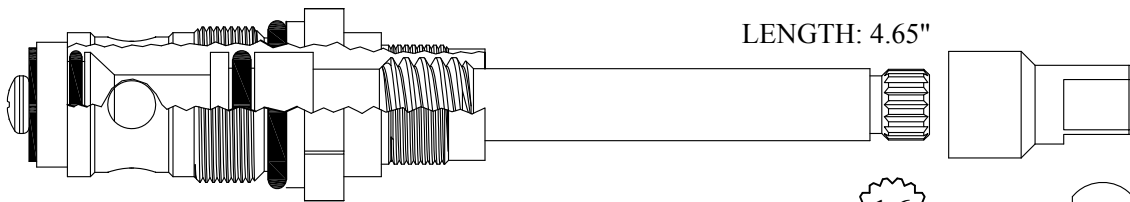

LENGTH: 4.65"

433121

GASKET: 891150 O-RING INCLUDED



Also available with seat LF648070

LF433121-S

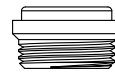

Plastic Escutcheon Nipple

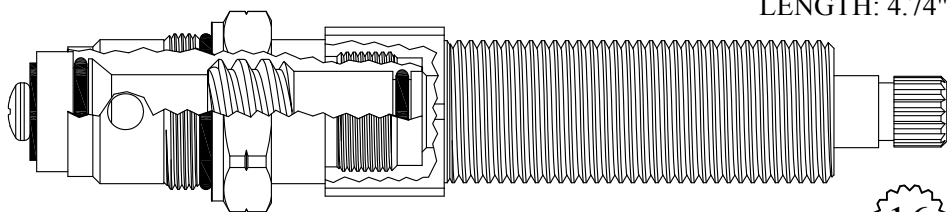

LENGTH: 4.74"

430941

GASKET: 890170 O-RING INCLUDED



Chrome Plated Stem

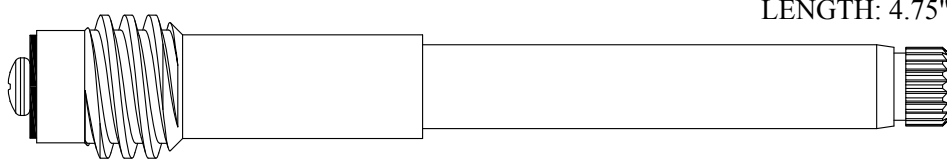

LENGTH: 4.75"

LF276011/ LF276012



FOR KOHLER

LENGTH: 4.89"

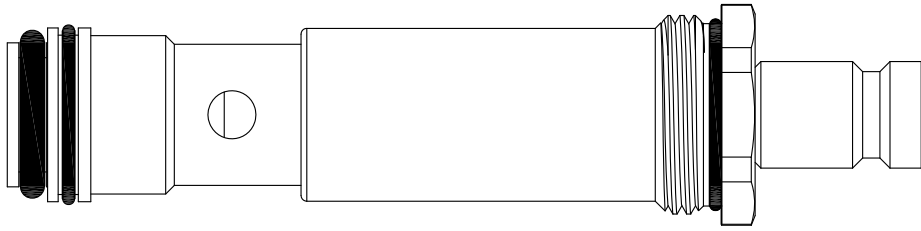

436180

GASKET: 890200 O-RING INCLUDED

Chrome Plated Stem

CERAMIC CONVERSION FOR KOHLER 407001/2

LENGTH: 4.90"

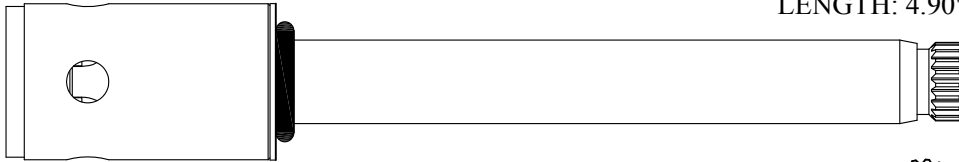

407041/ 407042

DISC SET: 151380-PKG

Also available with gold plated stem

407041-PG/ 407042-PG



Chrome Plated Stem

LENGTH: 5.00"

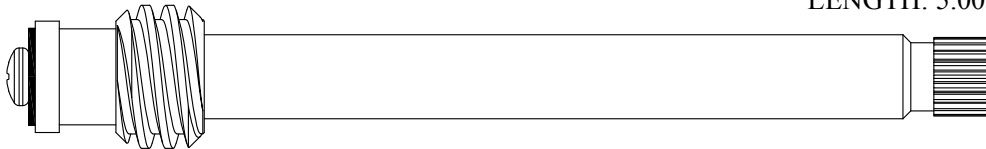

LF277051/ LF277052



Chrome Plated Stem / Plastic Plunger

LENGTH: 5.04"

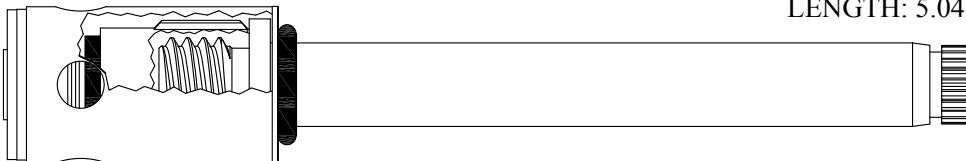

407001/ 407002

207001/ 207002 Stem Only

SEAT: LF649460 INCLUDED

Also available with Brass Plunger
407001-B / 407002-B

Also available with Brass Plunger &
Polished Gold stem

407001-PG / 407002-PG



FOR KOHLER

Chrome Plated Stem / Plastic Plunger

LENGTH: 5.04"

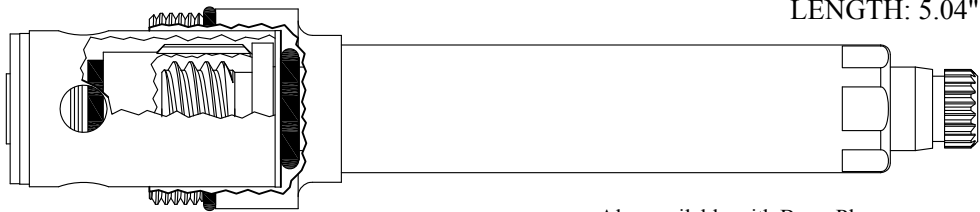

19
1-7

407021/ 407022
207001/ 207002 Stem Only

GASKET: 890210 O-RING INCLUDED
SEAT: LF649460 INCLUDED

Also available with Brass Plunger
407021-B / 407022-B

Chrome Plated Stem / Plastic Plunger

LENGTH: 5.04"

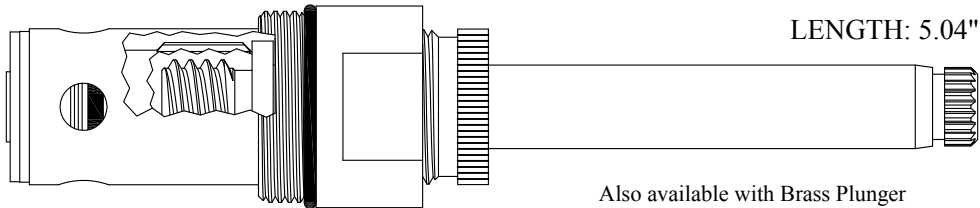

19
1-7

407031/ 407032
207001/ 207002 Stem Only

GASKET: 890210 O-RING INCLUDED
SEAT: LF649460 INCLUDED

Also available with Brass Plunger
407031-B / 407032-B
Also available with Brass Plunger &
Polished Gold stem
407031-PG / 407032-PG

Chrome Plated Stem / Brass Plunger

LENGTH: 5.04"

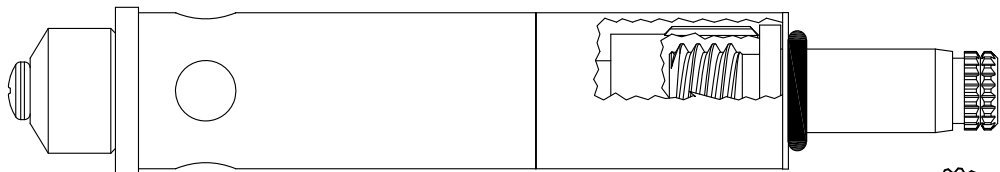

19
1-7

431412

Chrome Plated Stem / Brass Plunger

LENGTH: 5.04"

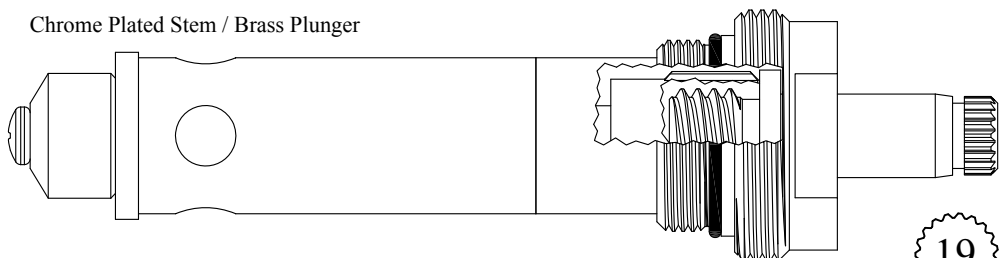

19
1-7

431422

GASKET: 890210 O-RING INCLUDED

FOR KOHLER

Plastic Escutcheon Nipple

LENGTH: 5.08"

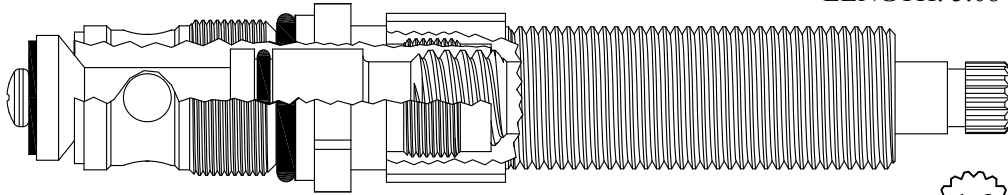

433171

GASKET: 891150 O-RING INCLUDED

16
1-6

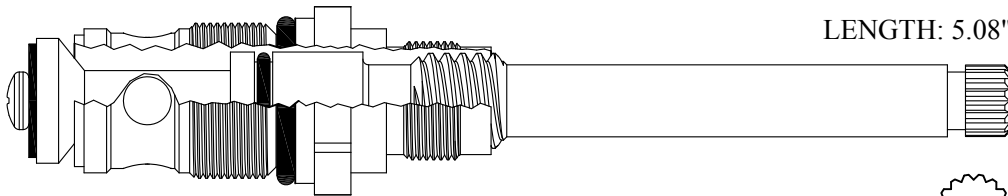

LENGTH: 5.08"

433181

GASKET: 891150 O-RING INCLUDED

16
1-6

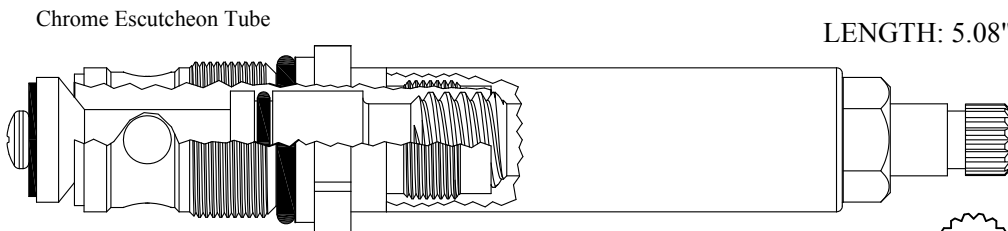

LENGTH: 5.08"

433191

GASKET: 891150 O-RING INCLUDED

16
1-6

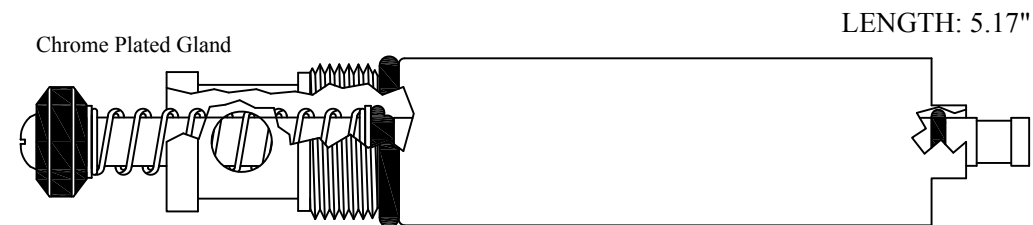

LENGTH: 5.17"

Chrome Plated Gland

432810

GASKET: 891150 O-RING INCLUDED

FOR KOHLER

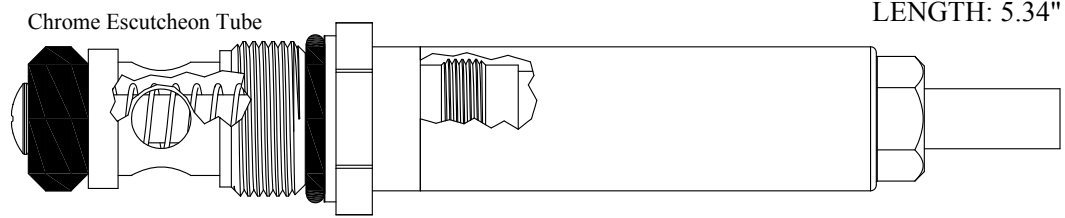

432910

GASKET: 891150 O-RING INCLUDED

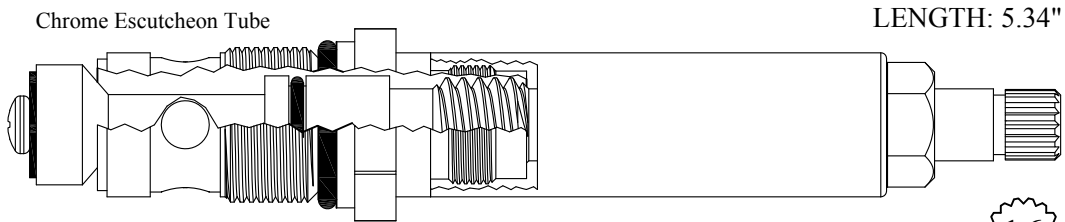

433211

GASKET: 891150 O-RING INCLUDED

16
1-6

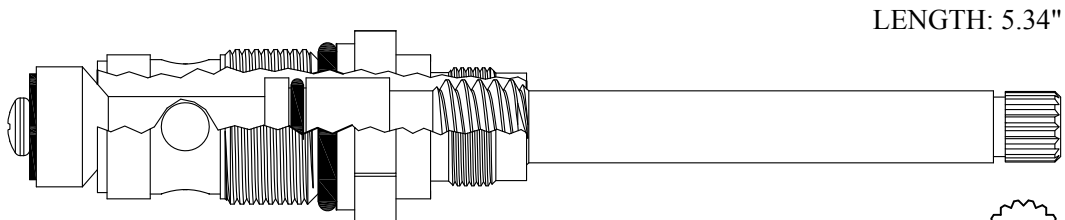

433231

GASKET: 891150 O-RING INCLUDED

16
1-6

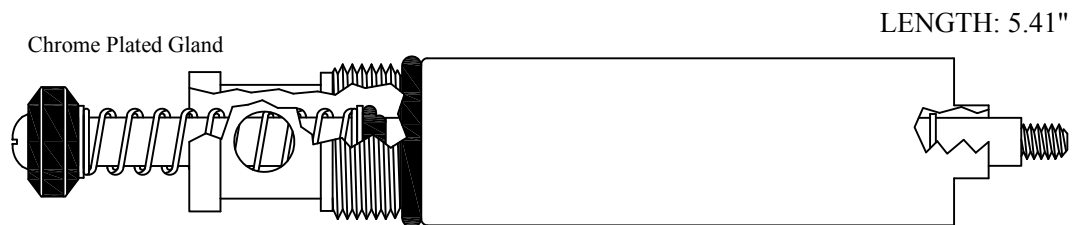

432830

GASKET: 891150 O-RING INCLUDED

FOR KOHLER

Chrome Plated Stem

LENGTH: 5.50"

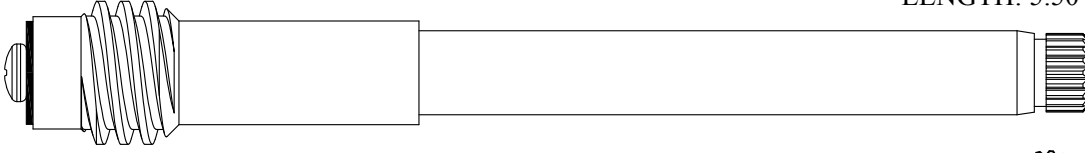

LF280051/ LF280052

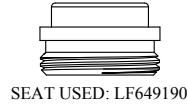

Chrome Plated Stem / Brass Plunger

LENGTH: 5.51"

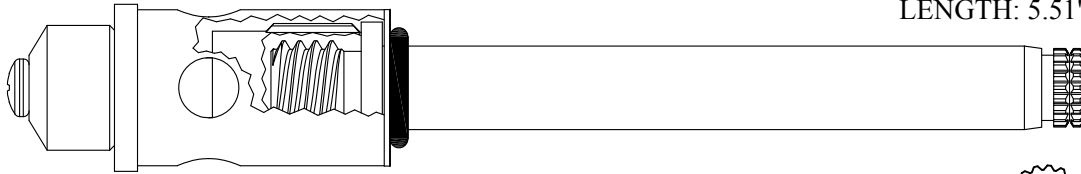

433412



Chrome Plated Stem & Bonnet / Brass Plunger

LENGTH: 5.51"

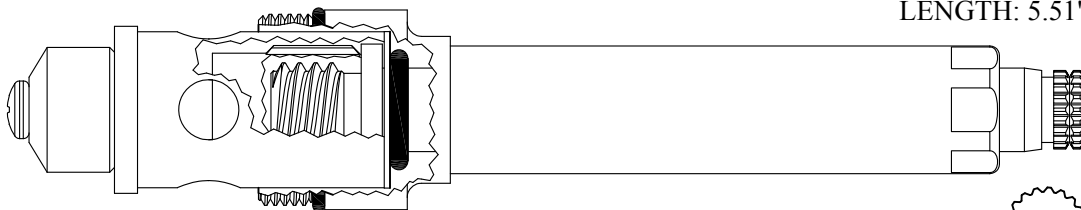

433422

GASKET: 890210 O-RING INCLUDED



Chrome Plated Stem

LENGTH: 5.80"

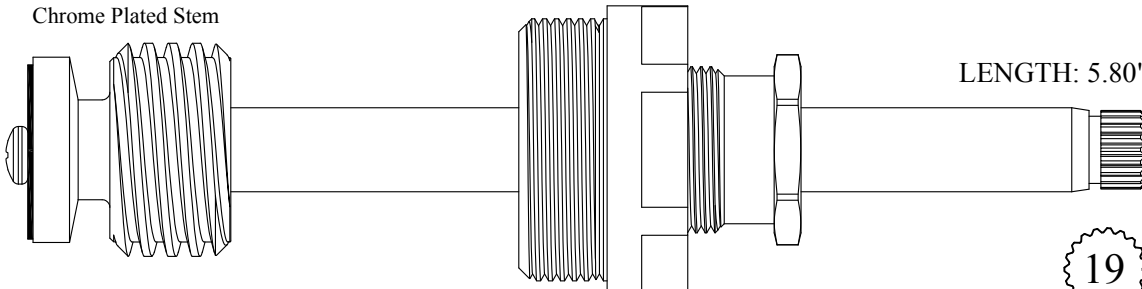

425211
225211 Stem Only



FOR KOHLER

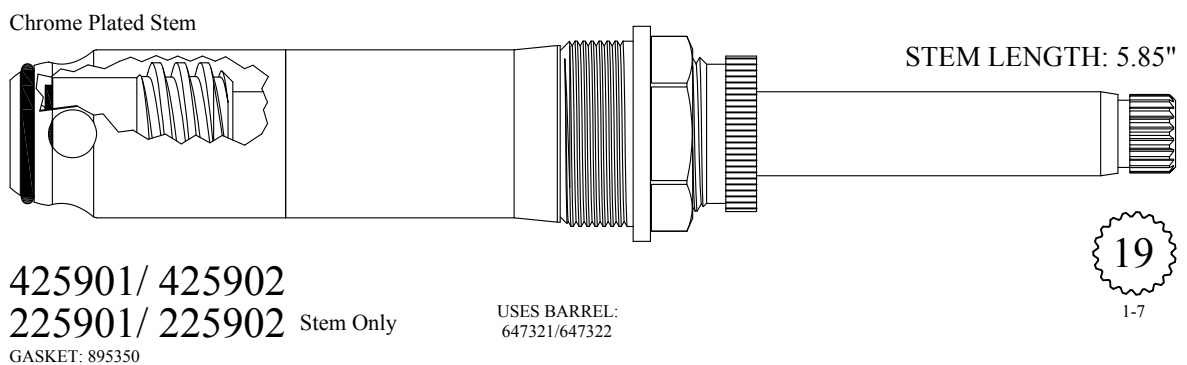
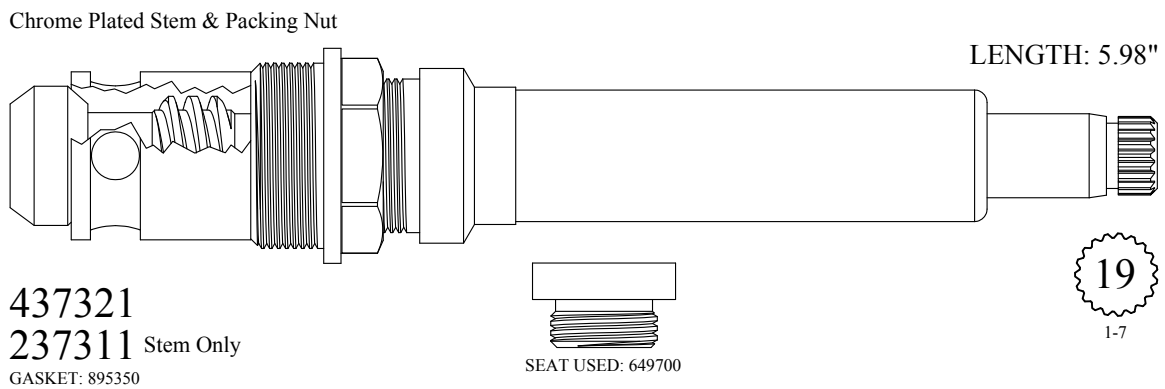
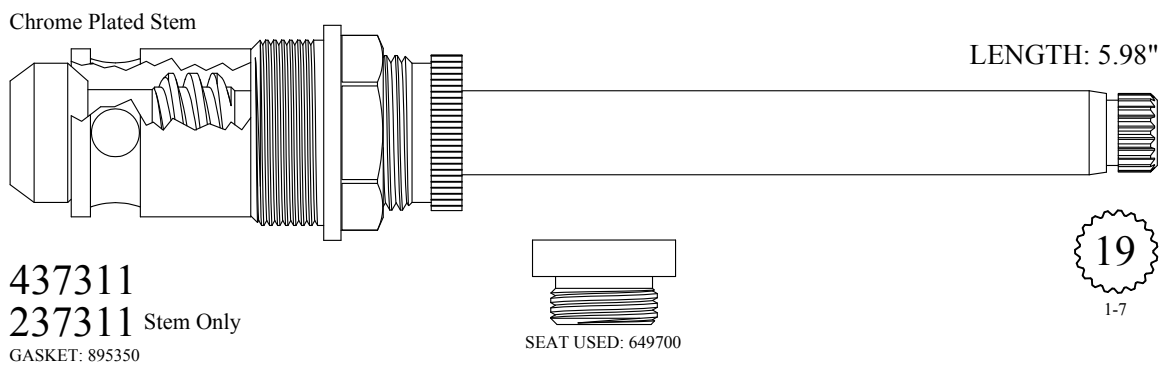
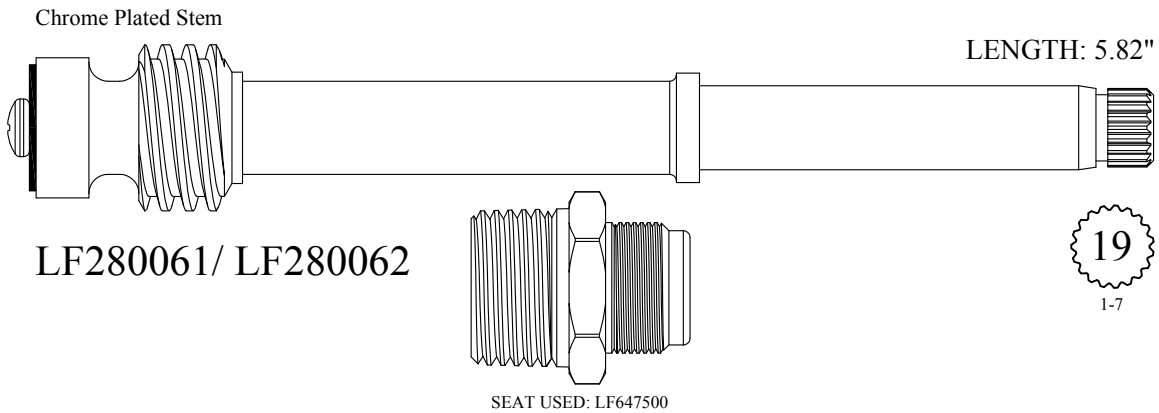

FOR KOHLER

Chrome Plated Stem

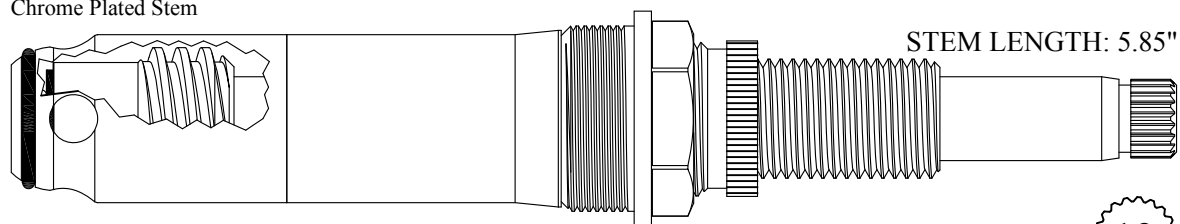

425911/ 425912
225901/ 225902 Stem Only
GASKET: 895350

USES BARREL:
647321/647322

19
1-7

Chrome Plated Stem

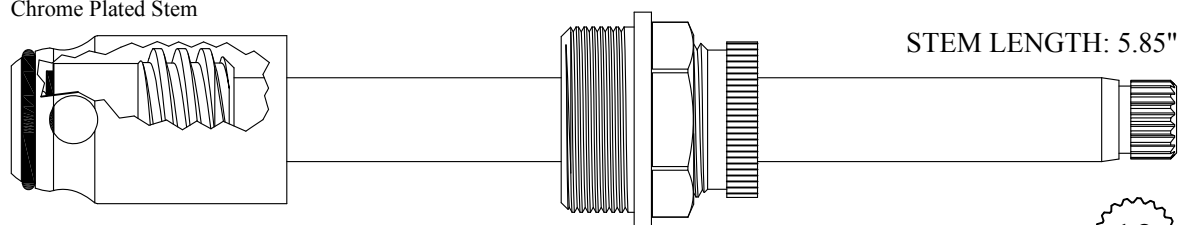

425931
225901 Stem Only
GASKET: 895350

USES BARREL:
647321

19
1-7

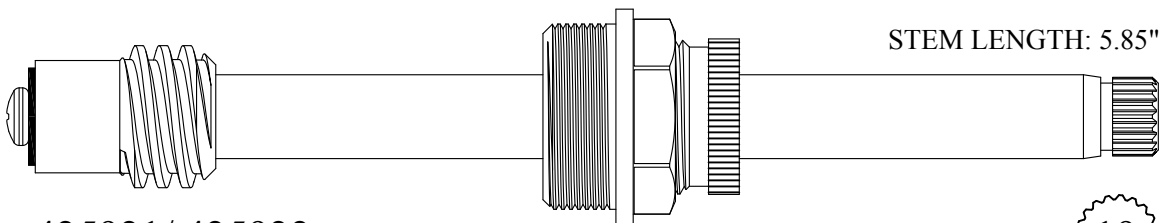

425921/ 425922
225901/ 225902 Stem Only
GASKET: 895350

19
1-7

Chrome Plated Stem

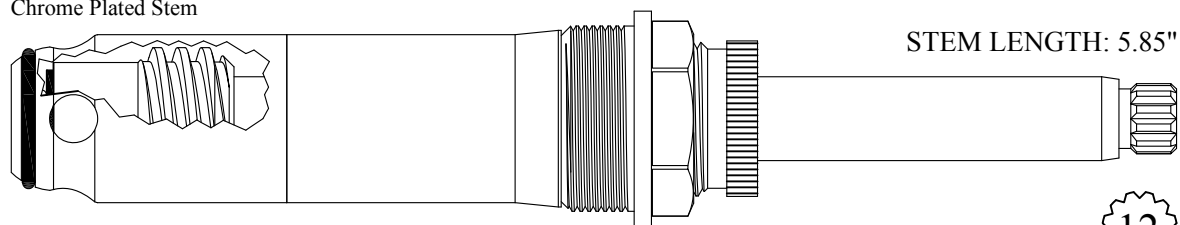

425951/ 425952
225951/ 225952 Stem Only
GASKET: 895350

USES BARREL:
647321/647322

12
1-2

FOR KOHLER

Chrome Plated Stem & Packing Nut

STEM LENGTH: 5.85"

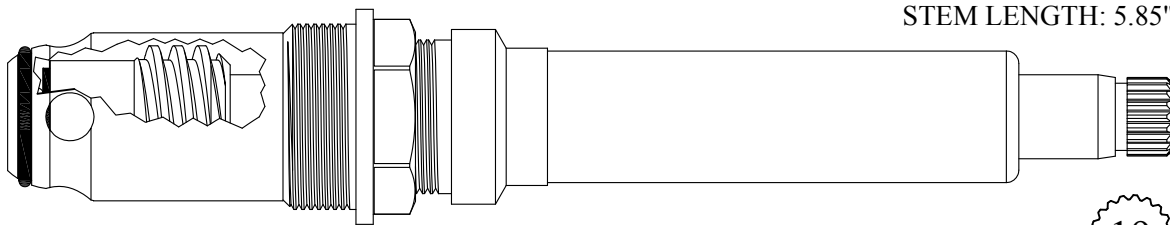

425961/ 425962
225901/ 225902 Stem Only
GASKET: 895350

USES BARREL:
647321/647322

19
1-7

Chrome Plated Stem

LENGTH: 6.09"

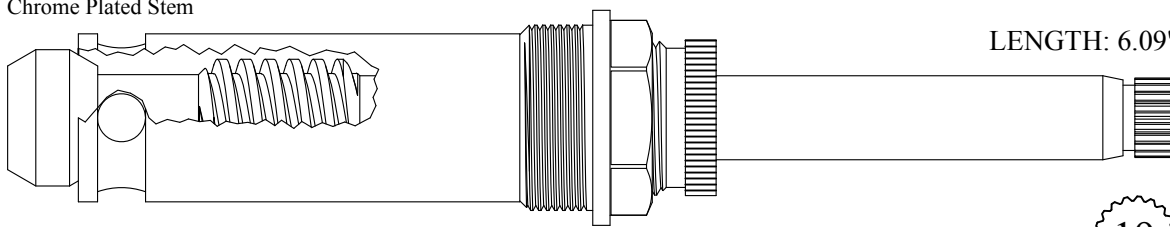

437301
237301 Stem Only
GASKET: 895350

Also available with seat 649700
LF437301-S



19
1-7

Chrome Plated Stem

LENGTH: 6.09"

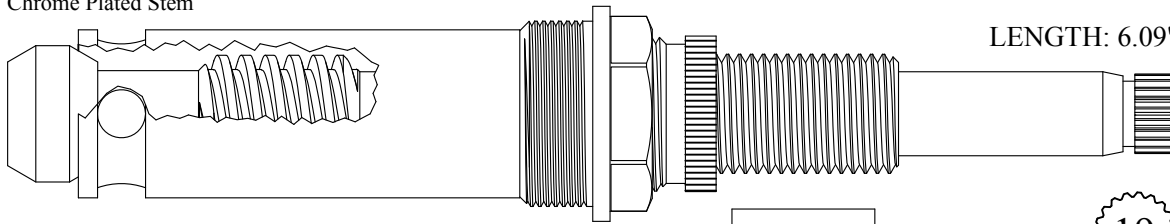

437331
237301 Stem Only
GASKET: 895350

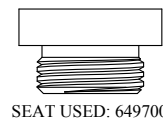

SEAT USED: 649700

19
1-7

Chrome Plated Stem

LENGTH: 6.13"

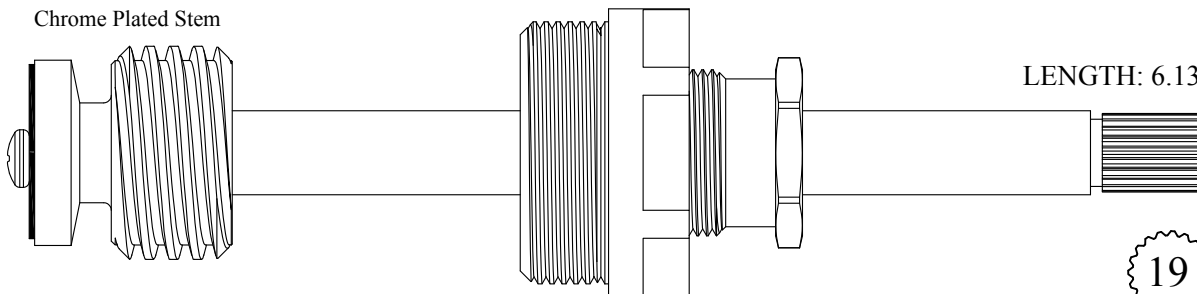

425221
225221 Stem Only

19
1-7

FOR KOHLER

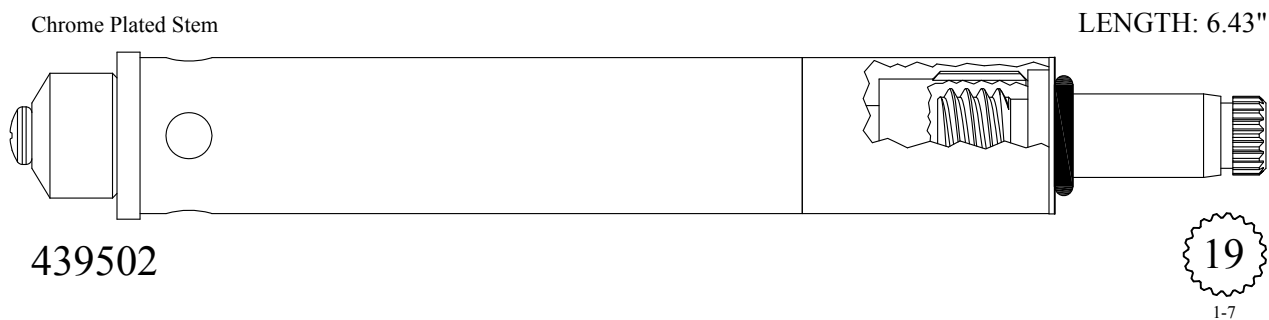
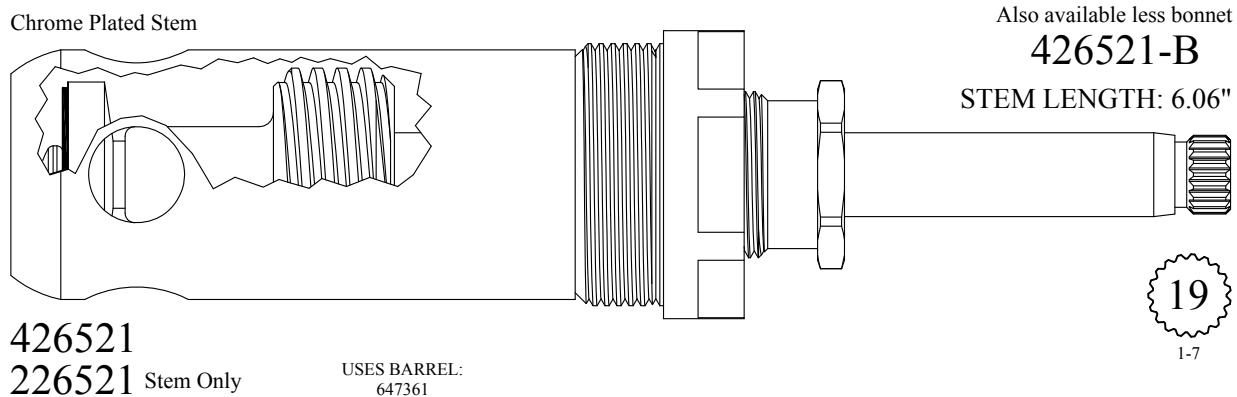
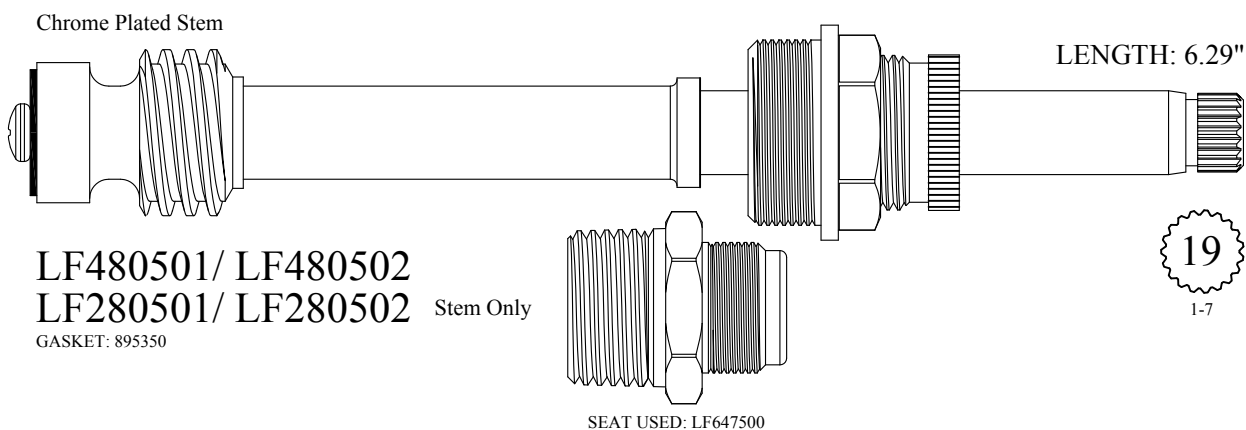
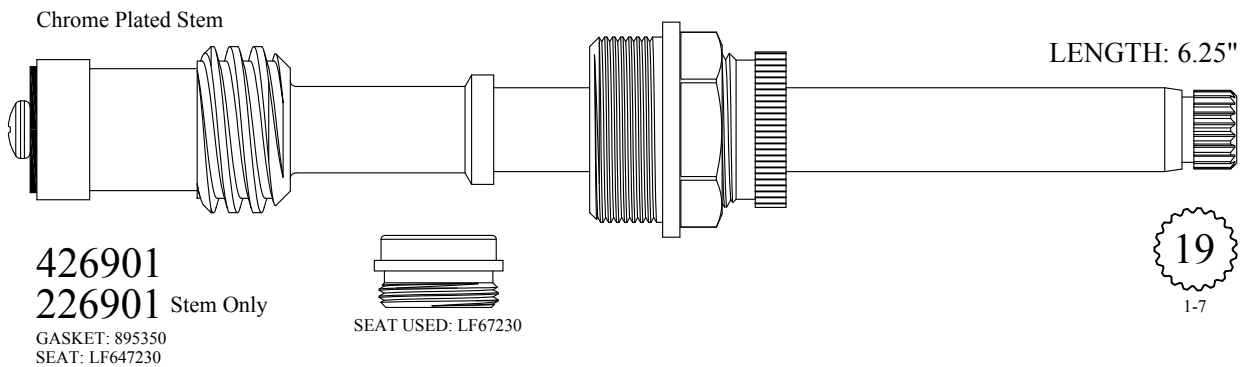

FOR KOHLER

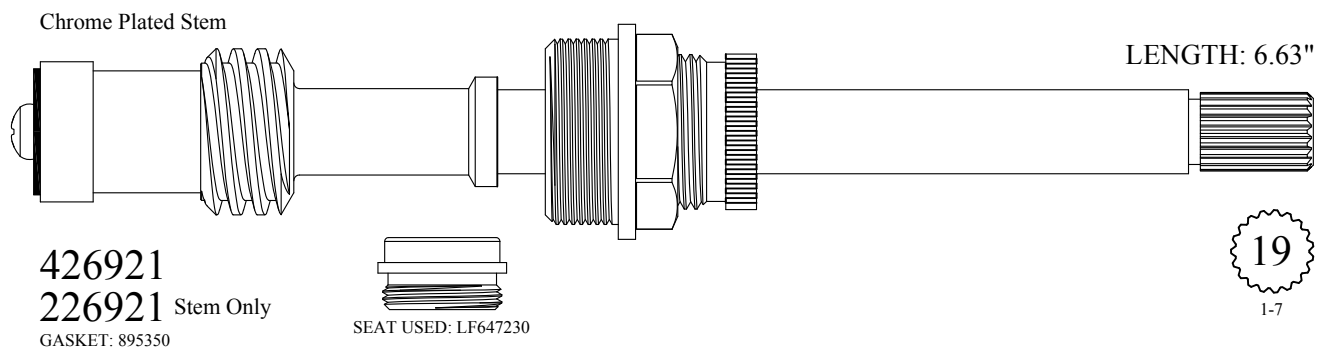
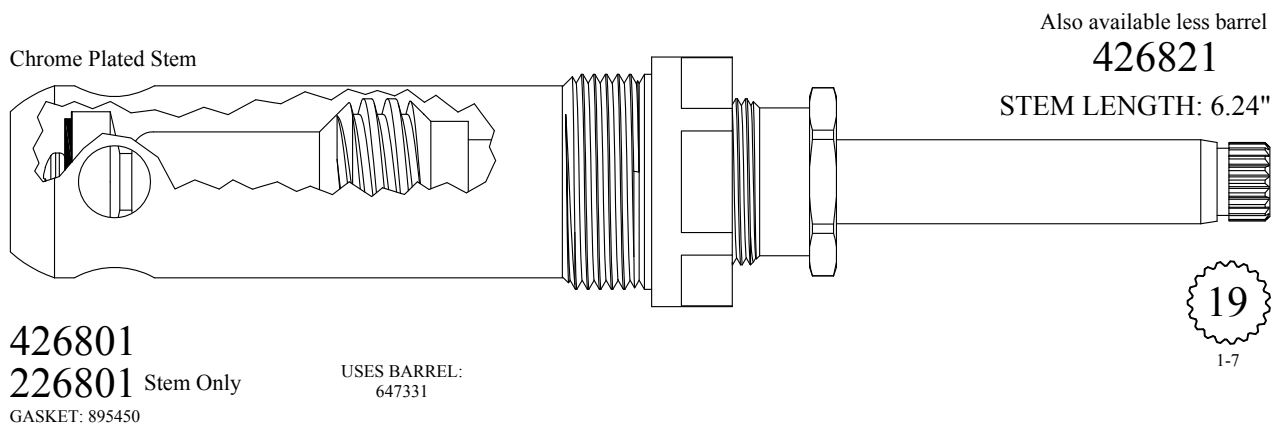
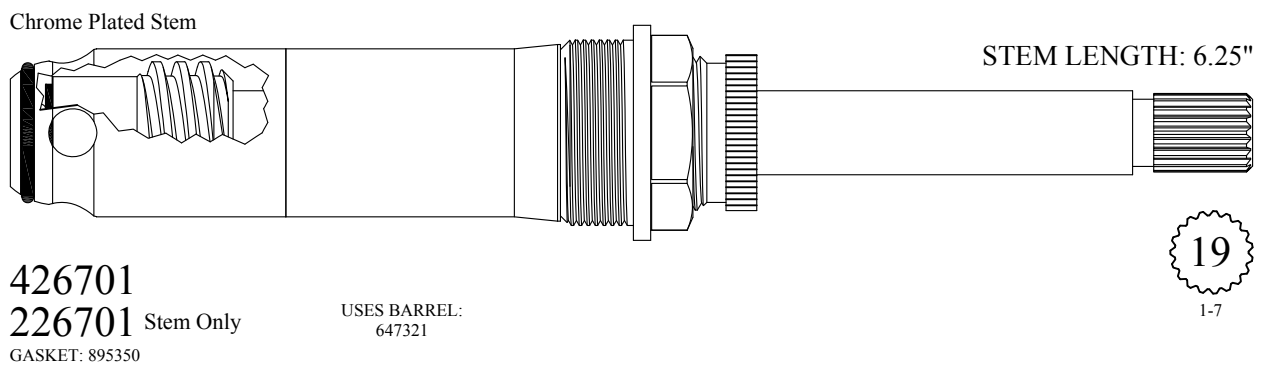
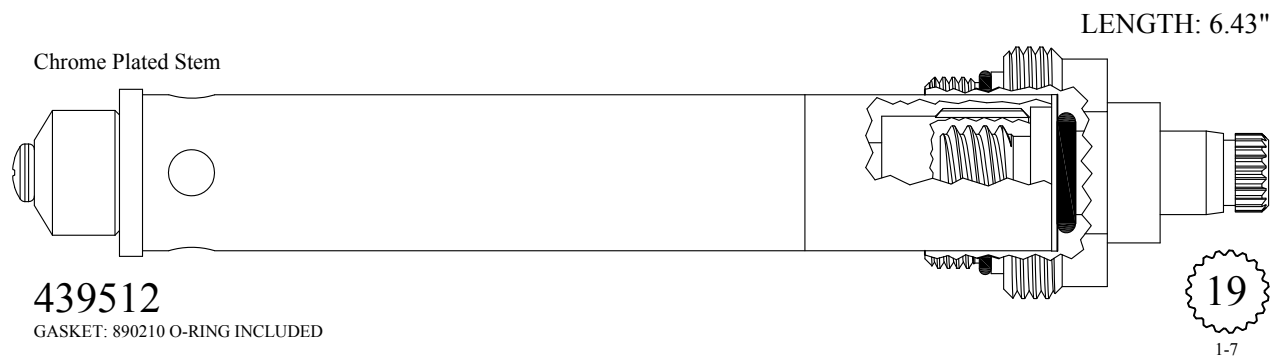

FOR KOHLER

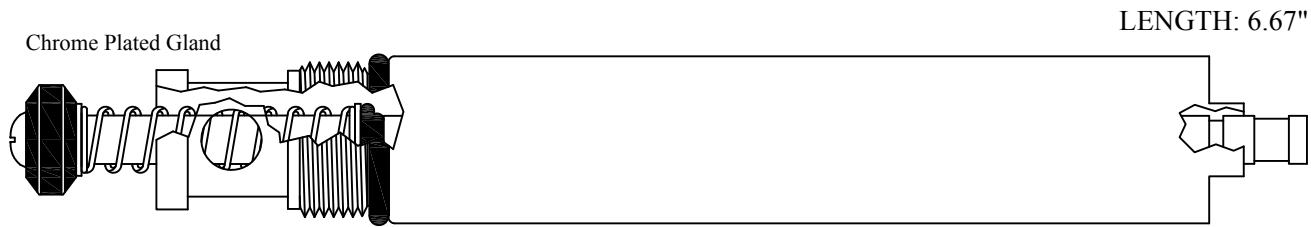

434600

GASKET: 891150 O-RING INCLUDED

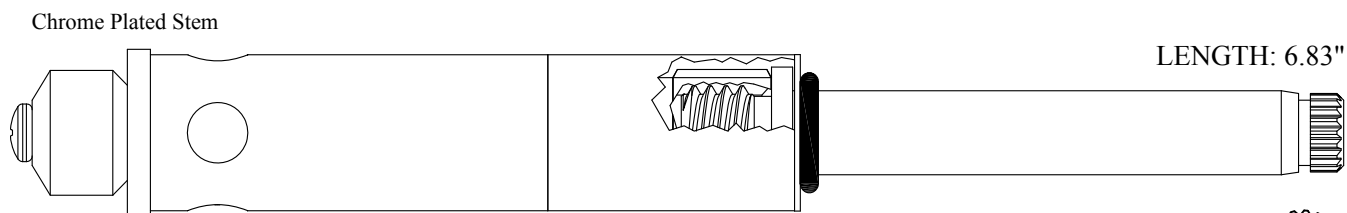

439312

19
1-7

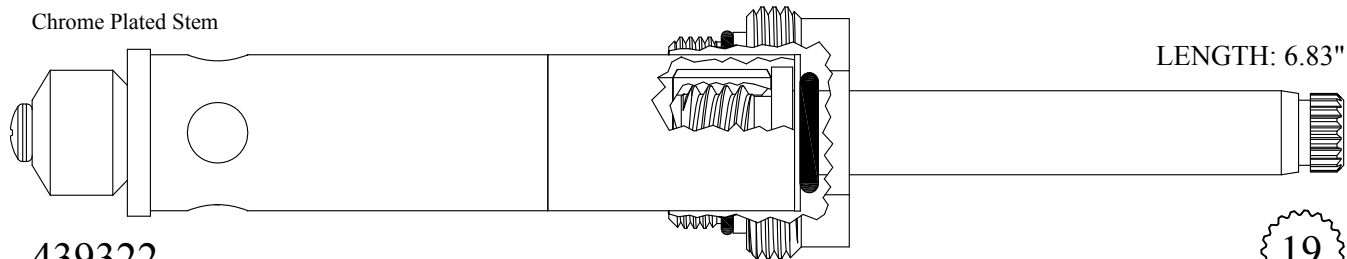

439322

19
1-7

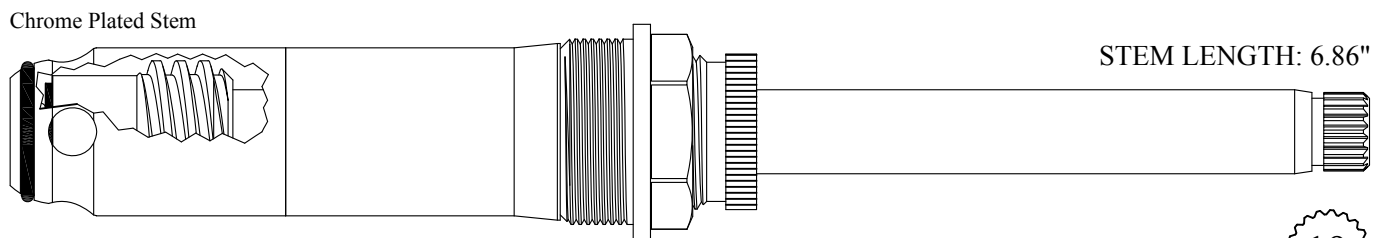

426711

226711 Stem Only

GASKET: 895350

USES BARREL:
647321

19
1-7

FOR KOHLER

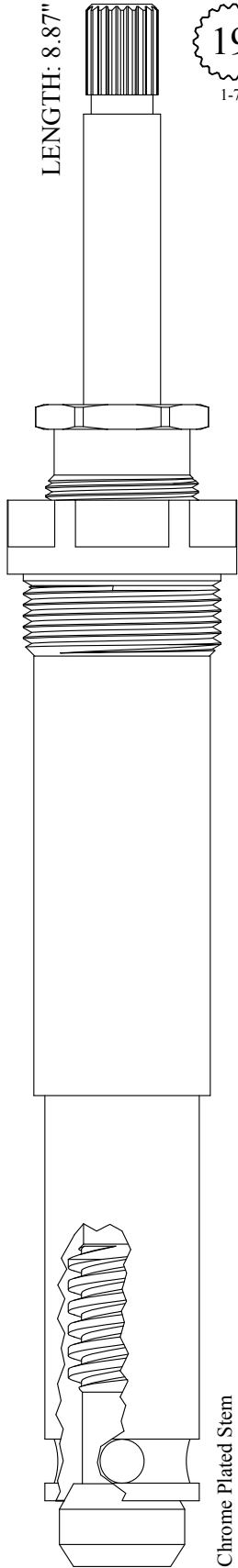

LENGTH: 8.87"

19
1-7

Chrome Plated Stem

GASKET: 895450

439801

239801 Stem Only

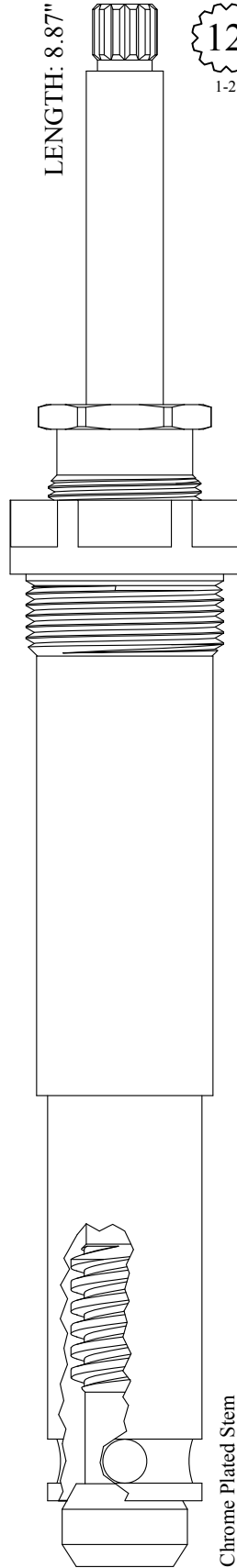

LENGTH: 8.87"

12
1-2

Chrome Plated Stem

GASKET: 895450

439851

239851 Stem Only

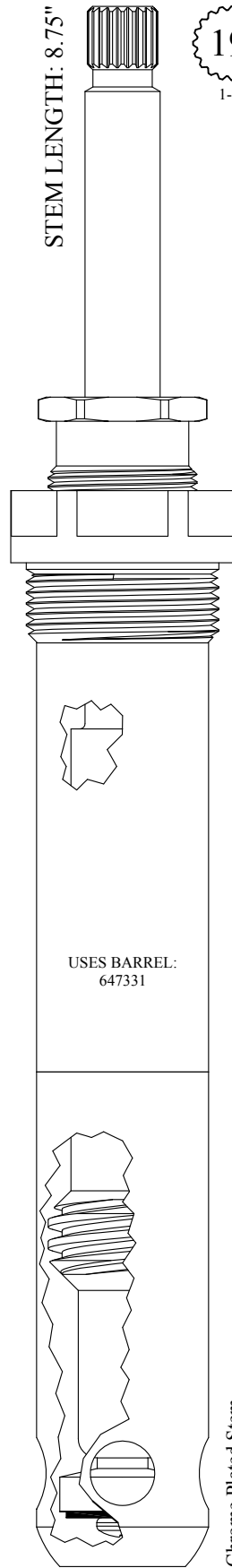

STEM LENGTH: 8.75"

19
1-7

Chrome Plated Stem

USES BARREL:
647331

GASKET: 895450

428331

228331 Stem Only

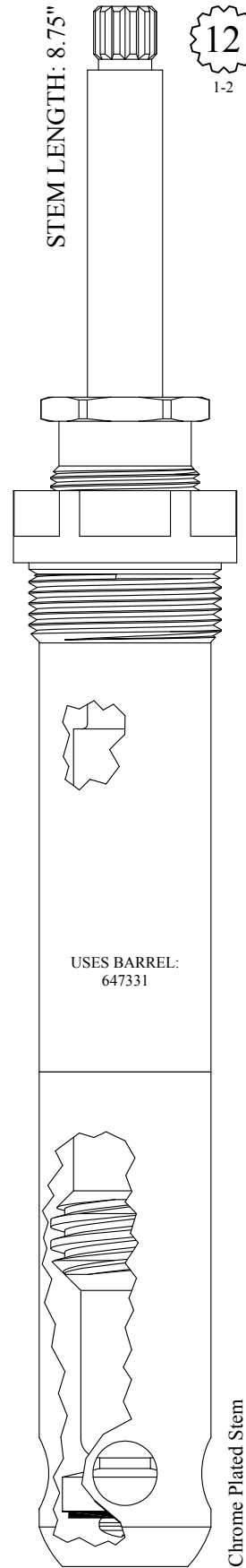

STEM LENGTH: 8.75"

12
1-2

Chrome Plated Stem

USES BARREL:
647331

GASKET: 895450

428381

228381 Stem Only

FOR KROIN BY VOLA

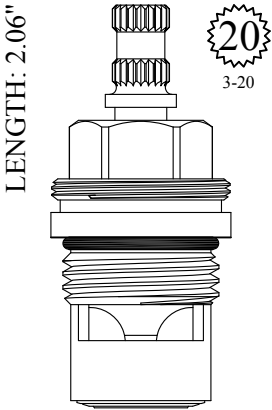

GASKET: 890170 O-RING INCLUDED
SEAL: 898510-W
DISC SET: 151380-PKG

LF459291
LF459292

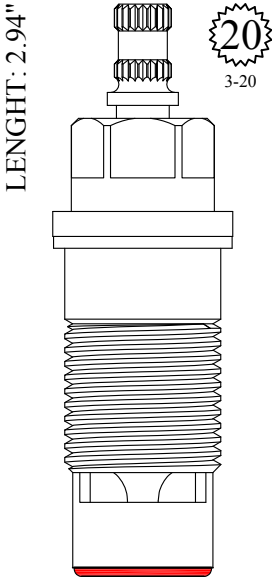

GASKET: 895150 INCLUDED
SEAL: 898570-R/B
DISC SET: 151380-PKG

LF466251
LF466252

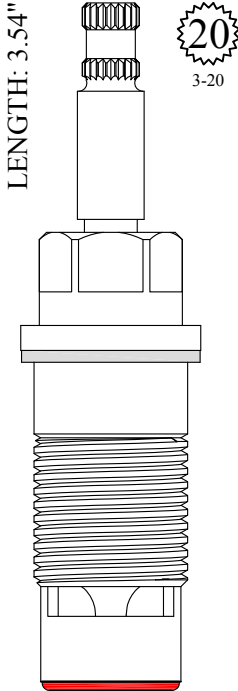

GASKET: 895150 INCLUDED
SEAL: 898570-R/B
DISC SET: 151380-PKG

LF468251
LF468252

FOR KUGLER

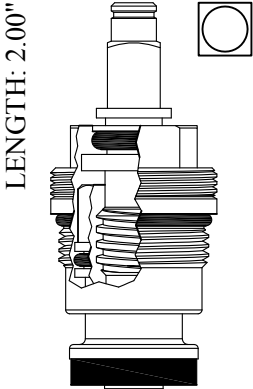

GASKET: 890170 O-RING INCLUDED

LF457262

FOR LABONGE

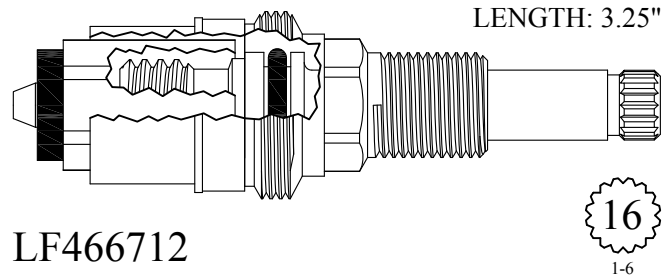

FOR LARDEN

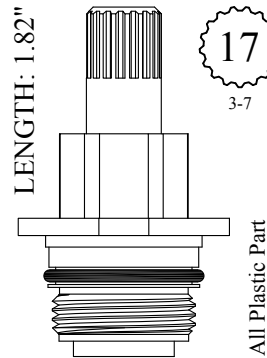

FOR LAWLER

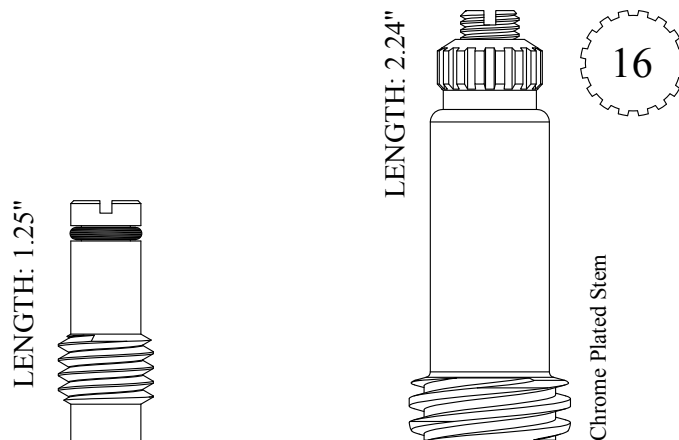

LF200751

201021

FOR LENHART

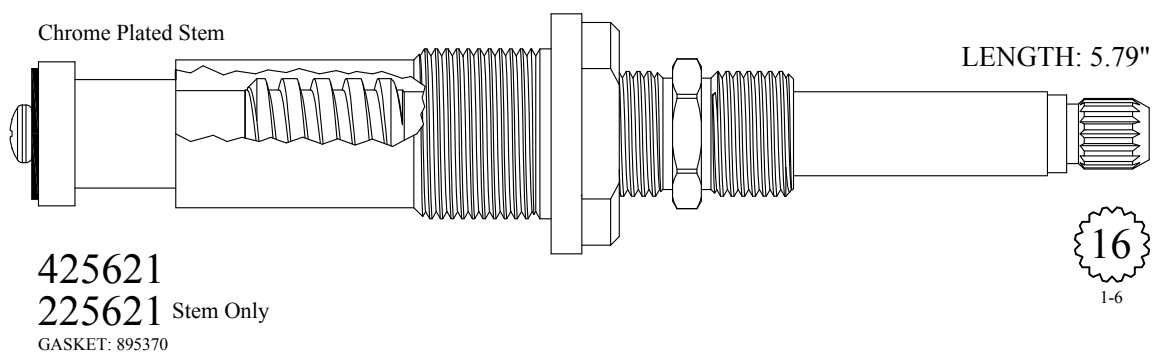
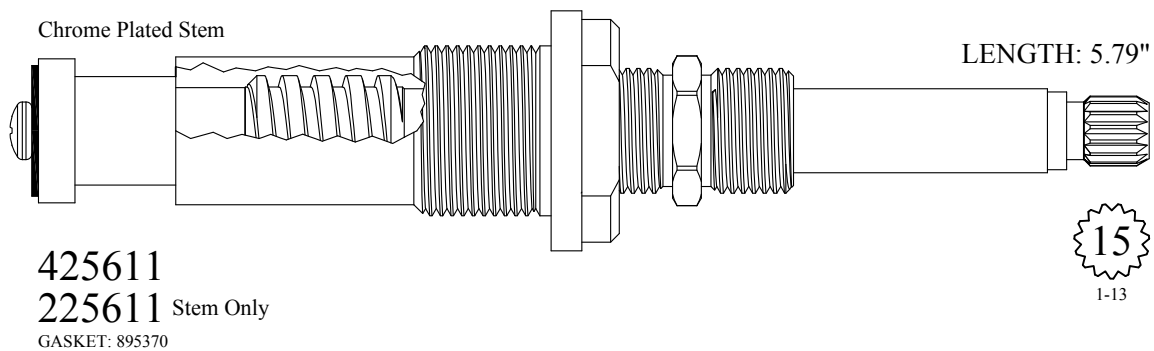
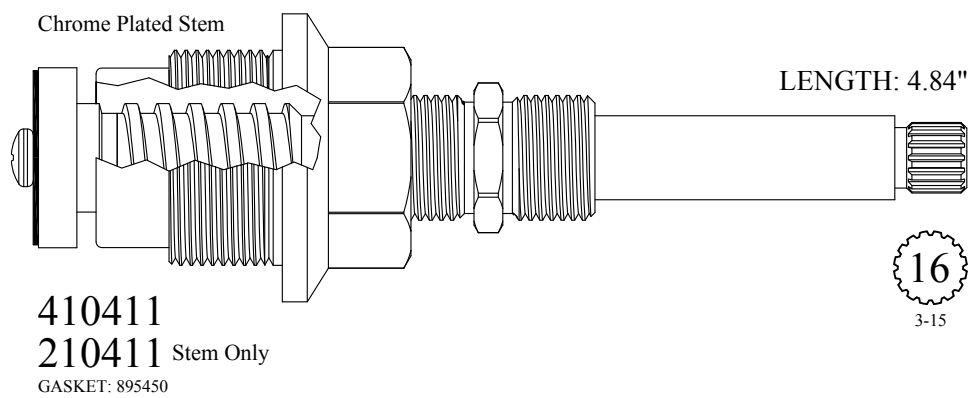
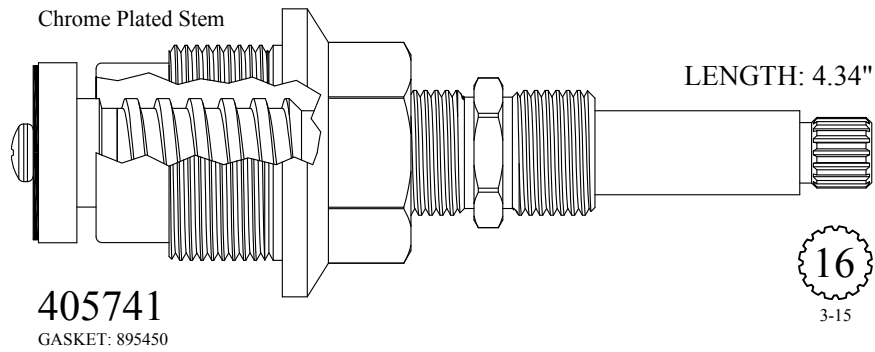

FOR LEONARD

FOR LEONARD
LENGTH: 4.31"

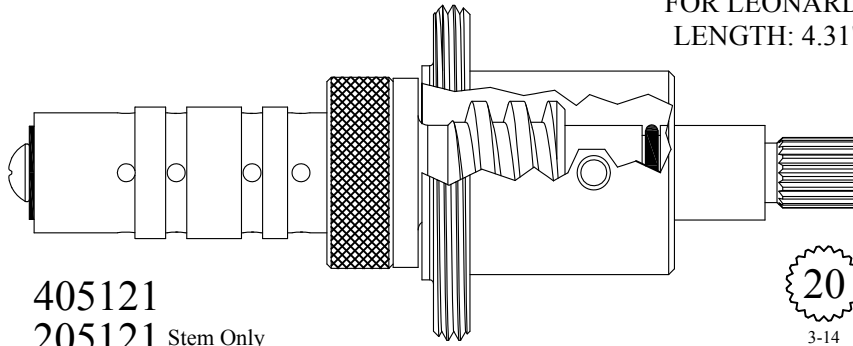

FOR LEONARD
LENGTH: 4.31"

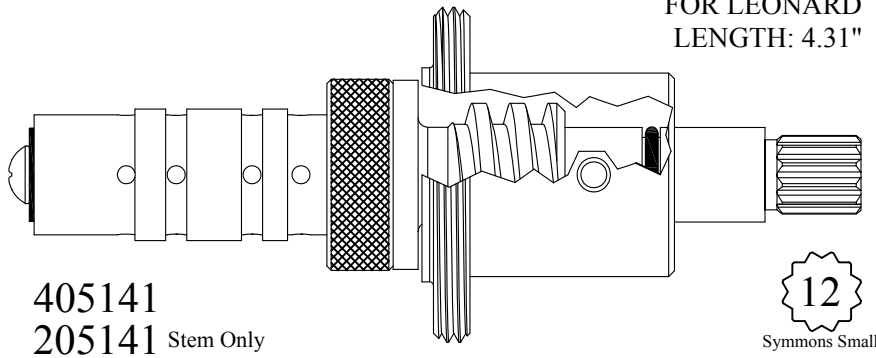

Chrome Plated Stem

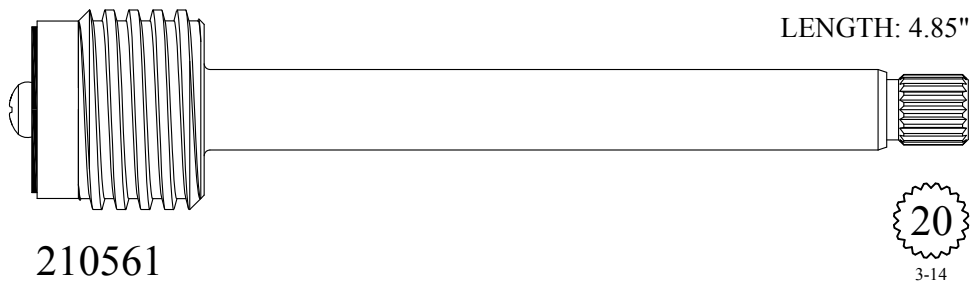

Chrome Plated Stem

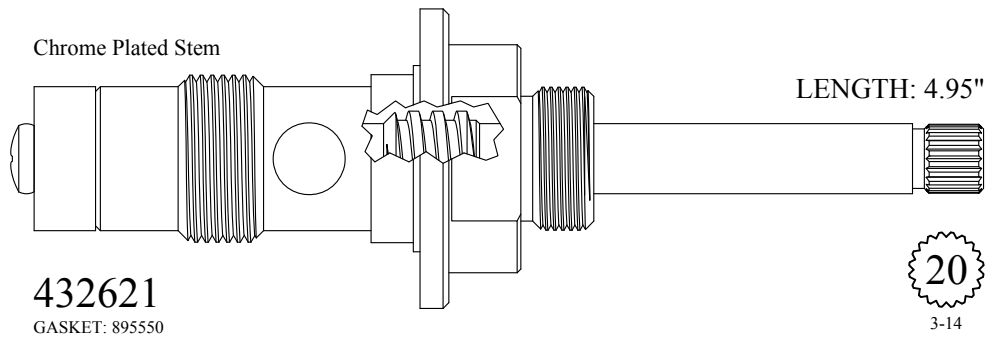

Send Your Orders To:

BARRY E.  SR. CO.

E-mail: orderdesk@barrywalter.com

Fax: 1.800.886.9831

Phone: 1.800.767.5552



Quality Replacement Parts

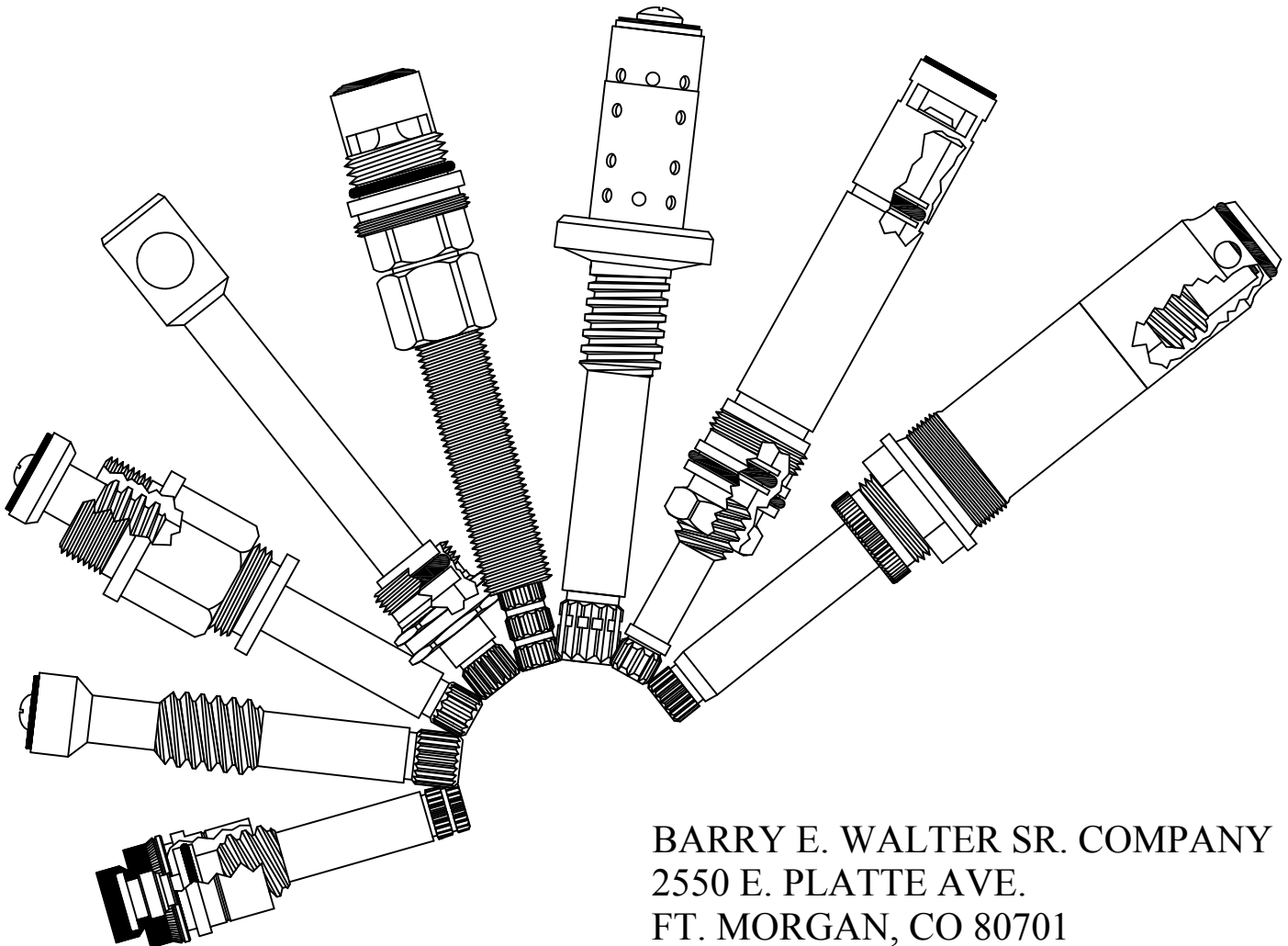

BARRY E. WALTER SR. COMPANY
2550 E. PLATTE AVE.
FT. MORGAN, CO 80701

*We are always adding
new parts. Check our
website for updates.*

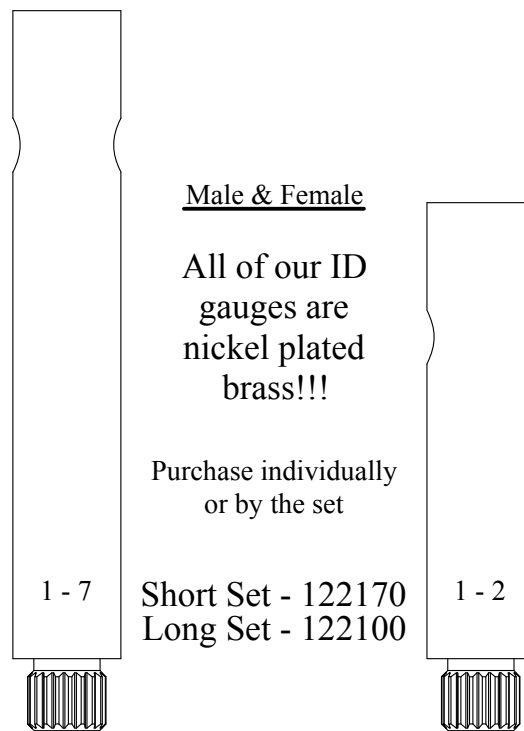

15 DIFFERENT BROACHES IN A SET

BARRY E.  SR. CO.

The logo features a stylized 'W' with a registered trademark symbol (®) inside a square frame.

FOR LIBERTY

LENGTH: 2.89"

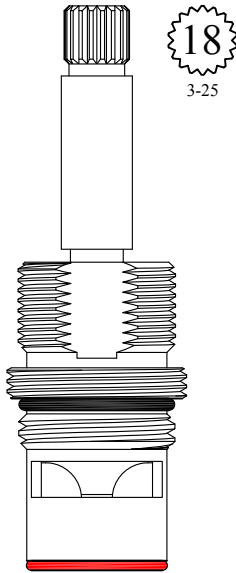

18
3-25

FOR LIBERTY
LENGTH: 2.89"

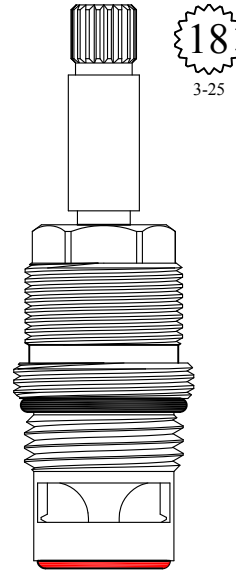

18
3-25

GASKET: 890170 O-RING INCLUDED
SEAL: 898570-R/B
DISC SET: 151380-PKG

LF465431
LF465432

Alternate Style
Not Available

USE LF465431/LF465432

FOR LOGAN

Chrome Plated Stem



SEAT USED: 648800

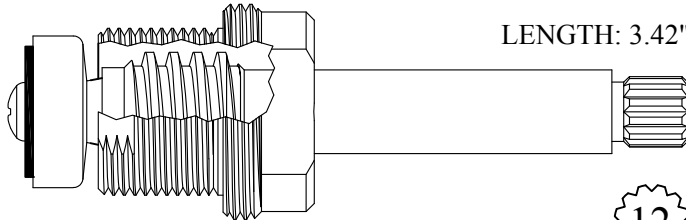

LENGTH: 3.42"

12
1-2

402811
202811 Stem Only
GASKET: 895400

Chrome Plated Unit
Polished Chrome Nut



SEAT USED: 648800

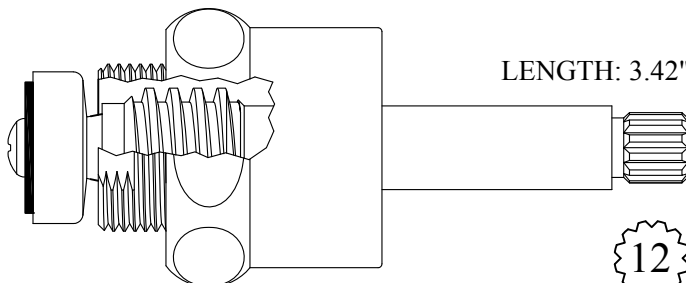

LENGTH: 3.42"

12
1-2

402811-N
202811 Stem Only
GASKET: 895400 INCLUDED

FOR LOGAN

Chrome Plated Stem

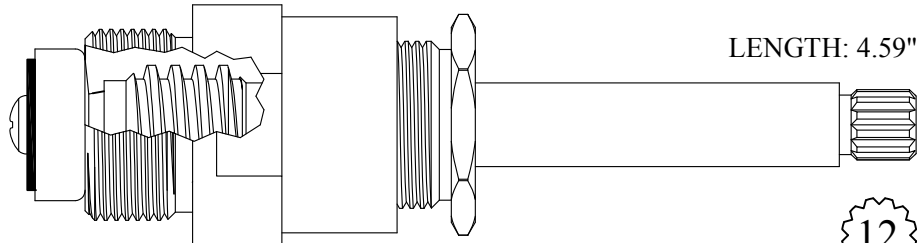

LENGTH: 4.59"

12
1-2

410011

210011 Stem Only

GASKET: 895430

Chrome Plated Stem

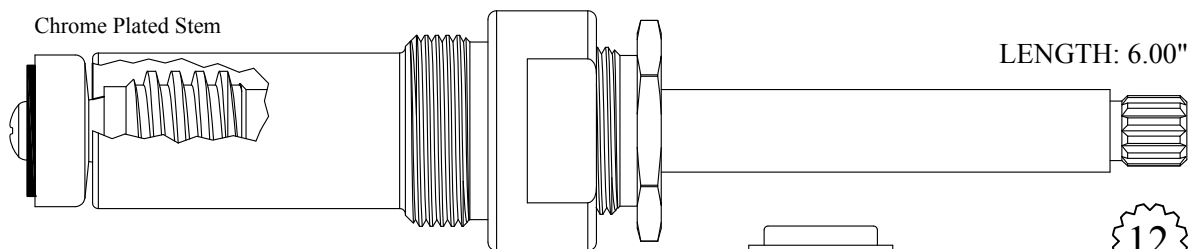

LENGTH: 6.00"

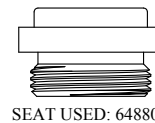

SEAT USED: 648800

12
1-2

426301

226301 Stem Only

GASKET: 895570

Also available in the following lengths:

UNIT	STEM ONLY		LENGTH
	UNIT	STEM ONLY	
427201	227201	227201	6.50"
427501	227501	227501	7.00"
428301	228301	228301	8.00"
428401	228401	228401	9.50"
429301	229301	229301	12.00"
429501	229501	229501	14.00"
429601	229601	229601	16.00"
429701	229701	229701	18.00"

THESE STEMS ARE ALL
CHROME PLATED

Additional variations and lengths on the following page.



FOR LOGAN

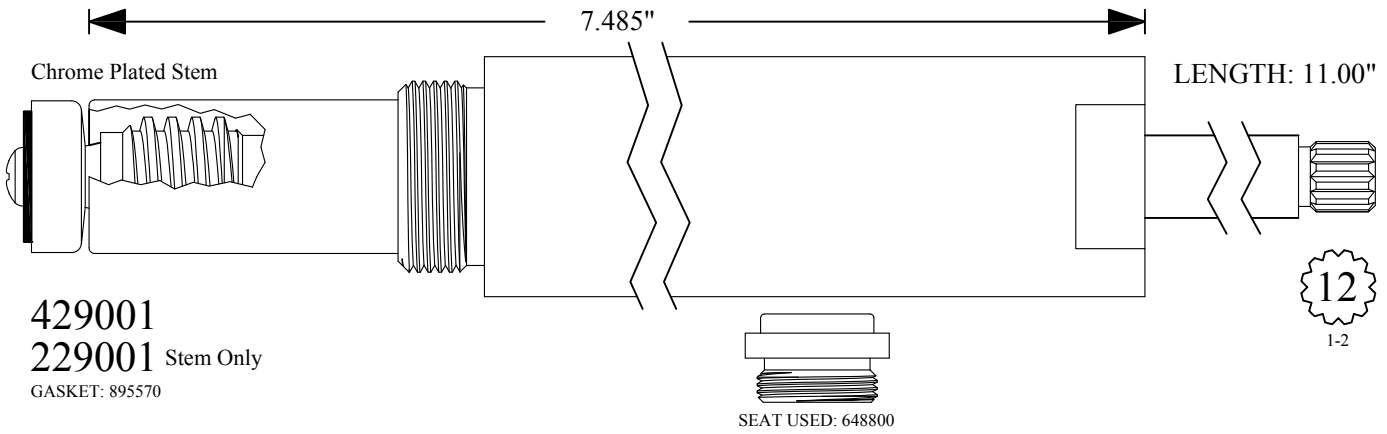
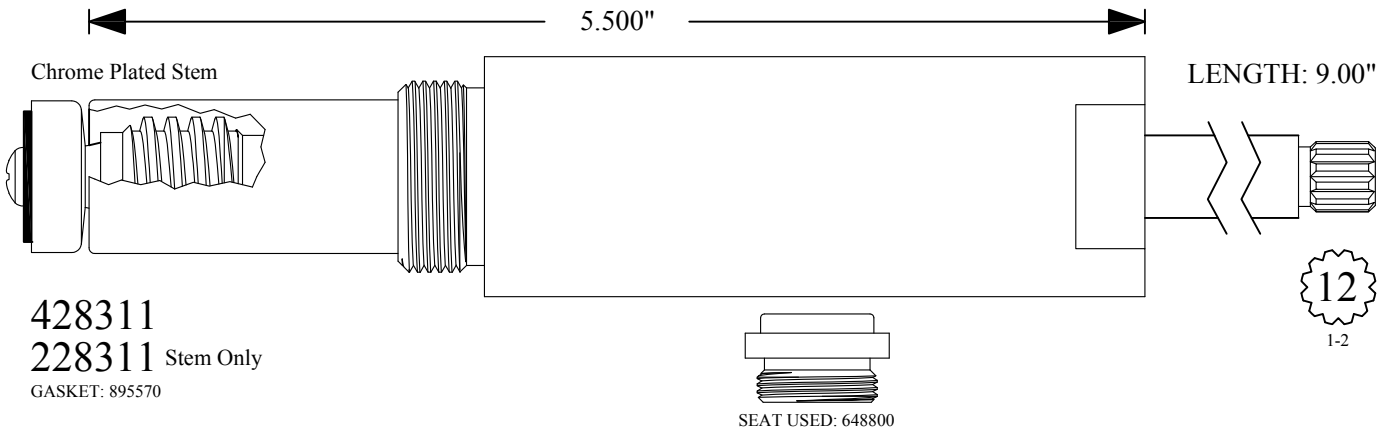

FOR MANSFIELD

FOR MANGORI

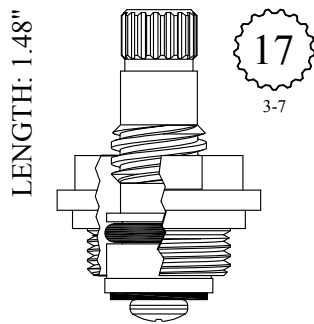

LF450981
LF450982

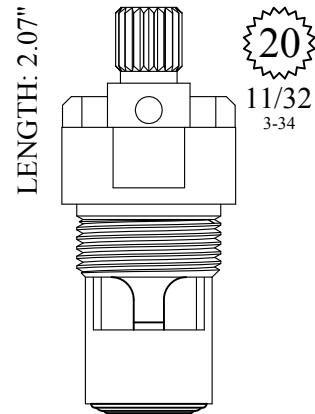

LF459471
LF459472

FOR McCAMBRIDGE

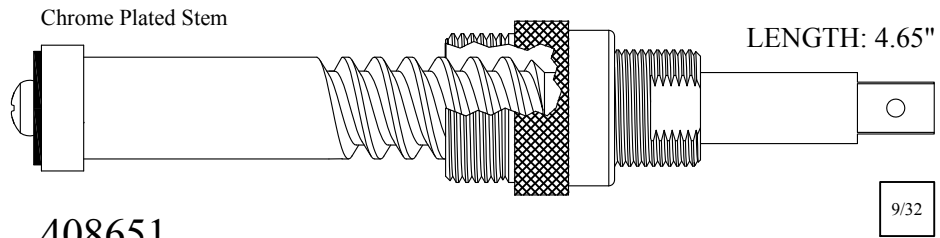

408651
208651 Stem Only
GASKET: 895160

FOR MELCLIFF

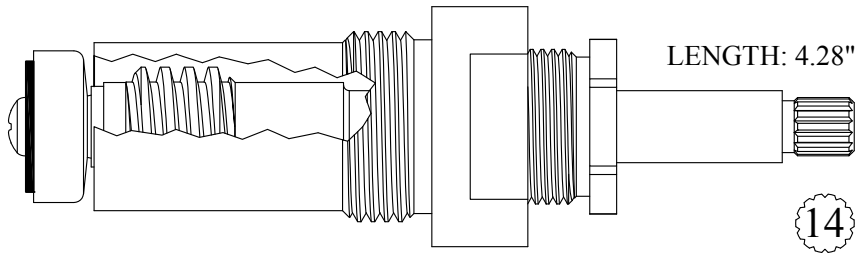

405311
205311 Stem Only
GASKET: 895550

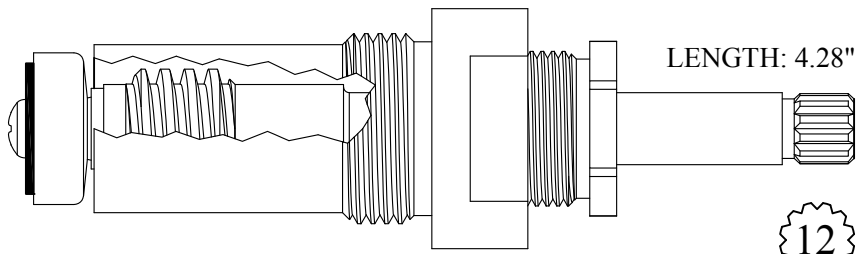

405361
205361 Stem Only
GASKET: 895550

1-2

FOR METCRAFT

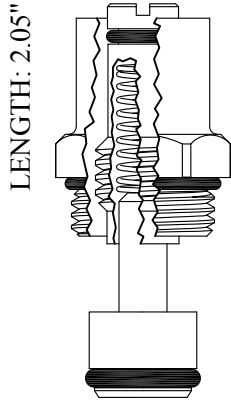

GASKET: 890170 O-RING INCLUDED

LF400751

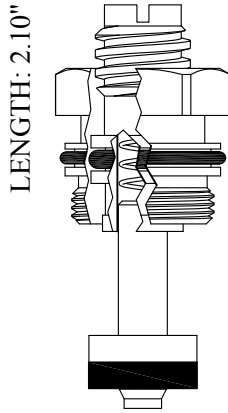

LF400441

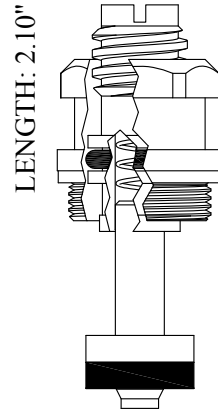

GASKET: 895100 INCLUDED

LF400461

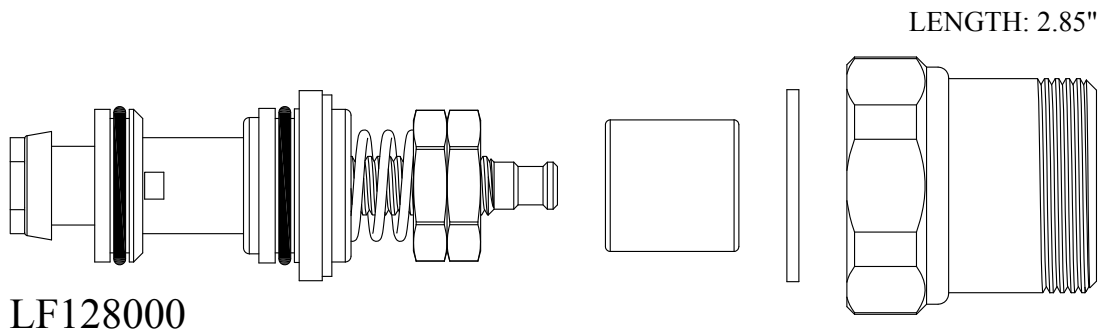

LF128000

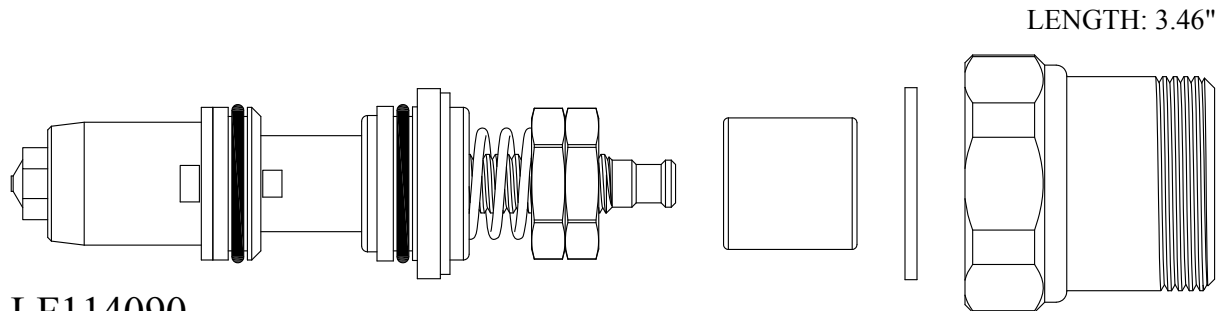

LF114090
LF114020 Cartridge Only

FOR MICHIGAN BRASS

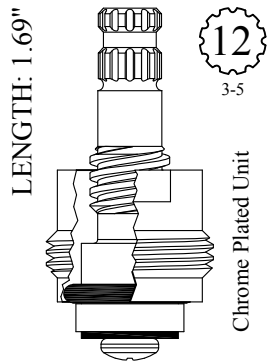

GASKET: 891120 O-RING INCLUDED

400621
400622

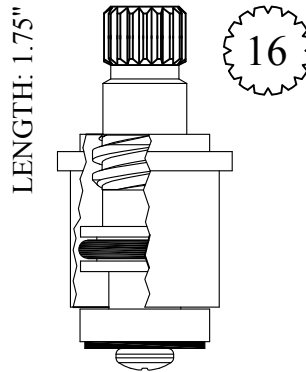

GASKET: 895140

LF455091
LF455092



SEAT USED: LF648210

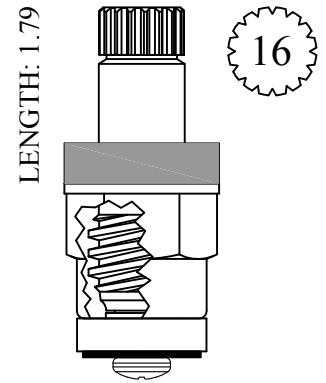

LF454151
LF454152

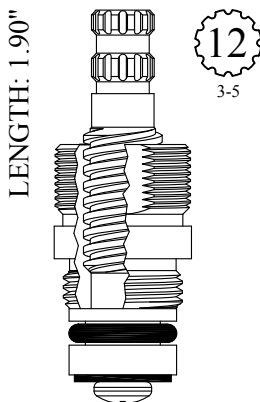

LF456821
LF456822



SEAT USED: LF648210

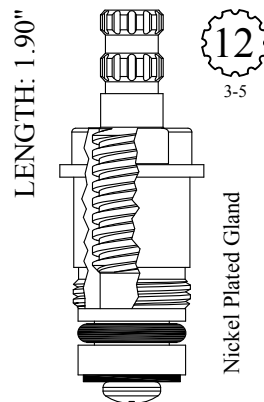

LF457021
LF457022



SEAT USED: LF648210

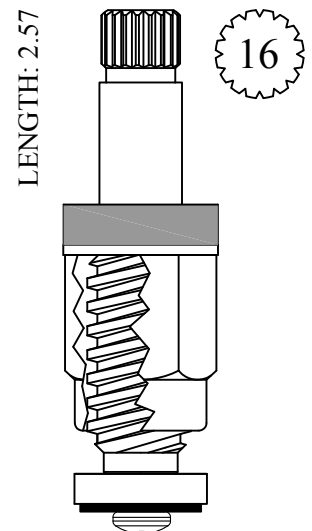

LF464141
LF464142

FOR MICHIGAN BRASS

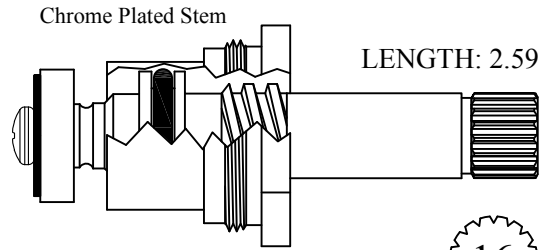

LF465321/ LF465322

LENGTH: 3.03"

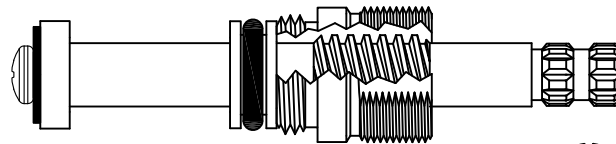
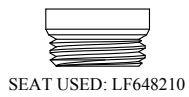

LF466101/ LF466102

3-5

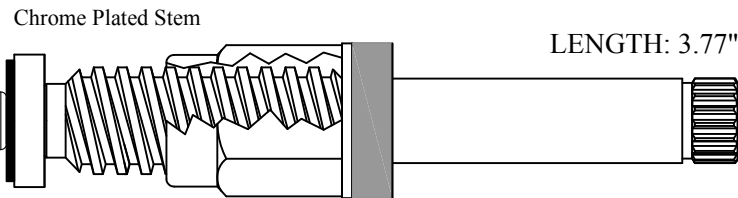

403271

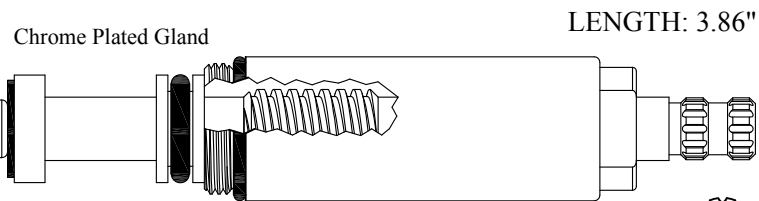

403421/ 403422

GASKET: 890160 O-RING INCLUDED

3-5

FOR MICHIGAN BRASS

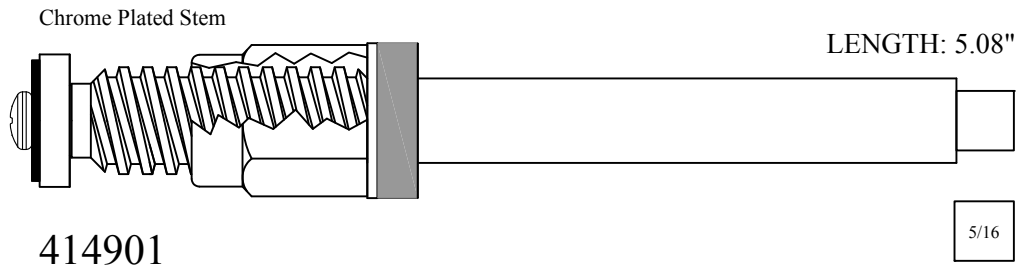
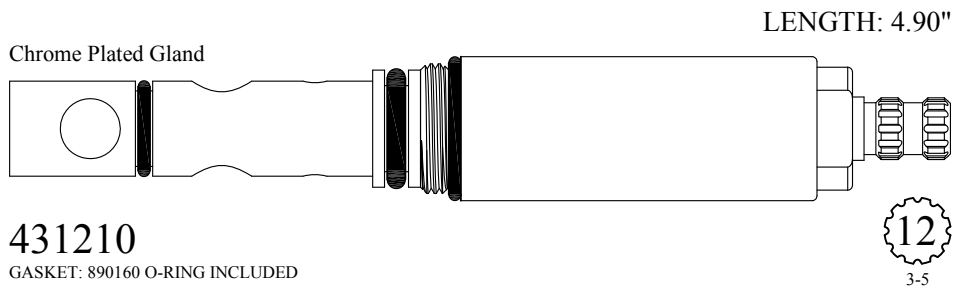
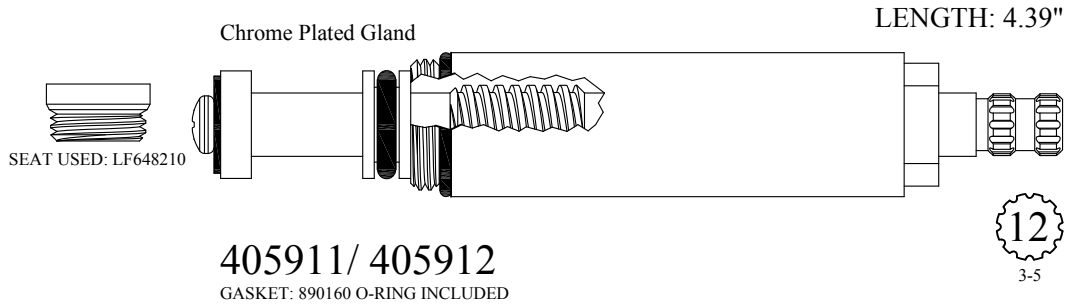

BARRY E.  WALTER  SR. CO.

FOR MILWAUKEE

LENGTH: 1.04"

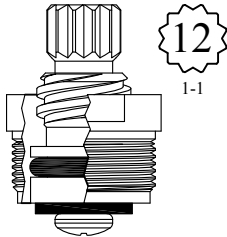

GASKET: 895100

LF450011
LF450012

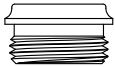

SEAT USED: LF649040

LENGTH: 1.43"

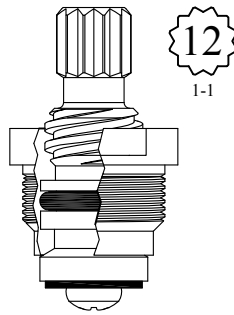

GASKET: 895100

LF451301
LF451302

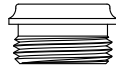

SEAT USED: LF649040

LENGTH: 1.65"

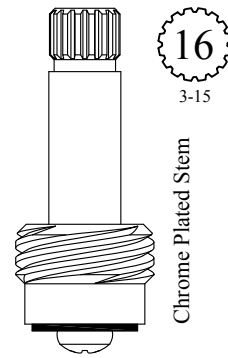

Chrome Plated Stem

201211
201212



SEAT USED: 648370

LENGTH: 1.74"

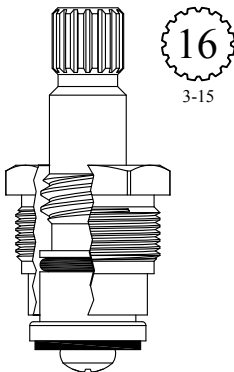

GASKET: 199930

LF453121
LF453122



SEAT USED: LF649040

LENGTH: 1.74"

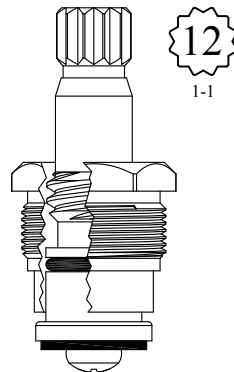

GASKET: 199930

LF453241
LF453242



SEAT USED: LF649040

LENGTH: 1.75"

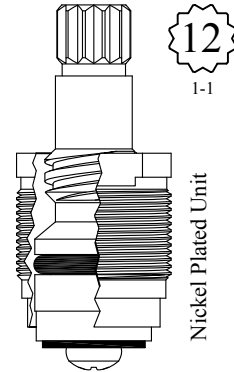

Nickel Plated Unit

GASKET: 894670

LF455021
LF455022

FOR MILWAUKEE

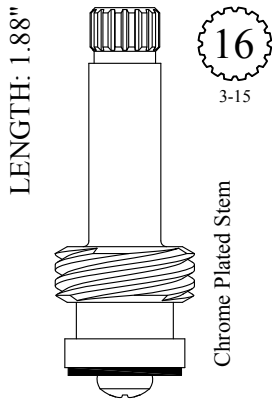

LF256121
LF256122



SEAT USED: LF649040

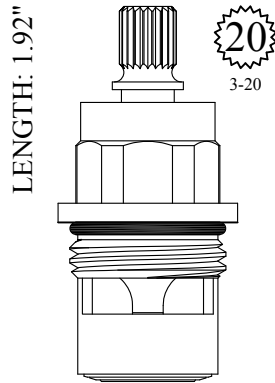

GASKET: 890170 O-RING INCLUDED
SEAL: 898510-W
DISC SET: 151380-PKG

LF456401
LF456402

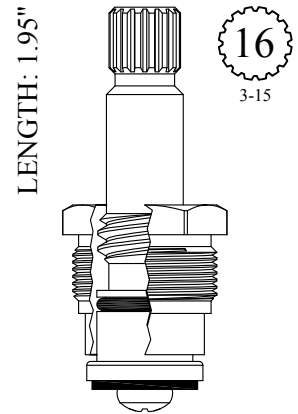

GASKET: 199930

LF457301



SEAT USED: LF649040

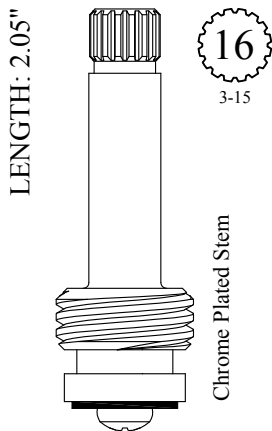

LF259051
LF259052



SEAT USED: LF649040

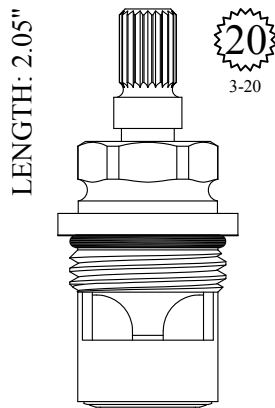

GASKET: 890170 O-RING INCLUDED
SEAL: 898510-W
DISC SET: 151380-PKG

LF458191
LF458192

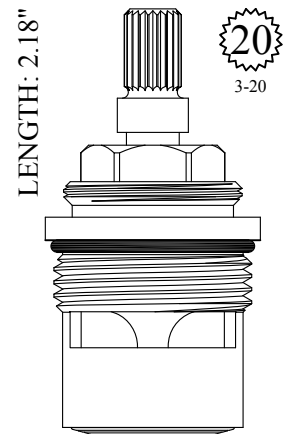

GASKET: 890210 O-RING INCLUDED
SEAL: 898520
DISC SET: 109850-PKG

401121
401122

FOR MILWAUKEE



SEAT USED: LF649040

Chrome Plated Stem LENGTH: 2.29"

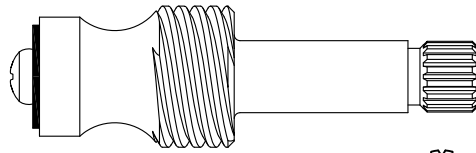

LF264231
LF264232

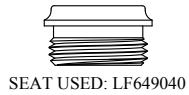

SEAT USED: LF649040

Chrome Plated Stem LENGTH: 2.29"

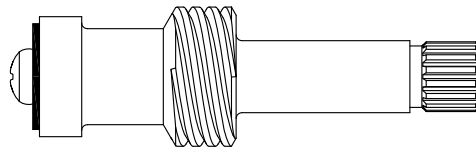

LF263181
LF263182



LENGTH 2.57

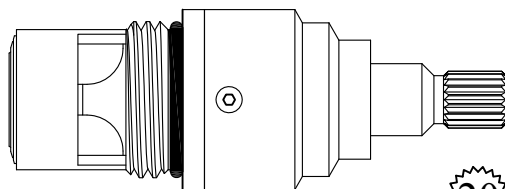

Individual items available
Stem Ext.: #118760
Esc Cap Nut: #124940



LF463941/ LF463942

GASKET: 890170 O-RING INCLUDED
SEAL: 898510-W
DISC SET: 151380-PKG

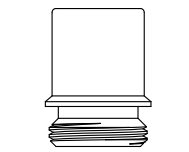

SEAT USED: LF649500

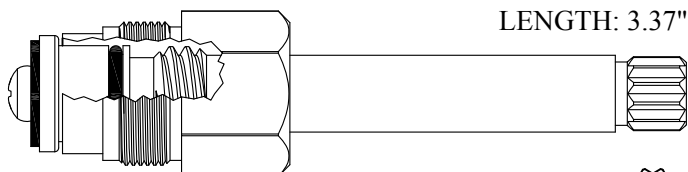

LENGTH: 3.37"

402591
GASKET: 199930



FOR MILWAUKEE



SEAT USED: LF649040

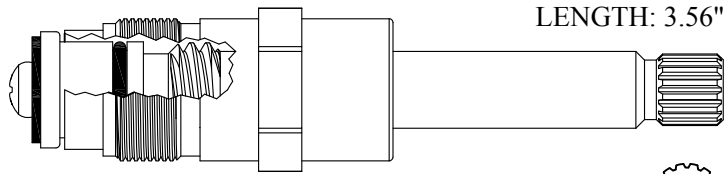

LENGTH: 3.56"

403001
203001 Stem Only
 GASKET: 199930

16
 3-15

Chrome Plated Stem

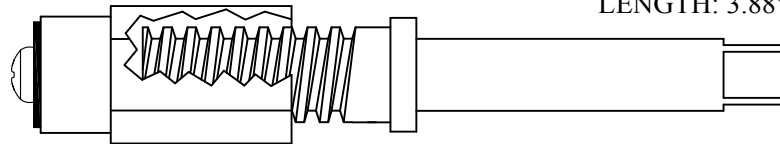

LENGTH: 3.88"

402632
202632 Stem Only

5/16

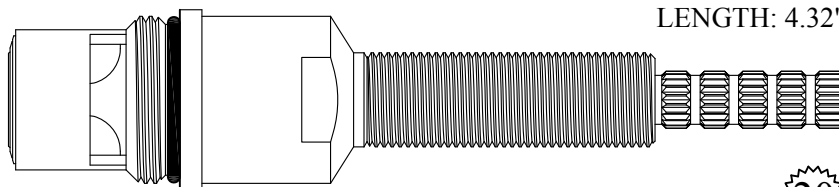

LENGTH: 4.32"

405191/ 405192
 GASKET: 890170 O-RING INCLUDED
 SEAL: 898510-W
 DISC SET: 151380-PKG

20
 3-20

Chrome Plated Stem

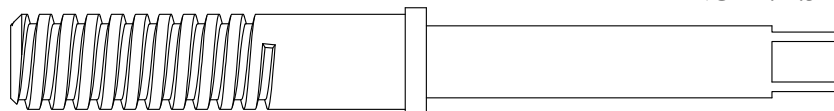

LENGTH: 4.34"

205212

5/16

FOR MILWAUKEE

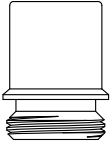

SEAT USED: LF649500

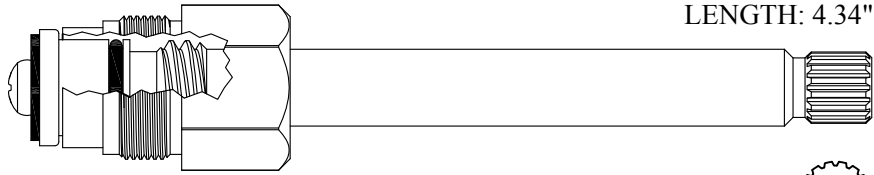

LENGTH: 4.34"

404901

GASKET: 199930

16

3-15

207512

LENGTH: 4.46"

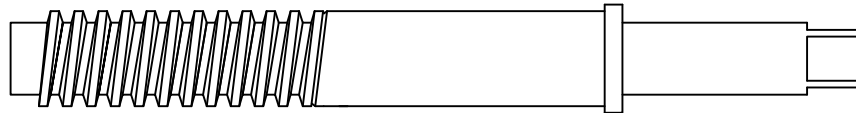

5/16

Chrome Plated Stem

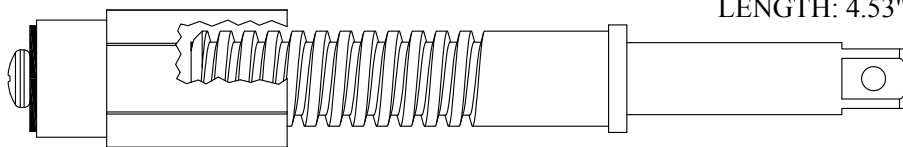

LENGTH: 4.53"

403432

203432

Stem Only

5/16

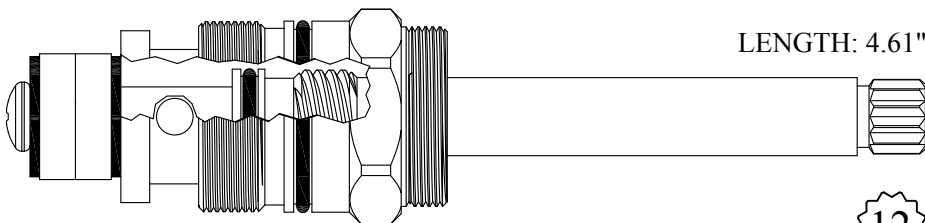

LENGTH: 4.61"

430951

GASKET: 890200 O-RING INCLUDED

12

1-1

FOR MILWAUKEE

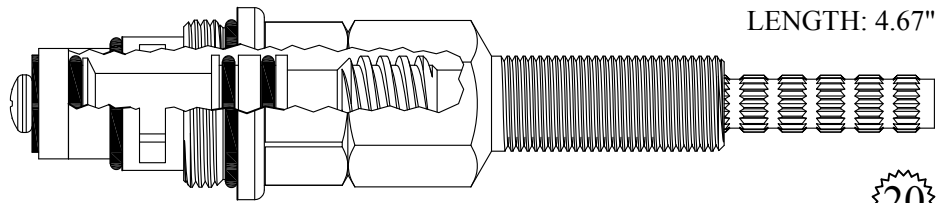

LENGTH: 4.67"

430931

GASKET: 890180 O-RING INCLUDED

20
3-20

Chrome Plated Stem

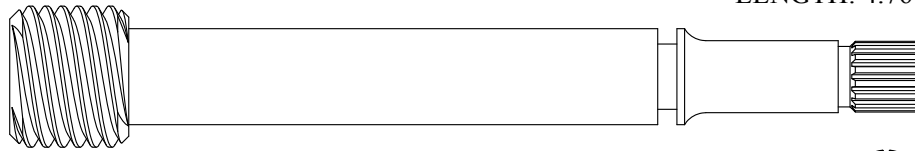

LENGTH: 4.76"

231331

16
3-15

Chrome Plated Stem

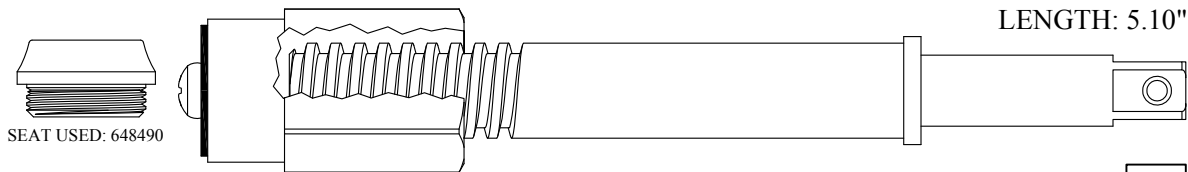

SEAT USED: 648490

LENGTH: 5.10"

408502

208502 Stem Only

GASKET: 894960 INCLUDED

5/16

Chrome Plated Stem

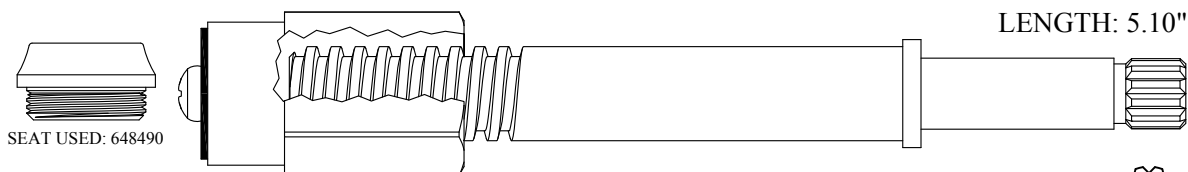

SEAT USED: 648490

LENGTH: 5.10"

408552

208552 Stem Only

GASKET: 894960 INCLUDED

12
1-2

FOR MILWAUKEE

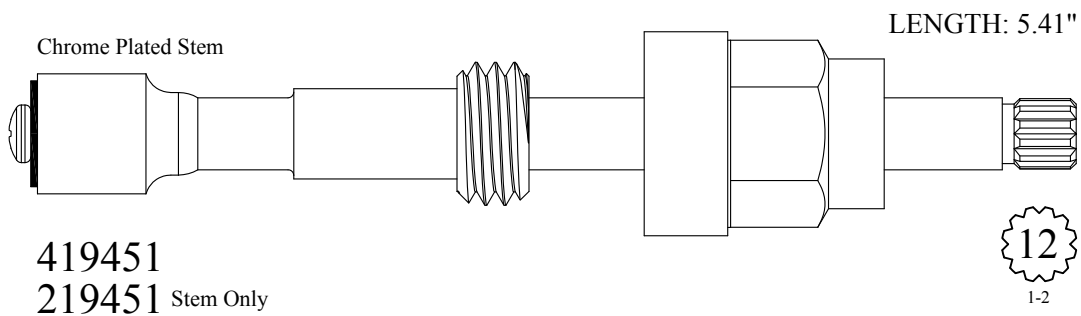
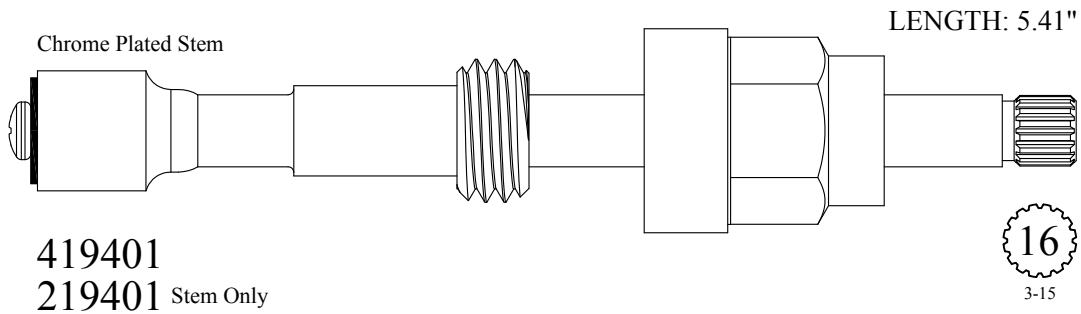
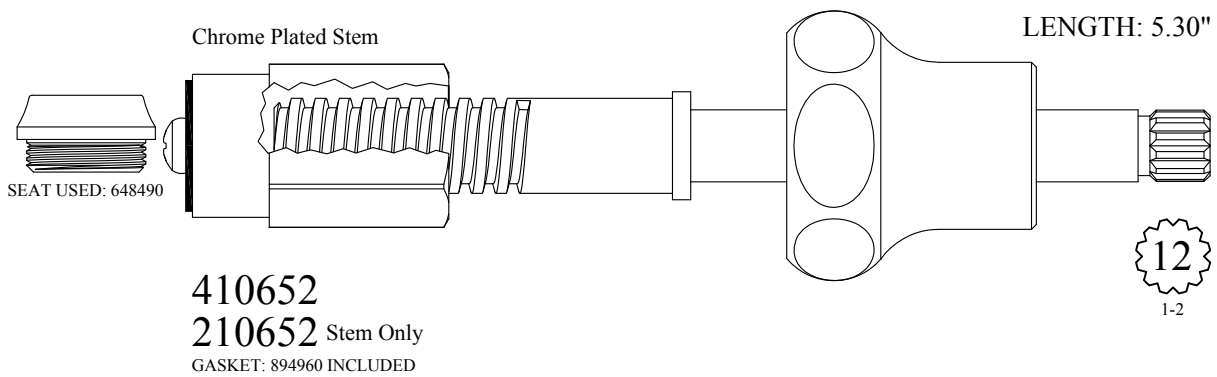
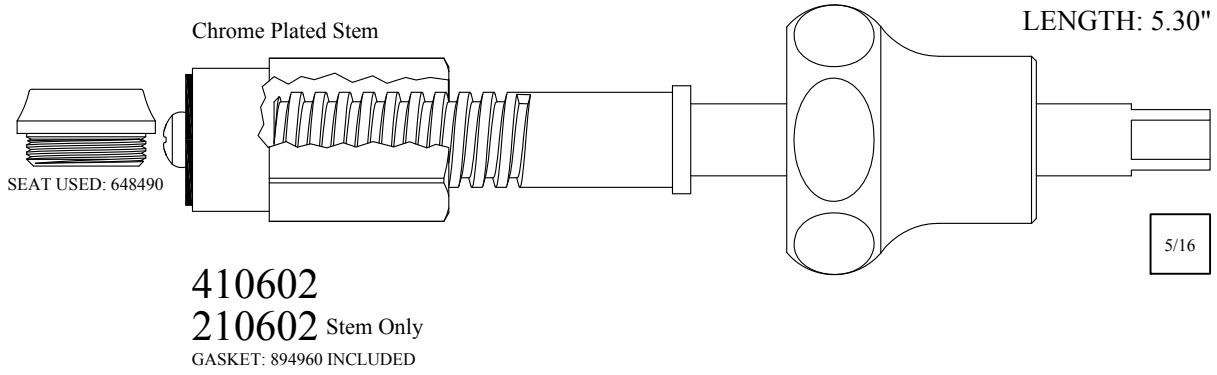

FOR MILWAUKEE

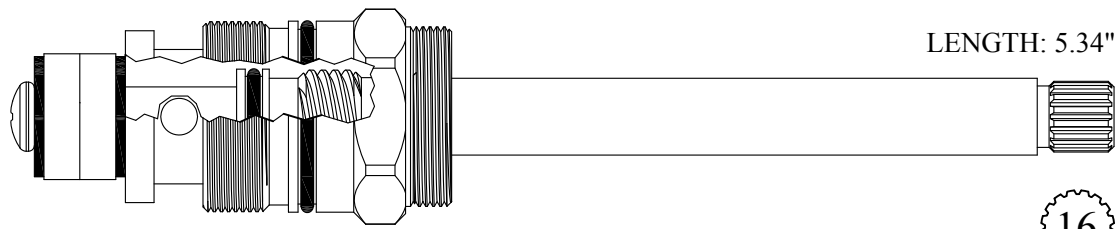

434721

GASKET: 890200 O-RING INCLUDED

16
3-15

Chrome Plated Stem

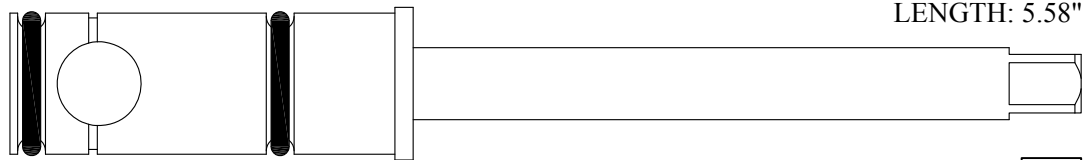

237420

5/16

Chrome Plated Stem

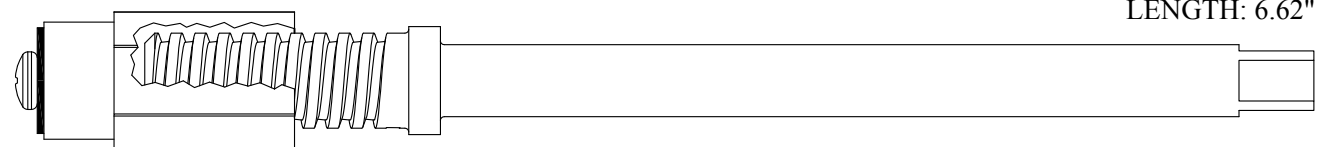

426312

226312 Stem Only

5/16

BARRY E.  SR. CO.

FOR MIXET

LENGTH: 1.60"

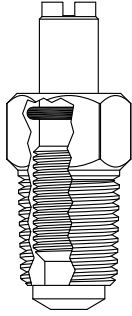

400721

LENGTH: 1.70"

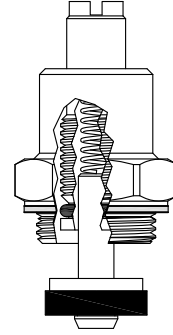

GASKET: 895060 INCLUDED

400371

LENGTH: 2.13"

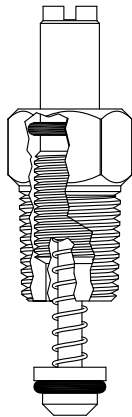

400731

LENGTH 2.27"

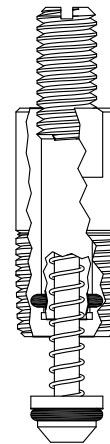

400901

FOR MOEN

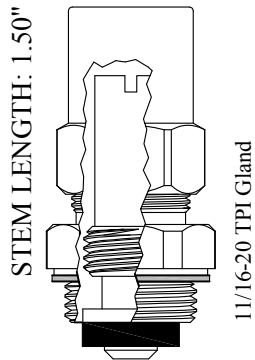

GASKET: 895110 INCLUDED

400311

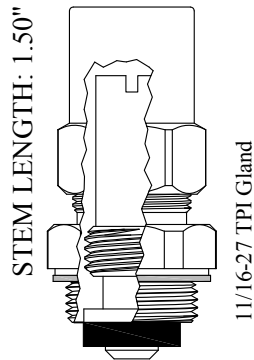

GASKET: 895110 INCLUDED

400321

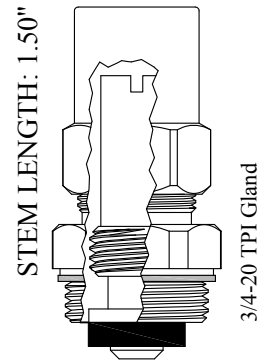

GASKET: 895110 INCLUDED

400341

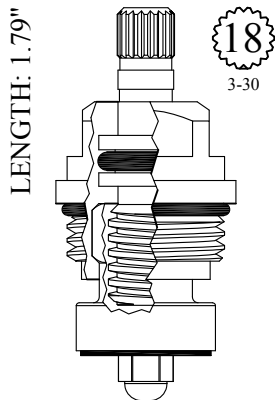

GASKET: 890180 O-RING INCLUDED

LF455362

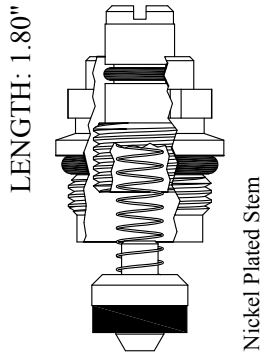

GASKET: 891140 O-RING INCLUDED

400421

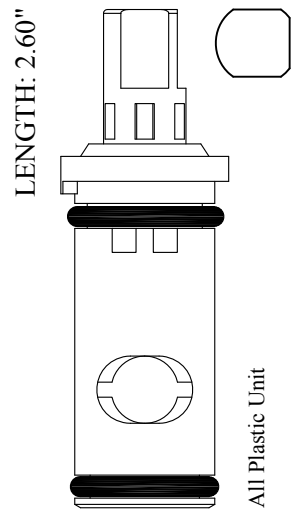

464300

FOR MOEN

Chrome Plated Stem & Tube

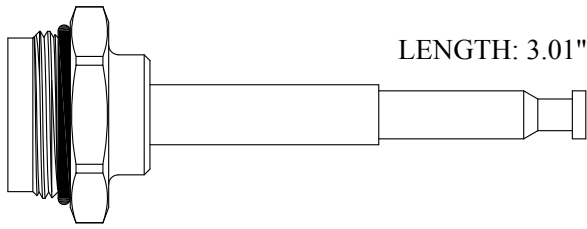

430450

GASKET: 890190 O-RING INCLUDED

Chrome Plated Stem & Tube

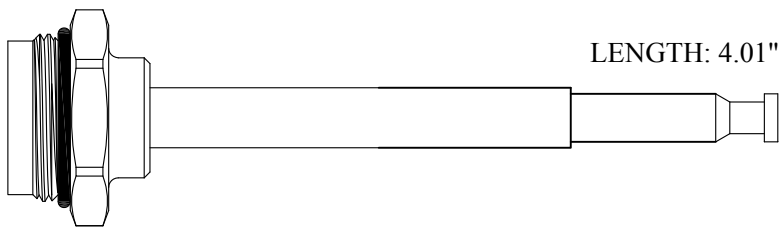

430460

GASKET: 890190 O-RING INCLUDED

Chrome Plated Stem & Tube

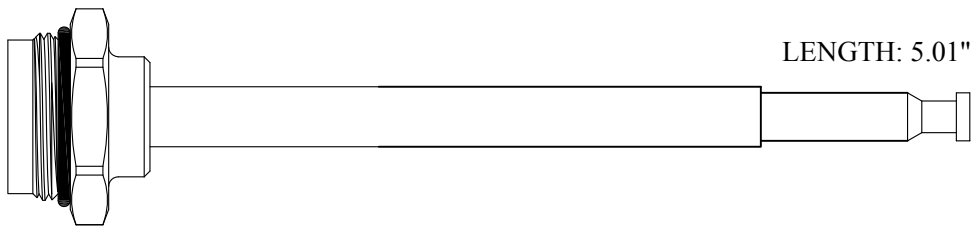

430590

GASKET: 890190 O-RING INCLUDED

BARRY E.  ALTER  SR. CO.

FOR MOUNTAIN

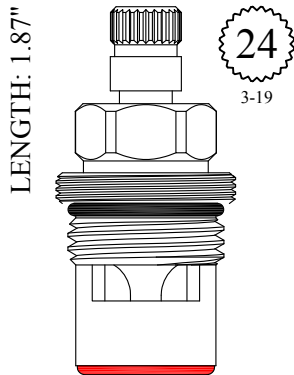

GASKET: 890170 O-RING INCLUDED
SEAL: 898570-R/B
DISC SET: 151380-PKG

LF456371
LF456372

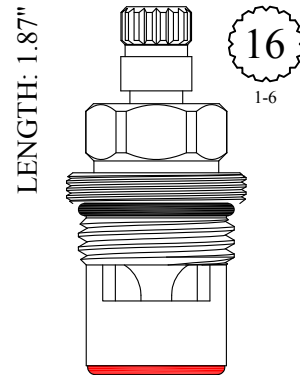

GASKET: 890170 O-RING INCLUDED
SEAL: 898570-R/B
DISC SET: 151380-PKG

LF456381
LF456382

Send Your Orders To:

BARRY E.  SR. CO.

E-mail: orderdesk@barrywalter.com

Fax: 1.800.886.9831

Phone: 1.800.767.5552

FOR MUELLER

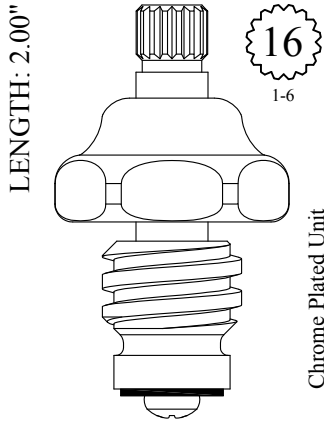

LF459011
 LF459012
 LF259011 Stem Only
 LF259012 Stem Only

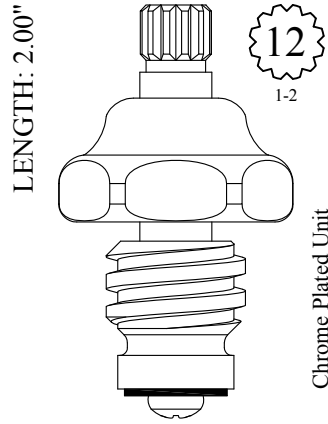

LF459061
 LF459062
 LF259061 Stem Only
 LF259062 Stem Only

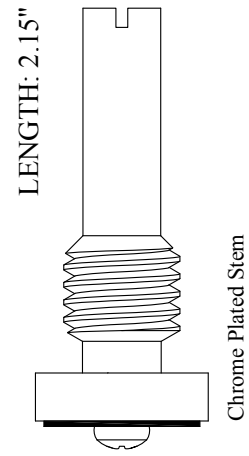

201141

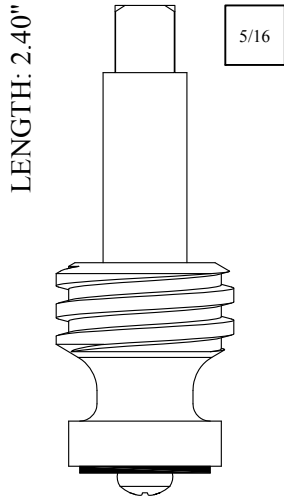

263341

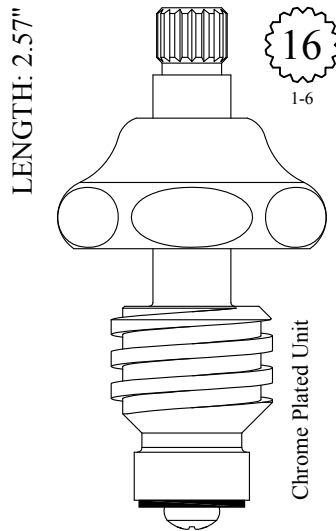

401401
 201401 Stem Only

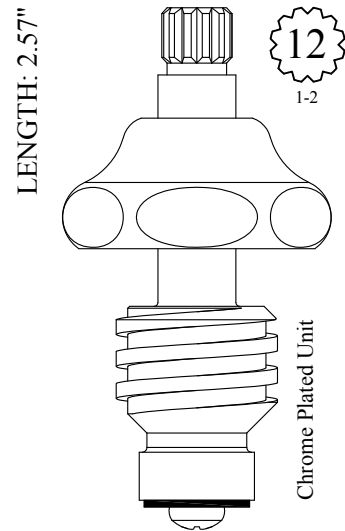

401451
 201451 Stem Only



SEAT USED: LF649190

FOR MUELLER

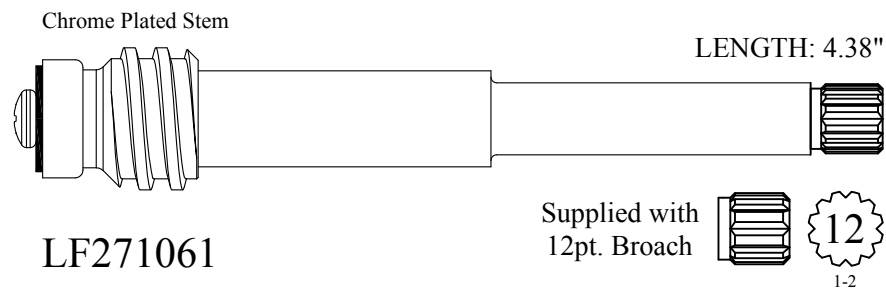
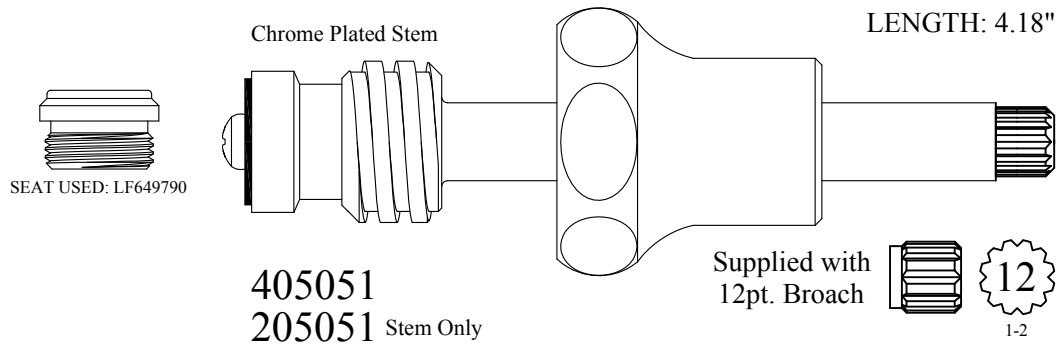
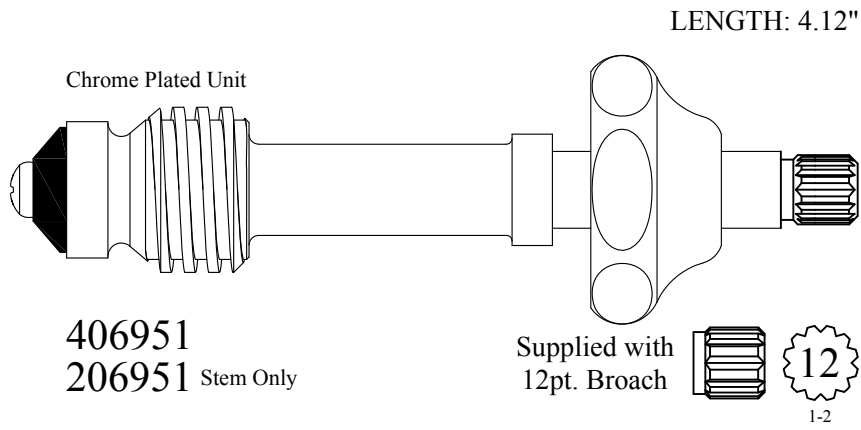
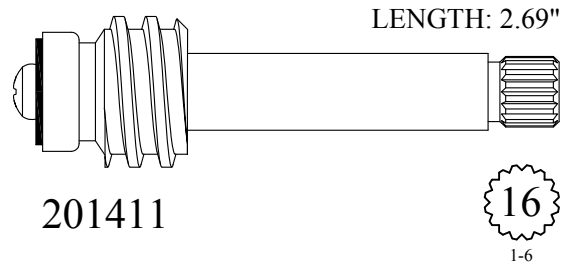

FOR MUELLER

LENGTH: 4.45"



406551
206551 Stem Only

Supplied with
12pt. Broach

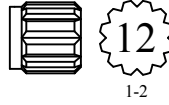

Chrome Plated Stem

LENGTH: 4.78"

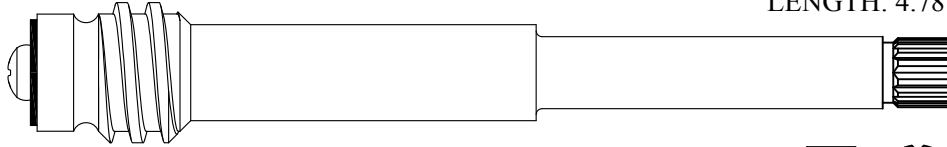

LF274061

Supplied with
12pt. Broach

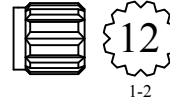

Chrome Plated Stem

LENGTH: 4.87"

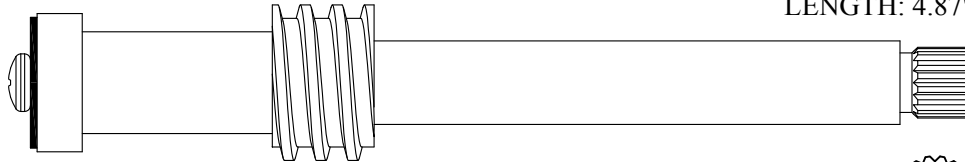

210021



Chrome Plated Stem

LENGTH: 5.03"

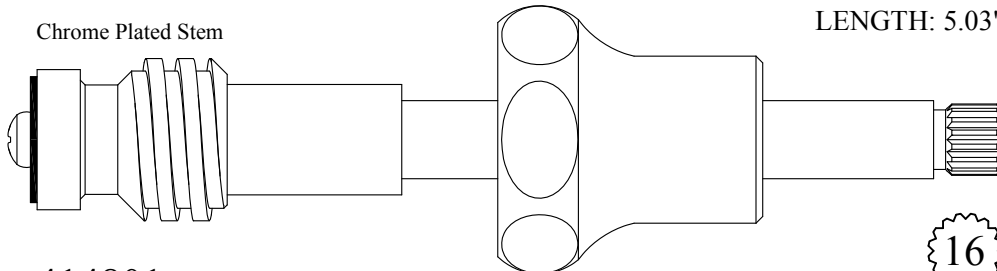

414801
214801 Stem Only



Send Your Orders To:

BARRY E.  SR. CO.

E-mail: orderdesk@barrywalter.com

Fax: 1.800.886.9831

Phone: 1.800.767.5552



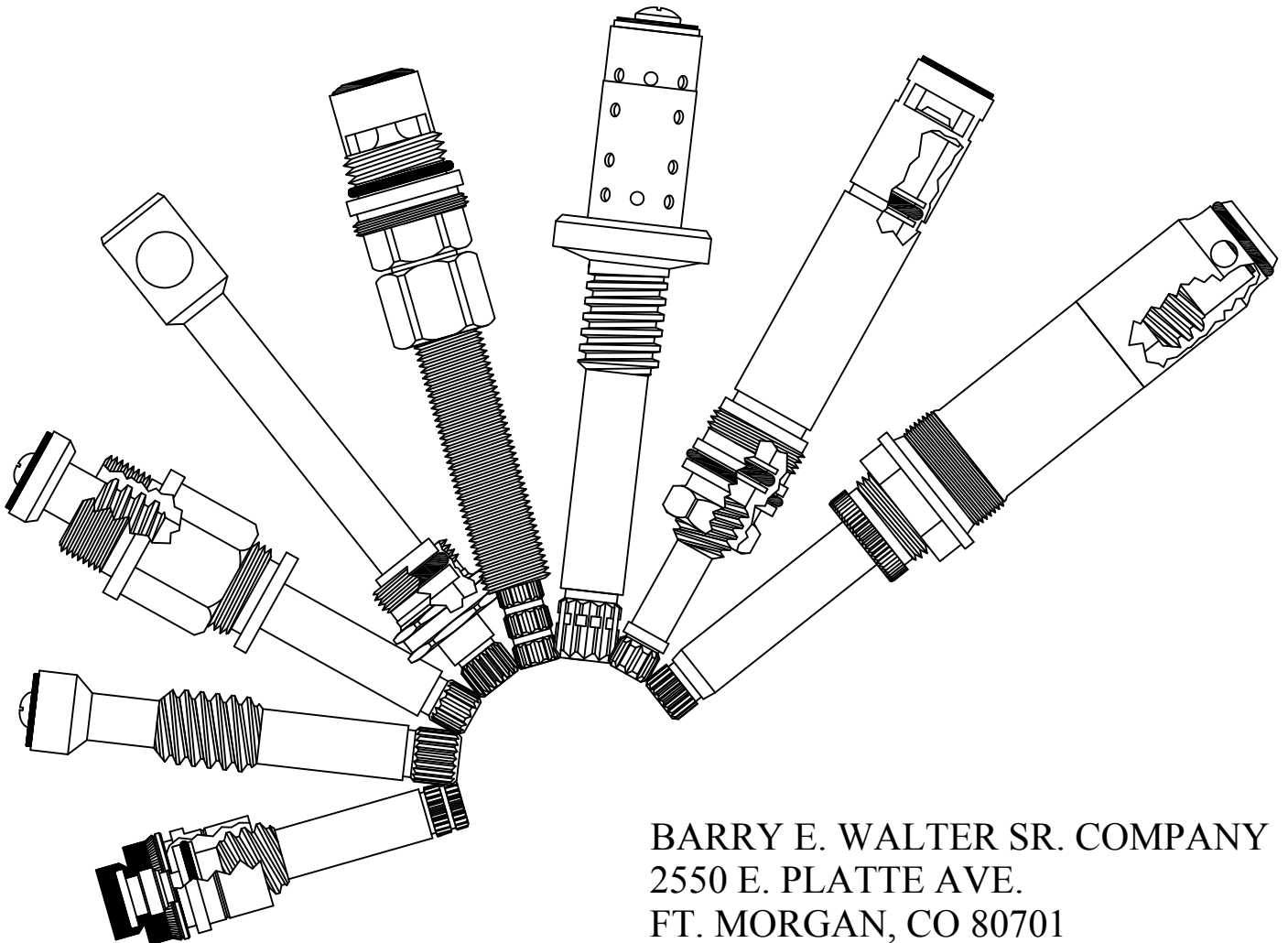

Quality Replacement Parts

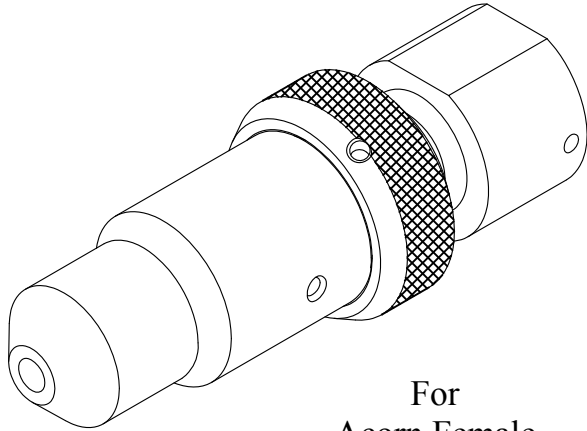

BARRY E. WALTER SR. COMPANY
2550 E. PLATTE AVE.
FT. MORGAN, CO 80701

*We are always adding
new parts. Check our
website for updates.*



For
Acorn Female
OEM# 1174-001-001
123100: 2.5 GPM

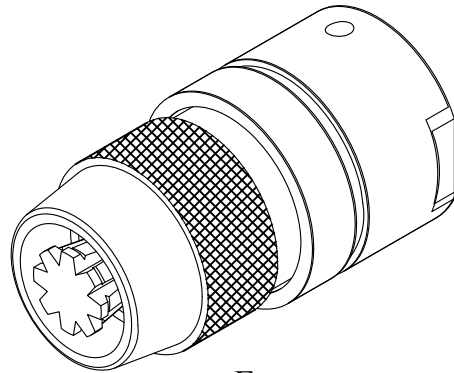

For
Symmons "Free-Flo" Rigid
OEM# 4-285F
112620: 2.5 GPM

MORE SHOWERHEADS AVAILABLE ONLINE

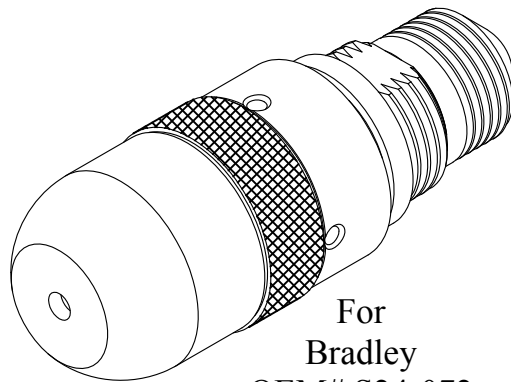

For
Bradley
OEM# S24-072
112450: 1.5 GPM
112130: 2.5 GPM
122380: 3.0 GPM

BARRY E.  ALTER  SR. CO.

FOR MUELLER

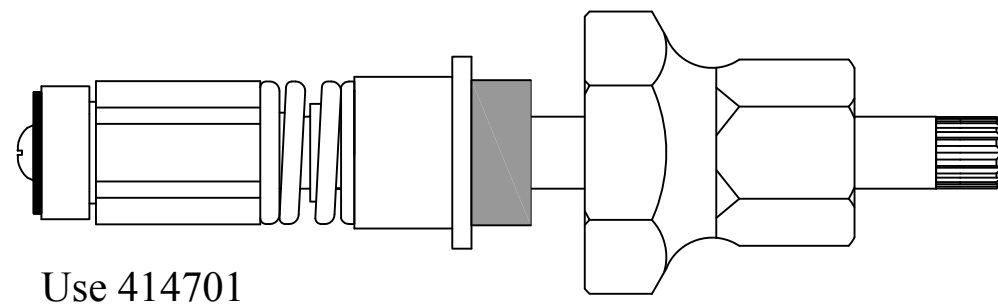
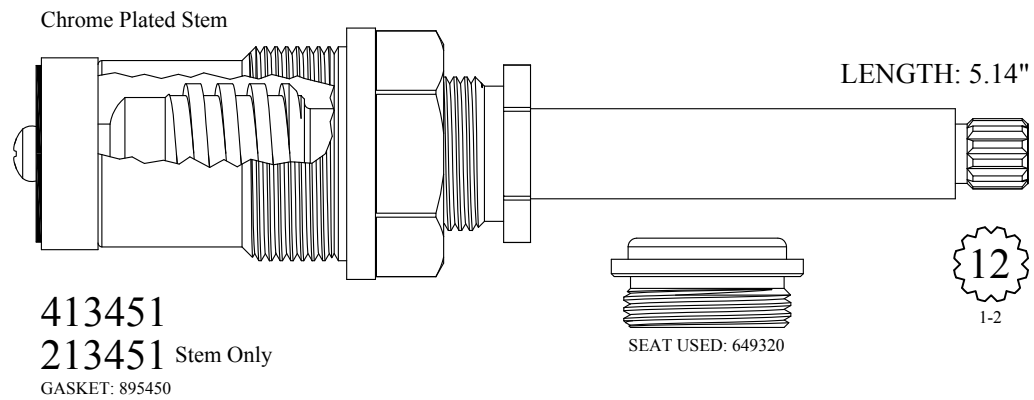
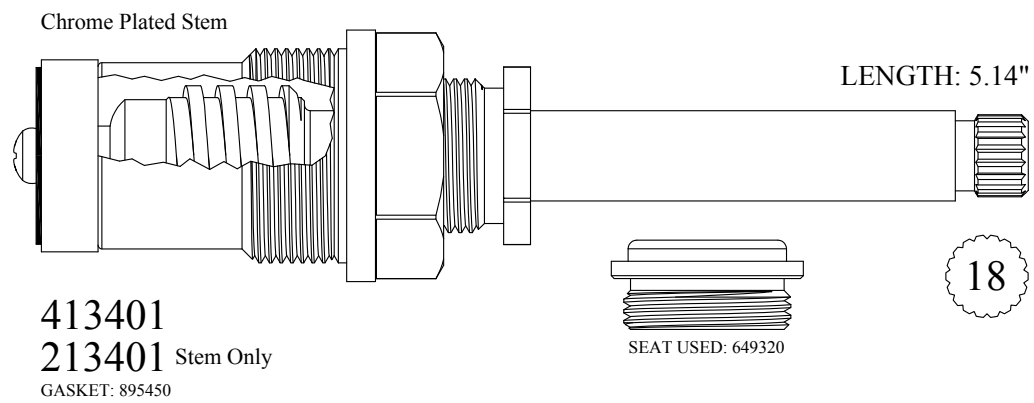
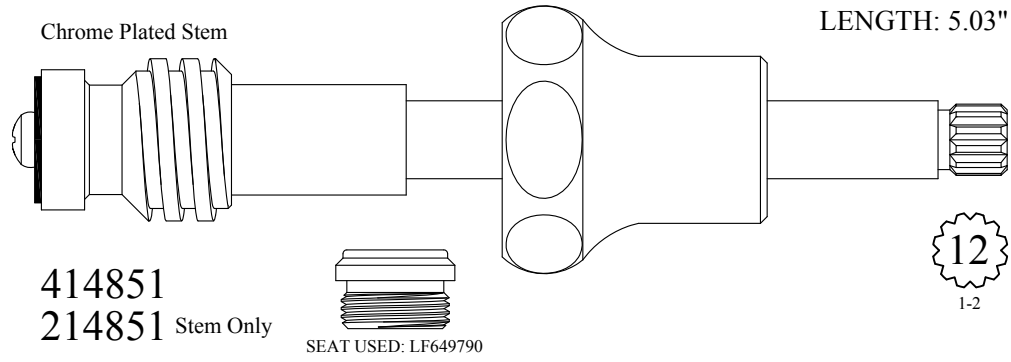

FOR MUELLER

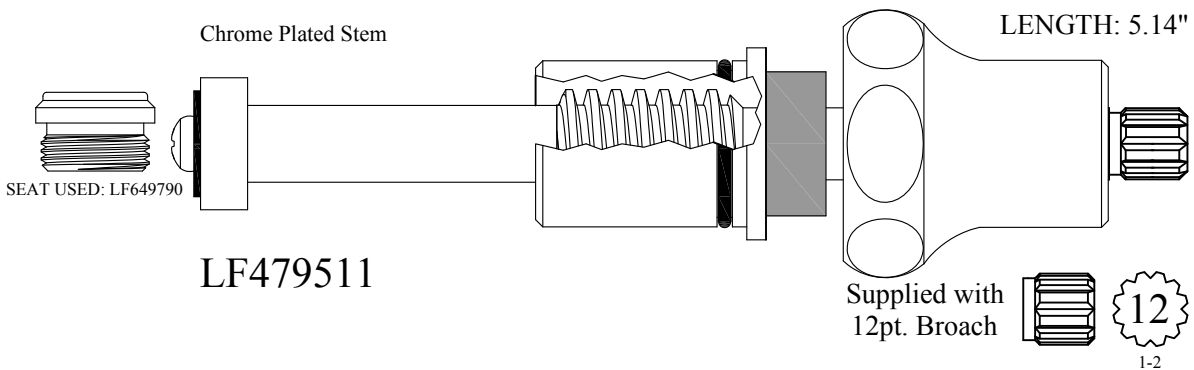
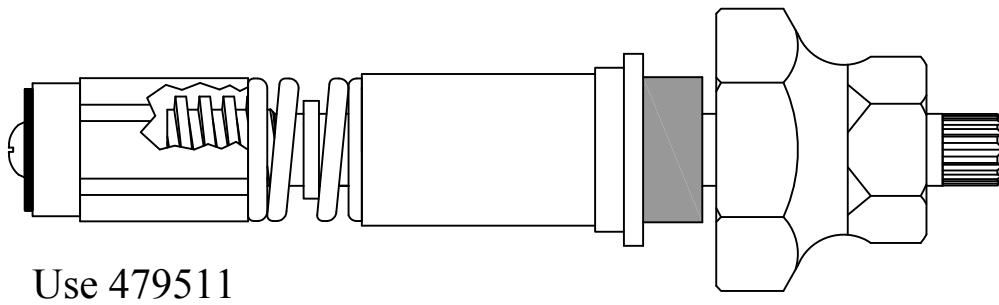
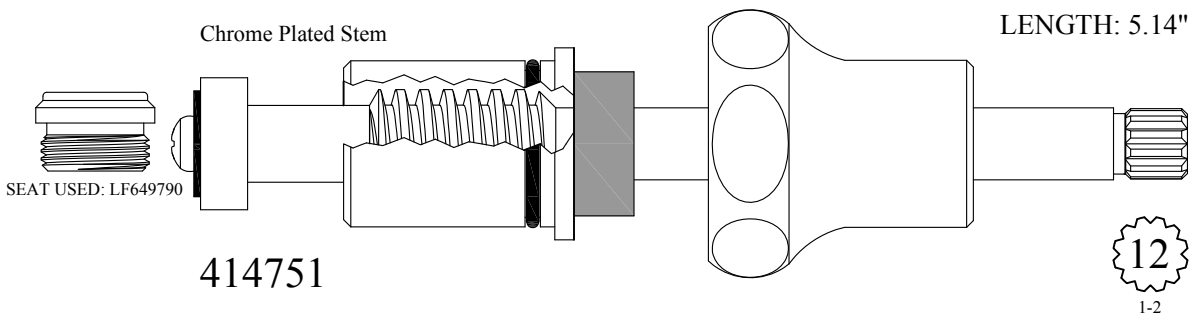
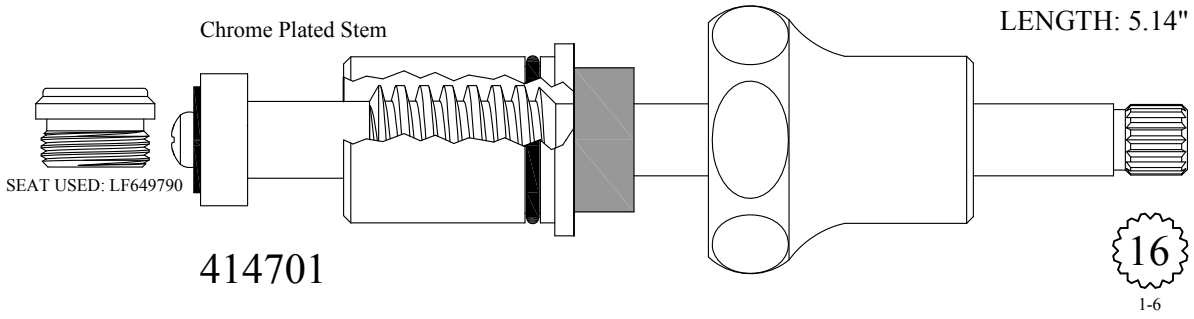

FOR MUELLER

LENGTH: 5.43"

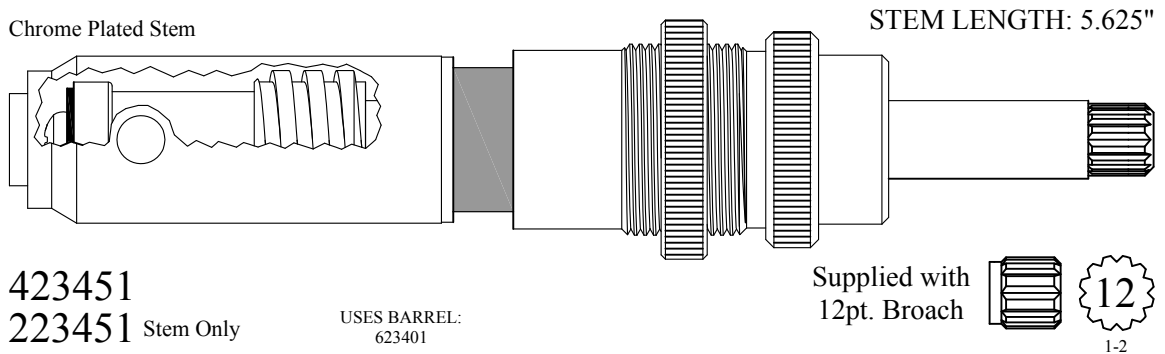
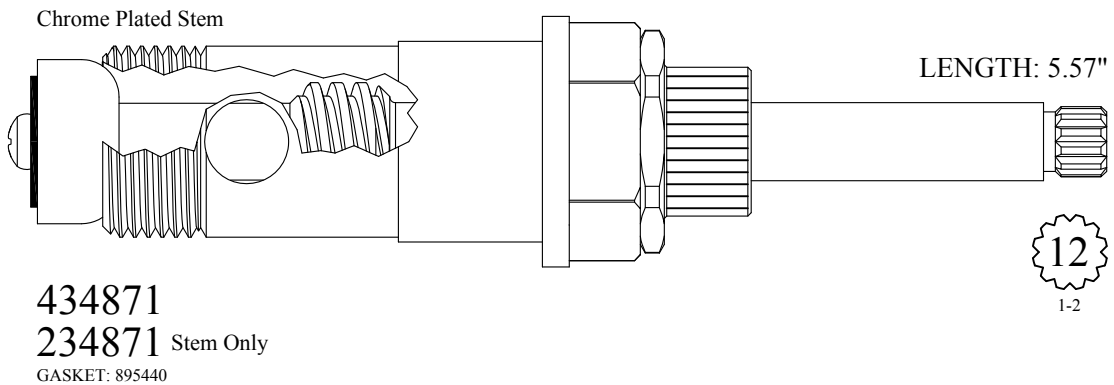
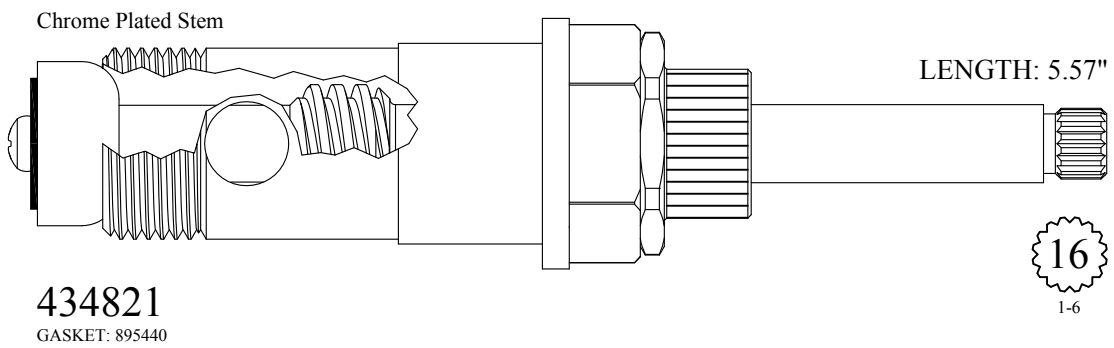
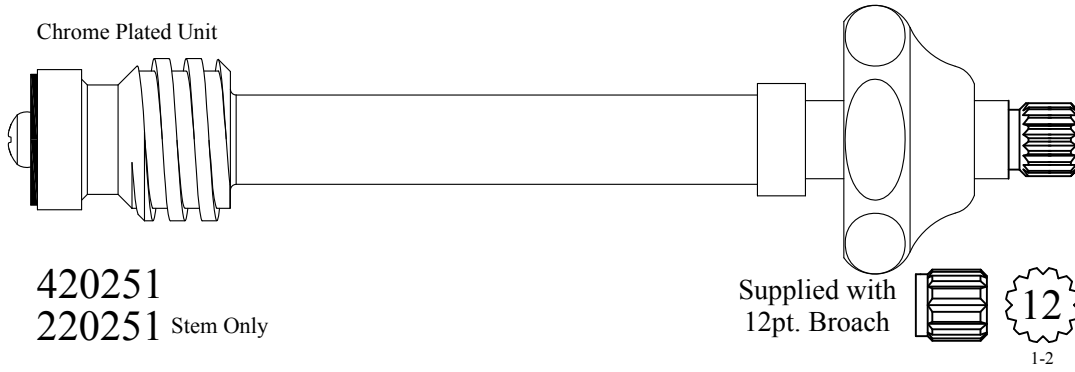

FOR MUELLER

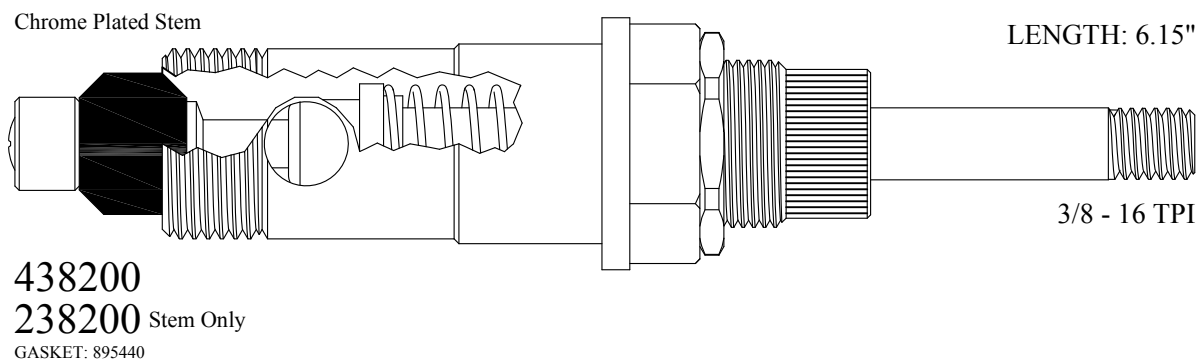
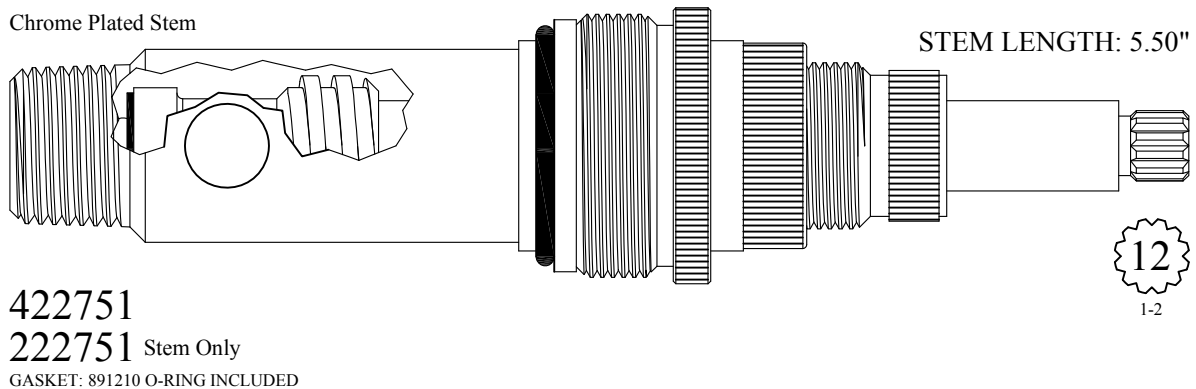
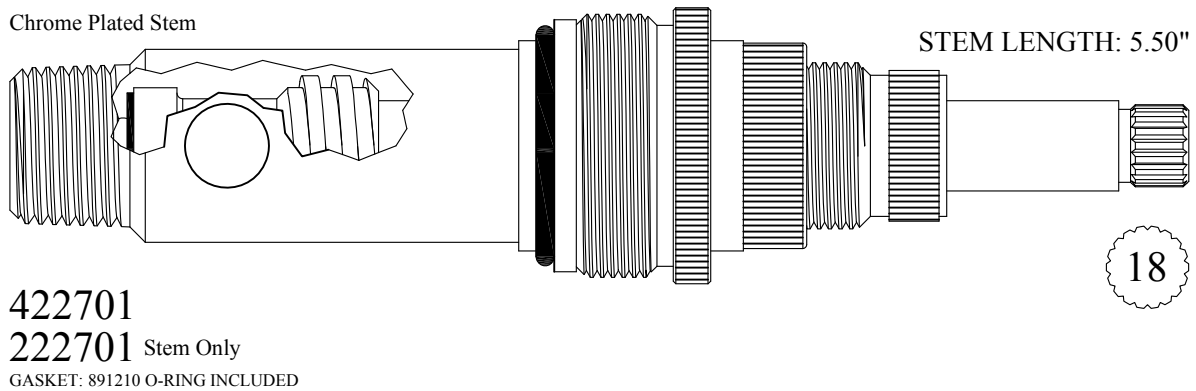
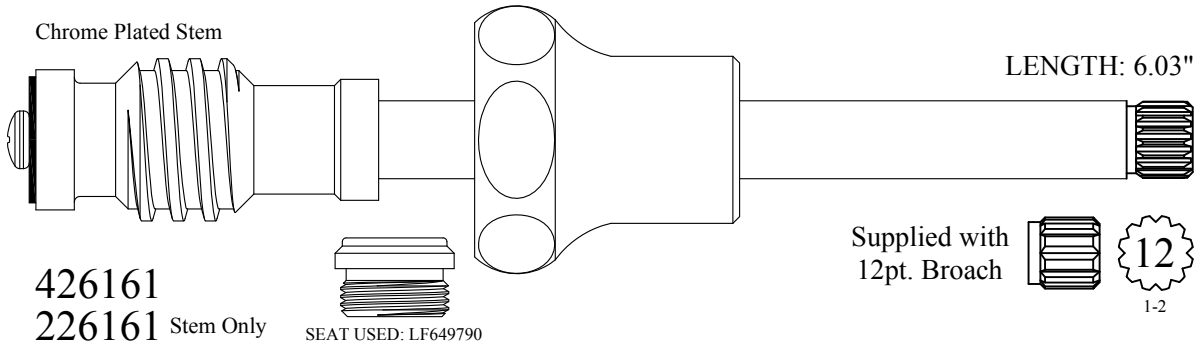

FOR MUELLER

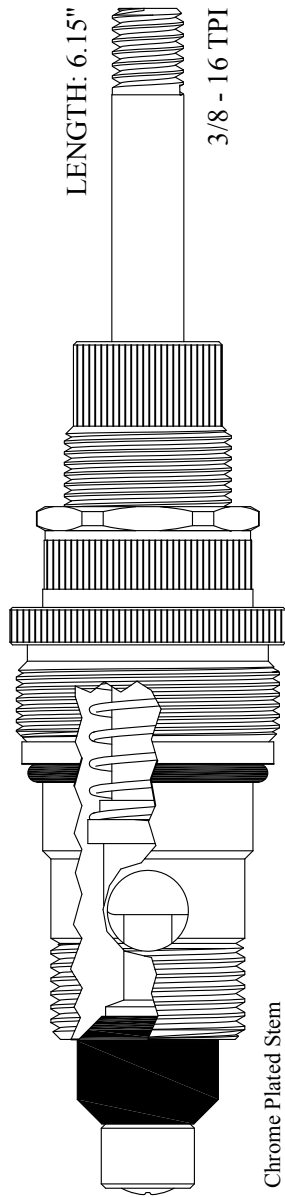

438210
238200 Stem Only

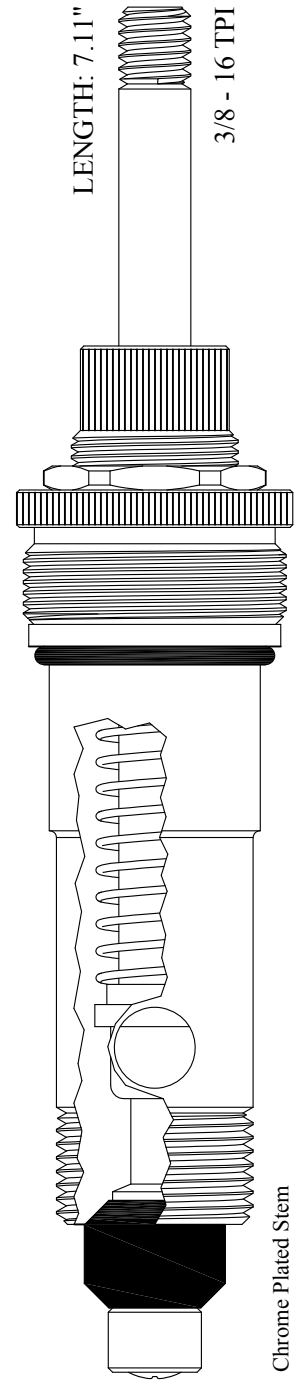

439640
239640 Stem Only

FOR MURRAY & SORENSON

Chrome Plated Stem

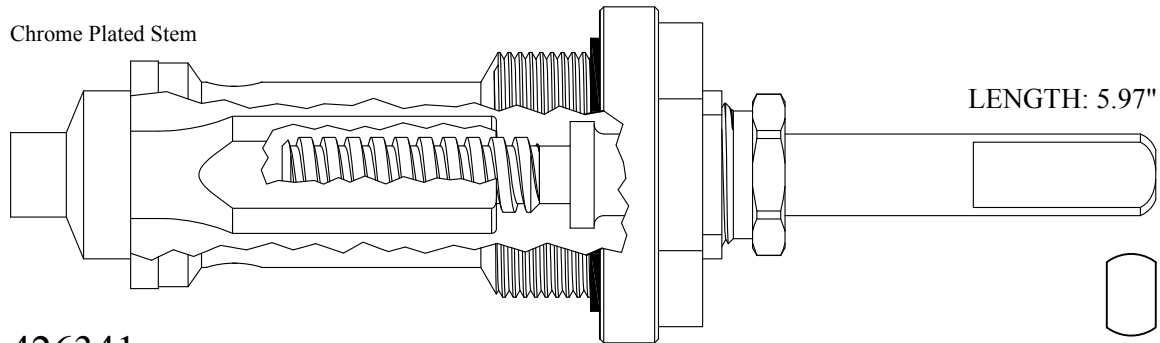

426341

226331 Stem Only

GASKET: 895460 INCLUDED

Chrome Plated Stem

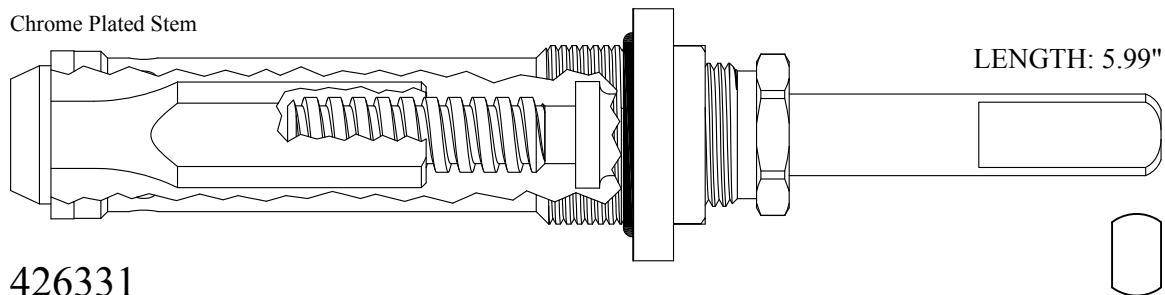

426331

226331 Stem Only

GASKET: 891180 O-RING INCLUDED

Send Your Orders To:

BARRY E.  WALTER  SR. CO.

E-mail: orderdesk@barrywalter.com

Fax: 1.800.886.9831

Phone: 1.800.767.5552

FOR NEWPORT

LENGTH: 2.24"

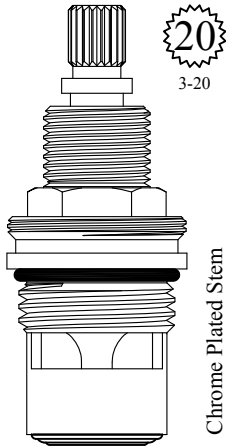

Chrome Plated Stem

GASKET: 890170 O-RING INCLUDED
SEAL: 898510-W
DISC SET: 151380-PKG

LF460361
LF460362

LENGTH: 2.60"

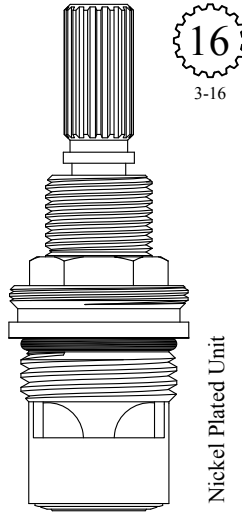

Nickel Plated Unit

GASKET: 890170 O-RING INCLUDED
SEAL: 898510-W
DISC SET: 151380-PKG

LF464361
LF464362

LENGTH: 2.71"

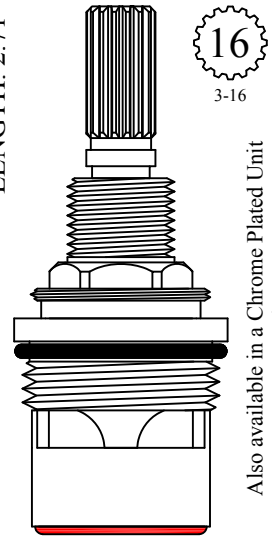

Also available in a Chrome Plated Unit

401651-CP / 401652-CP

GASKET: 890210 O-RING INCLUDED
SEAL: 898610-R/B
DISC SET: 109850-PKG

401651
401652

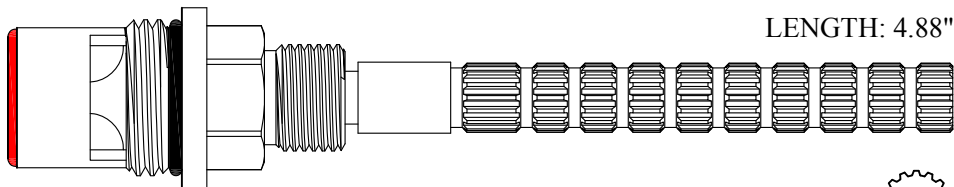

LENGTH: 4.88"

411221/ 411222

GASKET: 890170 O-RING INCLUDED
SEAL: 898570-R/B
DISC SET: 151380-PKG

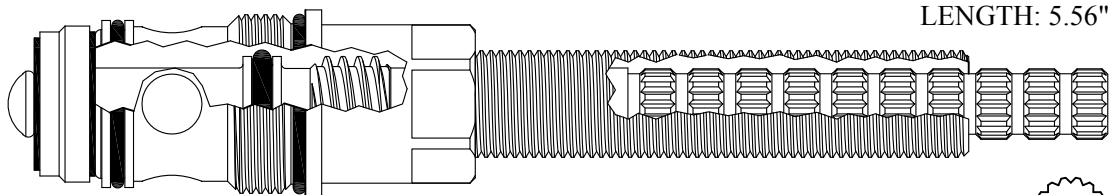

LENGTH: 5.56"

433371

GASKET: 890190 O-RING INCLUDED



SEAT USED: 647650



FOR NEWPORT

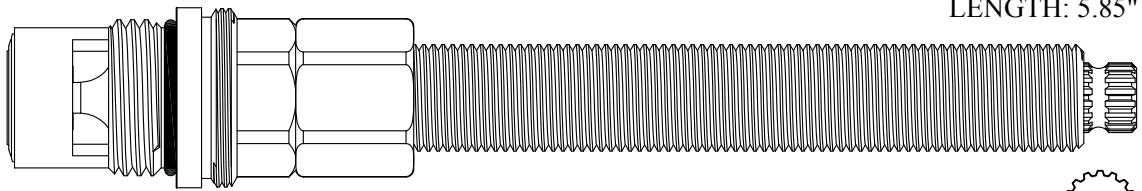

LENGTH: 5.85"

411271/ 411272

GASKET: 890170 O-RING INCLUDED
SEAL: 898510-W
DISC SET: 151380-PKG

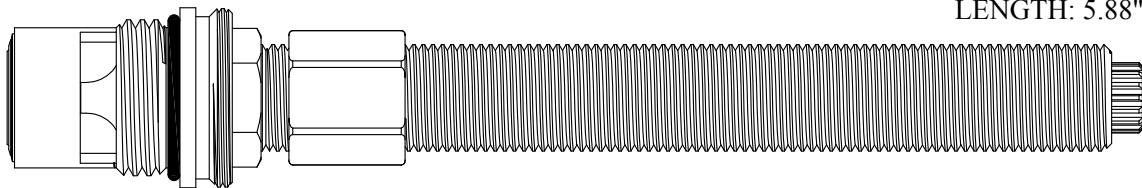

LENGTH: 5.88"

411281/ 411282

GASKET: 890170 O-RING INCLUDED
SEAL: 898510-W
DISC SET: 151380-PKG

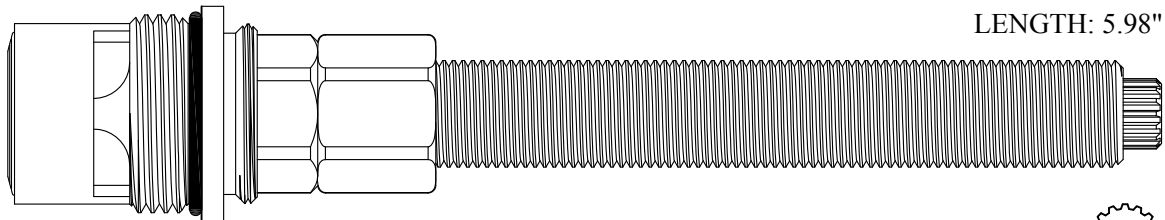

LENGTH: 5.98"

424911/ 424912

GASKET: 890210 O-RING INCLUDED
SEAL: 898520
DISC SET: 109850-PKG

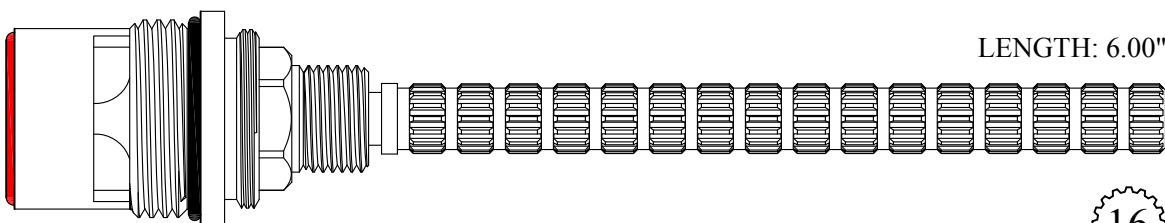

LENGTH: 6.00"

423651/ 423652

GASKET: 890210 O-RING INCLUDED
SEAL: 898610-R/B
DISC SET: 109850-PKG



FOR NEWPORT

Wall and Deck Models

To identify a 4 or 5-Port Unit, look down the stem from the broach end at the dent bushing. Refer to the images below:

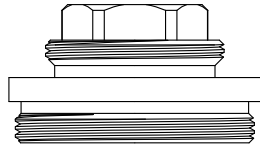

730560

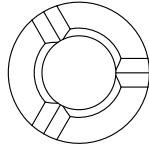

4-Port

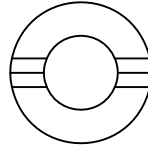

5-Port

LENGTH: 8.17"



LENGTH: 6.05"

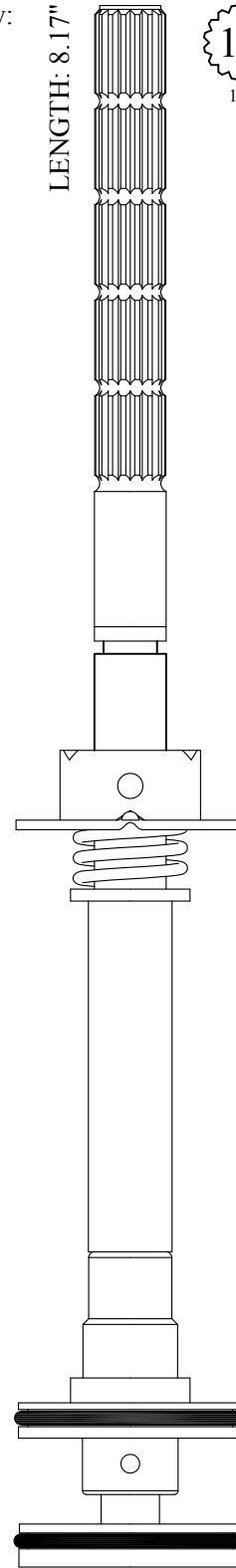
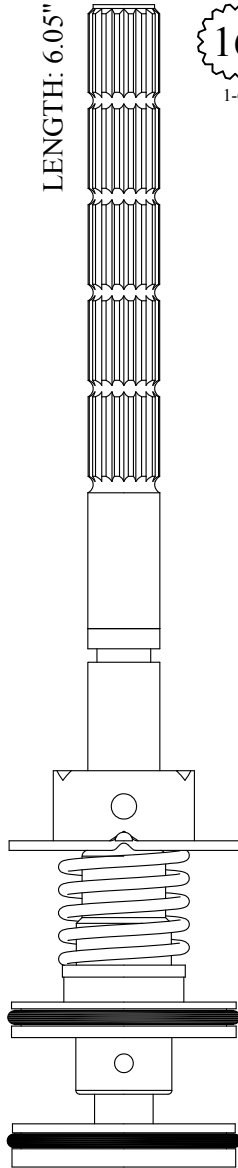

Wall Model	
4-Port	238320
5-Port	238330
W/ 730560 Bonnet	
4-Port	438320
5-Port	438330

Deck Model	
4-Port	239860
5-Port	239870
W/ 730560 Bonnet	
4-Port	439860
5-Port	439870

FOR NFC / AMERICAN FAUCETS

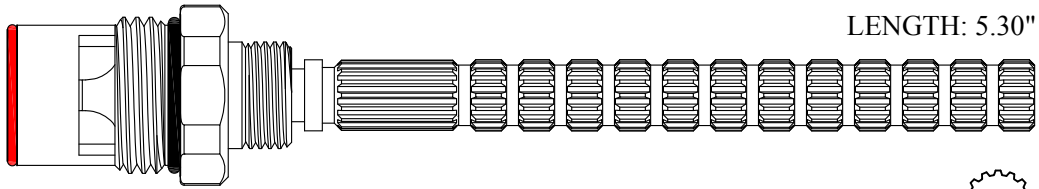

417221/ 417222

GASKET: 890170 O-RING INCLUDED
SEAL: 898580-R/B
DISC SET: 151380-PKG

16
3-16

FOR NIBCO

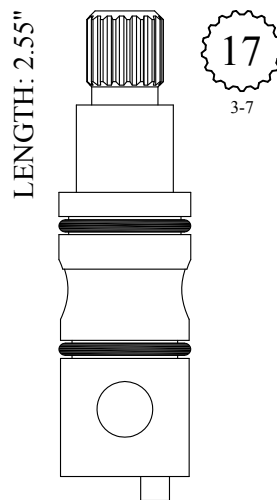

230730

FOR NICOLAZZI

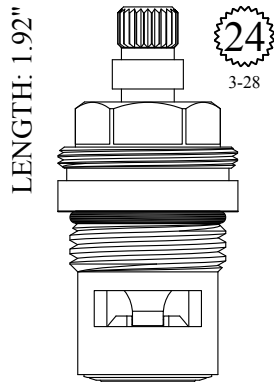

GASKET: 890170 O-RING INCLUDED
SEAL: 898510-W
DISC SET: 151380-PKG

LF456921
LF456922

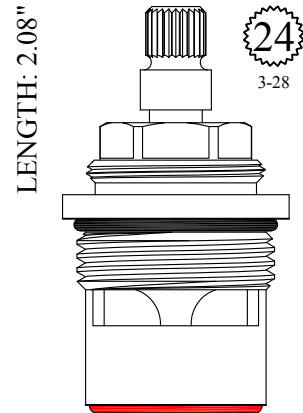

GASKET: 890210 O-RING INCLUDED
SEAL: 898610-R/B
DISC SET: 109850-PKG

401011
401012

FOR NORCA

Nickel Plated Unit

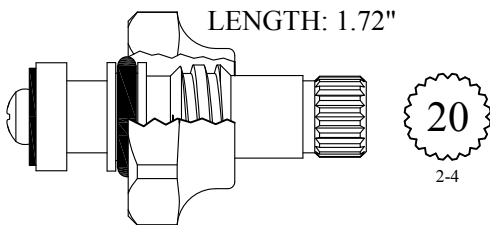

LF454181/ LF454182

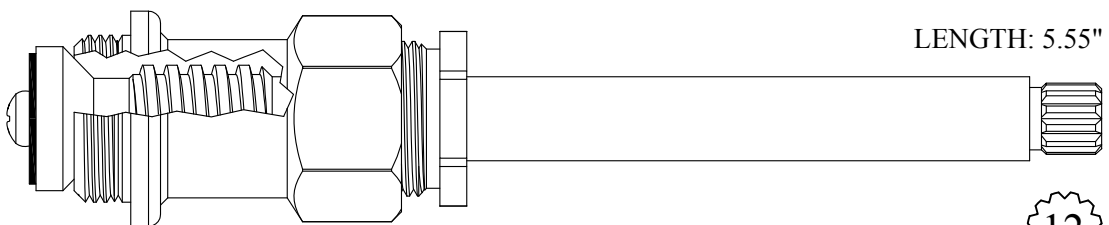

421631
GASKET: 895400

FOR OMNI

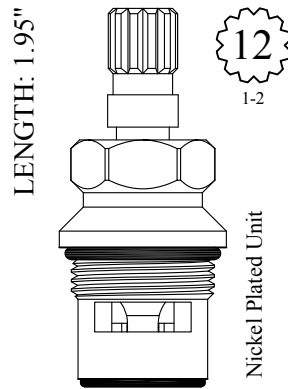

GASKET: 890170 O-RING INCLUDED
SEAL: 898540
DISC SET: 112530-PKG

LF458821
LF458822

FOR ONDINE

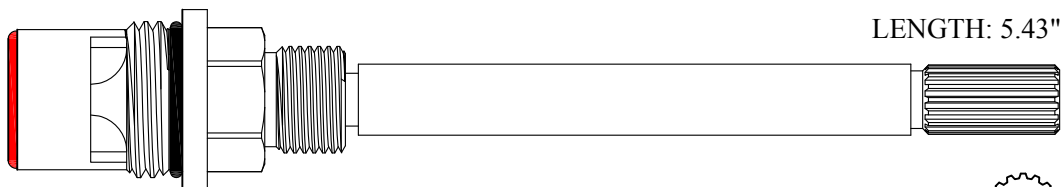

421221/ 421222

GASKET: 890170 O-RING INCLUDED
SEAL: 898570-R/B
DISC SET: 151380-PKG

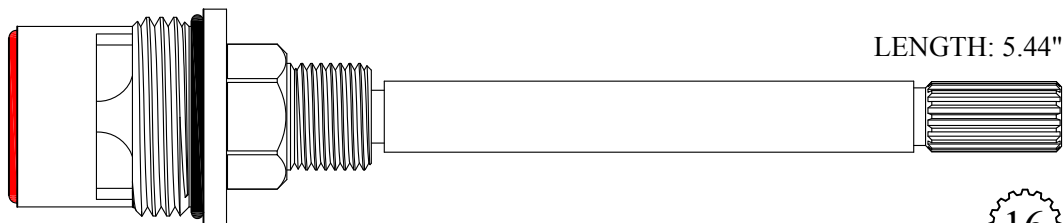

421241/ 421242

GASKET: 890210 O-RING INCLUDED
SEAL: 898610-R/B
DISC SET: 109850-PKG



FOR ORION

LENGTH: 2.18"

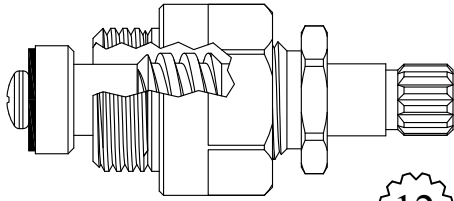

12
1-2

LF460601

GASKET: 895100

LENGTH: 4.47"

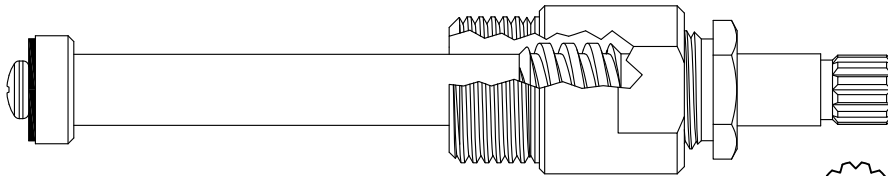

12
1-2

LF473101

LENGTH: 4.64"

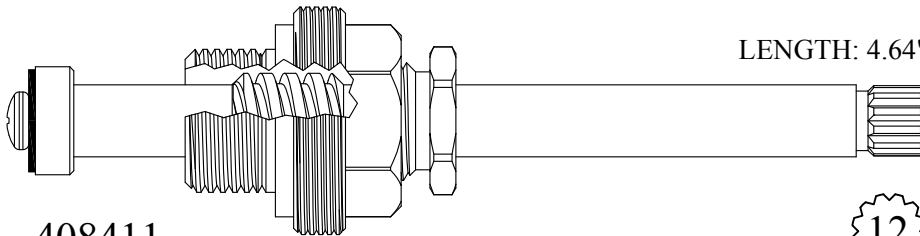

12
1-2

408411

GASKET: 895100

BARRY E.  WALTER  SR. CO.

FOR OTTONE & MELODA

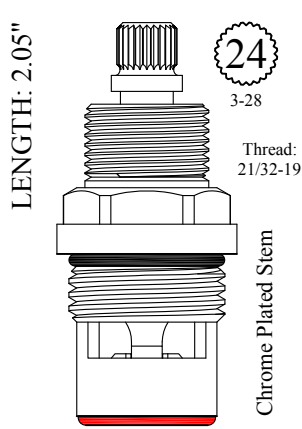

GASKET: 890170 O-RING INCLUDED
SEAL: 898570-R/B
DISC SET: 151380-PKG

LF459691
LF459692

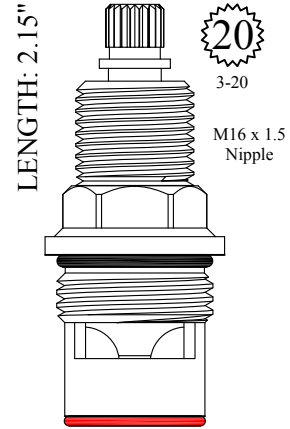

GASKET: 890170 O-RING INCLUDED
SEAL: 898580-R/B
DISC SET: 151380-PKG

LF460841
LF460842

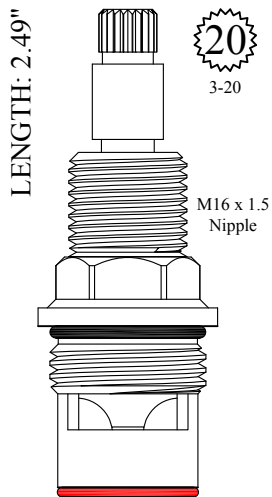

GASKET: 890170 O-RING INCLUDED
SEAL: 898580-R/B
DISC SET: 151380-PKG

LF462841
LF462842

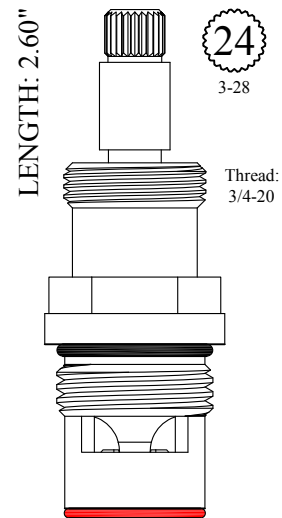

GASKET: 890170 O-RING INCLUDED
SEAL: 898580-R/B
DISC SET: 151380-PKG

LF401391
LF401392

FOR P.E. GUERIN

LENGTH: 1.88"

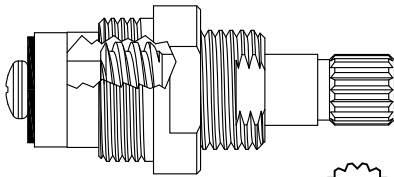

16
1-6

LF456321
LF456322

GASKET: 895100

Chrome Plated Stem

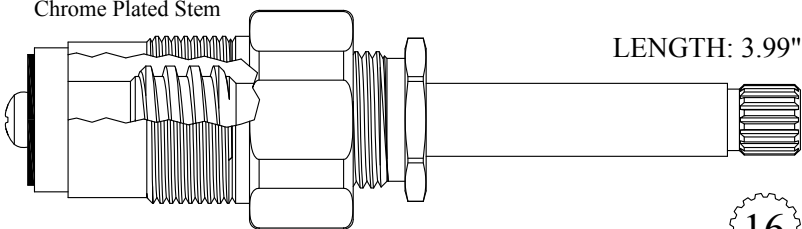

LENGTH: 3.99"

16

404421/ 404422

GASKET: 895400

Chrome Plated Stem

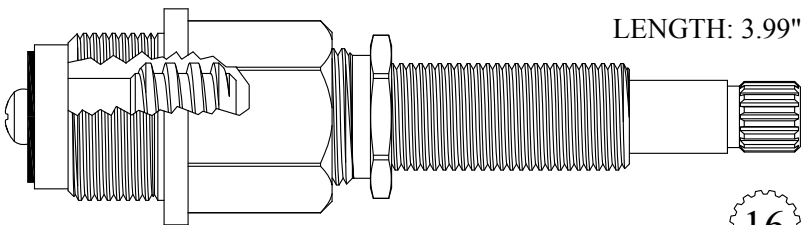

LENGTH: 3.99"

16

404431/ 404432

GASKET: 895400

Ceramic Conversion for 412811

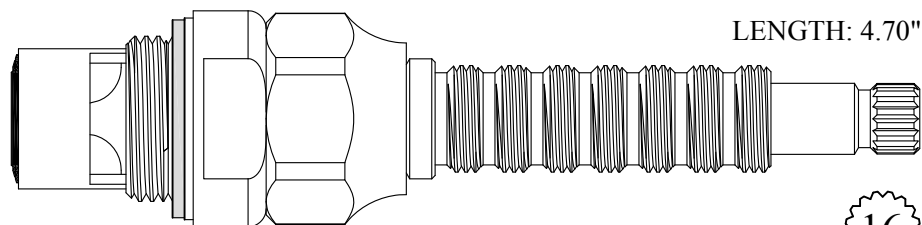

LENGTH: 4.70"

16

407991

GASKET: 895400 INCLUDED

SEAL: 898510

DISC SET: 151380-PKG

1-6

FOR P.E. GUERIN

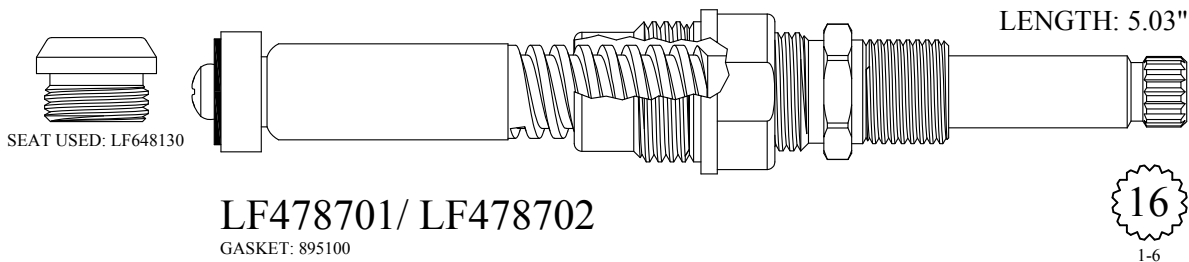
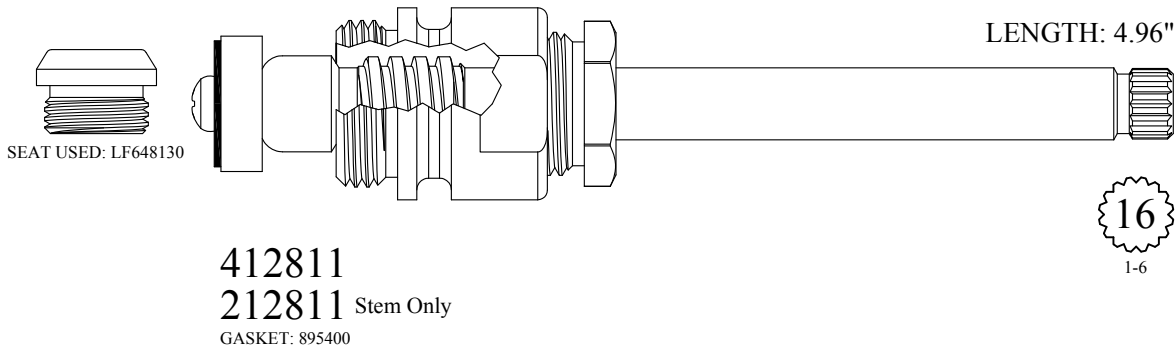

Send Your Orders To:

BARRY E.  SR. CO.

E-mail: orderdesk@barrywalter.com

Fax: 1.800.886.9831

Phone: 1.800.767.5552

FOR PACIFIC

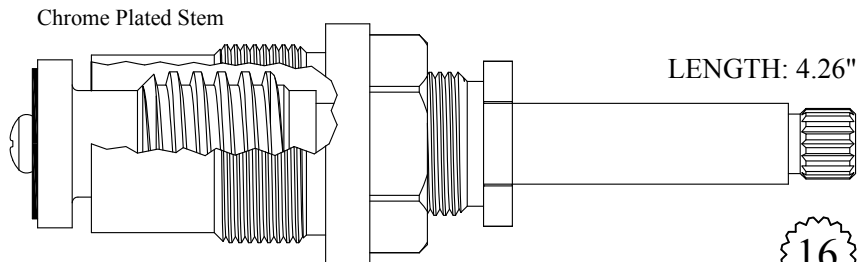

405921
205921 Stem Only
GASKET: 895540

16
1-6

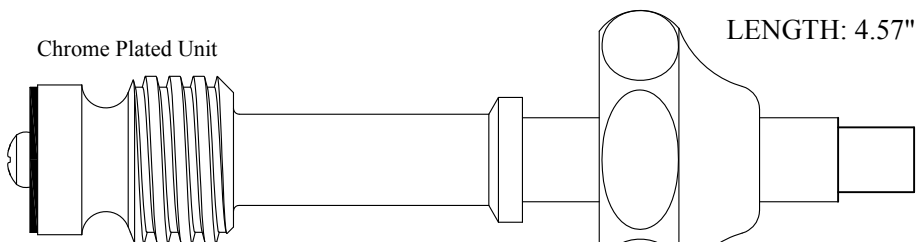

406451
206451 Stem Only

Supplied with
12pt. Broach



12
1-2

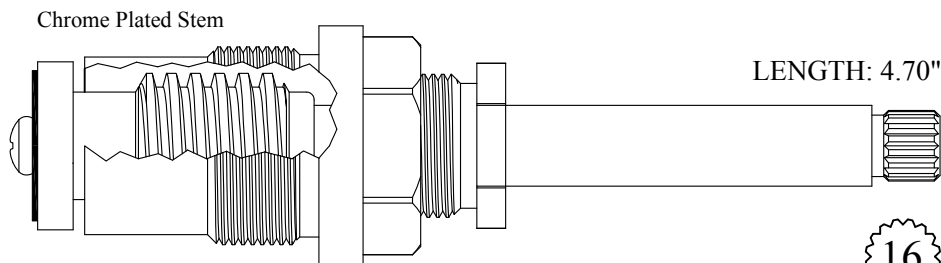

413321
213321 Stem Only
GASKET: 895540

16
1-6

BARRY E.  ALTER  SR. CO.

FOR PACIFICA

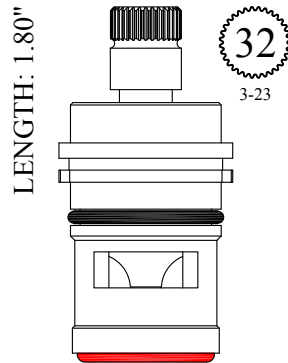

GASKET: 890170 O-RING INCLUDED
SEAL: 898570-R/B
DISC SET: 151380-PKG

LF456221
LF456222

FOR PAINI

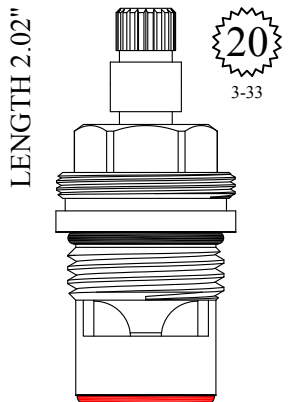

GASKET: 890170 O-RING INCLUDED
SEAL: 898570-R/B
DISC SET: 151380-PKG

LF458891
LF458892

FOR PAUL

LENGTH: 2.08"

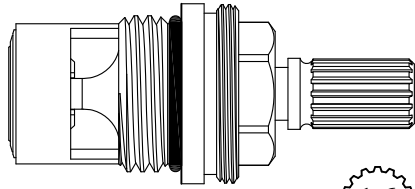

16
3-16

LF461901
LF461902

GASKET: 890170 O-RING INCLUDED
SEAL: 898510-W
DISC SET: 151380-PKG

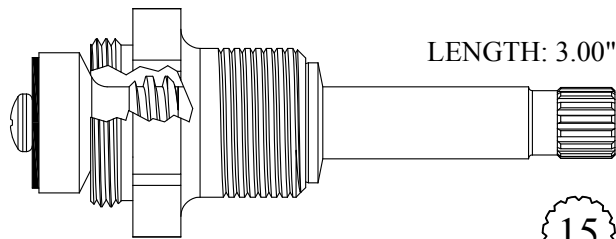

LENGTH: 3.00"

15
3-27

401861/ 401862
201861/ 201862 Stem Only
GASKET: 895400

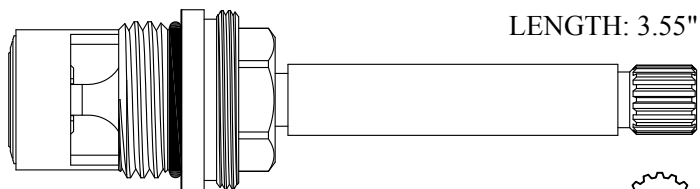

LENGTH: 3.55"

16
3-16

402931/ 402932
GASKET: 890170 O-RING INCLUDED
SEAL: 898510-W
DISC SET: 151380-PKG

Chrome Plated Stem

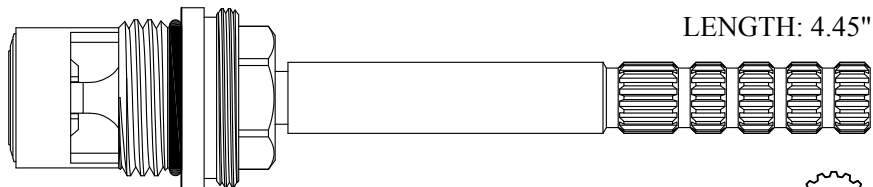

LENGTH: 4.45"

16
3-16

406731/ 406732
GASKET: 890170 O-RING INCLUDED
SEAL: 898510-W
DISC SET: 151380-PKG

FOR PAUL

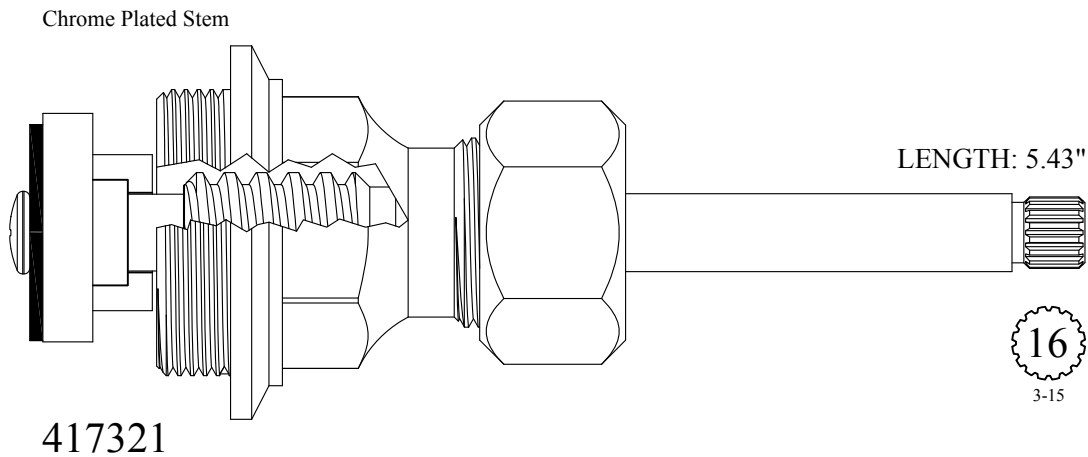

FOR PEGASUS

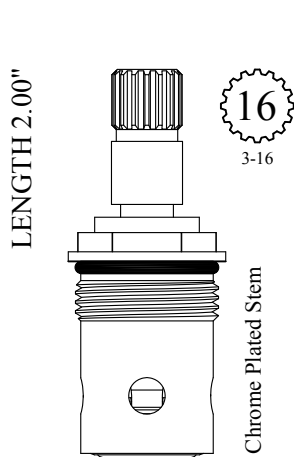

GASKET: 890160 O-RING INCLUDED
SEAL: 898500
DISC SET: 112530-PKG

LF457901
LF457902

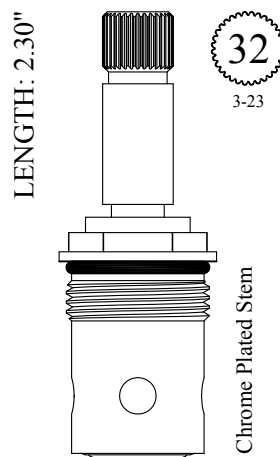

GASKET: 890160 O-RING INCLUDED
SEAL: 898500
DISC SET: 112530-PKG

LF462901
LF462902

FOR PERLICK

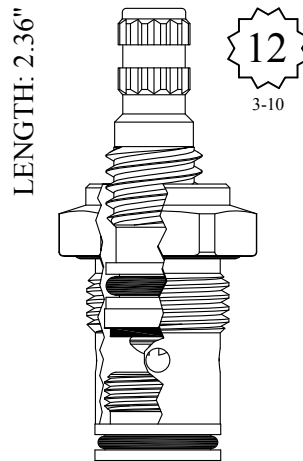

GASKET: 890180 O-RING INCLUDED

LF463351
LF463352

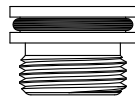

SEAT USED: LF663350

FOR PHOENIX

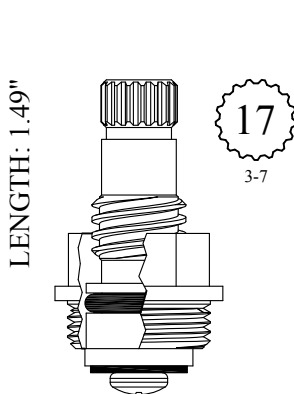

GASKET: 895100

400431



GASKET: 890170 O-RING INCLUDED

LF451171

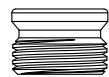

SEAT USED: LF649190



GASKET: 890170 O-RING INCLUDED

LF451181

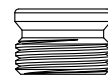

SEAT USED: LF649190

FOR PHOENIX

Single Lead

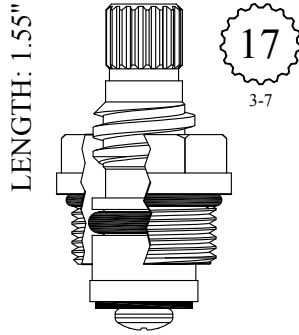

GASKET: 890170 O-RING INCLUDED

LF451211
LF451212



SEAT USED: LF648040

Single Lead

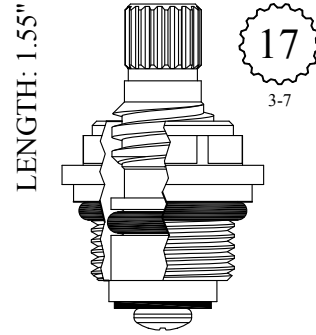

GASKET: 891150 O-RING INCLUDED

LF451221
LF451222

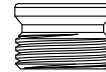

SEAT USED: LF649190

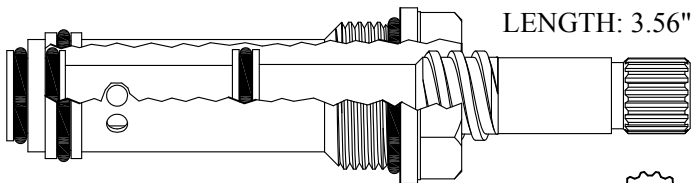

430771

GASKET: 890170 O-RING INCLUDED

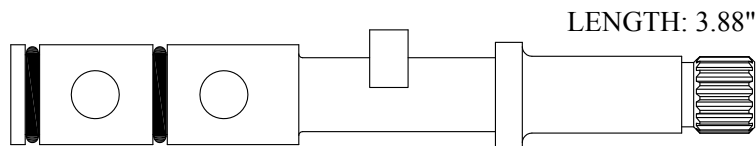

230370

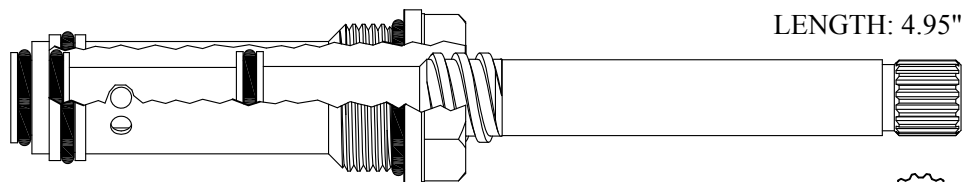

431821

GASKET: 890170 O-RING INCLUDED



Send Your Orders To:

BARRY E.  SR. CO.

E-mail: orderdesk@barrywalter.com

Fax: 1.800.886.9831

Phone: 1.800.767.5552



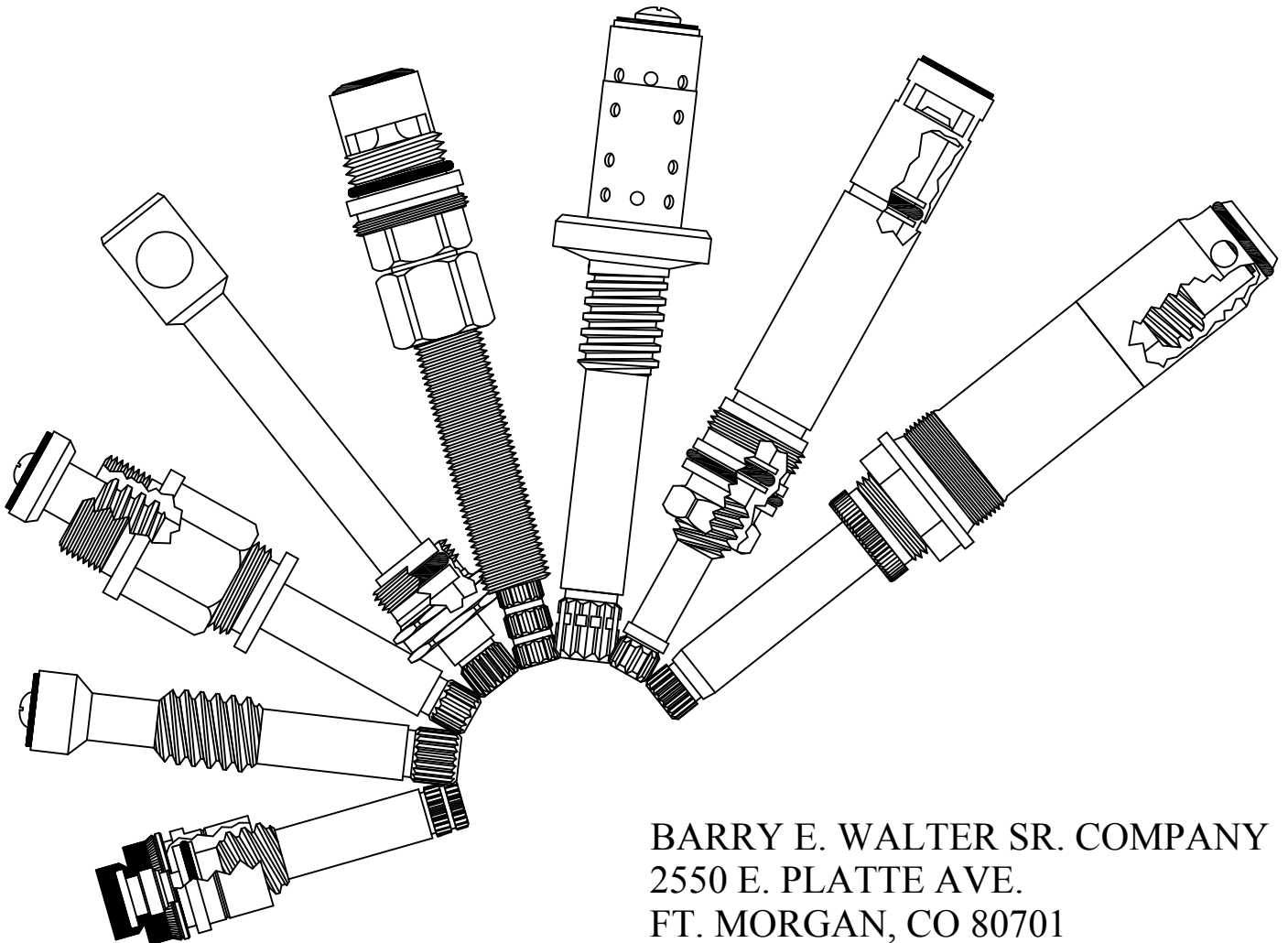

Quality Replacement Parts



BARRY E. WALTER SR. COMPANY
2550 E. PLATTE AVE.
FT. MORGAN, CO 80701

*We are always adding
new parts. Check our
website for updates.*

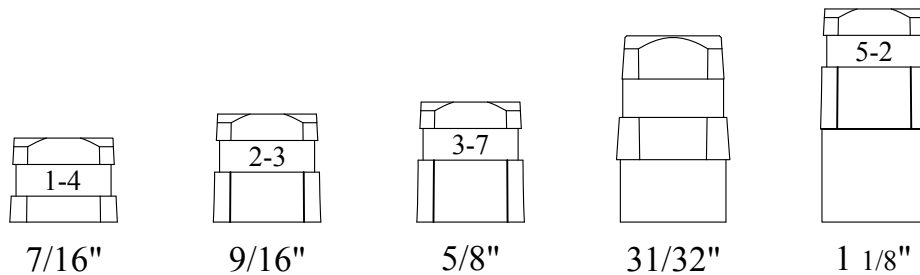
SOLID BRASS HANDLE SPUDS



AVAILABLE IN MANY DIFFERENT VARIATIONS,
CHECK THEM OUT ONLINE.

BARRY E.  ALTER  SR. CO.

FOR PHYLRICH

Individual items available
 Stem Ext. 29/32": #128350-PB
 & 128350-CP
 Ext. Adap. Screw: #103310

LENGTH: 2.08"

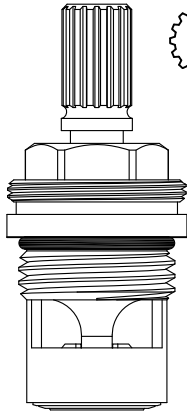

16
3-16

GASKET: 890170 O-RING INCLUDED
 SEAL: 898510-W
 DISC SET: 151380-PKG

LF461901
 LF461902

Polished Brass Stem Extension LENGTH: 2.49"

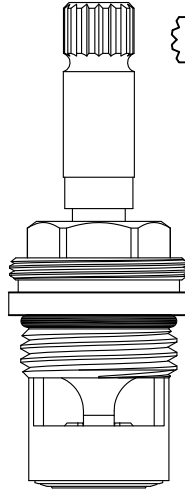

16
1-6

GASKET: 890170 O-RING INCLUDED
 SEAL: 898510-W
 DISC SET: 151380-PKG

LF463651
 LF463652

Also available with chrome plated stem extension
LF463651-CP / LF463652-CP

Individual items available
 Stem Ext. 1-1/16": #105270-PB
 & #105270-CP
 Ext. Adap. Screw: #103310

LENGTH: 2.64"

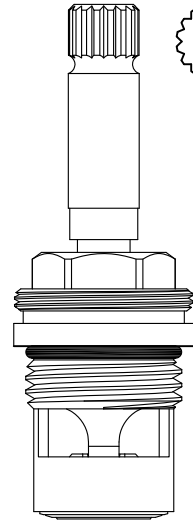

16
1-6

GASKET: 890170 O-RING INCLUDED
 SEAL: 898510-W
 DISC SET: 151380-PKG

LF464661
 LF464662

Also available with chrome plated stem extension
LF464661-CP / LF464662-CP

Individual items available
 Stem Ext. 1-1/4": #105340-PB
 & 105340-CP
 Ext. Adap. Screw: #103310

LENGTH: 2.81"

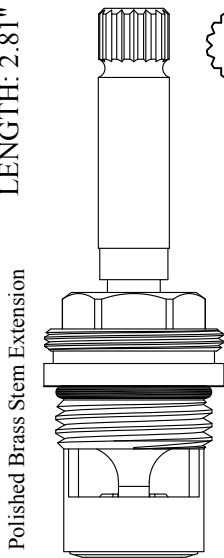

16
1-6

GASKET: 890170 O-RING INCLUDED
 SEAL: 898510-W
 DISC SET: 151380-PKG

LF465561
 LF465562

Also available with chrome plated stem extension
LF465561-CP / LF465562-CP

LENGTH: 2.96"

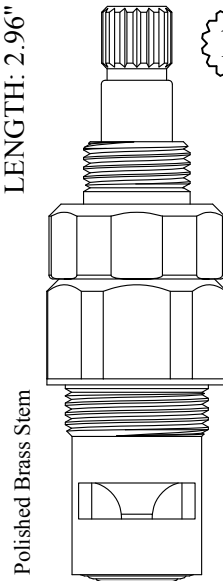

16
1-6

GASKET: 895270 INCLUDED
 SEAL: 898500
 DISC SET: 112530-PKG

LF466201
 LF466202

Also available with Polished Chrome Stem
LF466201-CP / LF466202-CP

Individual items available
 Stem Ext. 1-1/2": #121860-PB
 & 121860-CP
 Ext. Adap. Screw: #103310

LENGTH: 3.06"

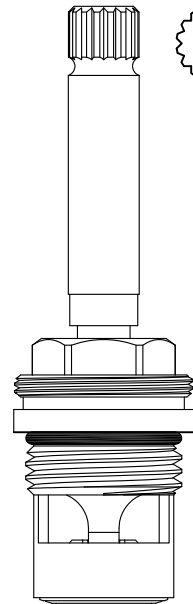

16
1-6

GASKET: 890170 O-RING INCLUDED
 SEAL: 898510-W
 DISC SET: 151380-PKG

LF466461
 LF466462

Also available with chrome plated stem extension
LF466461-CP / LF466462-CP

FOR PHYLRICH

Polished Brass Stem

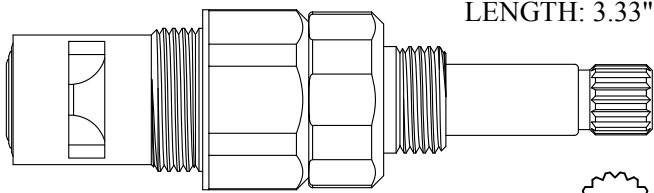

LENGTH: 3.33"



LF468101/ LF468102

GASKET: 895270 INCLUDED
SEAL: 898500
DISC SET: 112530-PKG

Also available with chrome plated stem

LF468101-CP/ LF468102-CP

Polished Brass Stem Extension

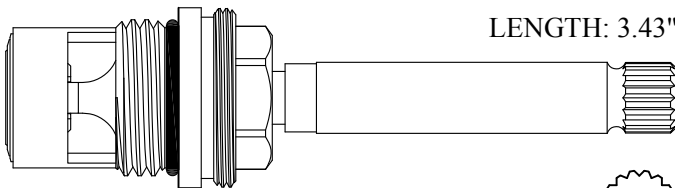

LENGTH: 3.43"



LF468461/ LF468462

GASKET: 890170 O-RING INCLUDED
SEAL: 898510-W
DISC SET: 151380-PKG

Individual items available
Stem Ext. 1 7/8": #102890-PB
& 102890-CP
Ext. Adap. Screw: #103310

Also available with chrome plated stem extension

LF468461-CP/ LF468462-CP

Polished Brass Stem

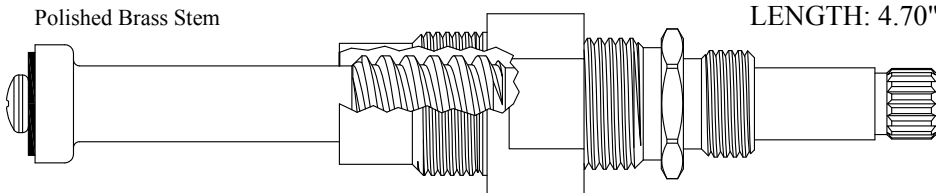

LENGTH: 4.70"



SEAT USED: LF648550

LF475091/ LF475092

LF275091/ LF275092 Stem Only

GASKET: 895100

Also available with chrome plated stem

LF475091-CP/ LF475092-CP

LF275091-CP/ LF275092-CP Stem Only

Polished Brass Stem Extension

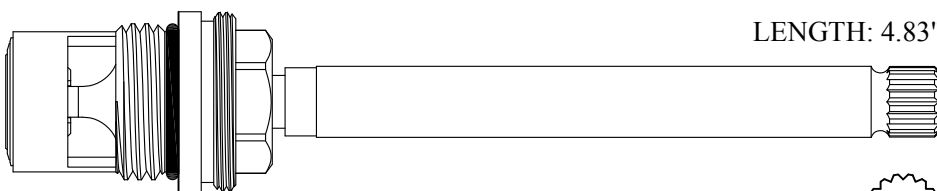

LENGTH: 4.83"



410061/ 410062

410061-CP/ 410062-CP

GASKET: 890170 O-RING INCLUDED
SEAL: 898510-W
DISC SET: 151380-PKG

Individual items available
Stem Ext. 3.25": #132150-PB
& 132150-CP
Ext. Adap. Screw: #103310

Also available with chrome plated stem

FOR PHYLRICH

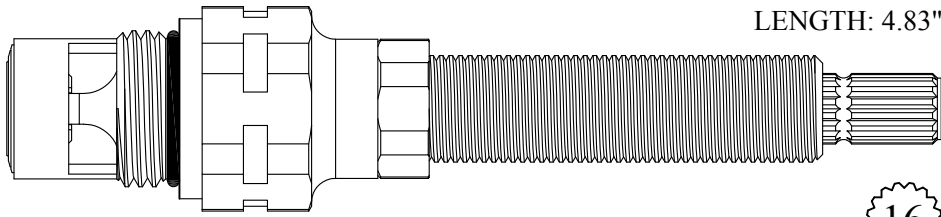

LENGTH: 4.83"

Individual items available
Stem Ext. 3.25": #102960
Ext. Adap. Screw: #103310

410081/ 410082

GASKET: 890170 O-RING INCLUDED
SEAL: 898510-W
DISC SET: 151380-PKG

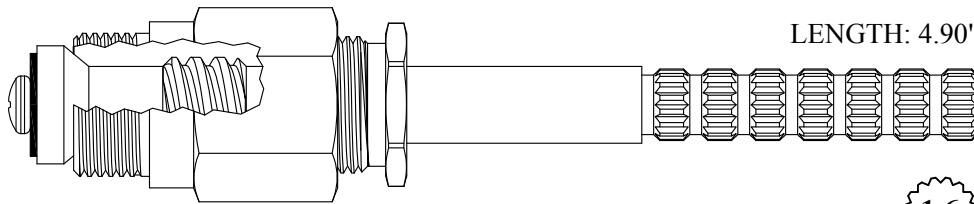

LENGTH: 4.90"

411031/ 411032

GASKET: 895100

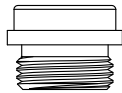

SEAT USED: LF648550

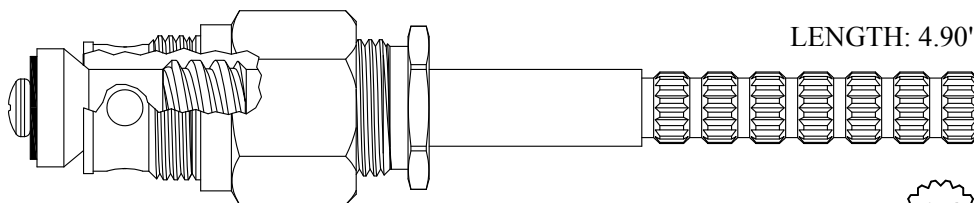

LENGTH: 4.90"

431941

GASKET: 895100

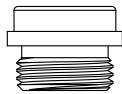

SEAT USED: LF648550



Polished Brass Stem

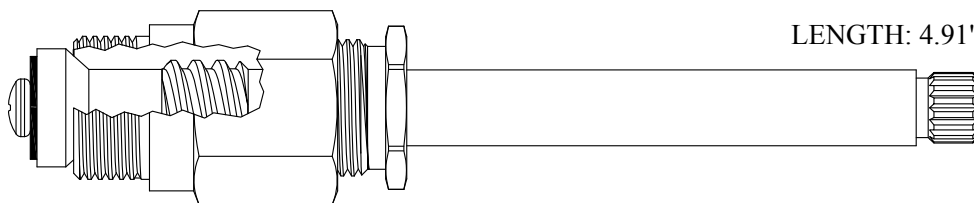

LENGTH: 4.91"

411041/ 411042

211041/ 211042 Stem Only

GASKET: 895100

Also available with chrome plated stem
411041-CP/ 411042-CP

211041-CP/ 211042-CP Stem Only

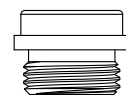

SEAT USED: LF648550

FOR PHYLRICH

Polished Brass Stem

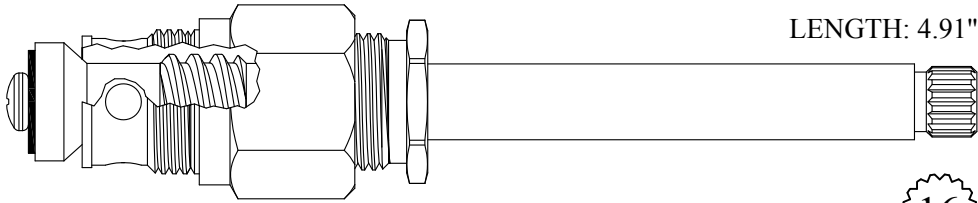

LENGTH: 4.91"

Also available with chrome plated stem

431951
GASKET: 895100

431951-CP



SEAT USED: LF648550

16
1-6

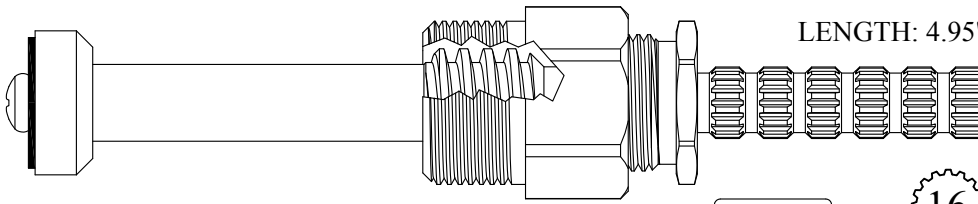

LENGTH: 4.95"

415641/ 415642
GASKET: 895400

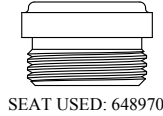

SEAT USED: 648970

16
3-16

Polished Brass Stem Extension



LENGTH: 4.97"

Also available with chrome plated stem

412041/ 412042
GASKET: 890210 O-RING INCLUDED
SEAL: 898520
DISC SET: 109850-PKG

412041-CP/ 412042-CP

16
1-6

Individual items available
Stem Ext. 3.25": #132150
& 132150-CP
Ext. Adap. Screw: #103310

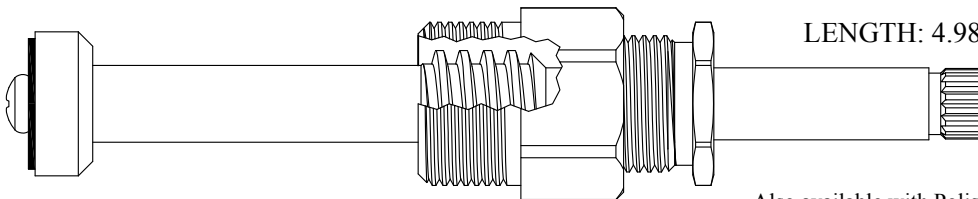

LENGTH: 4.98"

Also available with Polished Brass stem

415541-CP/ 415542-CP
215541-CP/ 215542-CP Stem Only
GASKET: 895400

415541-PB/ 415542-PB
215541-PB/ 215542-PB Stem Only

16
1-6



SEAT USED: 648970

FOR PHYLRICH

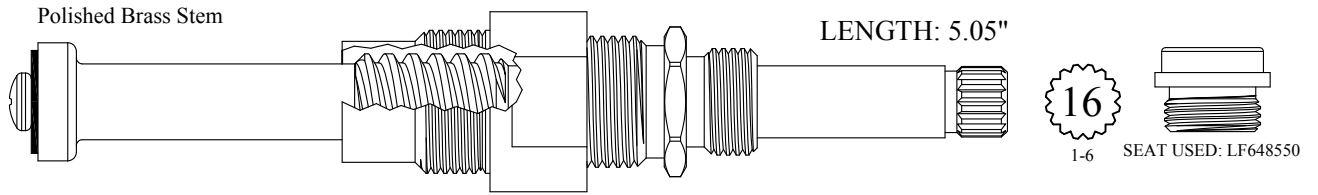

LF480191/ LF480192
LF280191/ LF280192 Stem Only
GASKET: 895100

Also available with chrome plated stem
LF480191-CP/ LF480192-CP
LF280191-CP/ LF280192-CP Stem Only

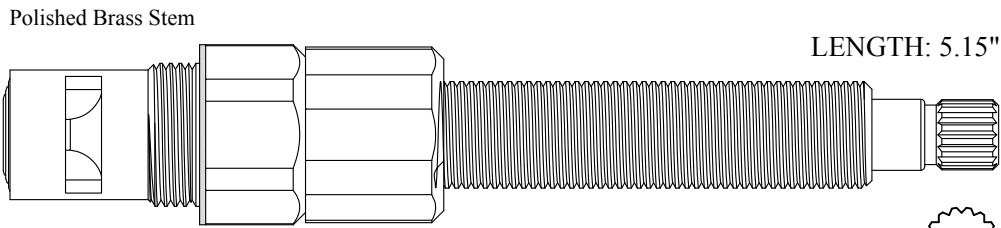

416831/ 416832
GASKET: 895270 INCLUDED
SEAL: 898500
DISC SET: 112530-PKG

Also available with chrome plated stem
416831-CP/ 416832-CP

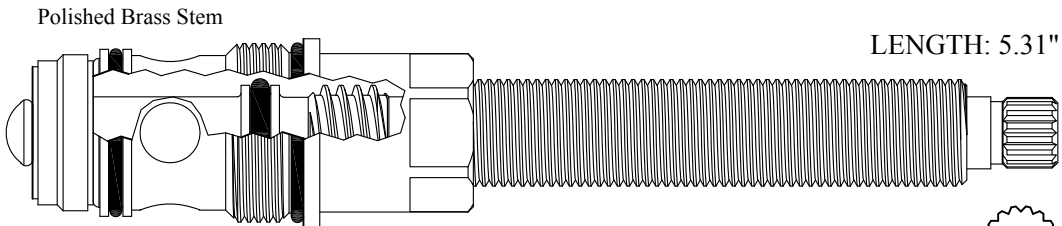

433361
GASKET: 890190 O-RING INCLUDED

Also available with chrome plated stem
433361-CP

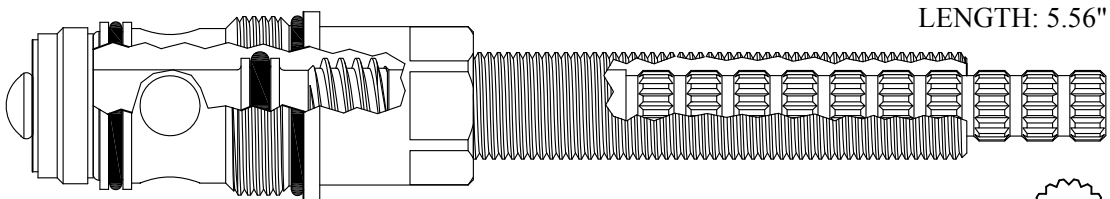

433371
GASKET: 890190 O-RING INCLUDED



FOR PHYLRICH

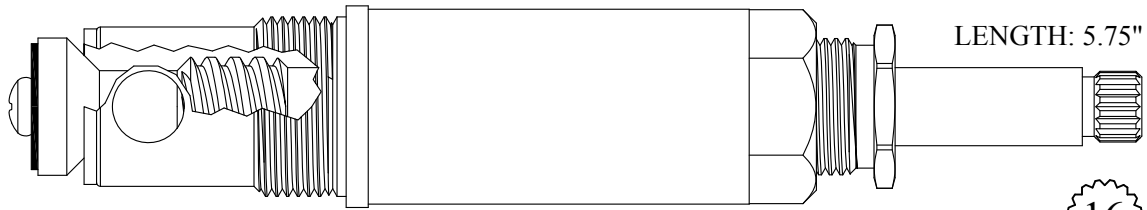

436131
236101 Stem Only
GASKET: 895370

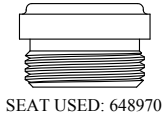

16
1-6

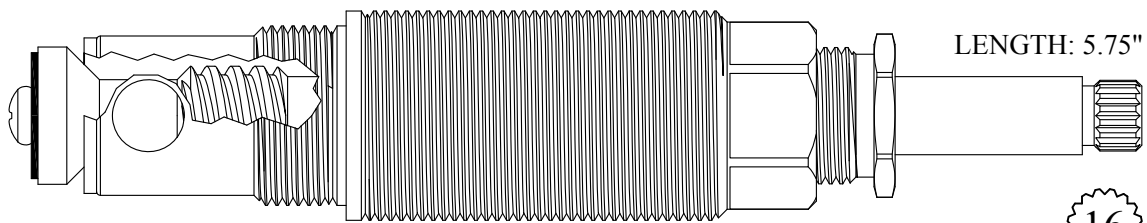

436141
236101 Stem Only
GASKET: 895370

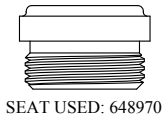

16
1-6

Send Your Orders To:

BARRY E.  SR. CO.

E-mail: orderdesk@barrywalter.com

Fax: 1.800.886.9831

Phone: 1.800.767.5552

FOR PHYLRICH

Wall and Deck Models

To identify a 4 or 5-Port Unit, look down the stem from the broach end at the dent bushing. Refer to the images below:

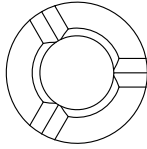

4-Port

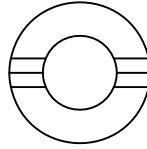

5-Port

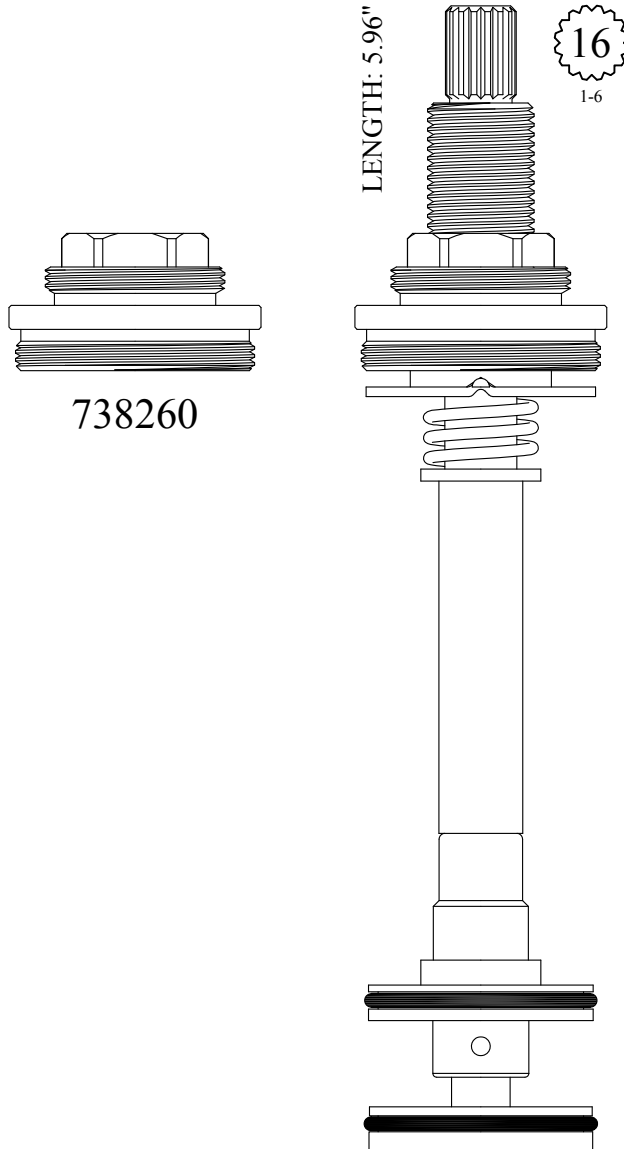

738260

Deck Model	
4-Port	238260
5-Port	238270
W/ 730560 Bonnet	
4-Port	438260
5-Port	438270

FOR PHYLRICH

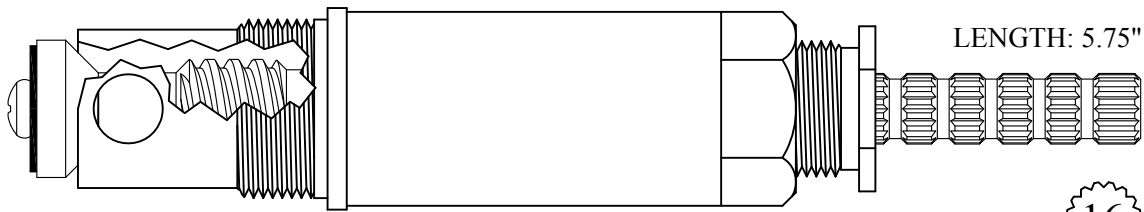

LENGTH: 5.75"

16
1-6

436171
GASKET: 895370



SEAT USED: 648970

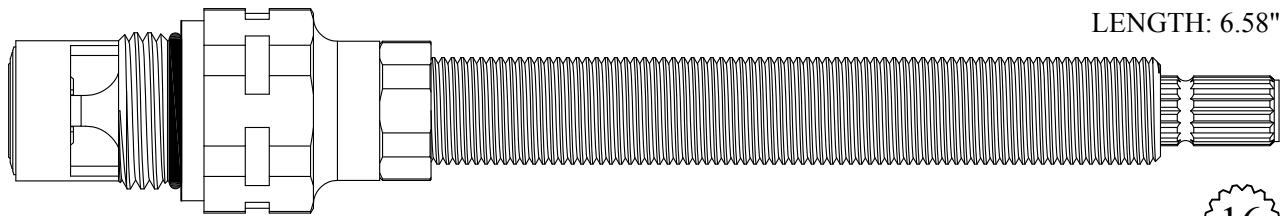

LENGTH: 6.58"

16
1-6

427281/ 427282

GASKET: 890170 O-RING INCLUDED
SEAL: 898510-W
DISC SET: 151380-PKG

Individual items available
Stem Ext. 5.00": #136050
Ext. Adap. Screw: #103310

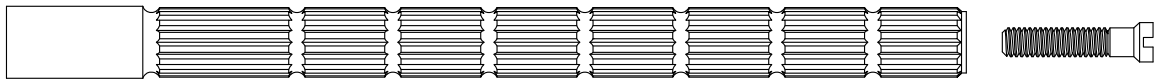

LENGTH: 6.75"

16
1-6

427241/ 427242

GASKET: 895100

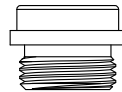

SEAT USED: LF648550

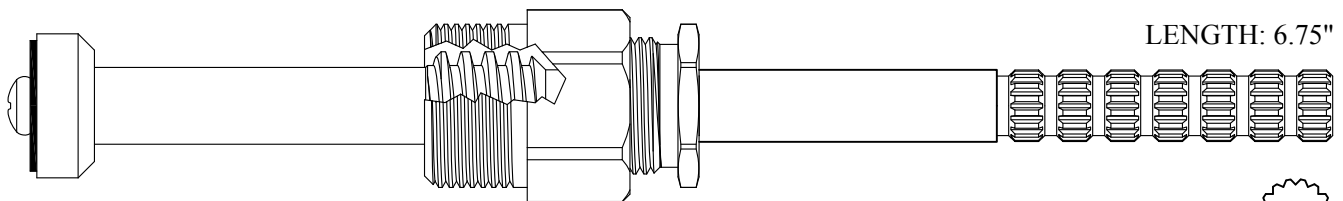

LENGTH: 6.75"

16
1-6

427321/ 427322

GASKET: 895400

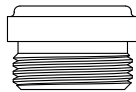

SEAT USED: 648970

FOR PHYLRICH

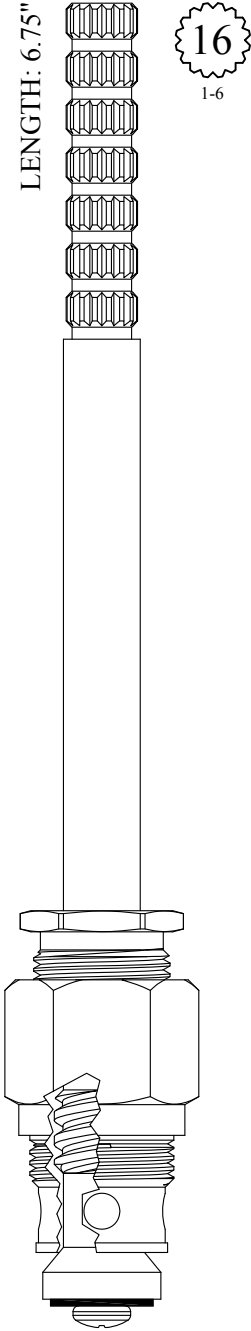

GASKET: 895100

439621



SEAT USED: LF648550

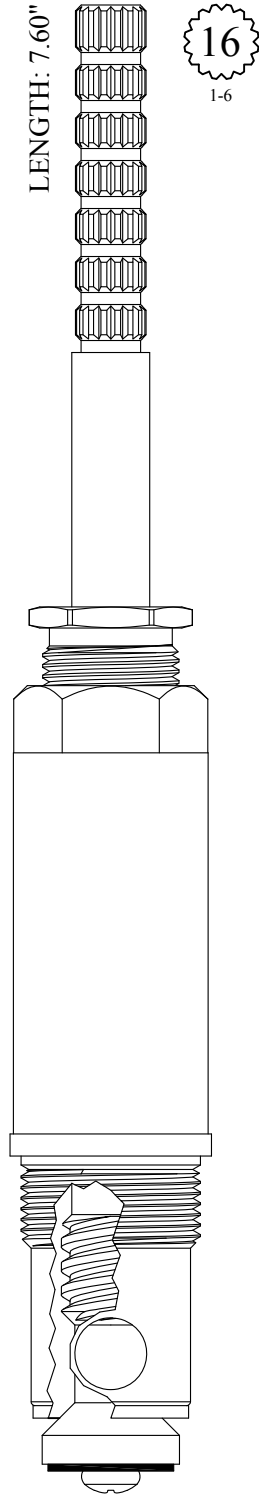

GASKET: 895370

439681



SEAT USED: 648970

FOR PIAZZA

LENGTH: 1.85"

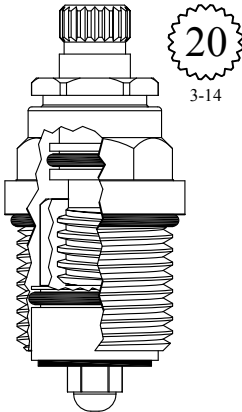

GASKET: 890180 O-RING INCLUDED

LF460802

LENGTH: 2.37"

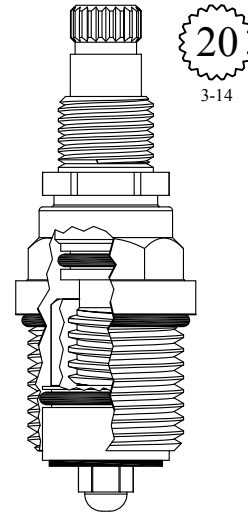

GASKET: 890180 O-RING INCLUDED

LF463702

LENGTH: 3.07"

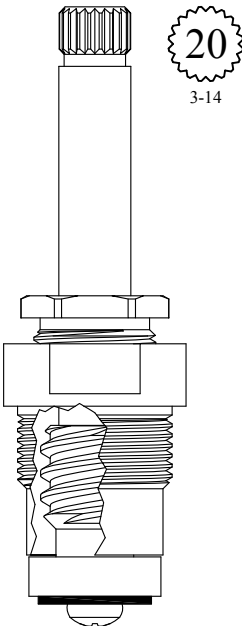

GASKET: 895150

401811

LENGTH: 3.26"

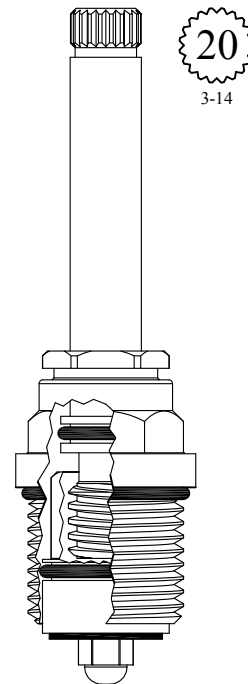

GASKET: 890180 O-RING INCLUDED

402252

FOR PIEL

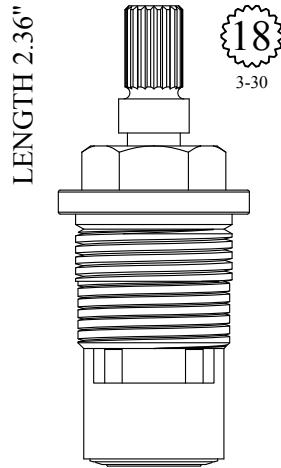

GASKET: 895150 INCLUDED
SEAL: 898510-W
DISC SET: 151380-PKG

LF462661
LF462662

FOR PILOT

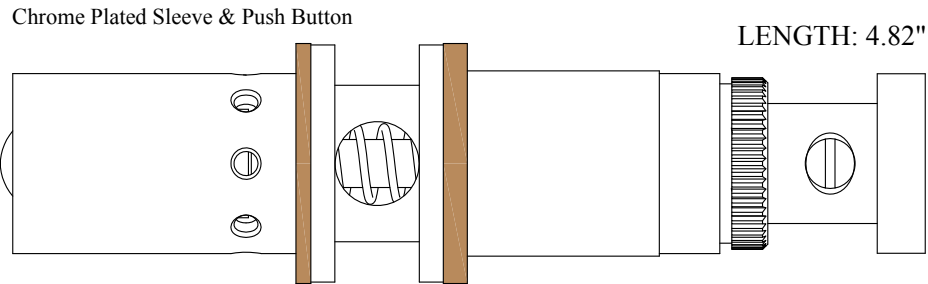

475700

GASKET: 894650 INCLUDED

FOR PORCHER

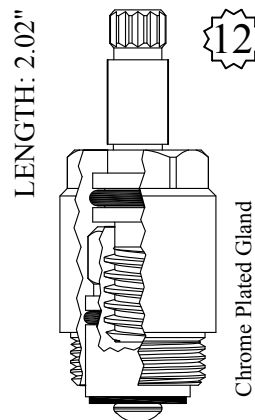

LF458602

FOR POWERS

LENGTH: 1.73"

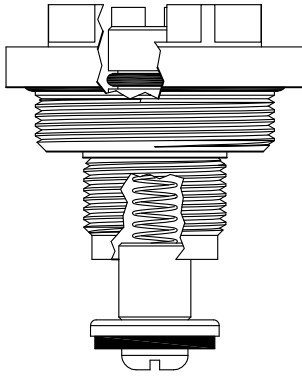

Also available as chrome plated unit

400471-CP

200471-CP Stem Only

GASKET: 891230 O-RING INCLUDED

400471
200471 Stem Only
500470-KIT Retainer & Spring Only

LENGTH: 2.28"

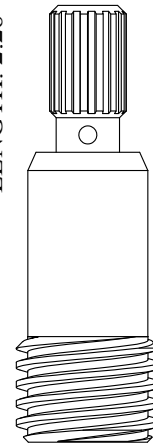

15
Small

201181

LENGTH: 2.28"

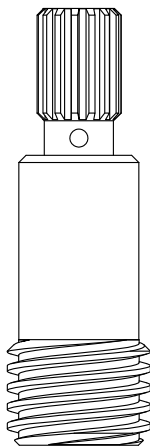

15
Large

201201

LENGTH: 2.60"

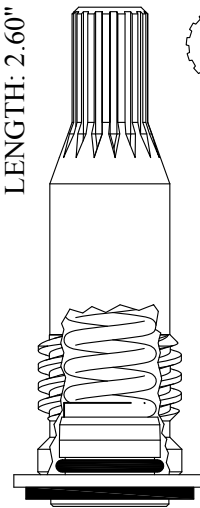

15
Small

201531

FOR POWERS

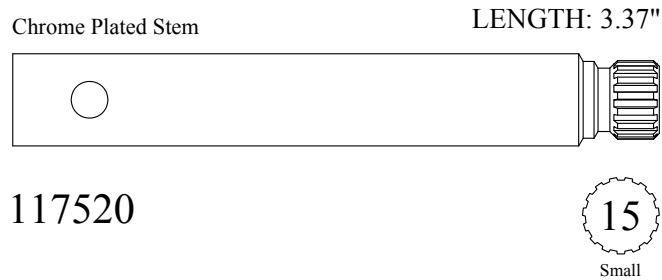
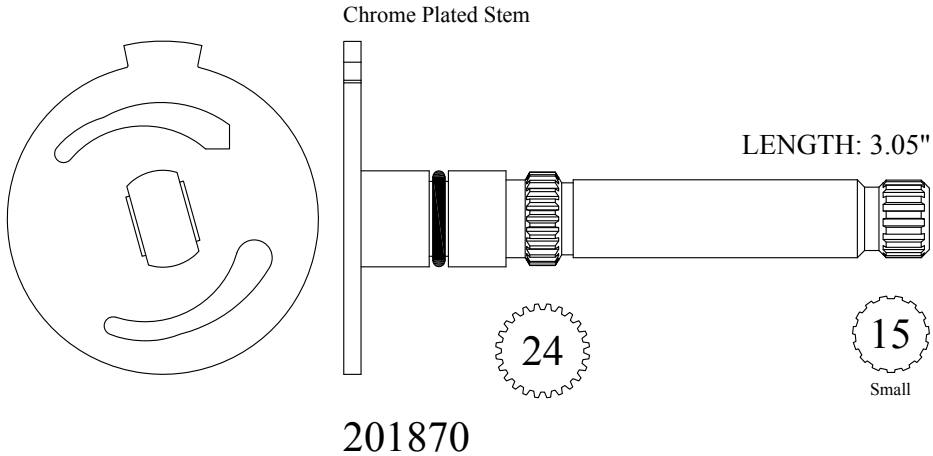

Send Your Orders To:

BARRY E.  WALTER  SR. CO.

E-mail: orderdesk@barrywalter.com

Fax: 1.800.886.9831

Phone: 1.800.767.5552

FOR PRECISION

Plastic Body

LENGTH: 2.54"

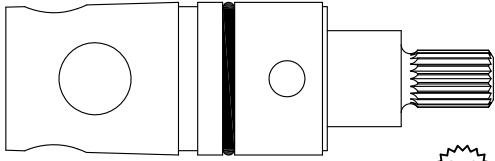

230670

20
3-20

Plastic Body

LENGTH: 6.59"

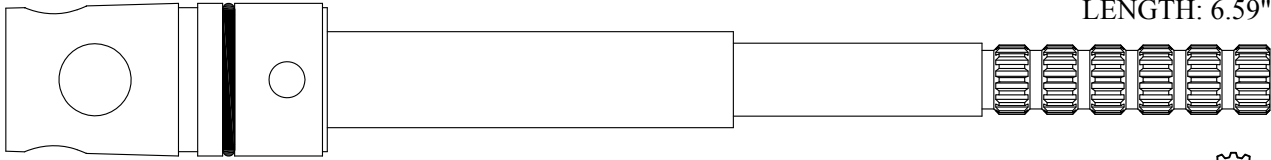

239160

16
3-16

FOR PREMIER

LENGTH: 1.81"

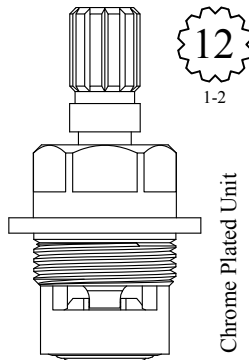

12
1-2

Chrome Plated Unit

SEAL: 898500
DISC SET: 112530-PKG

LF455981
LF455982

FOR PRICE PFISTER

LENGTH: 1.41"

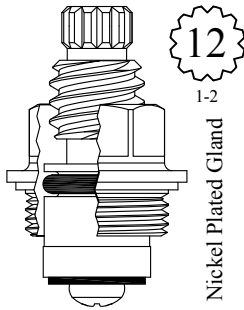

GASKET: 895100

LF451031
LF451032

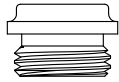

SEAT USED: LF648270

LENGTH: 1.42"

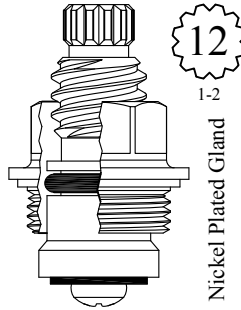

GASKET: 895100

LF451041
LF451042

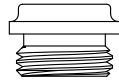

SEAT USED: LF648270

LENGTH: 1.53"

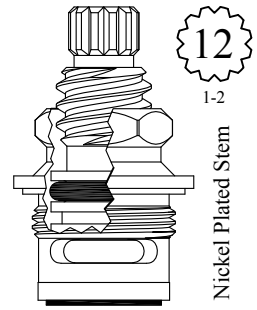

GASKET: 895100

LF450951
LF450952

LENGTH: 1.63"

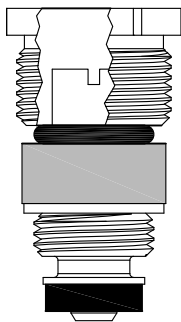

400301
200301 Stem Only

LENGTH: 1.63"

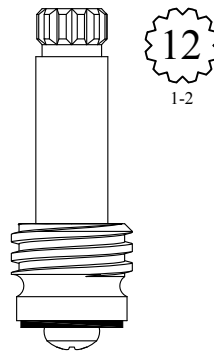

LF252401

LENGTH: 1.63"

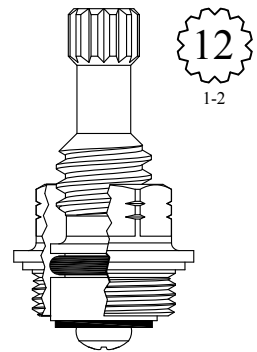

GASKET: 895100

LF453051
LF453052

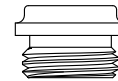

SEAT USED: LF648270

FOR PRICE PFISTER

LENGTH: 1.63"

GASKET: 895100
SEAT INCLUDED: LF648310
LF451001

LENGTH: 1.73"

Nickel Plated Gland
GASKET: 895100
LF454121
LF454122

SEAT USED: LF648270

LENGTH: 1.75"

Chrome Plated Stem
LF255161
LF255162

SEAT USED: LF648270

LENGTH: 1.76"

Chrome Plated Stem
LF255061
LF255062

SEAT USED: LF648270

LENGTH: 1.77"

GASKET: 895400
400741
200741 Stem Only

LENGTH: 1.78"

Nickel Plated Unit
GASKET: 895190 INCLUDED
SEAL: 898540
DISC SET: 112530-PKG
LF452801
LF452802

FOR PRICE PFISTER

LENGTH: 1.81"

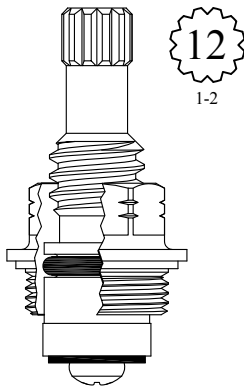

12
1-2

GASKET: 895100

LF456041

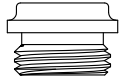

SEAT USED: LF648270

LENGTH: 1.88"

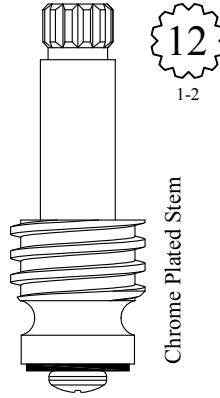

12
1-2

Chrome Plated Stem

LF256251

LENGTH: 1.91"

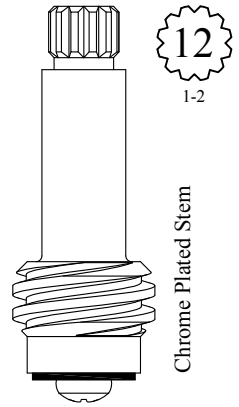

12
1-2

Chrome Plated Stem

LF257051
LF257052

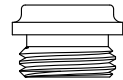

SEAT USED: LF648270

LENGTH: 1.91"

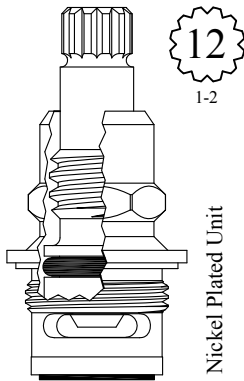

12
1-2

Nickel Plated Unit

GASKET: 895190

LF457201
LF457202

LENGTH: 1.91"

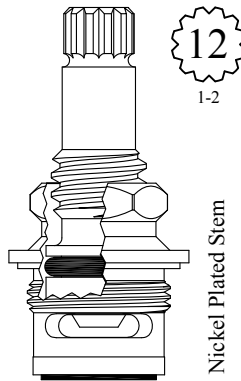

12
1-2

Nickel Plated Stem

GASKET: 895190

LF457221
LF457222

LENGTH: 1.95"

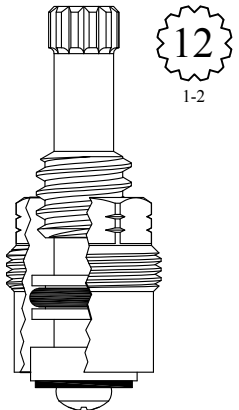

12
1-2

GASKET: 895060

LF458051

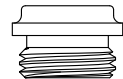

SEAT USED: LF648270

FOR PRICE PFISTER

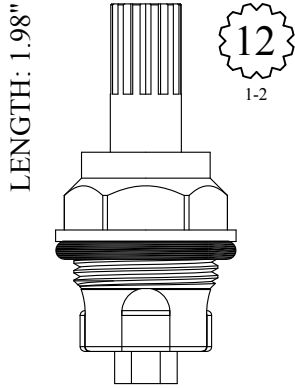

GASKET: 891100 O-RING INCLUDED

LF456331
LF456332

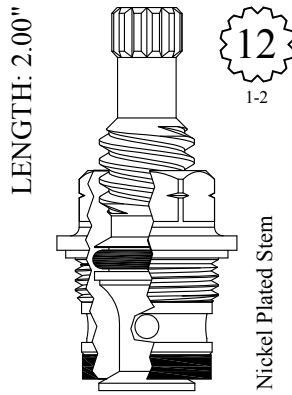

GASKET: 895100

LF458072

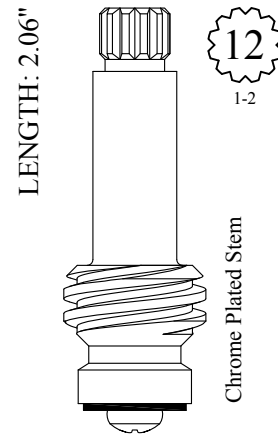

LF260081
LF260082

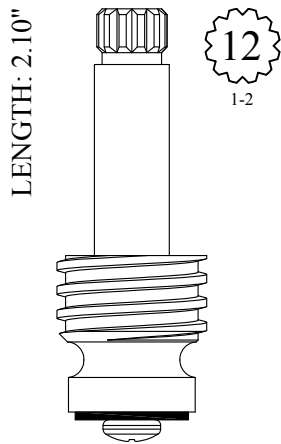

LF259251

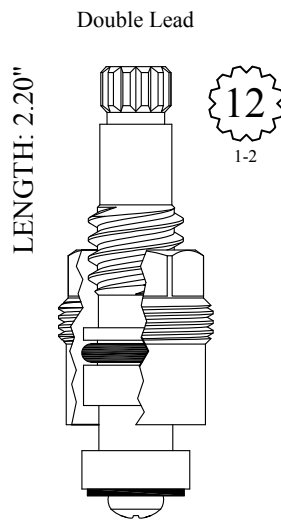

GASKET: 895060

LF461031
LF461032



SEAT USED: LF648270

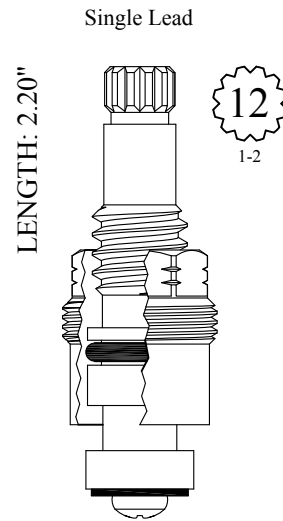

GASKET: 895060

LF461231



SEAT USED: LF648270

FOR PRICE PFISTER

LENGTH: 2.45"

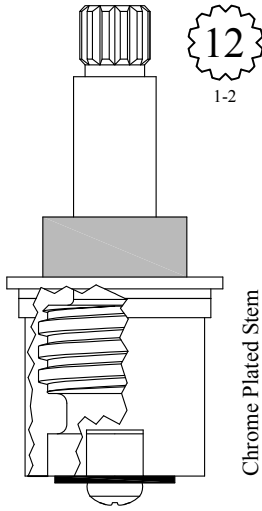

Chrome Plated Stem

401321
201351 Stem Only

Supplied with
12pt. Broach

LENGTH: 2.45"

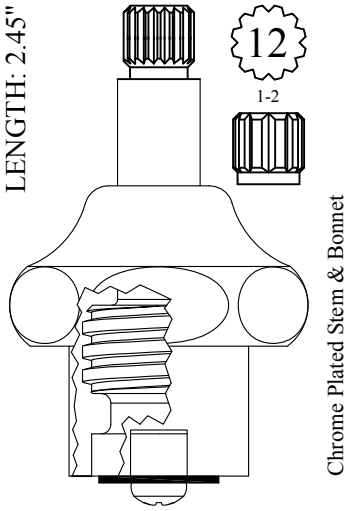

Chrome Plated Stem & Bonnet

401351
201351 Stem Only

LENGTH: 2.59"

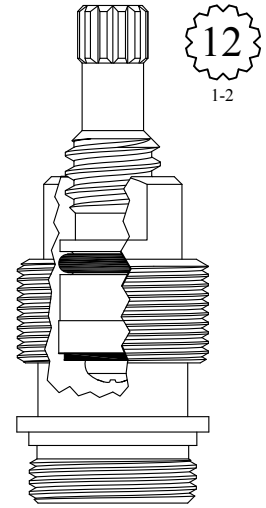

GASKET: 895400

401311

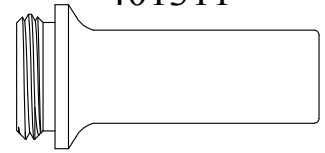

SEAT USED: 648290

LENGTH: 2.65"

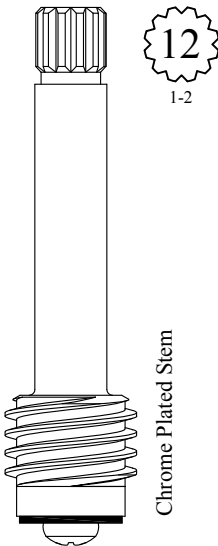

Chrome Plated Stem

LF265031
LF265032

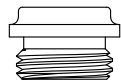

SEAT USED: LF648270

LENGTH: 2.65"

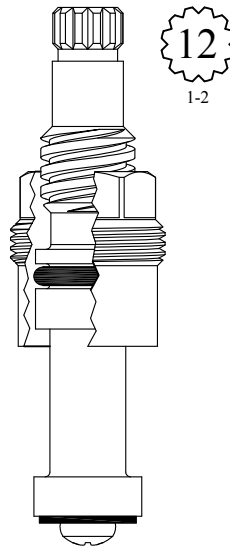

GASKET: 895060

LF465091
LF465092

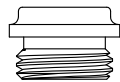

SEAT USED: LF648270

LENGTH: 2.74"

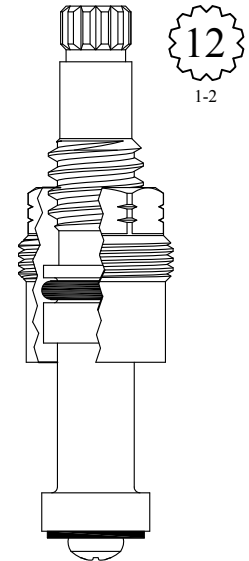

GASKET: 895060

LF465291

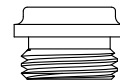

SEAT USED: LF648270

FOR PRICE PFISTER

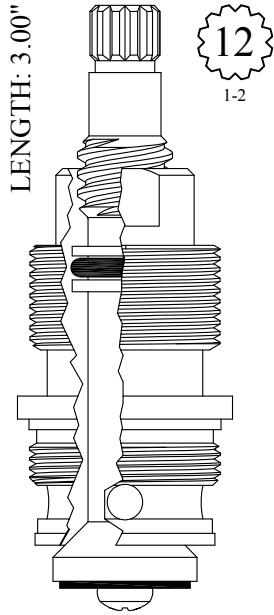

GASKET: 895550

430071-NS

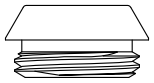

SEAT USED: 648370

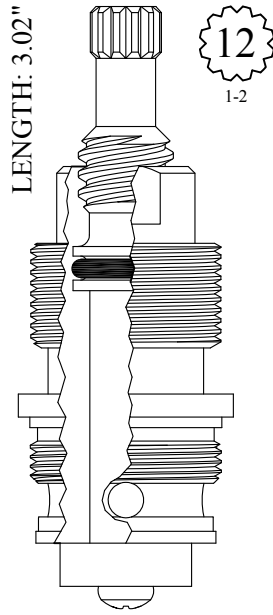

GASKET: 895550

430071

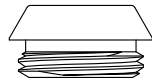

SEAT USED: 648370

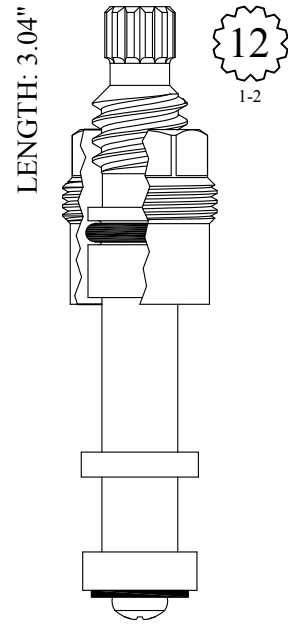

GASKET: 895060

LF467051
LF467052

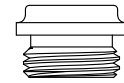

SEAT USED: LF648270

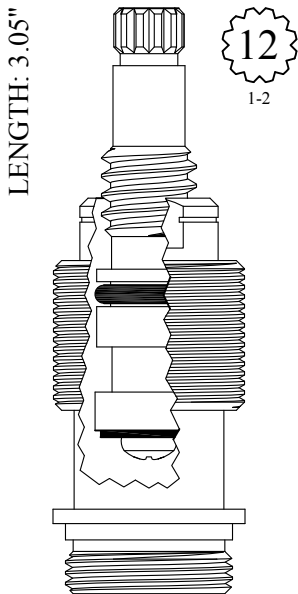

GASKET: 895400

402311

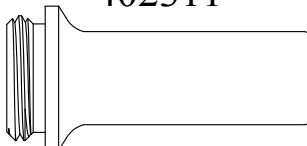

SEAT USED: 648290

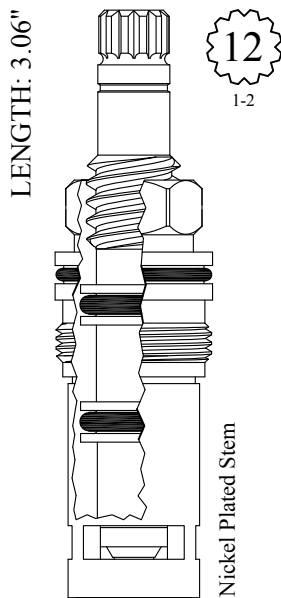

LF467301
LF467302

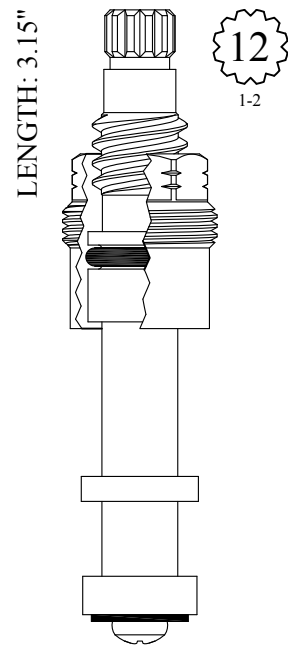

GASKET: 895060

LF467251

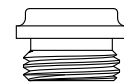

SEAT USED: LF648270

FOR PRICE PFISTER

LENGTH: 3.22"

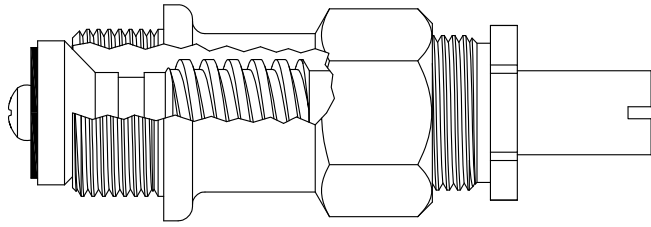

402621
202621 Stem Only
GASKET: 895400

LENGTH: 3.22"

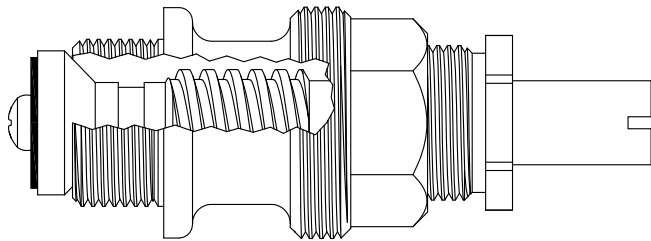

402671
202621 Stem Only
GASKET: 895400

LENGTH: 3.58"

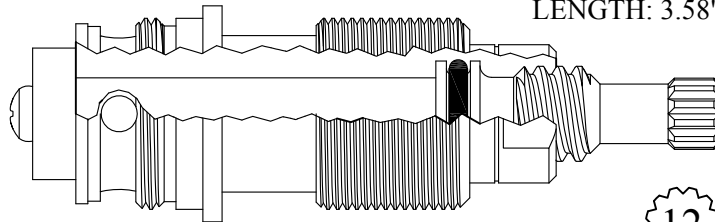

430091
GASKET: 895550



SEAT USED: 648370

12
1-2

LENGTH: 3.97"

Chrome Plated Unit

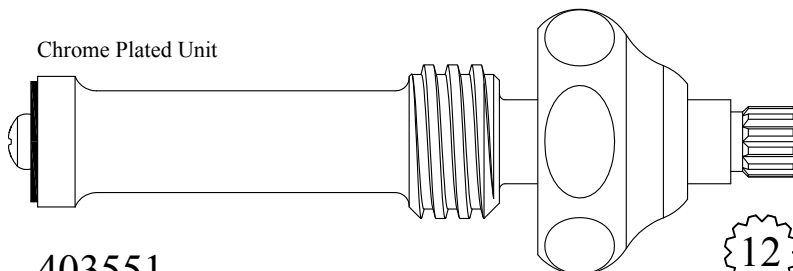

403551
203551 Stem Only

12
1-2

FOR PRICE PFISTER

Chrome Plated Stem

LENGTH: 4.22"

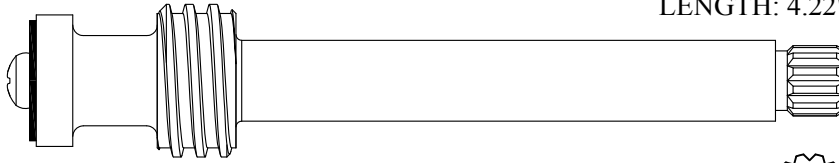

LF271071

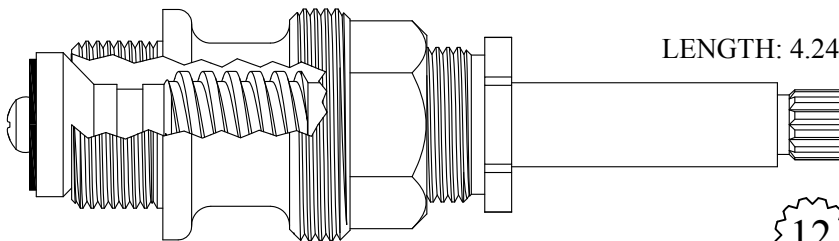

LENGTH: 4.24"

405101/ 405102
205101/ 205102 Stem Only
GASKET: 895400



SEAT USED: 648370

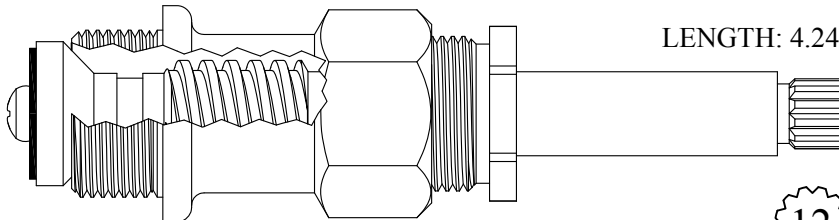

LENGTH: 4.24"

405111/ 405112
205101/ 205102 Stem Only
GASKET: 895400



SEAT USED: 648370

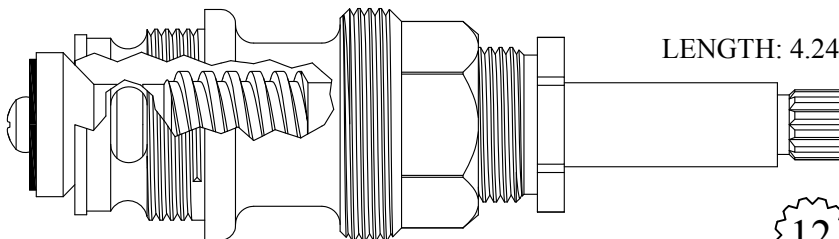

LENGTH: 4.24"

430301
230301 Stem Only
GASKET: 895550



SEAT USED: 648370



FOR PRICE PFISTER

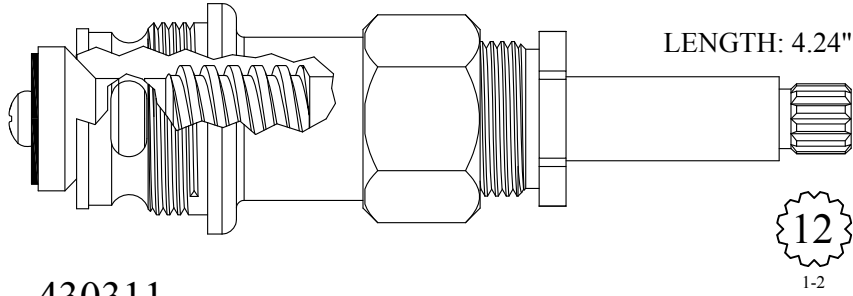

430311
230301 Stem Only
 GASKET: 895550

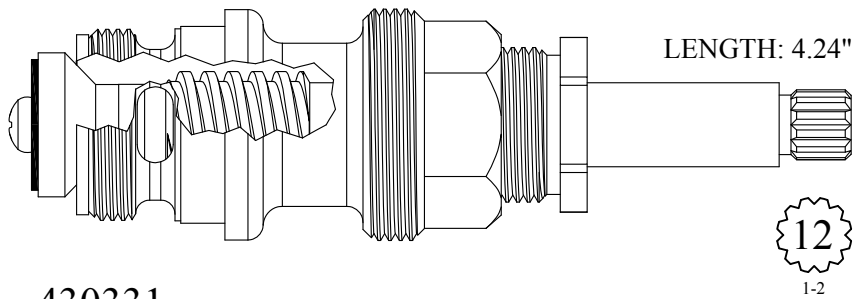
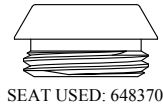

430331
230301 Stem Only
 GASKET: 895560

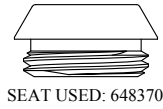

Chrome Plated Stem

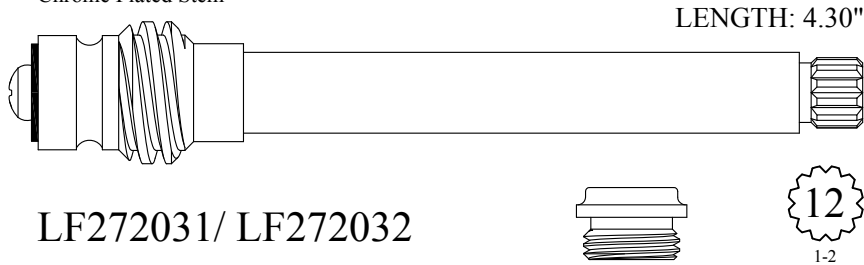

LF272031/ LF272032



One Piece Brass Stem

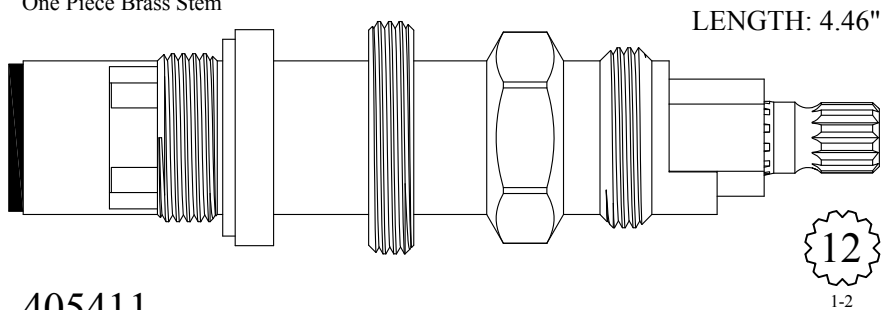

405411
 GASKET: 895390 INCLUDED
 SEAL: 898550
 DISC SET: 151380-PKG



You can use the 647390 seat to convert the old Beau Art body to accept the 405411 ceramic cartridge

FOR PRICE PFISTER

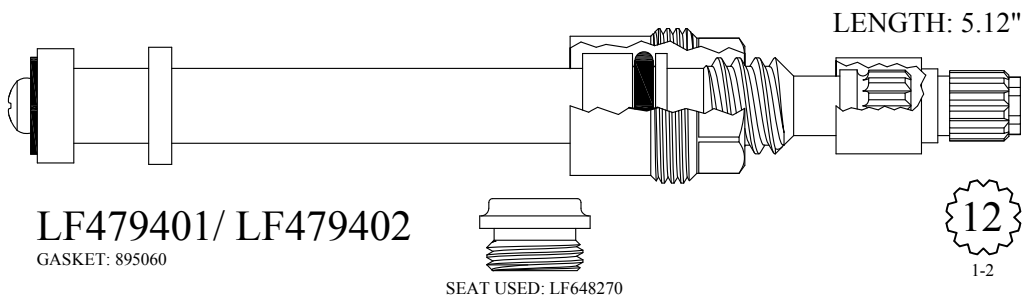
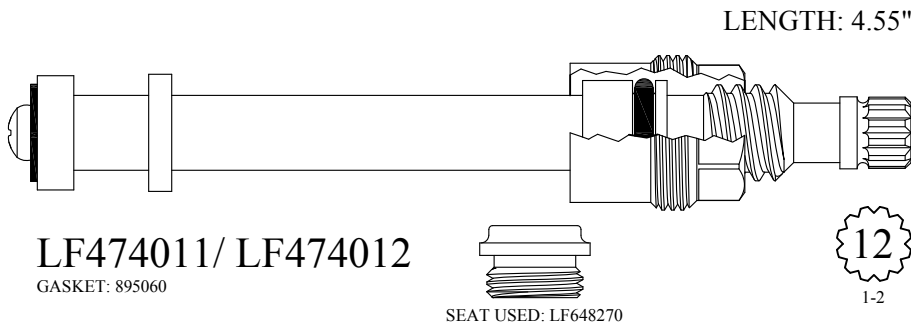
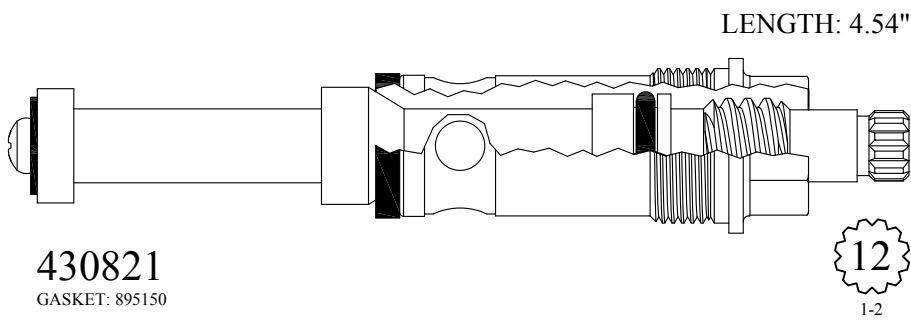
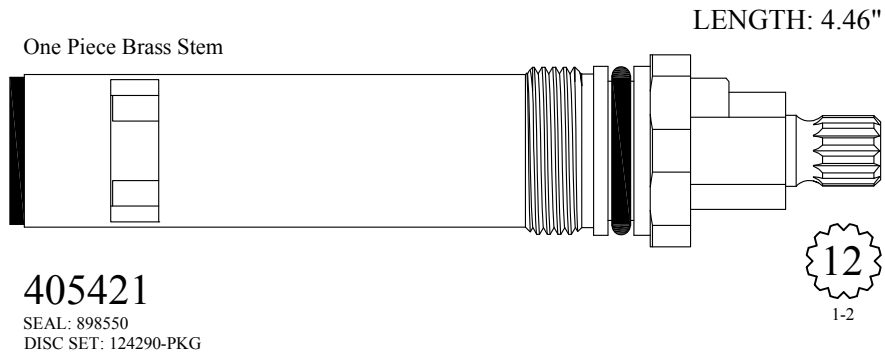

Send Your Orders To:

BARRY E.  SR. CO.

E-mail: orderdesk@barrywalter.com

Fax: 1.800.886.9831

Phone: 1.800.767.5552



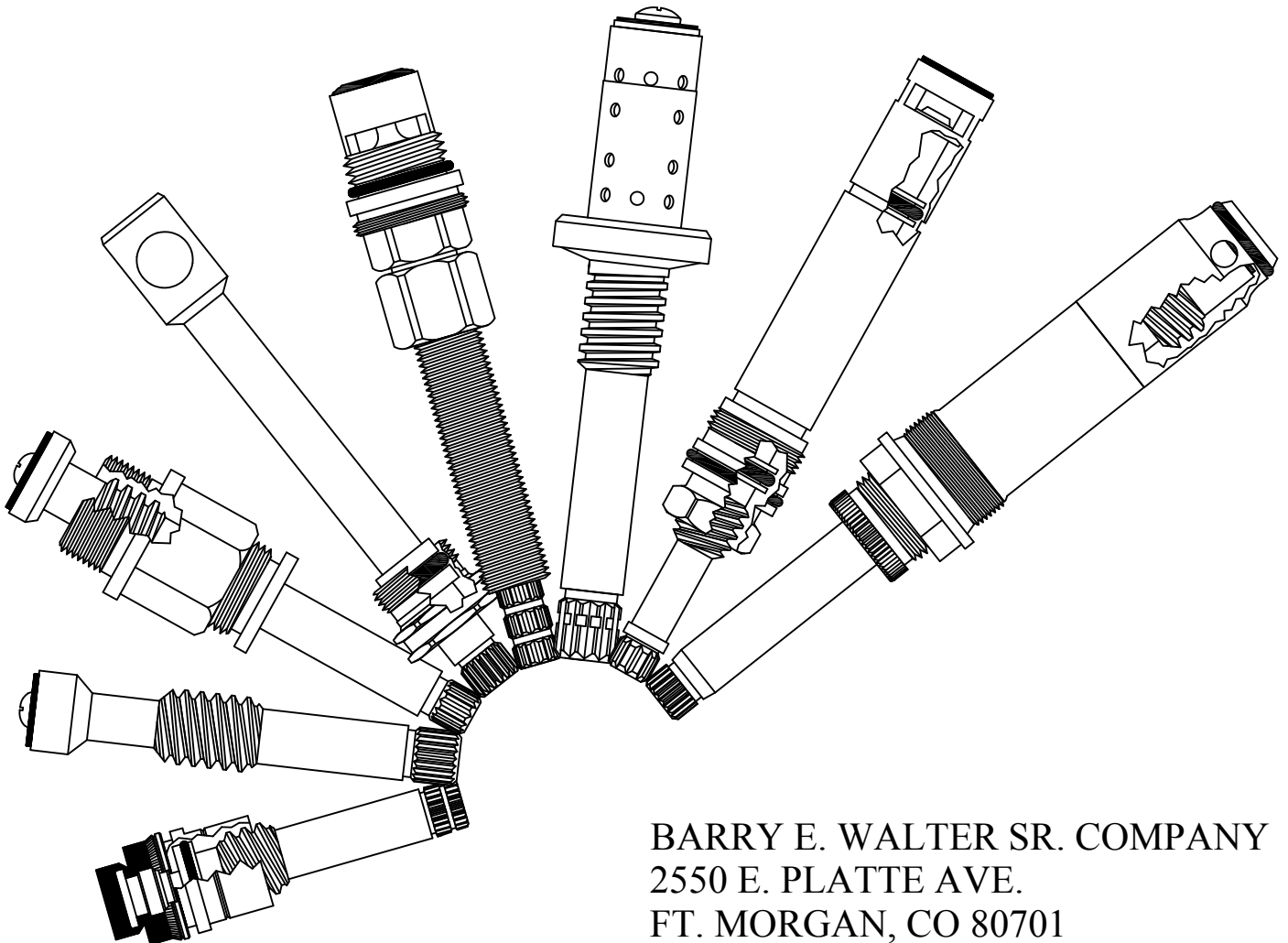

Quality Replacement Parts



BARRY E. WALTER SR. COMPANY
2550 E. PLATTE AVE.
FT. MORGAN, CO 80701

*We are always adding
new parts. Check our
website for updates.*

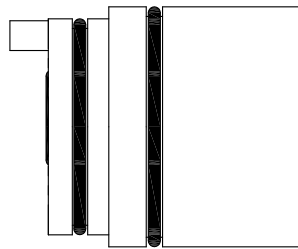
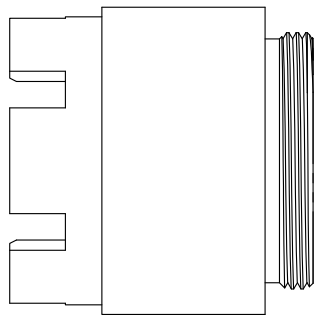
FOR AM STD RELIANT S/L CARTRIDGE EXTENSION KIT



160750

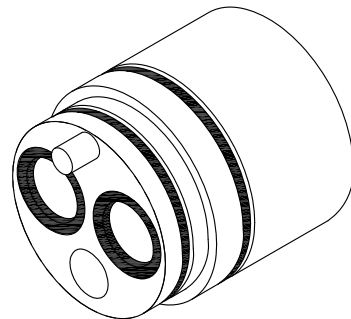

BARRY E.  ALTER  SR. CO.

FOR PRICE PFISTER

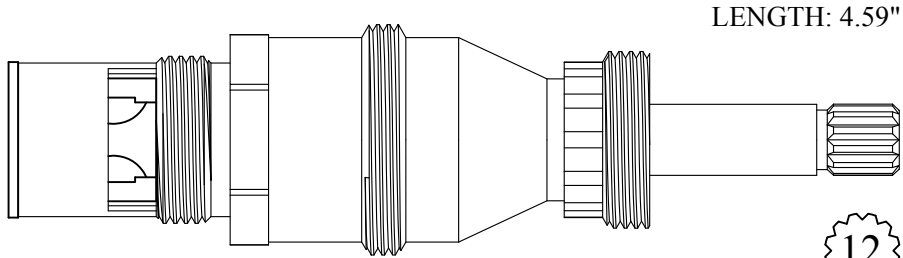

405441

GASKET: 895390 INCLUDED
DISC SET: 124290-PKG

12
1-2

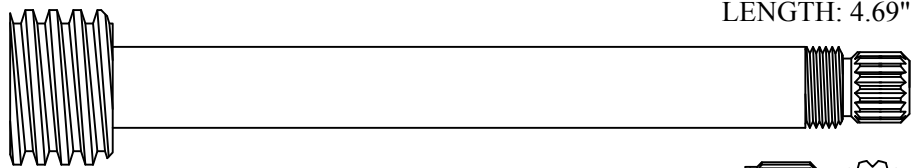

208971

Supplied with
12pt. Broach

12
1-2

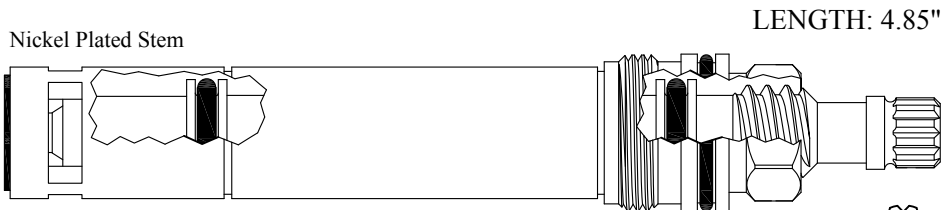

LF477201/ LF477202

12
1-2

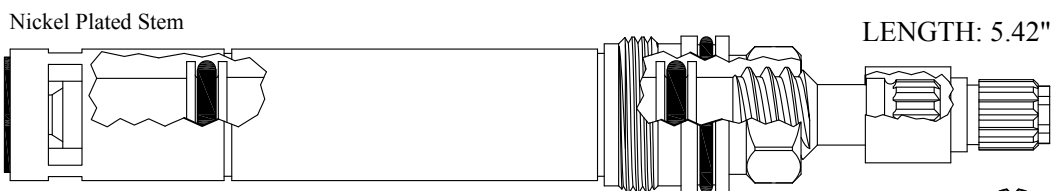

LF480381/ LF480382

12
1-2

FOR PRICE PFISTER

Chrome Plated Stem & Esc Tube

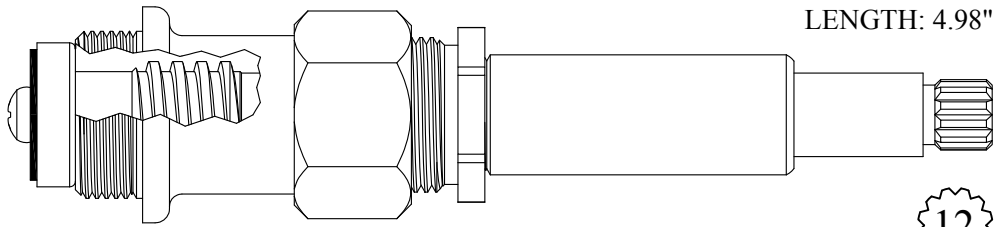

LENGTH: 4.98"

412901

GASKET: 895400

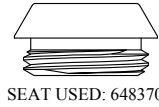

SEAT USED: 648370

12
1-2

Chrome Plated Stem

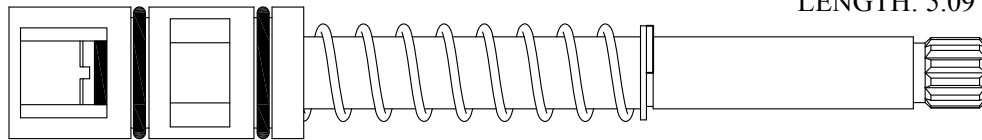

LENGTH: 5.09"

236260

12
1-2

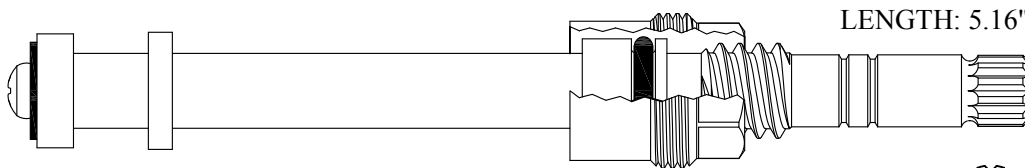

LENGTH: 5.16"

LF479501/ LF479502

GASKET: 895060

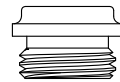

SEAT USED: LF648270

12
1-2

Chrome Plated Stem

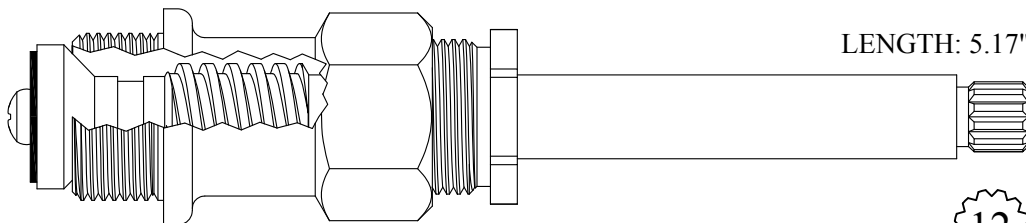

LENGTH: 5.17"

415301/ 415302

215301/ 215302 Stem Only

GASKET: 895400



SEAT USED: 648370

12
1-2

FOR PRICE PFISTER

Chrome Plated Stem

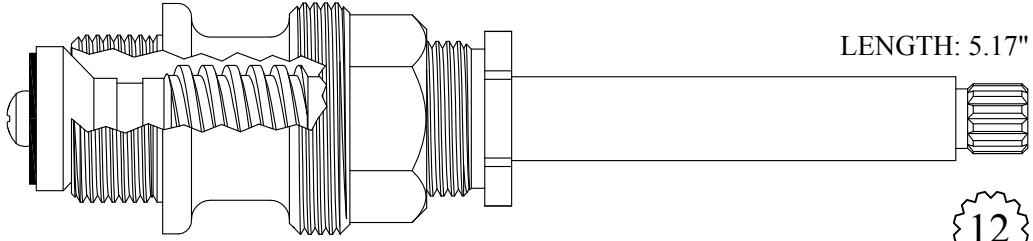

LENGTH: 5.17"



415311/ 415312
215301/ 215302 Stem Only
GASKET: 895400

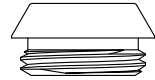

SEAT USED: 648370

Chrome Plated Stem

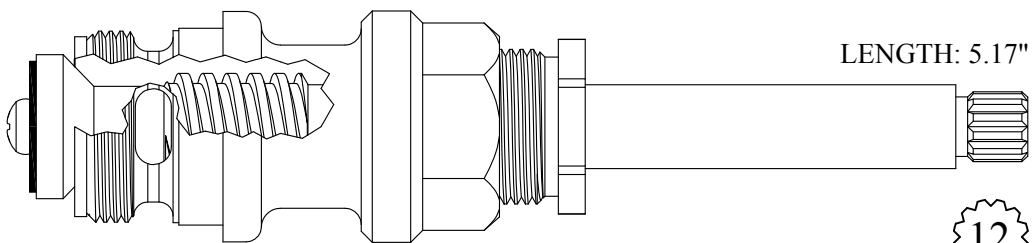

LENGTH: 5.17"



432001
232001 Stem Only
GASKET: 895560



SEAT USED: 648370

Chrome Plated Stem

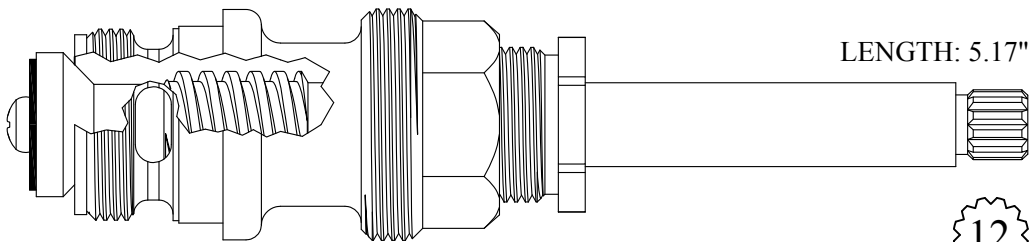

LENGTH: 5.17"



432011
232001 Stem Only
GASKET: 895560

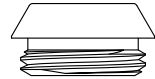

SEAT USED: 648370

Chrome Plated Stem

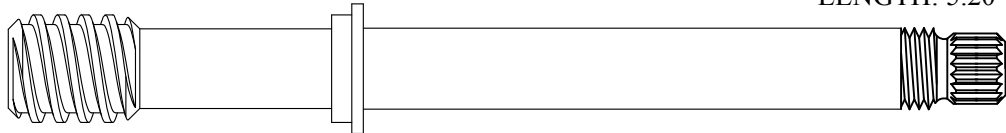

LENGTH: 5.20"

232651

Supplied with
12pt. Broach



FOR PRICE PFISTER

Nickel Plated Stem

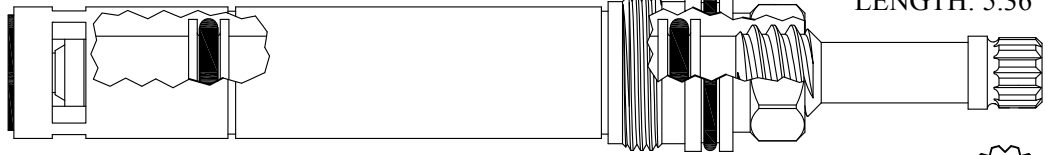

LENGTH: 5.36"

LF480401/ LF480402

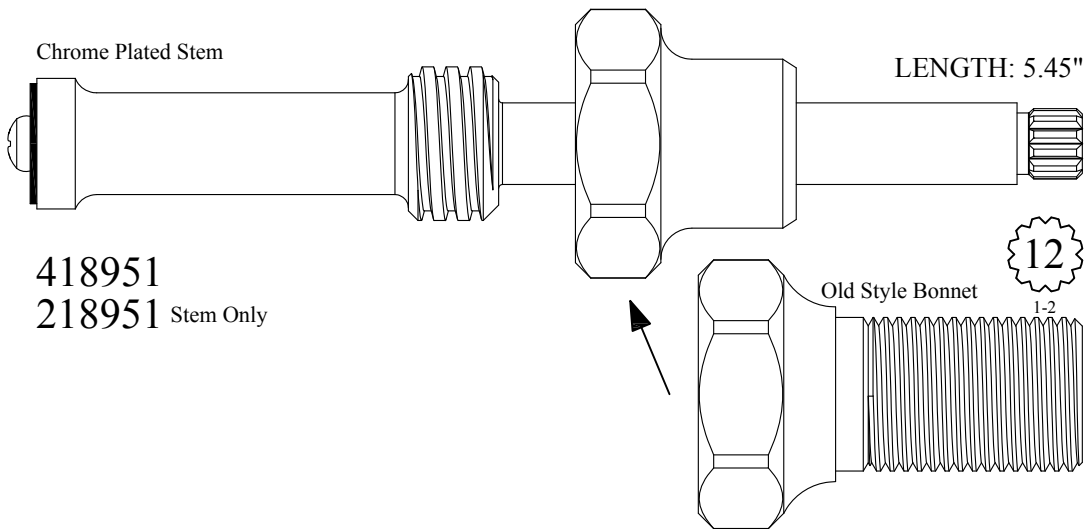

Chrome Plated Stem

LENGTH: 5.45"

418951
218951 Stem Only

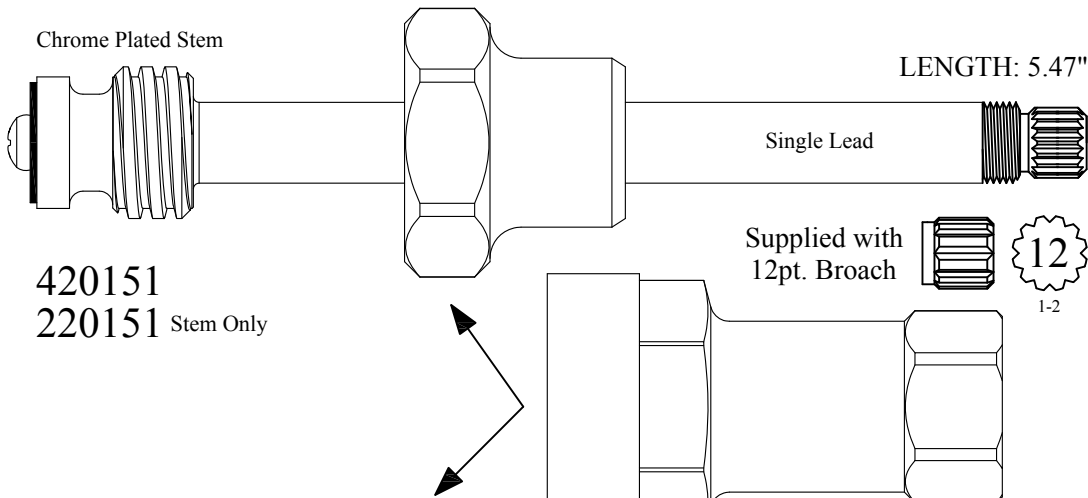

Chrome Plated Stem

LENGTH: 5.47"

Single Lead

420151
220151 Stem Only

Supplied with
12pt. Broach

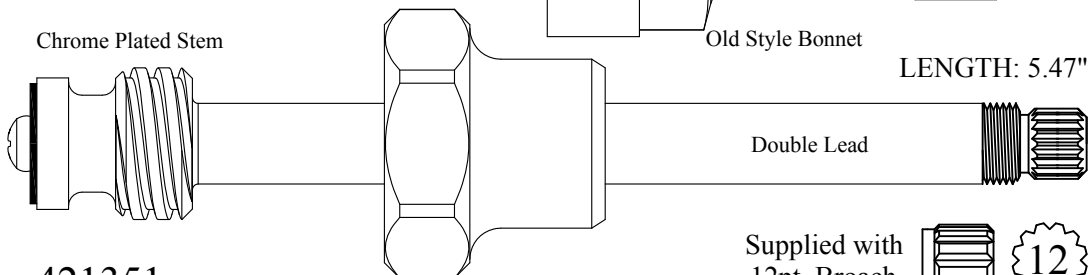

Chrome Plated Stem

LENGTH: 5.47"

Double Lead

Supplied with
12pt. Broach



421351
221351 Stem Only

FOR PRICE PFISTER

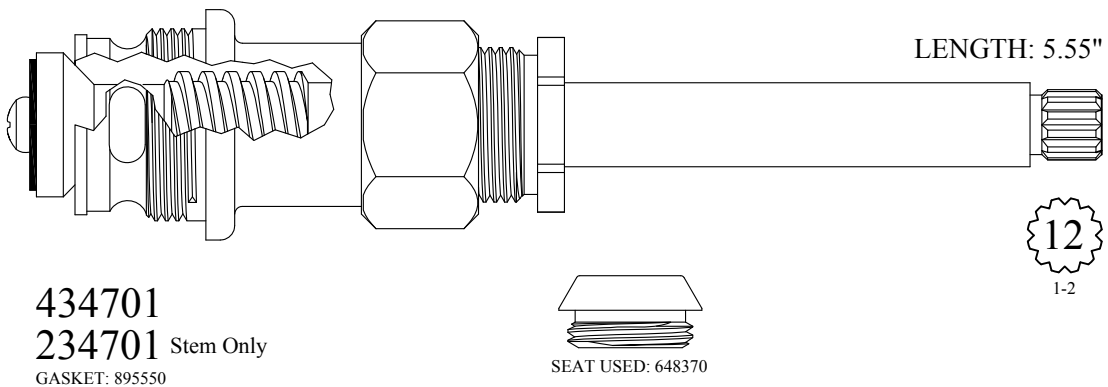
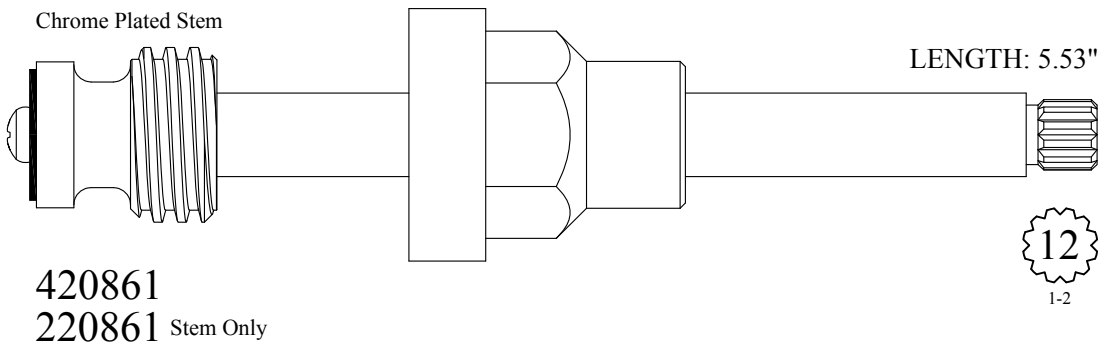
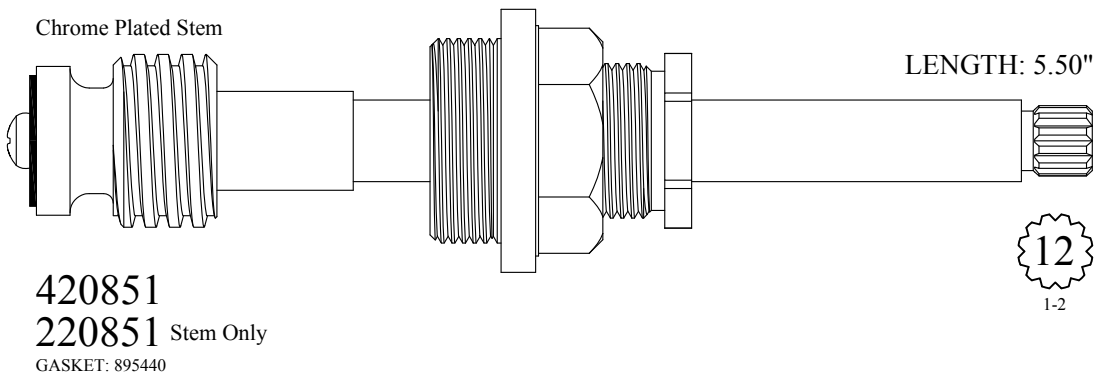
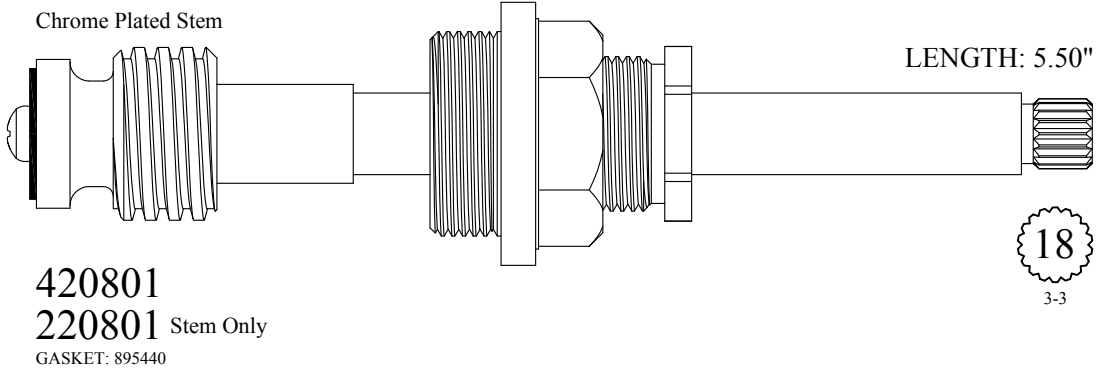

FOR PRICE PFISTER

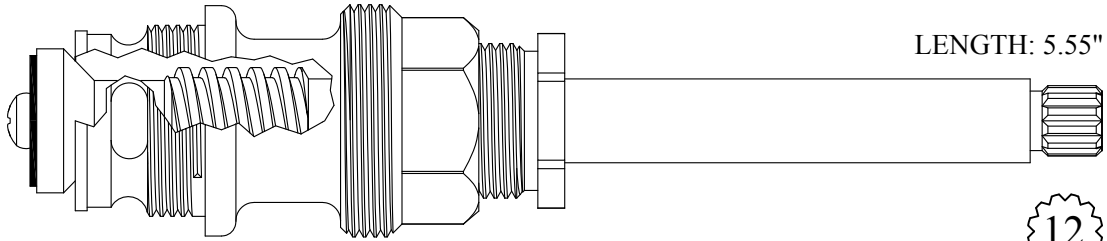

LENGTH: 5.55"

12
1-2

434711
234701 Stem Only
GASKET: 895550



SEAT USED: 648370

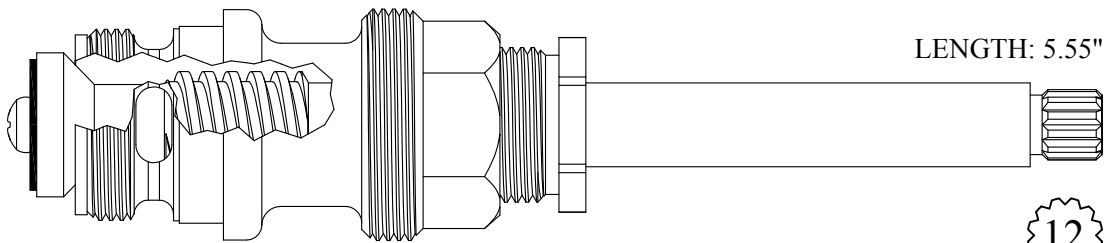

LENGTH: 5.55"

12
1-2

434751
234701 Stem Only
GASKET: 895560



SEAT USED: 648370

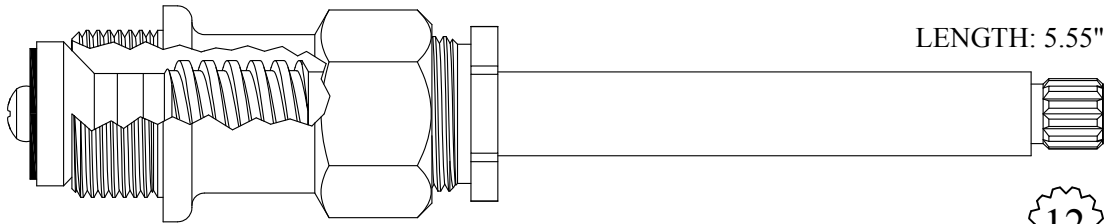

LENGTH: 5.55"

12
1-2

421601/ 421602
221601/ 221602 Stem Only
GASKET: 895400



SEAT USED: 648370

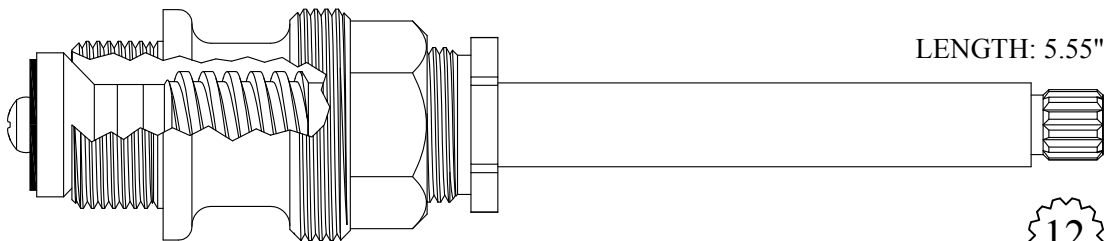

LENGTH: 5.55"

12
1-2

421611/ 421612
221601/ 221602 Stem Only
GASKET: 895400

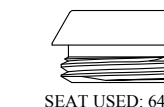

SEAT USED: 648370

FOR PRICE PFISTER

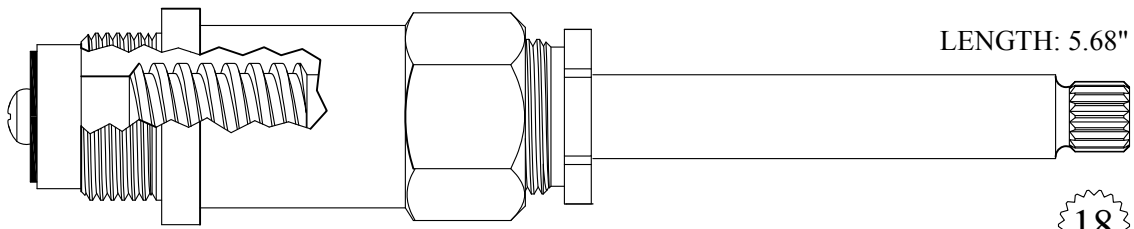

LENGTH: 5.68"

Use 421601



18
Old Style
Price Pfister

Ceramic Conversion for 421601 / 421602

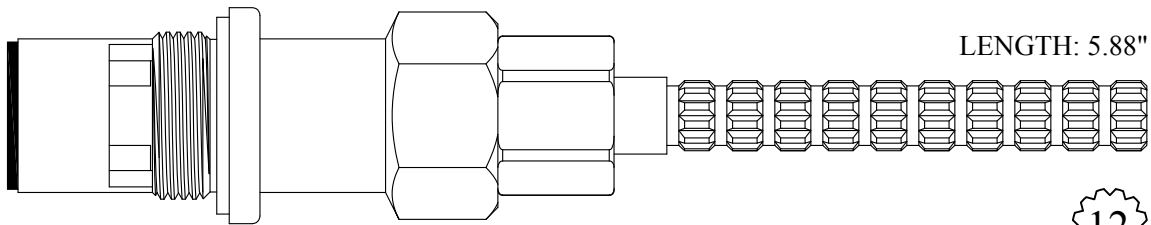

LENGTH: 5.88"

421691/ 421692

GASKET: 895390 INCLUDED
SEAL: 898550
DISC SET: 124290-PKG

12
1-2

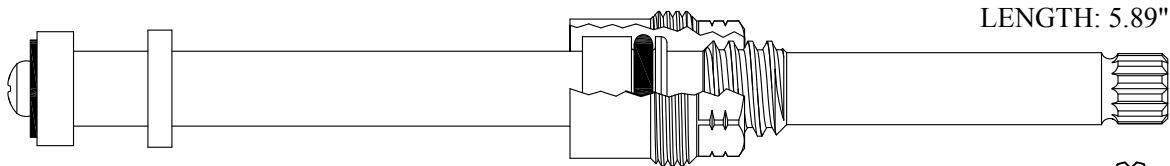

LENGTH: 5.89"

LF480071/ LF480072

GASKET: 895060

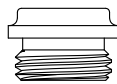

SEAT USED: LF648270

12
1-2

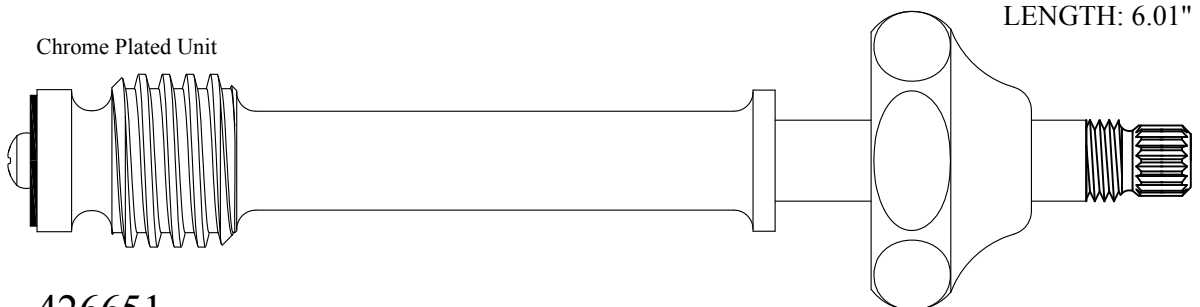

LENGTH: 6.01"

Chrome Plated Unit

426651
226651 Stem Only

Supplied with
12pt. Broach



12
1-2

FOR PRICE PFISTER

Chrome Plated Stem

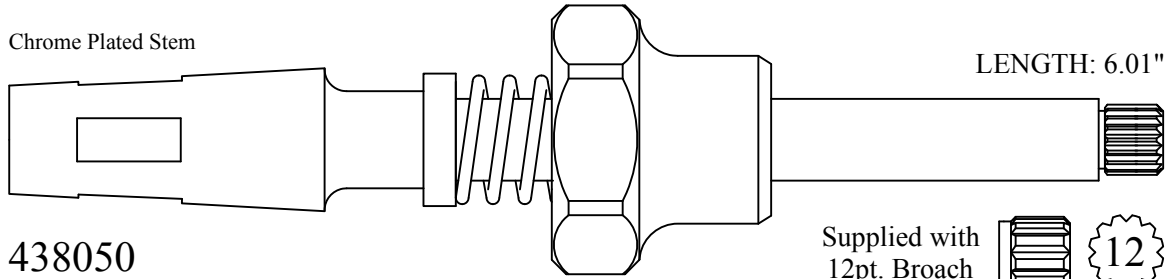

LENGTH: 6.01"

438050
238050 Stem Only

Supplied with
12pt. Broach

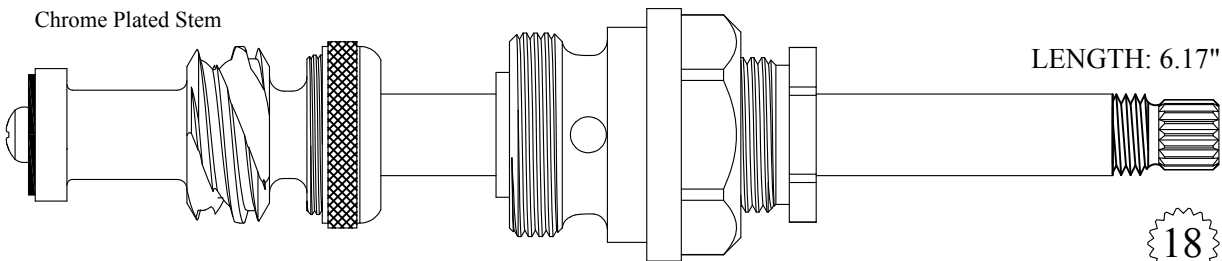

Chrome Plated Stem

LENGTH: 6.17"

438301
238301 Stem Only
GASKET: 895450

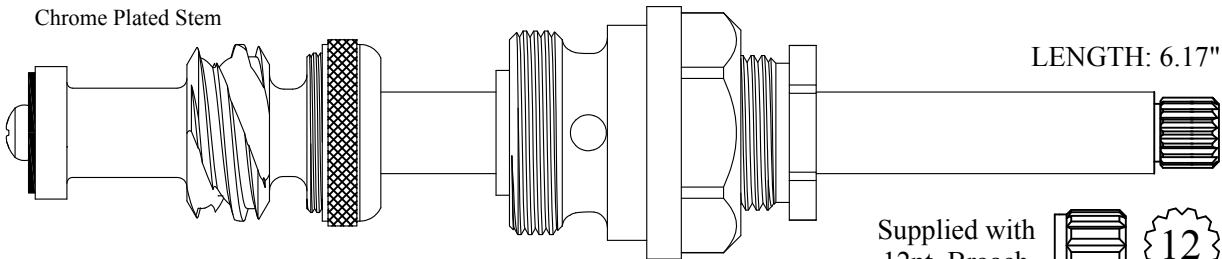

Chrome Plated Stem

LENGTH: 6.17"

438351
238351 Stem Only
GASKET: 895450

Supplied with
12pt. Broach

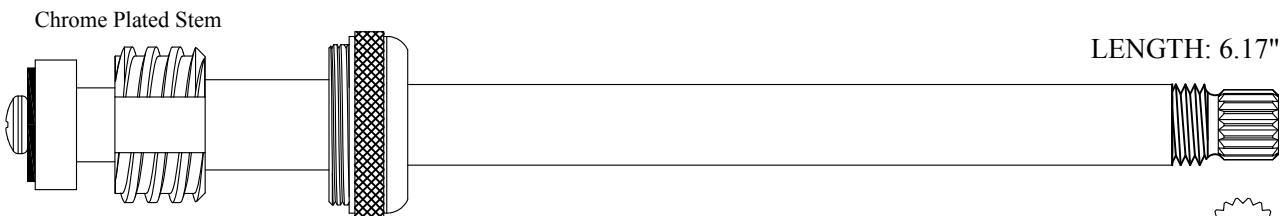

Chrome Plated Stem

LENGTH: 6.17"

239152



FOR PRICE PFISTER

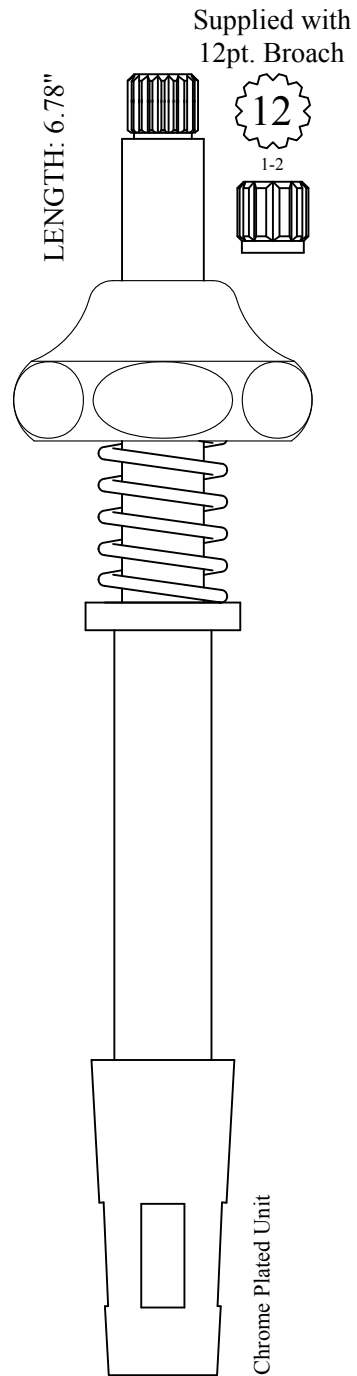

439350
239350 Stem Only

FOR PRINCIPE

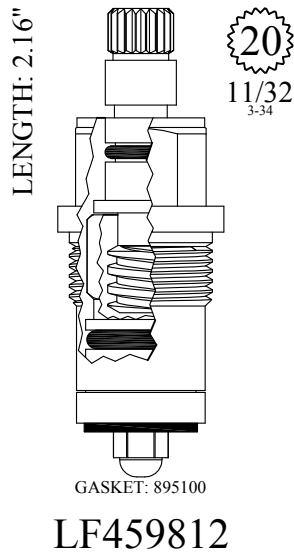

Send Your Orders To:

BARRY E.  SR. CO.

E-mail: orderdesk@barrywalter.com

Fax: 1.800.886.9831

Phone: 1.800.767.5552

FOR PUBCO

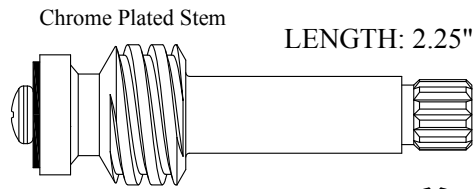

LF262041
LF262042

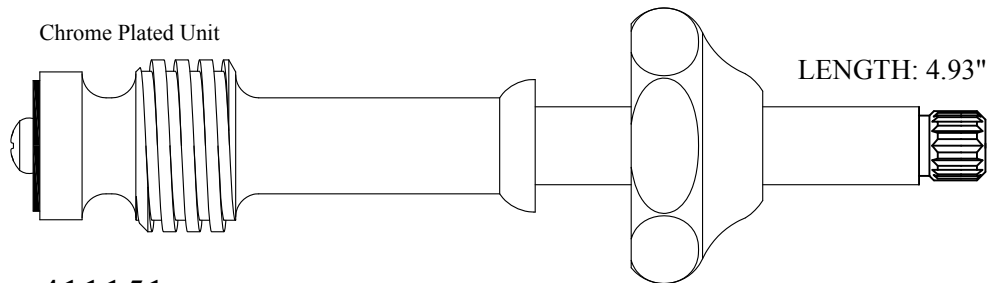

411151
211151 Stem Only

Supplied with
12pt. Broach

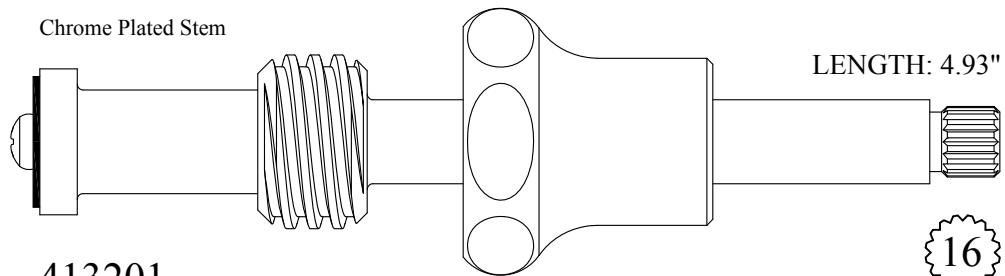

413201
213201 Stem Only

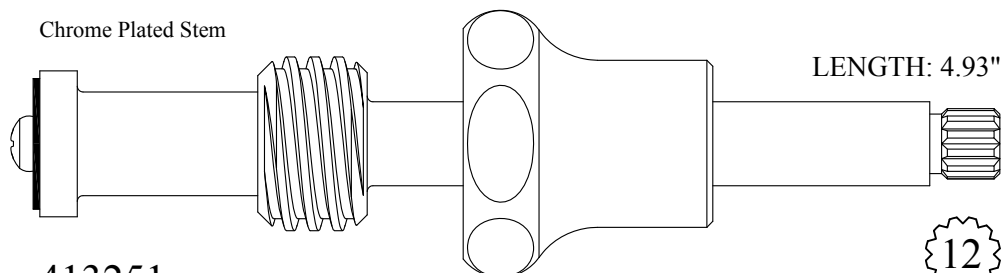

413251
213251 Stem Only



FOR PUBCO

LENGTH: 5.20"



416501
216501 Stem Only

16
1-6

LENGTH: 5.20"



416551
216551 Stem Only

12
1-2

LENGTH: 5.40"

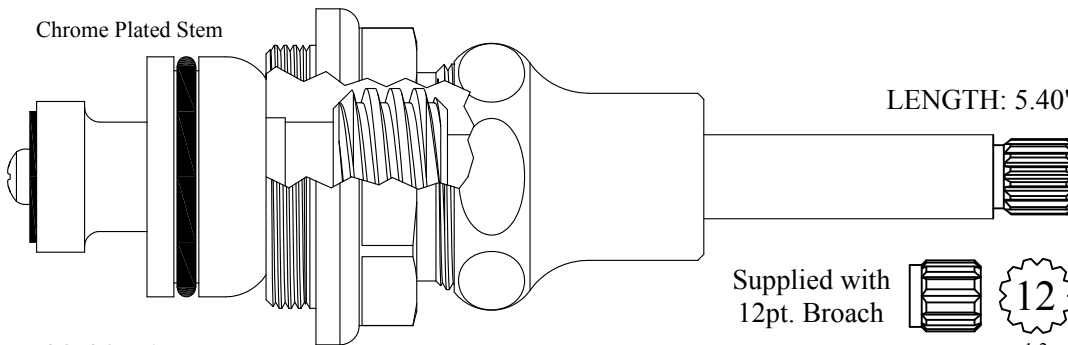

434951
234951 Stem Only
GASKET: 895500

Supplied with
12pt. Broach

12
1-2

LENGTH: 5.44"

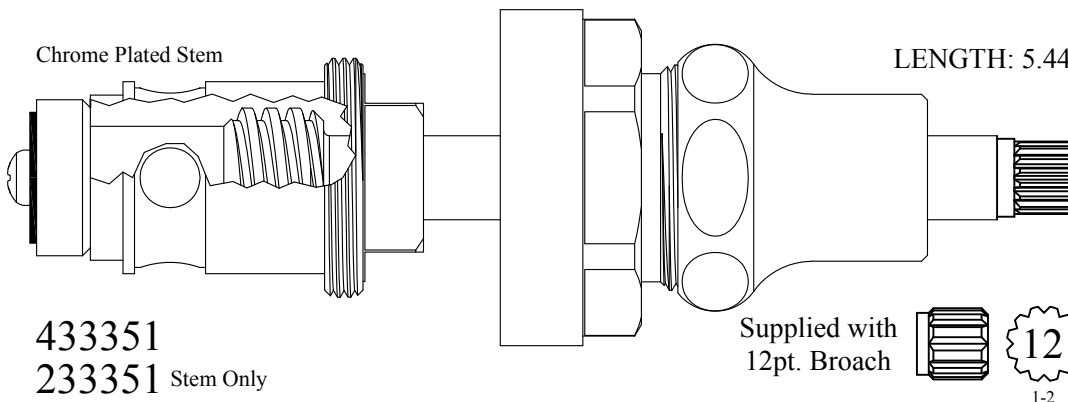

433351
233351 Stem Only

Supplied with
12pt. Broach

12
1-2

FOR PUBCO

Chrome Plated Stem

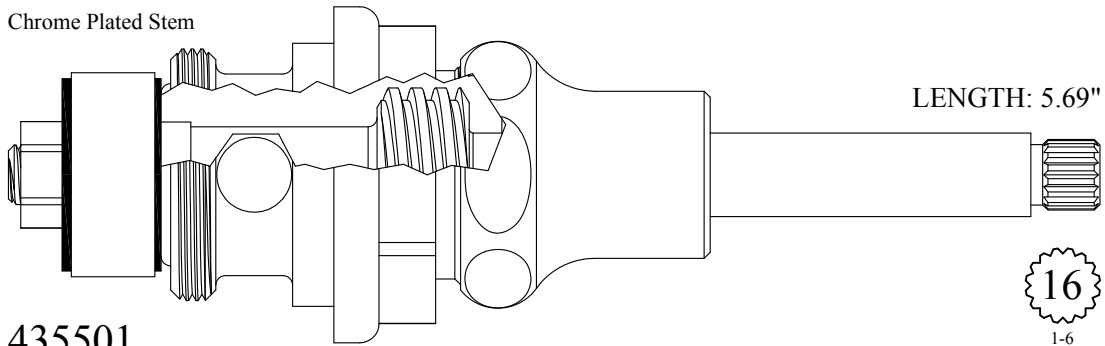

LENGTH: 5.69"



435501

235501 Stem Only

GASKET: 895500

Chrome Plated Stem

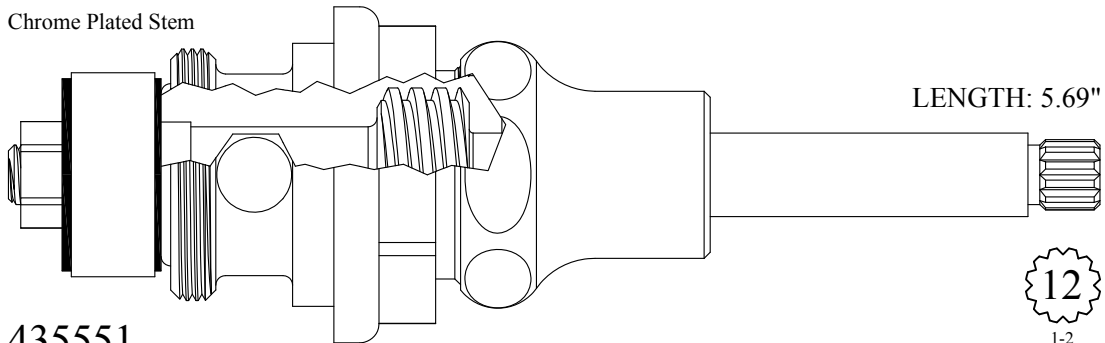

LENGTH: 5.69"



435551

235551 Stem Only

GASKET: 895500

Chrome Plated Stem

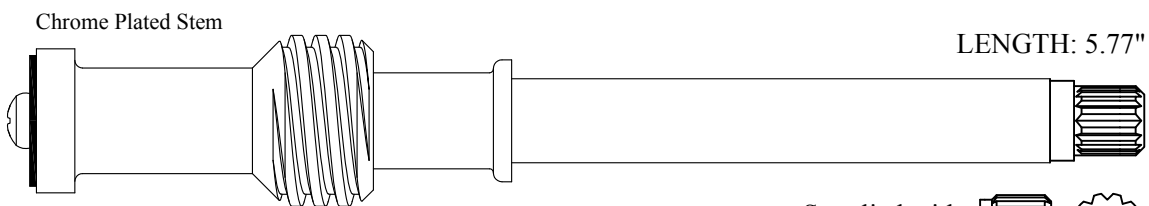

LENGTH: 5.77"

Supplied with
12pt. Broach



225361

Chrome Plated Stem

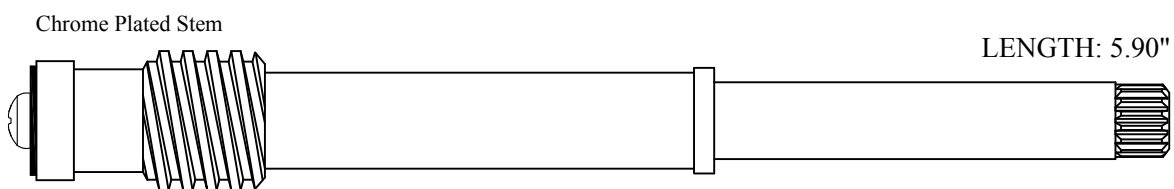

LENGTH: 5.90"



LF280091

FOR QUEEN CITY

Chrome Plated Stem

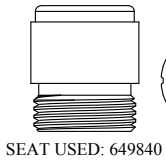

SEAT USED: 649840

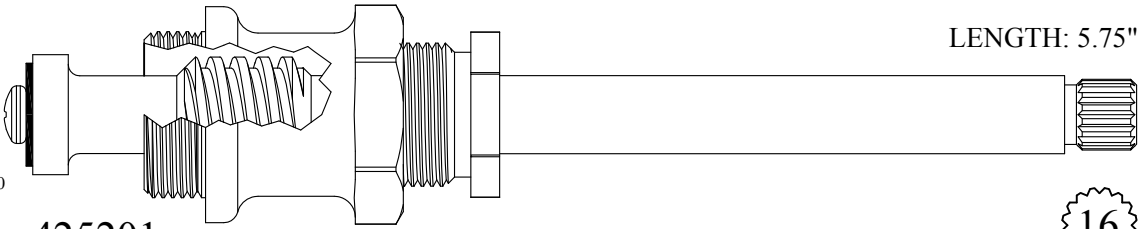

LENGTH: 5.75"

425201
225201 Stem Only
GASKET: 895400

16
1-6

Chrome Plated Stem

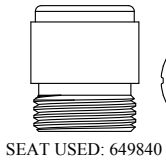

SEAT USED: 649840

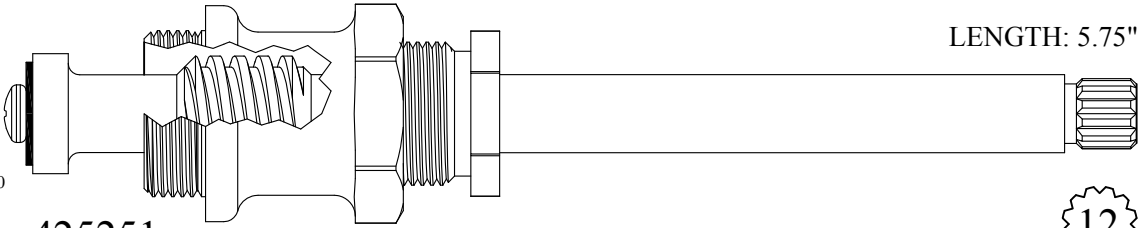

LENGTH: 5.75"

425251
225251 Stem Only
GASKET: 895400

12
1-2

Chrome Plated Stem

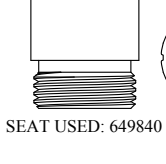

SEAT USED: 649840

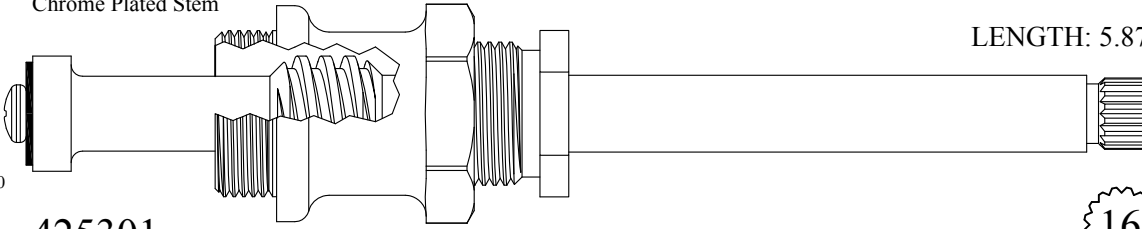

LENGTH: 5.87"

425301
225302 Stem Only
GASKET: 895400

16
1-6

Chrome Plated Stem

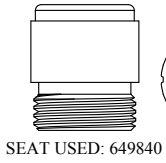

SEAT USED: 649840

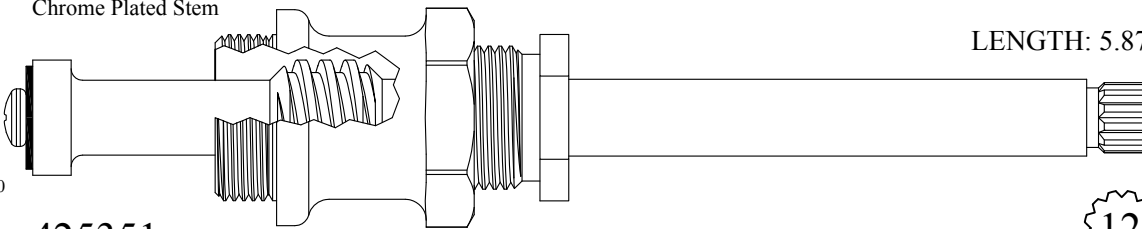

LENGTH: 5.87"

425351
225352 Stem Only
GASKET: 895400

12
1-2

Chrome Plated Stem

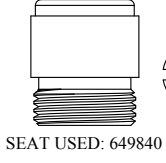

SEAT USED: 649840

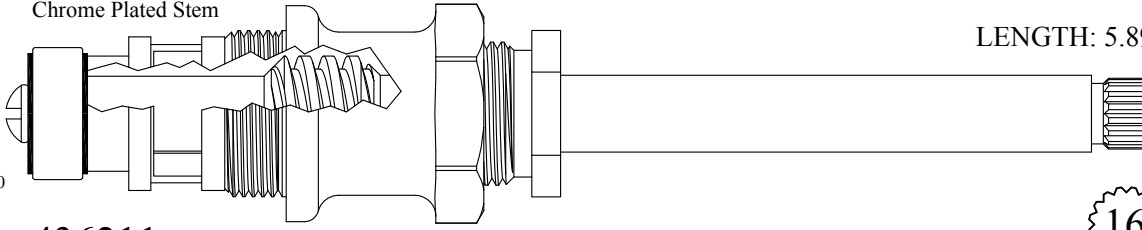

LENGTH: 5.89"

436211
236211 Stem Only
GASKET: 895400

16
1-6

FOR RAPETTI

1/2 Turn Ceramic LENGTH 1.97"

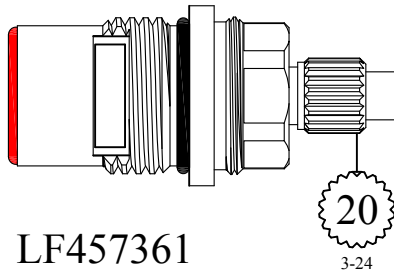

LF457361

LF457362

GASKET: 890170 O-RING INCLUDED
SEAL: 898570-R/B
DISC SET: 124290-PKG

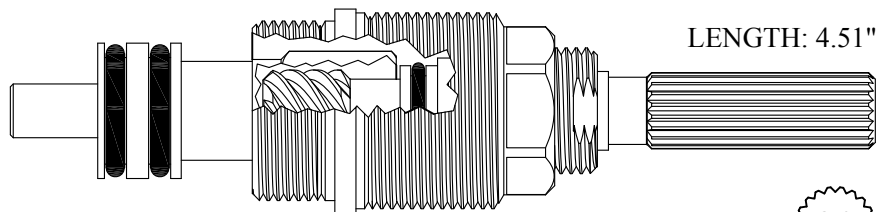

432071

GASKET: 895320

Send Your Orders To:

BARRY E.  SR. CO.

E-mail: orderdesk@barrywalter.com

Fax: 1.800.886.9831

Phone: 1.800.767.5552

FOR REID WATSON

LENGTH: 2.12"

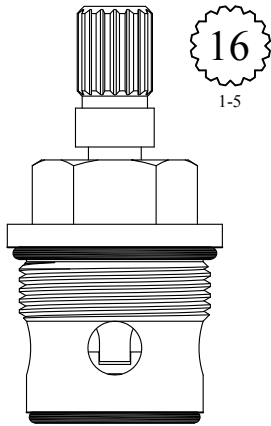

16
1-5

GASKET: 890210 O-RING INCLUDED
SEAL: 898530
DISC SET: 109850-PKG

401151
401152

LENGTH: 2.13"

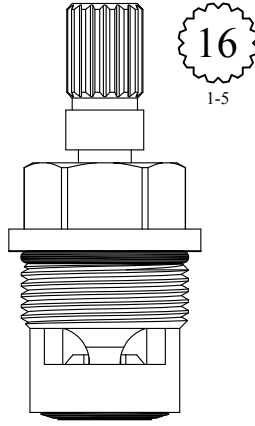

16
1-5

GASKET: 890180 O-RING INCLUDED
SEAL: 898510
DISC SET: 151380-PKG

LF459451
LF459452

LENGTH: 2.60"

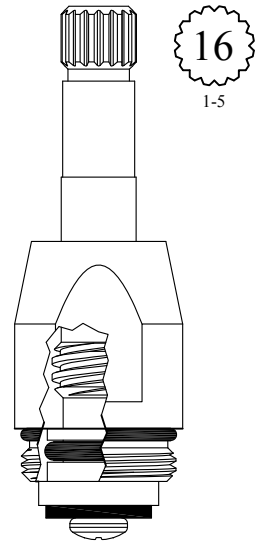

16
1-5

GASKET: 890170 O-RING INCLUDED

LF464501
LF464502

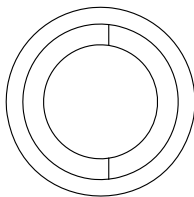

Teflon Sleeve

LENGTH: 3.04"

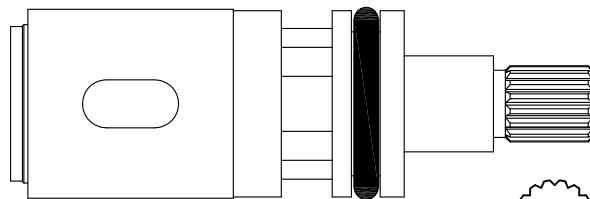

16
1-5

230470

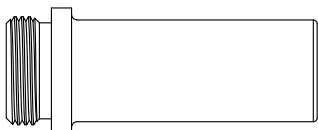

SEAT USED: LF649410

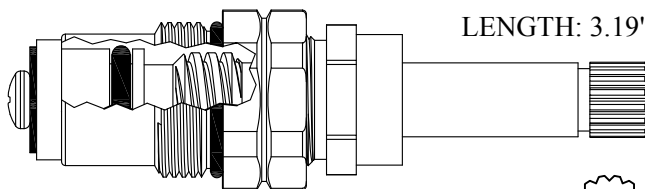

LENGTH: 3.19"

16
1-5

LF466701/ LF466702

GASKET: 890170 O-RING INCLUDED

FOR REID WATSON

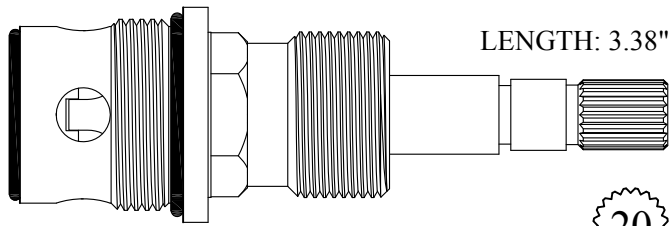

LENGTH: 3.38"

20
3-14

402661/ 402662

GASKET: 890210 O-RING INCLUDED
SEAL: 898530
DISC SET: 109850-PKG

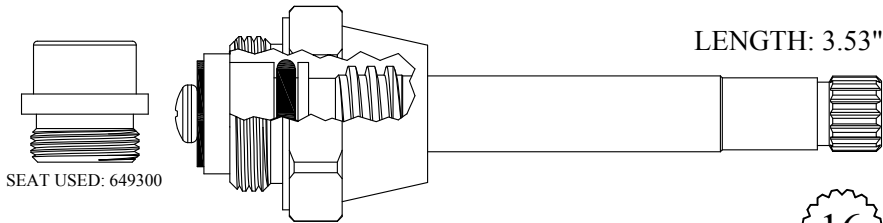

LENGTH: 3.53"

16
1-5

402921/ 402922

GASKET: 895150

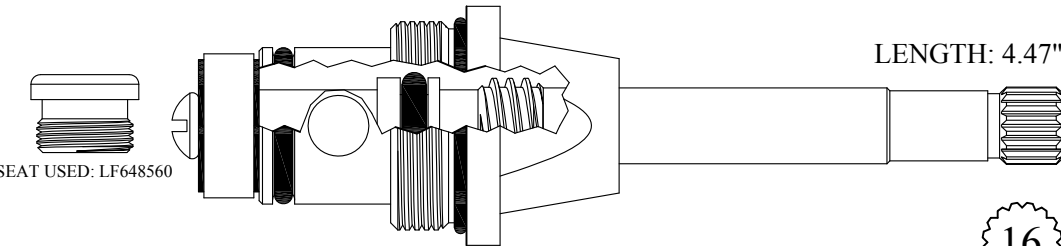

LENGTH: 4.47"

16
1-5

430531

GASKET: 890220 O-RING INCLUDED

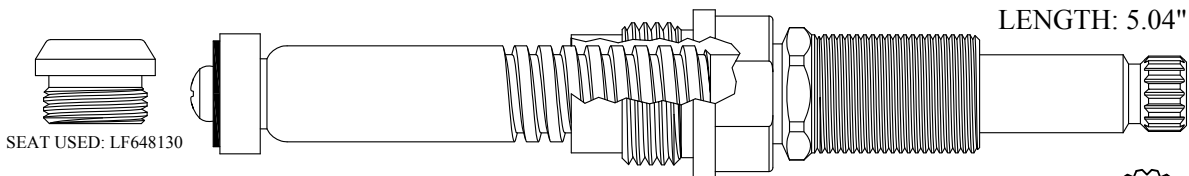

LENGTH: 5.04"

16
1-5

LF478711/ LF478712

GASKET: 895100

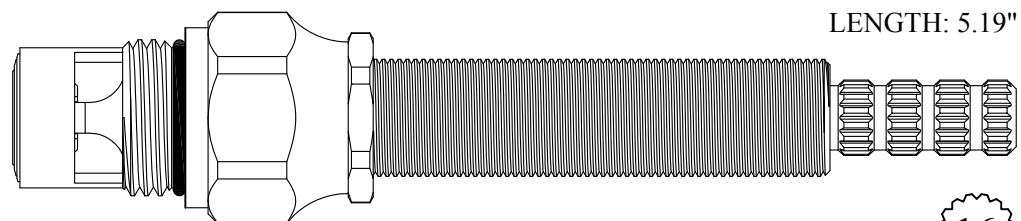

LENGTH: 5.19"

16
1-5

416711/ 416712

GASKET: 890170 O-RING INCLUDED
SEAL: 898510-W
DISC SET: 151380-PKG

FOR RICHMOND RHEEM

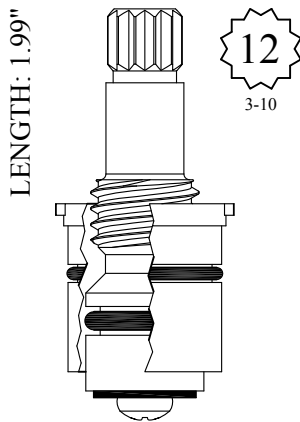

LF458131
LF458132

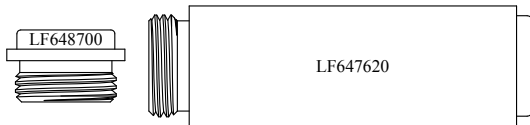

SEAT USED: LF648700 or LF647620

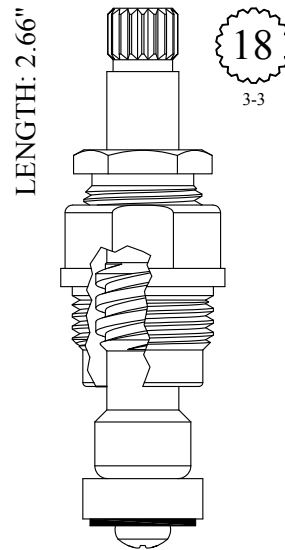

GASKET: 895100

LF465081
LF465082

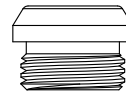

SEAT USED: LF648130

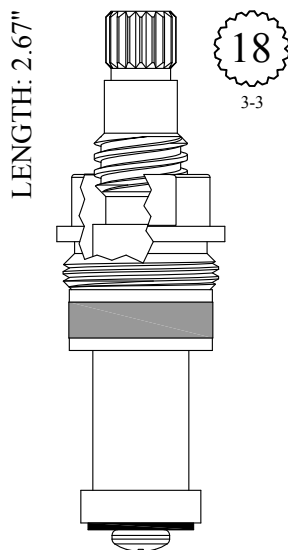

LF465111
LF465112



SEAT USED: LF648560

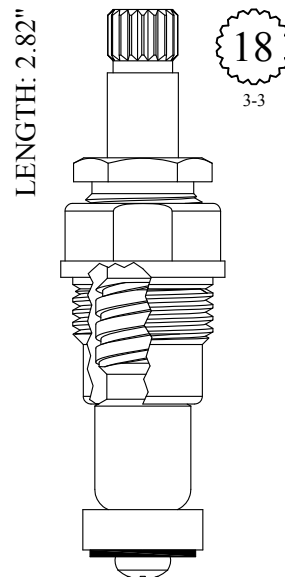

GASKET: 895100

LF465191
LF465192



SEAT USED: LF648130

FOR ROBERTS BRASS

Chrome Plated Stem & Pkg Nut

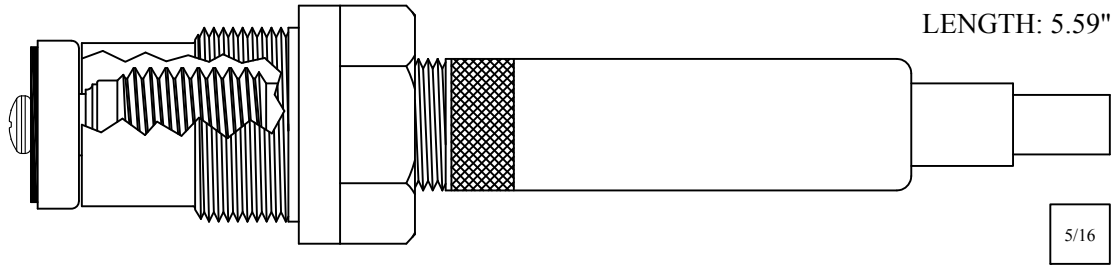

420711

220711 Stem Only

GASKET: 895450

Chrome Plated Stem & Pkg Nut

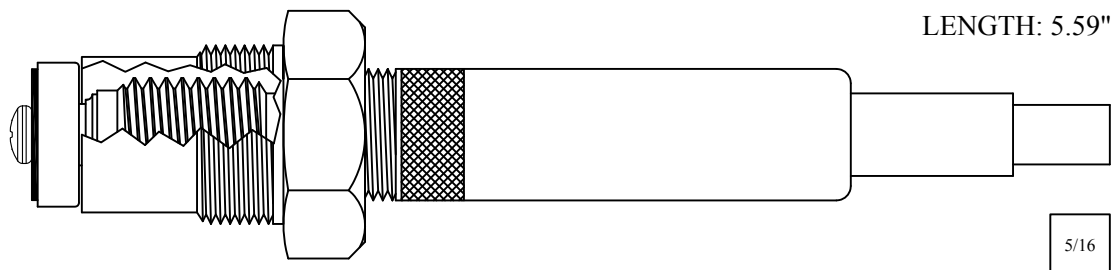

424721

224721 Stem Only

GASKET: 895320

Send Your Orders To:

BARRY E.  WALTER SR. CO.

E-mail: orderdesk@barrywalter.com

Fax: 1.800.886.9831

Phone: 1.800.767.5552

FOR RODAC

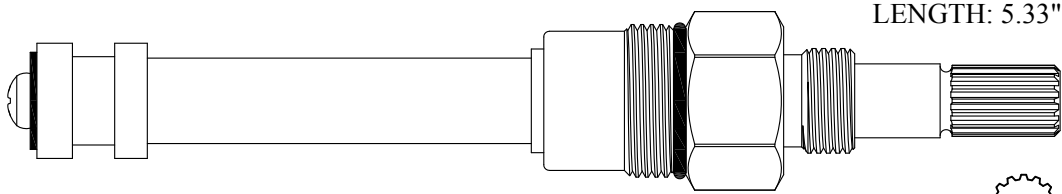

LENGTH: 5.33"

LF479801/ LF479802

GASKET: 890170 O-RING INCLUDED

16

3-16

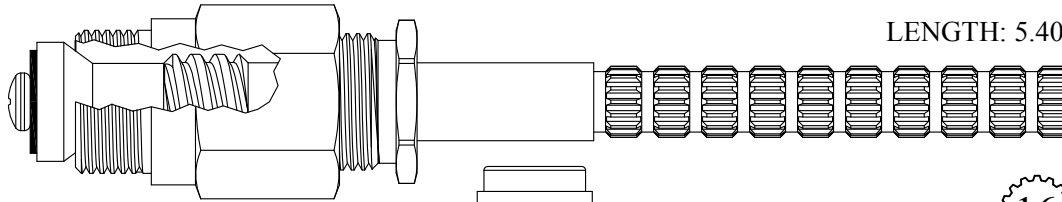

LENGTH: 5.40"

410991/ 410992

GASKET: 895100

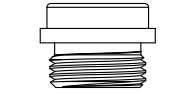

SEAT USED: LF648550

16

3-16

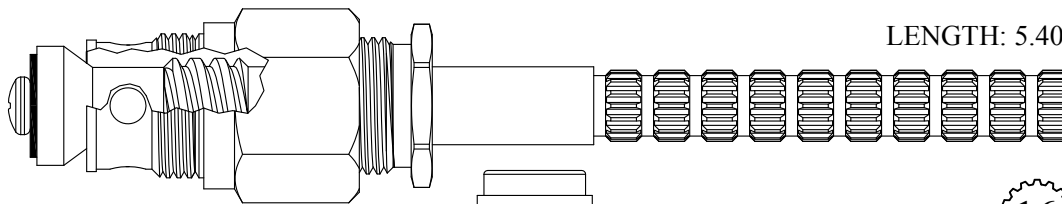

LENGTH: 5.40"

431931

GASKET: 895100

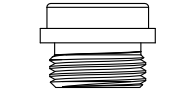

SEAT USED: LF648550

16

3-16

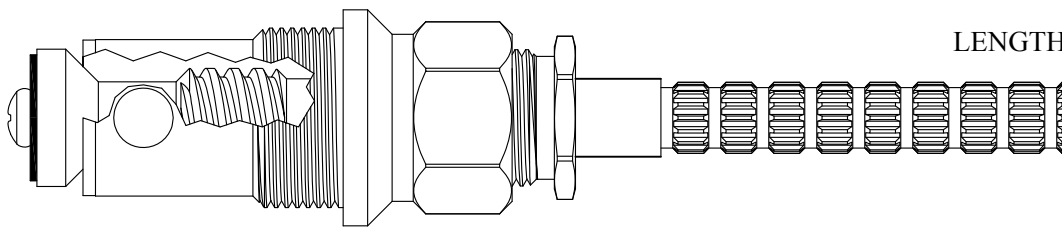

LENGTH: 5.75"

436151

236151 Stem Only

GASKET: 895370



SEAT USED: 648970

16

3-16

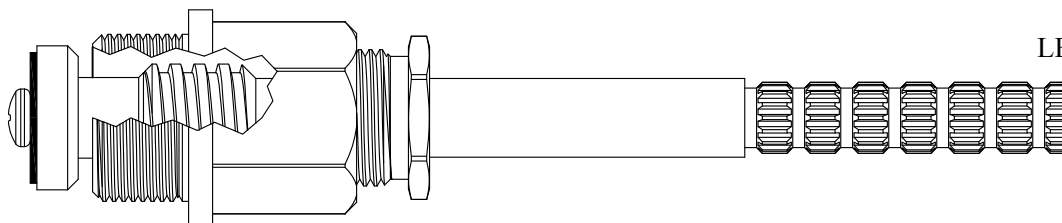

LENGTH: 6.19"

421711/ 421712

221711/ 221712 Stem Only

GASKET: 895400

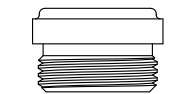

SEAT USED: 648970

16

3-16

FOR ROHL

LENGTH: 2.08"

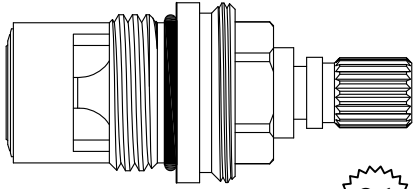

LF459541
LF459542

GASKET: 890170 O-RING INCLUDED
SEAL: 898510-W
DISC SET: 151380-PKG

LENGTH: 2.21"

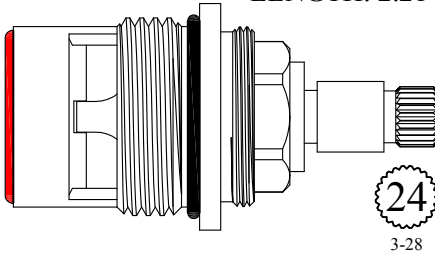

401031/ 401032

GASKET: 890210 O-RING INCLUDED
SEAL: 898610-R/B
DISC SET: 109850-PKG

LENGTH: 2.91"

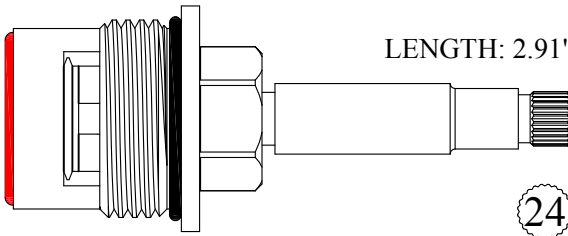

401601/ 401602

GASKET: 890210 O-RING INCLUDED
SEAL: 898610-R/B
DISC SET: 109850-PKG

New Style - Manual

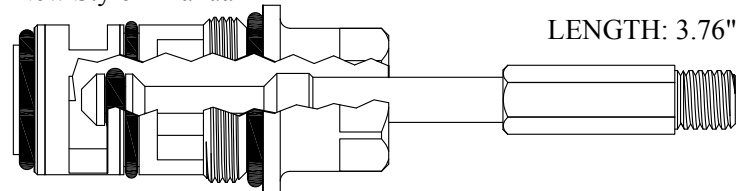

430850

GASKET: 894120 O-RING INCLUDED
Old Style - Automatic with Brass Link

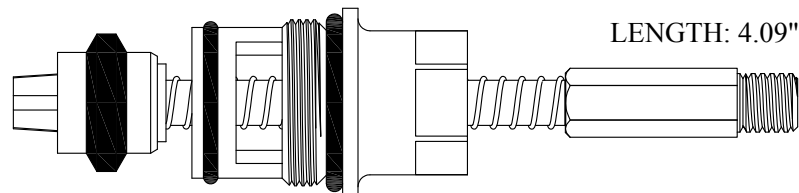

431130

GASKET: 894120 O-RING INCLUDED

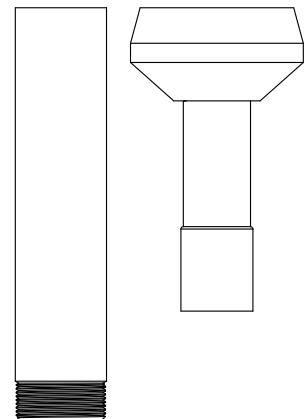

Chrome plated handle
& sleeve available
128540

FOR ROHL

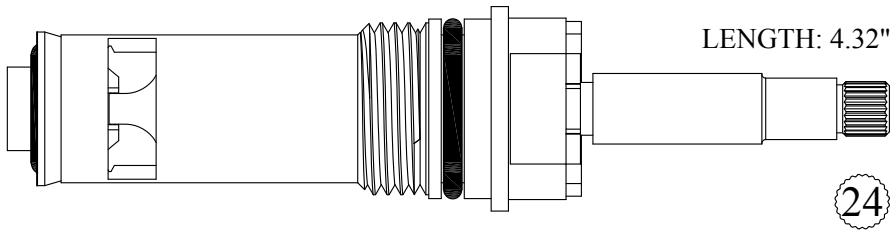

LF471401

SEAL: 898550
DISC SET: 151380-PKG

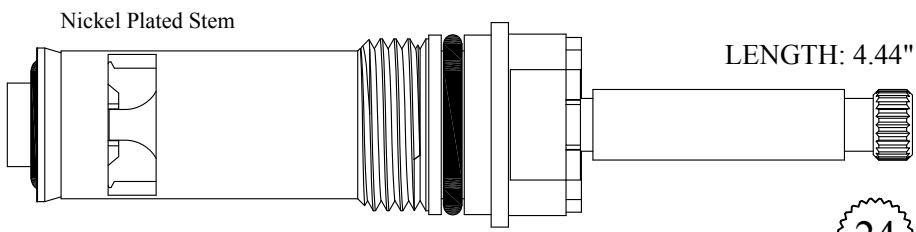

LF471601/ LF471602

SEAL: 898550
DISC SET: 151380-PKG

3-19

FOR ROSS & GADE

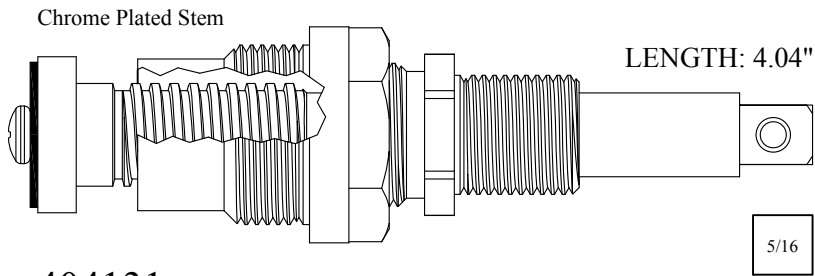

404131

204131 Stem Only

GASKET: 895320

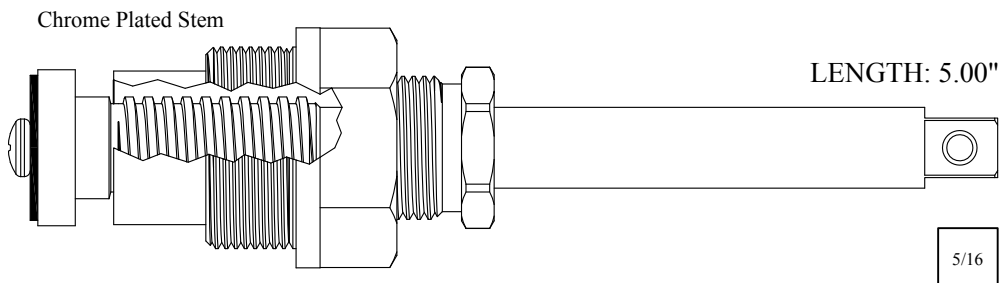

412241

212241 Stem Only

GASKET: 895430

Send Your Orders To:

BARRY E.  SR. CO.

E-mail: orderdesk@barrywalter.com

Fax: 1.800.886.9831

Phone: 1.800.767.5552



BRASS
AMERICA
Quality Replacement Parts

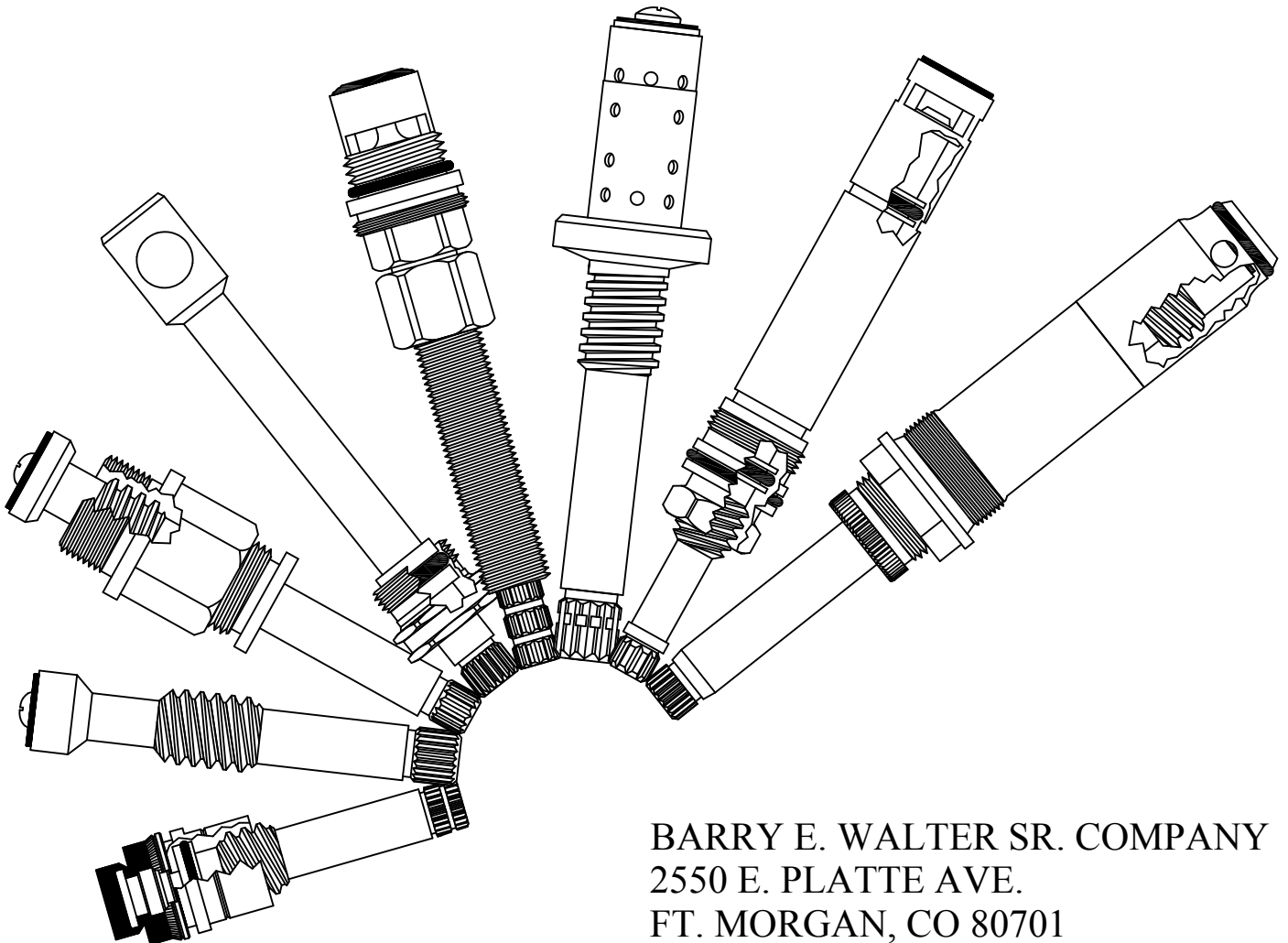

BARRY E. WALTER SR. COMPANY
2550 E. PLATTE AVE.
FT. MORGAN, CO 80701

*We are always adding
new parts. Check our
website for updates.*

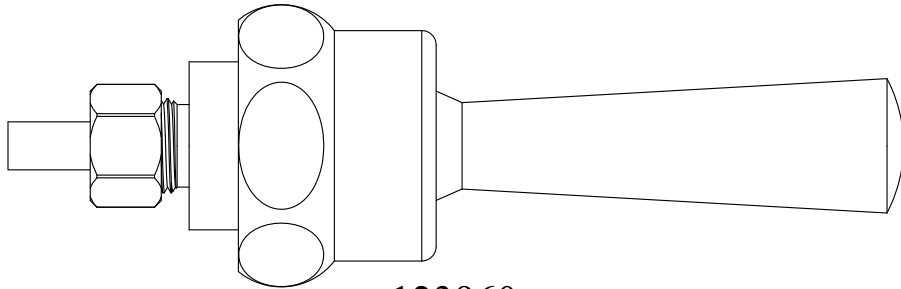

123960
Replaces:
OEM# F35A

BARRY E.  ALTER  SR. CO.

FOR ROYAL BRASS

LENGTH: 1.44"

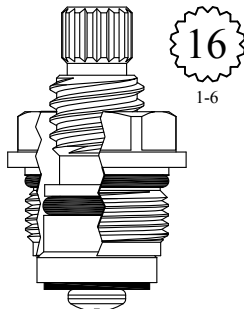

GASKET: 890160 O-RING INCLUDED

LF451131
LF451132

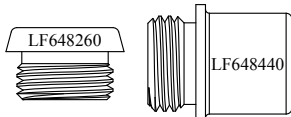

SEAT USED: LF648260 or LF648440

LENGTH: 1.70"

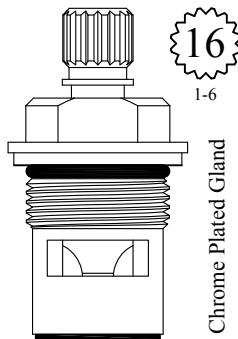

GASKET: 890160 O-RING INCLUDED
SEAL: 898540
DISC SET: 112530-PKG

LF451501
LF451502

LENGTH: 2.25"

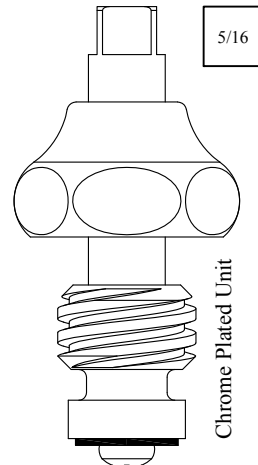

LF461831
LF461832
LF261831 Stem Only
LF261832 Stem Only

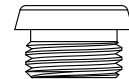

SEAT USED: LF648260

LENGTH: 2.25"

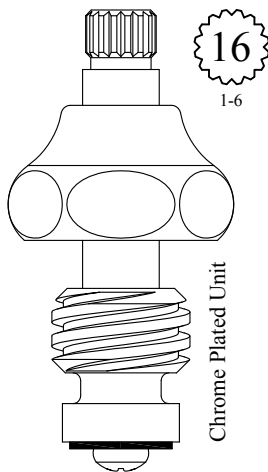

LF461841
LF461842
LF261841 Stem Only
LF261842 Stem Only



SEAT USED: LF648260

LENGTH: 2.38"



LF115960

LENGTH: 2.40"

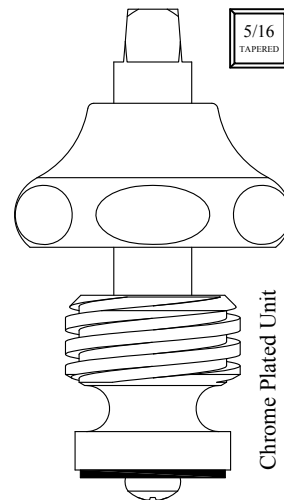

LF463221
LF463222
LF263221 Stem Only
LF263222 Stem Only

FOR ROYAL BRASS

LENGTH: 2.40"

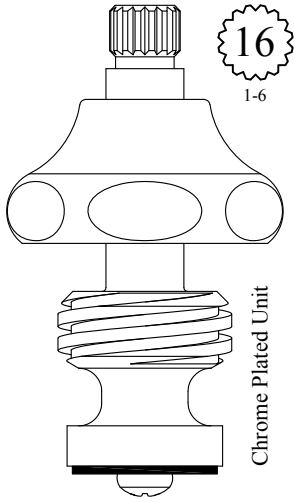

Chrome Plated Unit

LF463251
 LF463252
 LF263251 Stem Only
 LF263252 Stem Only

LENGTH: 2.55"

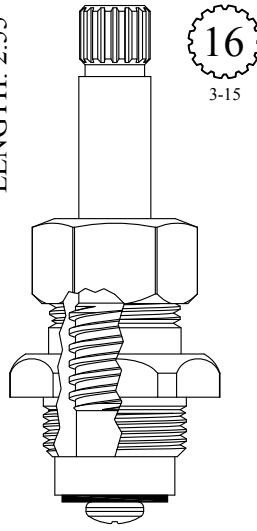

GASKET: 895100

LF463861

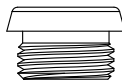

SEAT USED: LF648260

LENGTH: 2.60"

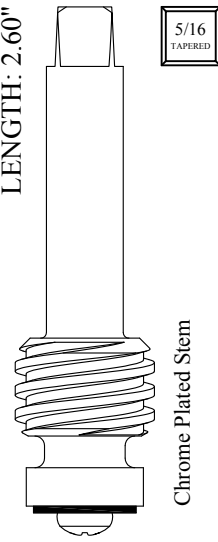

5/16
TAPERED

Chrome Plated Stem

LF264411
 LF264412

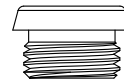

SEAT USED: LF648260

LENGTH: 2.60"

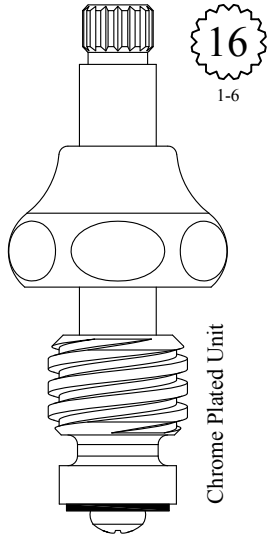

Chrome Plated Unit

LF464401
 LF464402
 LF264401 Stem Only
 LF264402 Stem Only

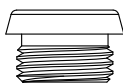

SEAT USED: LF648260

LENGTH: 2.63"

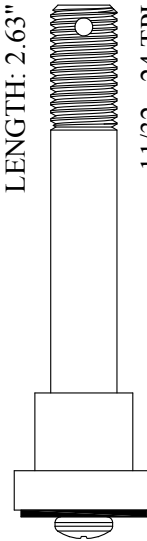

11/32 - 24 TPI

LF264700

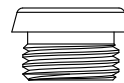

SEAT USED: LF648260

FOR ROYAL BRASS

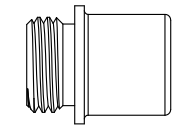

SEAT USED: LF648440

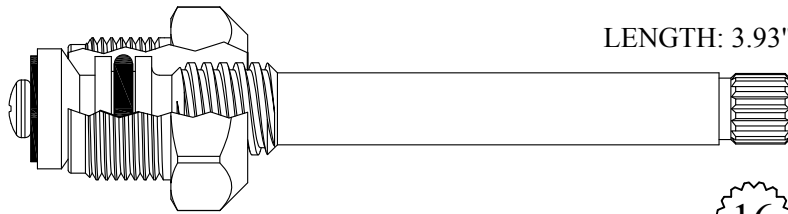

LENGTH: 3.93"

403441

GASKET: 895100



1-6

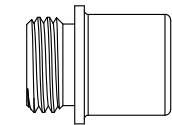

SEAT USED: LF648440

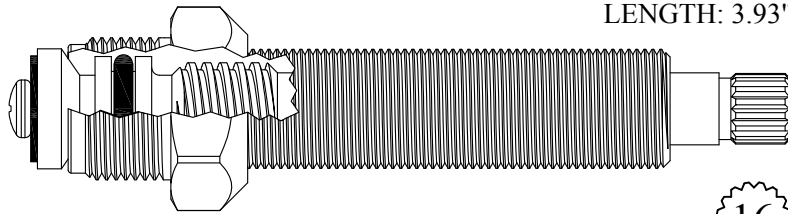

LENGTH: 3.93"

403621

GASKET: 895100



1-6

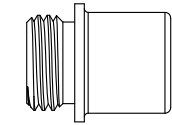

SEAT USED: LF648440

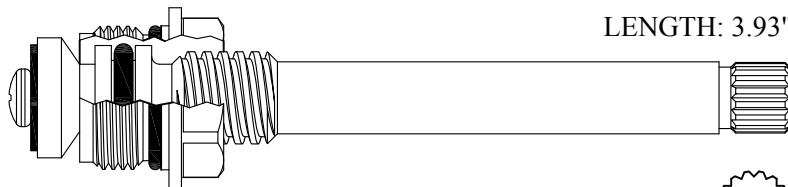

LENGTH: 3.93"

403521

GASKET: 890160 O-RING INCLUDED



1-6

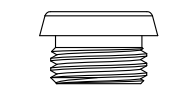

SEAT USED: LF648260

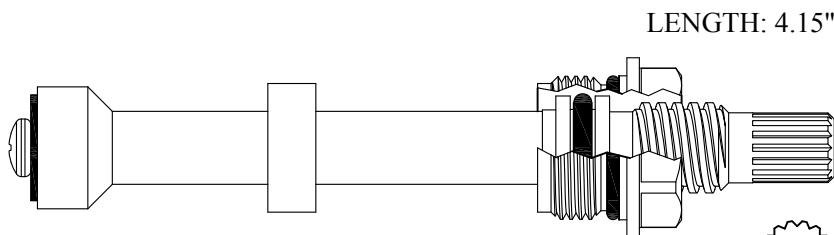

LENGTH: 4.15"

LF470301/ LF470302

GASKET: 890160 O-RING INCLUDED



1-6

FOR ROYAL BRASS

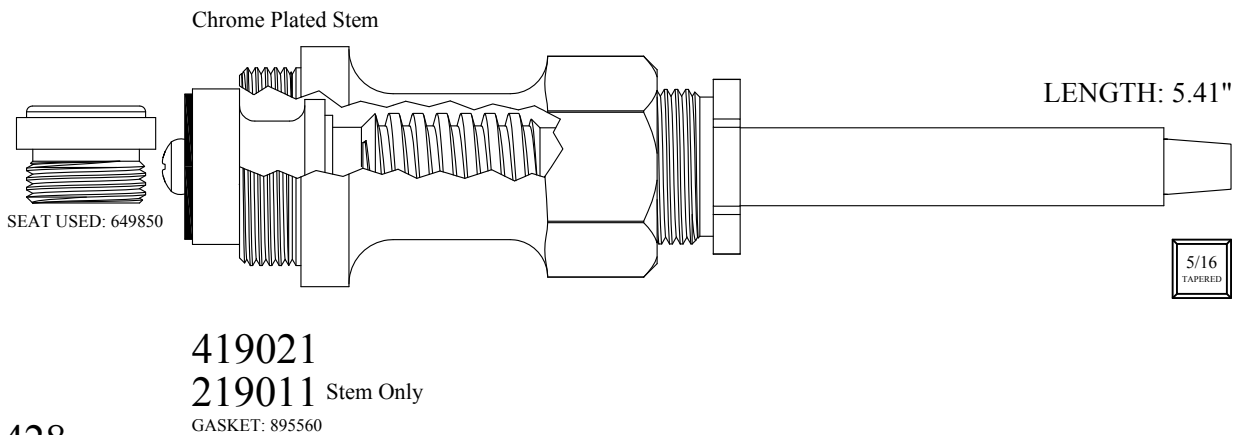
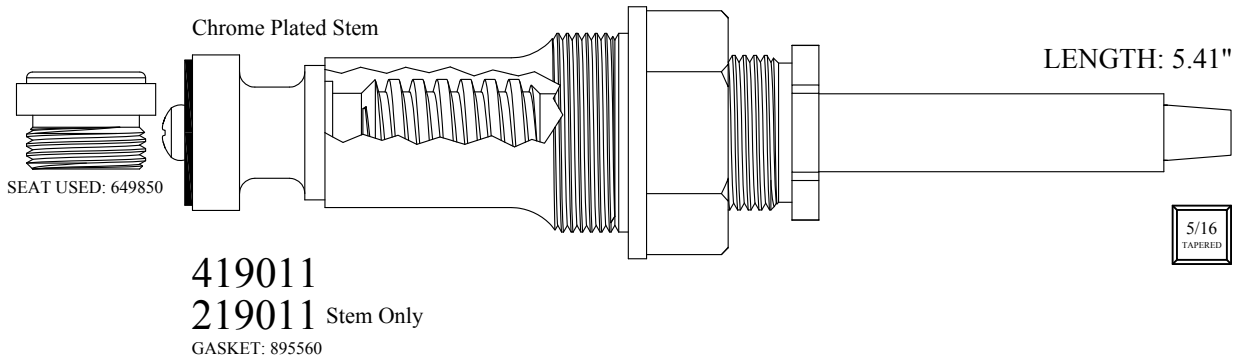
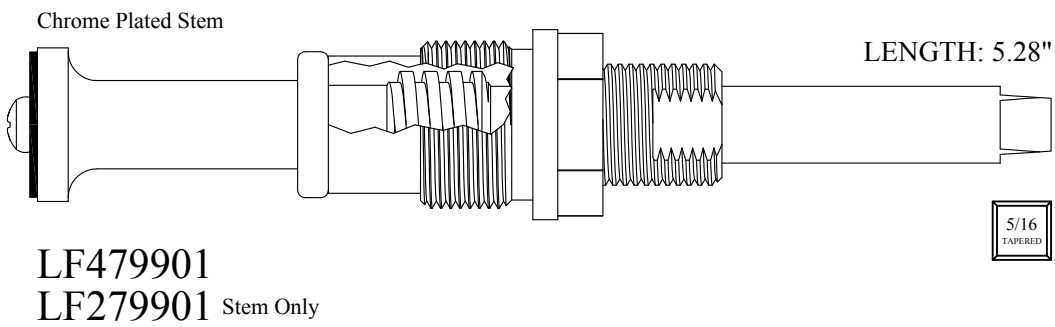
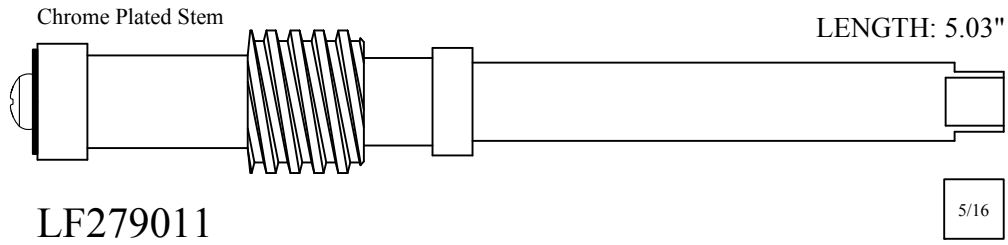

FOR ROYAL BRASS

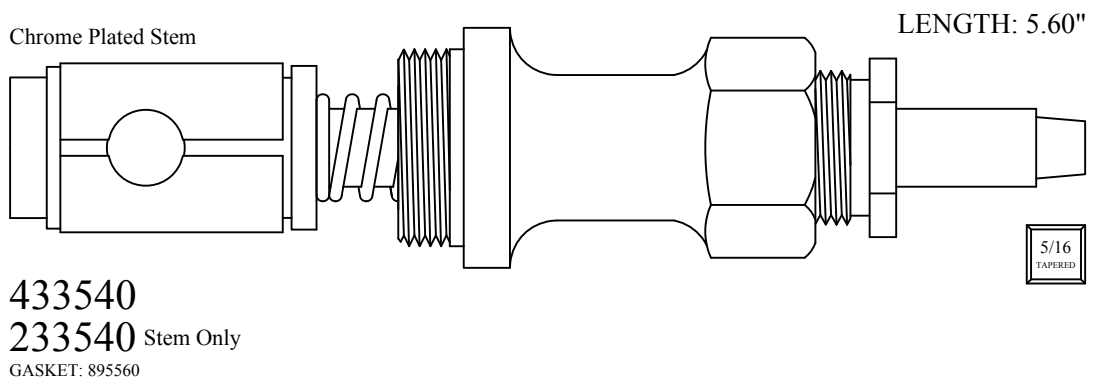
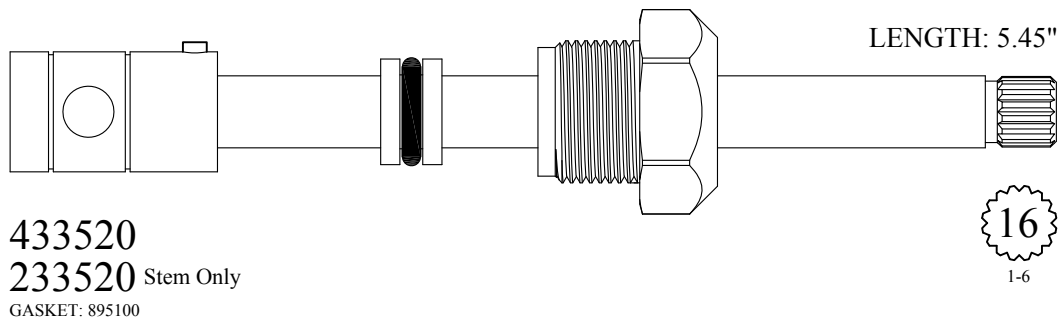
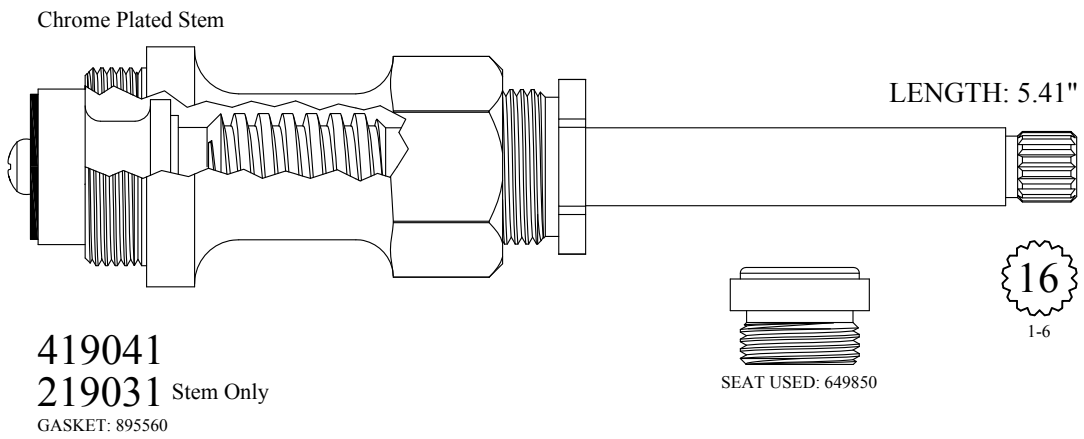
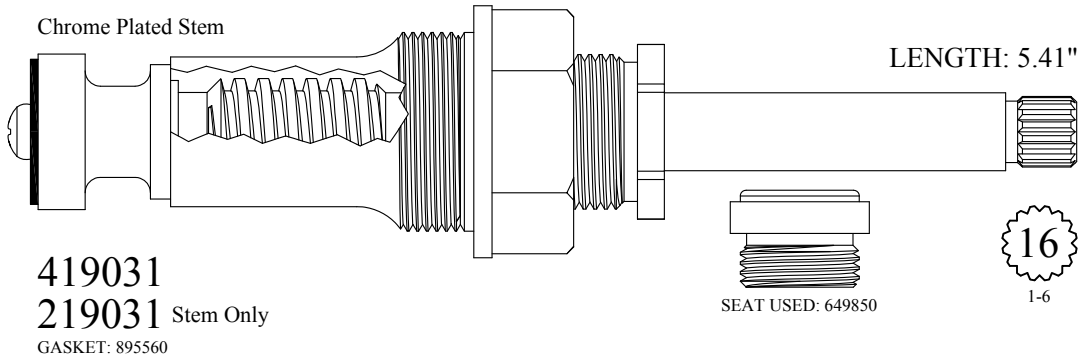

FOR ROYAL BRASS

Chrome Plated Stem

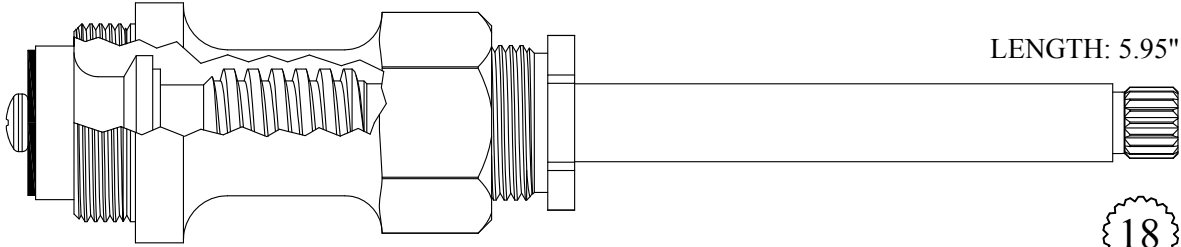

LENGTH: 5.95"

18
3-3

426001
226001 Stem Only
GASKET: 895560

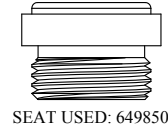

SEAT USED: 649850

Chrome Plated Stem

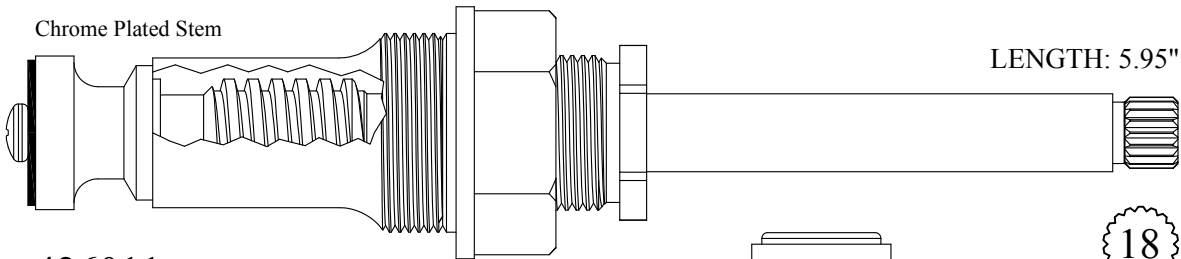

LENGTH: 5.95"

18
3-3

426011
226001 Stem Only
GASKET: 895560

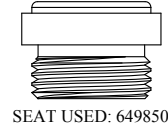

SEAT USED: 649850

Chrome Plated Stem

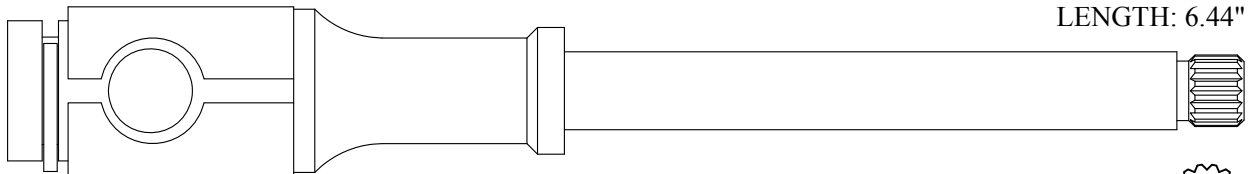

LENGTH: 6.44"

16
1-6

239420

Chrome Plated Stem

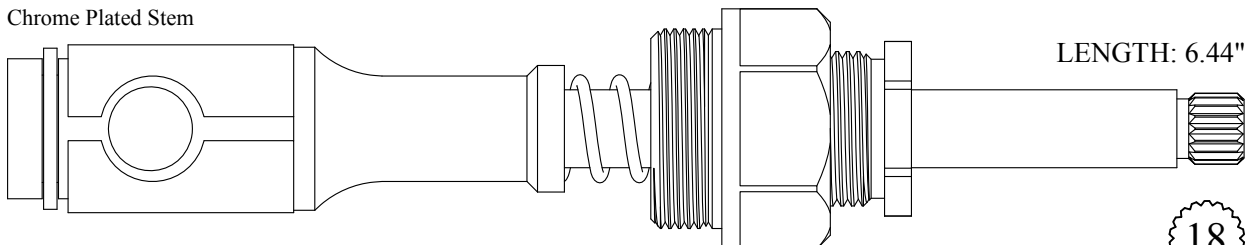

LENGTH: 6.44"

18
3-3

439400
239400 Stem Only
GASKET: 895560

FOR ROYAL BRASS

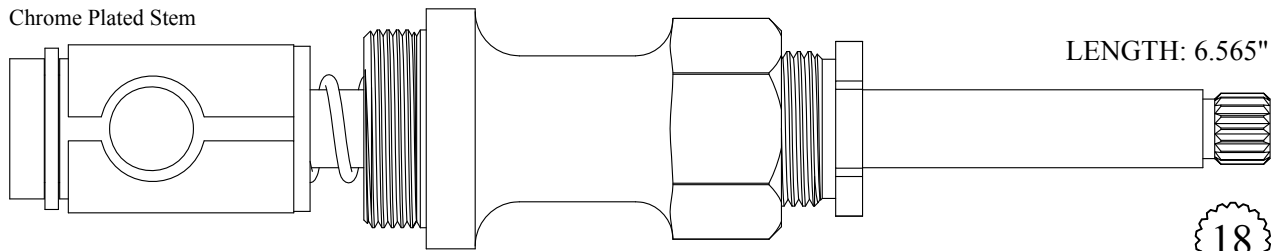

439630
239630 Stem Only
GASKET: 895560

Send Your Orders To:

BARRY E.  ALTER  SR. CO.

E-mail: orderdesk@barrywalter.com

Fax: 1.800.886.9831

Phone: 1.800.767.5552

FOR RUGO

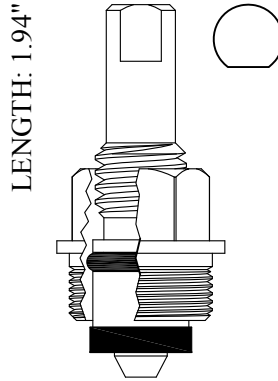

LENGTH: 1.94"

GASKET: 895100

LF458301

FOR SANTEC

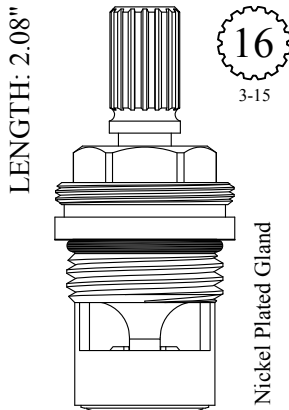

LENGTH: 2.08"

16
3-15

Nickel Plated Gland

GASKET: 890170 O-RING INCLUDED
SEAL: 898510-W
DISC SET: 151380-PKG

LF461911
LF461912

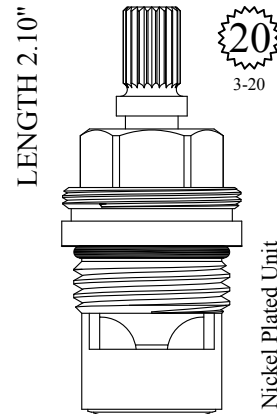

LENGTH 2.10"

20
3-20

Nickel Plated Unit

GASKET: 890170 O-RING INCLUDED
SEAL: 898510-W
DISC SET: 151380-PKG

LF459311
LF459312

FOR SAVOY

LENGTH: 1.31"

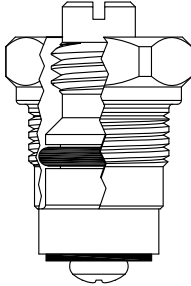

GASKET: 895100

400291

LENGTH: 1.63"

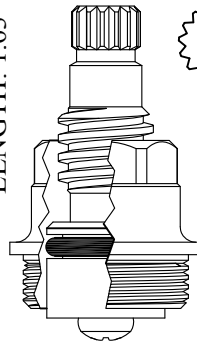

15
1-13

Chrome Plated Gland

GASKET: 895150

LF452201
LF452202

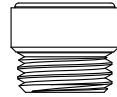

SEAT USED: LF649740

LENGTH: 1.63"

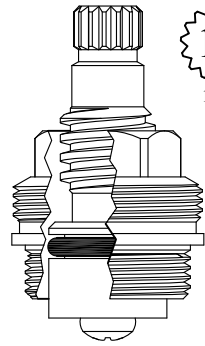

15
1-13

GASKET: 895150

LF452211
LF452212

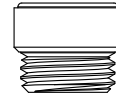

SEAT USED: LF649740

LENGTH: 2.16"

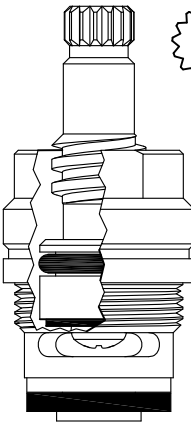

15
1-13

Chrome Plated Gland

Also available with monel seat LF648850-M
LF459631-M / LF459632-M

GASKET: 895150
SEAT INCLUDED: LF648850

LF459631
LF459632

LENGTH: 2.31"

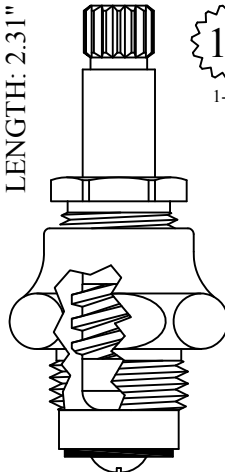

15
1-13

GASKET: 895100

LF462121

LENGTH: 2.39"

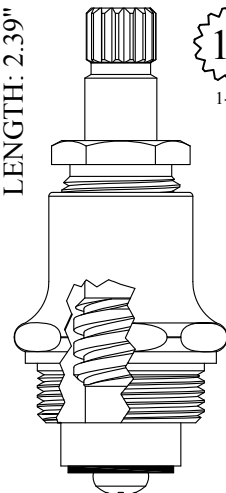

15
1-13

Chrome Plated Unit

GASKET: 895400

LF462081
LF462082

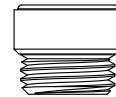

SEAT USED: LF649740

FOR SAVOY

LENGTH: 3.01"

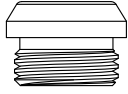

SEAT USED: LF648130

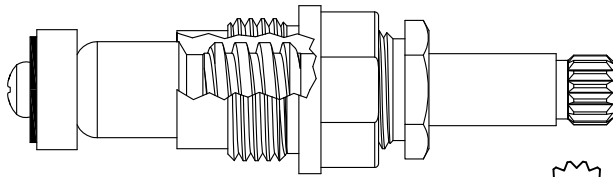

LF465211/ LF465212

GASKET: 895100



Chrome Plated Stem

LENGTH: 3.46"

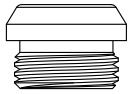

SEAT USED: LF648130

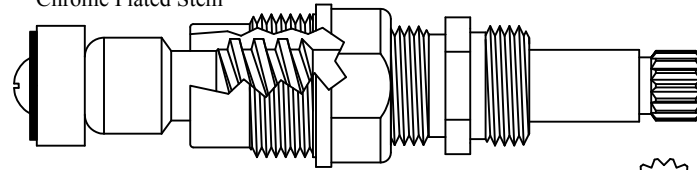

LF468051/ LF468052

GASKET: 895100

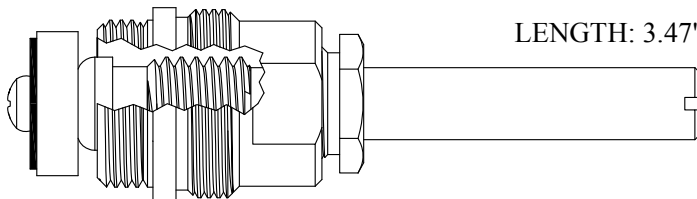

LENGTH: 3.47"

402831

GASKET: 895400

Chrome Plated Stem

LENGTH: 3.49"

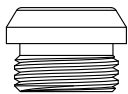

SEAT USED: LF648130

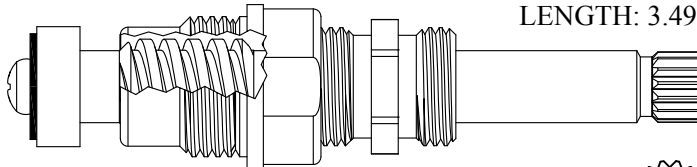

LF468021/ LF468022

GASKET: 895100



FOR SAVOY

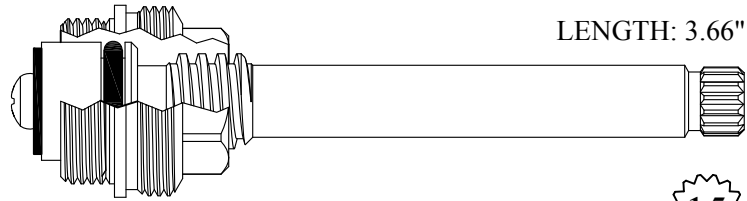

403321
GASKET: 895400

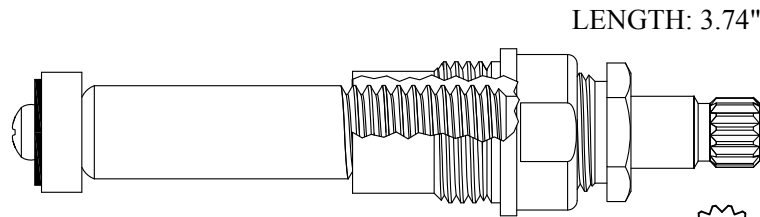

LF468801/ LF468802
GASKET: 895100

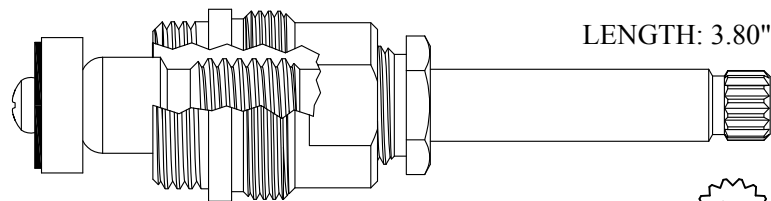

403411
203411 Stem Only
GASKET: 895400

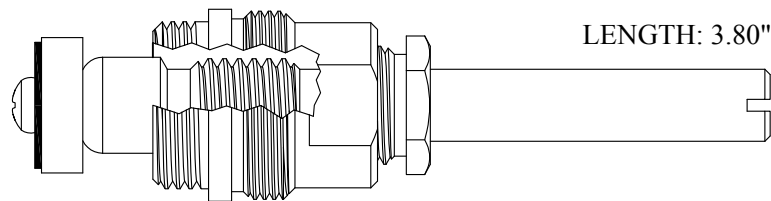

403561
GASKET: 895400

FOR SAVOY

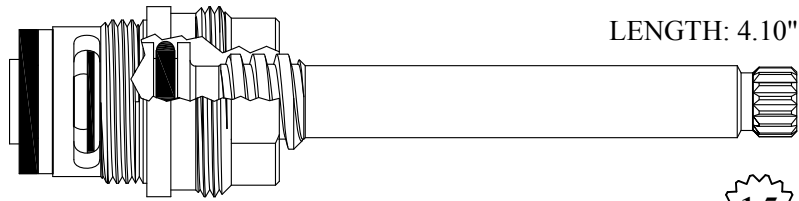

LENGTH: 4.10"

403341

GASKET: 895400
SEAT INCLUDED: LF648850

Also available with monel seat 648850-M

403341-M



1-13

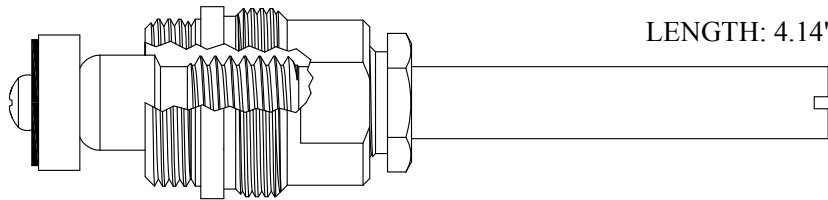

LENGTH: 4.14"

405521

GASKET: 895400



SEAT USED: LF648130

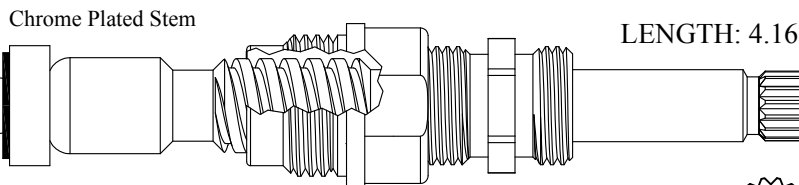

Chrome Plated Stem

LENGTH: 4.16"

LF469011/ LF469012

LF269011/ LF269012 Stem Only

GASKET: 895100



1-13



SEAT USED: LF648130

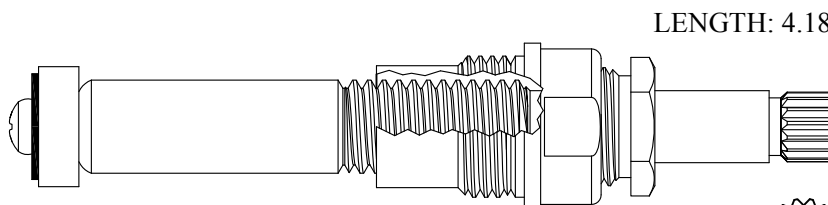

LENGTH: 4.18"

LF471231/ LF471232

LF271231/ LF271232 Stem Only

GASKET: 895100



1-13

FOR SAVOY

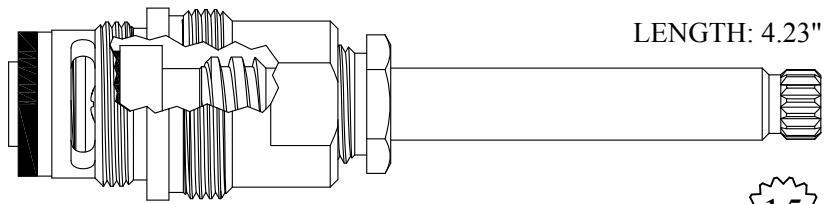

LENGTH: 4.23"

15

1-13

403311

GASKET: 895400SEAT
INCLUDED: LF648850

Also available with monel seat LF648850-M

403311-M

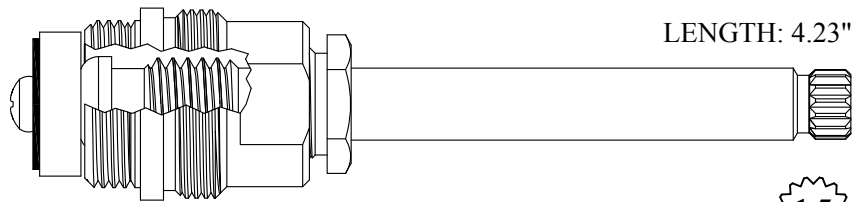

LENGTH: 4.23"

15

1-13

405631

205631 Stem Only

GASKET: 895400

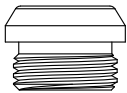

SEAT USED: LF648130

Chrome Plated Stem

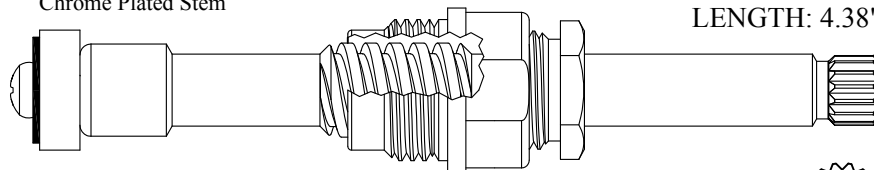

LENGTH: 4.38"

15

1-13

LF471111/ LF471112

LF271111/ LF271112 Stem Only

GASKET: 895100

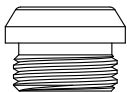

SEAT USED: LF648130

1/4L Bibb Washer

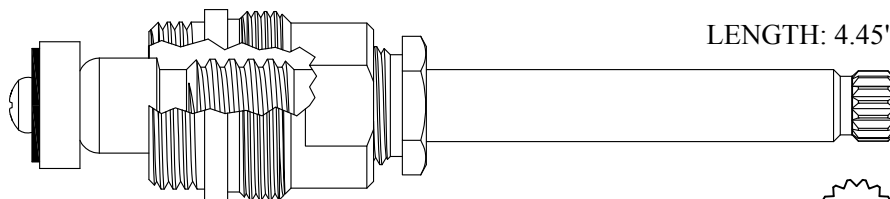

LENGTH: 4.45"

15

1-13

406711

206711 Stem Only

GASKET: 895400

FOR SAVOY

3/8M Bibb Washer

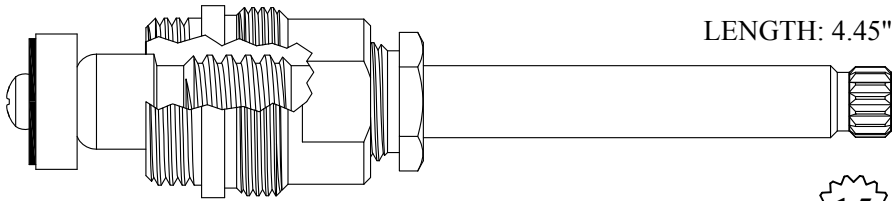

406701
206701 Stem Only
GASKET: 895400

15
1-13

LENGTH: 4.52"

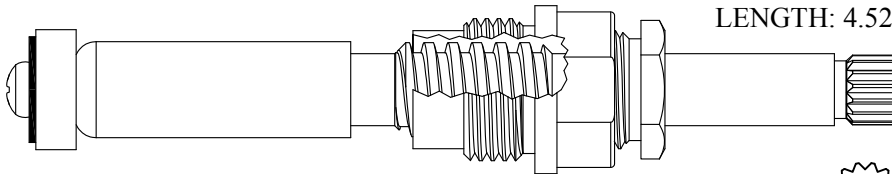

LF471301
LF471301 Stem Only
GASKET: 895100

15
1-13

Chrome Plated Stem

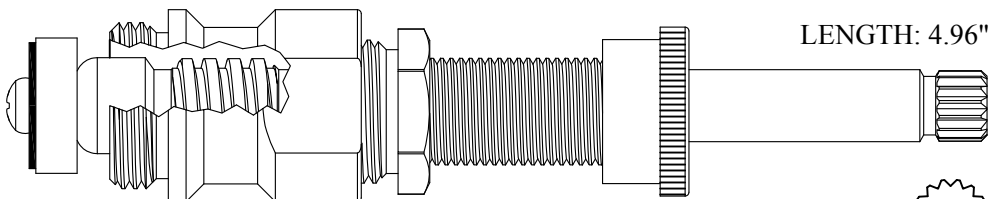

412711
212801 Stem Only
GASKET: 895400

15
1-13

Chrome Plated Stem

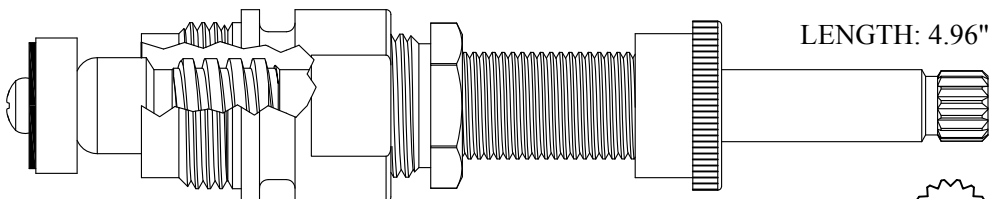

412721
212801 Stem Only
GASKET: 895400

15
1-13

FOR SAVOY

Chrome Plated Stem

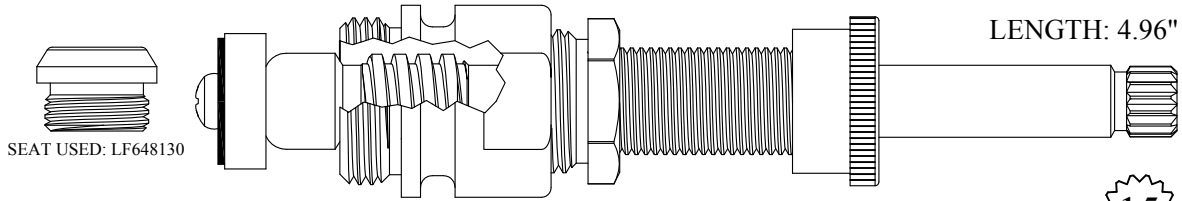

412731
212801 Stem Only
GASKET: 895400



Chrome Plated Stem & Esc Tube

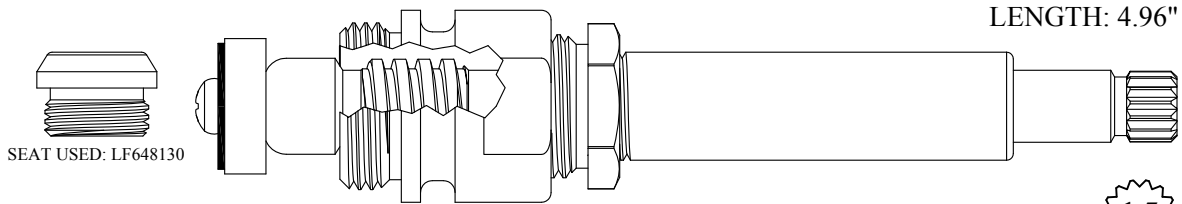

412741
212801 Stem Only
GASKET: 895400



Chrome Plated Stem & Esc Tube

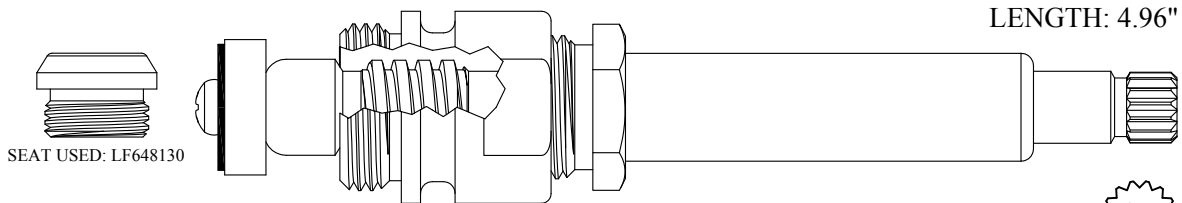

412801
212801 Stem Only
GASKET: 895400



BARRY E.  WALTER  SR. CO.

FOR SAVOY

Chrome Plated Stem & Esc Tube

LENGTH: 4.96"

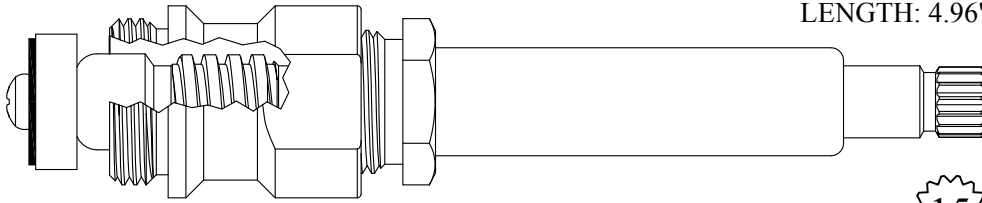

15
1-13

412821

212801 Stem Only

GASKET: 895400

Chrome Plated Stem

LENGTH: 4.96"

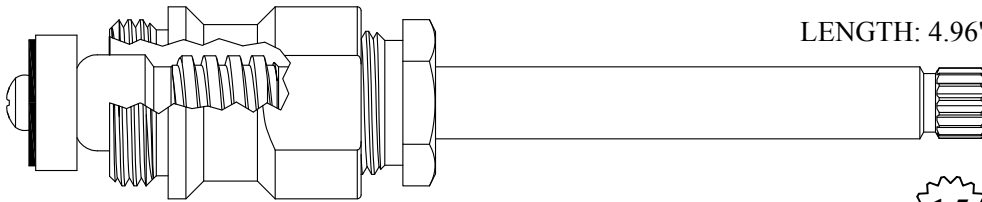

15
1-13

412821-LT

212801 Stem Only

GASKET: 895400

Chrome Plated Stem & Esc Tube

LENGTH: 4.96"

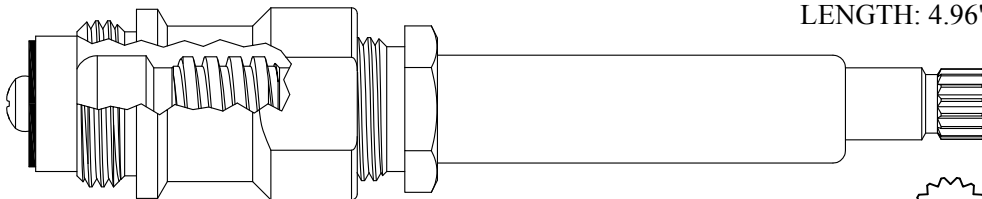

15
1-13

412831

212801 Stem Only

GASKET: 895400

Chrome Plated Stem & Esc Tube
5/8 Retainer

LENGTH: 4.96"

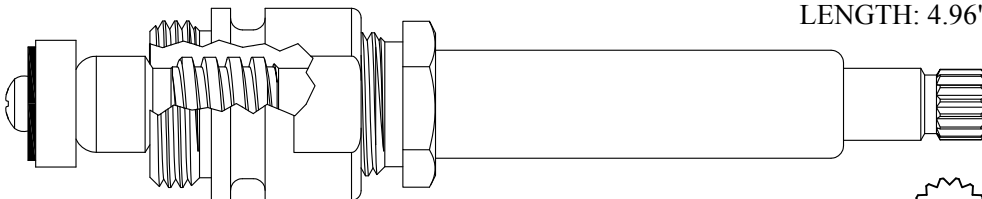

15
1-13

412841

212841 Stem Only

GASKET: 895400

FOR SAVOY

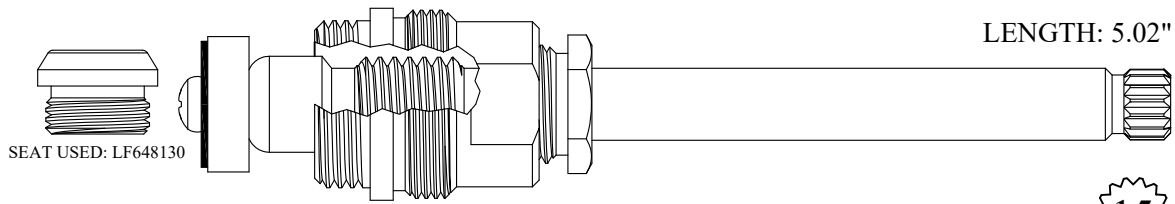

413211
213211 Stem Only
GASKET: 895400

15
1-13

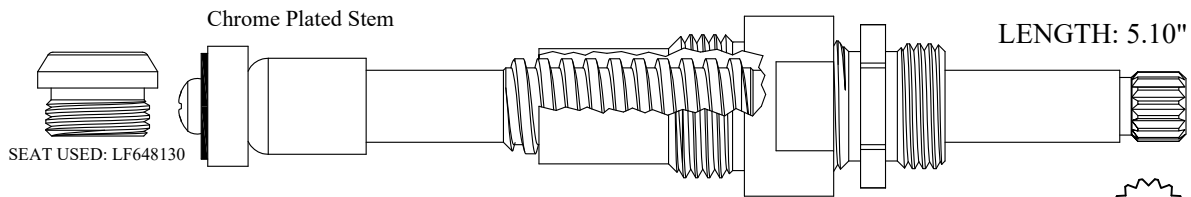

LF472021
LF272021 Stem Only
GASKET: 895100

15
1-13

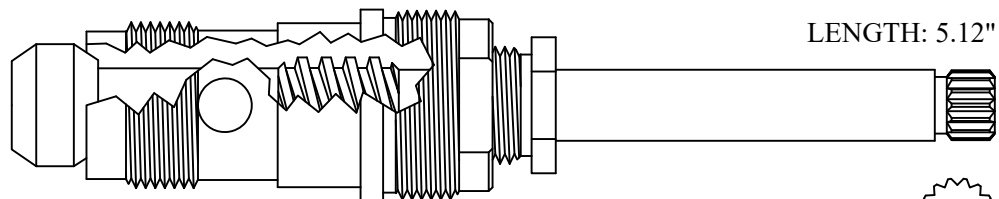

432411
232411 Stem Only
GASKET: 895400

15
1-13

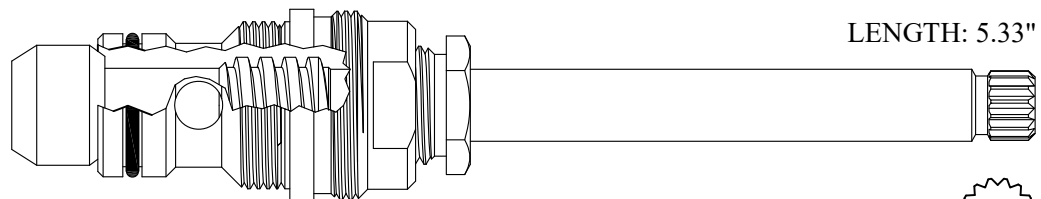

433391
233391 Stem Only
GASKET: 895400

15
1-13

FOR SAVOY

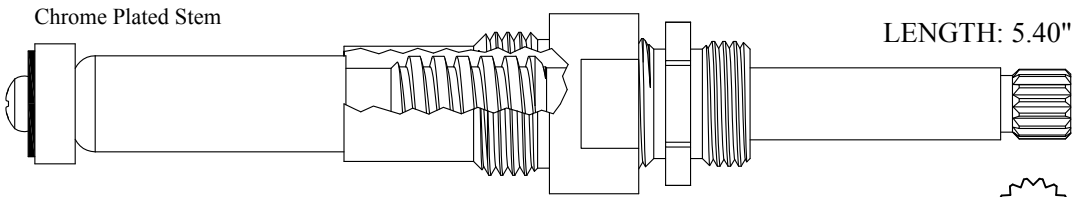

LF473011
LF273011 Stem Only
GASKET: 895100



15
1-13

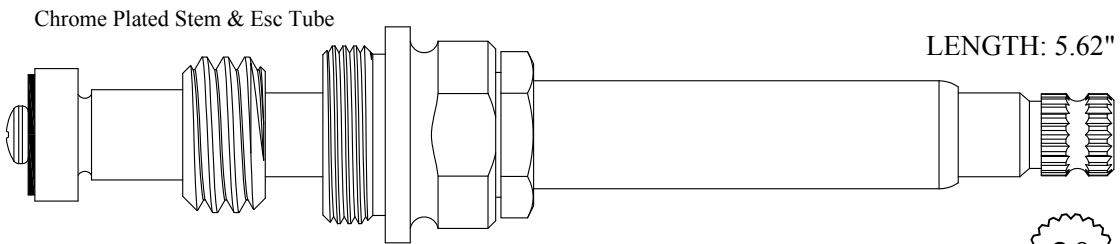

422711
222711 Stem Only
GASKET: 895320

20
2-4

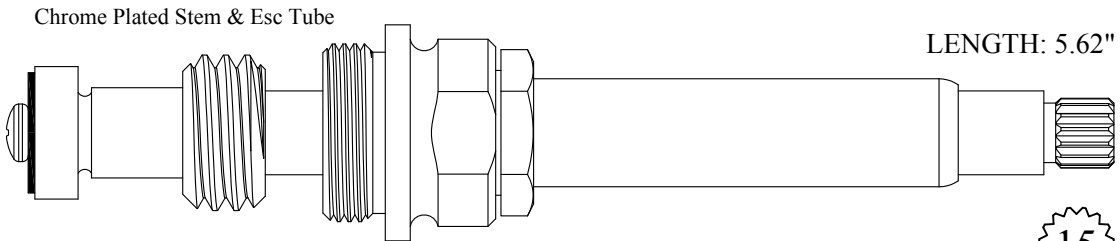

422721
222721 Stem Only
GASKET: 895320

15
1-13

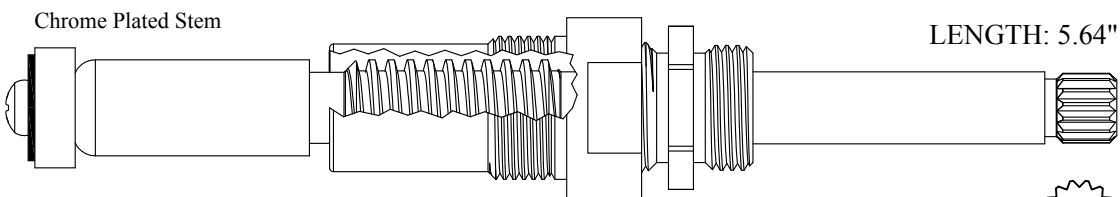

LF480351
LF280351 Stem Only
GASKET: 895100



15
1-13

FOR SAVOY

Chrome Plated Stem & Esc Tube

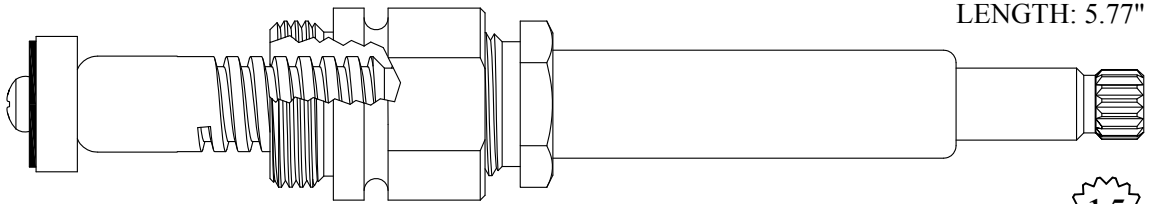

LENGTH: 5.77"

423211
223411 Stem Only
GASKET: 895400



SEAT USED: LF648130

15
1-13

Chrome Plated Stem & Esc Tube

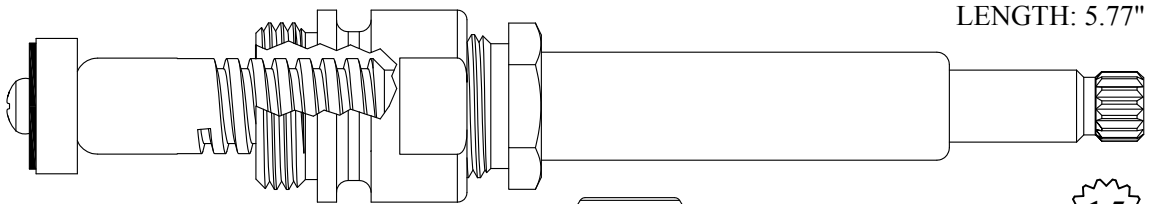

LENGTH: 5.77"

423411
223411 Stem Only
GASKET: 895400

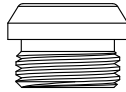

SEAT USED: LF648130

15
1-13

Chrome Plated Stem

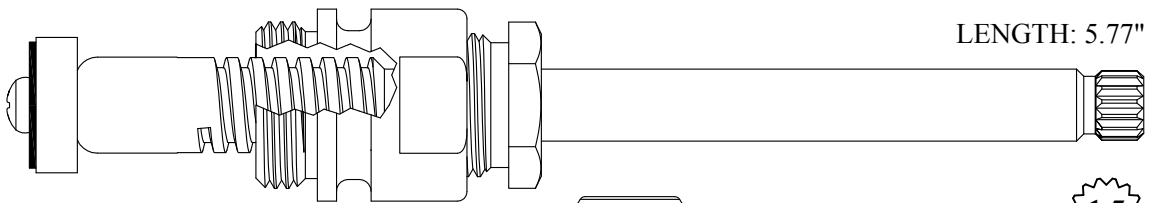

LENGTH: 5.77"

423411-LT
223411 Stem Only
GASKET: 895400

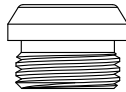

SEAT USED: LF648130

15
1-13

Chrome Plated Stem & Esc Tube

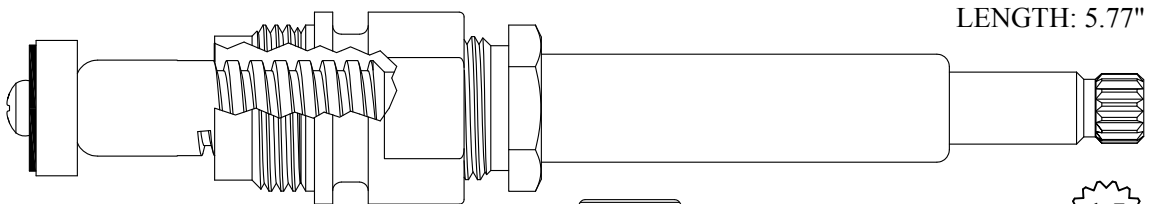

LENGTH: 5.77"

423511
223411 Stem Only
GASKET: 895400

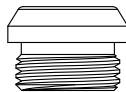

SEAT USED: LF648130

15
1-13

FOR SAVOY

Chrome Plated Stem & Esc Holder

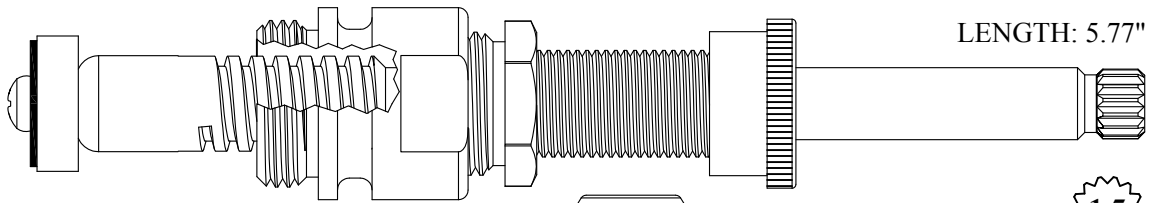

LENGTH: 5.77"

423521
223411 Stem Only
GASKET: 895400



SEAT USED: LF648130

15
1-13

Chrome Plated Stem & Esc Tube

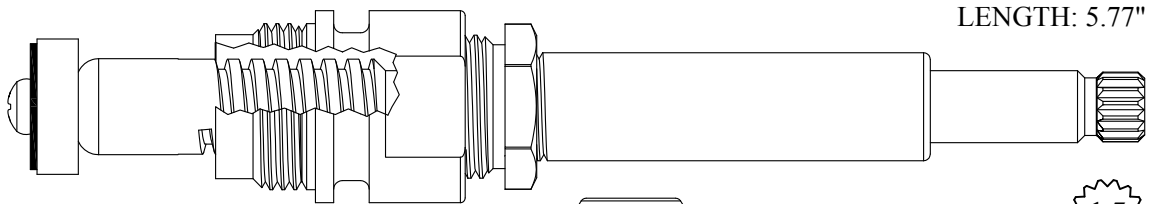

LENGTH: 5.77"

423541
223411 Stem Only
GASKET: 895400



SEAT USED: LF648130

15
1-13

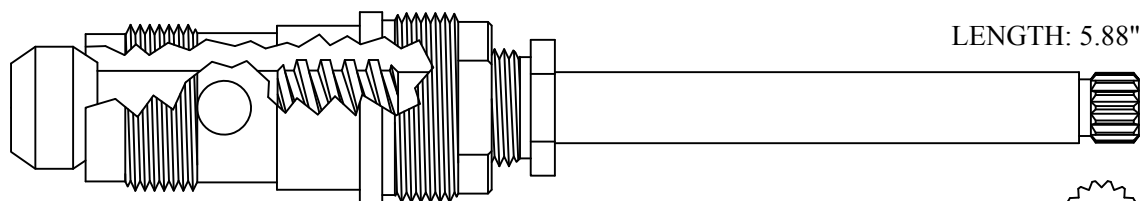

LENGTH: 5.88"

438921
238921 Stem Only
GASKET: 895400

15
1-13

Chrome Plated Stem & Esc Tube

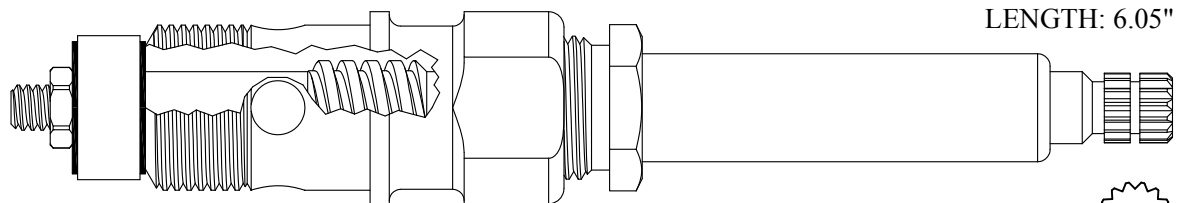

LENGTH: 6.05"

438931
238931 Stem Only
GASKET: 895400

7/8-16 Thread

15
1-13

FOR SAVOY

Chrome Plated Stem & Esc Tube

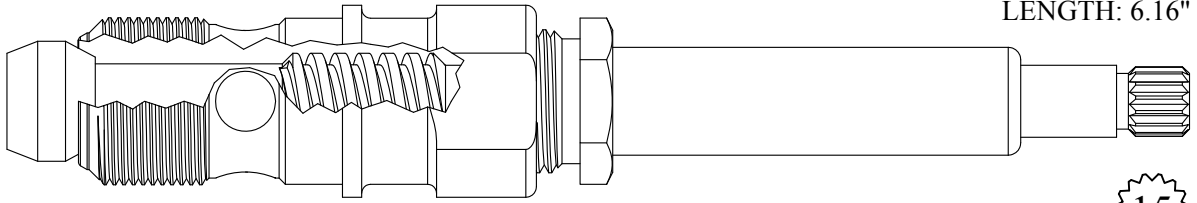

LENGTH: 6.16"

438911
238911 Stem Only
GASKET: 895400



Chrome Plated Stem & Esc Tube

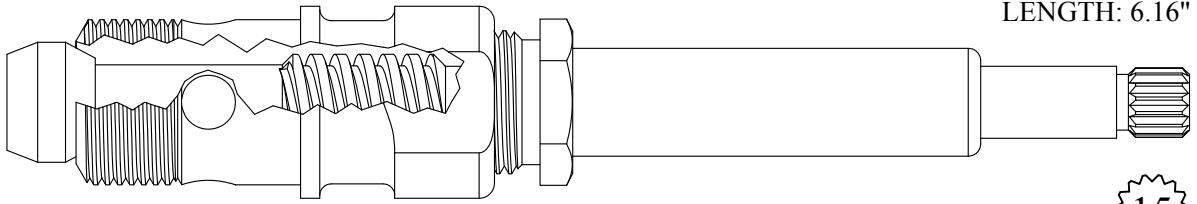

LENGTH: 6.16"

7/8-16 Thread

438941
238911 Stem Only
GASKET: 895400

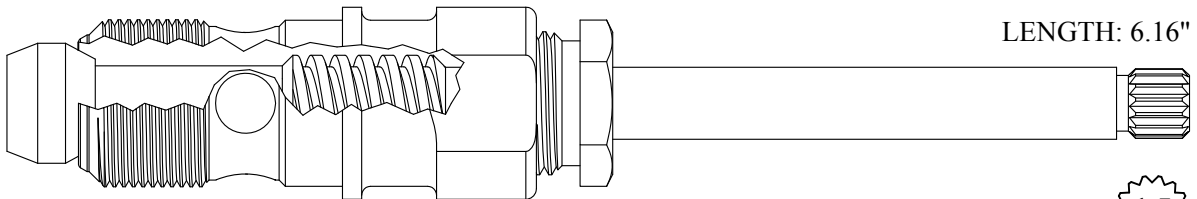

LENGTH: 6.16"

438951
238951 Stem Only
GASKET: 895400

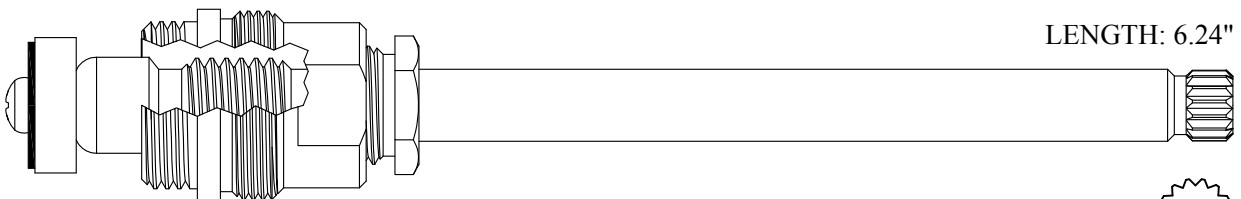

LENGTH: 6.24"

426741
226741 Stem Only
GASKET: 895400

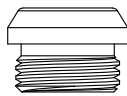

SEAT USED: LF648130



FOR SAVOY

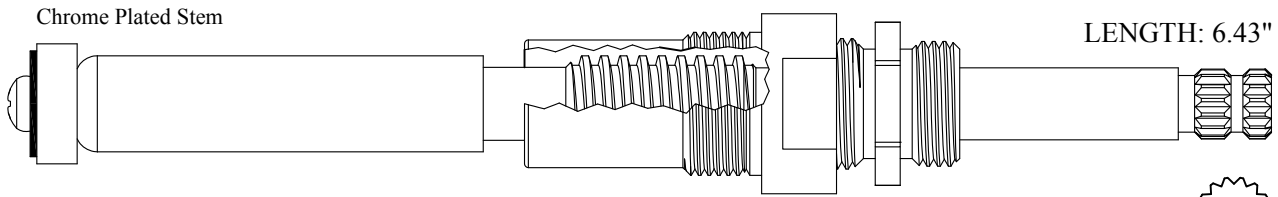

Chrome Plated Stem

LENGTH: 6.43"

LF480561
LF280561 Stem Only
GASKET: 895100



15
1-13

Chrome Plated Stem & Esc Tube

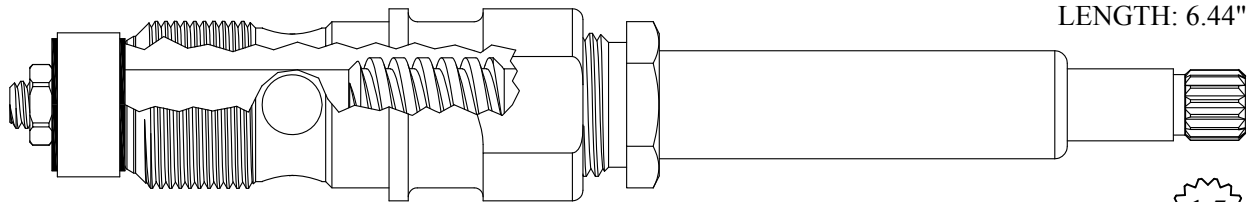

LENGTH: 6.44"

7/8-20 Thread

438901
238901 Stem Only
GASKET: 895400

15
1-13

Chrome Plated Stem & Esc Tube

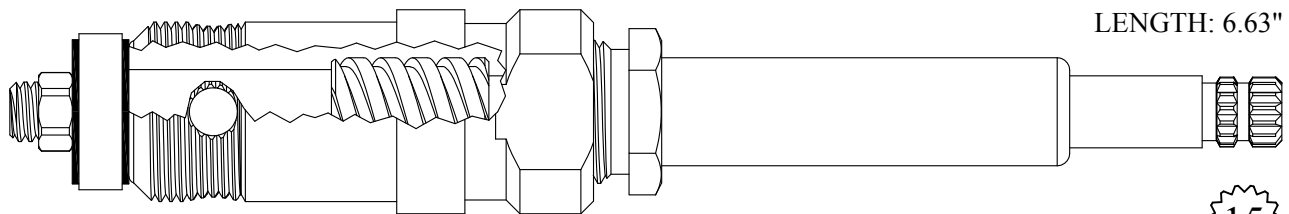

LENGTH: 6.63"

15/16-18 Thread

439121
239121 Stem Only
GASKET: 895320

15
1-13

Chrome Plated Stem & Esc Tube

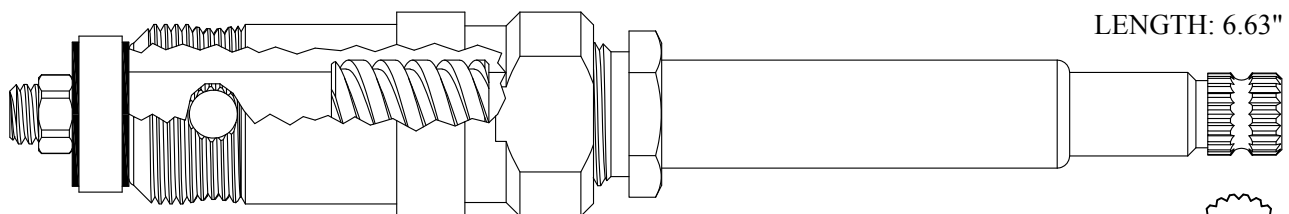

LENGTH: 6.63"

439131
239131 Stem Only
GASKET: 895320

20
2-4

FOR SAVOY

LENGTH: 7.02"

15
1-13

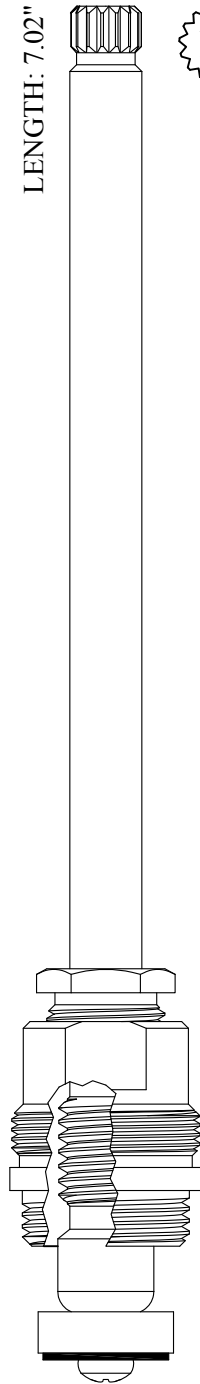

GASKET: 895400

427081



SEAT USED: LF648130

Send Your Orders To:

BARRY E.  SR. CO.

E-mail: orderdesk@barrywalter.com

Fax: 1.800.886.9831

Phone: 1.800.767.5552



Quality Replacement Parts

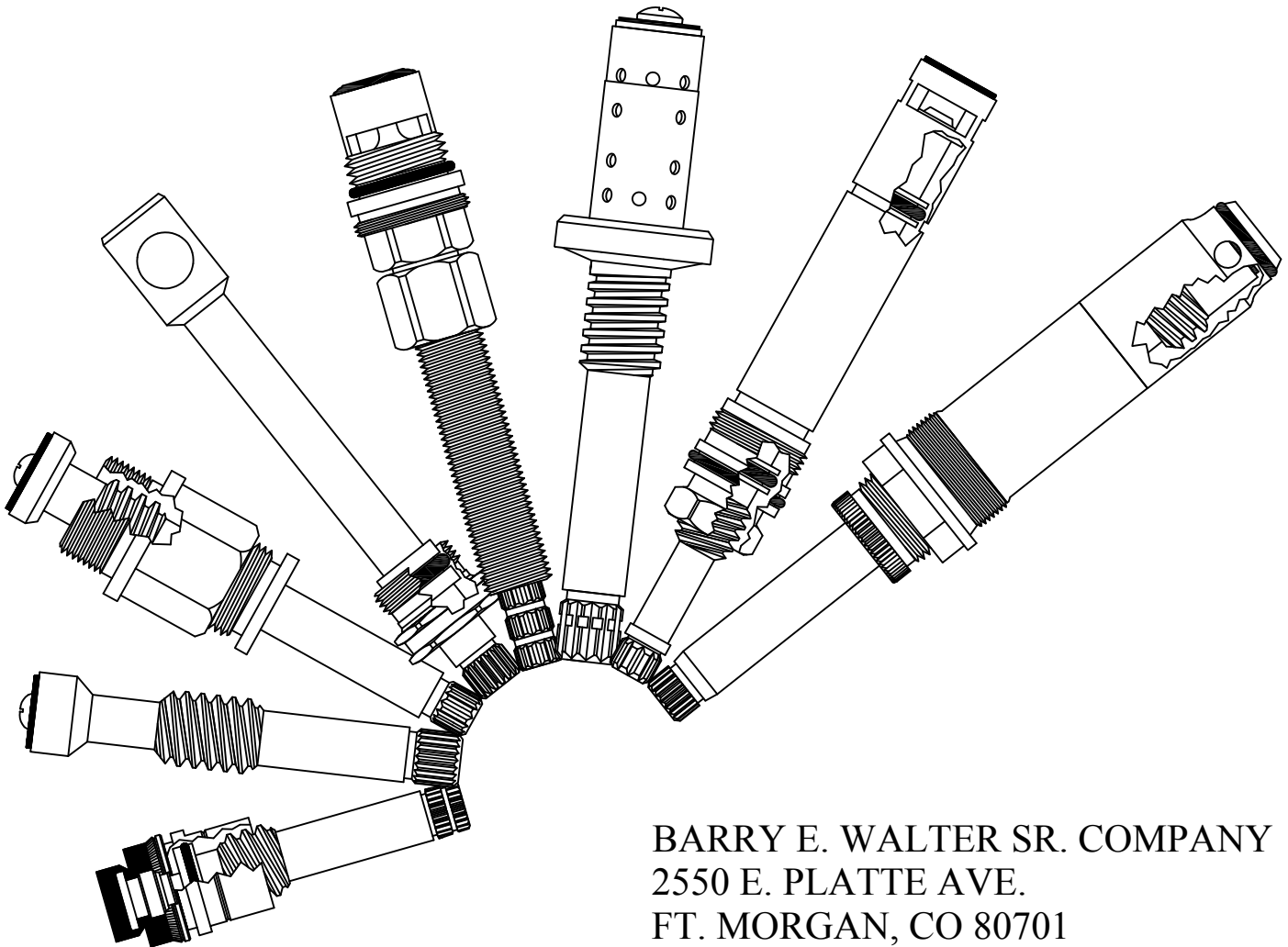

BARRY E. WALTER SR. COMPANY
2550 E. PLATTE AVE.
FT. MORGAN, CO 80701

*We are always adding new parts.
Check our website for updates.*

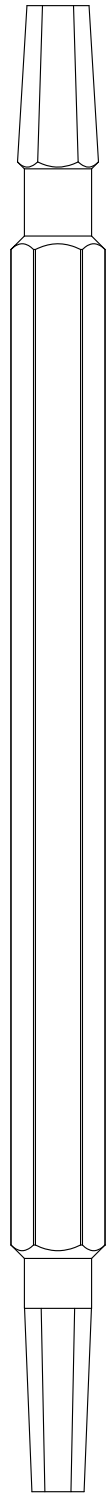

Hex Wrench

121580

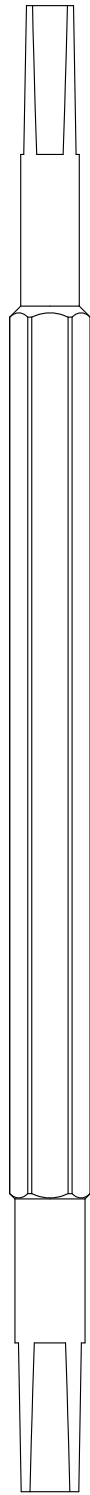

Small Square Wrench

121510

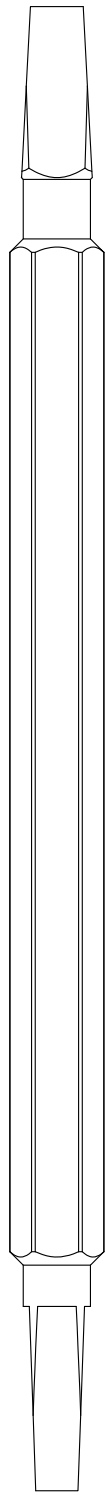

Large Square Wrench

121440

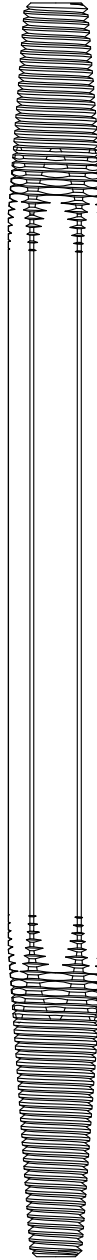

Easy-Out Wrench

134790

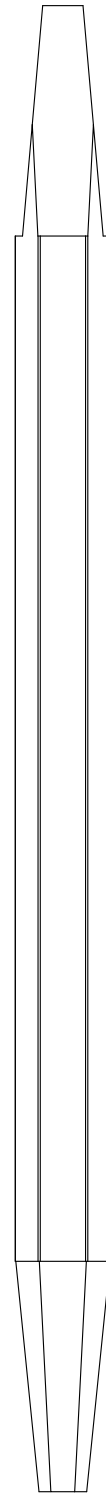

Squex Wrench

121650

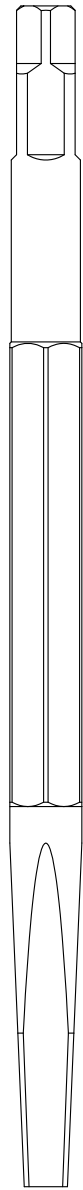

Mobile Home Wrench

192790

FOR SAYCO

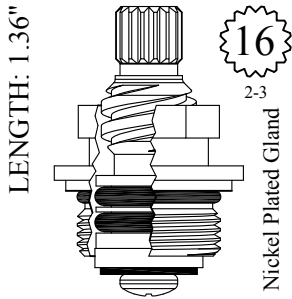

GASKET: 890160 O-RING INCLUDED

LF450091
LF450092

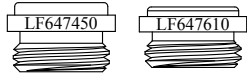

SEAT USED: LF647450 or LF647610

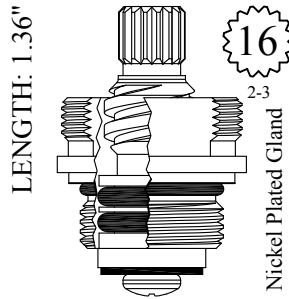

GASKET: 890160 O-RING INCLUDED

LF451271
LF451272

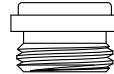

SEAT USED: LF647450

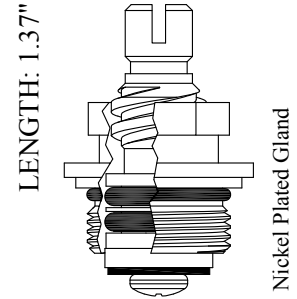

GASKET: 890160 O-RING INCLUDED

400271

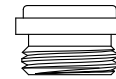

SEAT USED: LF647450

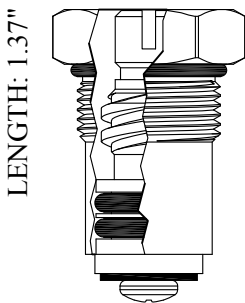

GASKET: 890170 O-RING INCLUDED

400281

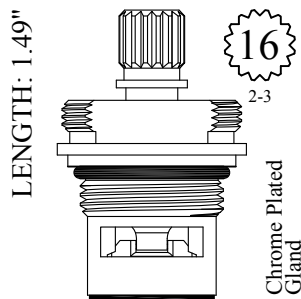

GASKET: 890170 O-RING INCLUDED
SEAL: 898540
DISC SET: 112530-PKG

LF451231
LF451232

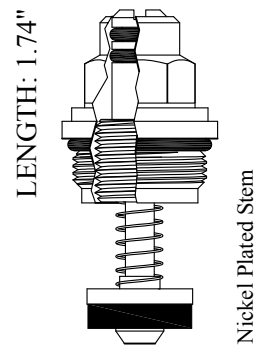

GASKET: 890160 O-RING INCLUDED

400121

FOR SAYCO

LENGTH: 1.87"

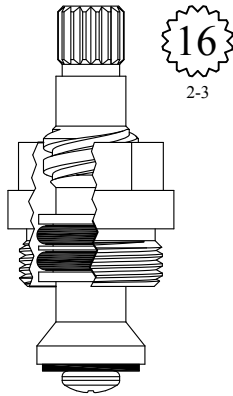

GASKET: 895100

LF456081
LF456082



SEAT USED: LF647450

LENGTH: 1.96"

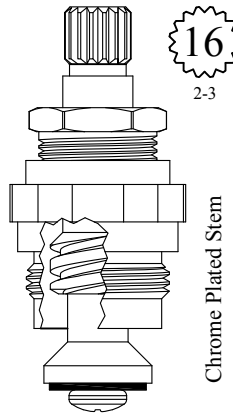

GASKET: 895100

LF458061
LF458062
LF258061 Stem Only
LF258062 Stem Only

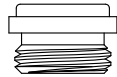

SEAT USED: LF647450

LENGTH: 1.96"

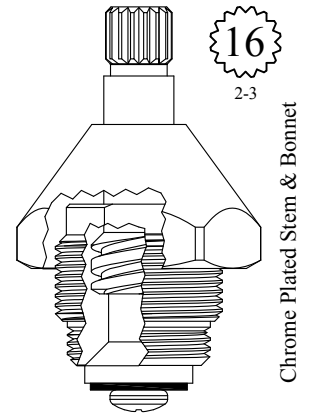

GASKET: 895100

LF459081
LF459082
LF258061 Stem Only
LF258062 Stem Only

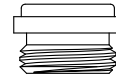

SEAT USED: LF647450

LENGTH: 2.05"

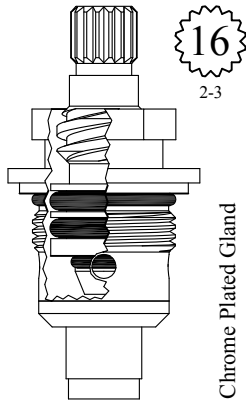

GASKET: 890160 O-RING INCLUDED
SEAT INCLUDED: 652360

LF452361
LF452362

LENGTH: 2.15"

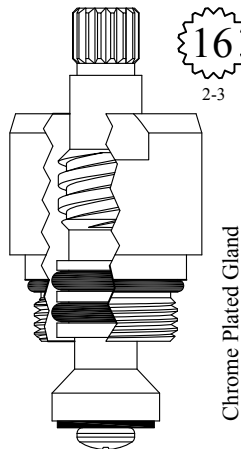

GASKET: 890170 O-RING INCLUDED

LF459111
LF459112



SEAT USED: LF647450

LENGTH: 2.17"

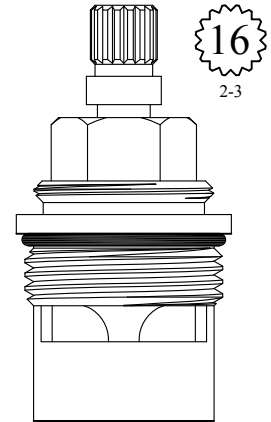

GASKET: 890210 O-RING INCLUDED
SEAL: 898610-R/B
DISC SET: 109850-PKG

401051
401052

FOR SAYCO

LENGTH: 2.29"

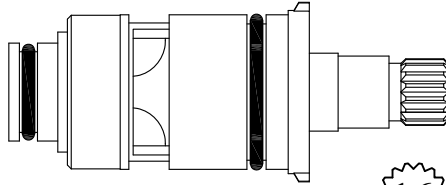

16
2-3

LF459611/ LF459612

DISC SET: 151380-PKG

Chrome Plated Stem

LENGTH: 2.79"

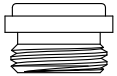

SEAT USED: LF647450

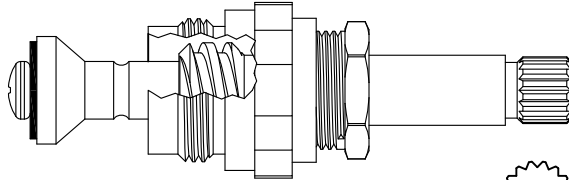

16
2-3

LF466091/ LF466092

LF266091/ LF266092 Stem Only

GASKET: 895100

Chrome Plated Stem & Bonnet

LENGTH: 2.79"

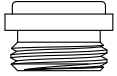

SEAT USED: LF647450

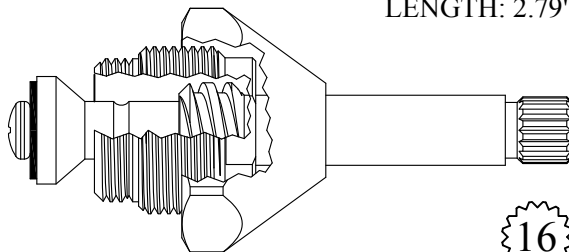

16
2-3

LF466191/ LF466192

LF266091/ LF266092 Stem Only

GASKET: 895100

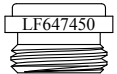
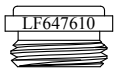

SEAT USED: LF647450
or LF647610

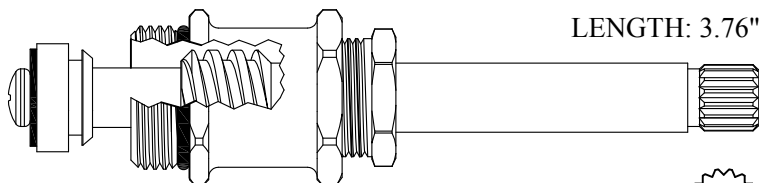

LENGTH: 3.76"

16
2-3

403031

203031 Stem Only

GASKET: 890160 O-RING INCLUDED



SEAT USED: LF647450

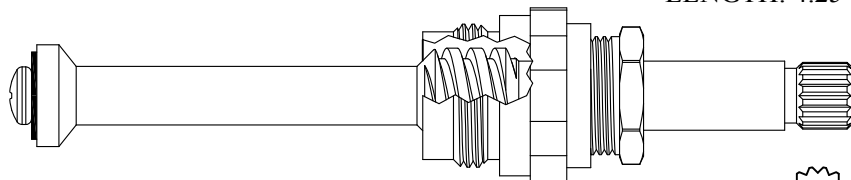

LENGTH: 4.25"

16
2-3

LF470951/ LF470952

LF270951/ LF270952 Stem Only

GASKET: 895100

FOR SAYCO

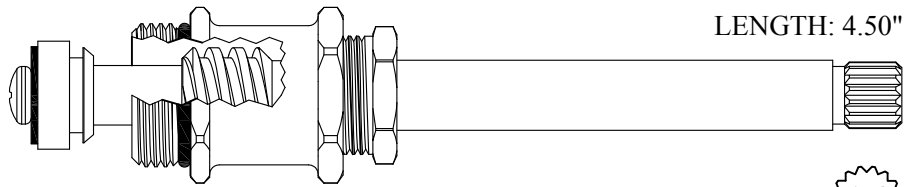
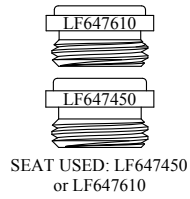

407201/ 407202
207201/ 207202 Stem Only
GASKET: 890160 O-RING INCLUDED

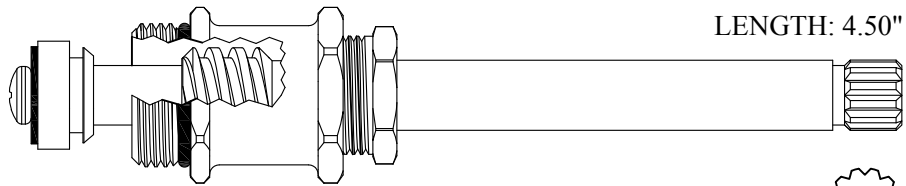
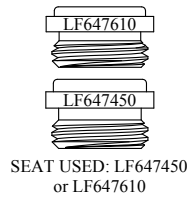

407251/ 407252
207251/ 207252 Stem Only
GASKET: 890160 O-RING INCLUDED

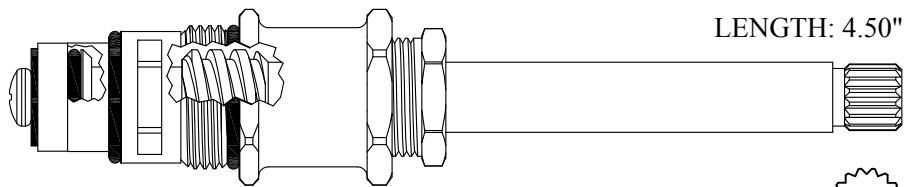
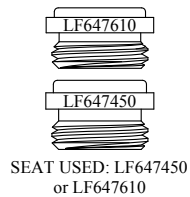

430701
230701 Stem Only (Includes Cage)
GASKET: 890160 O-RING INCLUDED

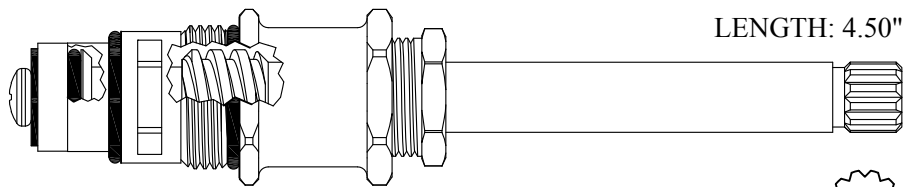
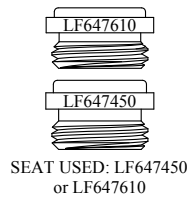

430751
207251 Stem Only
GASKET: 890160 O-RING INCLUDED



FOR SAYCO

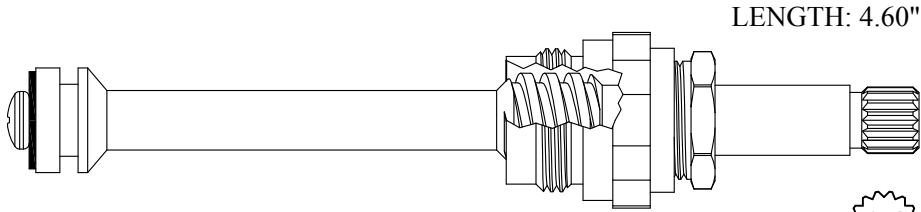

LF474051/ LF474052
LF274051/ LF274052 Stem Only
GASKET: 895100

16
2-3

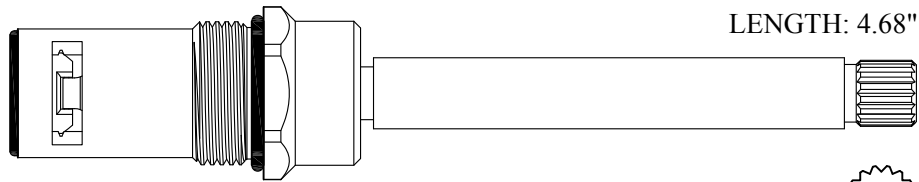

408611/ 408612
GASKET: 890170 O-RING INCLUDED
SEAL: 898510
DISC SET: 151380-PKG

16
2-3

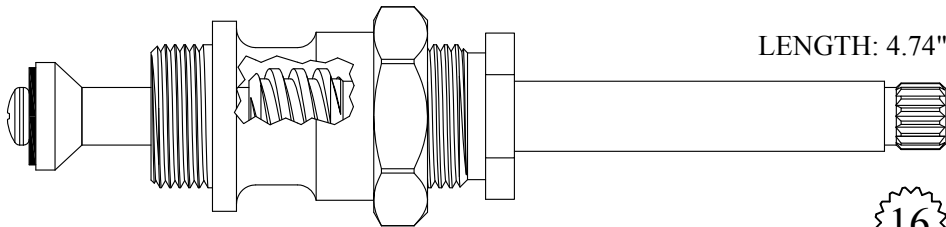

409601
209601 Stem Only
GASKET: 895100

16
2-3

Chrome Plated Stem

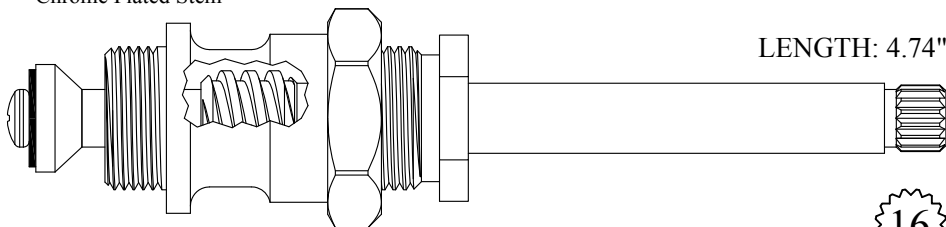

409611
209611 Stem Only
GASKET: 895100

16
2-3

FOR SAYCO

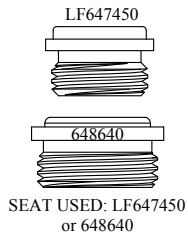

Chrome Plated Stem

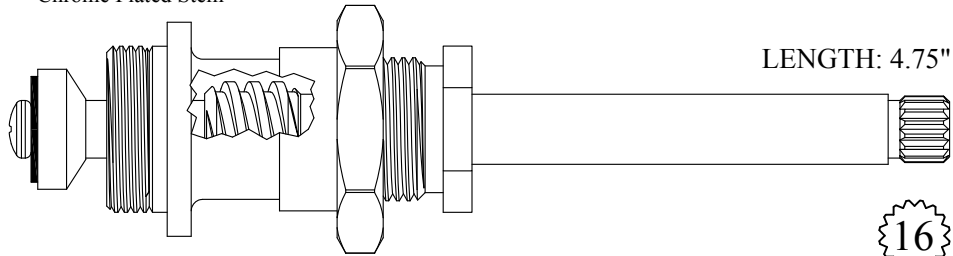

16
2-3

409801
209801 Stem Only
GASKET: 895400



Chrome Plated Stem

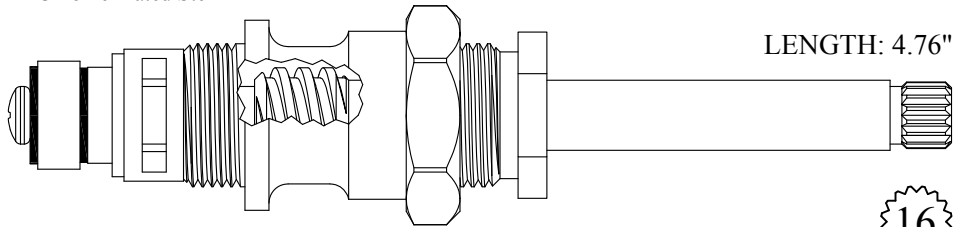

16
2-3

431341
231341 Stem Only
GASKET: 895100

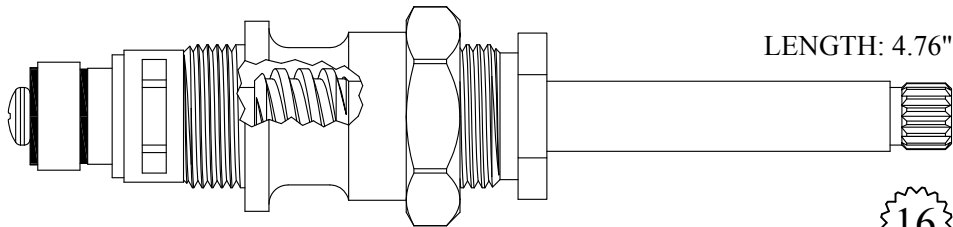

16
2-3

431201
231201 Stem Only
GASKET: 895100



Chrome Plated Esc Tube

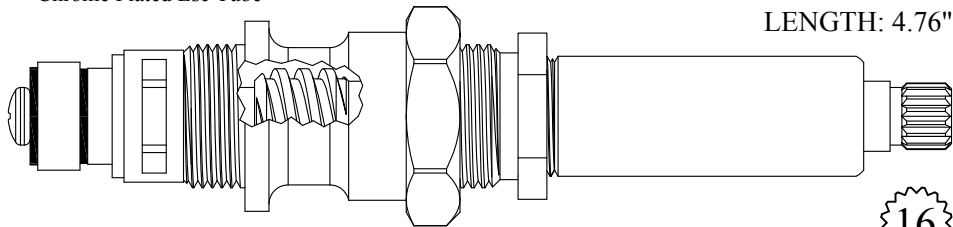

16
2-3

431221
231201 Stem Only
GASKET: 895100

FOR SAYCO

Chrome Plated Stem

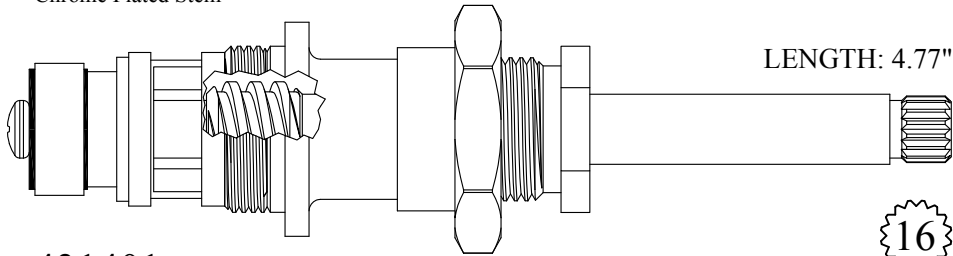
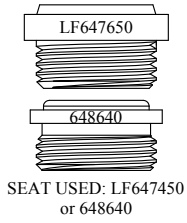

431401

231401 Stem Only

GASKET: 895400

Stem also available less cage

231401-1

16
2-3

Chrome Plated Stem

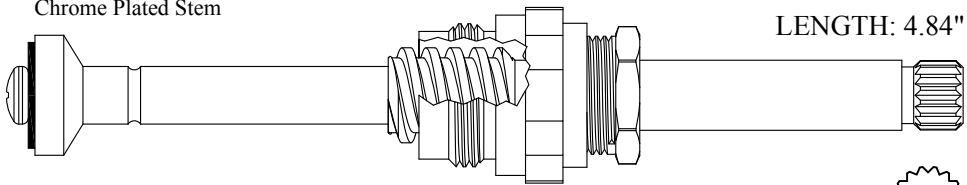

LF476051/ LF476052

LF276051/ LF276052 Stem Only

GASKET: 895100

16
2-3

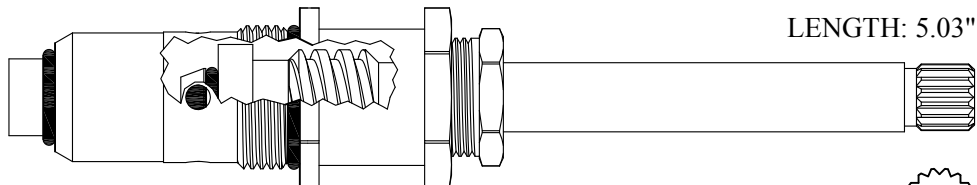

409911/ 409912

GASKET: 890160 O-RING INCLUDED
SEAT INCLUDED: 609910

16
2-3

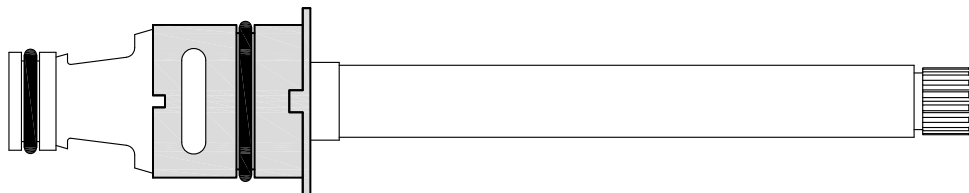

Not Available, Use 414421 / 414422

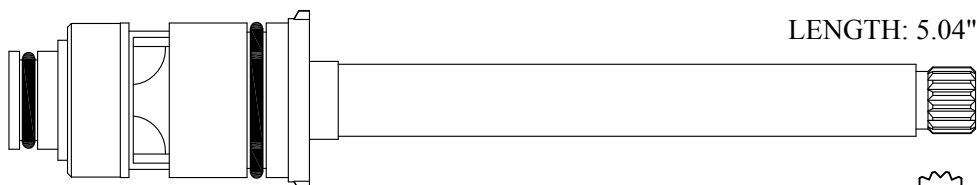

414421/ 414422

DISC SET: 151380-PKG

16
2-3

FOR SCOVILLE

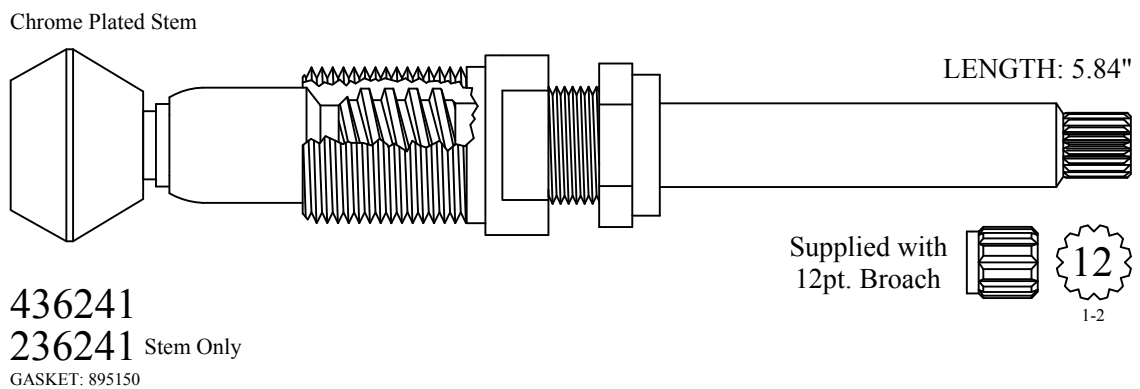
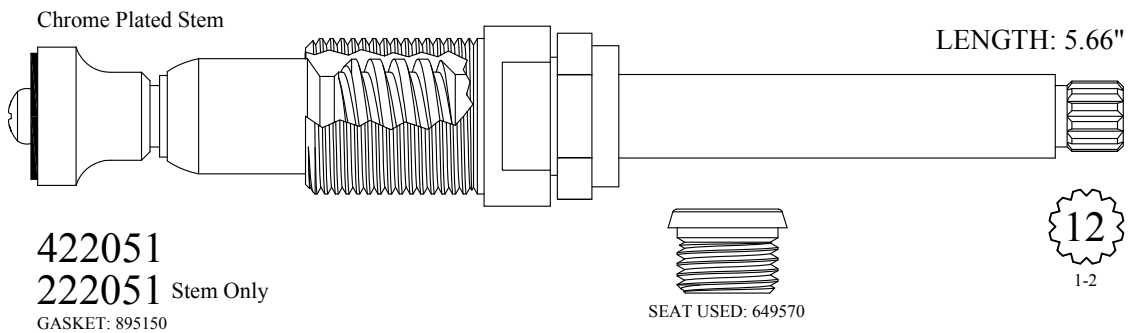
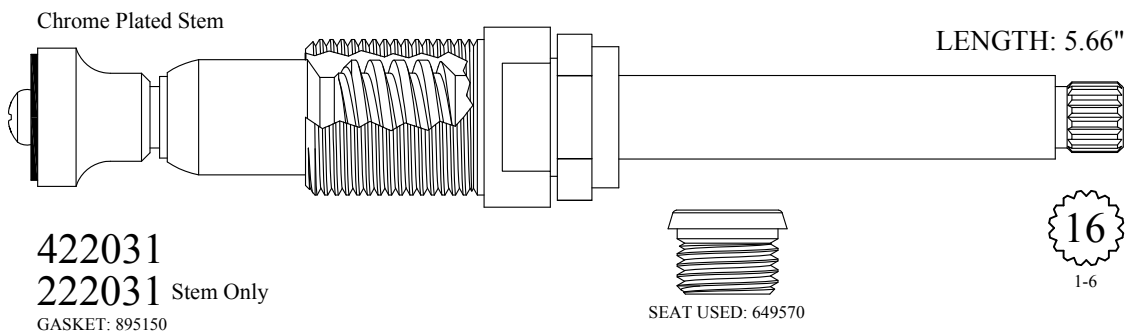
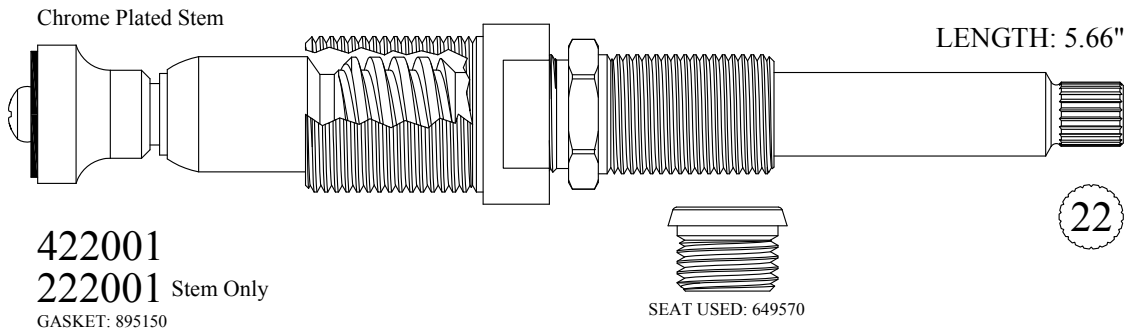

FOR SEARS - U/R - ELKAY

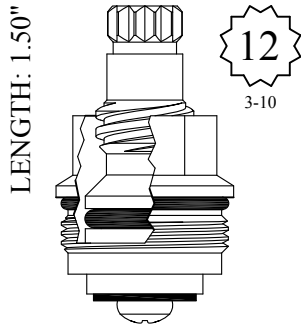

GASKET: 890180 O-RING INCLUDED

LF451091
LF451092

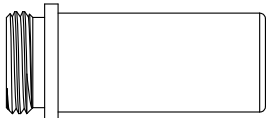

SEAT USED: LF648900

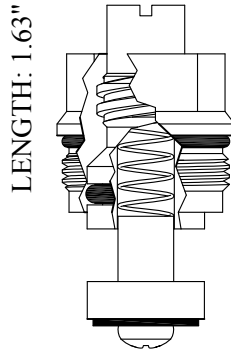

GASKET: 890180 O-RING INCLUDED

400261

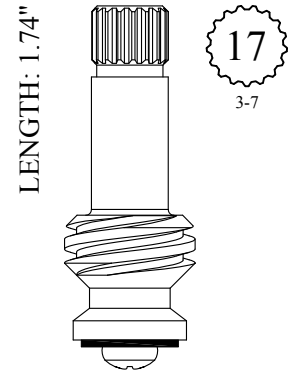

LF254141
LF254142

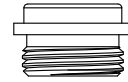

SEAT USED: LF648700

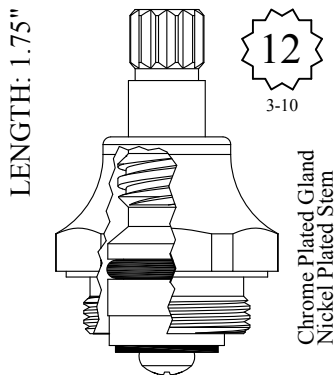

GASKET: 895150

LF454171
LF454172



SEAT USED: LF648700

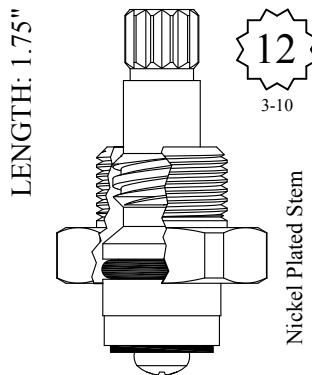

LF454221
LF454222



SEAT USED: LF648700

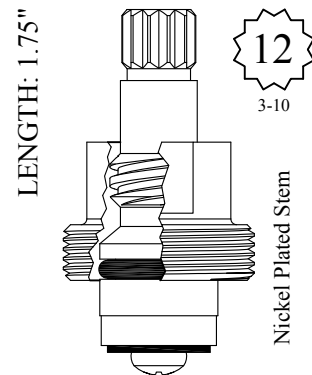

LF454231
LF454232



SEAT USED: LF648700

FOR SEARS - U/R - ELKAY

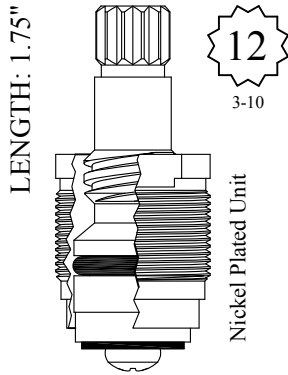

GASKET: 894670

LF455021
LF455022



SEAT USED: LF648700

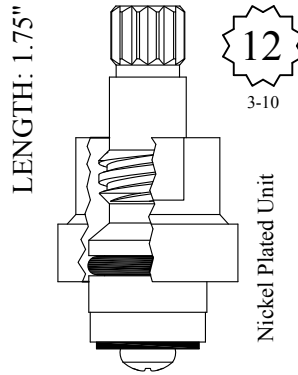

LF455041
LF455042

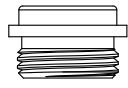

SEAT USED: LF648700

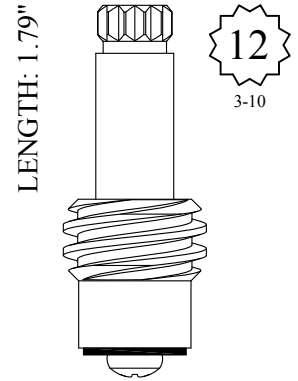

LF255101
LF255102

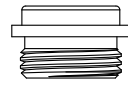

SEAT USED: LF648700

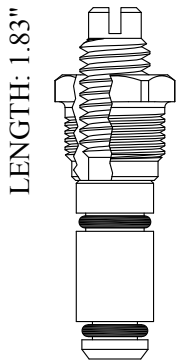

400361

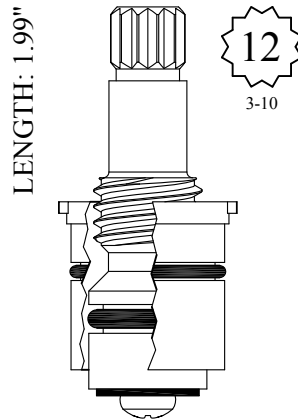

LF458131
LF458132

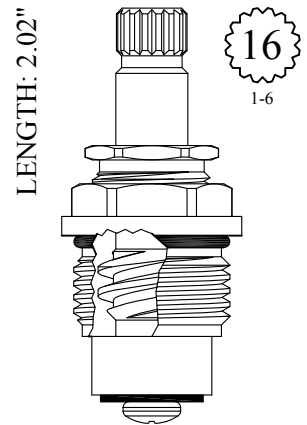

LF458281
LF458282

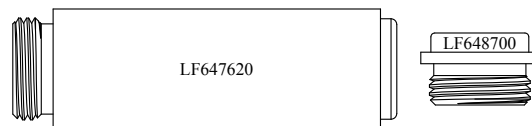

SEAT USED: LF647620 or LF648700

FOR SEARS - U/R - ELKAY

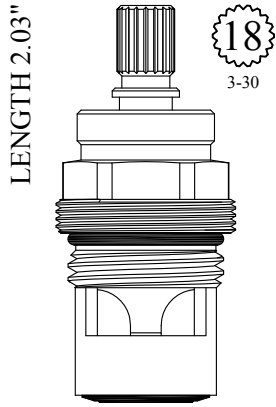

GASKET: 890170 O-RING INCLUDED
SEAL: 898510
DISC SET: 151380-PKG

LF459171
LF459172

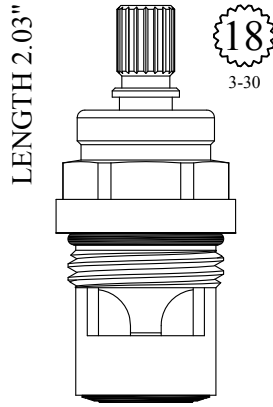

GASKET: 890170 O-RING INCLUDED
SEAL: 898510
DISC SET: 151380-PKG

LF459181
LF459182

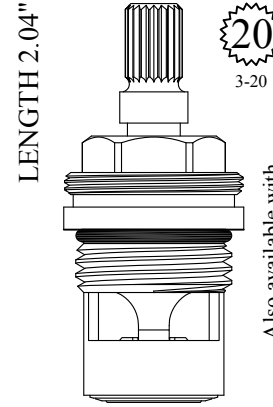

GASKET: 890170 O-RING INCLUDED
SEAL: 898510-W
DISC SET: 151380-PKG

LF459201
LF459202

Also available with
nickel plated gland

LF459201-NP / LF459202-NP

Also available with cap nut
LF461171-N / LF461172-N

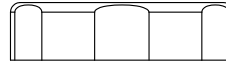

Replaces Midcor
Cartridge

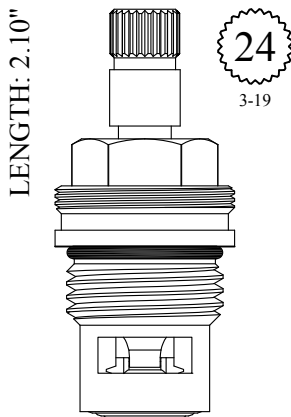

GASKET: 890170 O-RING INCLUDED
SEAL: 898500
DISC SET: 112530-PKG

LF459581
LF459582

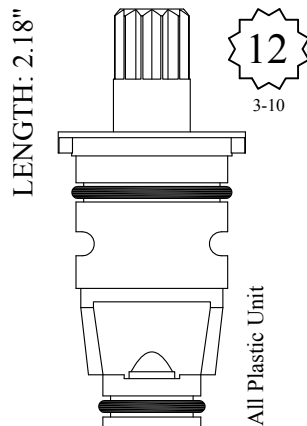

459461 Red
459462 Blue

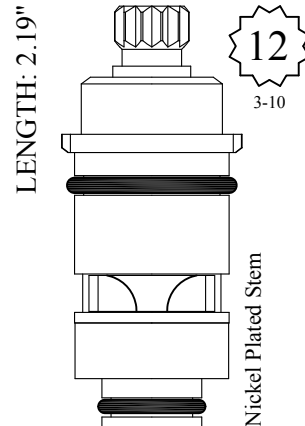

DISC SET: 151380-PKG

LF461171
LF461172

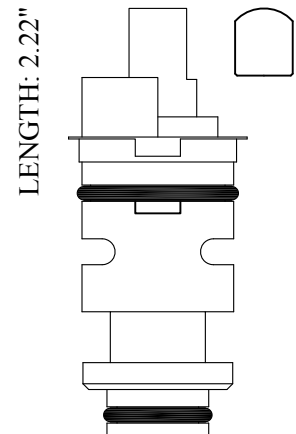

459621 Red
459622 Blue

FOR SEARS - U/R - ELKAY

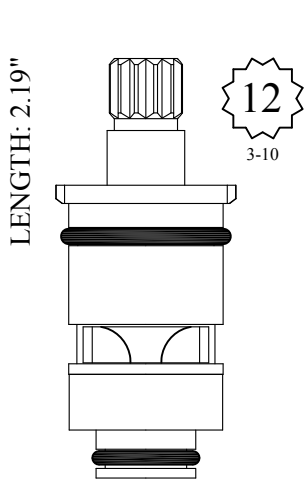

DISC SET: 151380-PKG

LF461071
LF461072

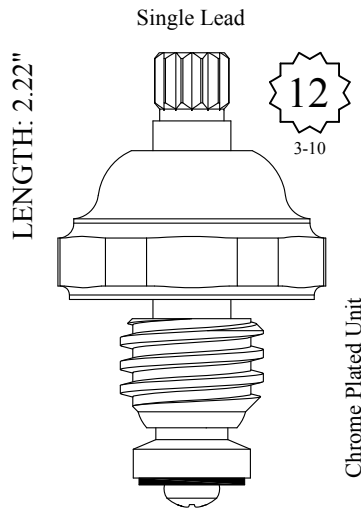

LF463021
LF263021 Stem Only

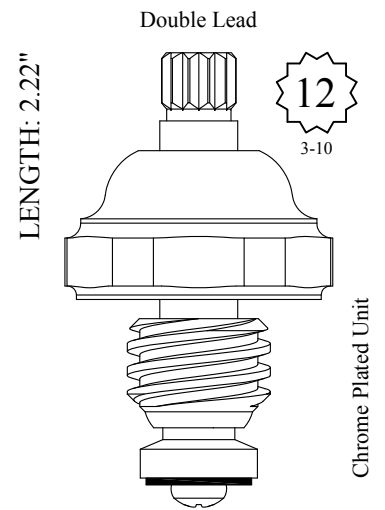

LF463031
LF463032
LF263031 Stem Only
LF263032 Stem Only

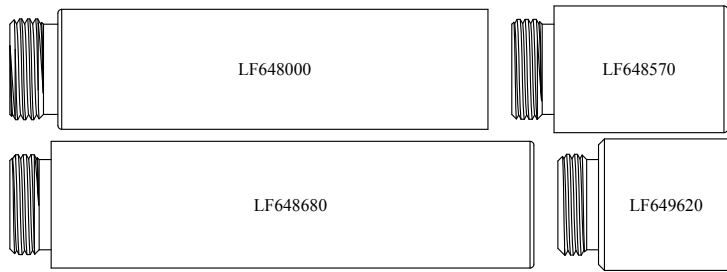
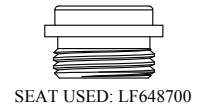

SEATS USED: LF648000, LF648570, LF648680 & LF649620

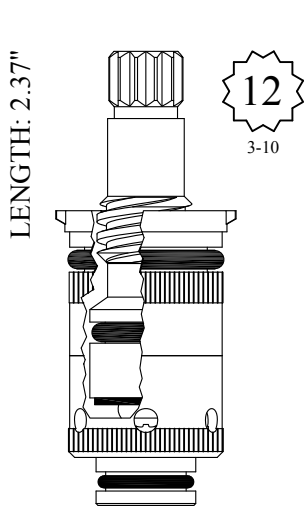

LF461081
LF461082

Also available less seat
LF461081-LS/ LF461082-LS

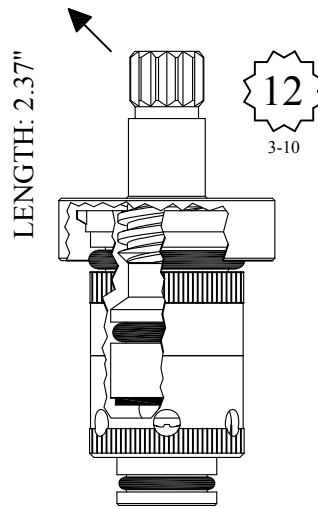

LF461181
LF461182

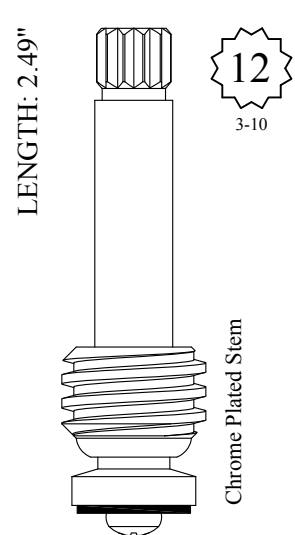

201431
SEAT USED: LF648700

FOR SEARS - U/R - ELKAY

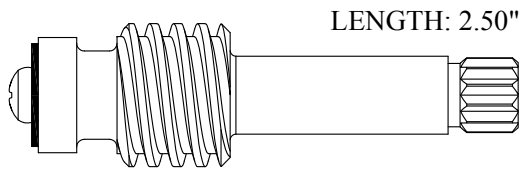
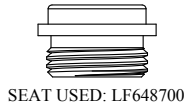

LF264111/ LF264112

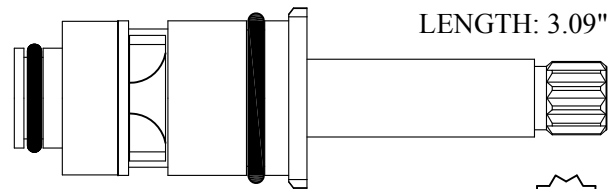
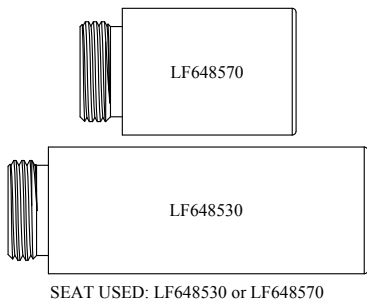

LF467031/ LF467032

DISC SET: 151380-PKG

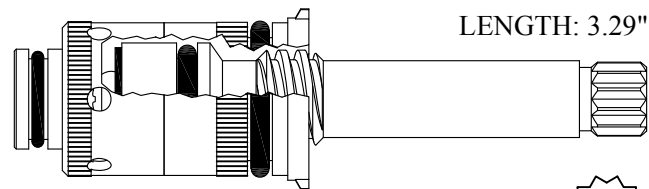
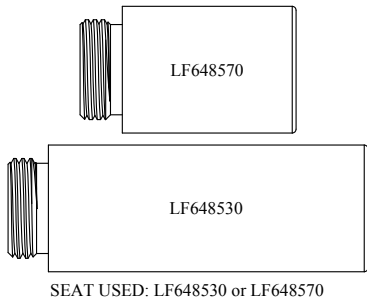

LF467041/ LF467042

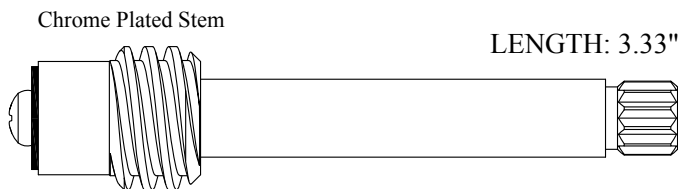
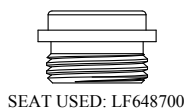

LF268011/ LF268012



FOR SEARS - U/R - ELKAY

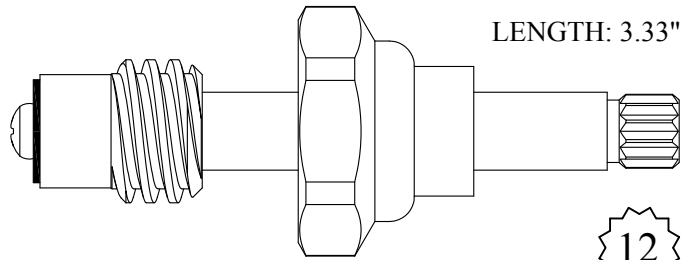

LENGTH: 3.33"

402701/ 402702
202701/ 202702 Stem Only



3-10

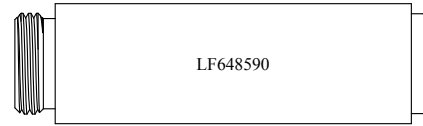
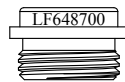

SEAT USED: LF648700 or LF648590

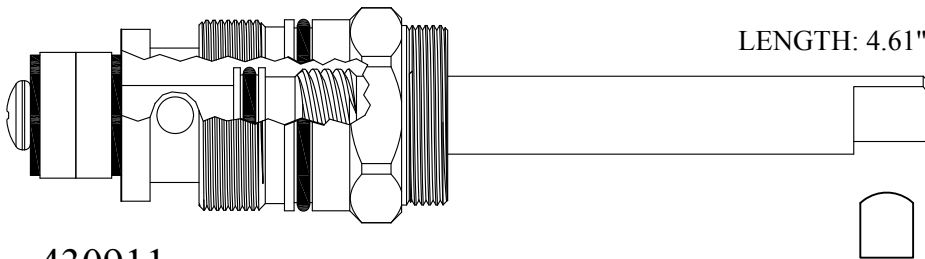

LENGTH: 4.61"

430911
230961 Stem Only

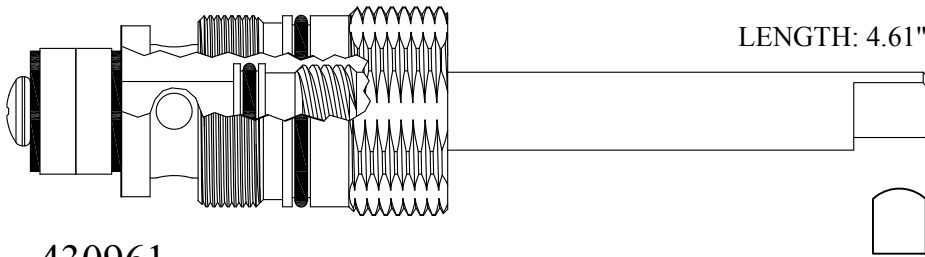

LENGTH: 4.61"

430961
230961 Stem Only

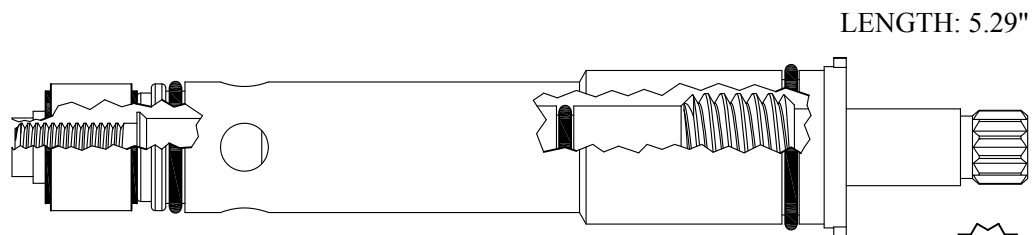

LENGTH: 5.29"

432901
232901 Stem Only



3-10

FOR SEARS - U/R - ELKAY

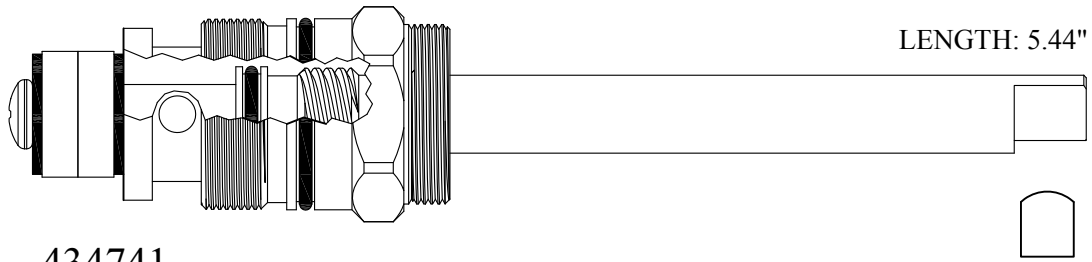

434741
GASKET: 890200

LENGTH: 5.44"

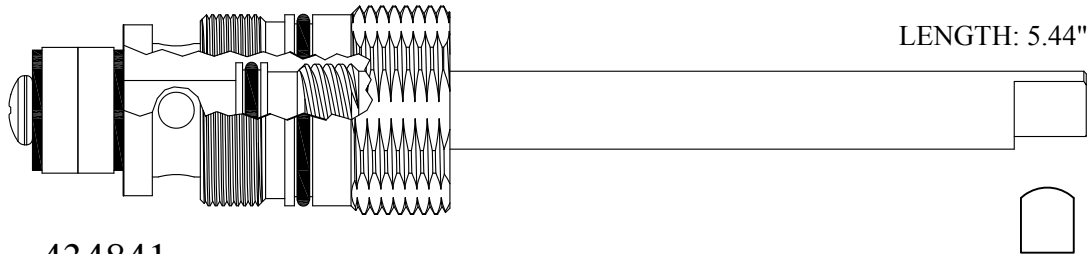

434841
GASKET: 890200

LENGTH: 5.44"

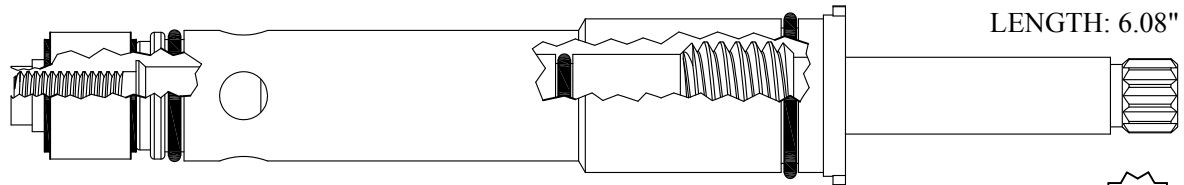

437011

LENGTH: 6.08"

12
3-10

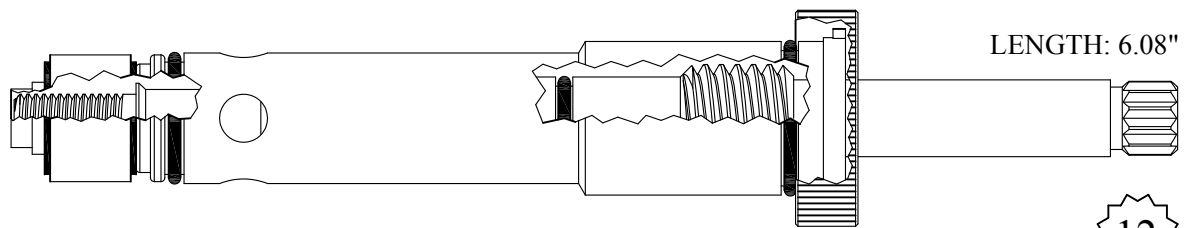

437021

LENGTH: 6.08"

12
3-10

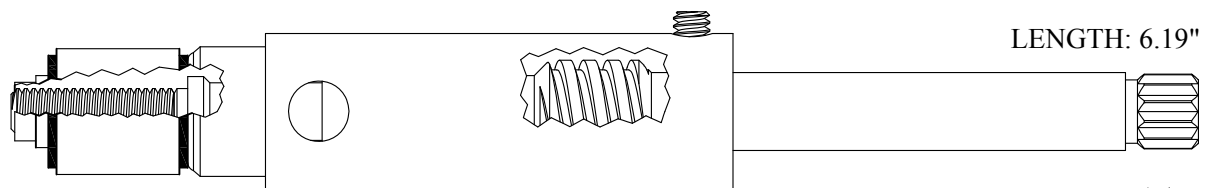

438411

LENGTH: 6.19"

12
3-10

FOR SEACREST

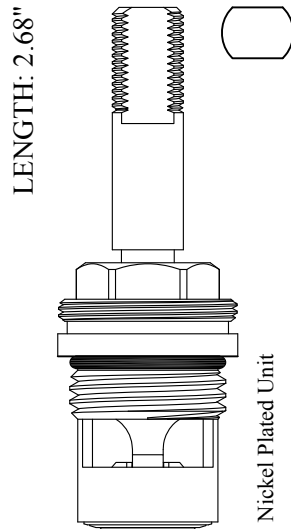

GASKET: 890170 O-RING INCLUDED
 SEAL: 898510-W
 DISC SET: 151380-PKG

LF464611
 LF464612

FOR SEPCO

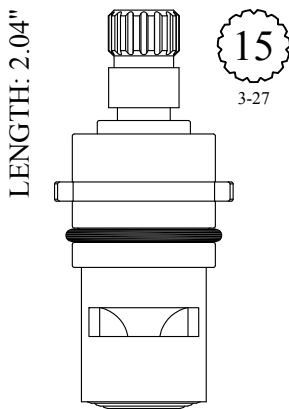

SEAL: 898500
 DISC SET: 112530-PKG

LF458841
 LF458842

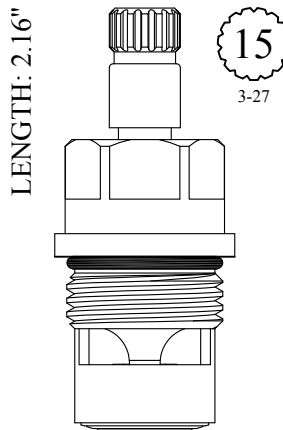

GASKET: 890170 O-RING INCLUDED
 SEAL: 898510-W
 DISC SET: 151380-PKG

LF462451
 LF462452

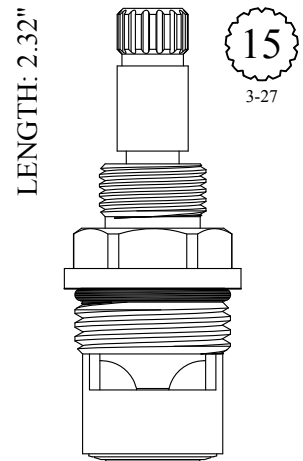

GASKET: 890170 O-RING INCLUDED
 SEAL: 898510-W
 DISC SET: 151380-PKG

LF459721
 LF459722

FOR SEPCO

LENGTH: 2.44"

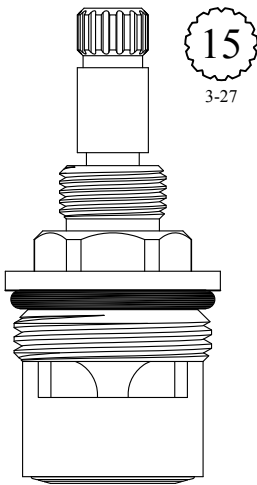

15
3-27

GASKET: 891180 O-RING INCLUDED
SEAL: 898520
DISC SET: 109850-PKG

401251
401252

LENGTH: 2.60"

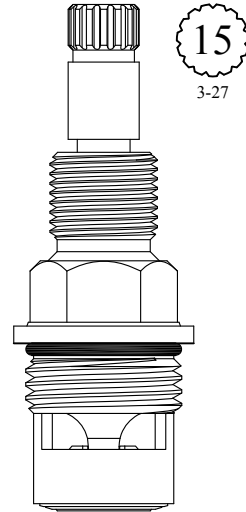

15
3-27

GASKET: 890170 O-RING INCLUDED
SEAL: 898510-W
DISC SET: 151380-PKG

LF464381
LF464382

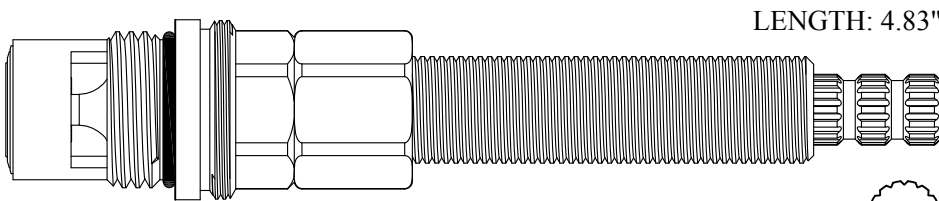

LENGTH: 4.83"

15
3-27

410031/ 410032

GASKET: 890170 O-RING INCLUDED
SEAL: 898510-W
DISC SET: 151380-PKG

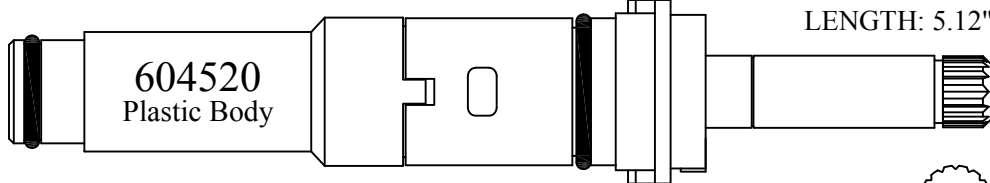

LENGTH: 5.12"

15
3-27

414711/ 414712

604520
Plastic Body

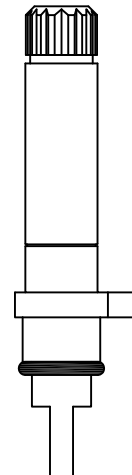

Available: Stem Only
214711 / 214712

FOR SHERLE WAGNER

LENGTH: 2.40"

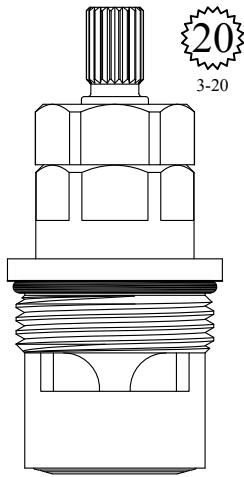

GASKET: 890210 O-RING INCLUDED
SEAL: 898520
DISC SET: 109850-PKG

401381
401382

LENGTH: 2.41"

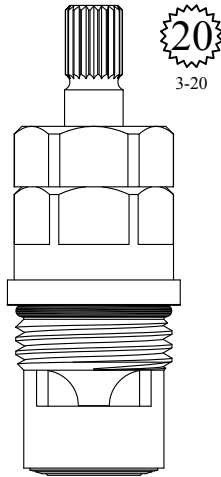

GASKET: 890170 O-RING INCLUDED
SEAL: 898510-W
DISC SET: 151380-PKG

LF462521
LF462522

LENGTH: 2.43"

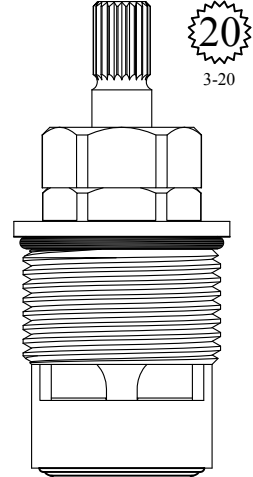

GASKET: 890210 O-RING INCLUDED
SEAL: 898520
DISC SET: 109850-PKG

401581
401582

LENGTH 3.08"

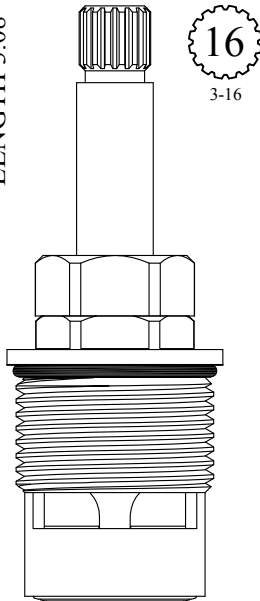

GASKET: 890210 O-RING INCLUDED
SEAL: 898520
DISC SET: 109850-PKG

401881
401882

LENGTH: 3.09"

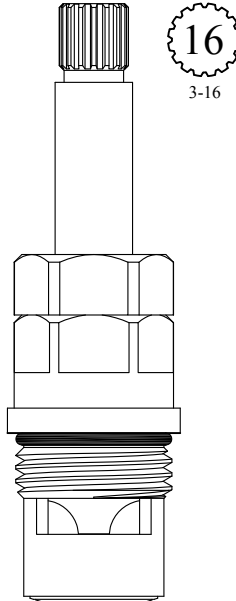

GASKET: 890170 O-RING INCLUDED
SEAL: 898510-W
DISC SET: 151380-PKG

LF466521
LF466522

LENGTH: 3.33"

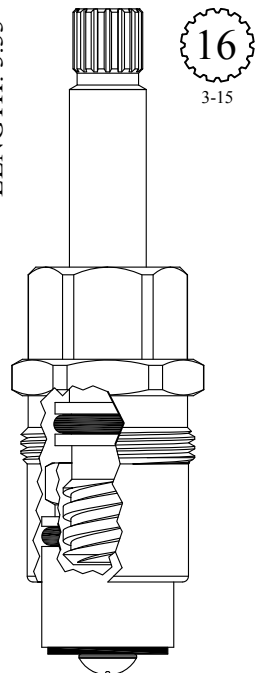

GASKET: 895100

LF467501
LF467502

FOR SHERLE WAGNER

Polished Brass Stem



SEAT USED: LF648620

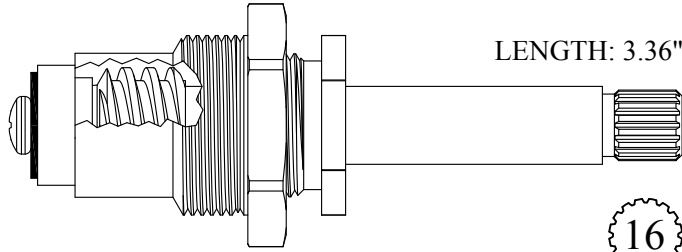

LENGTH: 3.36"



LF467111-PB/ LF467112-PB

GASKET: 895330

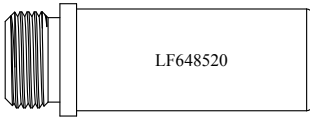

LF648520

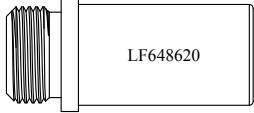

LF648620

SEAT USED: LF648520 or LF648620

Polished Brass Stem

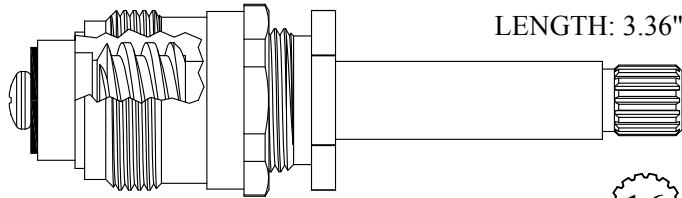

LENGTH: 3.36"



LF467611-PB/ LF467612-PB

GASKET: 895120

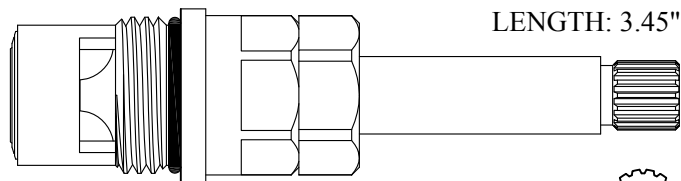

LENGTH: 3.45"



LF468521/ LF468522

GASKET: 890170 O-RING INCLUDED

SEAL: 898510-W

DISC SET: 151380-PKG

BARRY E.  WALTER  SR. CO.

FOR SIGMA

LENGTH: 2.60"

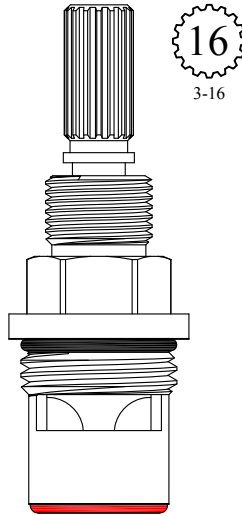

GASKET: 890170 O-RING INCLUDED
SEAL: 898570-R/B
DISC SET: 151380-PKG

LF464341
LF464342

FOR SIGN OF THE CRAB

Chrome Bonnet
available separately

757500

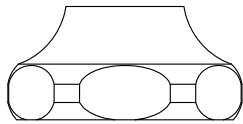

LENGTH: 1.98"

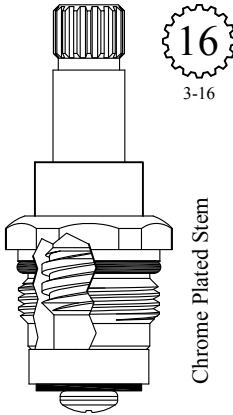

Chrome Plated Stem

Also available with polished brass stem
LF457501-PB / LF457502-PB

GASKET: 890160 O-RING INCLUDED

LF457501
LF457502

LENGTH: 1.99"

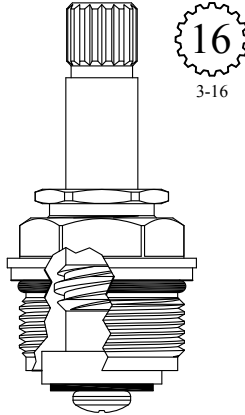

GASKET: 890180 O-RING INCLUDED

LF457721
LF457722

LENGTH 2.00"

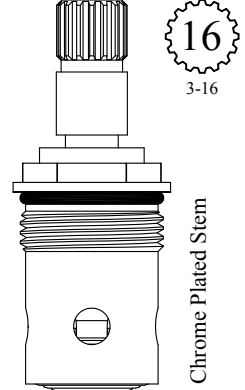

Chrome Plated Stem

GASKET: 890160 O-RING INCLUDED
SEAL: 898500
DISC SET: 112530-PKG

LF457901
LF457902

FOR SIGN OF THE CRAB

LENGTH: 2.04"

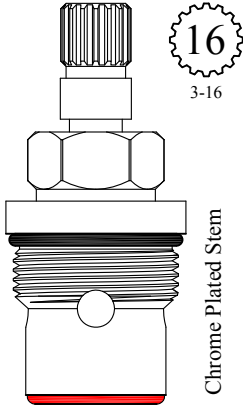

16
3-16

Chrome Plated Stem

GASKET: 890170 O-RING INCLUDED
SEAL: 898570-R/B
DISC SET: 151380-PKG

LF459371
LF459372

LENGTH: 2.23"

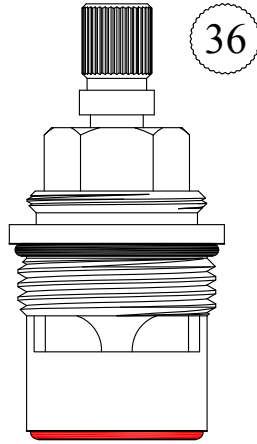

36

GASKET: 890210 O-RING INCLUDED
SEAL: 898610-R/B
DISC SET: 109850-PKG

400981
400982

LENGTH: 2.53"

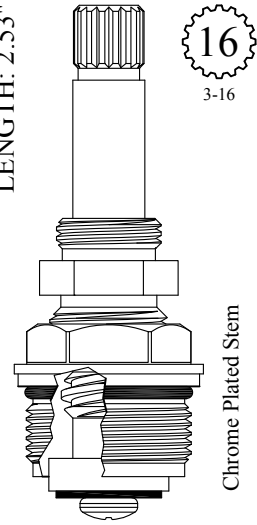

16
3-16

Chrome Plated Stem

GASKET: 890180 O-RING INCLUDED

LF464151
LF464152

LENGTH: 2.54"

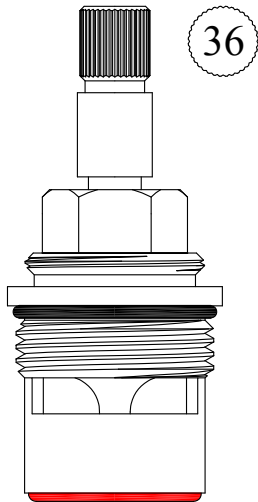

36

GASKET: 890210 O-RING INCLUDED
SEAL: 898610-R/B
DISC SET: 109850-PKG

401481
401482

LENGTH: 2.60"

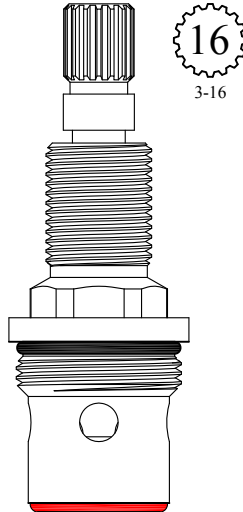

16
3-16

GASKET: 890170 O-RING INCLUDED
SEAL: 898570-R/B
DISC SET: 151380-PKG

LF464511
LF464512

LENGTH: 2.66"

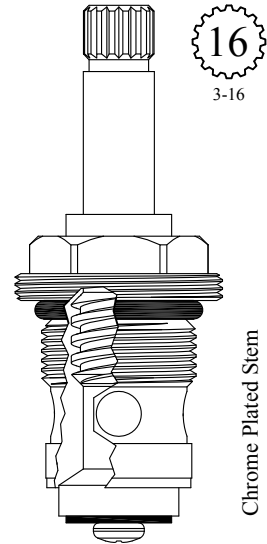

16
3-16

Chrome Plated Stem

GASKET: 891150 O-RING INCLUDED

430761

FOR SIGN OF THE CRAB

Chrome Plated Stem

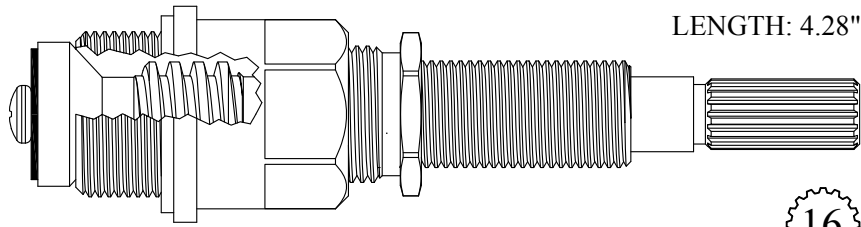

16
3-16

404841/ 404842

GASKET: 895390 INCLUDED

Chrome Plated Stem

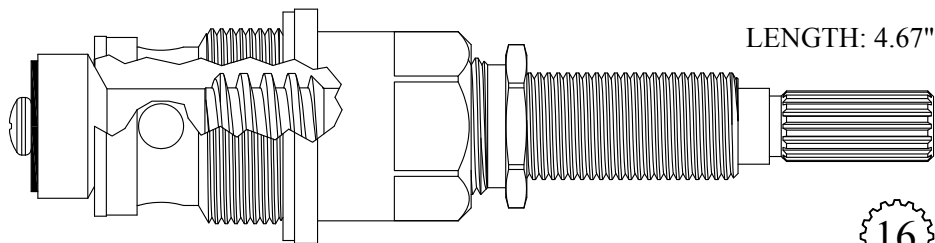

16
3-16

430971

GASKET: 895570 INCLUDED

Chrome Plated Stem

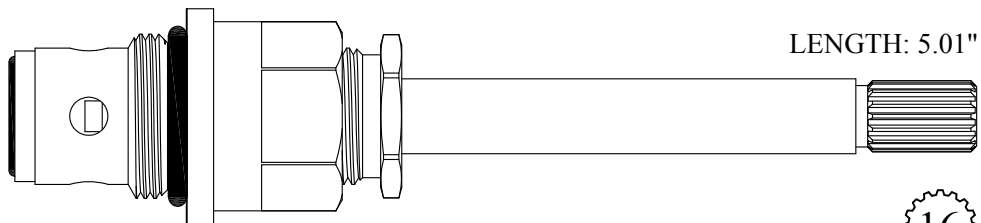

16
3-16

414911/ 414912

GASKET: 891160 O-RING INCLUDED
DISC SET: 112530-PKG

BARRY E.  SR. CO.

FOR SIGNATURE HARDWARE

FOR SIMBOLO

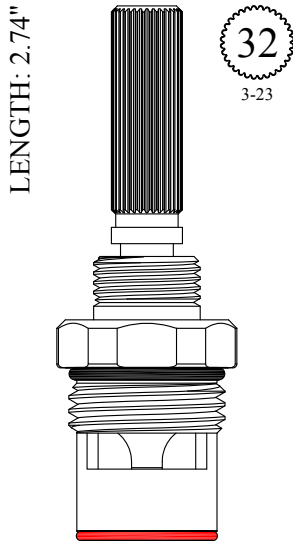

GASKET: 890170 O-RING INCLUDED
SEAL: 898570-R/B
DISC SET: 151380-PKG

LF464421
LF464422

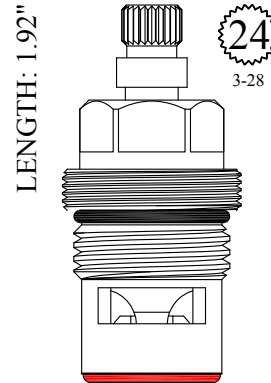

GASKET: 890170 O-RING INCLUDED
SEAL: 898570-R/B
DISC SET: 151380-PKG

LF456911
LF456912

FOR SISCO

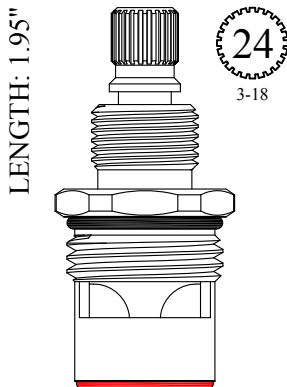

GASKET: 890170 O-RING INCLUDED
SEAL: 898570-R/B
DISC SET: 151380-PKG

LF456901
LF456902

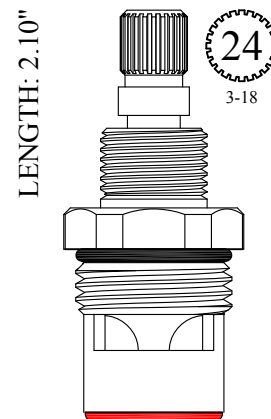

GASKET: 890170 O-RING INCLUDED
SEAL: 898580-R/B
DISC SET: 151380-PKG

LF459221
LF459222

FOR SOHO

LENGTH: 2.87"

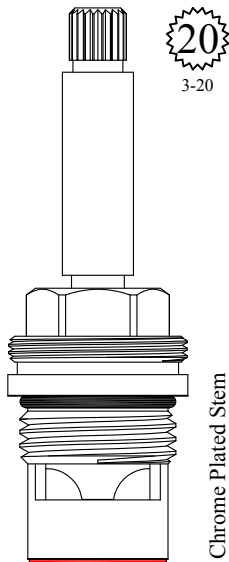

GASKET: 890170 O-RING INCLUDED
SEAL: 898570-R/B
DISC SET: 151380-PKG

LF465371
LF465372

LENGTH: 2.88"

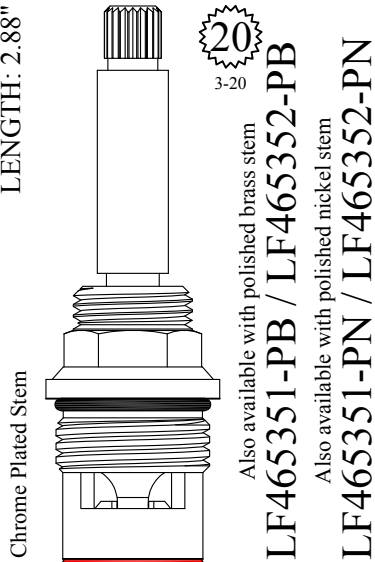

GASKET: 890170 O-RING INCLUDED
SEAL: 898580-R/B
DISC SET: 151380-PKG

LF465351
LF465352

LENGTH: 3.10"

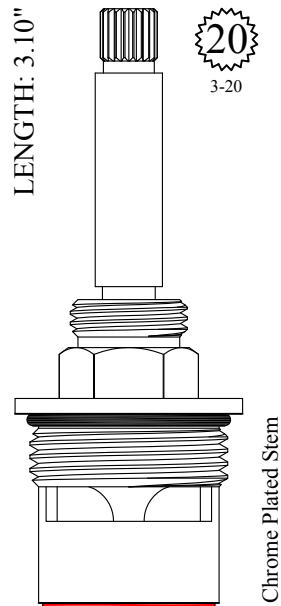

GASKET: 890170 O-RING INCLUDED
SEAL: 898610-R/B
DISC SET: 109850-PKG

402351
402352

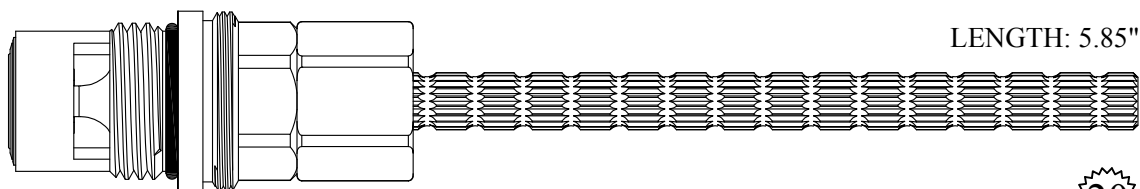

LENGTH: 5.85"

425741/ 425742

GASKET: 890170 O-RING INCLUDED
SEAL: 898510-W
DISC SET: 151380-PKG

20
3-20

BARRY E.  SR. CO.

Send Your Orders To:

BARRY E.  SR. CO.

E-mail: orderdesk@barrywalter.com

Fax: 1.800.886.9831

Phone: 1.800.767.5552



Quality Replacement Parts

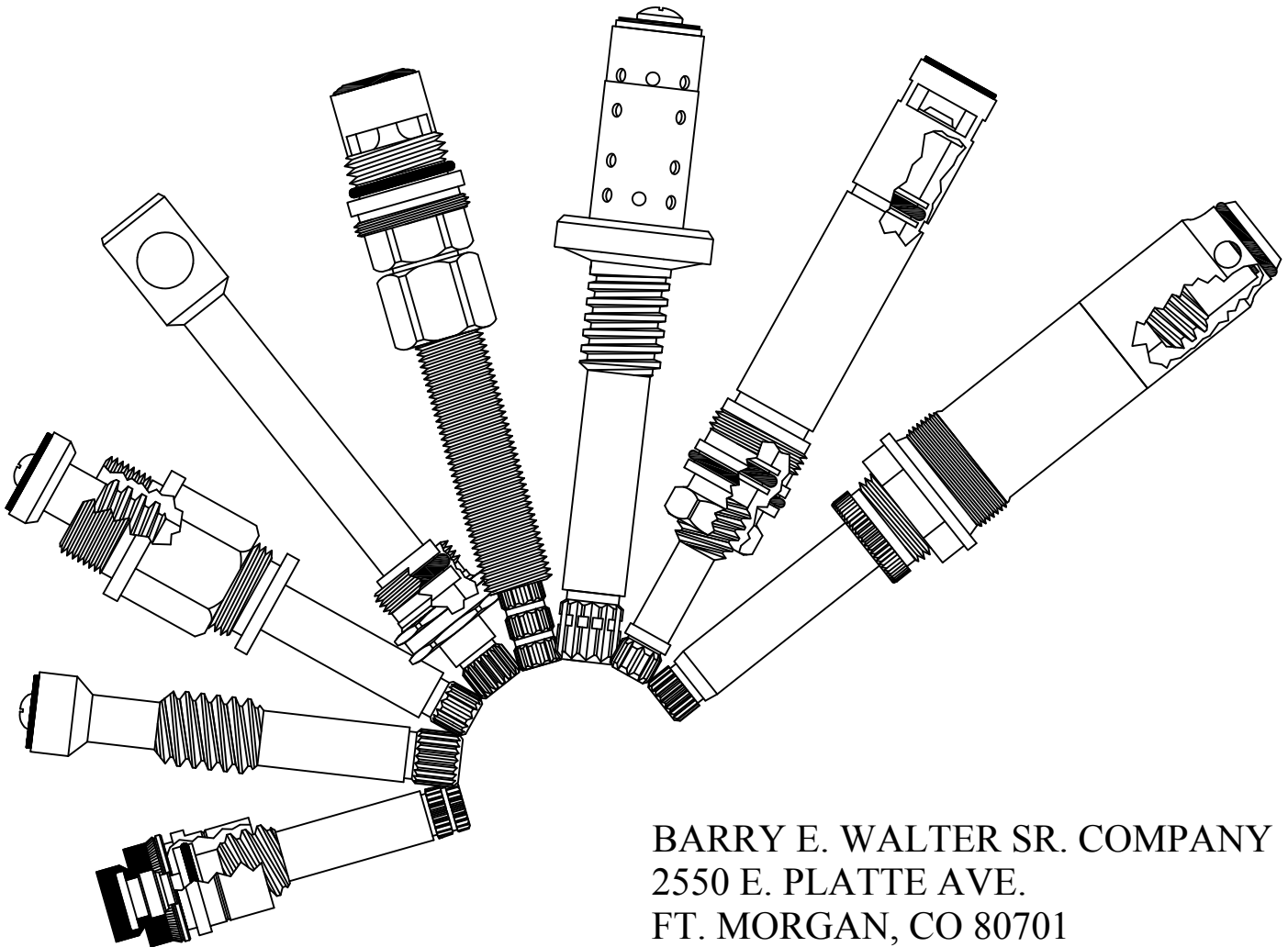

BARRY E. WALTER SR. COMPANY
2550 E. PLATTE AVE.
FT. MORGAN, CO 80701

FOR SPEAKMAN

LENGTH: 1.07"

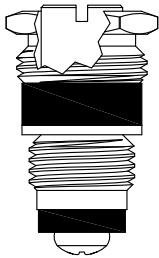

Nickel Plated Stem
Chrome Plated Pkg Nut

LF400111
LF200111 Stem Only

LENGTH: 1.24"

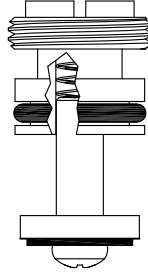

400220

LENGTH: 1.48"

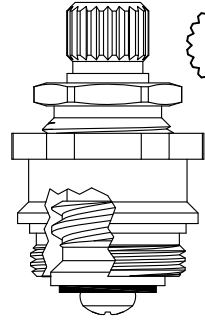

20

2-4

Nickel Plated Gland

GASKET: 895150

LF451081
LF451082

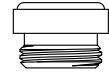

SEAT USED: LF648760

LENGTH: 1.63"

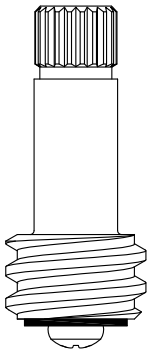

20
2-4

LF253071
LF253072

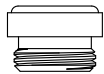

SEAT USED: LF648760

LENGTH: 1.64"

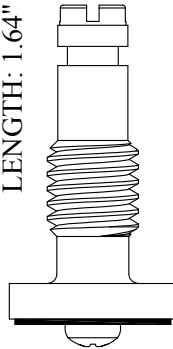

Chrome Plated Stem

252911

LENGTH: 1.75"

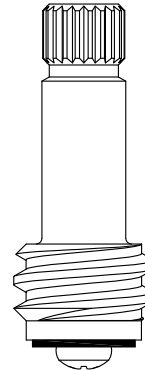

20

2-4

Chrome Plated Stem

LF256011
LF256012

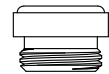

SEAT USED: LF648760

FOR SPEAKMAN

LENGTH: 1.85"

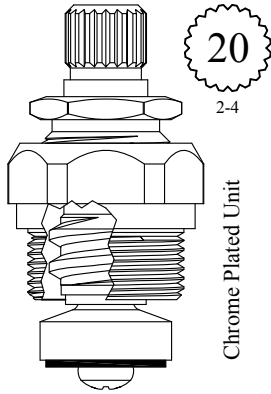

20

2-4

Chrome Plated Unit

GASKET: 895150

LF456061

LF456062

LF256061 Stem Only

LF256062 Stem Only



SEAT USED: LF648930

Comes with a plastic
Speakman handle bushing

LENGTH: 1.94"

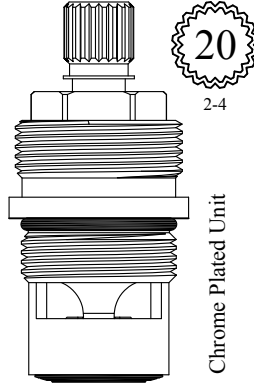

20

2-4

Chrome Plated Unit

GASKET: 890170 O-RING INCLUDED
SEAL: 898510-W
DISC SET: 151380-PKG

LF458801

LF458802

LENGTH: 1.94"

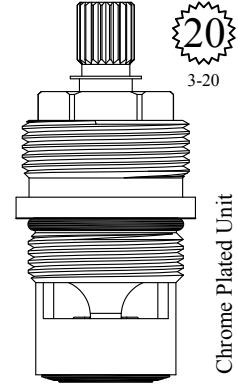

20

3-20

Chrome Plated Unit

GASKET: 890170 O-RING INCLUDED
SEAL: 898510-W
DISC SET: 151380-PKG

LF458811

LF458812

LENGTH: 2.00"

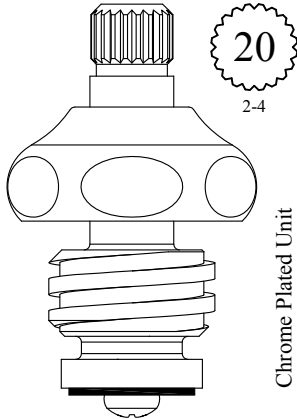

20

2-4

Chrome Plated Unit

LF457121

LF457122

LF257121 Stem Only

LF257122 Stem Only

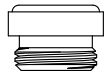

SEAT USED: LF648760

LENGTH: 2.20"

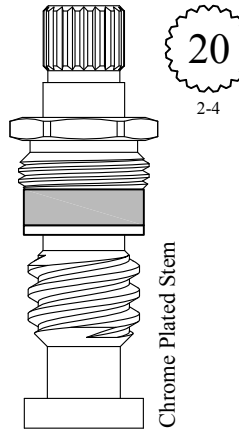

20

2-4

Chrome Plated Stem

401131

201131 Stem Only



SEAT USED: 648190

LENGTH: 2.24"

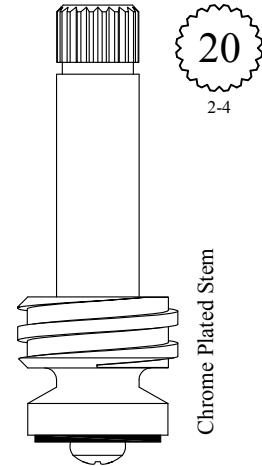

20

2-4

Chrome Plated Stem

LF263041

LF263042



SEAT USED: LF648930

FOR SPEAKMAN

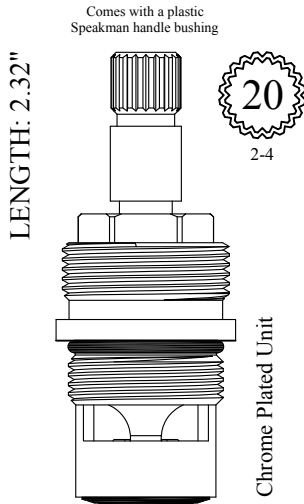

GASKET: 890170 O-RING INCLUDED
SEAL: 898510
DISC SET: 151380-PKG
LF462501
LF462502

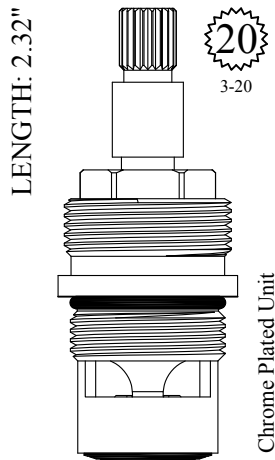

GASKET: 890170 O-RING INCLUDED
SEAL: 898510
DISC SET: 151380-PKG
LF462511
LF462512

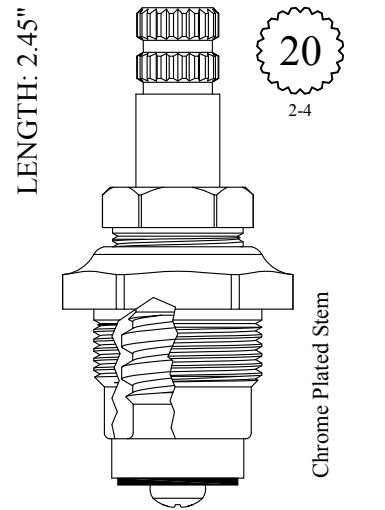

GASKET: 895400
LF463731
LF263731 Stem Only

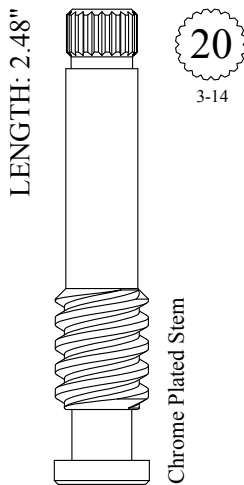

201301
SEAT USED: 648190

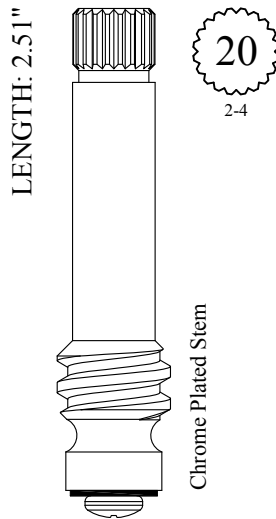

LF264081
LF264082
SEAT USED: LF648760

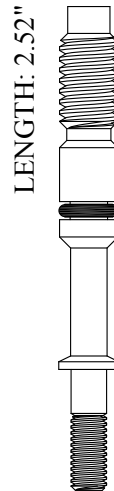

LF264430

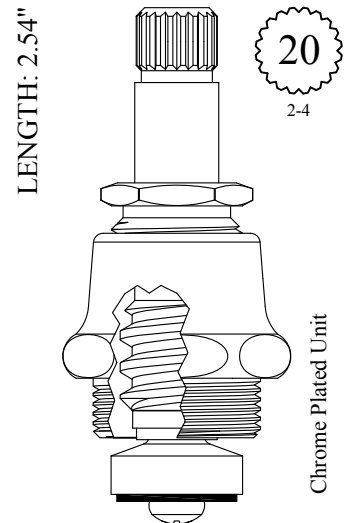

GASKET: 895180
LF464051
LF464052
LF264051 Stem Only
LF264052 Stem Only



FOR SPEAKMAN

LENGTH: 2.60"

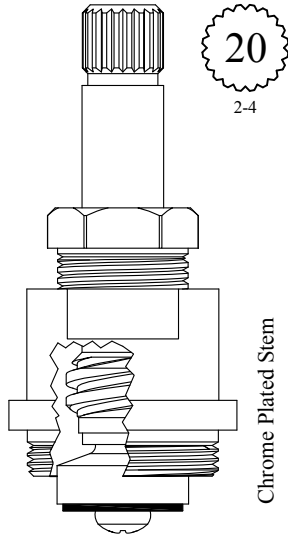

Chrome Plated Stem

GASKET: 895550

LF464071
LF264071 Stem Only

LENGTH: 2.63"

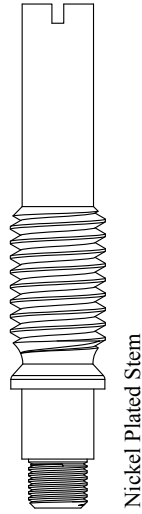

Nickel Plated Stem

264331

LENGTH: 2.79"

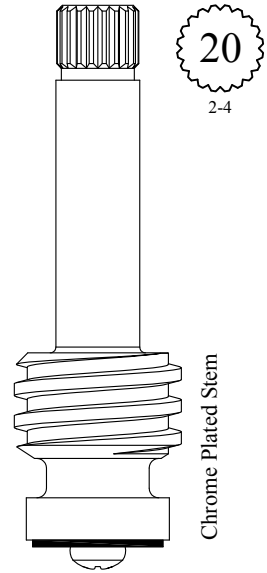

Chrome Plated Stem

LF265421

LENGTH: 2.88"

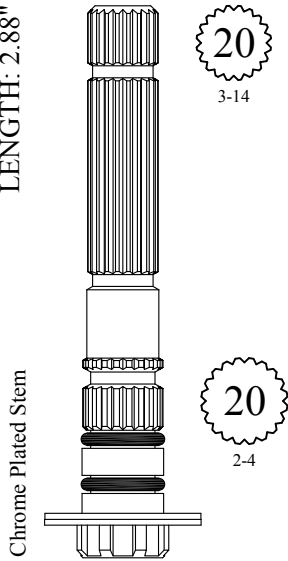

Chrome Plated Stem

201510

LENGTH: 2.88"

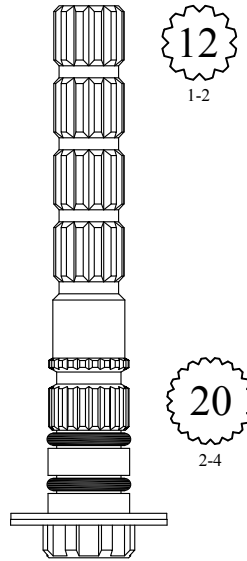

201540

LENGTH: 2.88"

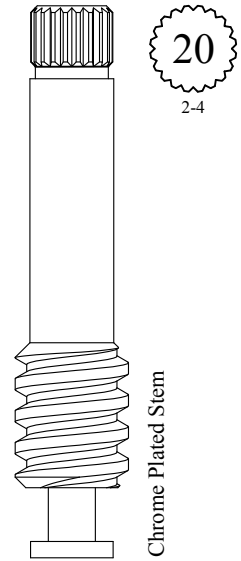

Chrome Plated Stem

201681

FOR SPEAKMAN

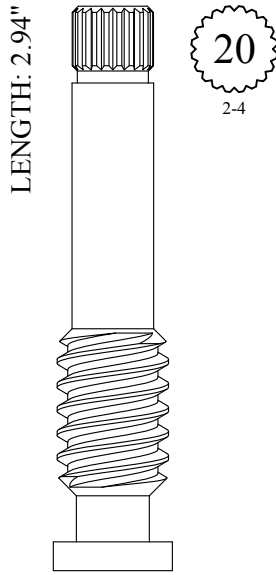

201701

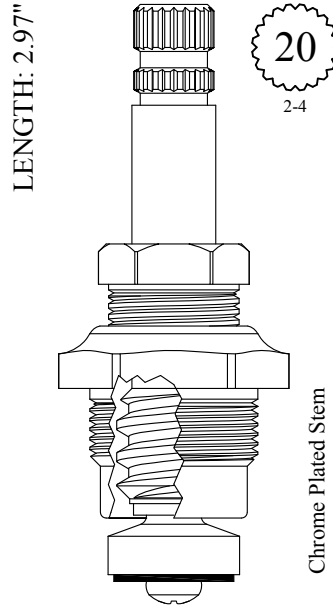

GASKET: 895400

LF467171
 LF467172
 LF267171 Stem Only
 LF267172 Stem Only

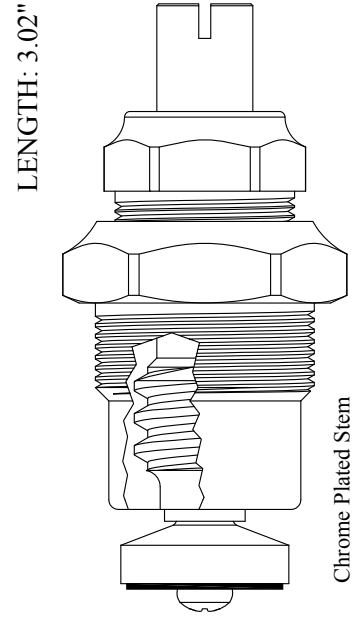

GASKET: 895450

402071
 202071 Stem Only

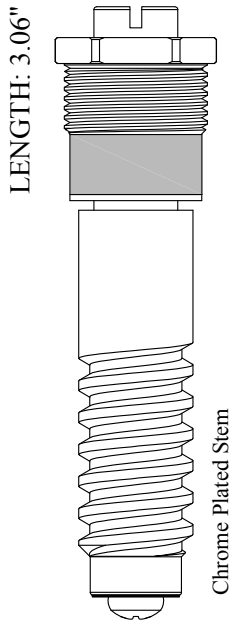
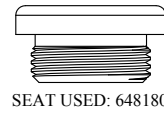

401901
 201901 Stem Only

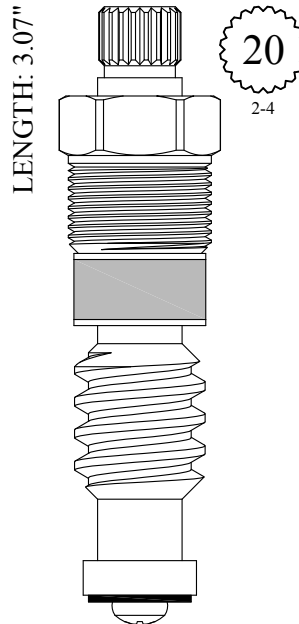

402201
 202201 Stem Only

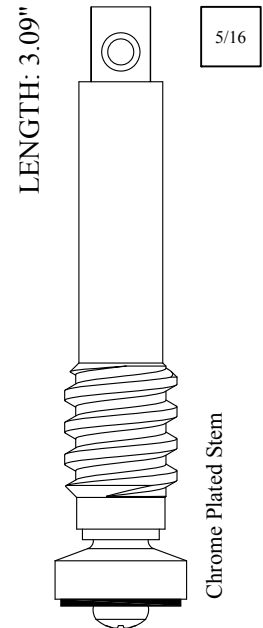

LF267521

FOR SPEAKMAN

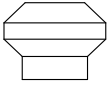

SEAT USED: 649110

LENGTH: 3.22"

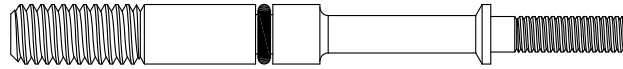

LF267140

Chrome Plated Stem

LENGTH: 3.23"

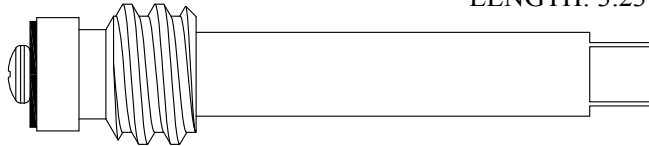

LF267201

11/32

Chrome Plated Unit

LENGTH: 3.27"

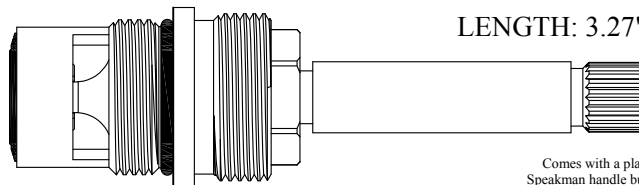

Comes with a plastic
Speakman handle bushing

LF466901/ LF466902

GASKET: 890170 O-RING INCLUDED
SEAL: 898510
DISC SET: 151380-PKG

20
2-4

Chrome Plated Unit

LENGTH: 3.27"

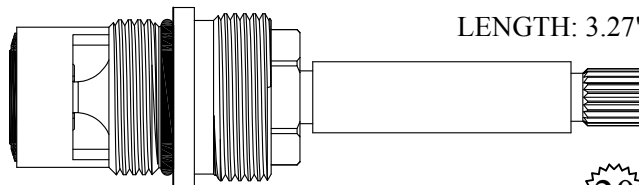

LF466911/ LF466912

GASKET: 890170 O-RING INCLUDED
SEAL: 898510
DISC SET: 151380-PKG

20
3-20

FOR SPEAKMAN

Chrome Plated Stem

LENGTH: 3.31"

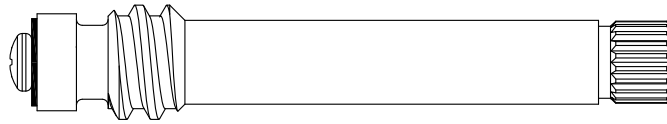

LF267661



SEAT USED: LF648760

LENGTH: 3.37"

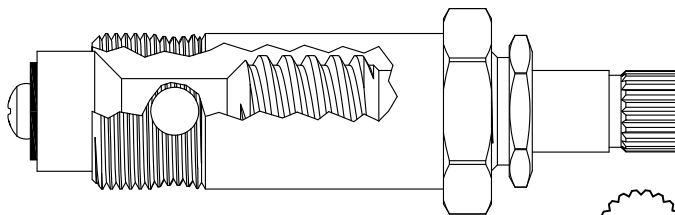

430111
230111 Stem Only
GASKET: 895160



SEAT USED: LF648760

LENGTH: 3.40"

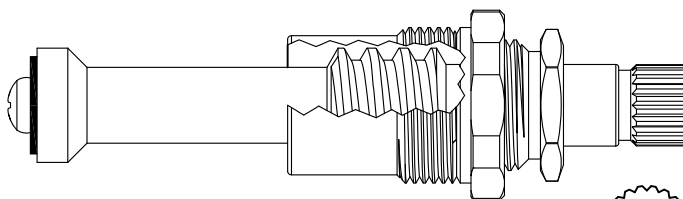

LF468501
LF268501 Stem Only

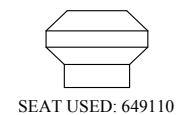

SEAT USED: 649110

LENGTH: 3.44"

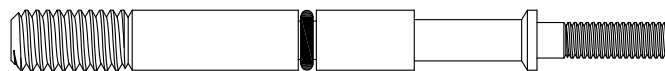

LF267900

FOR SPEAKMAN

Chrome Plated Unit

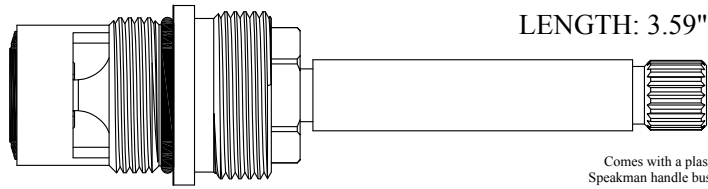

LENGTH: 3.59"

Comes with a plastic
Speakman handle bushing

402951/ 402952

GASKET: 890170 O-RING INCLUDED
SEAL: 898510
DISC SET: 151380-PKG



2-4

Chrome Plated Unit

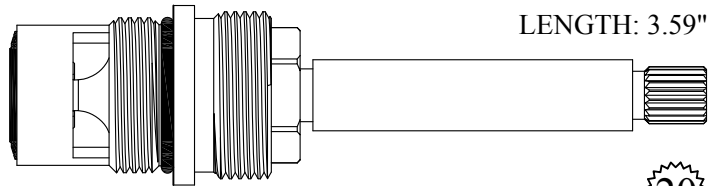

LENGTH: 3.59"

402961/ 402962

GASKET: 890170 O-RING INCLUDED
SEAL: 898510
DISC SET: 151380-PKG



3-20

Chrome Plated Stem

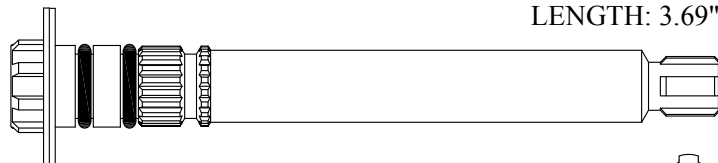

LENGTH: 3.69"

202980



2-4



SEAT USED: LF648760

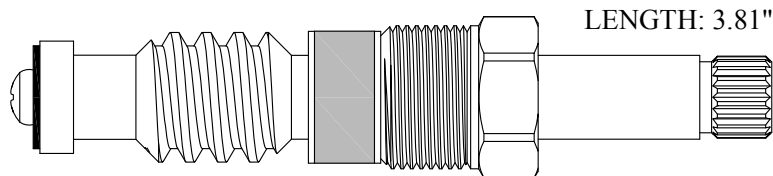

LENGTH: 3.81"

**403301
203301 Stem Only**



2-4

FOR SPEAKMAN

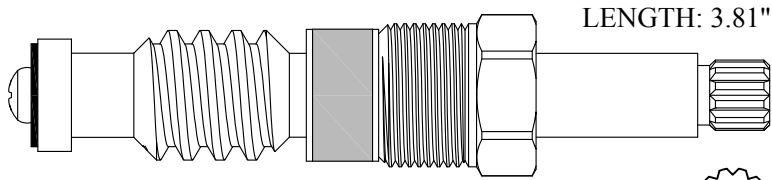

403351
203351 Stem Only

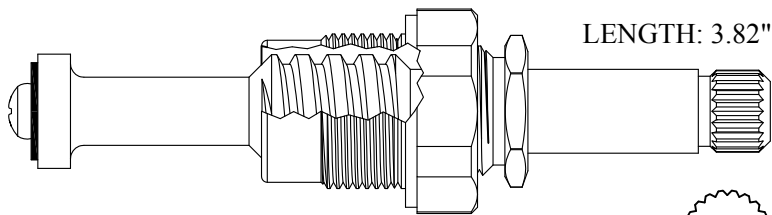

403241
203241 Stem Only
GASKET: 895160

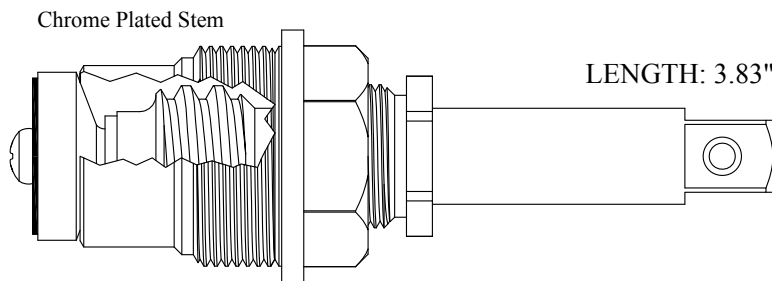
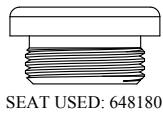

403401
203401 Stem Only

Chrome Plated Stem

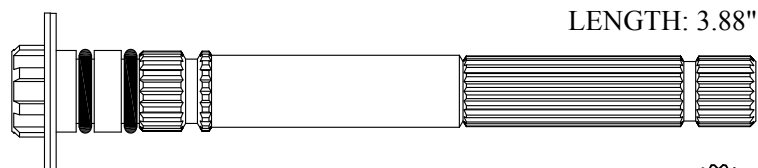

203470



FOR SPEAKMAN



SEAT USED: LF648930

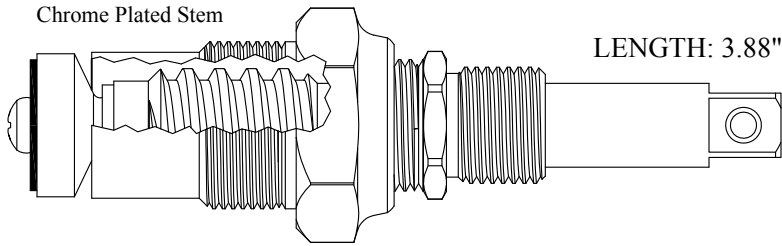

403531
203531 Stem Only
GASKET: 895400



SEAT USED: LF648760

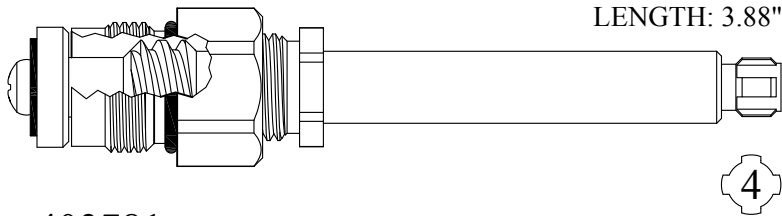

403781
GASKET: 890150 O-RING INCLUDED

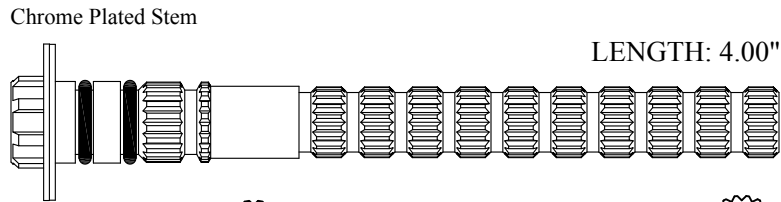

204030



2-4



3-14



SEAT USED: LF648760

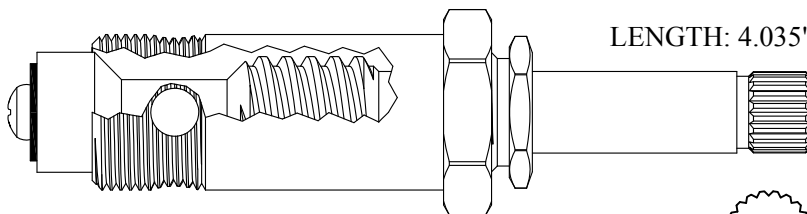

430121
230121 Stem Only
GASKET: 895160



2-4

FOR SPEAKMAN

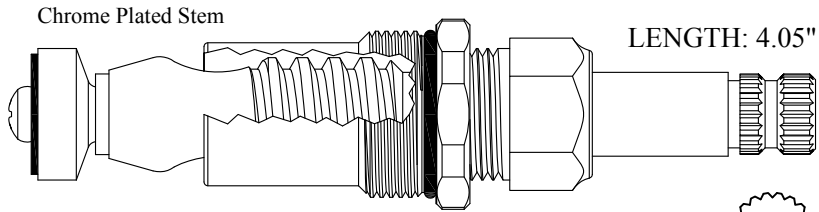

LF470101/ LF470102
 LF270101/ LF270102 Stem Only
 GASKET: 890180 O-RING INCLUDED

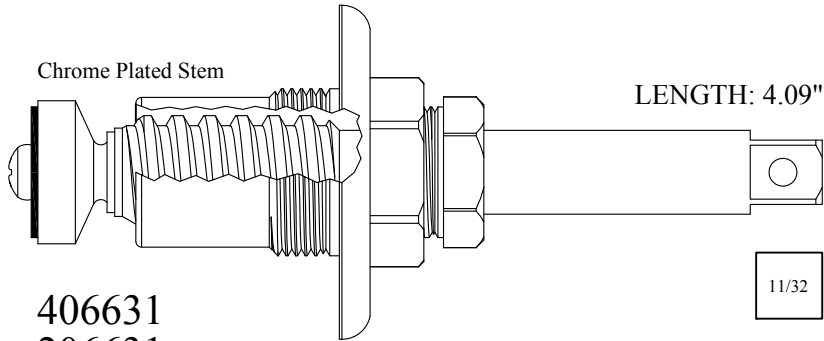

406631
 206631 Stem Only
 GASKET: 895400

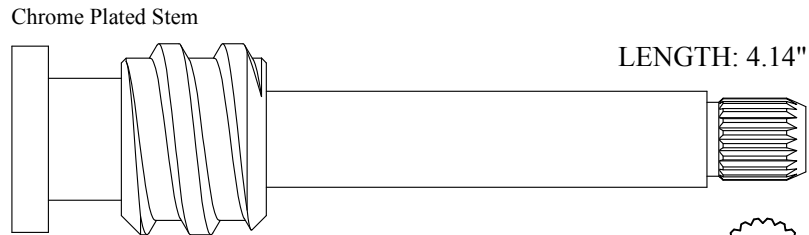

204511

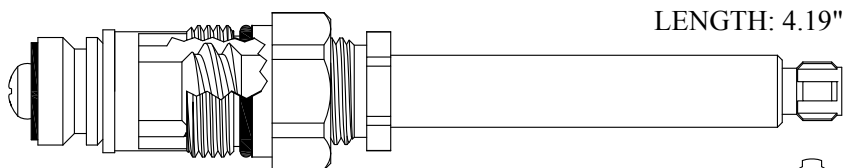

430381



FOR SPEAKMAN

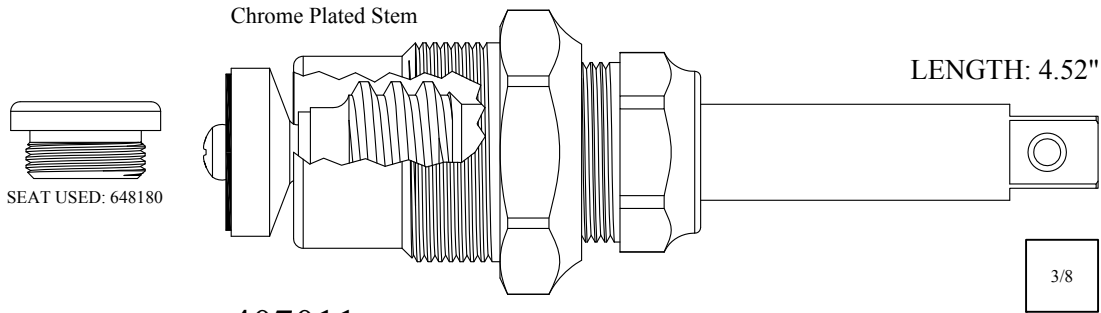

407011
207011 Stem Only
 GASKET: 895450

3/8

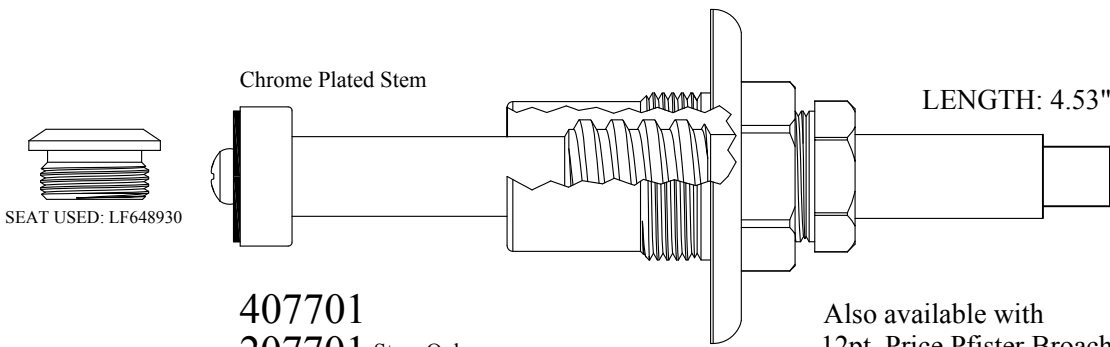

407701
207701 Stem Only
 GASKET: 895400

Also available with
 12pt. Price Pfister Broach

407751
207751 Stem Only

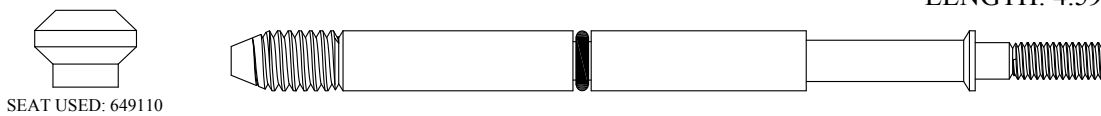
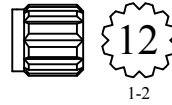

LF274070

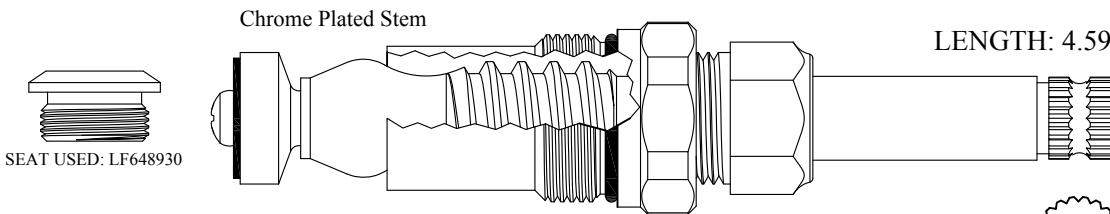

LF475011/ LF475012
LF275011/ LF275012 Stem Only
 GASKET: 890180 O-RING INCLUDED

20
 2-4

FOR SPEAKMAN

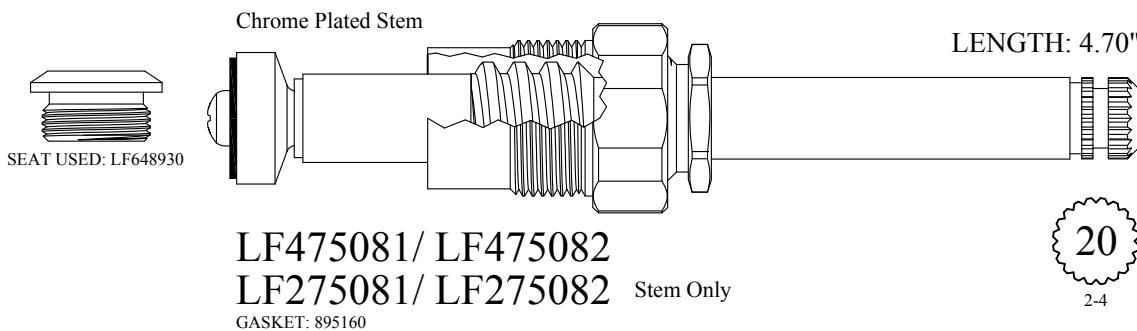
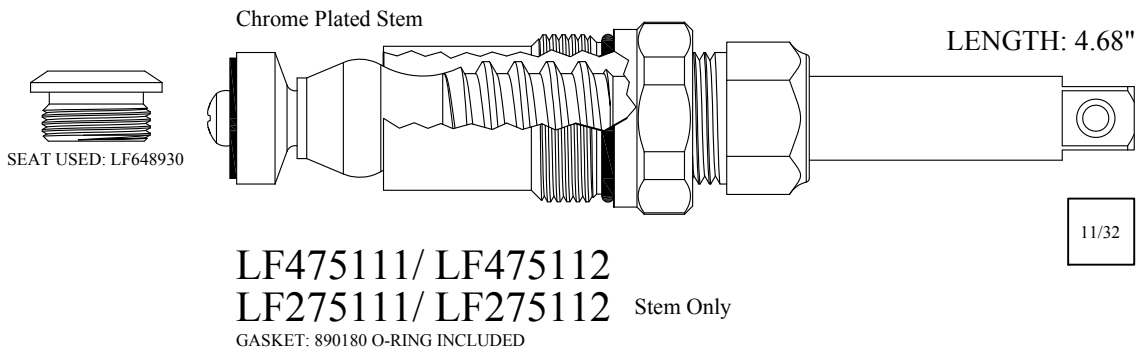
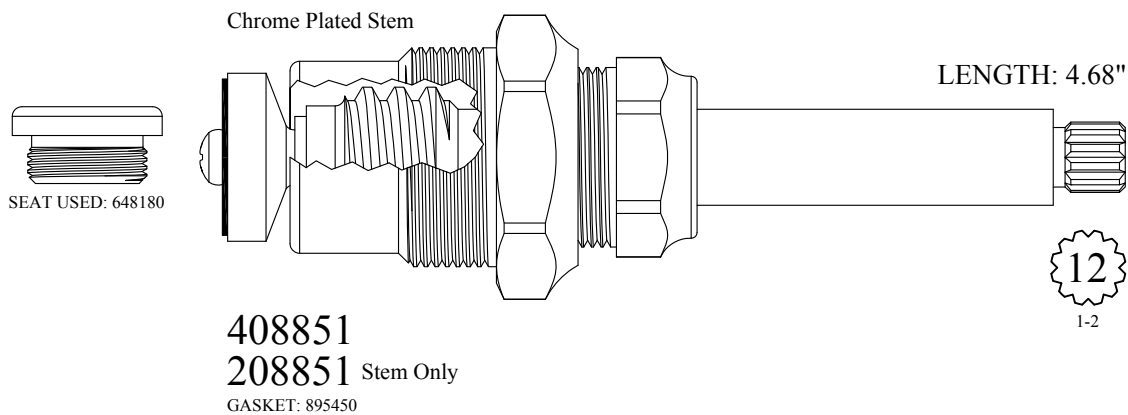
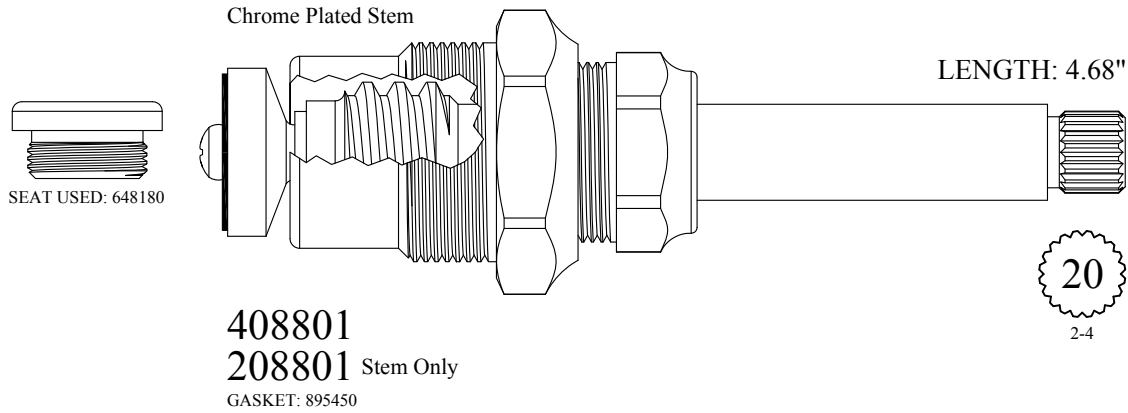

FOR SPEAKMAN

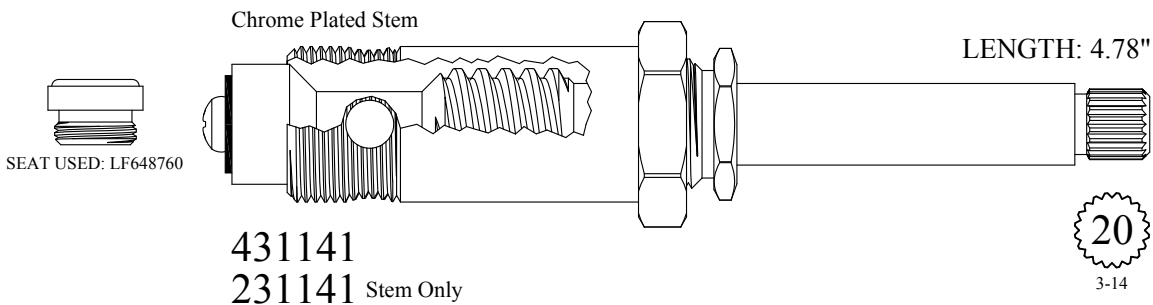
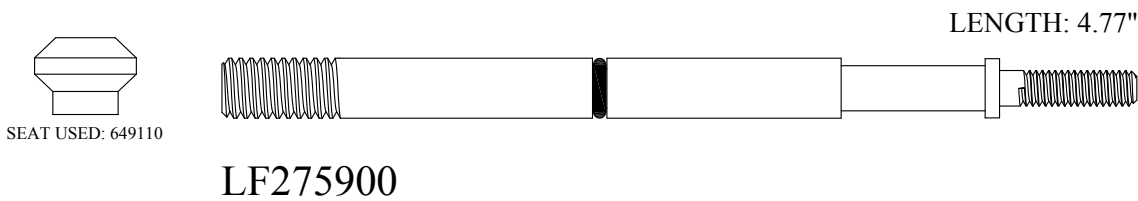
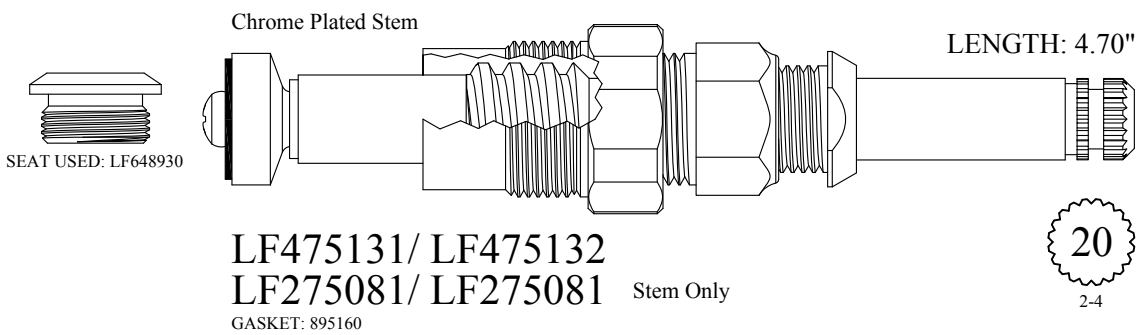
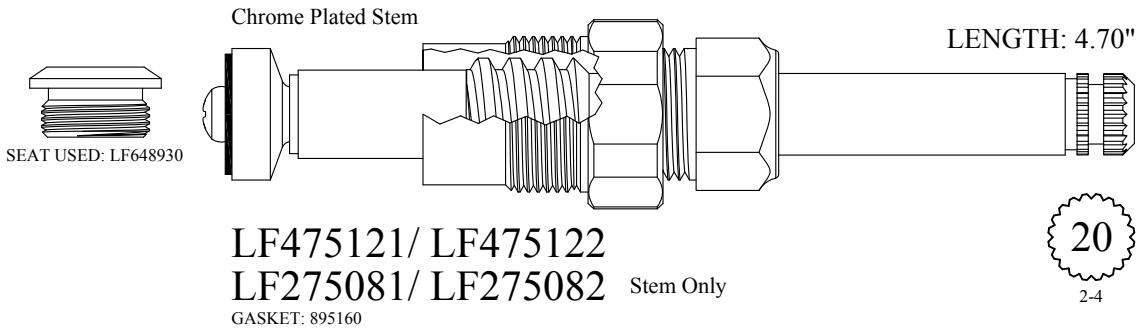

FOR SPEAKMAN

Chrome Plated Stem

SEAT USED: LF648760

LENGTH: 4.78"

431191
231191 Stem Only

GASKET: 890180 O-RING INCLUDED

20
2-4

Chrome Plated Stem

SEAT USED: LF648930

LENGTH: 4.92"

LF475101/ LF475102
LF275101/ LF275102 Stem Only

GASKET: 890180 O-RING INCLUDED

20
2-4

Chrome Plated Stem

SEAT USED: LF648930 or LF648760

LENGTH: 4.93"

411701
211701 Stem Only

GASKET: 895180

20
2-4

Chrome Plated Stem

SEAT USED: LF648930 or LF648760

LENGTH: 4.93"

411751
211751 Stem Only

GASKET: 895180

12
1-2

FOR SPEAKMAN

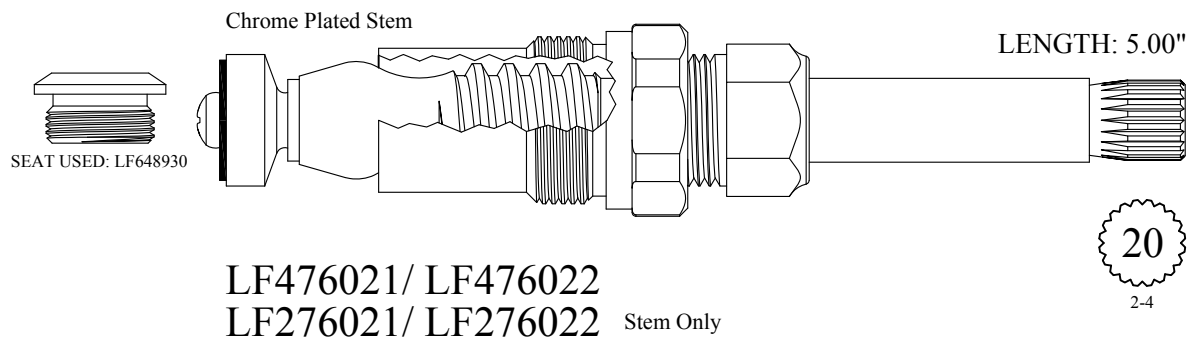
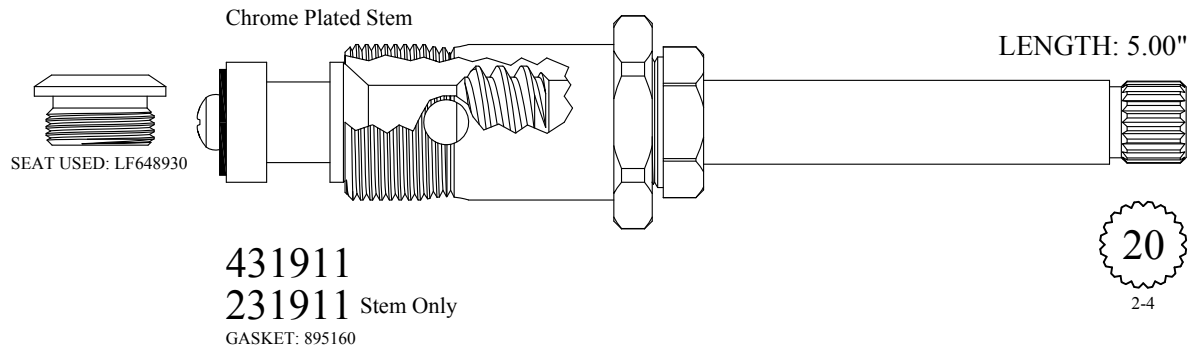
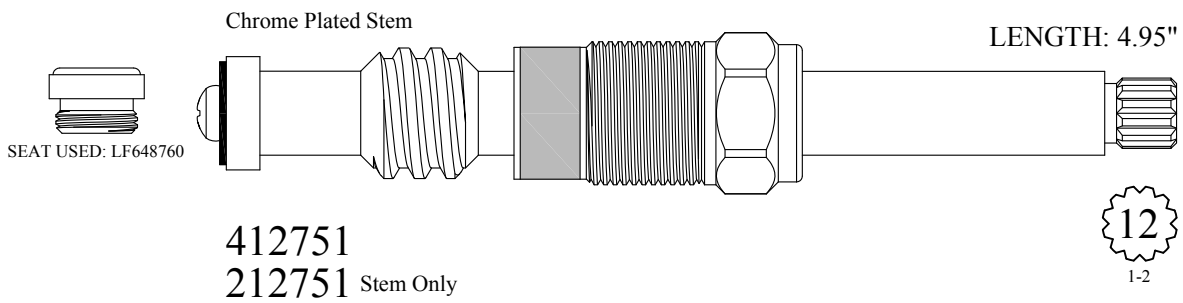
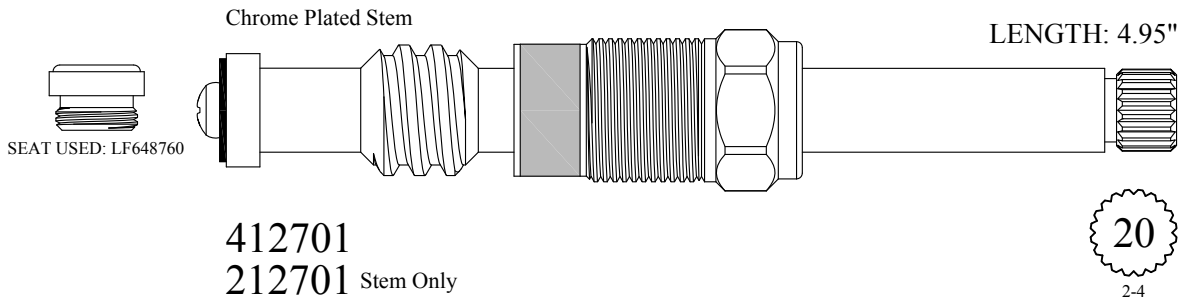

FOR SPEAKMAN

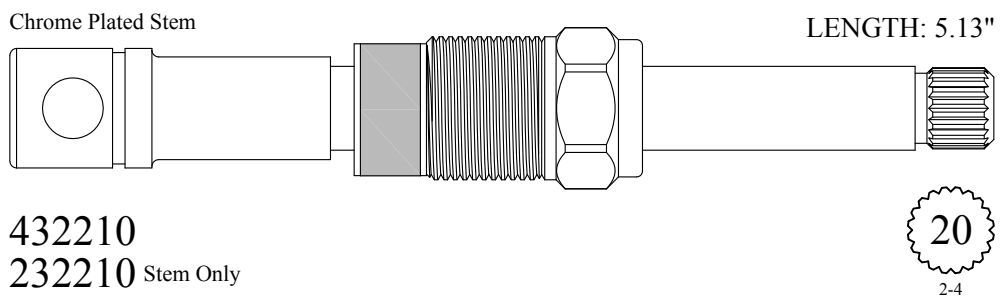
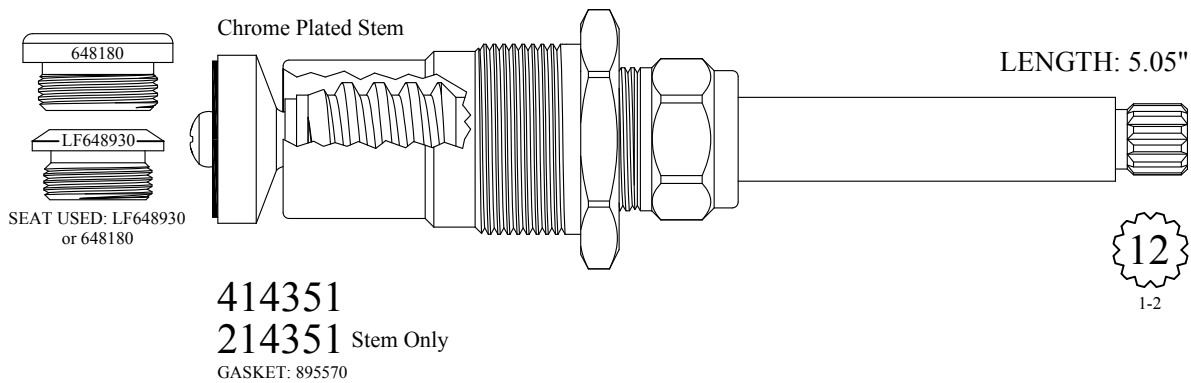
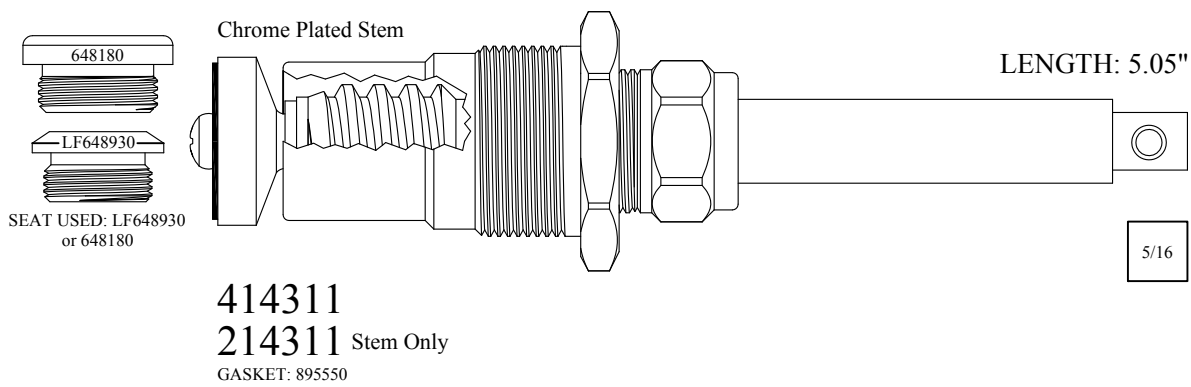
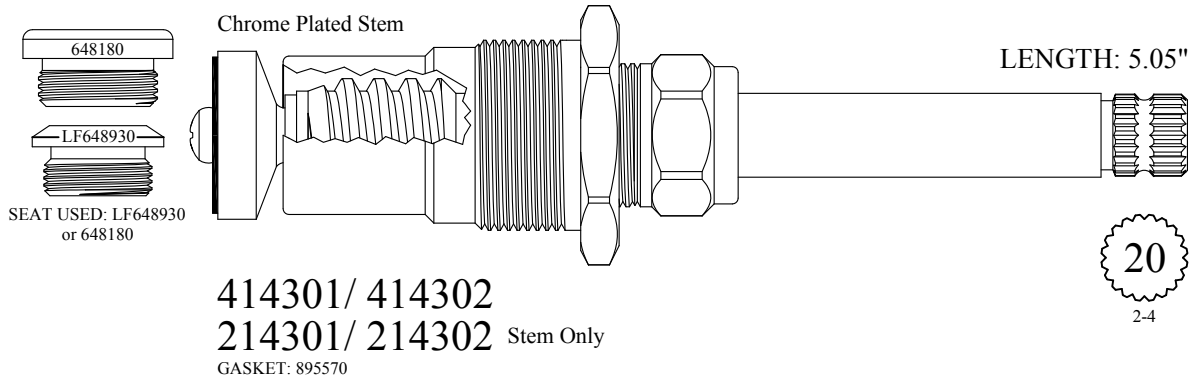

FOR SPEAKMAN

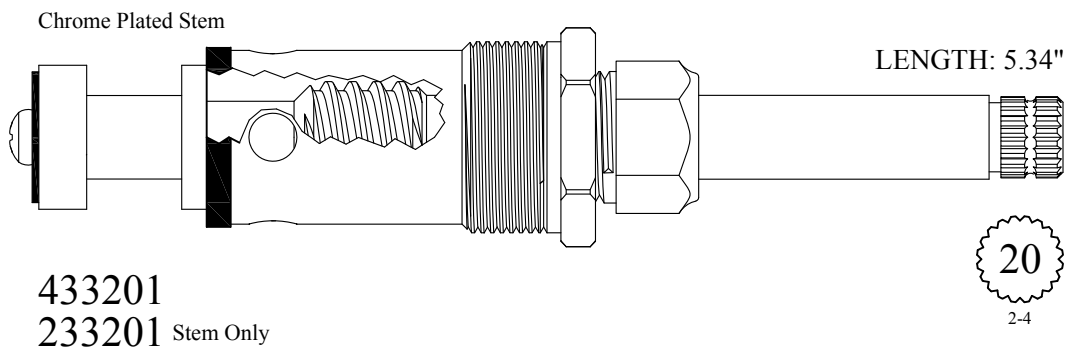
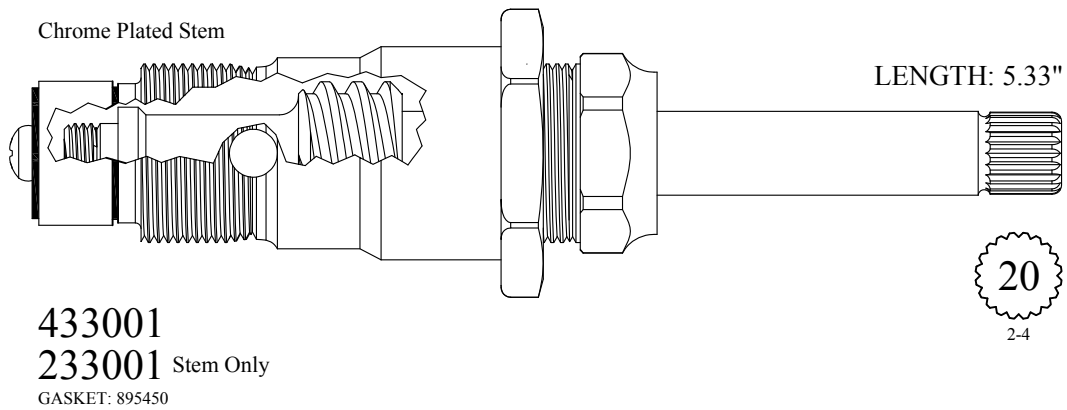
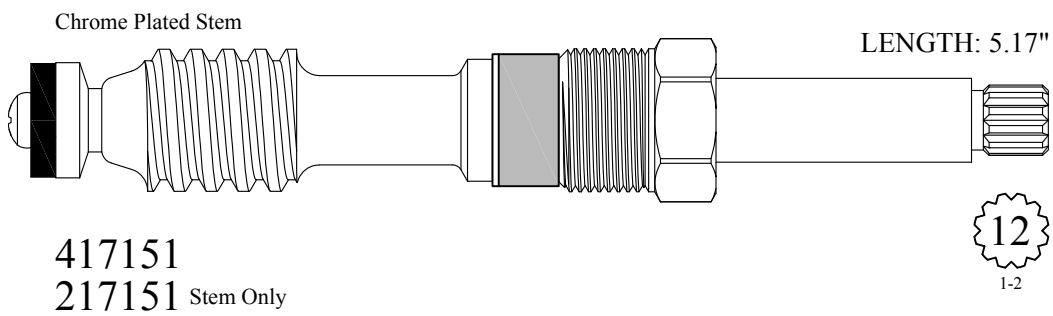
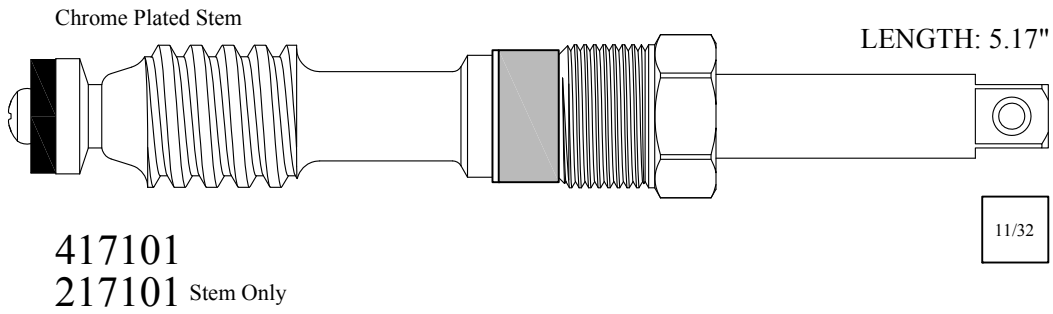

FOR SPEAKMAN

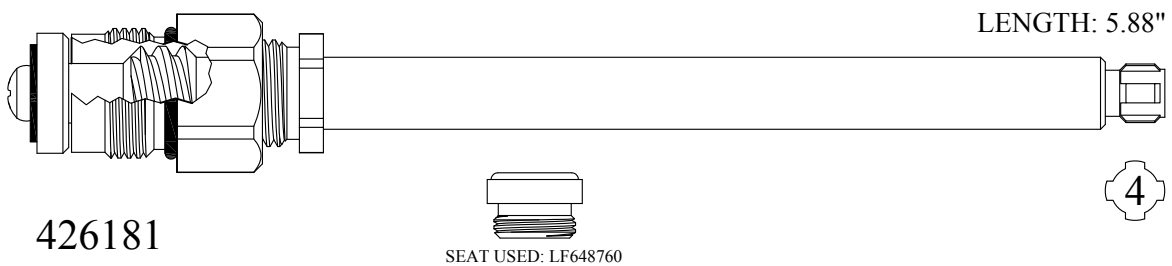
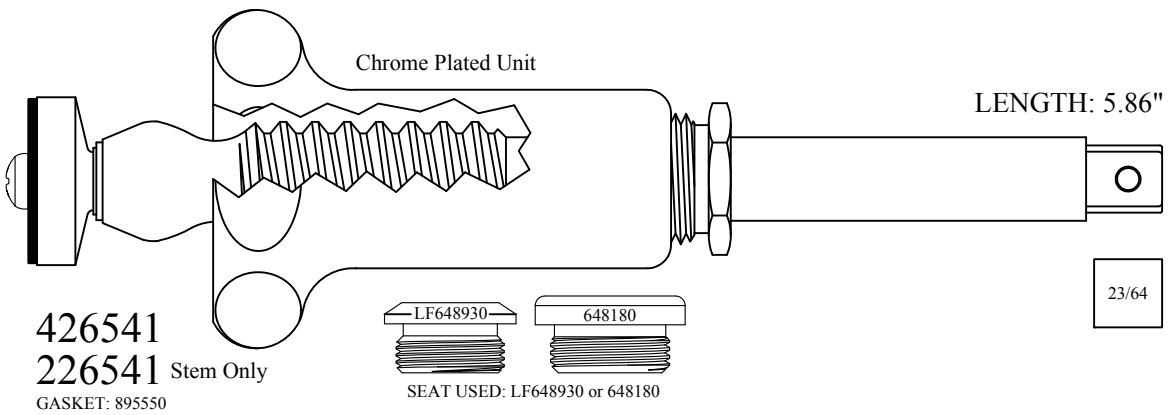
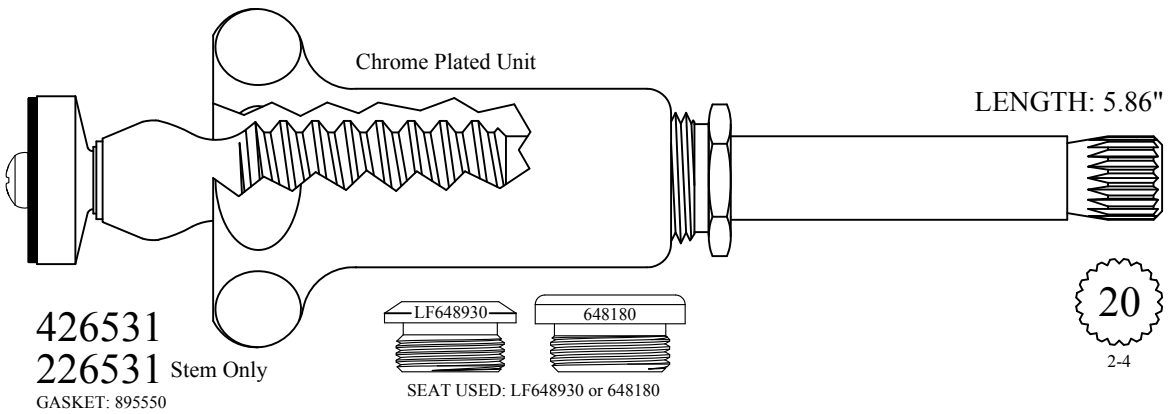
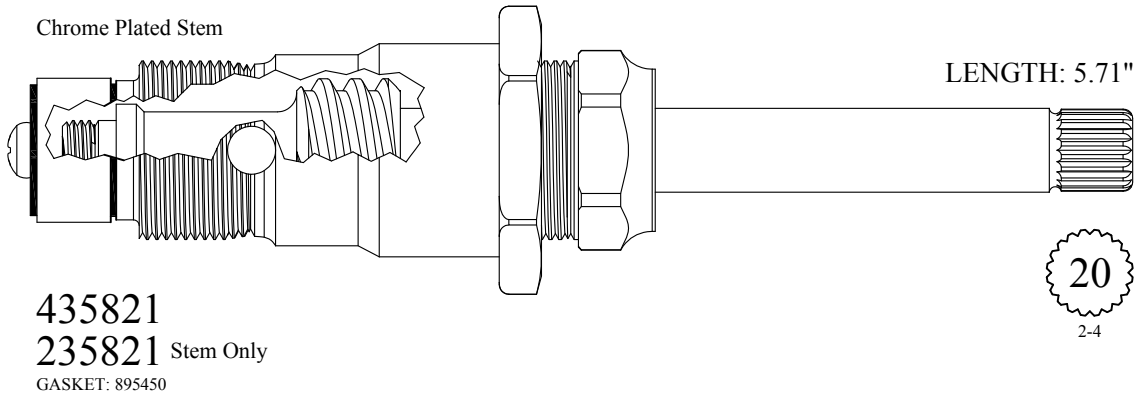

FOR SPEAKMAN

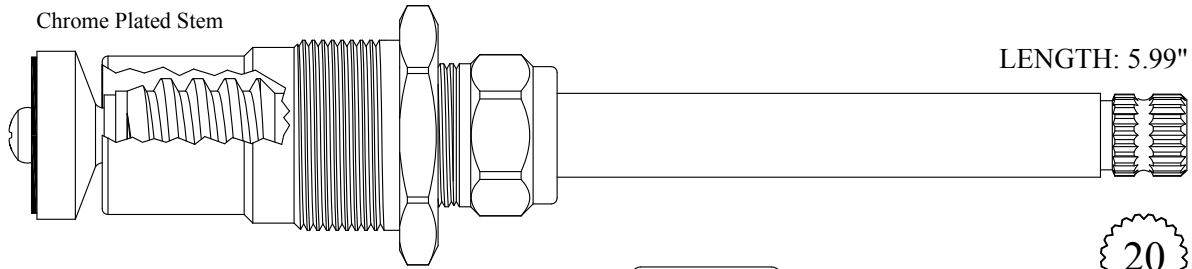

426021/ 426022
226021/ 226022 Stem Only
GASKET: 895550

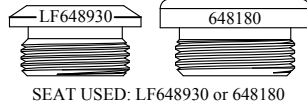

SEAT USED: LF648930 or 648180

20
2-4

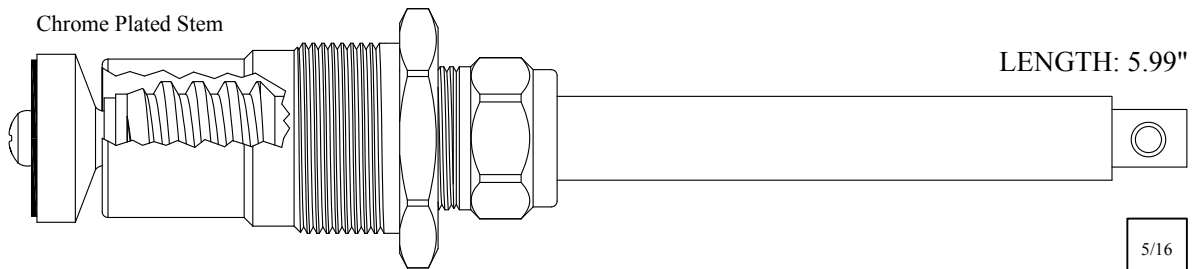

426041
226041 Stem Only
GASKET: 895550

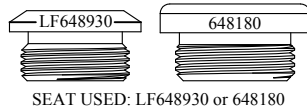

SEAT USED: LF648930 or 648180

5/16

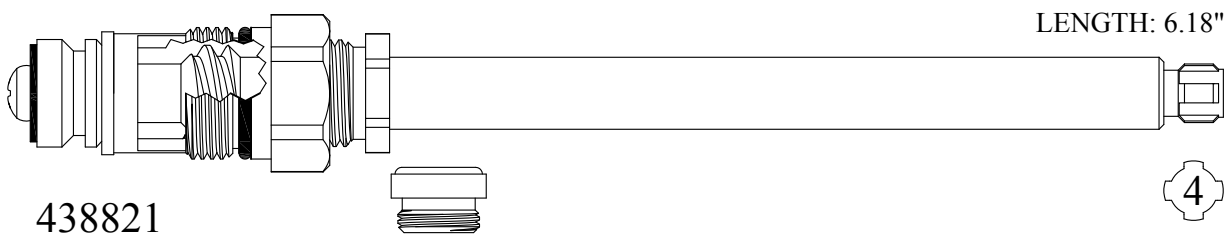

438821



SEAT USED: LF648760

4

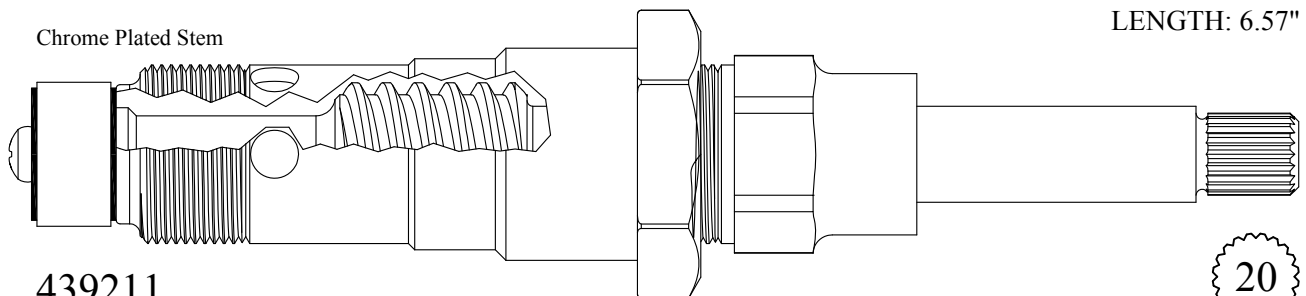

439211
239211 Stem Only
GASKET: 895450

20
2-4

FOR SPEAKMAN

LENGTH: 7.35"

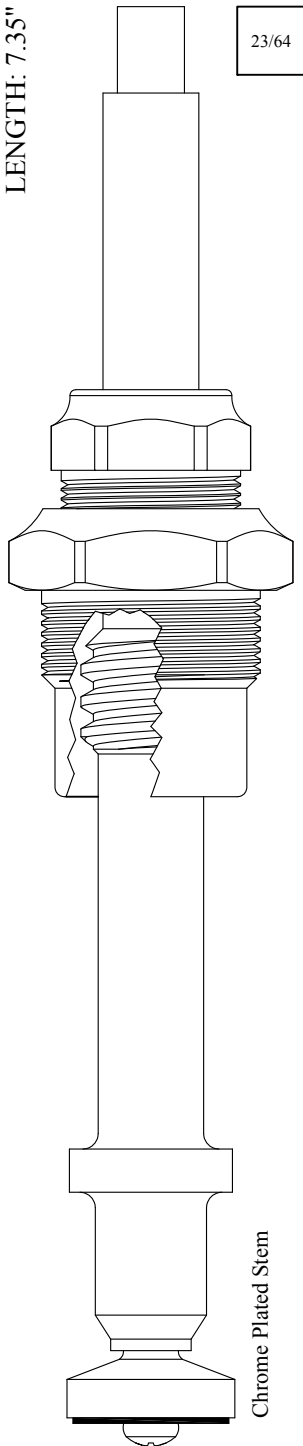

GASKET: 895450

428321
228321 Stem Only

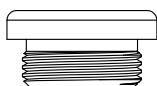

SEAT USED: 648180

LENGTH: 9.09"

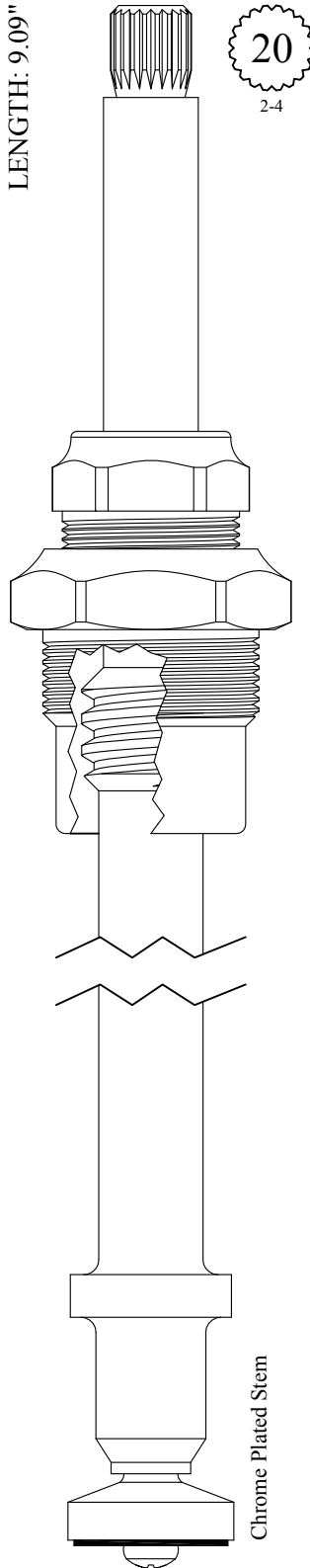

GASKET: 895450

428341
228341 Stem Only

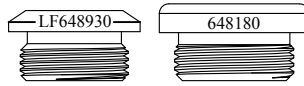

SEAT USED: LF648930 or 648180

LENGTH: 9.09"

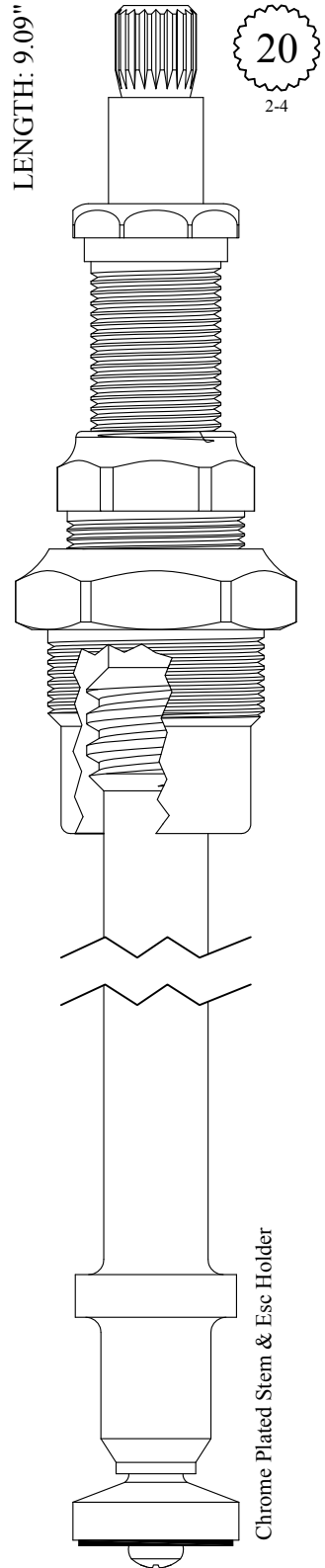

GASKET: 895450

428421
228421 Stem Only

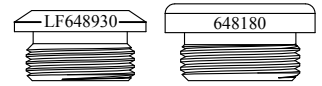

SEAT USED: LF648930 or 648180

Send Your Orders To:

BARRY E.  SR. CO.

E-mail: orderdesk@barrywalter.com

Fax: 1.800.886.9831

Phone: 1.800.767.5552

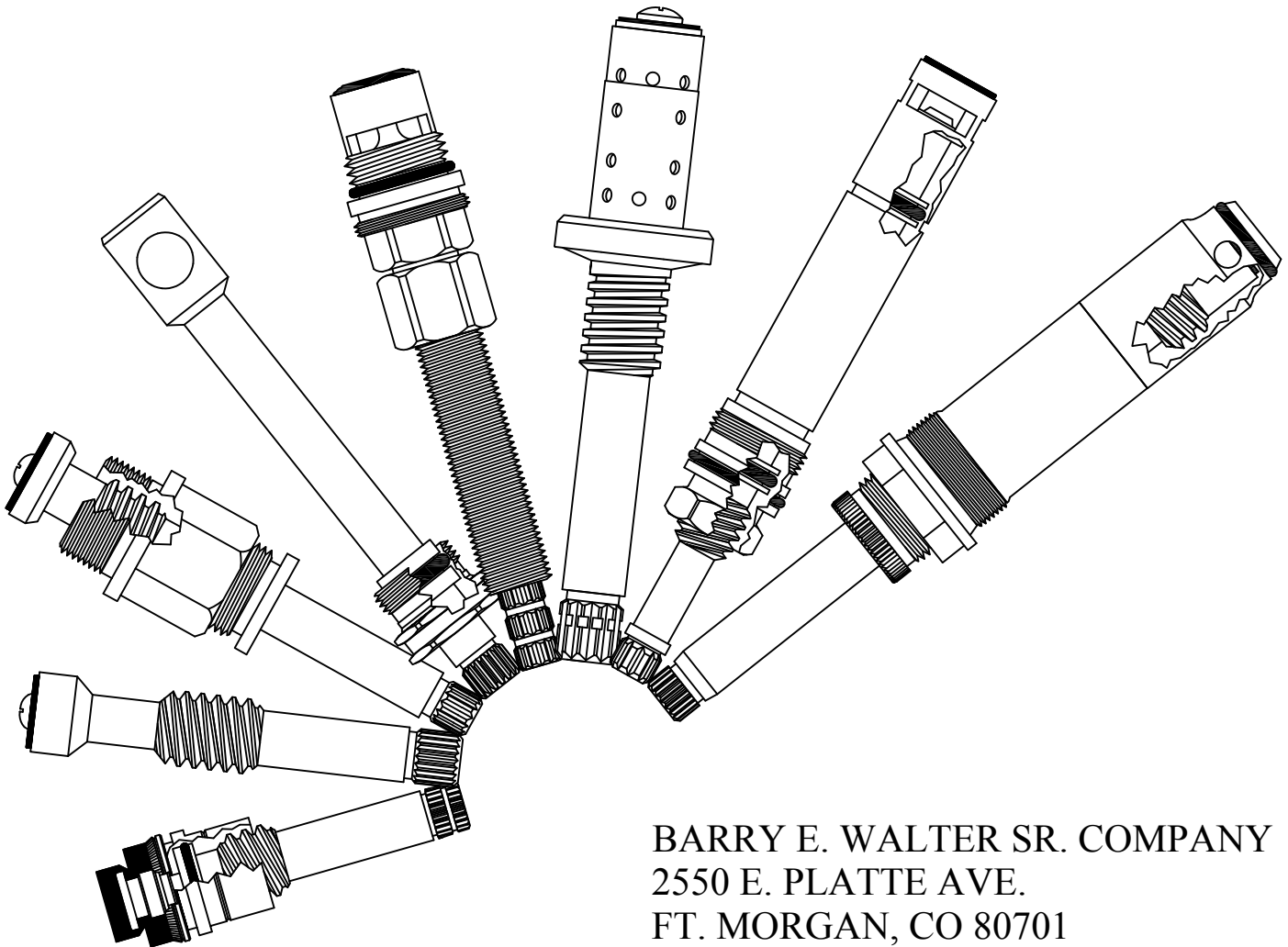

BARRY E. WALTER SR. COMPANY
2550 E. PLATTE AVE.
FT. MORGAN, CO 80701

FOR SPHINX

Chrome Plated Stem

LENGTH: 3.90"

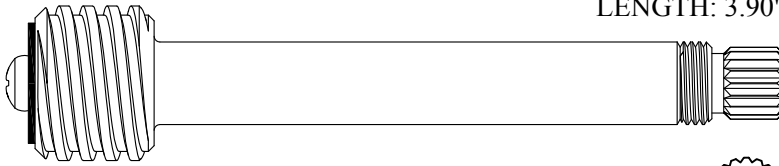

202221/ 202222

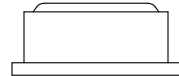

SEAT USED: LF649520



Chrome Plated Stem

LENGTH: 3.90"

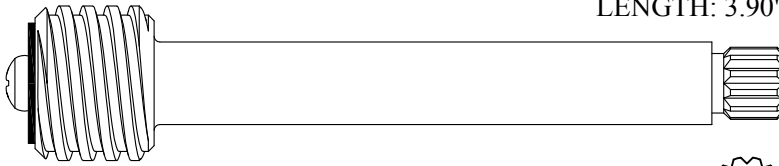

202271/ 202272

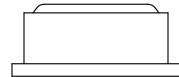

SEAT USED: LF649520



Chrome Plated Handle

LENGTH: 4.35"

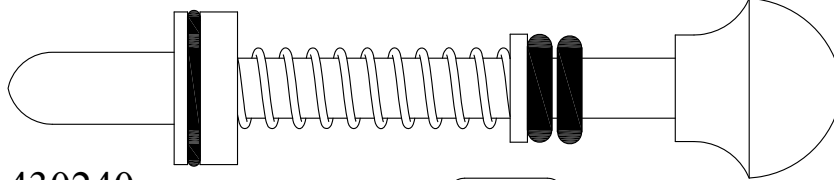

430240

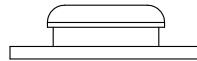

SEAT USED: LF649510

Chrome Plated Unit

LENGTH: 5.19"

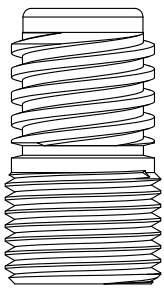

SEAT USED:
LF647941 FOR 416361
LF647942 FOR 416362

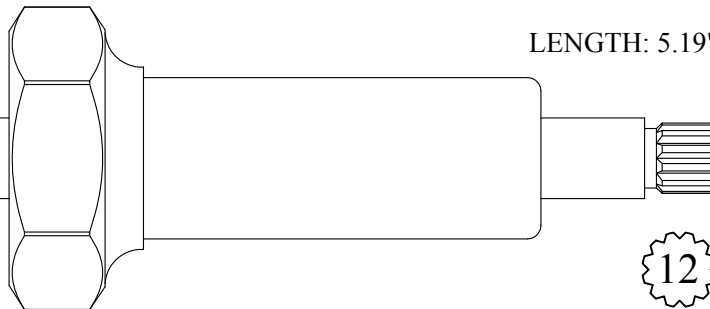
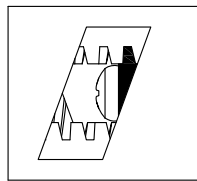

416361/ 416362
216361/ 216362 Stem Only



FOR SPHINX

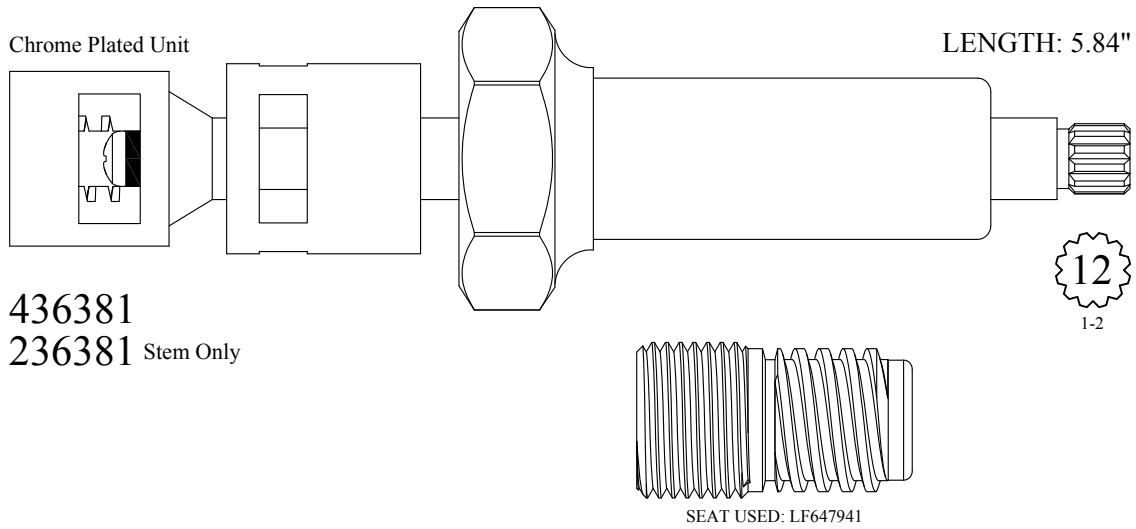

FOR SPRINGHOUSE

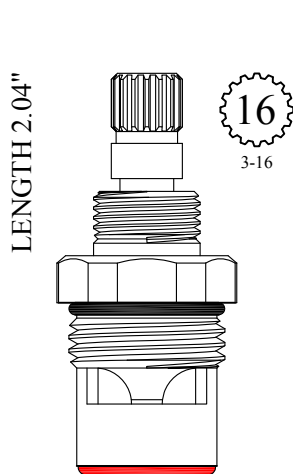

GASKET: 890170 O-RING INCLUDED
SEAL: 898580-R/B
DISC SET: 151380-PKG

LF459771
LF459772

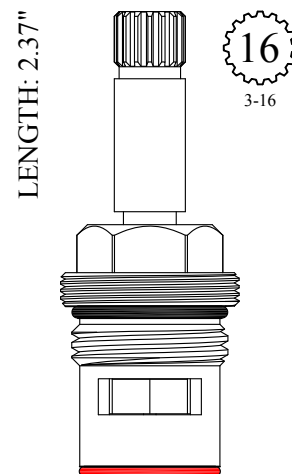

GASKET: 890170 O-RING INCLUDED
SEAL: 898580-R
DISC SET: 115520-PKG

LF462681
LF462682

FOR STANDARD SANITARY

SPECIAL ORDER ONLY
Many different variations
available

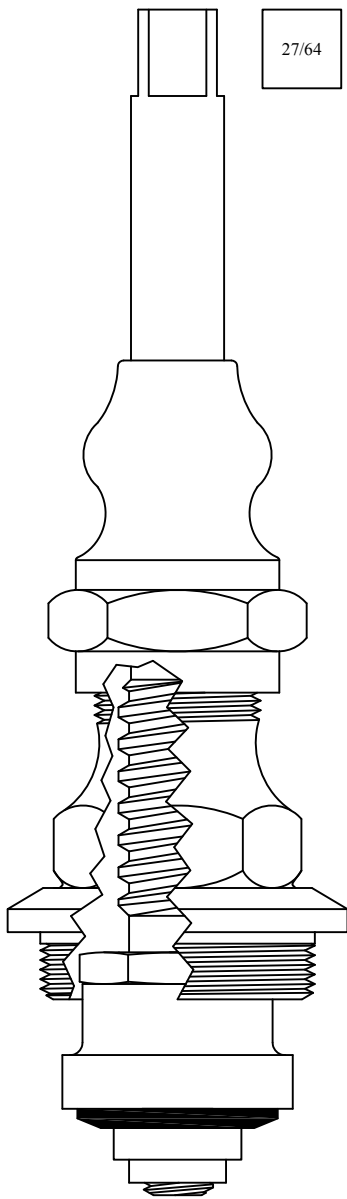

LENGTH: 6.21"

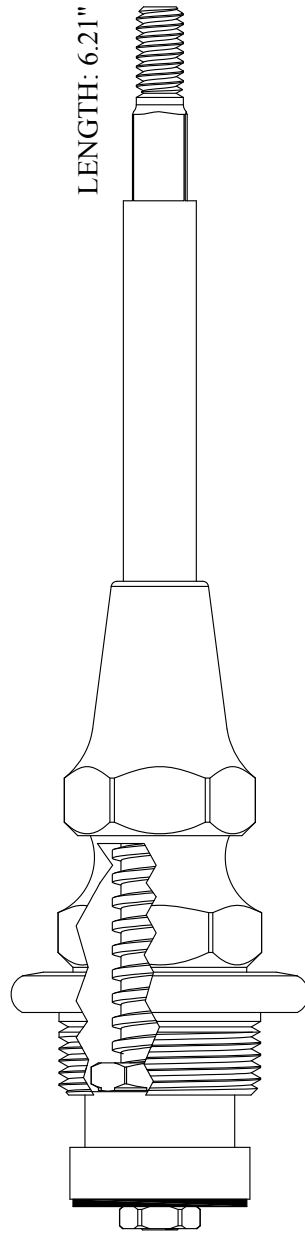

GASKET: 895440

427111

LENGTH: 7.74"

5/16

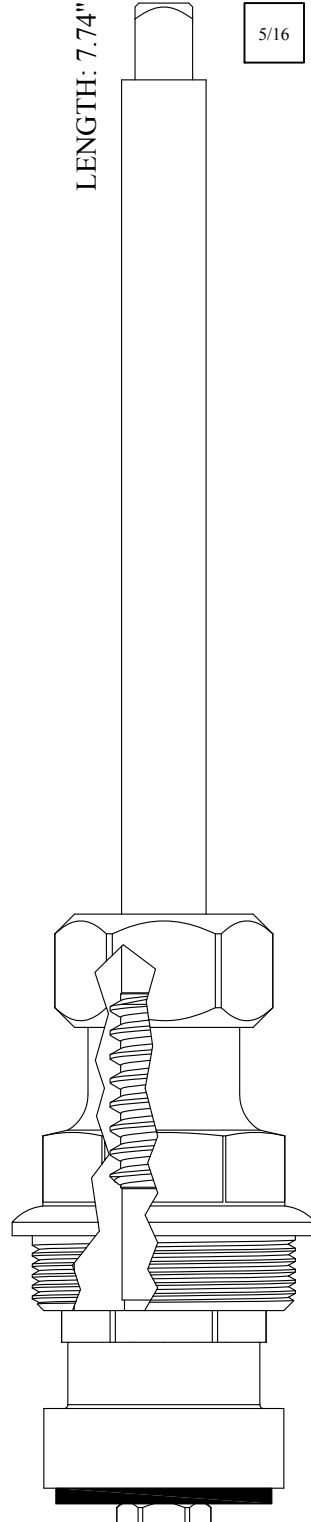

GASKET: 895500

427801

LENGTH: 7.74"

12

1-2

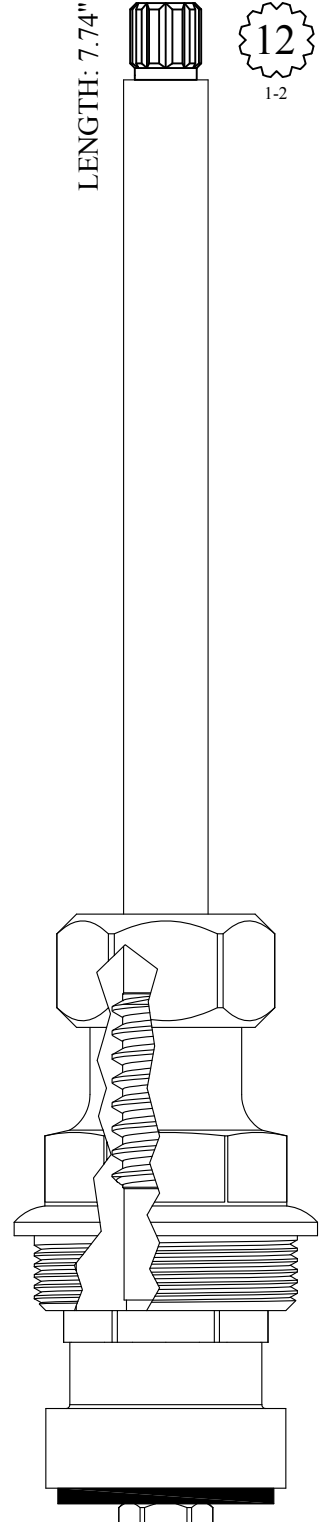

GASKET: 895500

427851

Send Your Orders To:

BARRY E.  SR. CO.

E-mail: orderdesk@barrywalter.com

Fax: 1.800.886.9831

Phone: 1.800.767.5552



Quality Replacement Parts

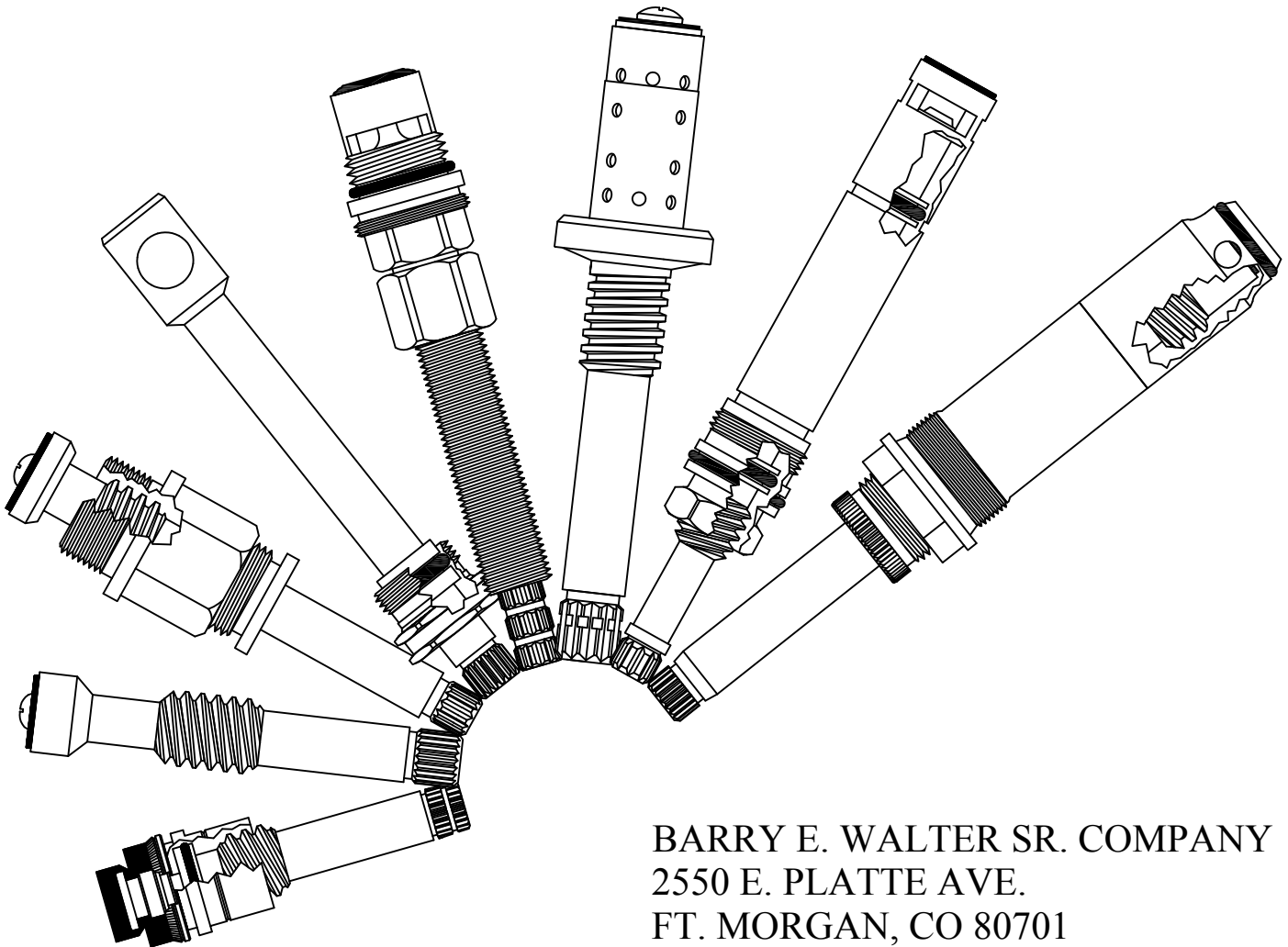

BARRY E. WALTER SR. COMPANY
2550 E. PLATTE AVE.
FT. MORGAN, CO 80701

FOR STERLING BRASS

Chrome Plated Stem

LENGTH: 2.40"

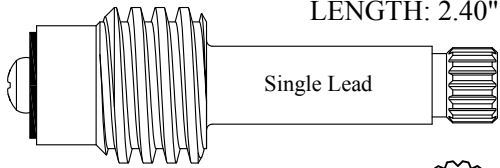

LF263511



Chrome Plated Stem

LENGTH: 2.40"

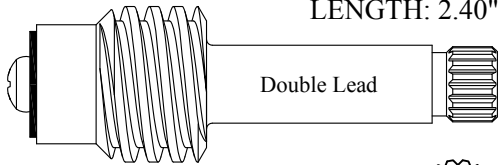

LF263521
LF263522



Chrome Plated Stem

LENGTH: 3.99"

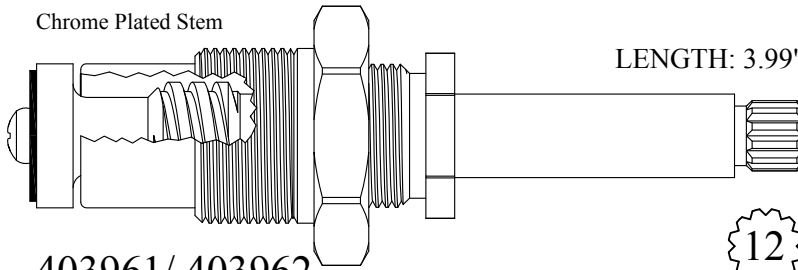

403961/ 403962
203961/ 203962 Stem Only
GASKET: 895370



Chrome Plated Unit

LENGTH: 4.65"

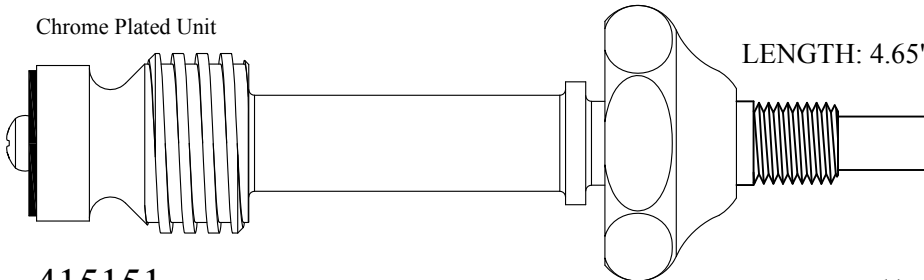

415151
215151 Stem Only

Supplied with
12pt. Broach

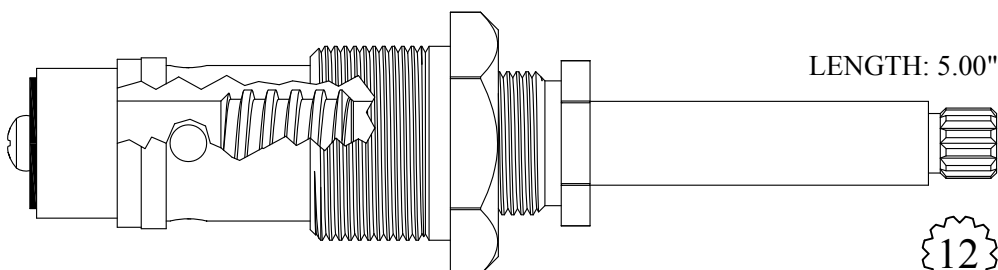

LENGTH: 5.00"

430812
GASKET: 895430



FOR STERLING BRASS

Chrome Plated Stem

LENGTH: 5.19"

416951 / 416952
216951 / 216952 Stem Only

GASKET: 895370

SEAT USED: LF649010

Supplied with 12pt. Broach

12
1-2

Chrome Plated Stem

LENGTH: 5.22"

419051
219051 Stem Only

GASKET: 895370

SEAT USED: LF649010

Supplied with 12pt. Broach

12
1-2

Chrome Plated Stem

LENGTH: 5.37"

419001
219001 Stem Only

GASKET: 895370

SEAT USED: LF649010

7/16 - 20 TPI

Chrome Plated Stem

LENGTH: 5.48"

426151
226151 Stem Only

Supplied with 12pt. Broach

12
1-2

FOR STERLING BRASS

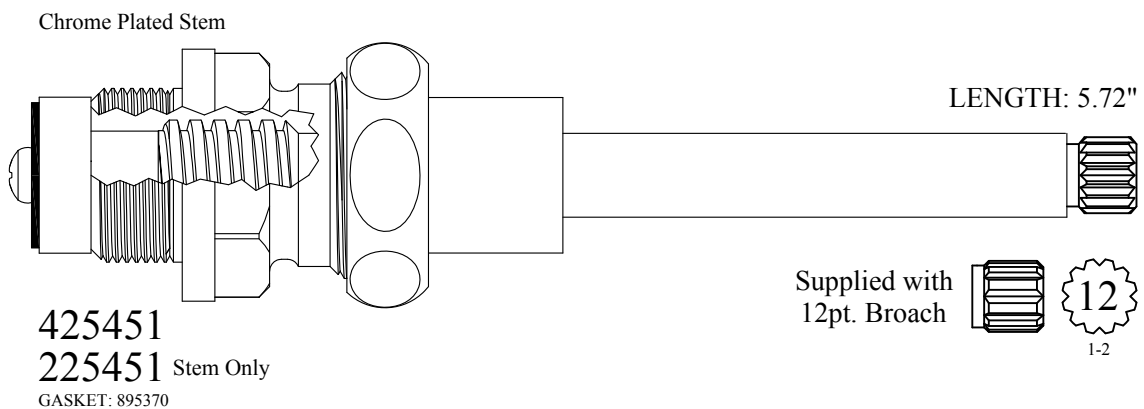
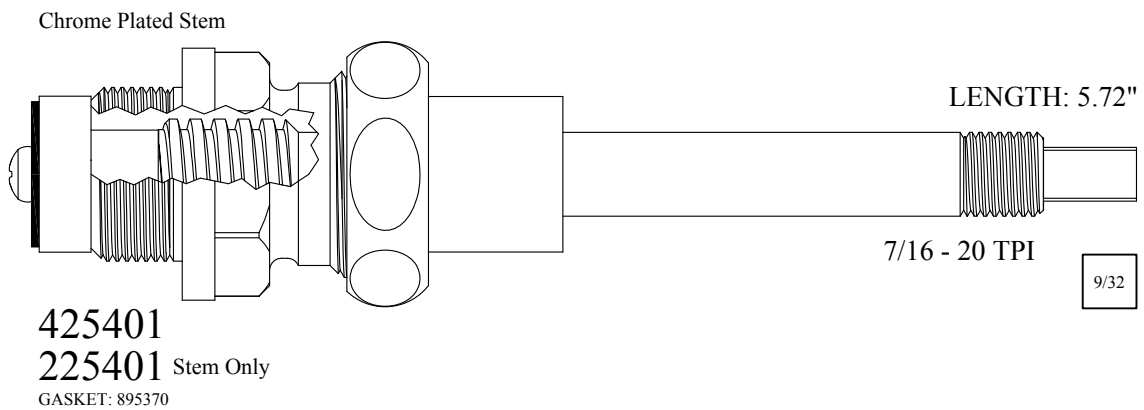
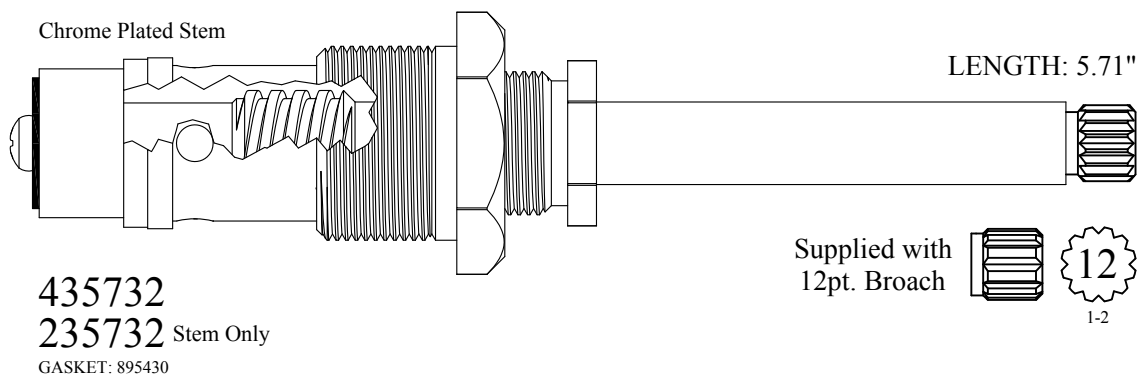
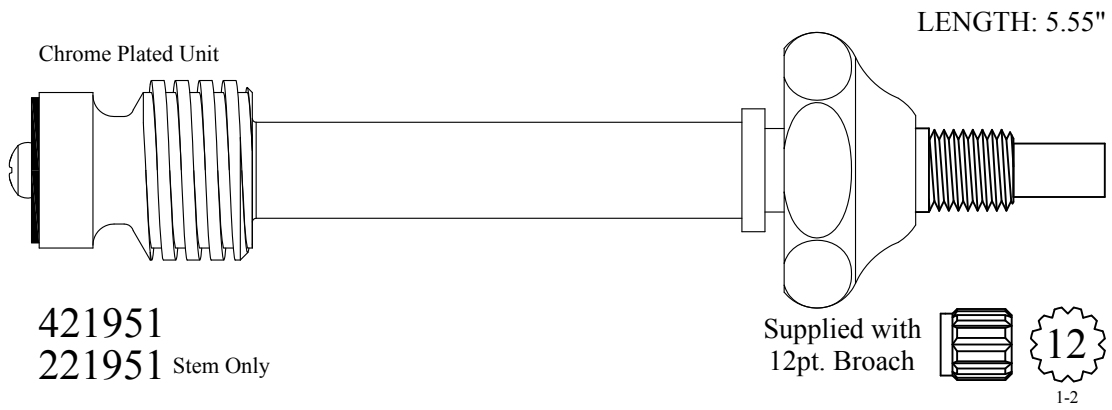

FOR STERLING BRASS

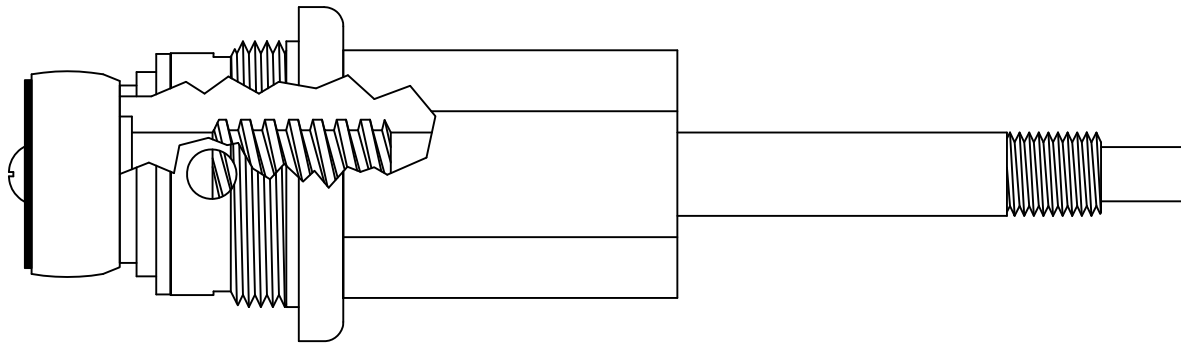
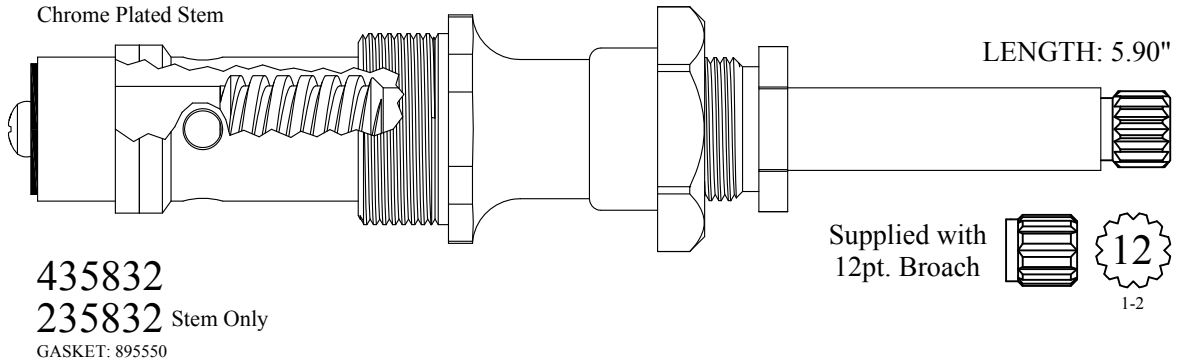

Not Available, Use 438101

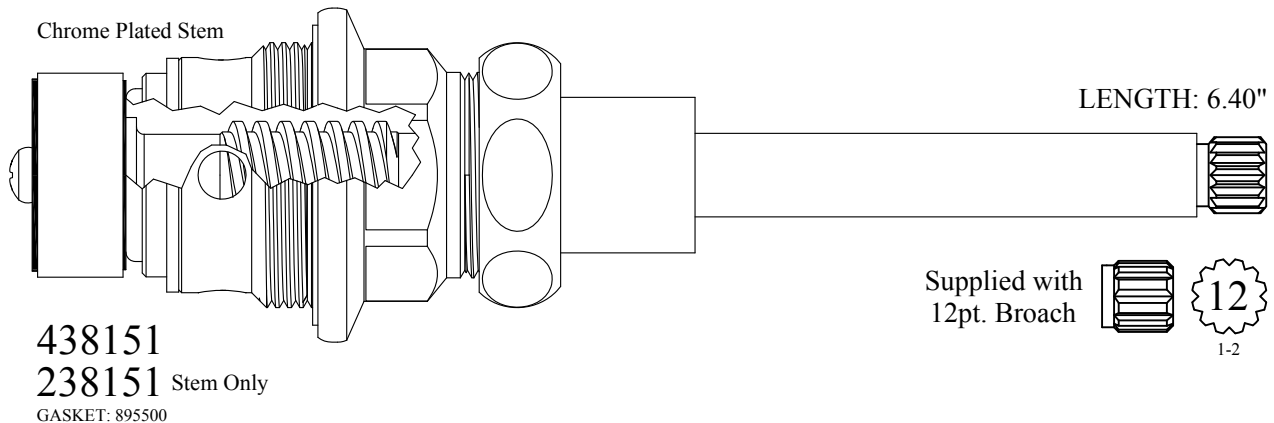
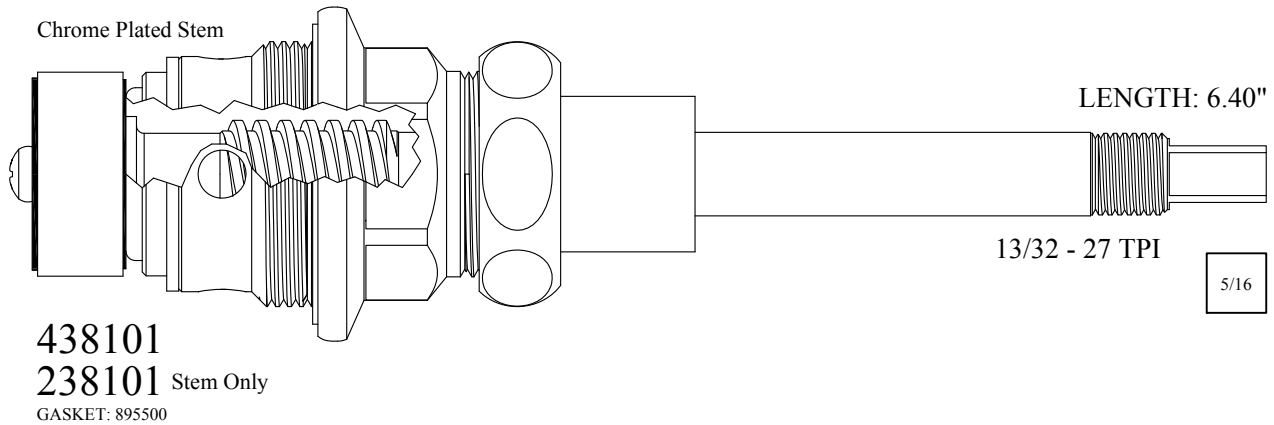

FOR STERLING FAUCET

LENGTH: 1.31"

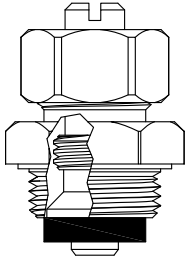

GASKET: 895110

400181

LENGTH: 1.37"

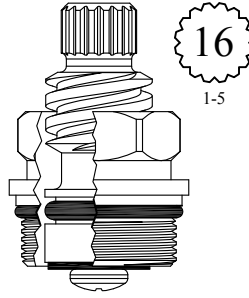

GASKET: 890180 O-RING INCLUDED

LF450401
LF450402

LENGTH: 1.46"

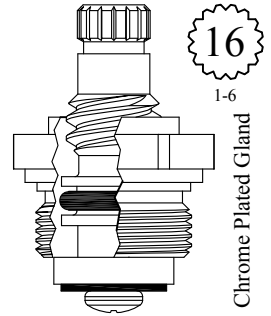

Chrome Plated Gland

400511
400512

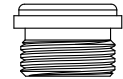

SEAT USED: LF648170

LENGTH: 1.54"

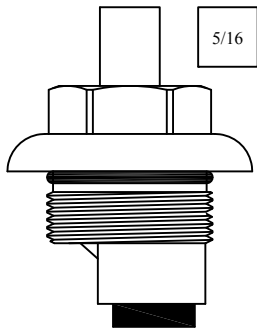

All Plastic Unit

GASKET: 890180 O-RING INCLUDED

452290

LENGTH: 1.55"

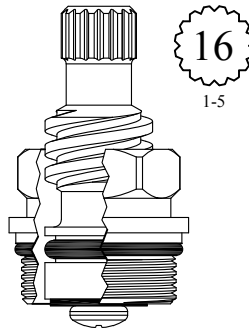

GASKET: 890180 O-RING INCLUDED

LF451401
LF451402

LENGTH: 1.56"

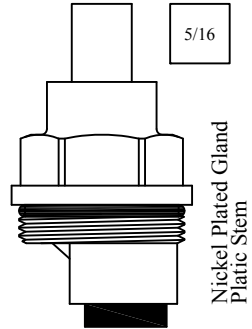

Nickel Plated Gland
Plastic Stem

GASKET: 890180 O-RING INCLUDED

LF452300
252300 Stem Only

LENGTH: 1.65"

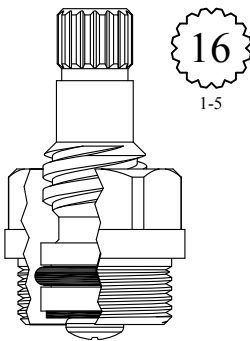

GASKET: 895160

LF452091
LF452092



SEAT USED: LF648170

LENGTH: 1.69"

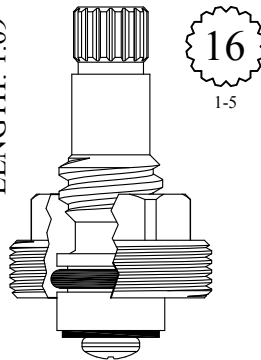

400711
400712



SEAT USED: LF648170

LENGTH: 1.74"

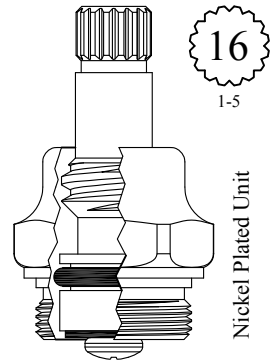

Nickel Plated Unit

GASKET: 895160

LF455131
LF455132



SEAT USED: LF648170

FOR STERLING FAUCET

LENGTH: 1.75"

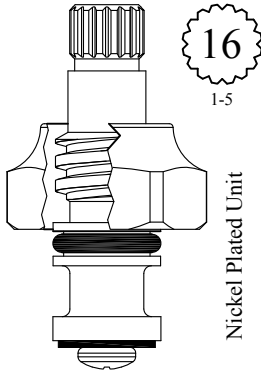

Nickel Plated Unit

LF454161
LF454162

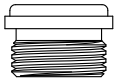

SEAT USED: LF648170

LENGTH: 1.75"

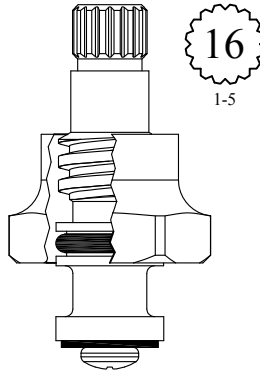

Also available as nickel plated unit

LF454111/ LF454112

454241
454242

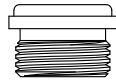

SEAT USED: LF648170

LENGTH: 1.75"

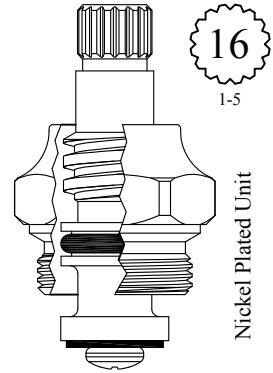

Nickel Plated Unit

GASKET: 895160

LF455031
LF455032

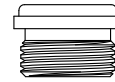

SEAT USED: LF648170

LENGTH: 1.75"

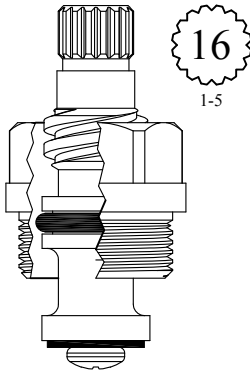

GASKET: 895160

LF455051
LF455052



SEAT USED: LF648170

LENGTH: 1.75"

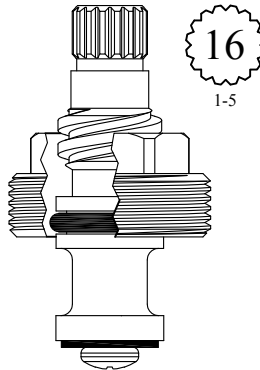

LF455071
LF455072



SEAT USED: LF648170

LENGTH: 1.77"

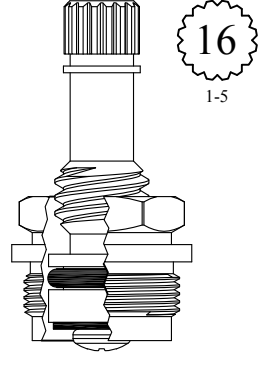

GASKET: 895160

LF452951
LF452952



SEAT USED: LF648170

FOR STERLING FAUCET

LENGTH: 1.78"

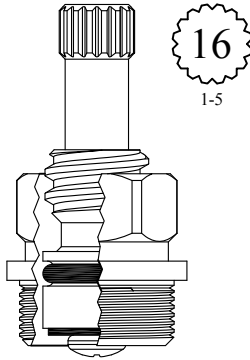

GASKET: 895160

LF453081
LF453082

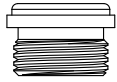

SEAT USED: LF648170

LENGTH: 1.94"

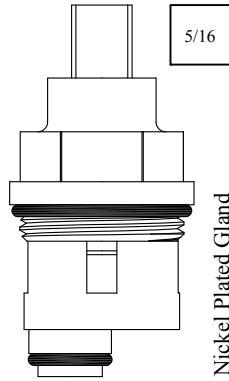

GASKET: 890180 O-RING INCLUDED

LF458171
LF458172

LENGTH: 2.00"

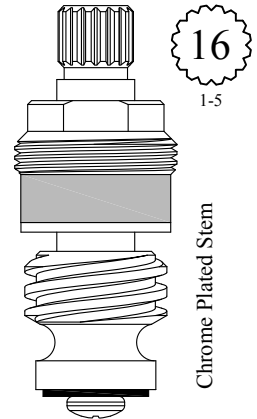

LF458091
LF458092

LF258091 Stem Only
LF458092 Stem Only

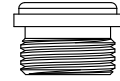

SEAT USED: LF648170

LENGTH: 2.03"

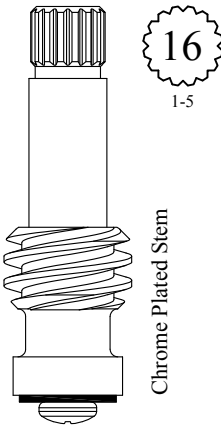

LF259071
LF259072



SEAT USED: LF648170

LENGTH: 2.13"

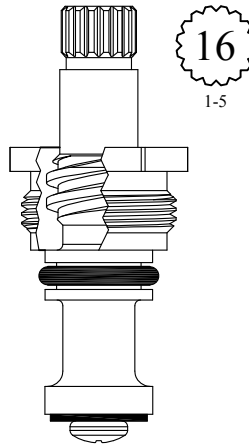

LF460101
LF460102

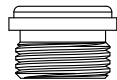

SEAT USED: LF648170

LENGTH: 2.18"

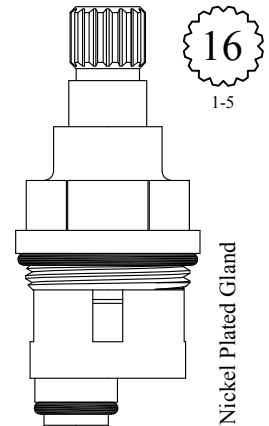

GASKET: 890180 O-RING INCLUDED

LF458181
LF458182

FOR STERLING FAUCET

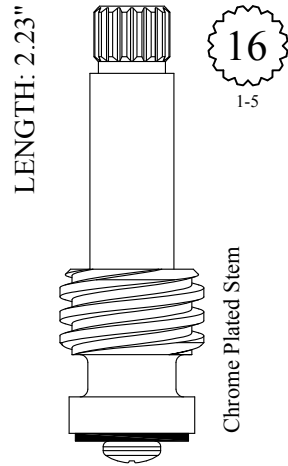

LF261051
LF261052

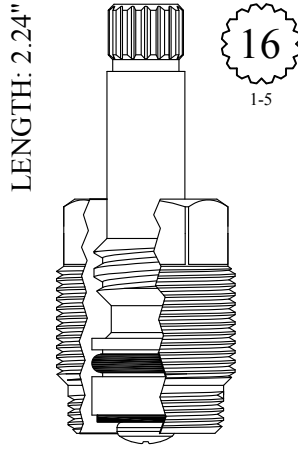

GASKET: 895160

401111
401112

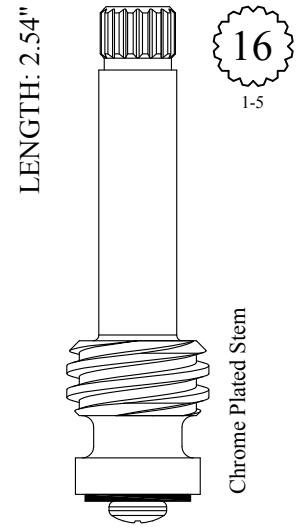

LF265011
LF265012

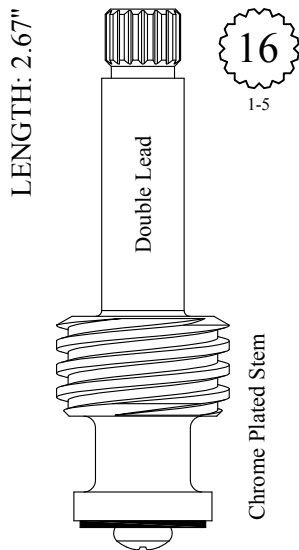

LF264861
LF264862

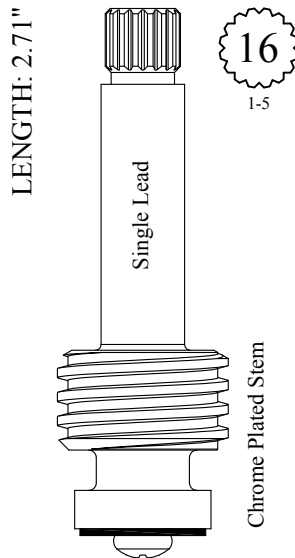

LF264871
LF264872

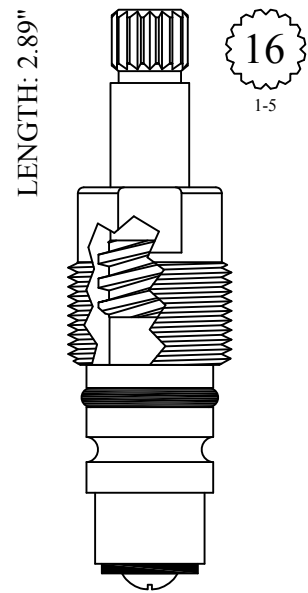

LF465621
LF465622

FOR STERLING FAUCET



LENGTH: 2.97"

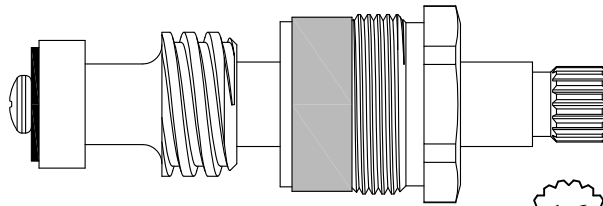

LF466061/ LF466062
LF266061/ LF266062 Stem Only



LENGTH: 2.98"

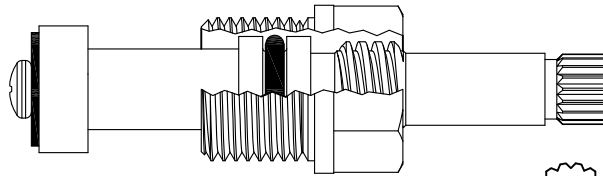

LF465631/ LF465632
GASKET: 895100



LENGTH: 3.03"

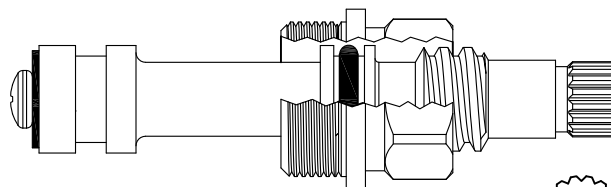

LF466111/ LF466112
GASKET: 895160

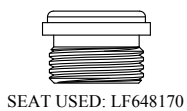

LENGTH: 3.29"

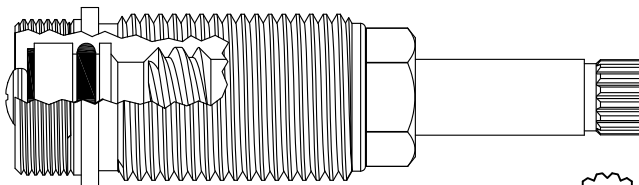

402411
GASKET: 895150



FOR STERLING FAUCET

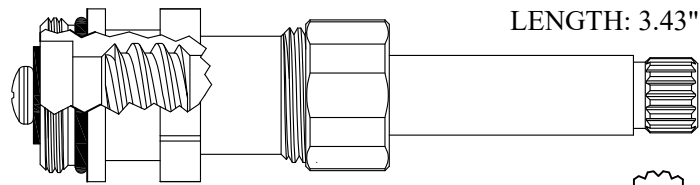

402821
GASKET: 890170 O-RING INCLUDED

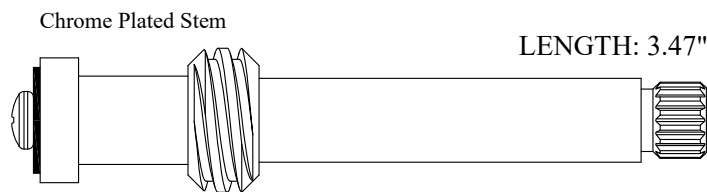

LF268161/ LF268162

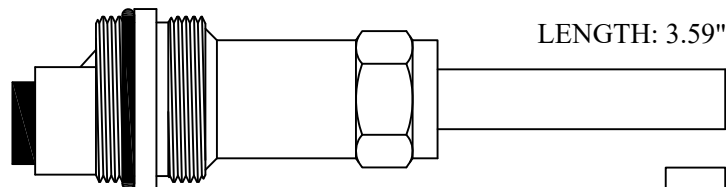

403220
203220 Stem Only
GASKET: 890190 O-RING INCLUDED

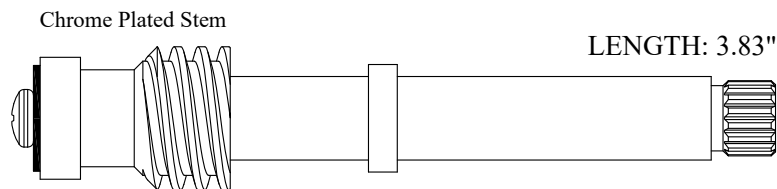

LF269041/ LF269042



FOR STERLING FAUCET

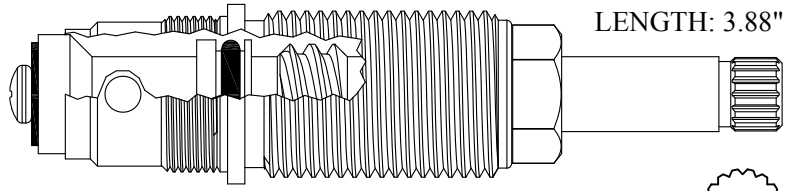

430181
GASKET: 895150

16
1-5

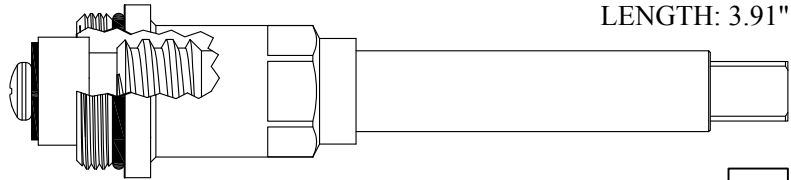

403931/ 403932
GASKET: 890170 O-RING INCLUDED

5/16

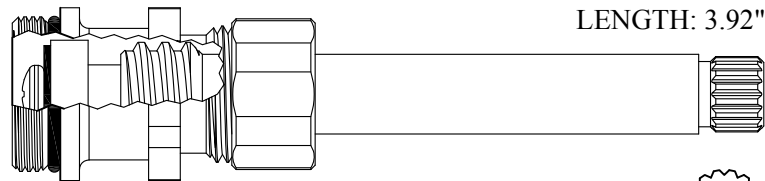

403331
GASKET: 890170 O-RING INCLUDED

16
1-5

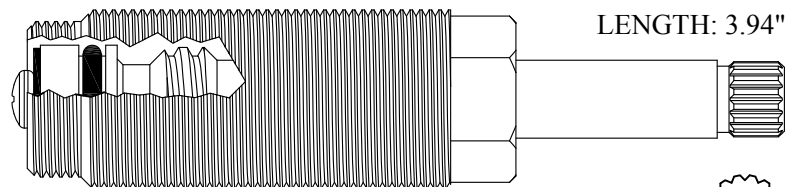

403511/ 403512
GASKET: 895150

16
1-5

FOR STERLING FAUCET

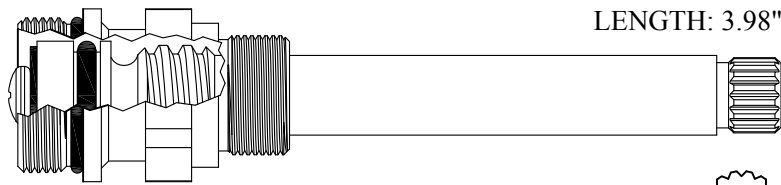

403921
GASKET: 890170 O-RING INCLUDED

16
1-5

Plastic Stem

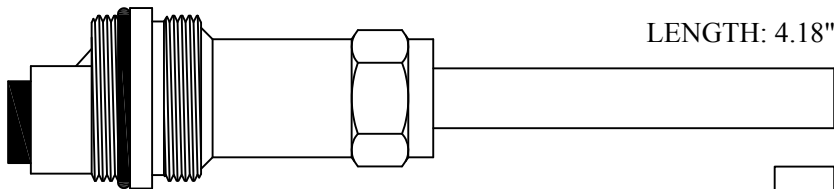

404810
204810 Stem Only
GASKET: 890190 O-RING INCLUDED

5/16

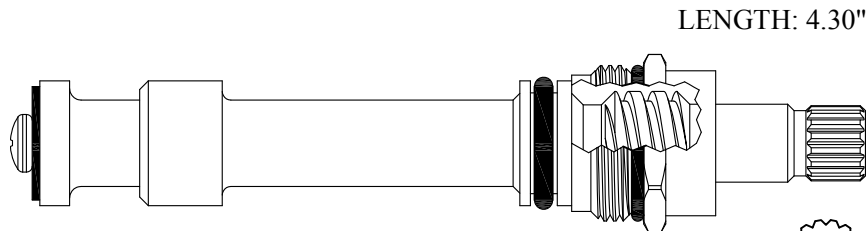

LF471001/ LF471002
GASKET: 890170 O-RING INCLUDED

16
1-5

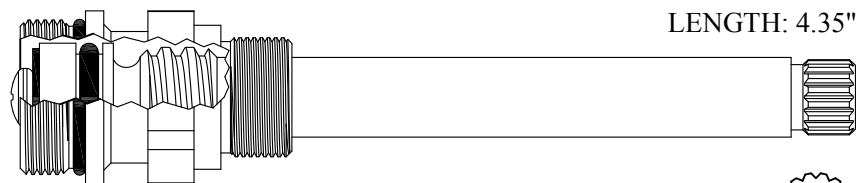

405181
GASKET: 890170 O-RING INCLUDED

16
1-5

FOR STERLING FAUCET

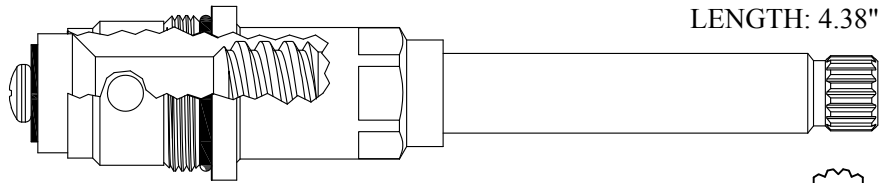

430231

GASKET: 890170 O-RING INCLUDED

16
1-5

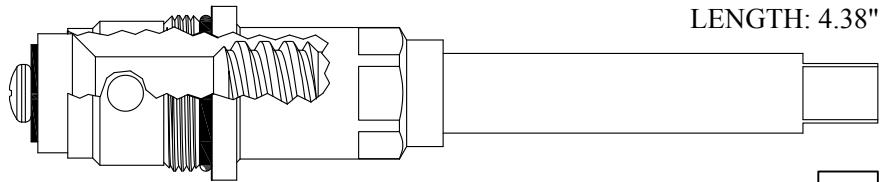

430261

GASKET: 890170 O-RING INCLUDED

5/16

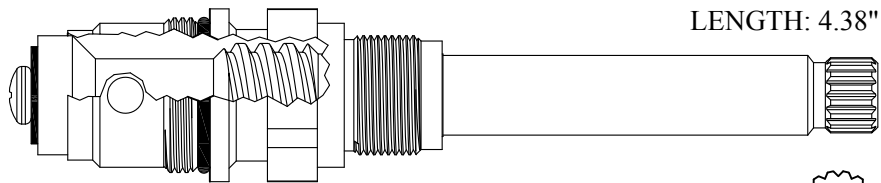

430291

GASKET: 890170 O-RING INCLUDED

16
1-5

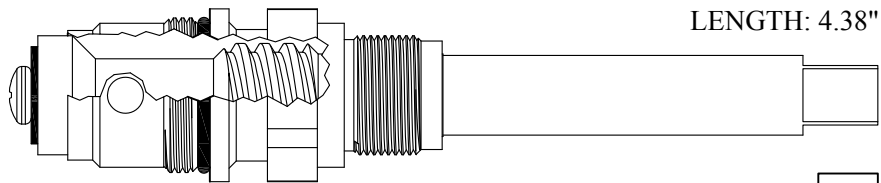

430421

GASKET: 890170 O-RING INCLUDED

5/16

FOR STERLING FAUCET

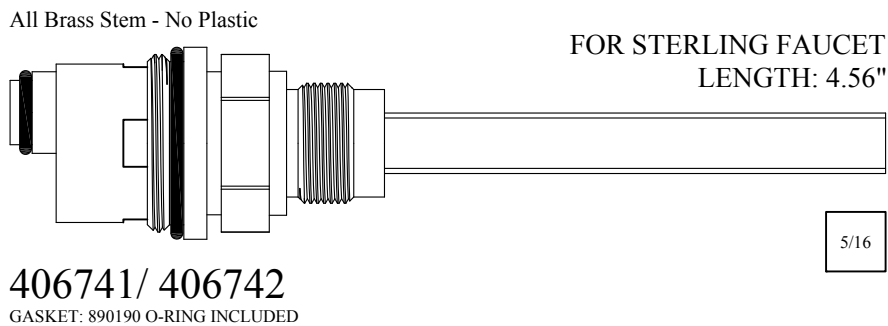
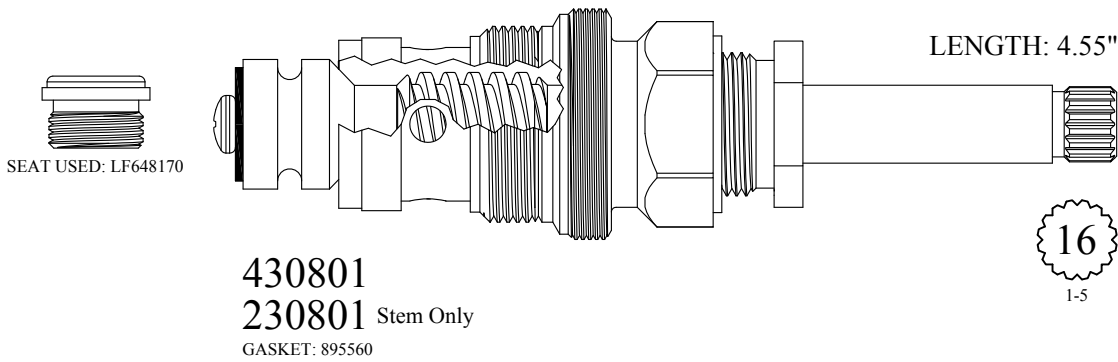
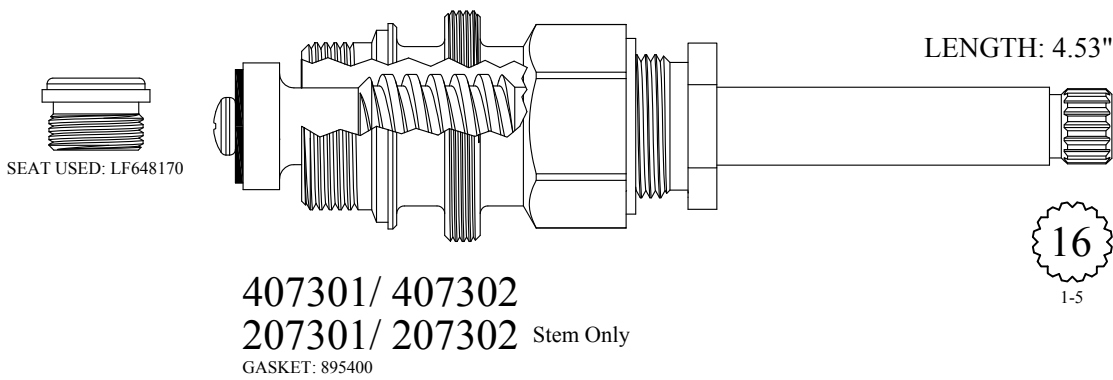
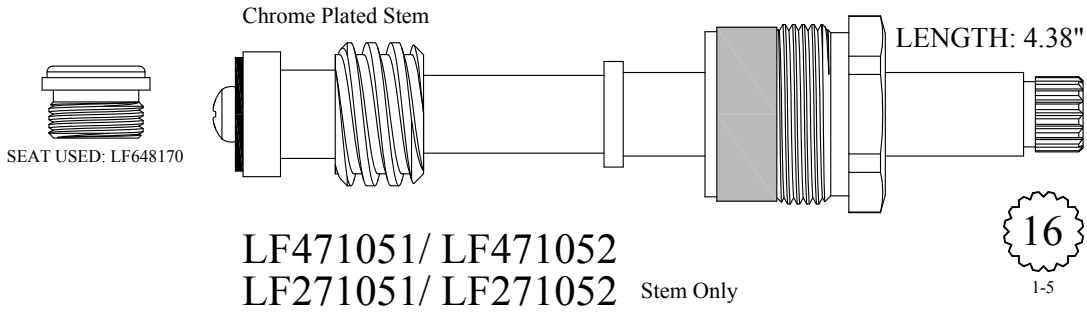

FOR STERLING FAUCET

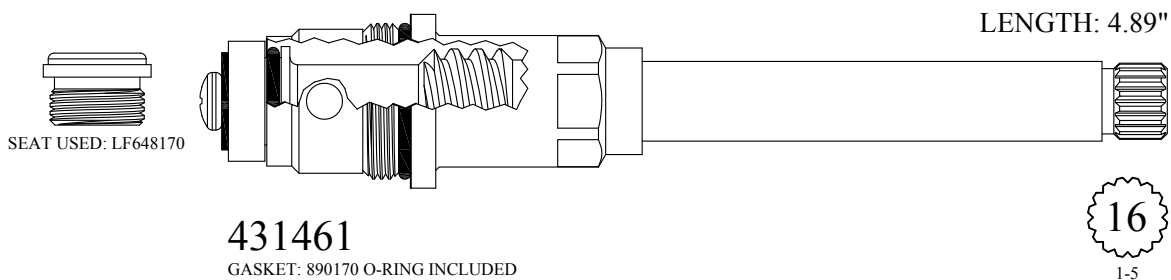
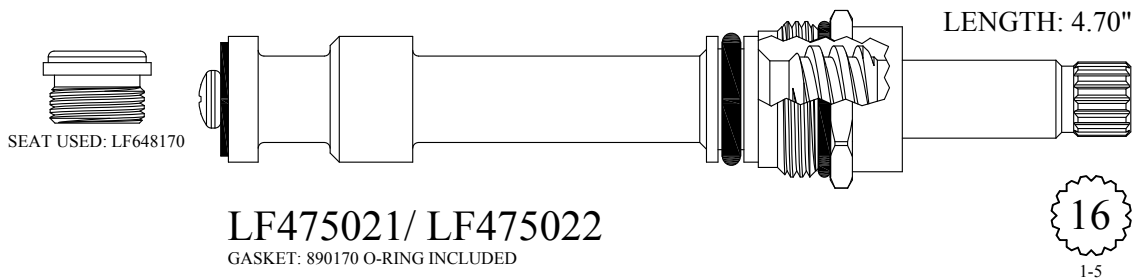
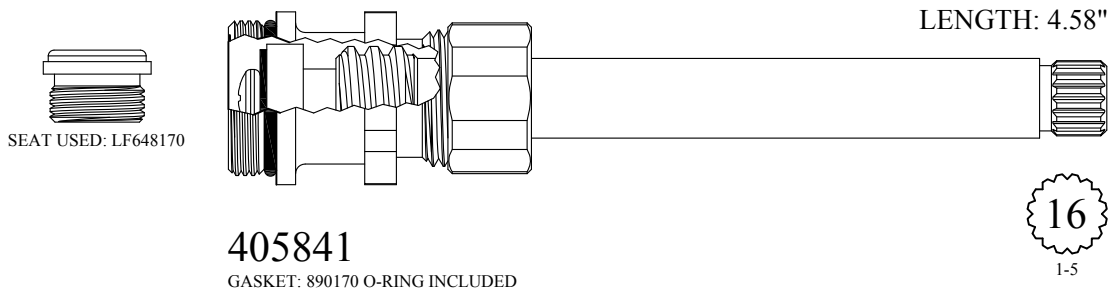
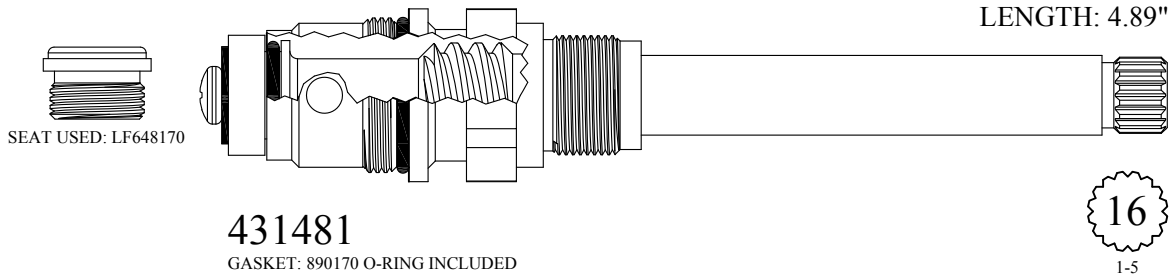

FOR STERLING FAUCET

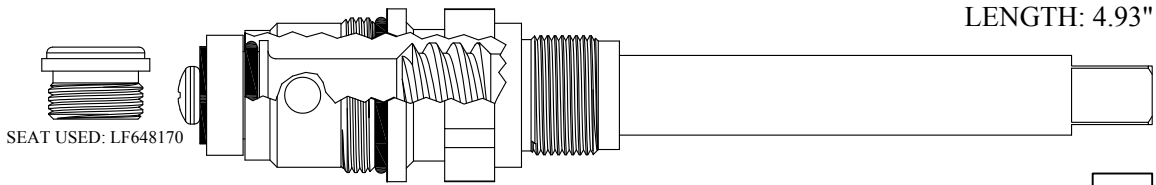

SEAT USED: LF648170

LENGTH: 4.93"

431471

GASKET: 890170 O-RING INCLUDED

5/16

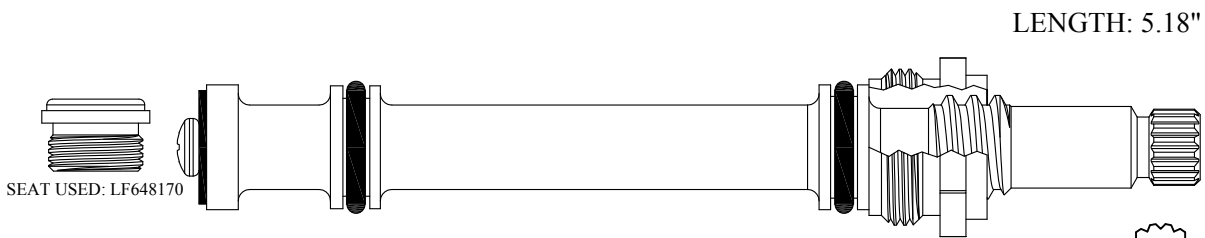

SEAT USED: LF648170

LENGTH: 5.18"

LF479601/ LF479602

16
1-5

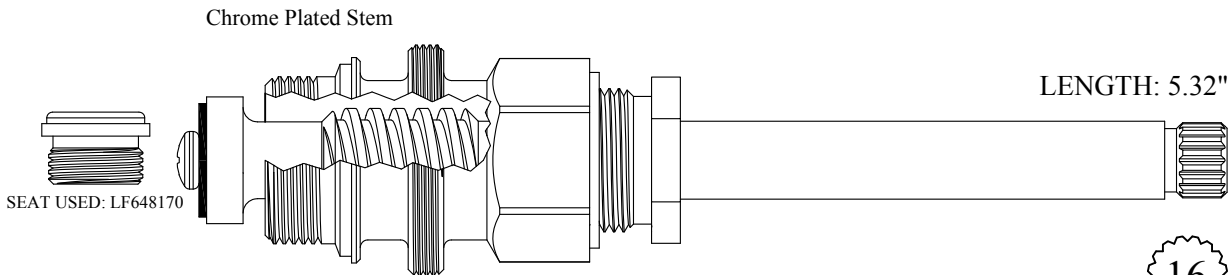

SEAT USED: LF648170

Chrome Plated Stem

LENGTH: 5.32"

418201

218201 Stem Only

GASKET: 895400

16
1-5

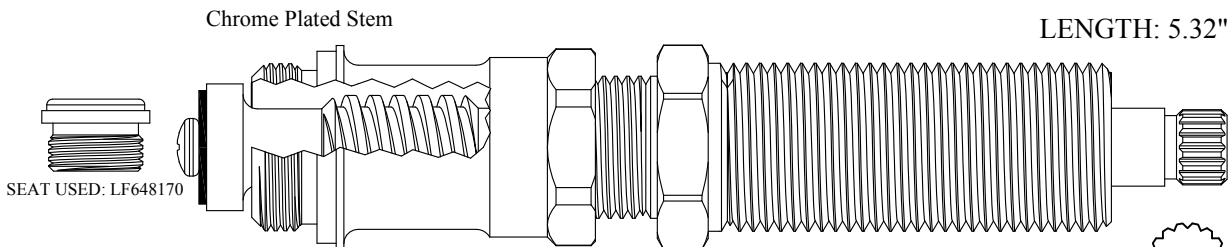

SEAT USED: LF648170

Chrome Plated Stem

LENGTH: 5.32"

418231

218201 Stem Only

GASKET: 895400

16
1-5

FOR STERLING FAUCET

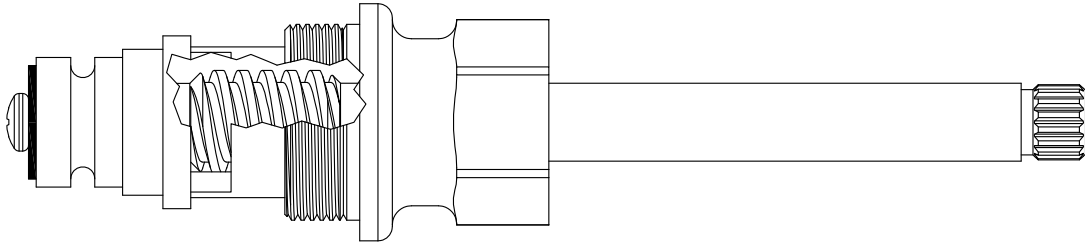

Not Available, Use 434001

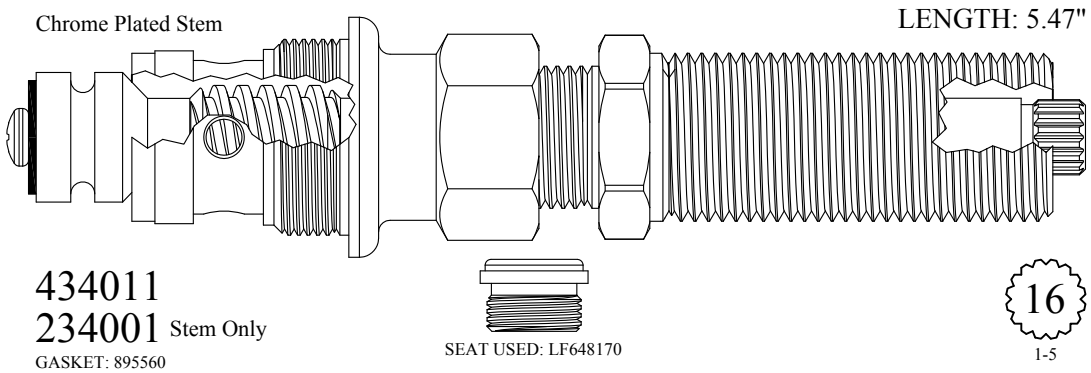
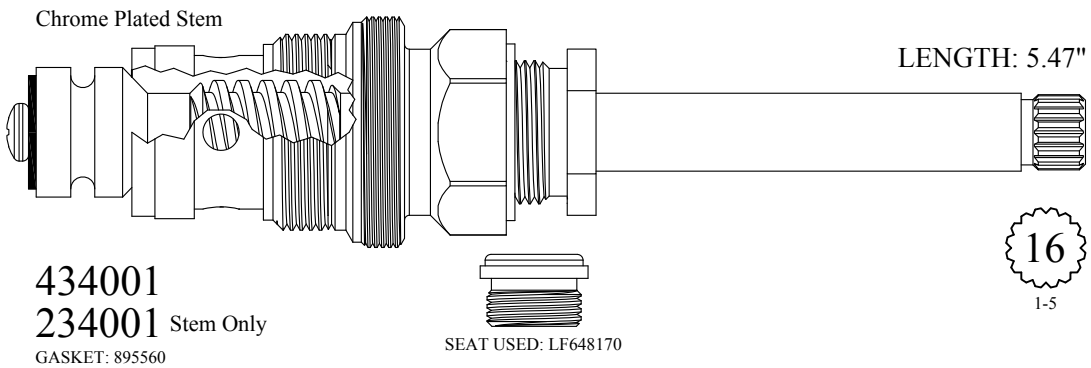

BARRY E.  WALTER  SR. CO.

FOR STREAMLINER

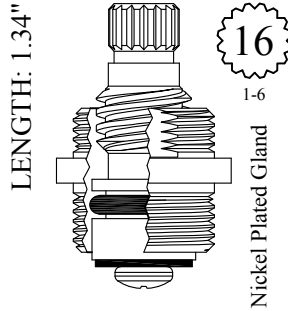

LENGTH: 1.34"

16

1-6

Nickel Plated Gland

GASKET: 895100

LF450131
LF450132

FOR STREAMWAY

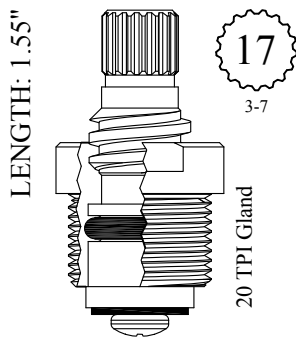

LENGTH: 1.55"

17

3-7

20 TPI Gland

GASKET: 895100

LF451161
LF451162



SEAT USED: LF649190

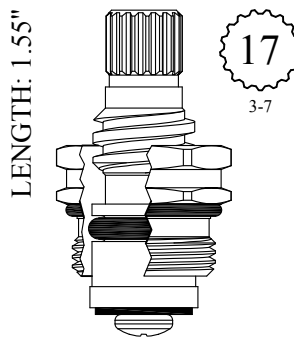

LENGTH: 1.55"

17

3-7

GASKET: 890170 O-RING INCLUDED

LF451171
LF251111 Stem Only



SEAT USED: LF649190

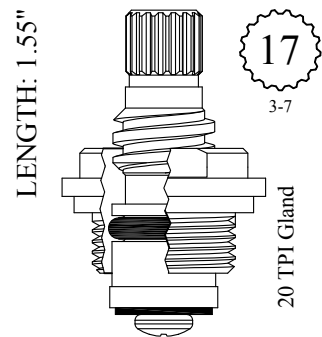

LENGTH: 1.55"

17

3-7

20 TPI Gland

GASKET: 895100

LF452171
LF452172



SEAT USED: LF649190

FOR STREAMWAY

LENGTH: 1.75"

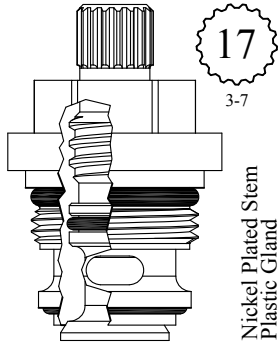

Nickel Plated Stem
Plastic Gland

GASKET: 891150 O-RING INCLUDED

LF454302

LENGTH: 1.88"

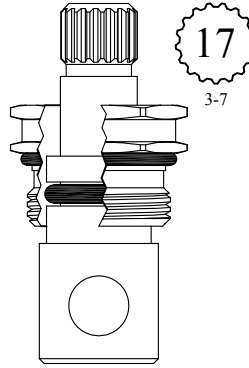

GASKET: 890170 O-RING INCLUDED

430010
230010 Stem Only

LENGTH: 1.97"

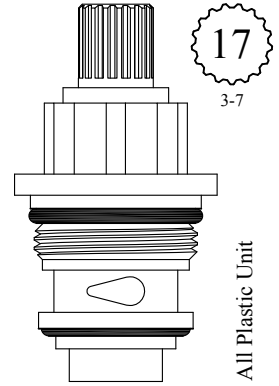

All Plastic Unit

GASKET: 891150 O-RING INCLUDED

454041
454042

LENGTH: 2.53"

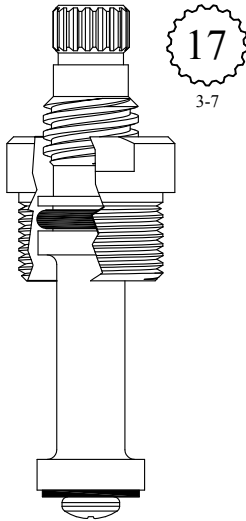

GASKET: 895100

LF464121
LF464122



SEAT USED: LF648040

LENGTH: 2.53"

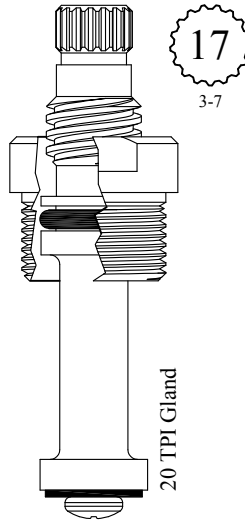

GASKET: 895100

LF464161
LF464162



SEAT USED: LF648040

LENGTH: 3.08"

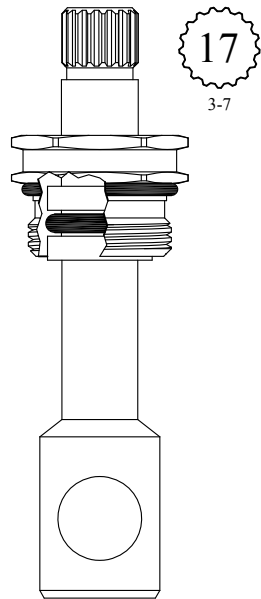

GASKET: 890170 O-RING INCLUDED

430050
230050 Stem Only

FOR STREAMWAY

Chrome Plated Stem

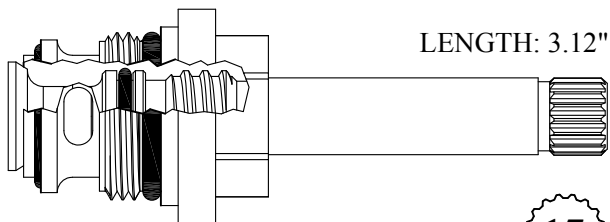

401832

GASKET: 891150 O-RING INCLUDED



18 TPI Gland

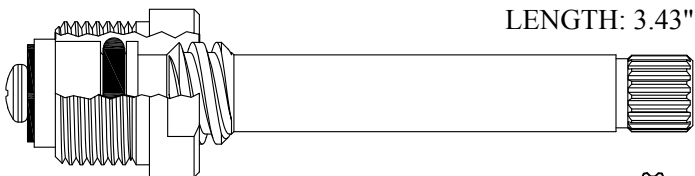

402711/ 402712

GASKET: 895100



20 TPI Gland

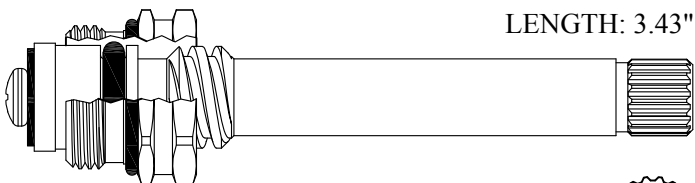

402721

GASKET: 895100



LENGTH: 3.48"

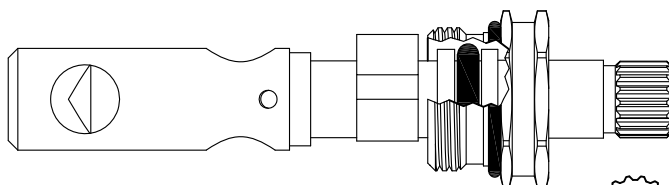

430060

230060 Stem Only

GASKET: 890170 O-RING INCLUDED



FOR STREAMWAY

LENGTH: 3.48"

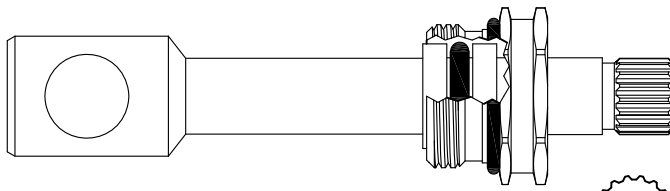

430080

230080 Stem Only

GASKET: 890170 O-RING INCLUDED

17

3-7

LENGTH: 4.49"

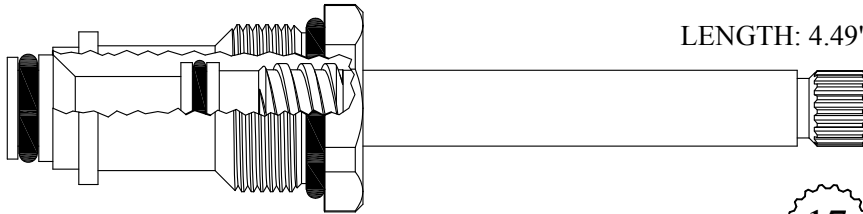

430521

GASKET: 891160 O-RING INCLUDED

17

3-7

LENGTH: 4.80"

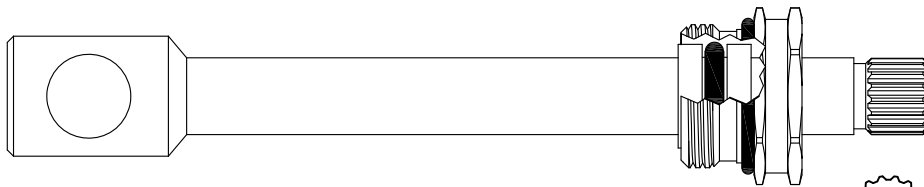

431310

231310 Stem Only

GASKET: 890170 O-RING INCLUDED

17

3-7

LENGTH: 4.95"

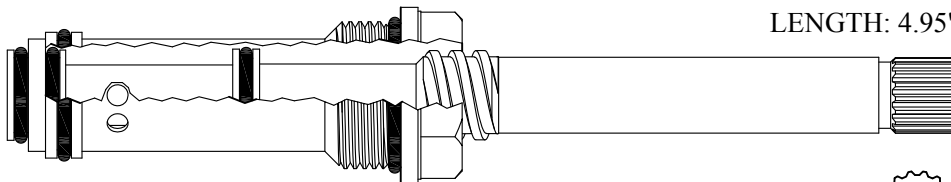

431821

GASKET: 890170 O-RING INCLUDED

17

3-7

LENGTH: 5.45"

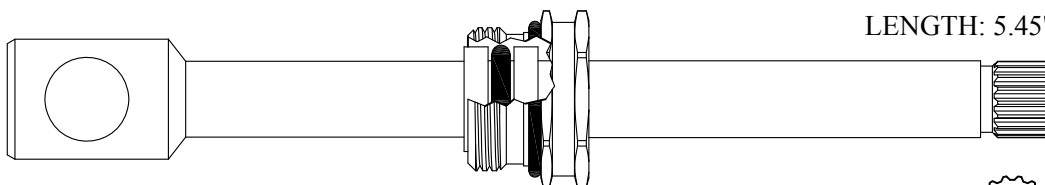

434810

234810 Stem Only

GASKET: 890170 O-RING INCLUDED

17

3-7

FOR SUNRISE / PRO PLUS

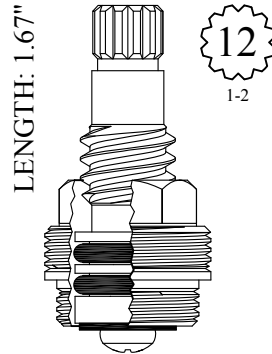

GASKET: 895100

LF453251
LF453252

FOR SUPER GRIF

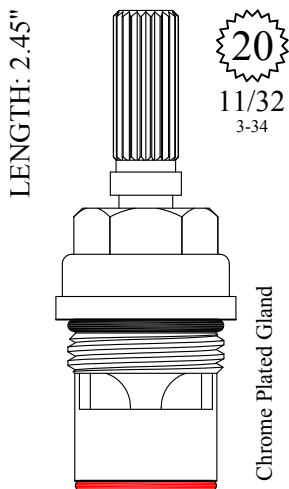

GASKET: 890170 O-RING INCLUDED
SEAL: 898580-R/B
DISC SET: 151380-PKG

LF463641
LF463642

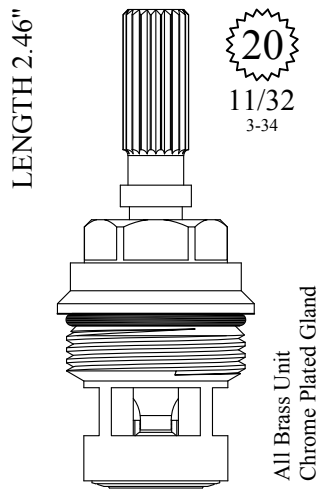

GASKET: 890190 O-RING INCLUDED
SEAL: 898510-W
DISC SET: 151380-PKG

LF463621
LF463622

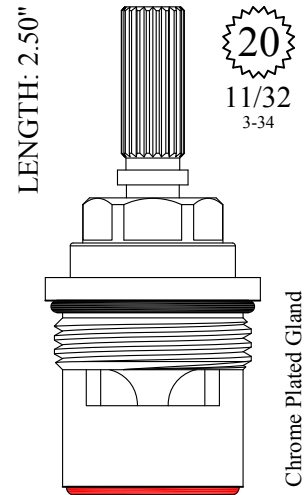

GASKET: 890210 O-RING INCLUDED
SEAL: 898610-R/B
DISC SET: 109850-PKG

401281
401282

Send Your Orders To:

BARRY E.  SR. CO.

E-mail: orderdesk@barrywalter.com

Fax: 1.800.886.9831

Phone: 1.800.767.5552



BRASS
AMERICA
Quality Replacement Parts

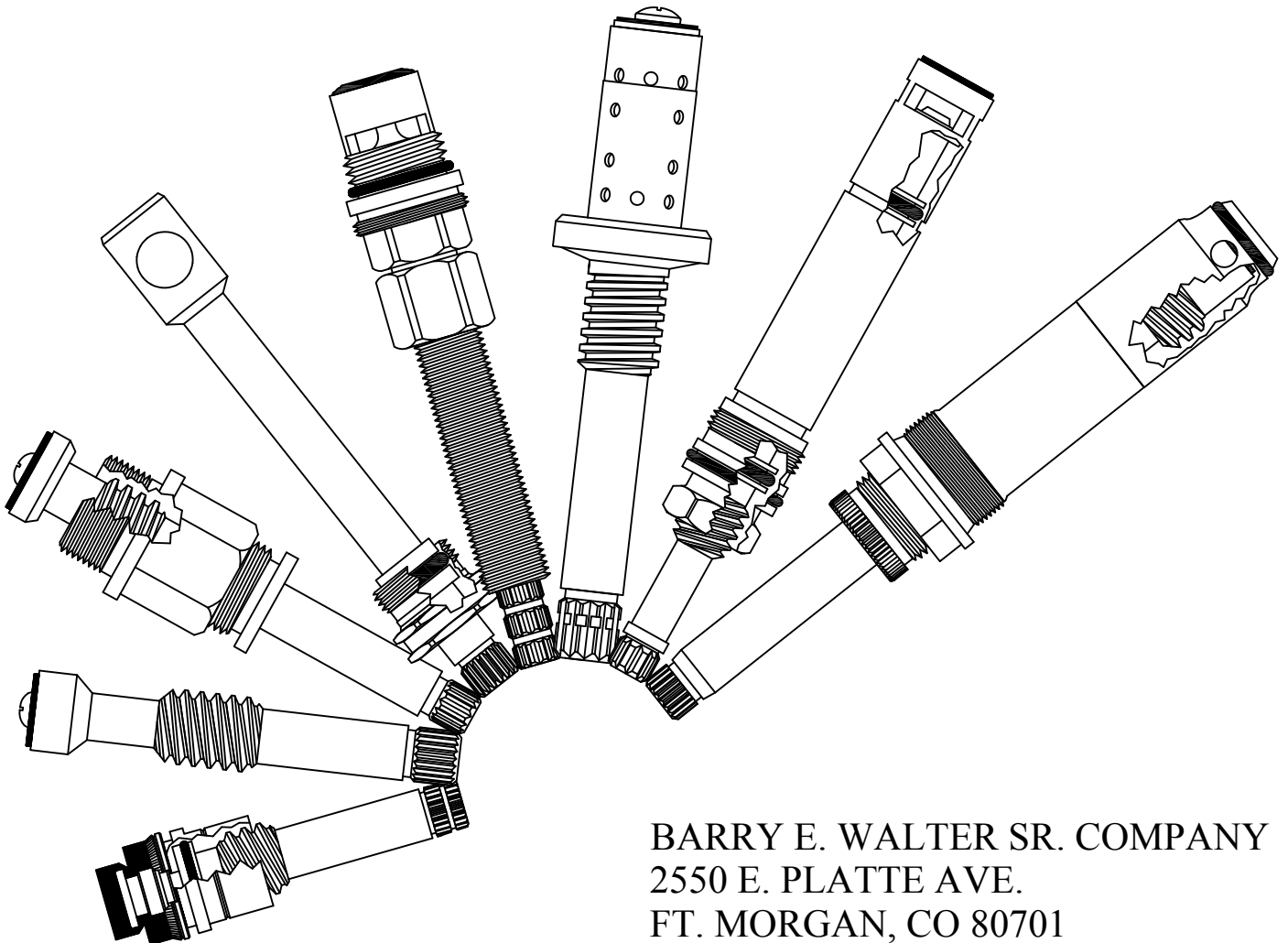

BARRY E. WALTER SR. COMPANY
2550 E. PLATTE AVE.
FT. MORGAN, CO 80701

FOR SYMMONS

LENGTH: 1.75"

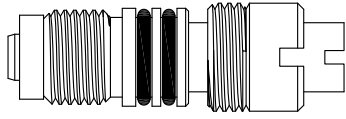

400661
200661 Stem Only

Chrome Plated Push Button

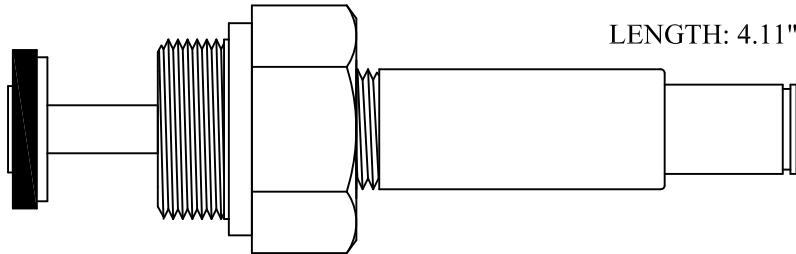

LENGTH: 4.11"

430360
 GASKET: 895350 INCLUDED

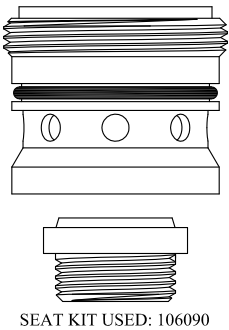

SEAT KIT USED: 106090

205511 Stem Only
 GASKET: 895500 INCLUDED

Bonnet Only
705511

LENGTH: 4.27"

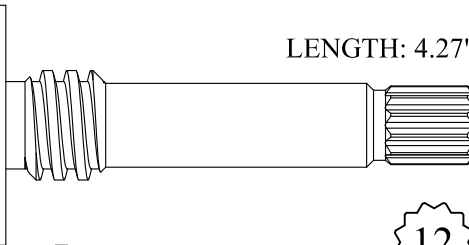

12

Symmons Small

Complete unit
 also available
405511

Chrome Plated Push Button

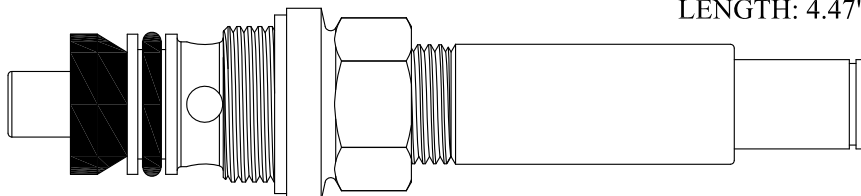

LENGTH: 4.47"

430720
 GASKET: 895150 INCLUDED

FOR SYMMONS

Chrome Plated Shank & Pkg Nut

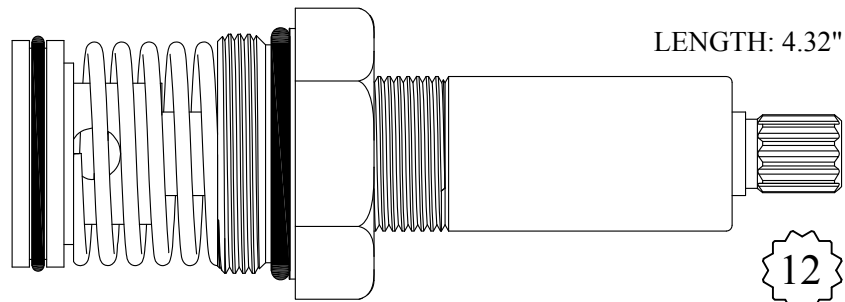

431160
231160 Stem Only
GASKET: 891220 O-RING INCLUDED

12

Symmons Small

Chrome Plated Shank & Pkg Nut

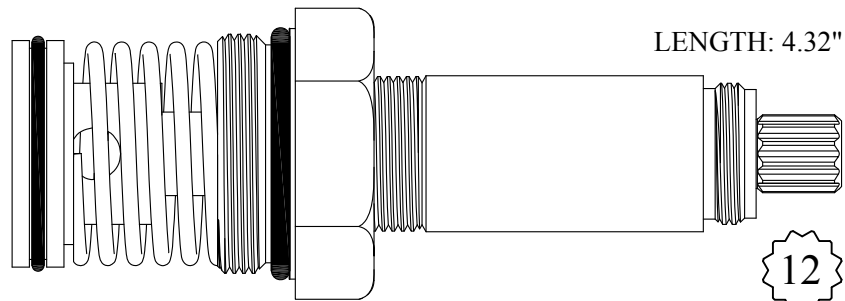

431170
231160 Stem Only
GASKET: 891220 O-RING INCLUDED

12

Symmons Small

Chrome Plated Shank

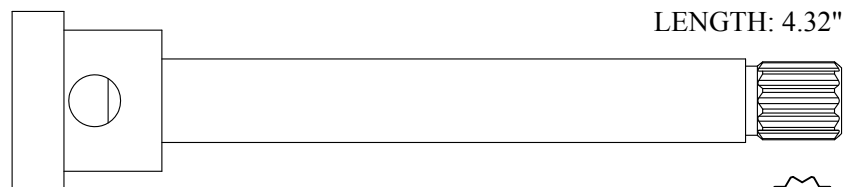

231640

12

Symmons Small

FOR SYMMONS

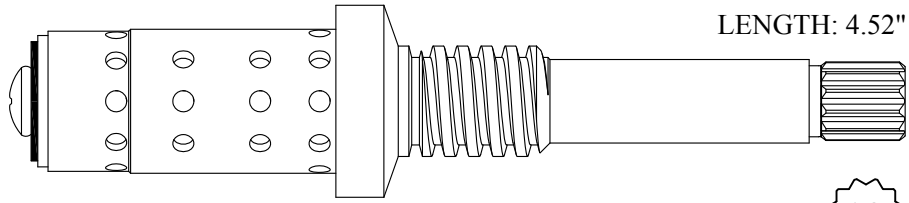
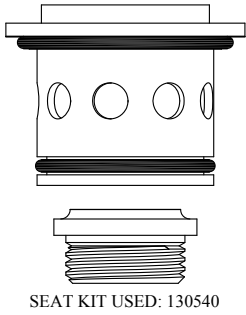

207231

12

Symmons Small

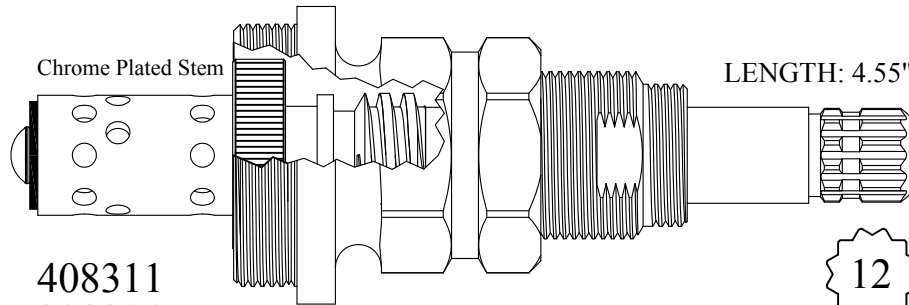
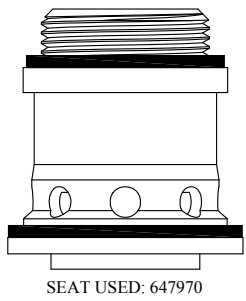

408311
208311 Stem Only
GASKET: 895500

12

Symmons Large

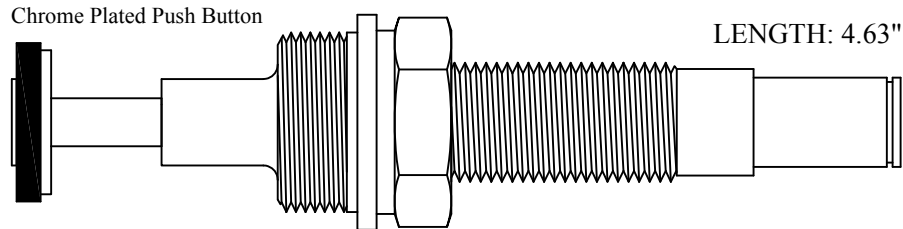

430830
GASKET: 895350 INCLUDED

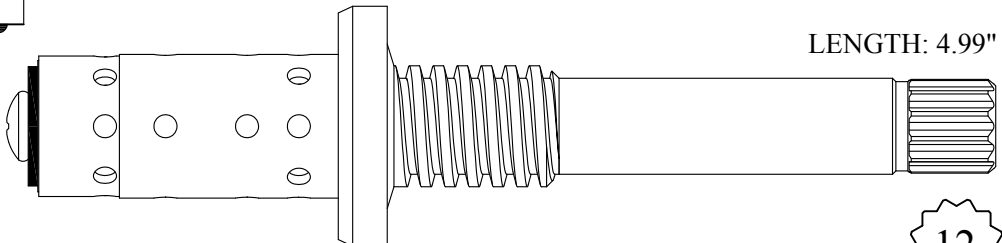
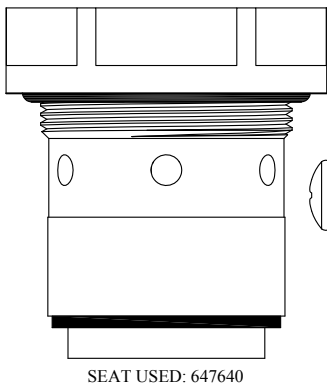

212111

12

Symmons Large

FOR SYMMONS

Chrome Plated Gland & Push Button

LENGTH: 5.12"

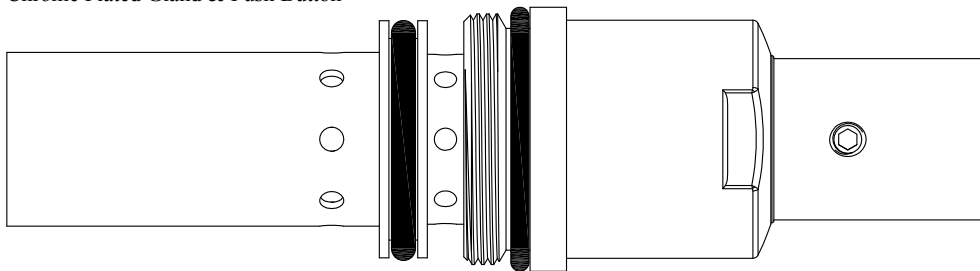

415410

Chrome Plated Stem

LENGTH: 5.12"

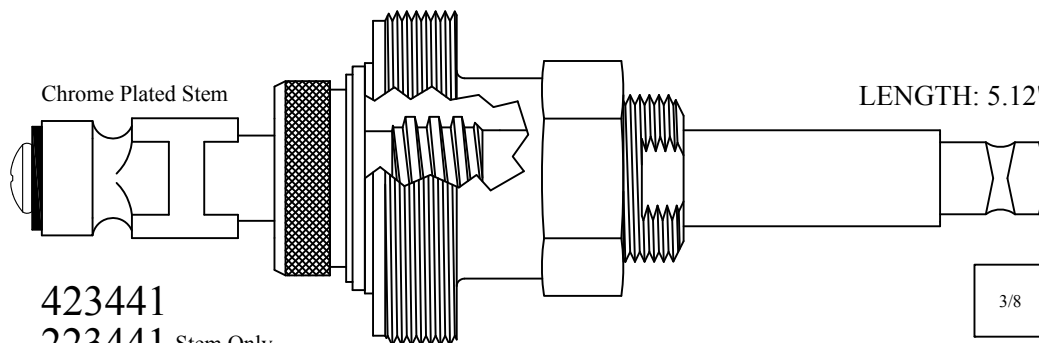

423441

223441 Stem Only

3/8

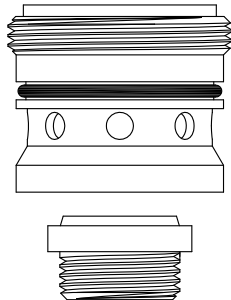

SEAT KIT USED: 106090

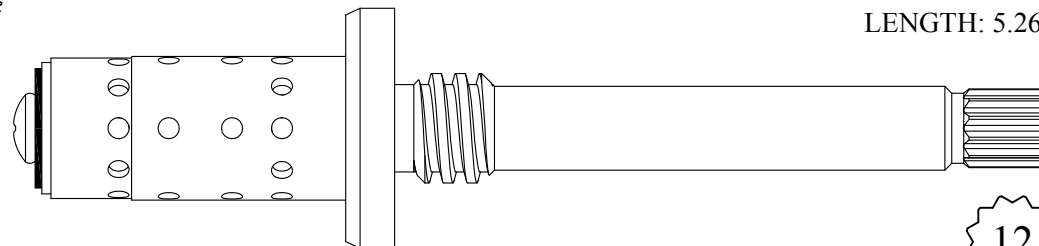

LENGTH: 5.26"

217701 Stem Only

GASKET: 895500 INCLUDED

12

Symmons Large

Also available with
bonnet assembly

#717701

417701

Chrome Plated Stem

LENGTH: 5.29"

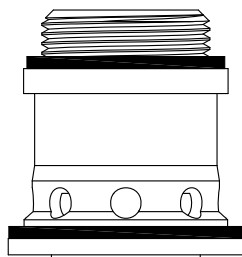

SEAT USED: 647970

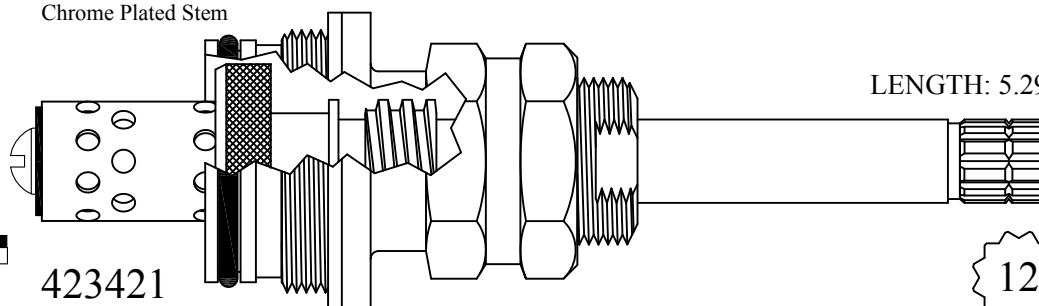

423421

223421 Stem Only

GASKET: 895500 INCLUDED

12

Symmons Large

FOR SYMMONS

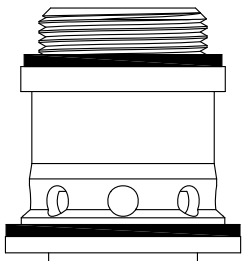

SEAT USED: 647970

Chrome Plated Stem

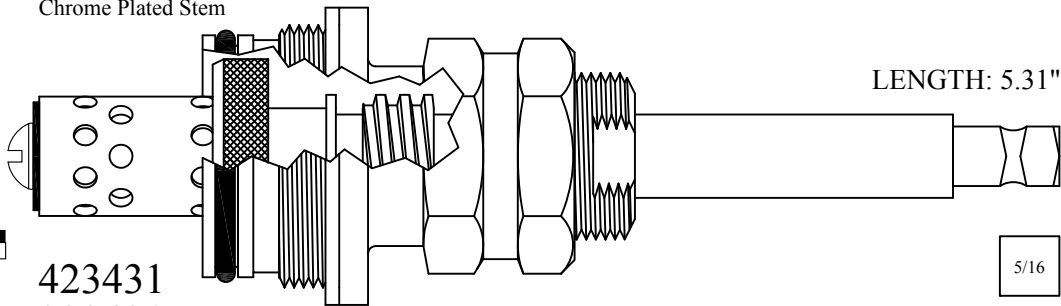

LENGTH: 5.31"

423431
223431 Stem Only
 GASKET: 895500 INCLUDED

5/16

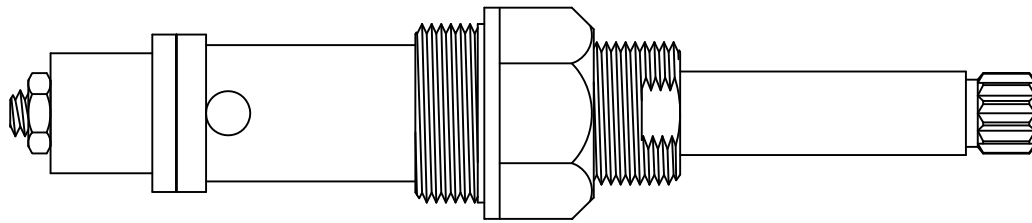

Old Style, Use 433281

Old Style
 Chrome Plated Stem & Pkg Nut

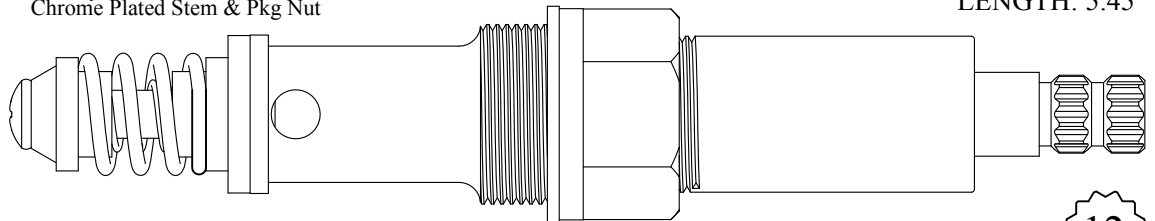

LENGTH: 5.45"

433281
 GASKET: 895350 INCLUDED

12

Symmons Small

Chrome Plated Stem

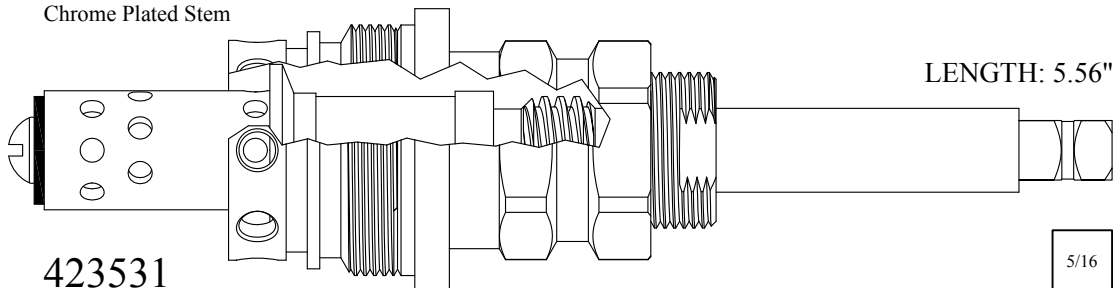

LENGTH: 5.56"

423531
223531 Stem Only
 GASKET: 895500 INCLUDED

5/16

FOR SYMMONS

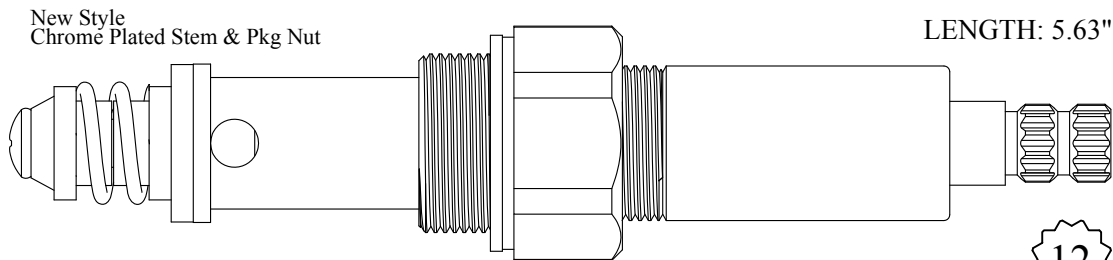

435781

GASKET: 895350 INCLUDED

12

Symmons Small

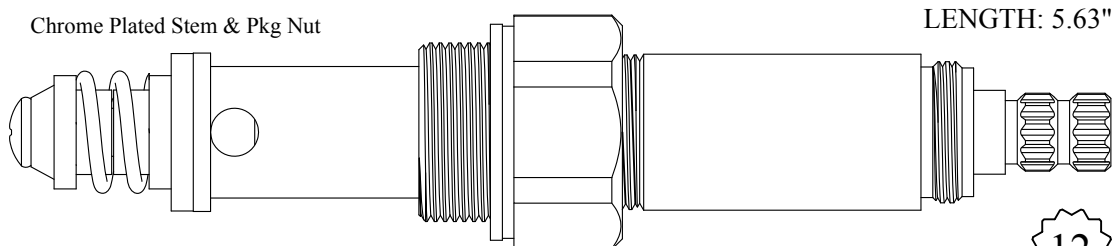

435791

GASKET: 895350 INCLUDED

12

Symmons Small

Send Your Orders To:

BARRY E.  WALTER  SR. CO.

E-mail: orderdesk@barrywalter.com

Fax: 1.800.886.9831

Phone: 1.800.767.5552

FOR SYSTEM

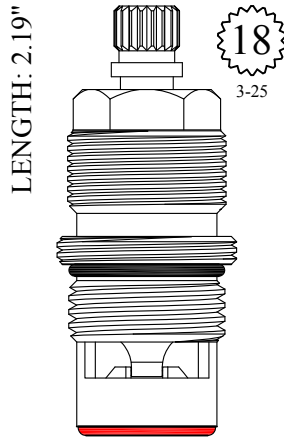

GASKET: 890170 O-RING INCLUDED
 SEAL: 898570-R/B
 DISC SET: 151380-PKG

LF460711
 LF460712

FOR T & S

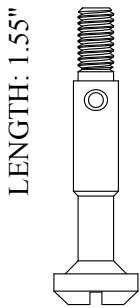

LF107910

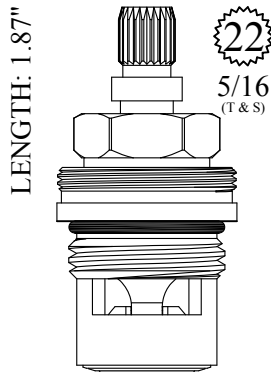

GASKET: 890170 O-RING INCLUDED
 SEAL: 898500
 DISC SET: 112530-PKG

LF456261
 LF456262

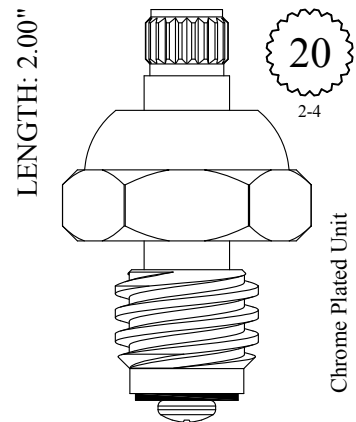

LF458201
 LF458202
 LF258201 Stem Only
 LF258202 Stem Only



SEAT USED: LF647700

FOR T & S

LENGTH: 2.23"

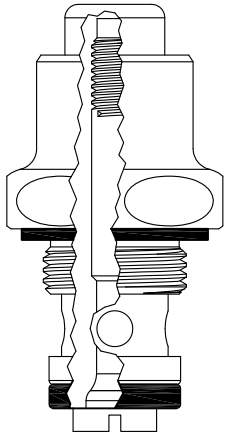

Chrome Plated Unit

GASKET: 895260 INCLUDED

LF462400

LENGTH: 2.67"

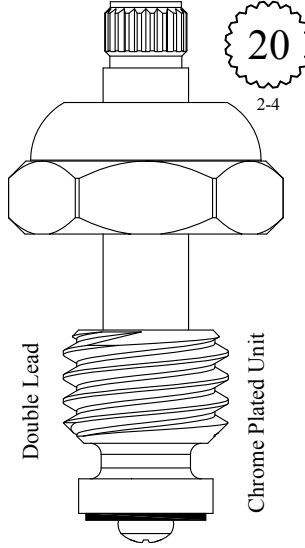

Double Lead

Chrome Plated Unit

LF465021
LF465022
LF265021 Stem Only
LF265022 Stem Only



SEAT USED: LF646900

LENGTH: 2.67"

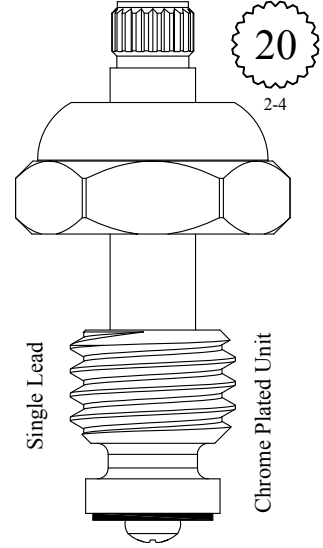

Single Lead

Chrome Plated Unit

LF465181
LF265181 Stem Only

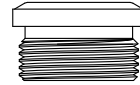

SEAT USED: LF646900

LENGTH: 2.83"

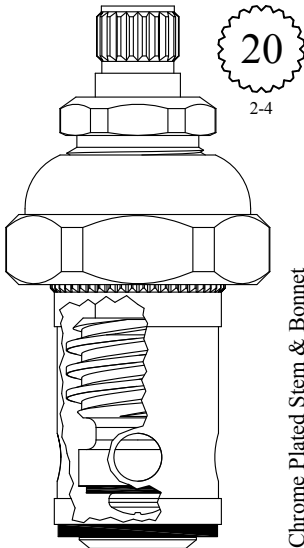

Chrome Plated Stem & Bonnet

Also available with handle ABRTS33410

LF464061-3341 / LF464062-3341

LF464061
LF464062
LF264061 Stem Only
LF264062 Stem Only

USES BARREL:
 LF664061/LF664062

LENGTH: 2.83"

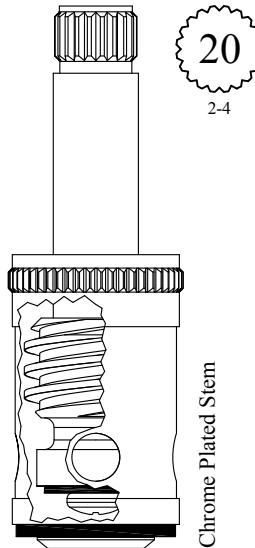

Chrome Plated Stem

LF464061-LB
LF464062-LB
LF264061 Stem Only
LF264062 Stem Only

USES BARREL:
 LF664061/LF664062

LENGTH: 3.04"

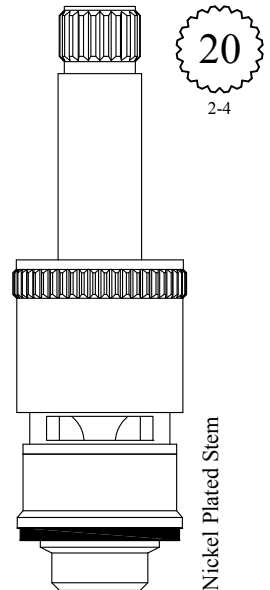

Nickel Plated Stem

SEAL: 898510
 DISC SET: 151380-PKG
LF466401
LF466402

FOR T & S

Chrome Plated Stem & Cap Nut

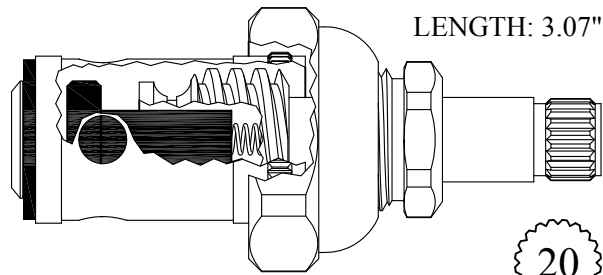

LF464181/ LF464182

LF264181/ LF264182

LF118481/ LF118482

Stem W/ Spring & Retainer

Stem Only

USES BARREL:
LF664061/LF664062

20

2-4

Chrome Plated Stem

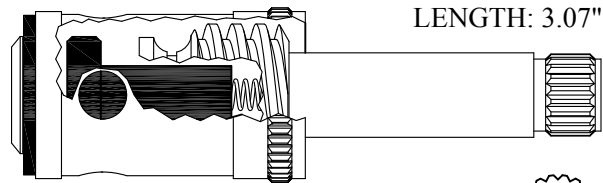

LF464181-LB/ LF464182-LB

LF264181/ LF264182

Stem W/ Spring & Retainer

USES BARREL:
LF664061/LF664062

20

2-4

Chrome Plated Unit w/ Button

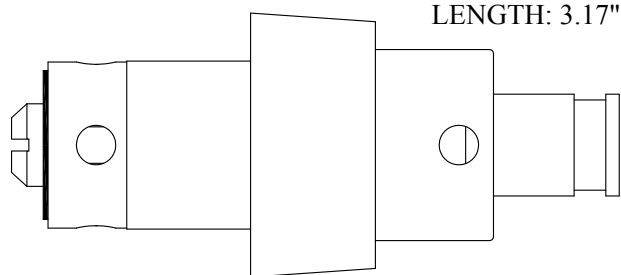

LF467210

Chrome Plated Stem

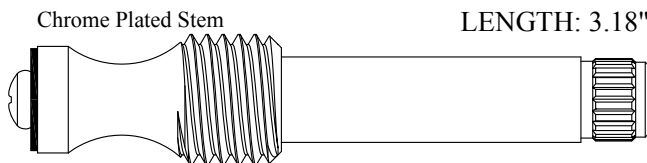

LF268401

20

2-4

FOR TANNER

LENGTH: 2.29"

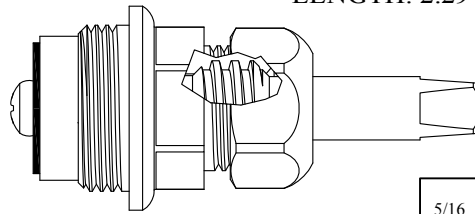

462561
GASKET: 895400

5/16
Tapered

LENGTH: 2.31"

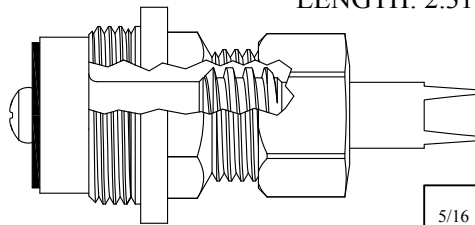

468031
GASKET: 895370

5/16
Tapered

LENGTH: 2.77"

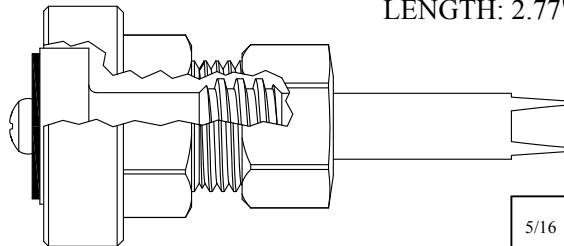

465251
GASKET: 894860 INCLUDED

5/16
Tapered

LENGTH: 3.01"

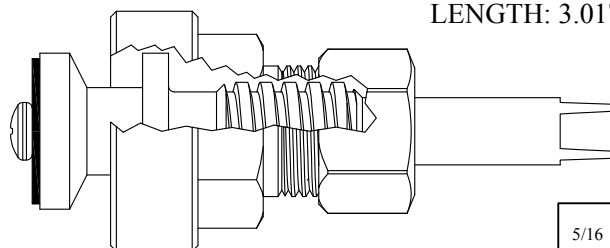

466341
GASKET: 894860 INCLUDED

5/16
Tapered

FOR TANNER

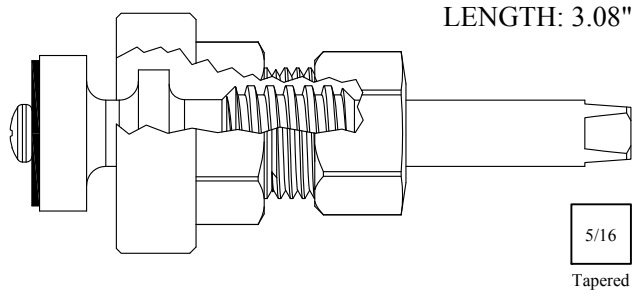

466371
GASKET: 894860 INCLUDED

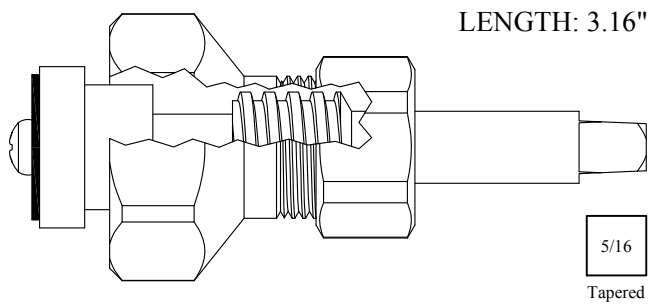

466601
GASKET: 895540

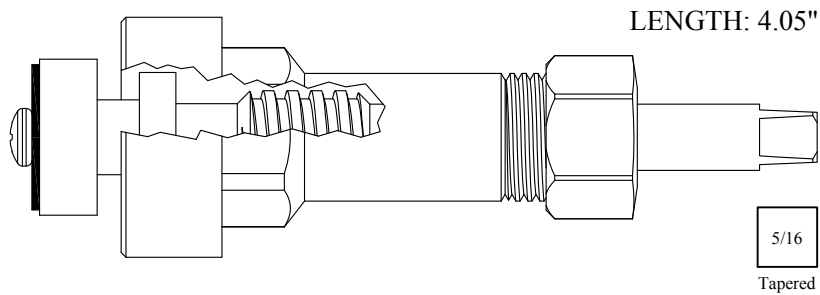

470811
GASKET: 894860 INCLUDED

BARRY E.  WALTER  SR. CO.

FOR TEMPRESS

Old Style - Automatic

LENGTH: 3.59"

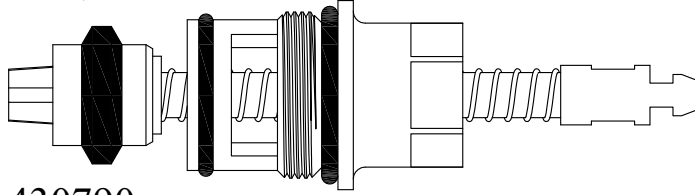

430790

GASKET: 894120 O-RING INCLUDED

New Style - Manual

LENGTH: 3.76"

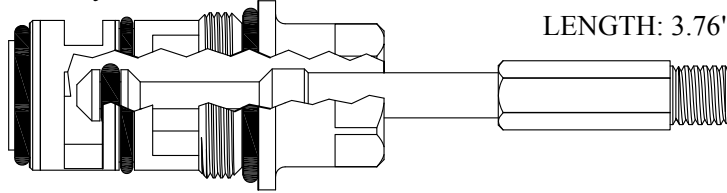

430850

GASKET: 894120 O-RING INCLUDED

Old Style - Automatic with Brass Link

LENGTH: 4.09"

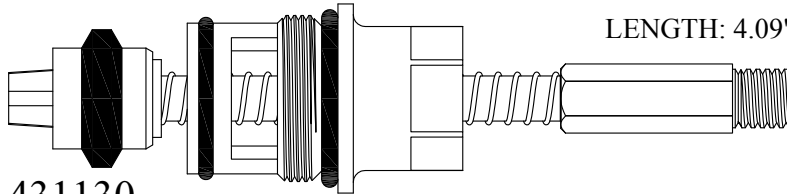

431130

GASKET: 894120 O-RING INCLUDED

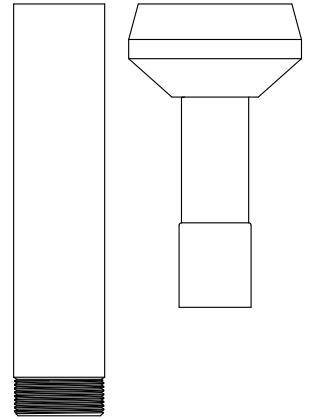

Chrome plated handle
& sleeve available
128540

FOR THG

LENGTH: 2.90"

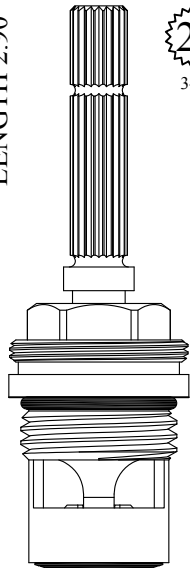

20
3-20

GASKET: 890170 O-RING INCLUDED
SEAL: 898510-W
DISC SET: 151380-PKG

LF465581
LF465582

FOR TWYFORD BATHROOM

LENGTH: 2.35"

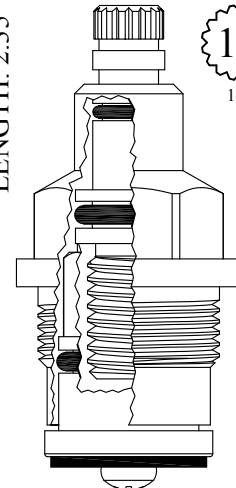

16
1-6

GASKET: 895370

401372

FOR UNION BRASS / GOPHER

LENGTH: 1.38"

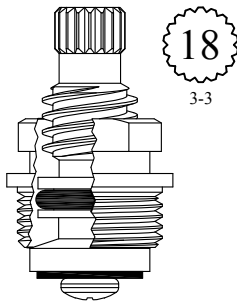

GASKET: 895100

LF450071
LF450072

LENGTH: 1.45"

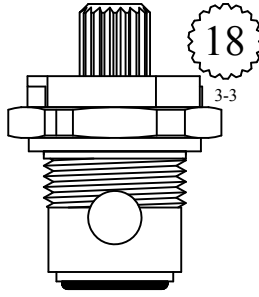

GASKET: 895100

LF452121
LF452122

LENGTH: 1.75"

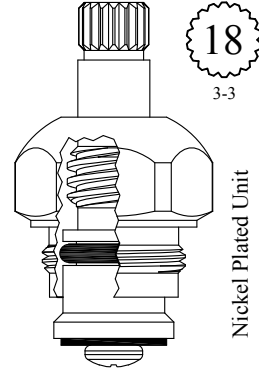

GASKET: 895100

LF455011
LF455012

Nickel Plated Unit

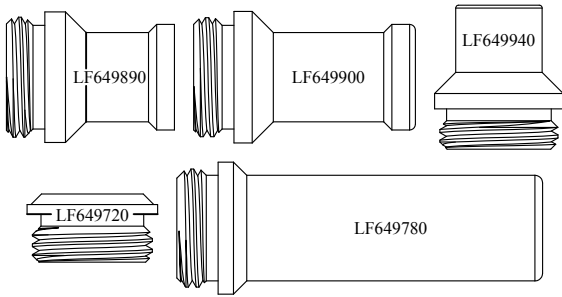

SEATS USED: LF649720,
LF649780, LF649890,
LF649900 or LF649940

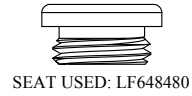

SEAT USED: LF648480

LENGTH: 1.81"

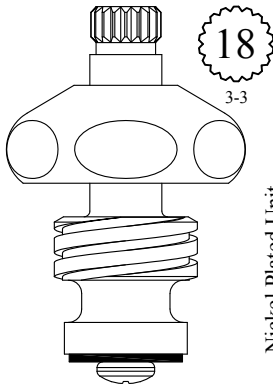

Nickel Plated Unit

LF455121
LF455122
LF255121 Stem Only
LF255122 Stem Only

LENGTH: 2.39"

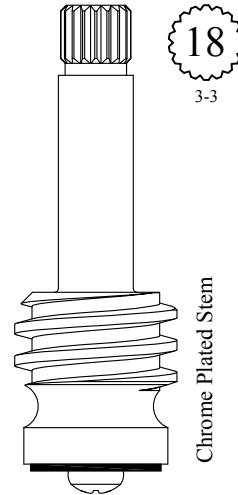

Chrome Plated Stem

LF264191
LF264192



SEAT USED: LF648480

FOR UNION BRASS / GOPHER

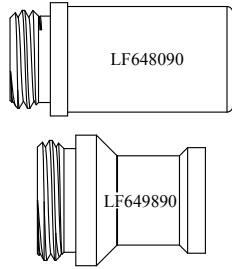

SEATS USED: LF648090 or LF649890

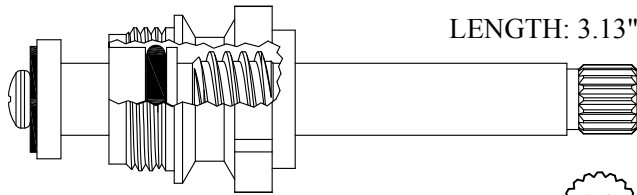

LENGTH: 3.13"

402001/ 402002

GASKET: 895100

18
3-3

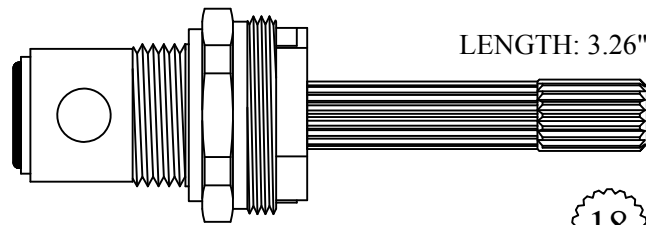

LENGTH: 3.26"

402511/ 402512

GASKET: 895100
SEAL: 898510
DISC SET: 151380-PKG

18
3-3

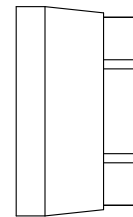

Cap Nut
702510
available



SEAT USED: LF649930

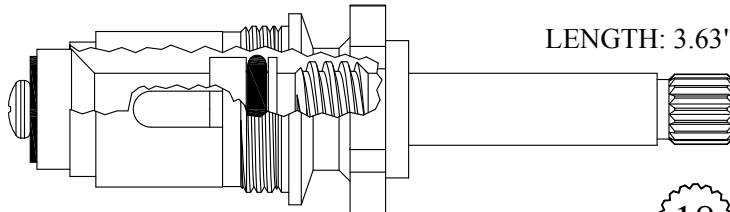

LENGTH: 3.63"

430151

GASKET: 895400

18
3-3

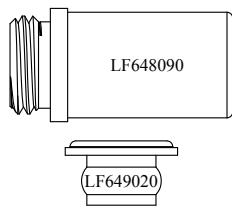

SEATS USED: LF648090 or LF649020

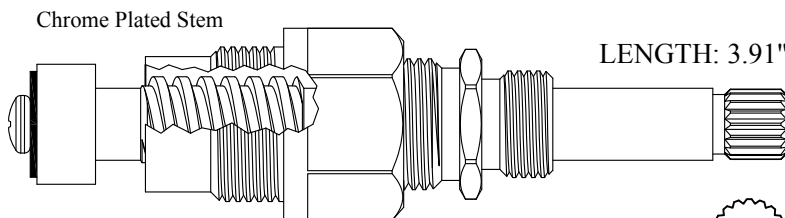

Chrome Plated Stem

LENGTH: 3.91"

LF469051/ LF469052

LF269051/ LF269052 Stem Only

GASKET: 895150

18
3-3

FOR UNION BRASS / GOPHER

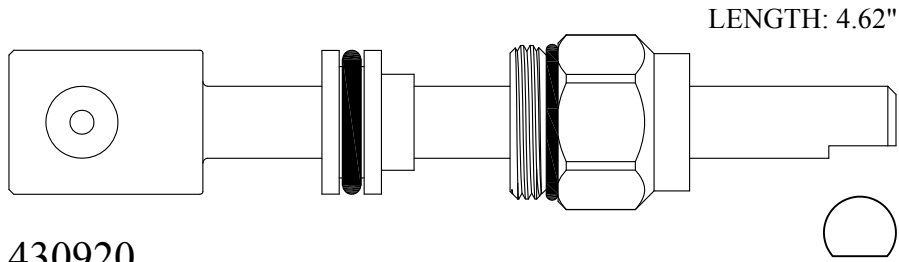

430920
230920 Stem Only
 GASKET: 890170 O-RING INCLUDED

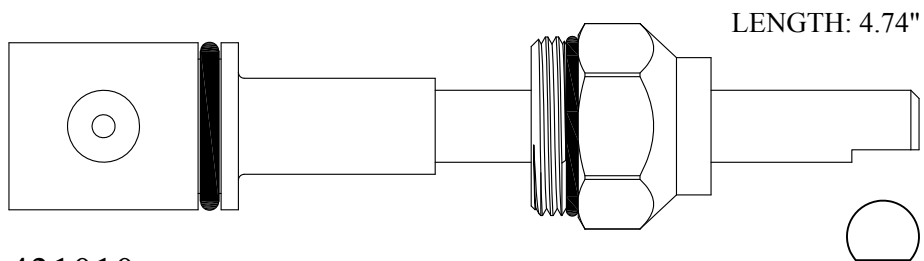

431010
231010 Stem Only
 GASKET: 890190 O-RING INCLUDED

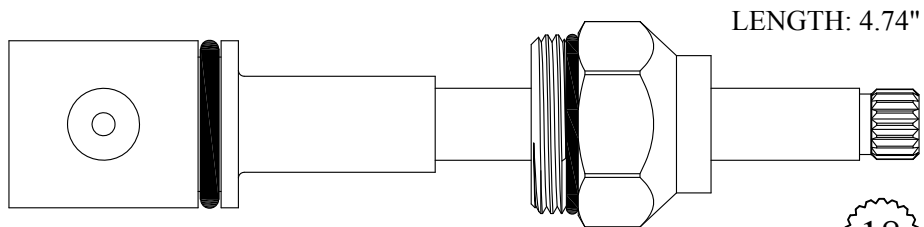

431060
 GASKET: 890190 O-RING INCLUDED

18
 3-3

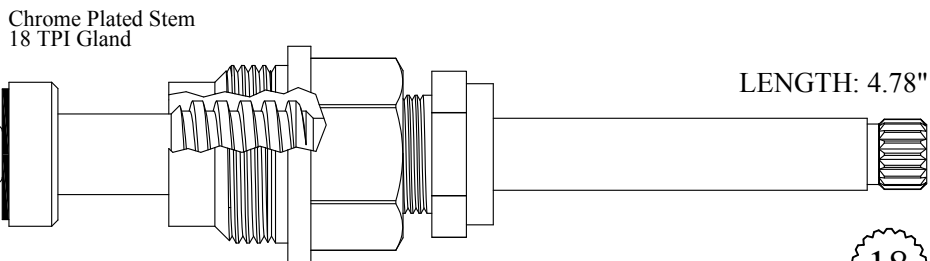

Chrome Plated Stem
 18 TPI Gland
409701
209701 Stem Only
 GASKET: 895370

18
 3-3

SEAT USED: LF649930

FOR UNION BRASS / GOPHER

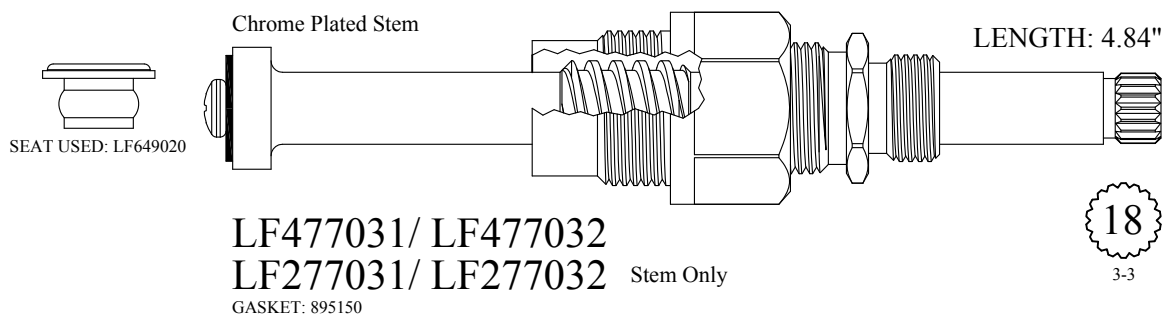
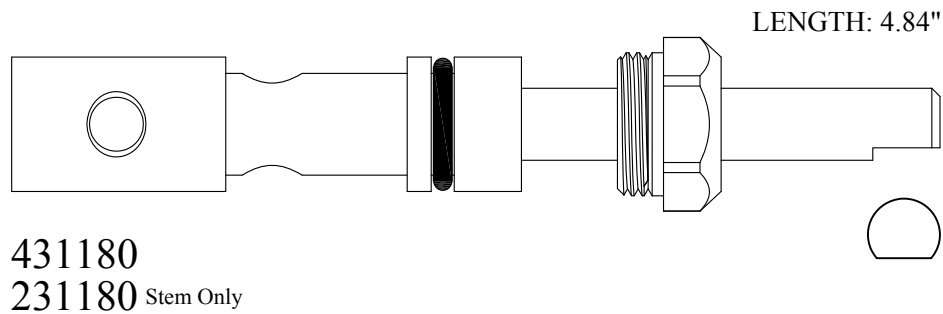
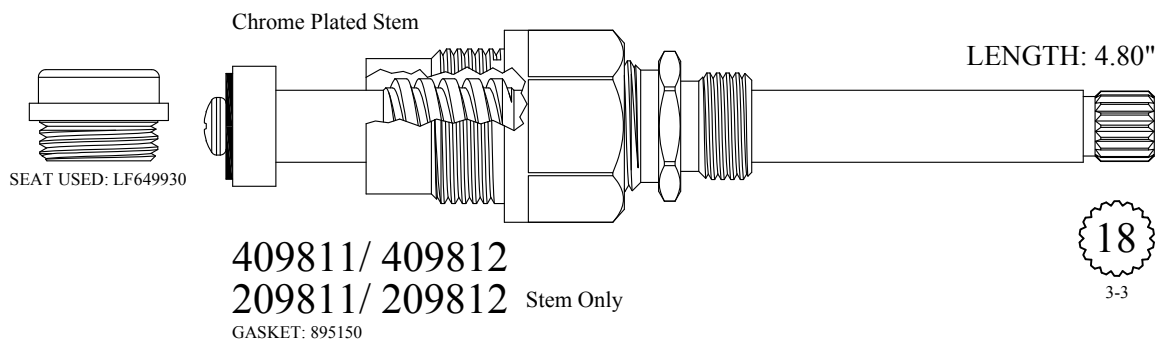
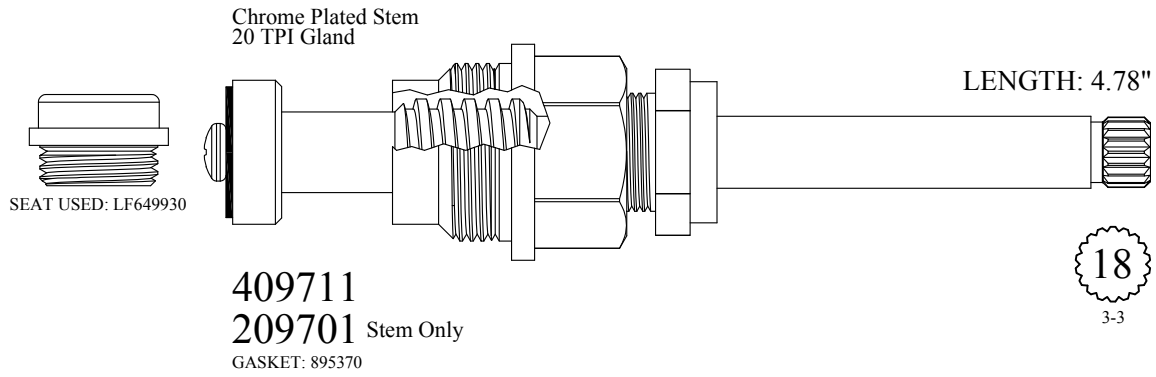

FOR UNION BRASS / GOPHER

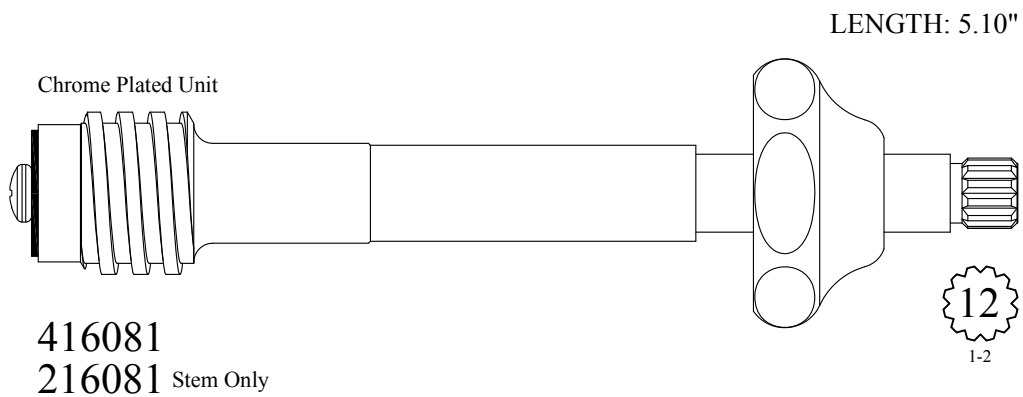
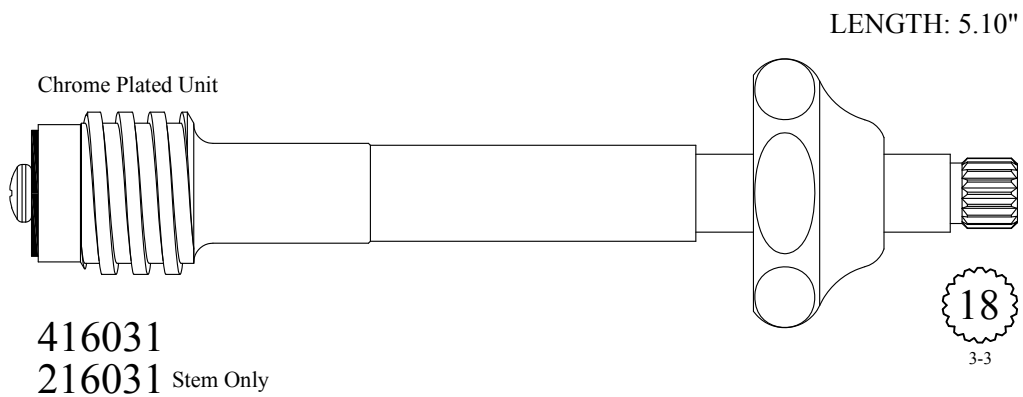
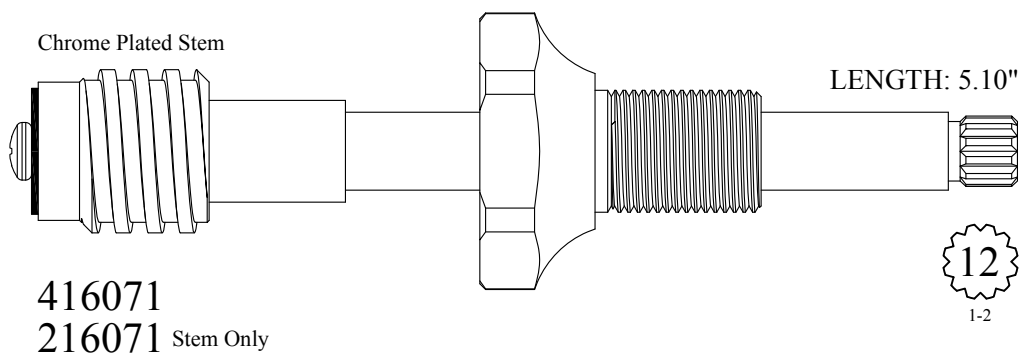
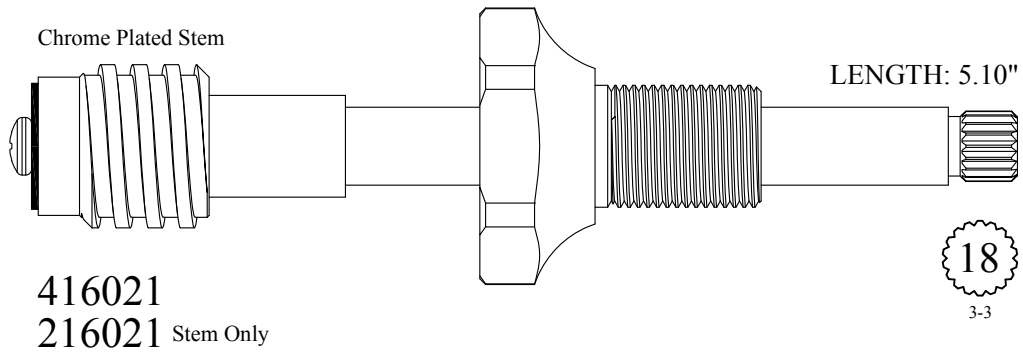

FOR UNION BRASS / GOPHER

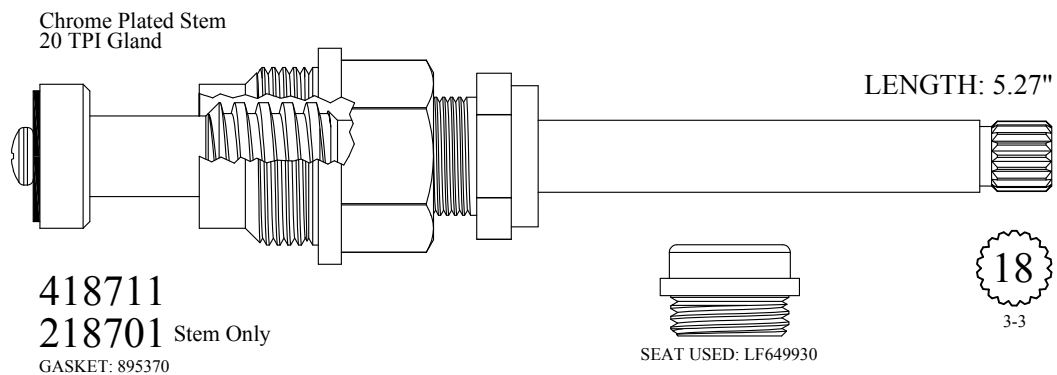
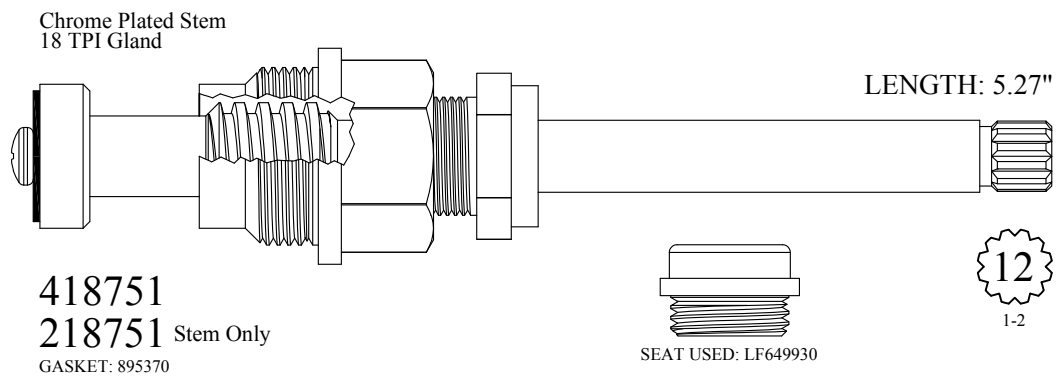
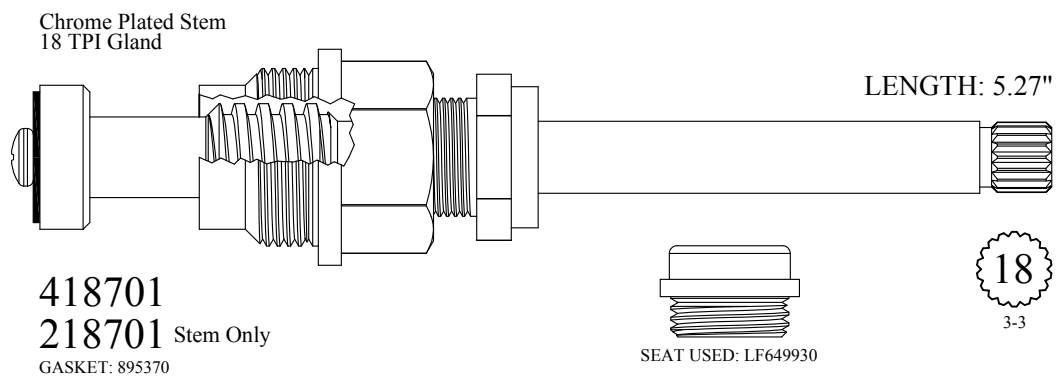
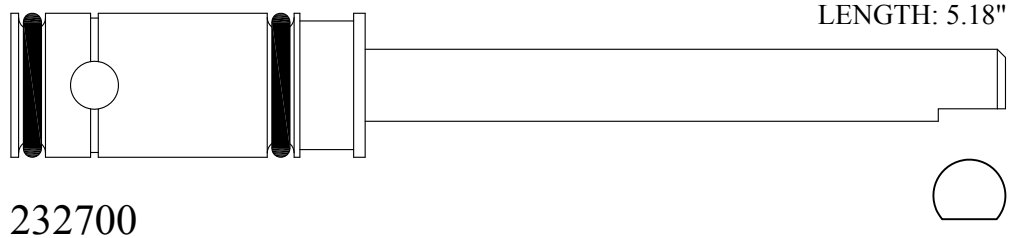

FOR UNION BRASS / GOPHER

Chrome Plated Stem

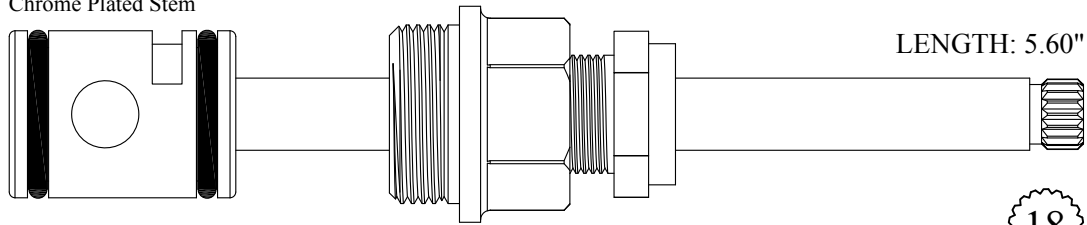

LENGTH: 5.60"

435200
235200 Stem Only

18
3-3

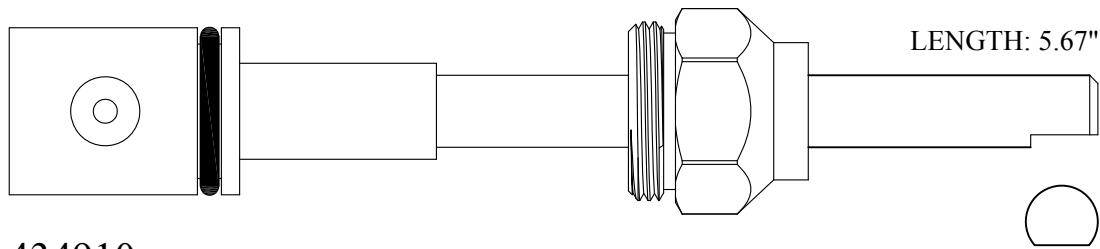

LENGTH: 5.67"

434910
234910 Stem Only

Chrome Plated Stem

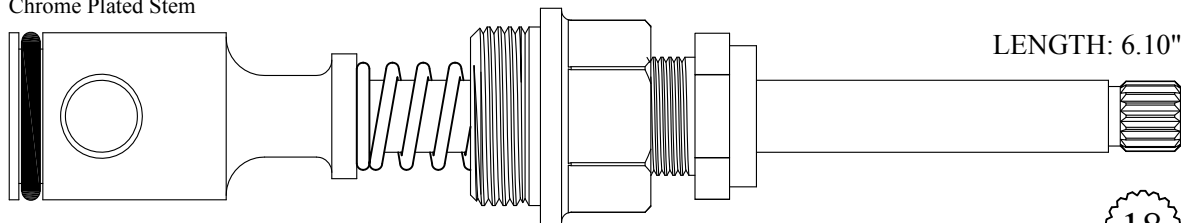

LENGTH: 6.10"

437900
237900 Stem Only
GASKET: 895330

18
3-3

BARRY E.  WALTER  SR. CO.

FOR UNITED

LENGTH: 5.08"

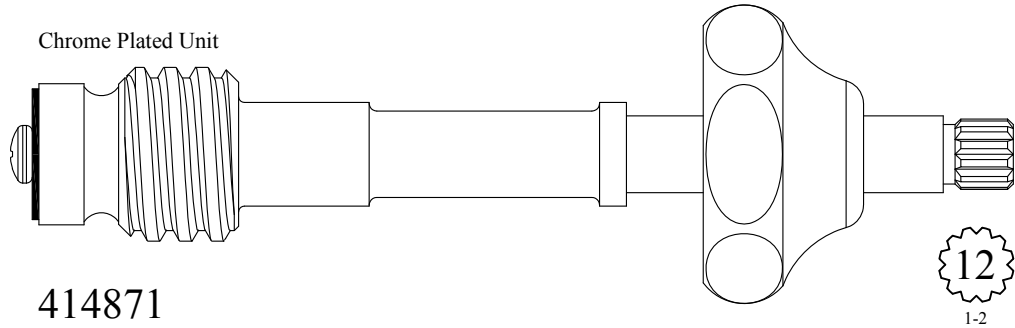

414871
214871 Stem Only

12
1-2

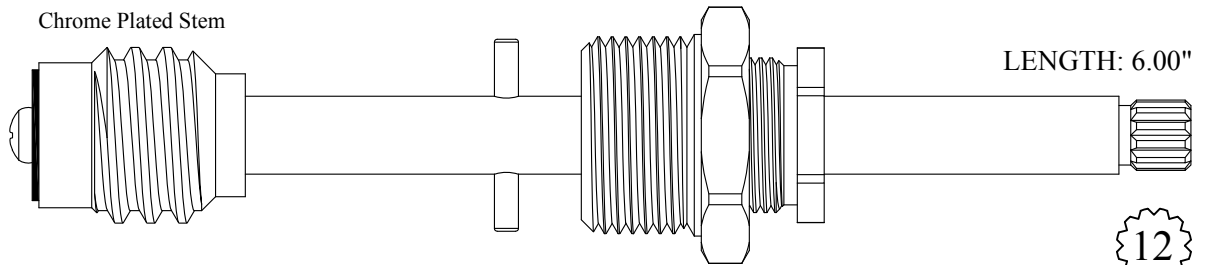

426641
226641 Stem Only

LENGTH: 6.00"

12
1-2

FOR UNIVERSAL BRASS

Chrome Plated Stem

LENGTH: 2.27"

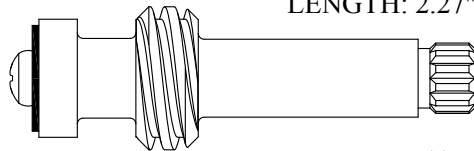

LF263061
LF263062

12
1-2

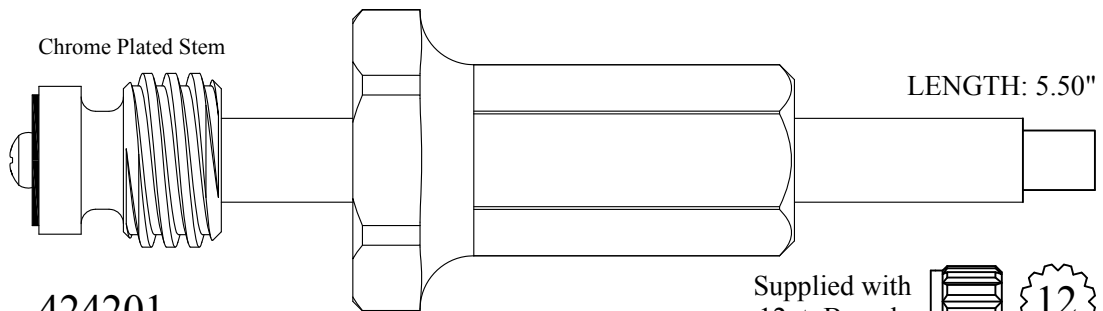

LENGTH: 5.50"

424201
224201 Stem Only

Supplied with
12pt. Broach



12
1-2

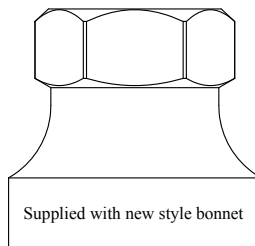

FOR URREA

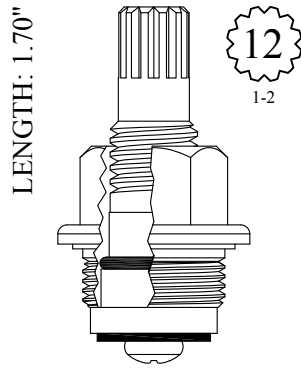

LF453401

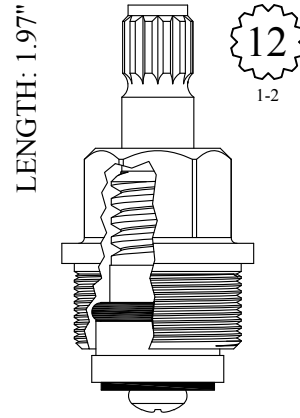

GASKET: 895180

LF458401

FOR WATTS

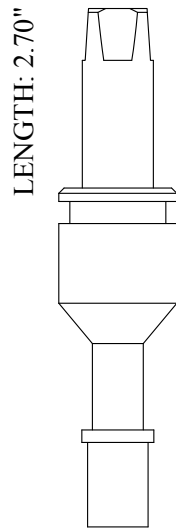

130990

FOR WATER SAVER

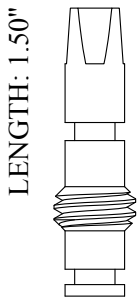

LF251341

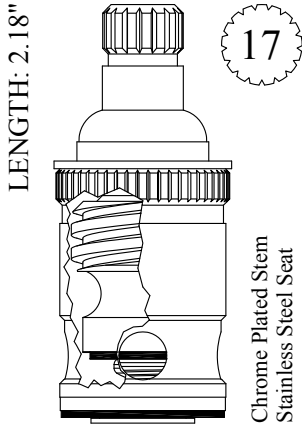

SEAT INCLUDED: LF648600

LF461301
LF461302

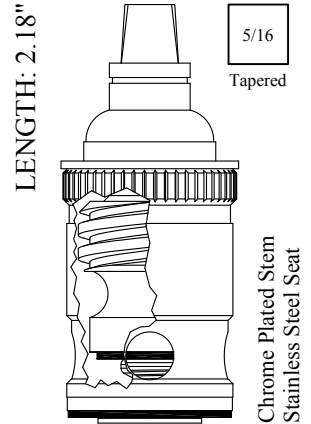

SEAT INCLUDED: LF648600

LF461311
LF461312

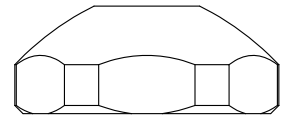

Chrome Plated Bonnet also available
761300

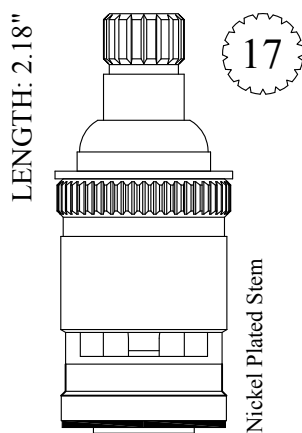

DISC SET: 151380-PKG

LF461321
LF461321

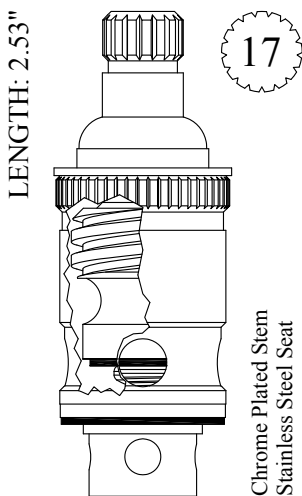

SEAT INCLUDED: LF649880

LF464041
LF464042

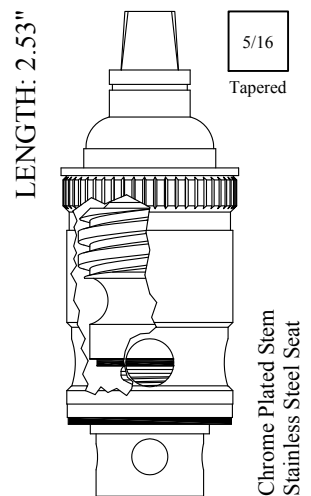

SEAT INCLUDED: LF649880

LF464441
LF464442

FOR WATERMARK

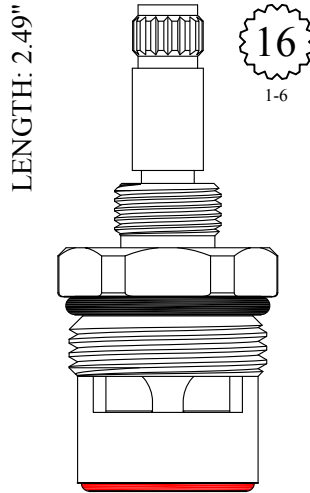

GASKET: 890170 O-RING INCLUDED
 SEAL: 898610-R/B
 DISC SET: 109850-PKG

401261
 401262

FOR WATERWORKS

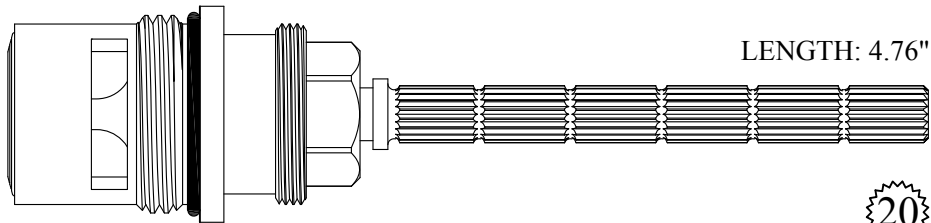

409941/ 409942

GASKET: 890210 O-RING INCLUDED
 SEAL: 898520
 DISC SET: 109850-PKG

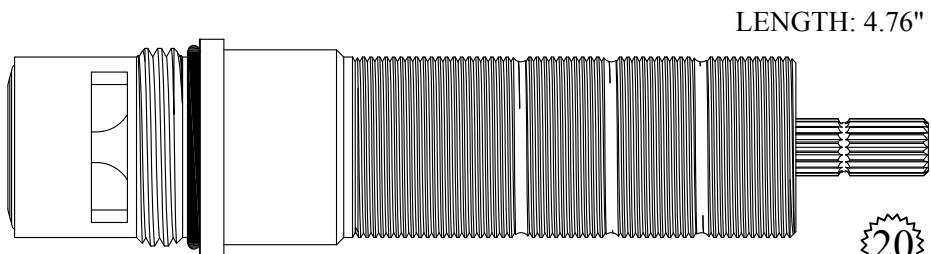

409941-EN/ 409942-EN

GASKET: 890210 O-RING INCLUDED
 SEAL: 898520
 DISC SET: 109850-PKG

Escutcheon Nipple available separately

127350

FOR WELLINGTON

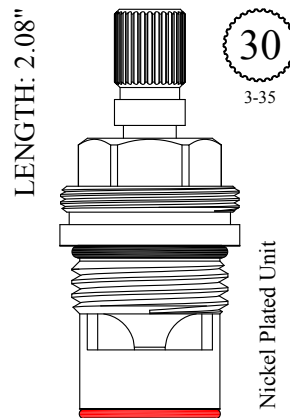

GASKET: 890170 O-RING INCLUDED
SEAL: 898580-R/B
DISC SET: 151380-PKG

LF459351
LF459352

Send Your Orders To:

BARRY E.  ALTER  SR. CO.

E-mail: orderdesk@barrywalter.com

Fax: 1.800.886.9831

Phone: 1.800.767.5552

FOR WEST BRASS

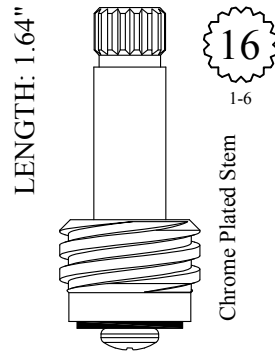

LF252111
LF252112

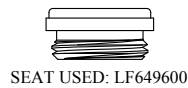

SEAT USED: LF649600

FOR WEST BRASS (ITALY)

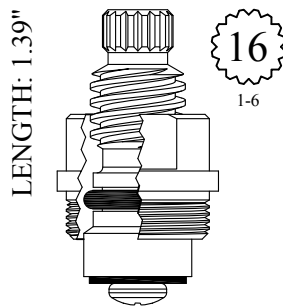

GASKET: 895100

LF450121
LF450122

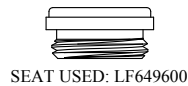

SEAT USED: LF649600

FOR WEST BRASS (JAPAN)

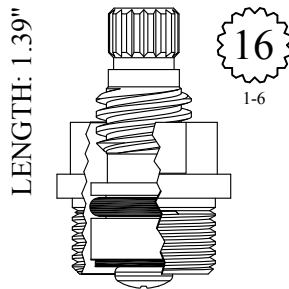

GASKET: 895100

LF450081
LF450082

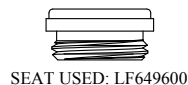

SEAT USED: LF649600

Send Your Orders To:

BARRY E.  SR. CO.

E-mail: orderdesk@barrywalter.com

Fax: 1.800.886.9831

Phone: 1.800.767.5552



BRASS
AMERICA
Quality Replacement Parts

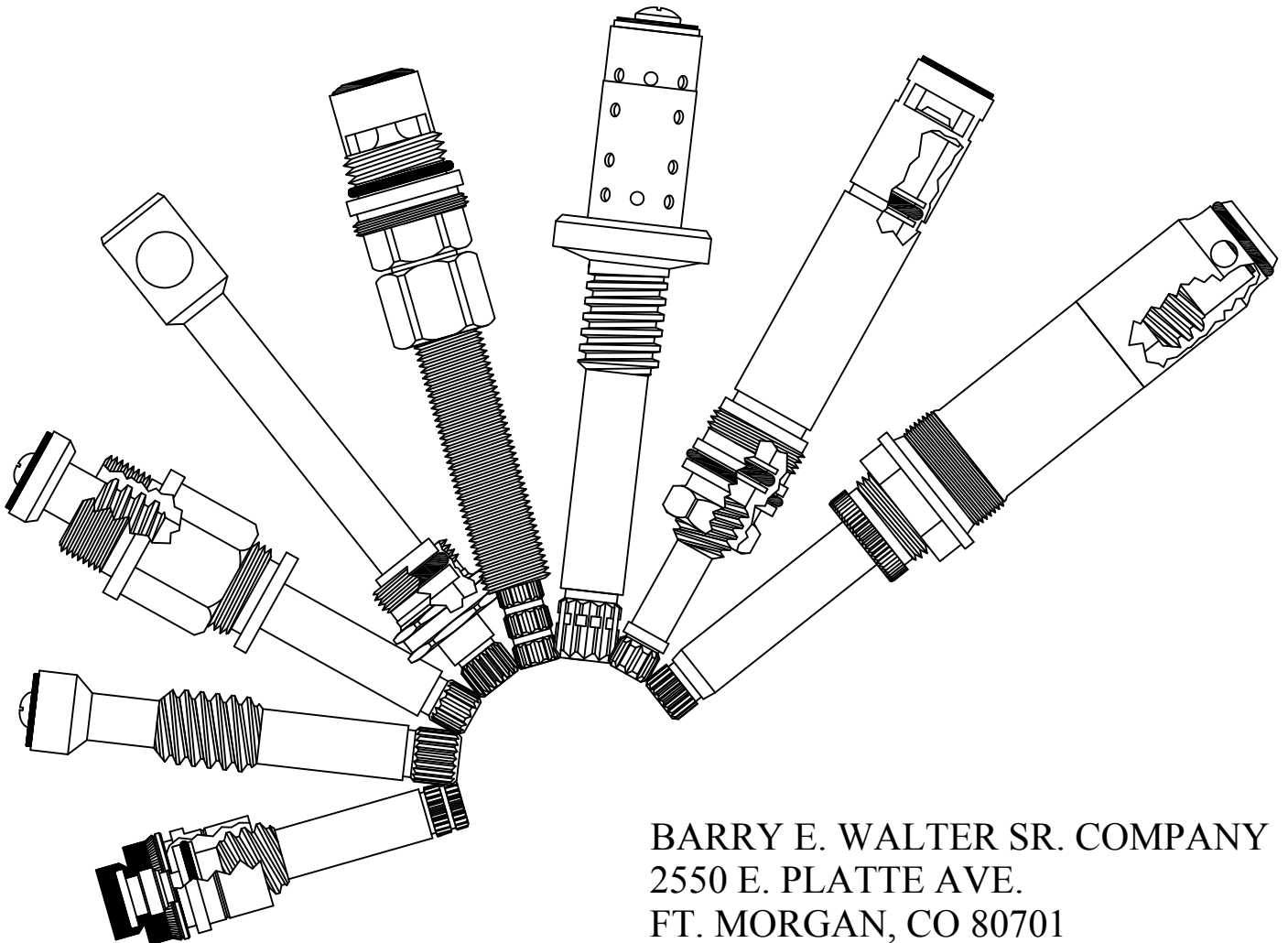

BARRY E. WALTER SR. COMPANY
2550 E. PLATTE AVE.
FT. MORGAN, CO 80701

*We are always adding
new parts. Check our
website for updates.*

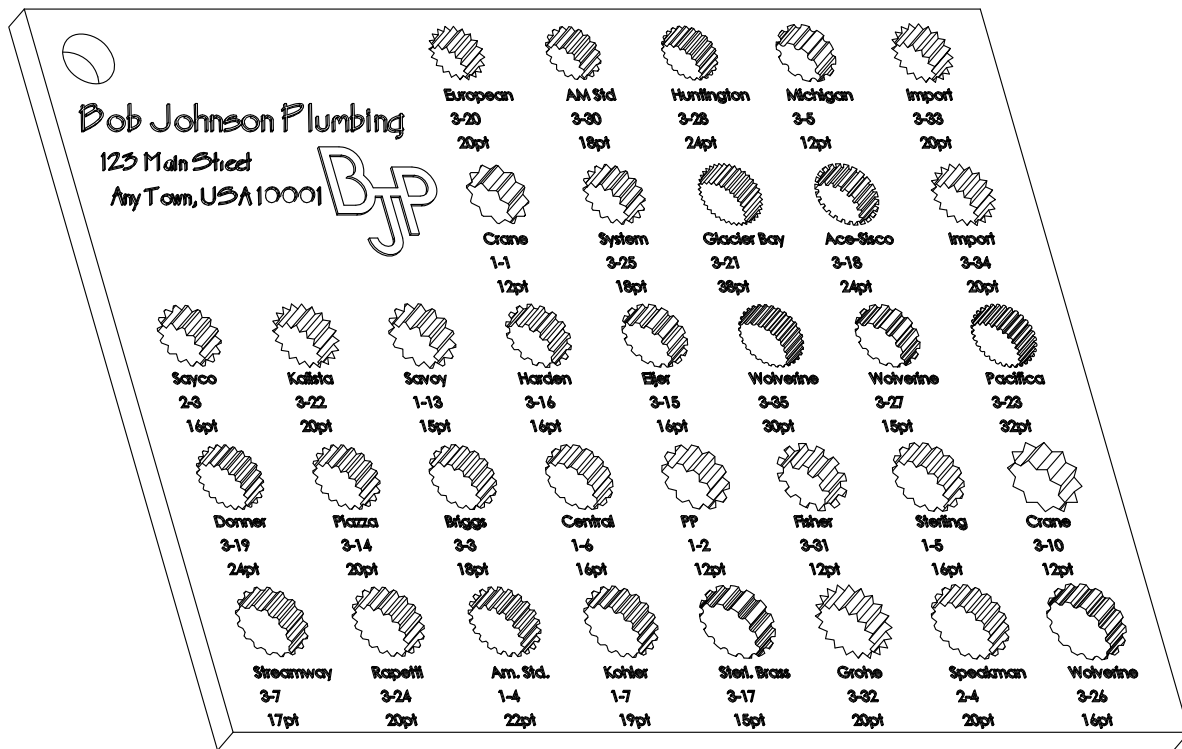

PART # 113740

BARRY E.  SR. CO.

FOR WILLOUGHBY

REPAIR KIT AVAILABLE
145450

KIT INCLUDES:
BEVELED BIBB WASHER
15.5MM x 3MM O-RING
.312 x .187 x .062 O-RING
.84 x .625 x .105 WASHER
6-32 x 1/4" BIBB SCREW

LENGTH: 1.66"

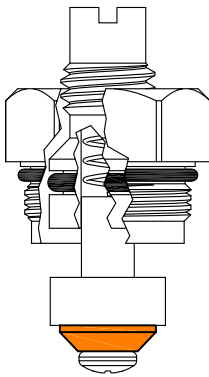

GASKET: 890190 O-RING INCLUDED

LF400451

LENGTH: 2.56"

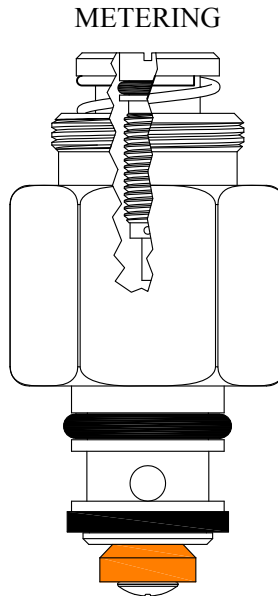

LF465480

LENGTH: 2.65"

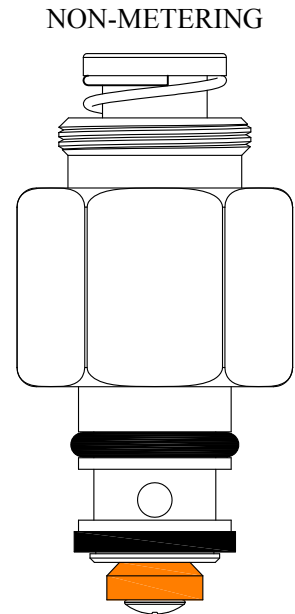

LF465470

Send Your Orders To:

BARRY E.  SR. CO.

E-mail: orderdesk@barrywalter.com

Fax: 1.800.886.9831

Phone: 1.800.767.5552

FOR WOLVERINE

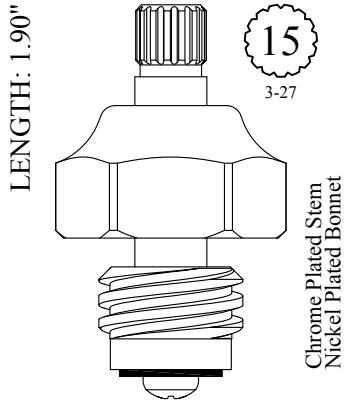

LF457161
LF457162
LF257161 Stem Only
LF257162 Stem Only

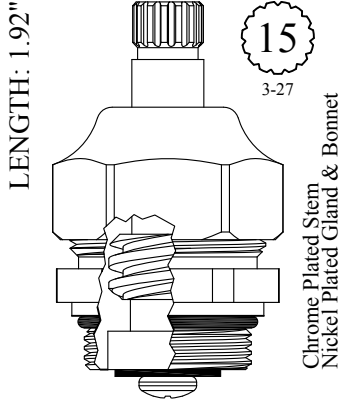
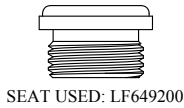

GASKET: 890190 O-RING INCLUDED

LF457081
LF457082

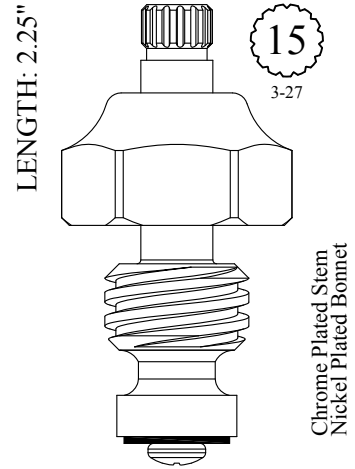

LF463081
LF463082
LF263081 Stem Only
LF263082 Stem Only

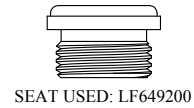

Also available as a RH/LH Kit

LF463321-2

Kit includes: (1) RH Stem, (1) LH Stem, (1) Body

Available: Stem Only

LF263321 / LF263322

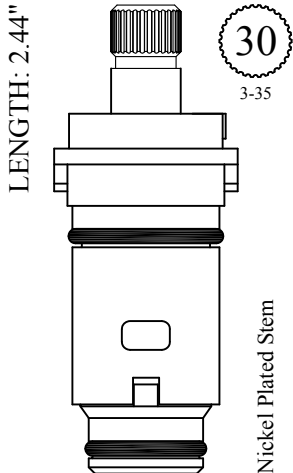
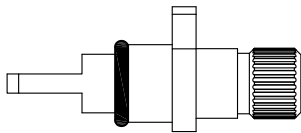

LF463321
LF463322

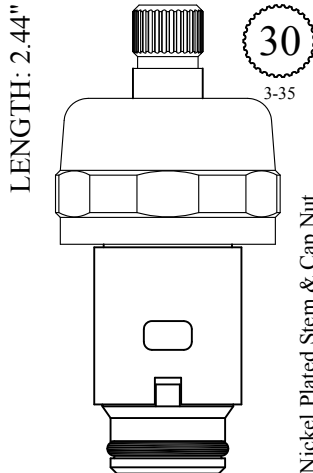

LF463321-N
LF463322-N

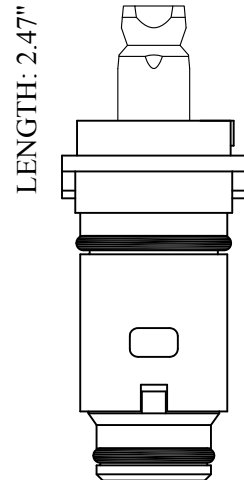
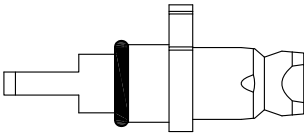

LF463361
LF463362

Also available as a RH/LH Kit

LF463361-2

Kit includes: (1) RH Stem, (1) LH Stem, (1) Body

Available: Stem Only

LF263361 / LF263362

FOR WOLVERINE

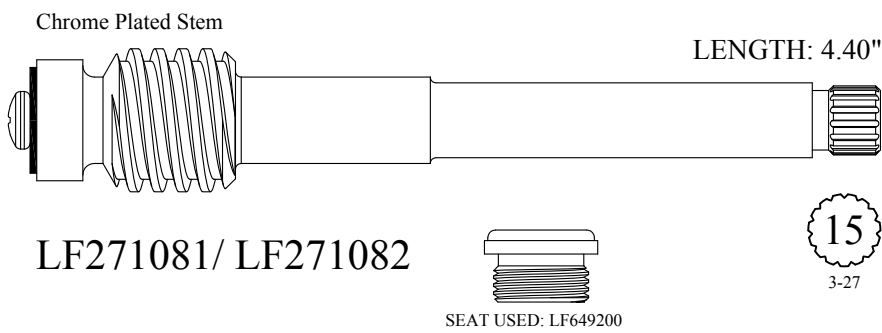
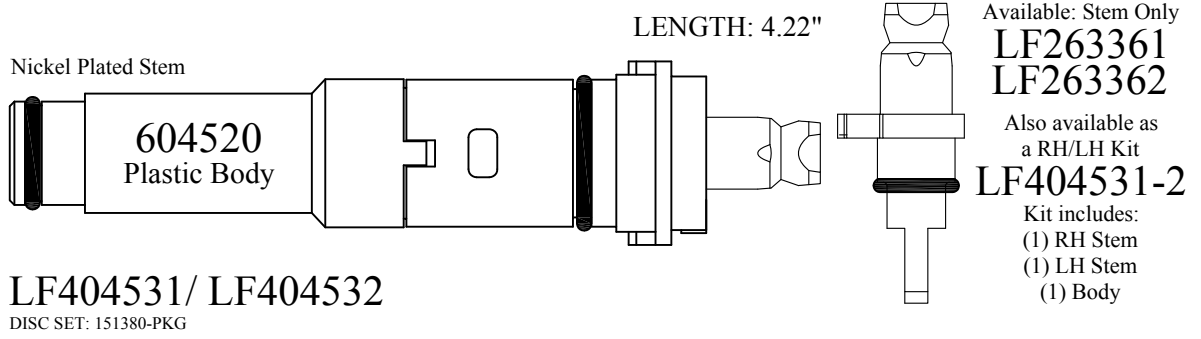
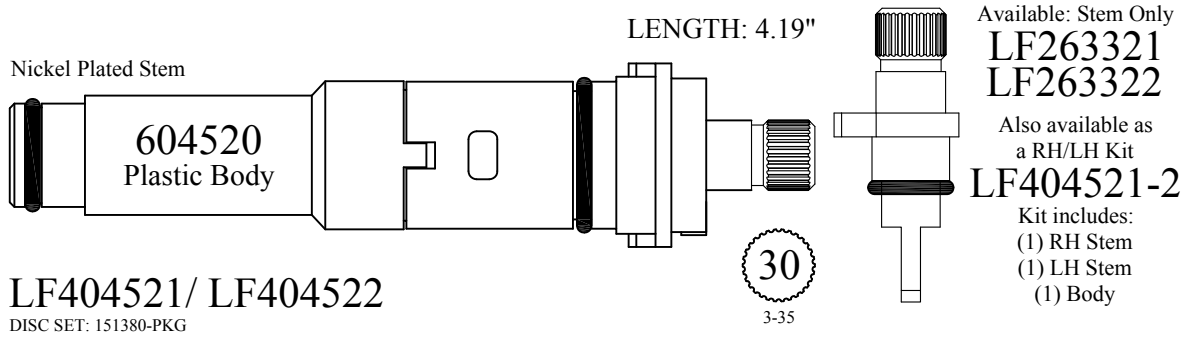
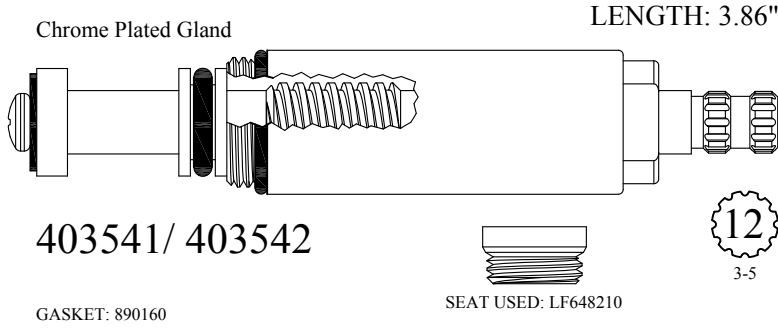

FOR WOLVERINE

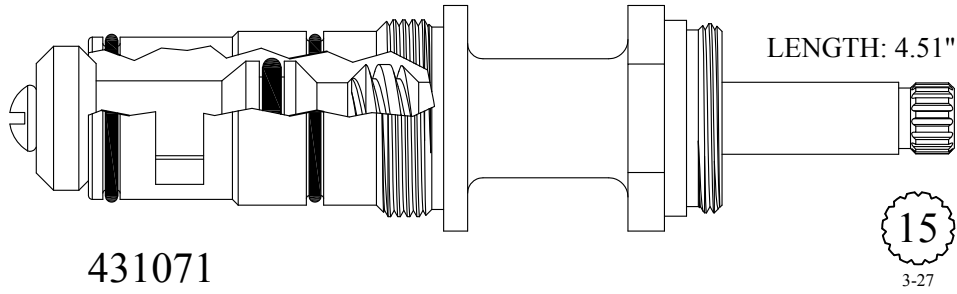

431071

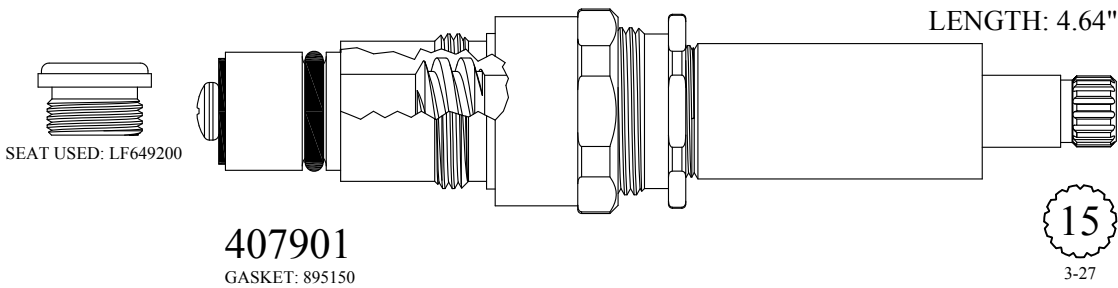

407901

GASKET: 895150

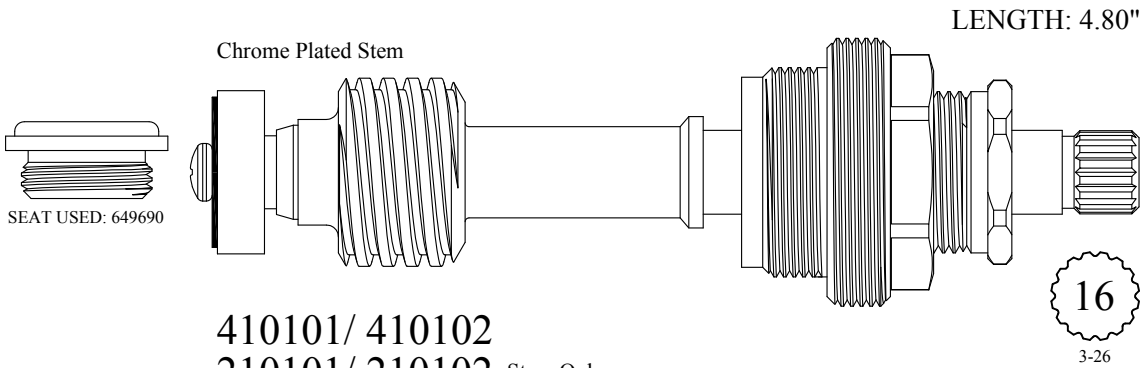

410101/ 410102

210101/ 210102 Stem Only

GASKET: 895450

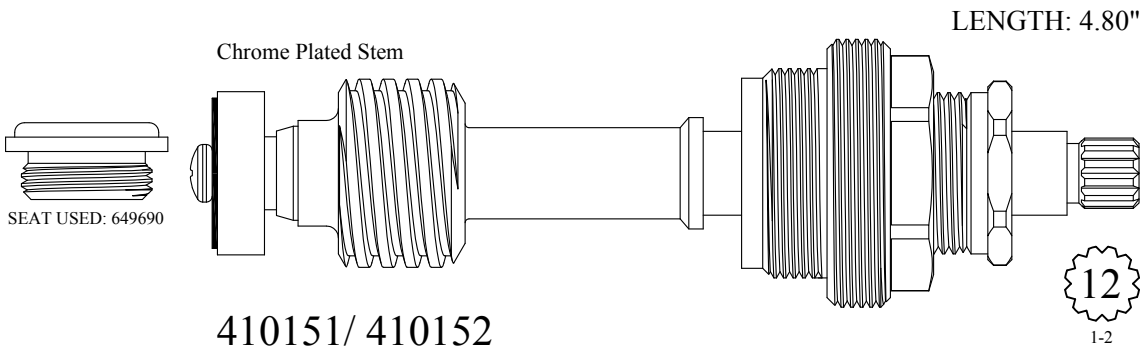

410151/ 410152

210151/ 210152 Stem Only

GASKET: 895450

FOR WOLVERINE

Chrome Plated Gland

LENGTH: 4.90"

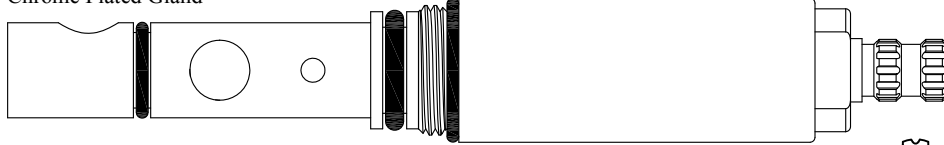

431240

GASKET: 890160 O-RING INCLUDED

12

3-5

Chrome Plated Stem

LENGTH: 5.18"

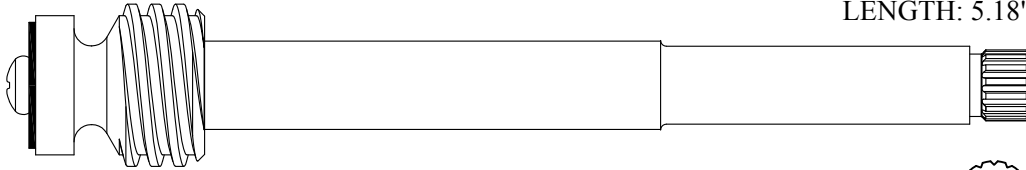

215921

15

3-27

Chrome Plated Stem

LENGTH: 5.18"

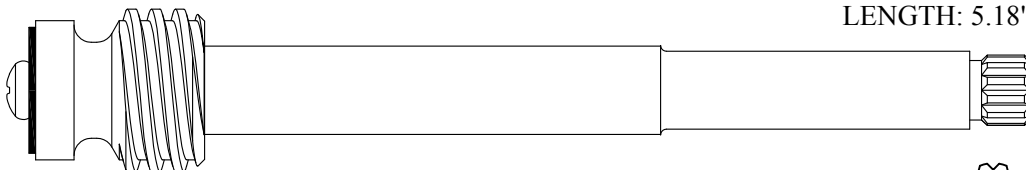

215971

12

1-2

Chrome Plated Stem

LENGTH: 5.18"

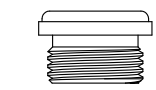

SEAT USED: LF649200

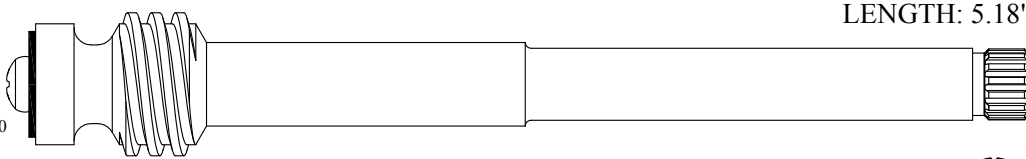

LF280021/ LF280022

15

3-27

FOR WOLVERINE

Chrome Plated Stem

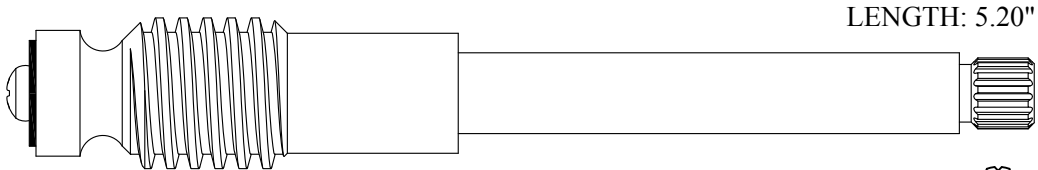

LENGTH: 5.20"

LF279821/ LF279822

15
3-27

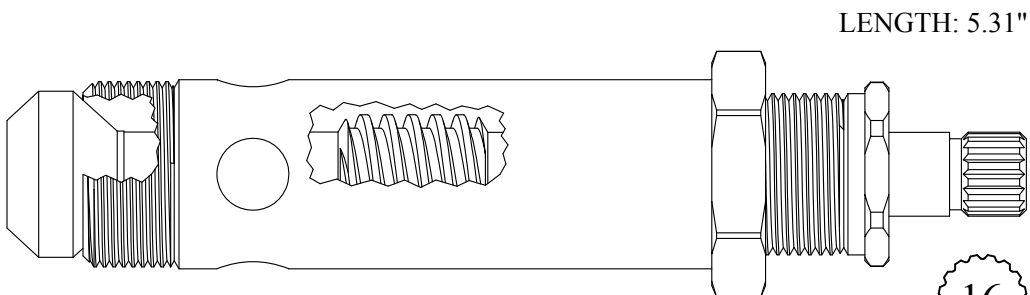

LENGTH: 5.31"

433381
233381 Stem Only
GASKET: 895550

16
3-26

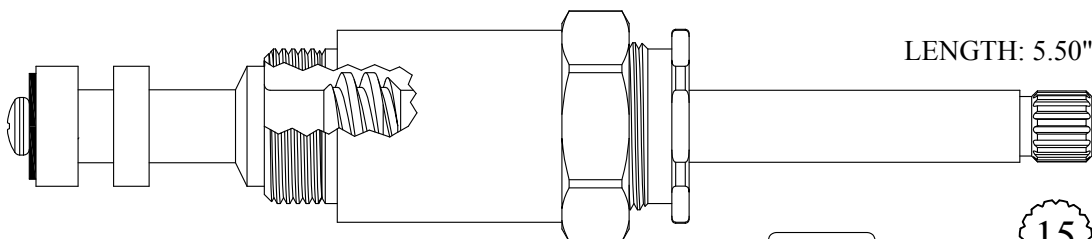

LENGTH: 5.50"

418311
GASKET: 895150

SEAT USED: LF649200

15
3-27

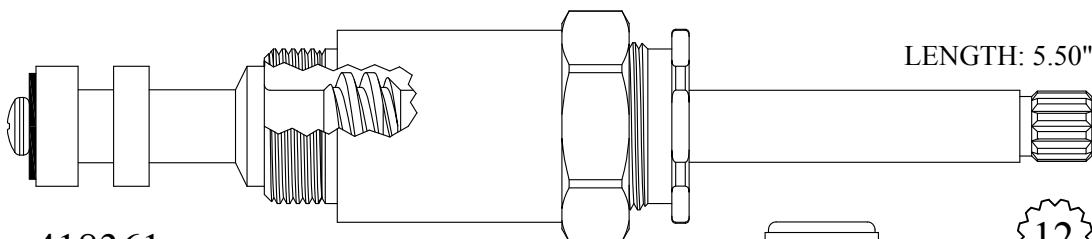

LENGTH: 5.50"

418361
GASKET: 895150

SEAT USED: LF649200

12
1-2

FOR WOLVERINE

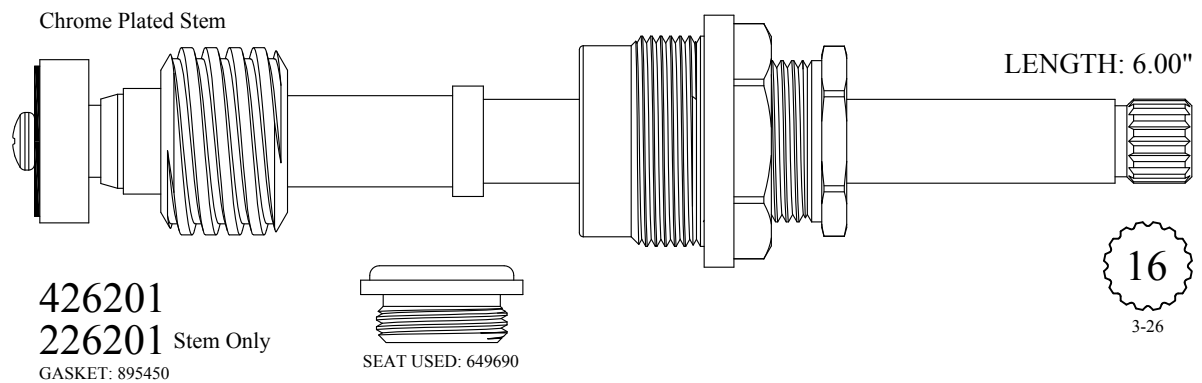
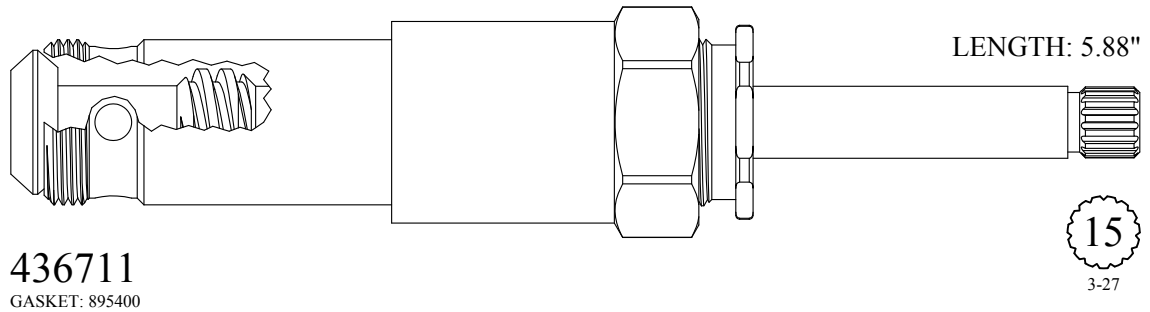
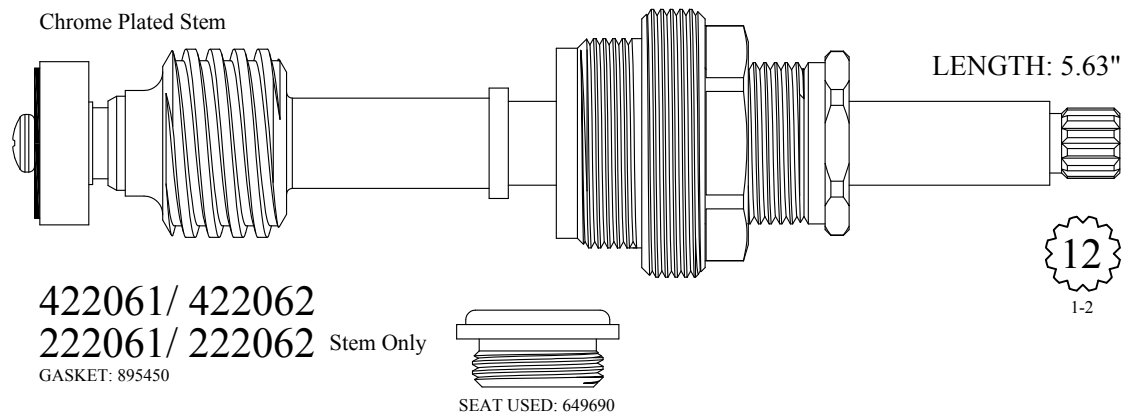
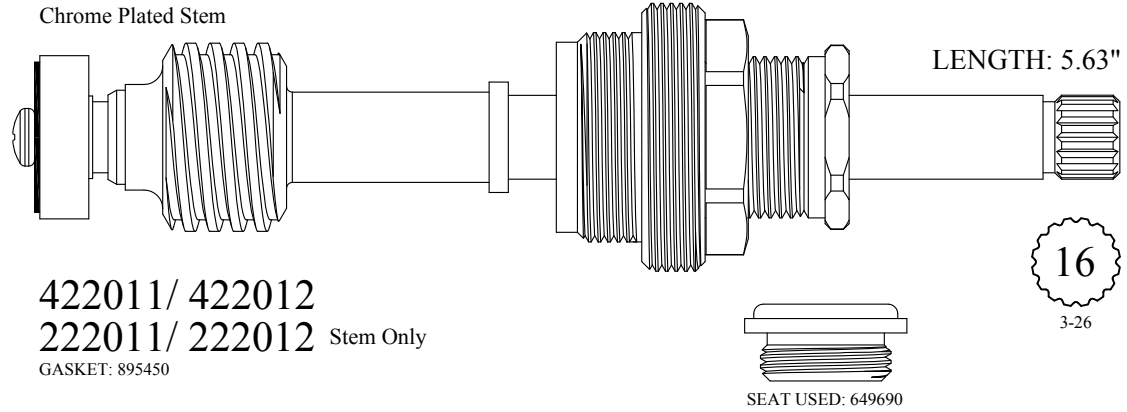

FOR WOLVERINE

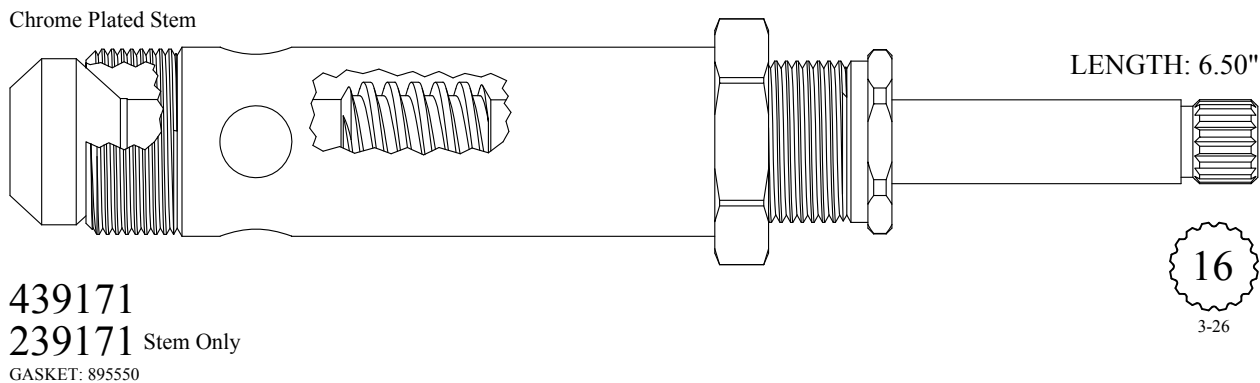
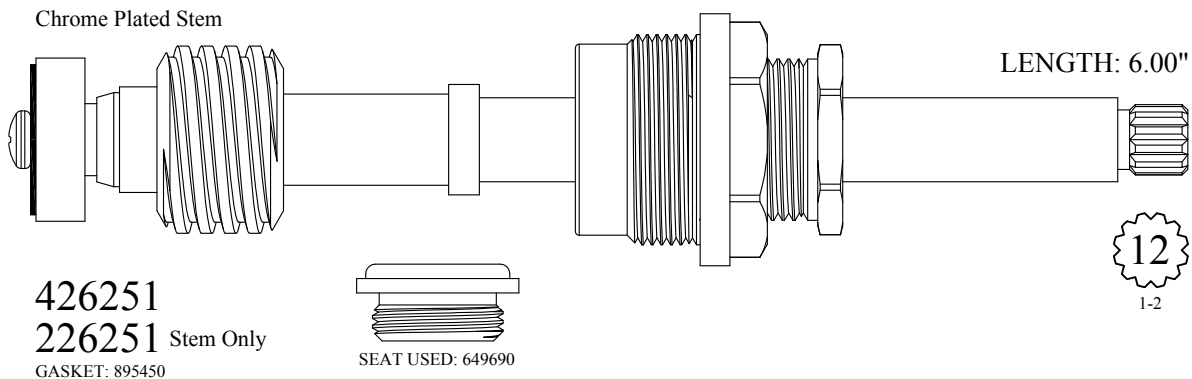

FOR YUGO

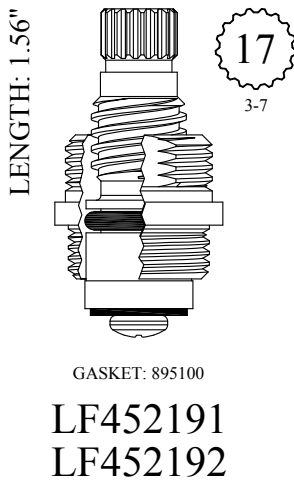

FOR ZURN

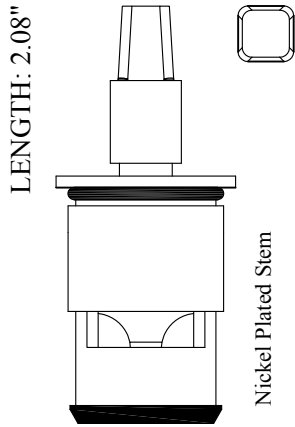

SEAL: 898590
 DISC SET: 151380-PKG
LF459441
LF459442

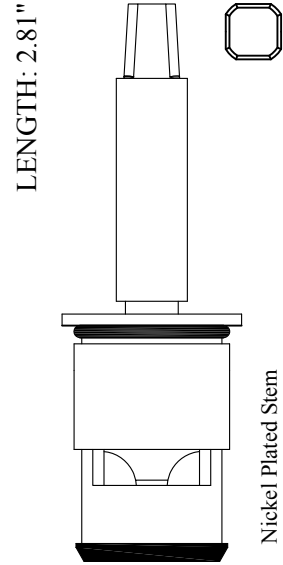

SEAL: 898590
 DISC SET: 151380-PKG
LF465441
LF465442

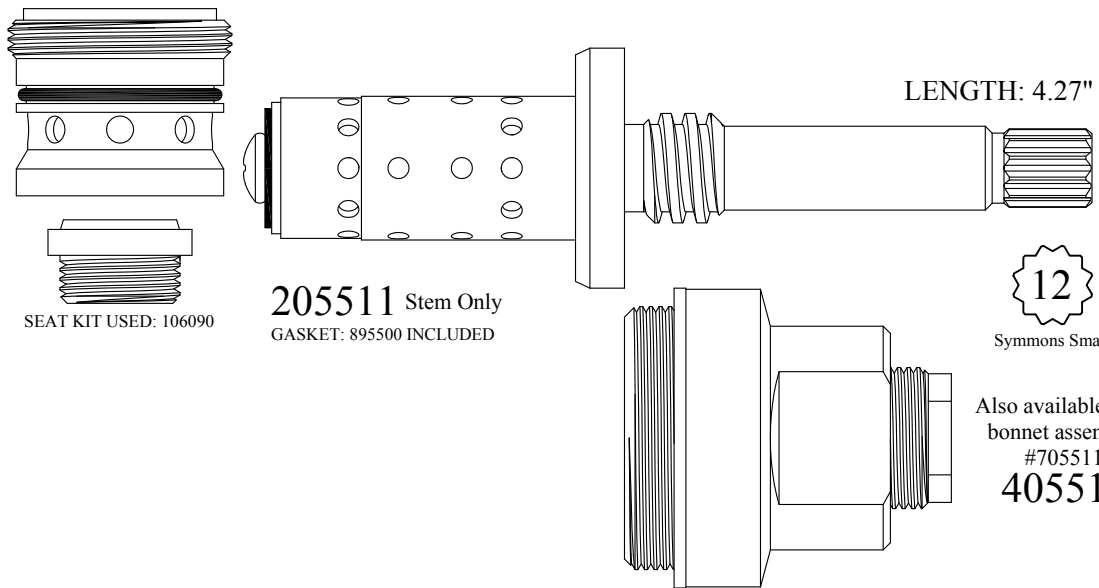

BARRY E.  SR. CO.

UNKNOWN

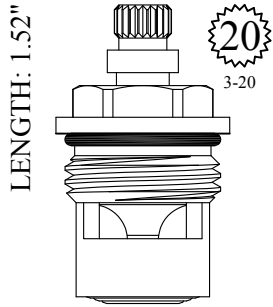

GASKET: 890170 O-RING INCLUDED
SEAL: 898500
DISC SET: 112530-PKG

LF450991
LF450992

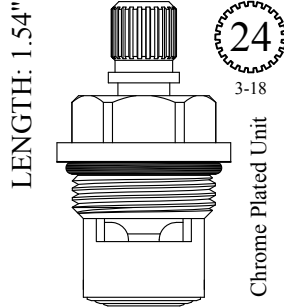

GASKET: 890170 O-RING INCLUDED
SEAL: 898500
DISC SET: 112530-PKG

LF451201
LF451202

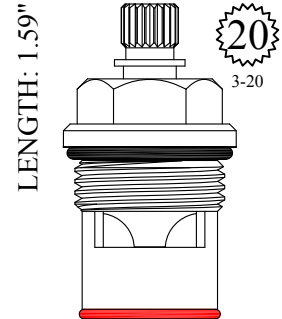

GASKET: 890170 O-RING INCLUDED
SEAL: 898580-R/B
DISC SET: 151380-PKG

LF451261
LF451262

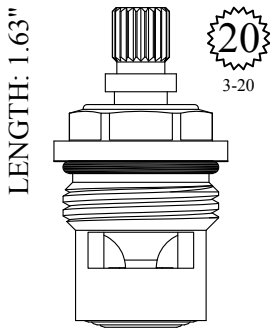

GASKET: 890170 O-RING INCLUDED
SEAL: 898500
DISC SET: 112530-PKG

LF451281
LF451282

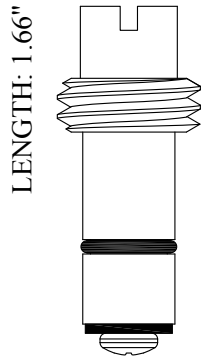

200611

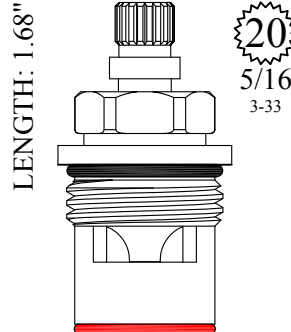

GASKET: 890170 O-RING INCLUDED
SEAL: 898580-R/B
DISC SET: 151380-PKG

LF452611
LF452612

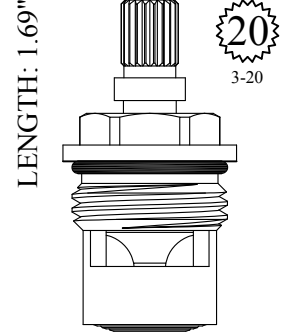

GASKET: 890170 O-RING INCLUDED
SEAL: 898500
DISC SET: 112530-PKG

LF452381
LF452382

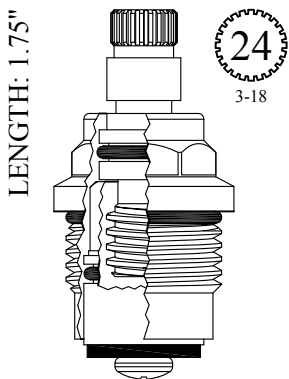

GASKET: 890170 O-RING INCLUDED

LF455422

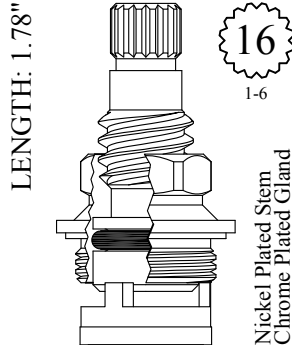

GASKET: 895100

LF455141
LF455142

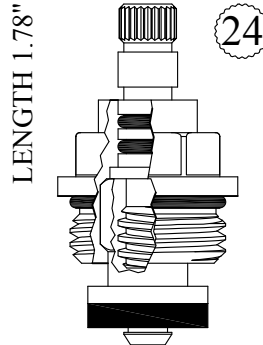

GASKET: 890170 O-RING INCLUDED

LF455942

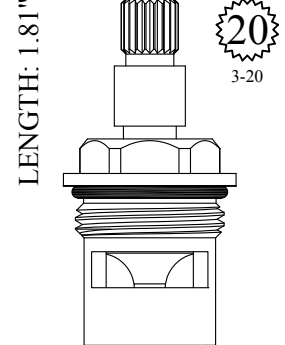

GASKET: 890170 O-RING INCLUDED
SEAL: 898500
DISC SET: 112530-PKG

LF456031
LF456032

UNKNOWN

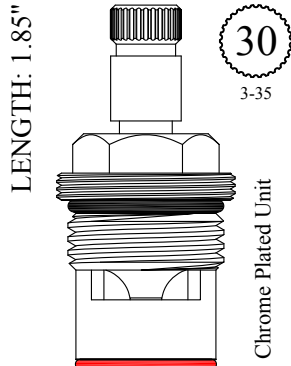

GASKET: 890170 O-RING INCLUDED
SEAL: 898580-R/B
DISC SET: 151380-PKG

LF456481
LF456482

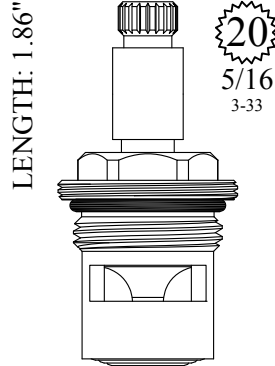

GASKET: 890170 O-RING INCLUDED
SEAL: 898500
DISC SET: 112530-PKG

LF456251
LF456252

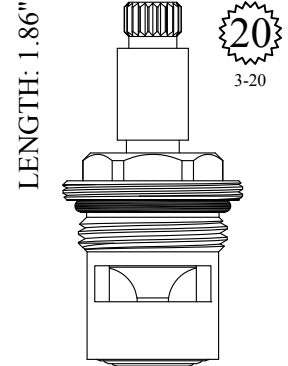

GASKET: 890170 O-RING INCLUDED
SEAL: 898500
DISC SET: 112530-PKG

LF456271
LF456272

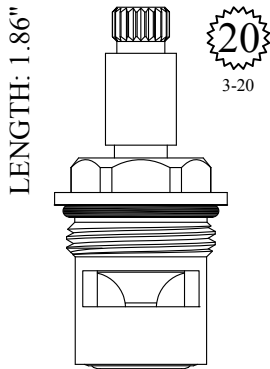

GASKET: 890170 O-RING INCLUDED
SEAL: 898500
DISC SET: 112530-PKG

LF456281
LF456282

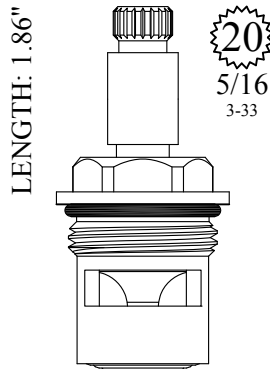

GASKET: 890170 O-RING INCLUDED
SEAL: 898500
DISC SET: 112530-PKG

LF456291
LF456292

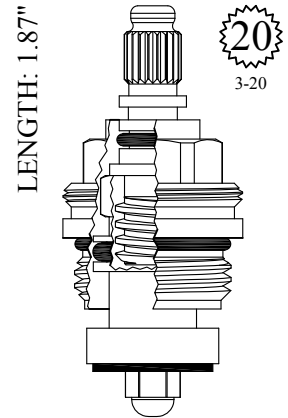

GASKET: 890170 O-RING INCLUDED

LF456462

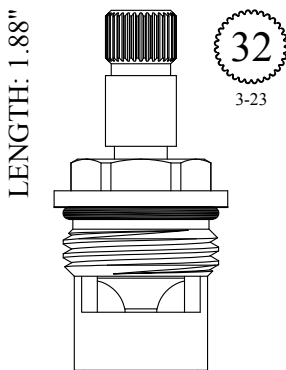

GASKET: 890170 O-RING INCLUDED
SEAL: 898500
DISC SET: 112530-PKG

LF455381
LF455382

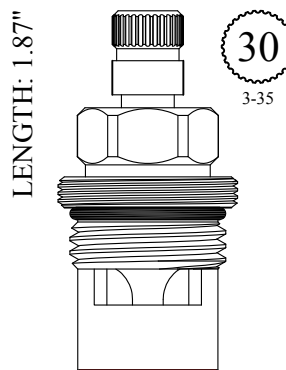

GASKET: 890170 O-RING INCLUDED
SEAL: 898570-R/B
DISC SET: 151380-PKG

LF456411
LF456412

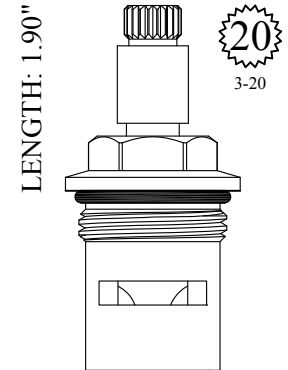

GASKET: 890170 O-RING INCLUDED
SEAL: 898500
DISC SET: 112530-PKG

LF456881
LF456882

UNKNOWN

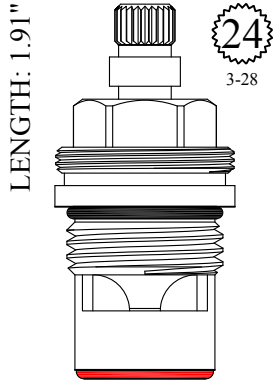

GASKET: 890170 O-RING INCLUDED
SEAL: 898570-R/B
DISC SET: 151380-PKG

LF459131
LF459132

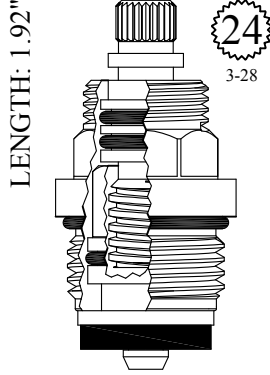

GASKET: 890170 O-RING INCLUDED

LF456422

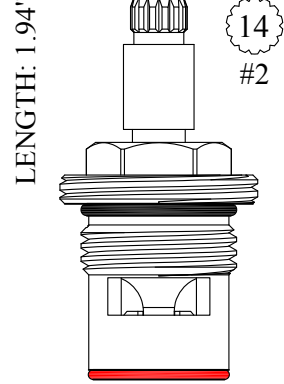

GASKET: 890170 O-RING INCLUDED
SEAL: 898580-R/B
DISC SET: 151380-PKG

LF458431
LF458432

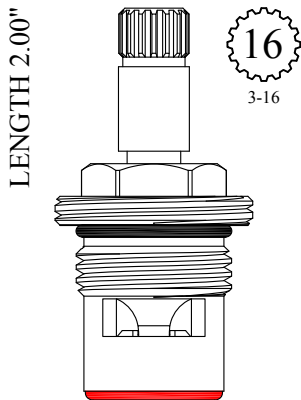

GASKET: 890170 O-RING INCLUDED
SEAL: 898570-R/B
DISC SET: 151380-PKG

LF459431
LF459432

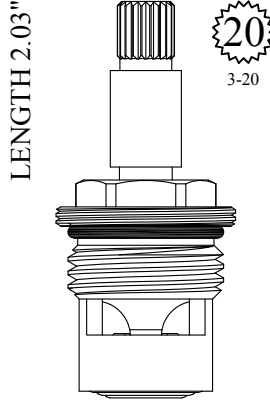

GASKET: 890170 O-RING INCLUDED
SEAL: 898500
DISC SET: 112530-PKG

LF459281
LF459282

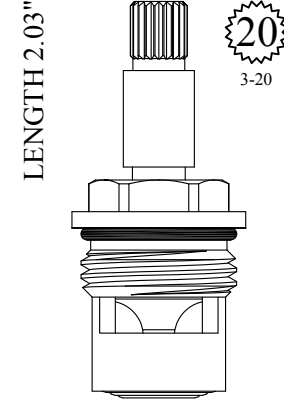

GASKET: 890170 O-RING INCLUDED
SEAL: 898500
DISC SET: 112530-PKG

LF459381
LF459382

UNKNOWN

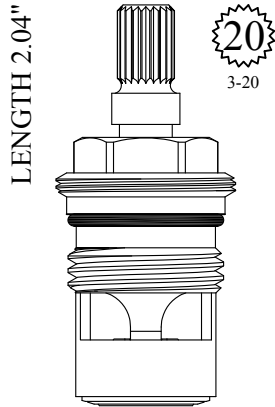

GASKET: 890170 O-RING INCLUDED
SEAL: 898510-W
DISC SET: 151380-PKG

LF459161
LF459162

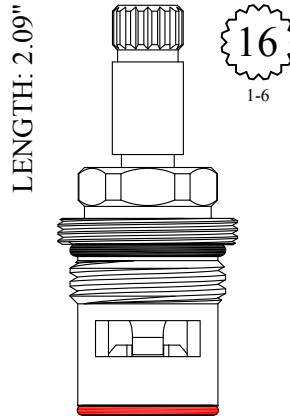

GASKET: 890170 O-RING INCLUDED
SEAL: 898580-R/B
DISC SET: 151380-PKG

LF459531
LF459532

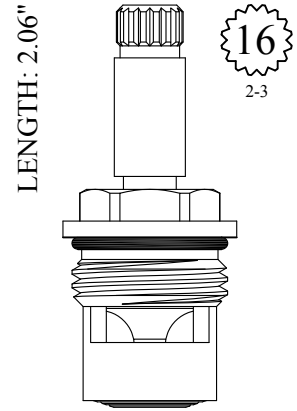

GASKET: 890170 O-RING INCLUDED
SEAL: 898500
DISC SET: 112530-PKG

LF457291
LF457292

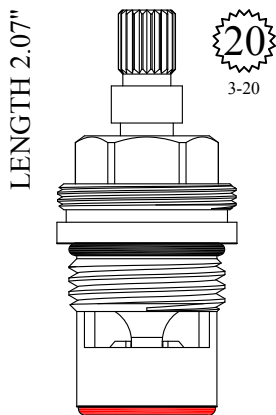

GASKET: 890170 O-RING INCLUDED
SEAL: 898570-R/B
DISC SET: 151380-PKG

LF458861
LF458862

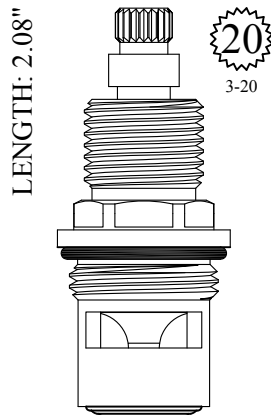

GASKET: 890170 O-RING INCLUDED
SEAL: 898500
DISC SET: 112530-PKG

LF459591
LF459592

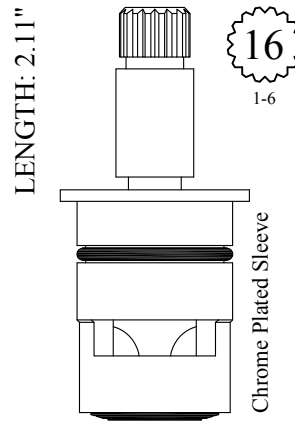

SEAL: 898510
DISC SET: 151380-PKG

LF459641
LF459642

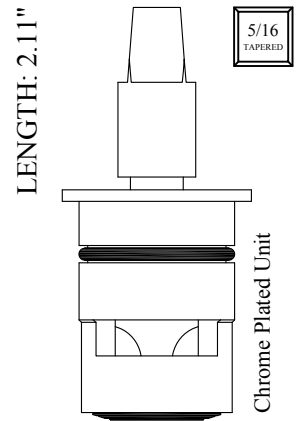

SEAL: 898510
DISC SET: 151380-PKG

LF459671
LF459672

UNKNOWN

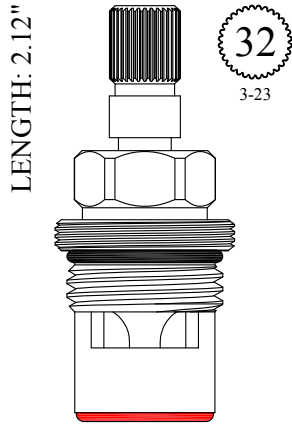

GASKET: 890170 O-RING INCLUDED
SEAL: 898570-R/B
DISC SET: 151380-PKG

LF460371
LF460372

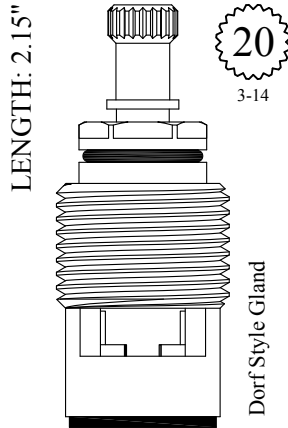

LF458981

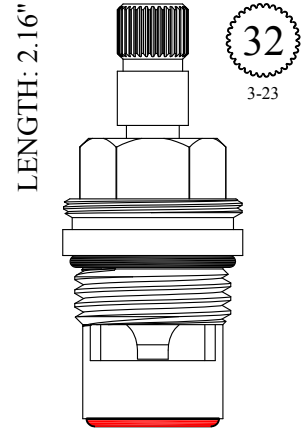

GASKET: 890170 O-RING INCLUDED
SEAL: 898570-R/B
DISC SET: 151380-PKG

LF459361
LF459362

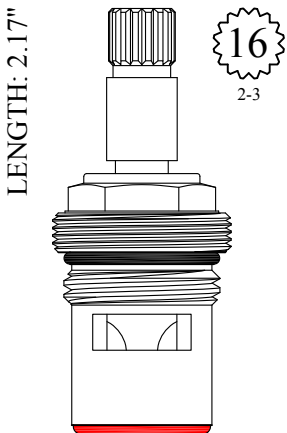

GASKET: 890170 O-RING INCLUDED
SEAL: 898570-R/B
DISC SET: 151380-PKG

LF459661
LF459662

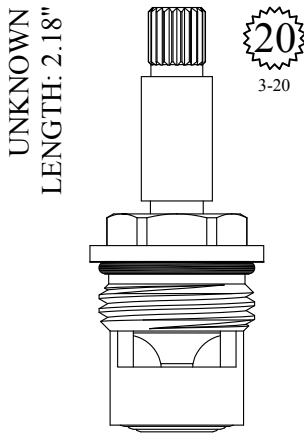

GASKET: 890170 O-RING INCLUDED
SEAL: 898500
DISC SET: 112530-PKG

LF459561
LF459562

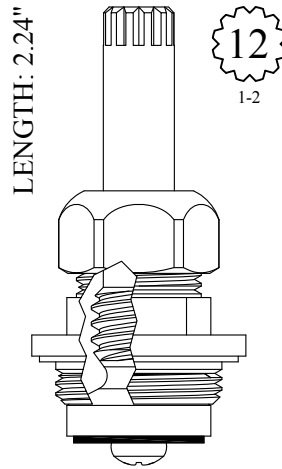

GASKET: 895400

191041

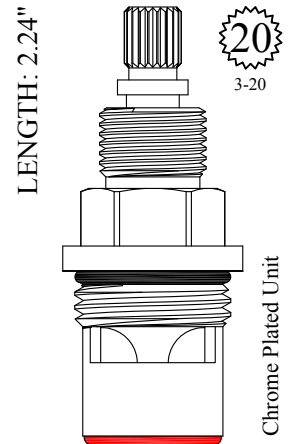

GASKET: 890170 O-RING INCLUDED
SEAL: 898570-R/B
DISC SET: 151380-PKG

LF460341
LF460342

UNKNOWN

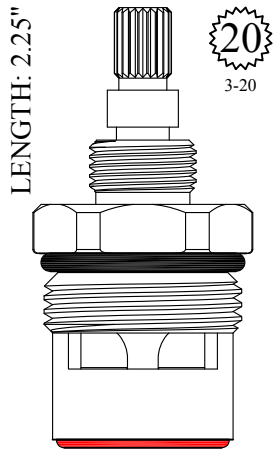

GASKET: 890170 O-RING INCLUDED
SEAL: 898610-R/B
DISC SET: 109850-PKG

401441
401442

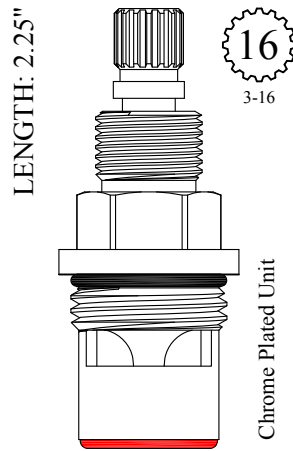

GASKET: 890170 O-RING INCLUDED
SEAL: 898570-R/B
DISC SET: 151380-PKG

LF461341
LF461342

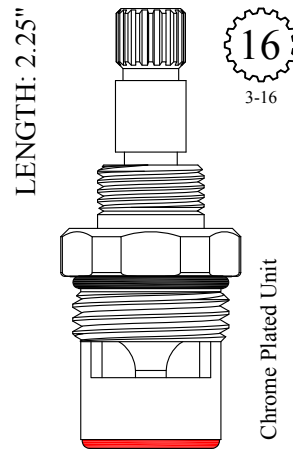

GASKET: 890170 O-RING INCLUDED
SEAL: 898570-R/B
DISC SET: 151380-PKG

LF462311
LF462312

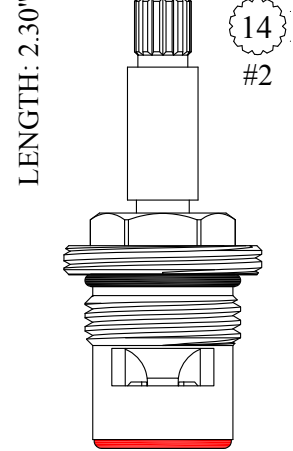

GASKET: 890170 O-RING INCLUDED
SEAL: 898570-R/B
DISC SET: 151380-PKG

LF462431
LF462432

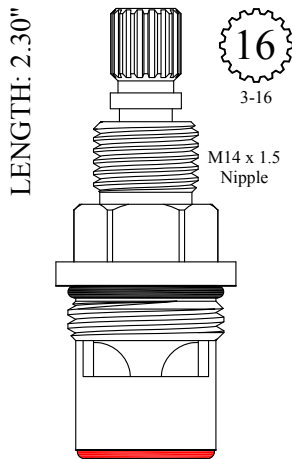

GASKET: 890170 O-RING INCLUDED
SEAL: 898570-R/B
DISC SET: 151380-PKG

LF462641
LF462642

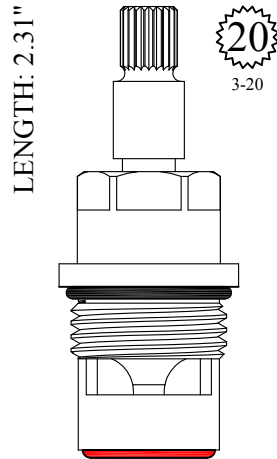

GASKET: 890170 O-RING INCLUDED
SEAL: 898570-R/B
DISC SET: 151380-PKG

LF461401
LF461402

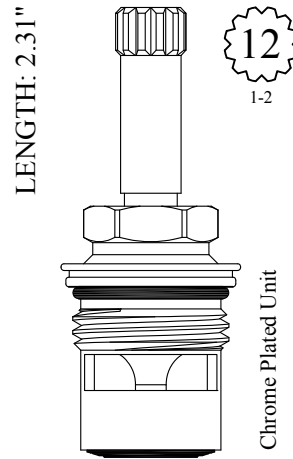

GASKET: 890170 O-RING INCLUDED
SEAL: 898510
DISC SET: 151380-PKG

LF462551
LF462552

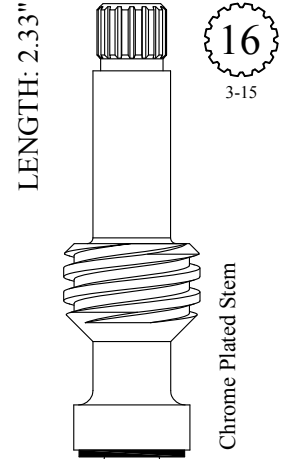

201191
201192

UNKNOWN

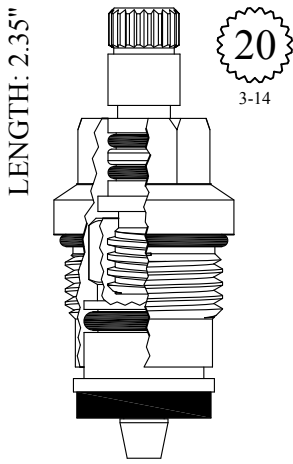

GASKET: 890180 O-RING INCLUDED

LF459482

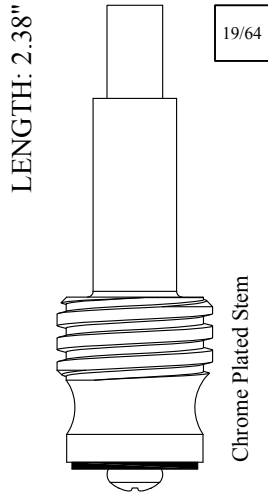

201331

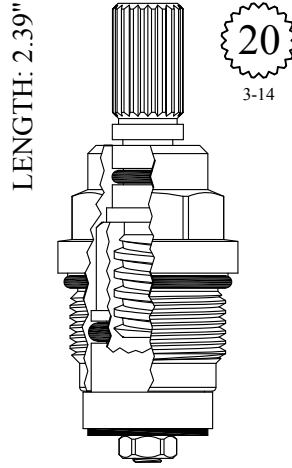

GASKET: 890180 O-RING INCLUDED

LF460272

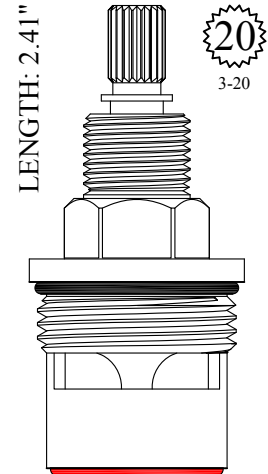

GASKET: 890210 INCLUDED
SEAL: 898610-R/B
DISC SET: 109850-PKG

400961
400962

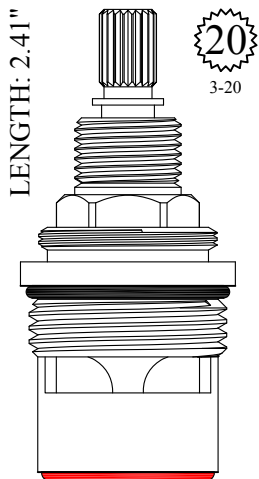

GASKET: 890210 INCLUDED
SEAL: 898610-R/B
DISC SET: 109850-PKG

400991
400992

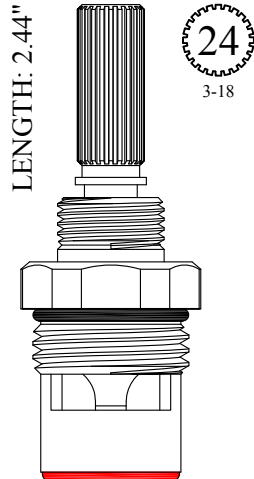

GASKET: 890170 O-RING INCLUDED
SEAL: 898570-R/B
DISC SET: 151380-PKG

LF463661
LF463662

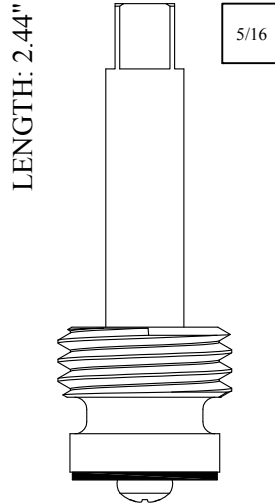

152981

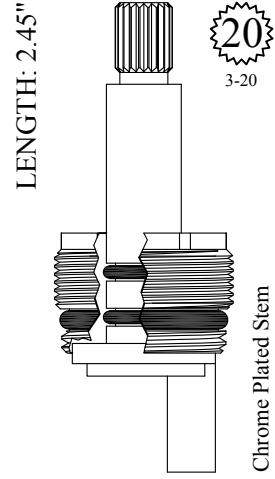

GASKET: 891150 O-RING INCLUDED

431100

UNKNOWN

LENGTH: 2.52"

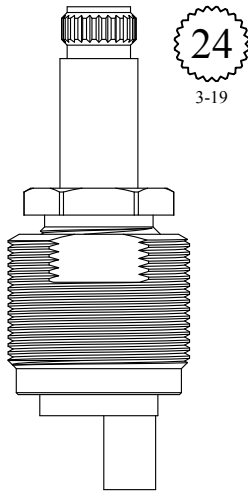

430680
230680 Stem Only

LENGTH: 2.52"

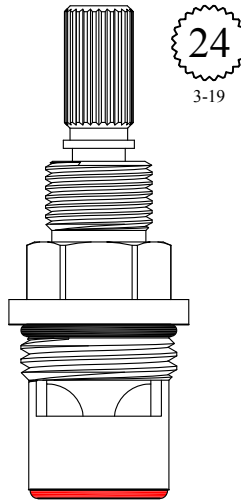

GASKET: 890170 O-RING INCLUDED
SEAL: 898570-R/B
DISC SET: 151380-PKG

LF464351
LF464352

LENGTH: 2.53"

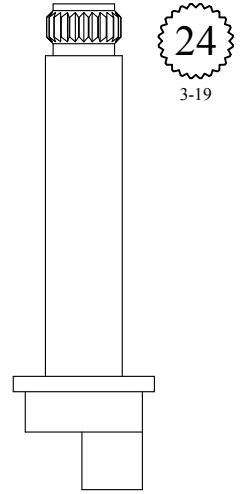

230890

LENGTH: 2.72"

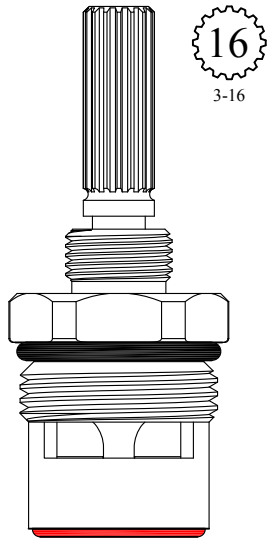

GASKET: 891180 O-RING INCLUDED
SEAL: 898610-R/B
DISC SET: 109850-PKG

401561
401562

LENGTH: 2.78"

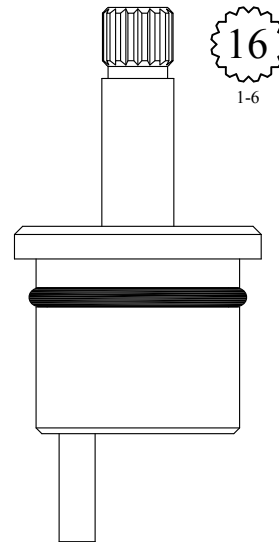

230860

UNKNOWN

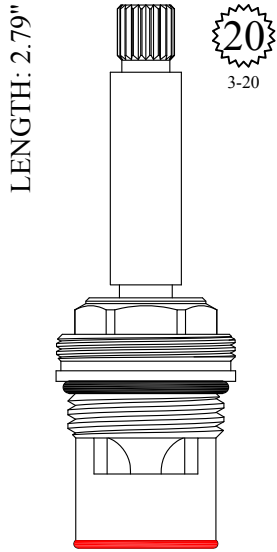

20
3-20

GASKET: 890170 O-RING INCLUDED
SEAL: 898580-R/B
DISC SET: 151380-PKG

LF465331
LF465332

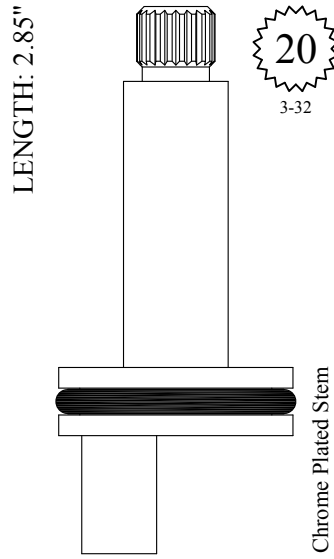

20
3-32

Chrome Plated Stem

231090

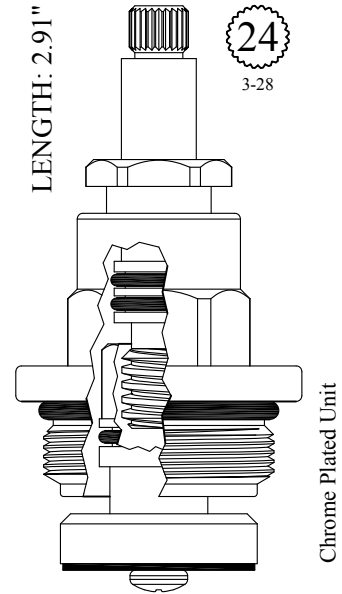

24
3-28

Chrome Plated Unit

GASKET: 891210 O-RING INCLUDED

401922

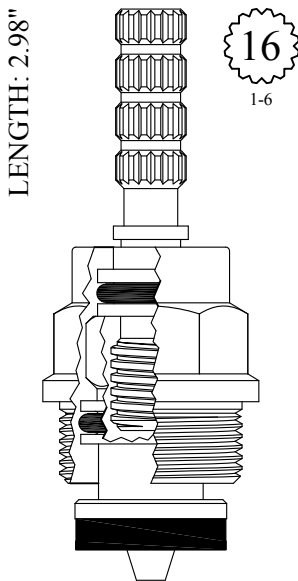

16
1-6

GASKET: 895330

LF465702

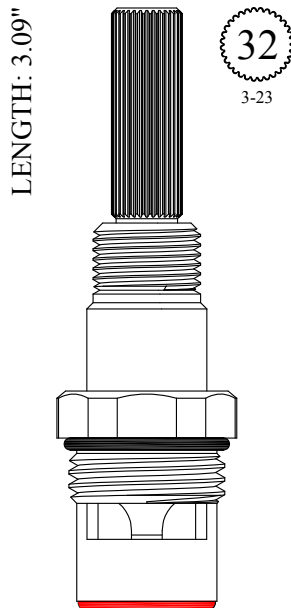

32
3-23

GASKET: 890170 O-RING INCLUDED
SEAL: 898570-R/B
DISC SET: 151380-PKG

LF466441
LF466442

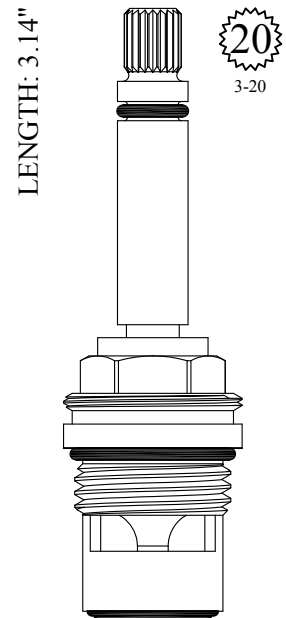

20
3-20

GASKET: 890170 O-RING INCLUDED
SEAL: 898510
DISC SET: 151380-PKG

LF466921
LF466922

UNKNOWN

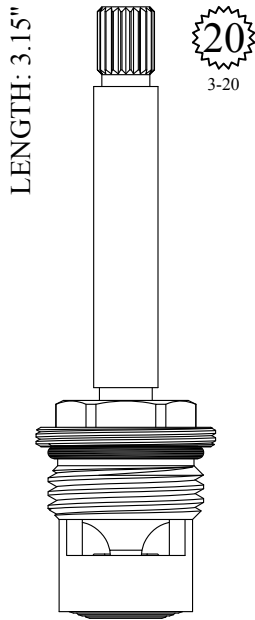

GASKET: 890170 O-RING INCLUDED
SEAL: 898500
DISC SET: 151380-PKG

LF467381
LF467382

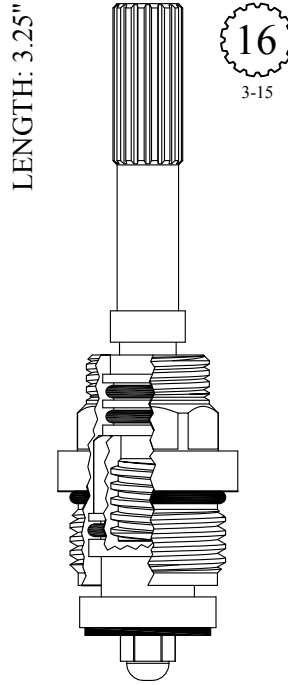

GASKET: 890170 O-RING INCLUDED

402472

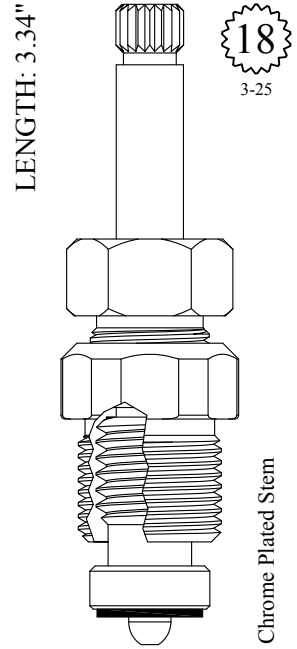

GASKET: 895100

LF466811

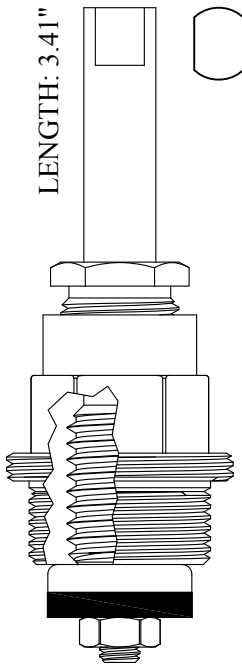

GASKET: 895330

401751

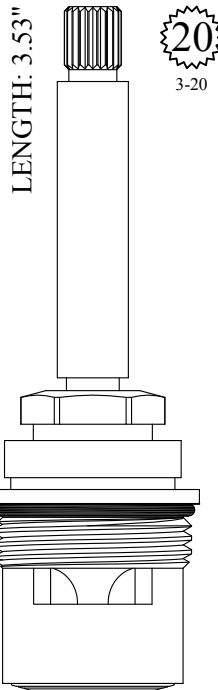

GASKET: 890210 O-RING INCLUDED
SEAL: 898520
DISC SET: 109850-PKG

402571
402572

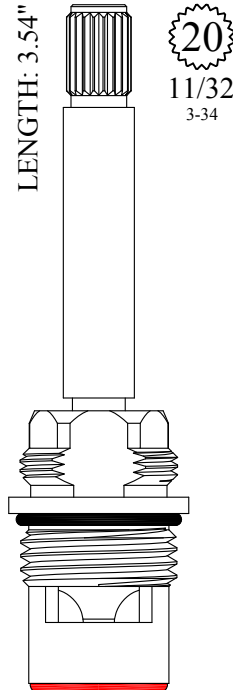

GASKET: 890170 O-RING INCLUDED
SEAL: 898570-R/B
DISC SET: 151380-PKG

LF468221
LF468222

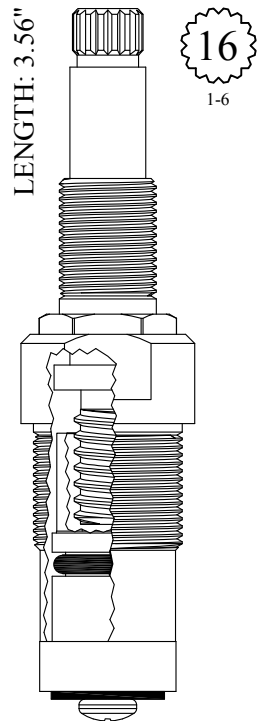

GASKET: 895140

402782

UNKNOWN

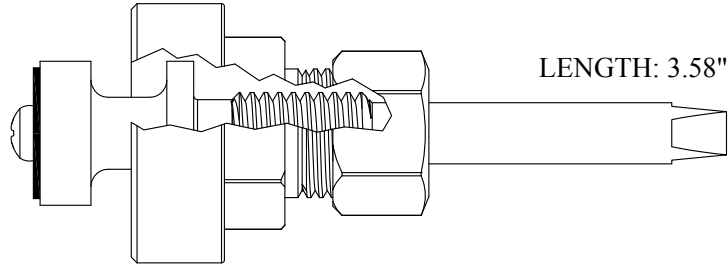

468231

GASKET: 894970 INCLUDED

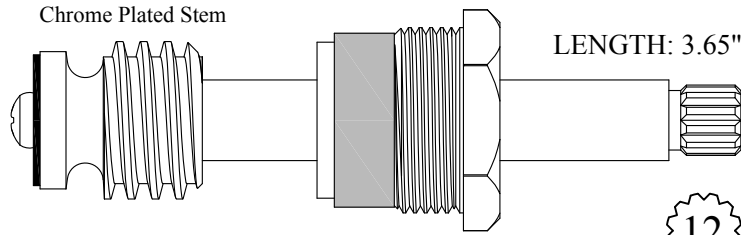

LF469221

LF269221 Stem Only

12
1-2

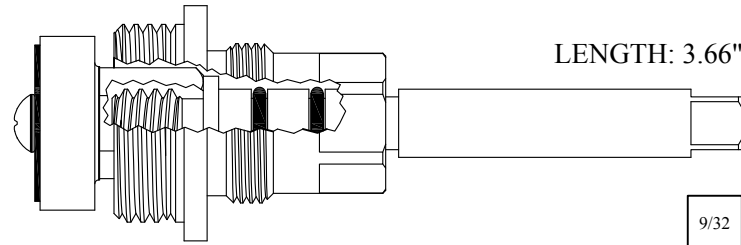

403062

GASKET: 895560

9/32

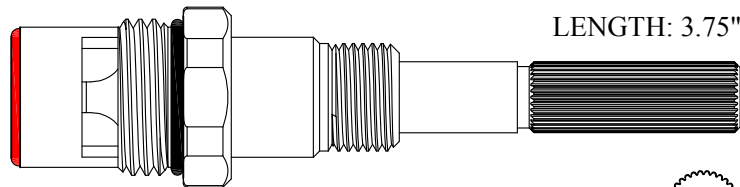

LF468441/ LF468442

GASKET: 890170 O-RING INCLUDED
SEAL: 898570-R/B
DISC SET: 151380-PKG

32
3-23

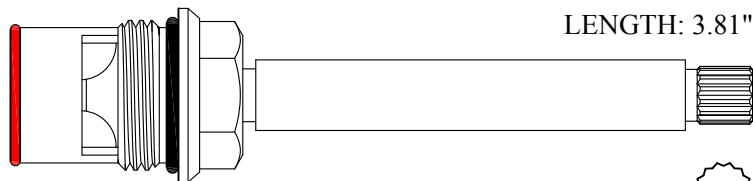

LF403461/ LF403462

GASKET: 890170 O-RING INCLUDED
SEAL: 898580-R/B
DISC SET: 151380-PKG

14
5/16

UNKNOWN

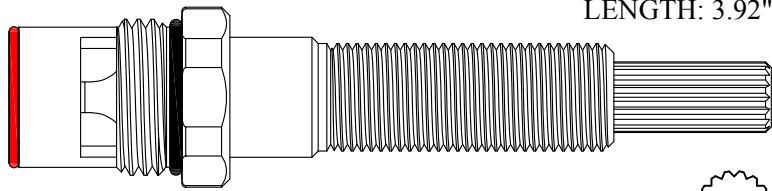

LENGTH: 3.92"

403631/ 403632

GASKET: 890170 O-RING INCLUDED
SEAL: 898580-R/B
DISC SET: 151380-PKG

16
1-6

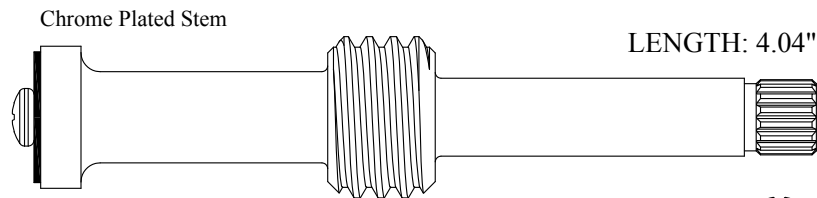

Chrome Plated Stem

LENGTH: 4.04"

204061

Supplied with
12pt. Broach



12
1-2

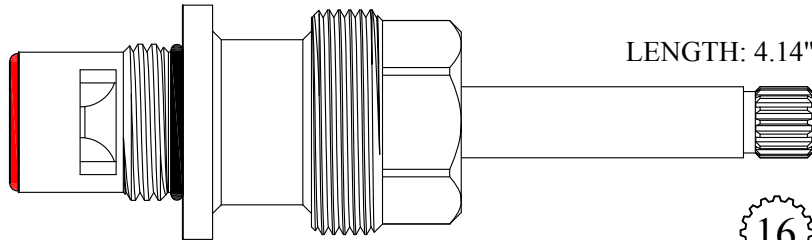

LENGTH: 4.14"

404301/ 404302

GASKET: 890170 O-RING INCLUDED
SEAL: 898580-R/B
DISC SET: 151380-PKG

16
3-16

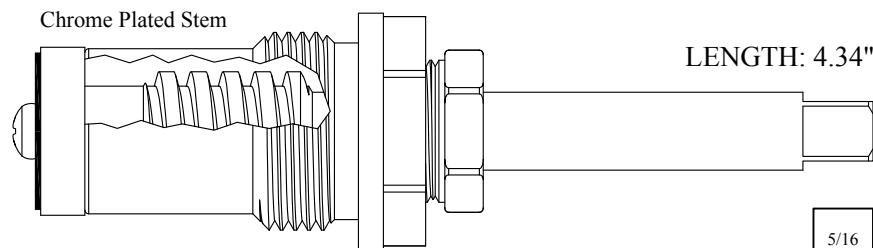

Chrome Plated Stem

LENGTH: 4.34"

405321

205321 Stem Only

GASKET: 895560

5/16

UNKNOWN

Chrome Plated Stem

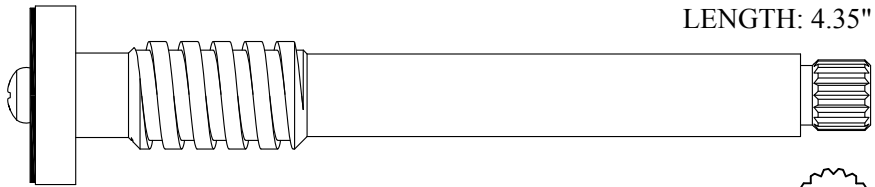

LENGTH: 4.35"

206211

16
1-6

Chrome Plated Stem

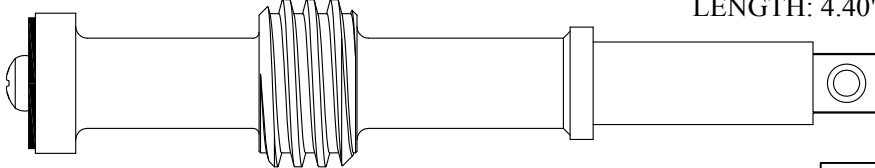

LENGTH: 4.40"

205831

5/16

LENGTH: 4.01"

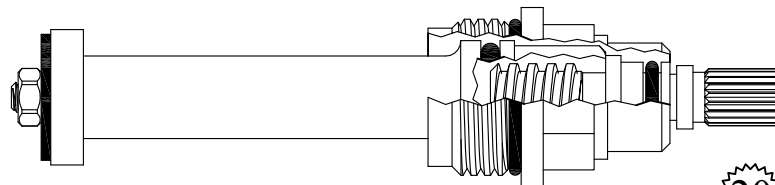

426812

GASKET: 890170 O-RING INCLUDED

20
3-20

LENGTH: 4.52"

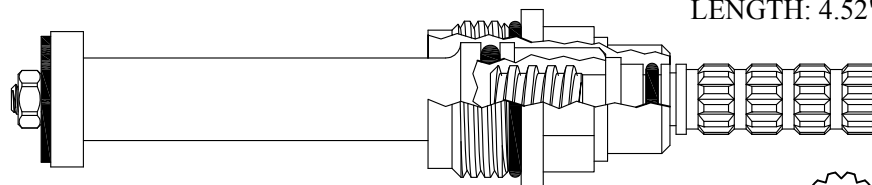

426862

GASKET: 890170 O-RING INCLUDED

12
1-2

UNKNOWN

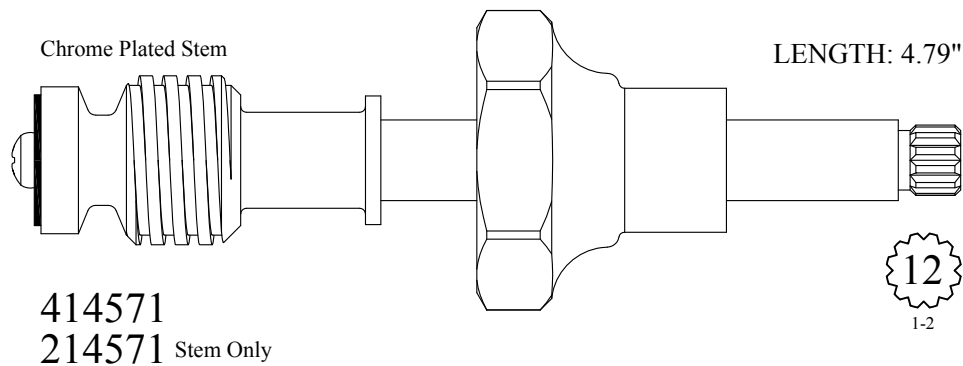
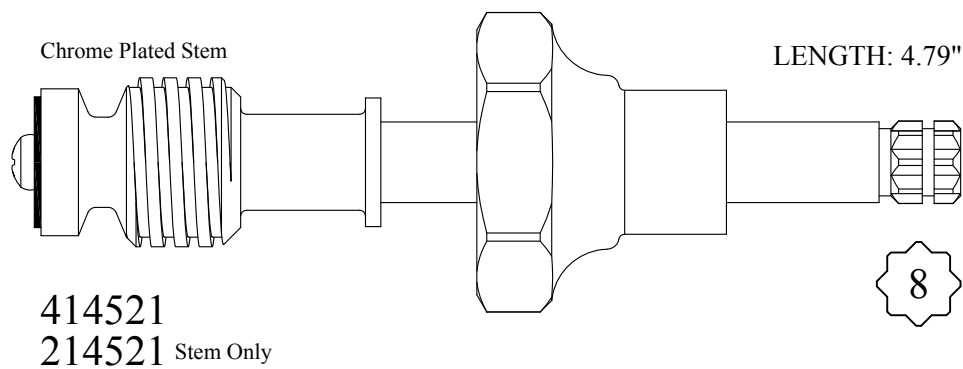
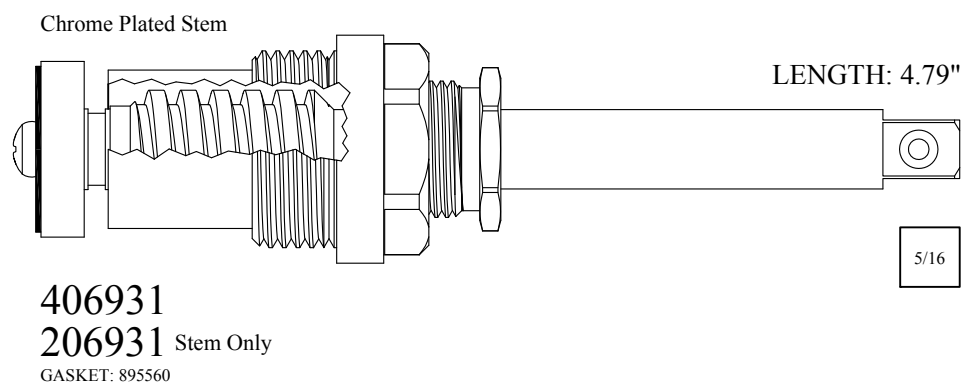
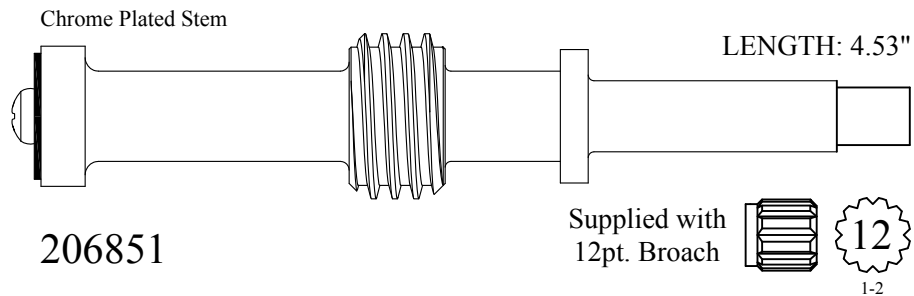

Send Your Orders To:

BARRY E.  SR. CO.

E-mail: orderdesk@barrywalter.com

Fax: 1.800.886.9831

Phone: 1.800.767.5552



Quality Replacement Parts

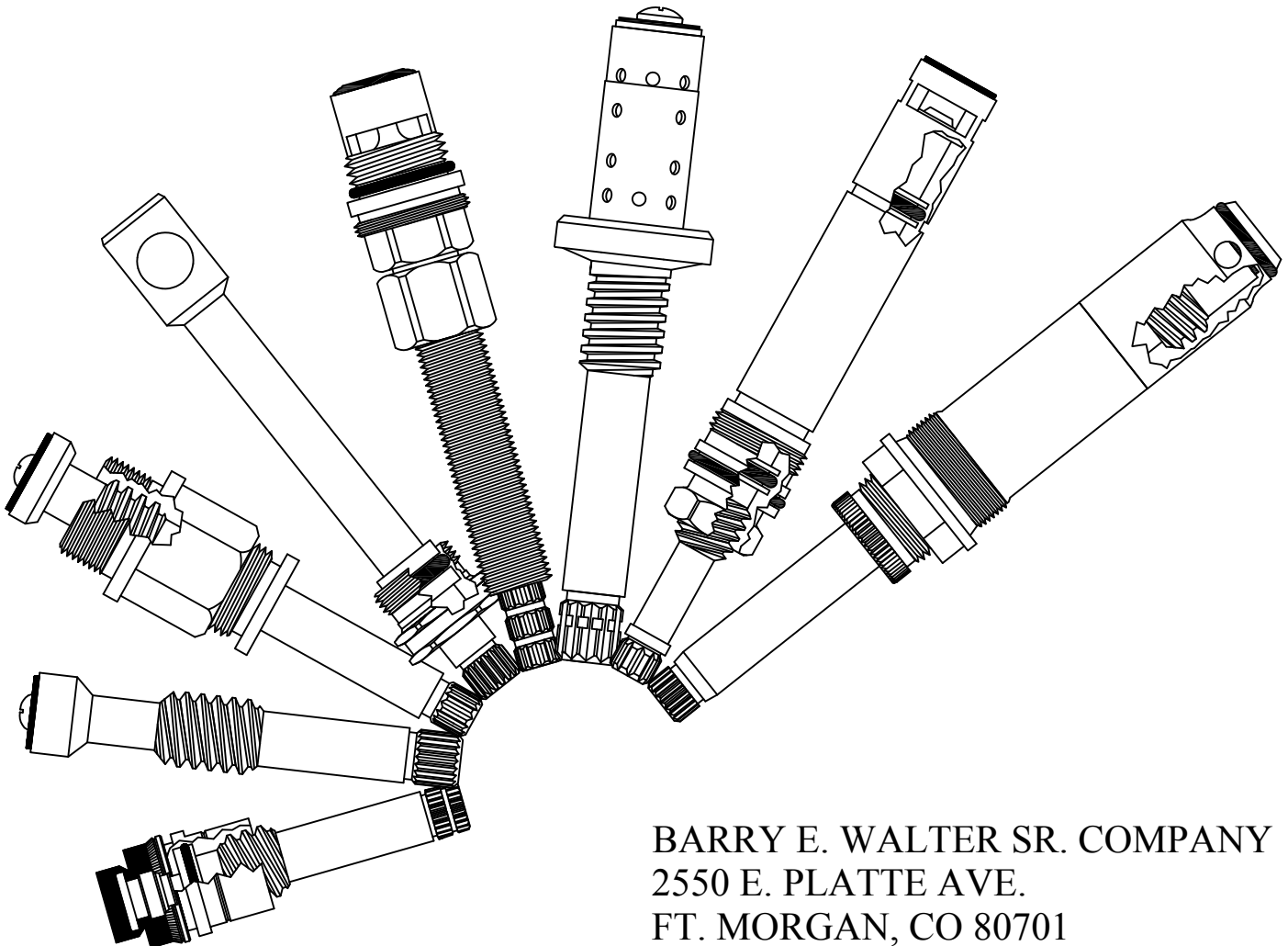

BARRY E. WALTER SR. COMPANY
2550 E. PLATTE AVE.
FT. MORGAN, CO 80701

We are always adding new parts. Check our website for updates.

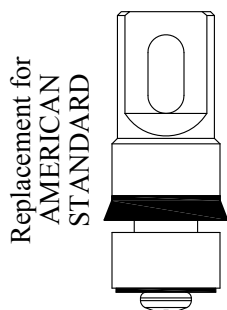

Replacement for
AMERICAN
STANDARD

640010
OEM# 8339-07
SEAT: 649370

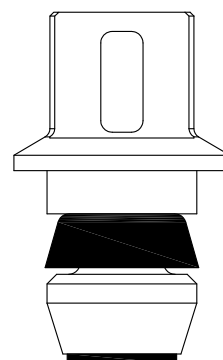

640320
OEM# 50
SEAT: 647980

**CHECK OUT OUR WEBSITE
FOR MORE BALLCOCK PLUNGERS**

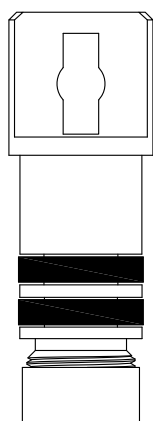

640300
OEM# 41 5/8"

Replacement for
UNIVERSAL
RUNDLE

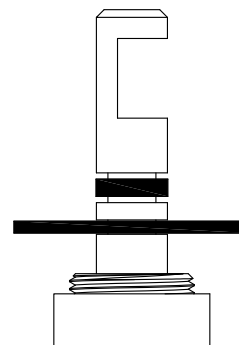

640400
OEM# A369
SEAT: 647830

BARRY E.  SR. CO.

UNKNOWN

Chrome Plated Stem

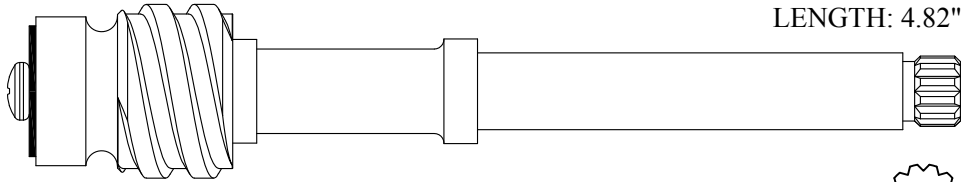

LENGTH: 4.82"

209451



1-2

Chrome Plated Stem

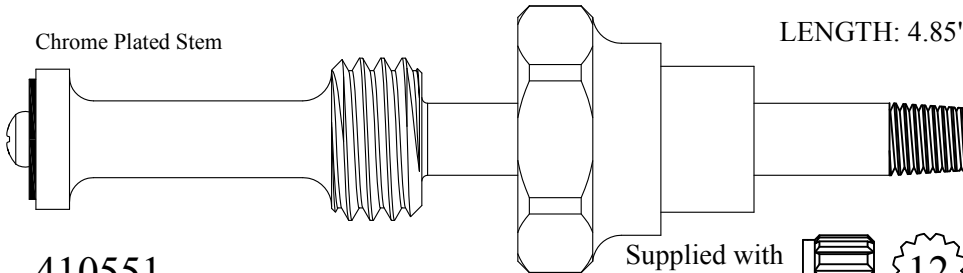

LENGTH: 4.85"

410551

210551 Stem Only

Supplied with
12pt. Broach



1-2

3/8M Bibb Washer
Chrome Plated Stem

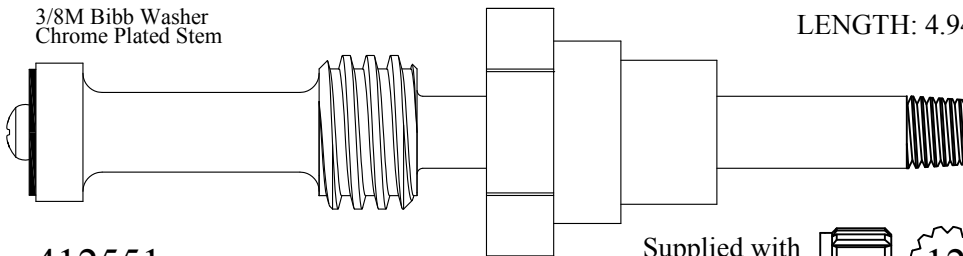

LENGTH: 4.94"

412551

212551 Stem Only

Supplied with
12pt. Broach



1-2

1/4L Bibb Washer
Chrome Plated Stem

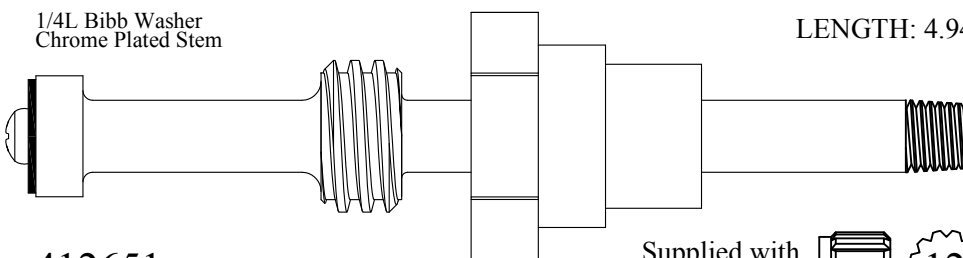

LENGTH: 4.94"

412651

212651 Stem Only

Supplied with
12pt. Broach



1-2

Chrome Plated Unit

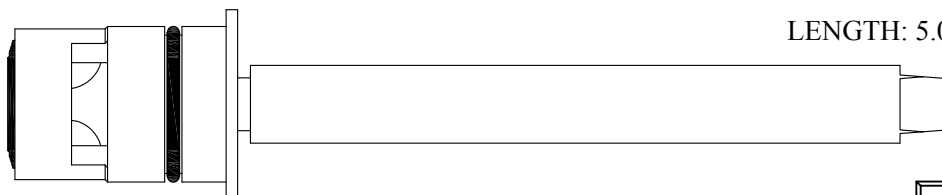

LENGTH: 5.00"

412641/ 412642

SEAL: 898510
DISC SET: 151380-PKG



UNKNOWN

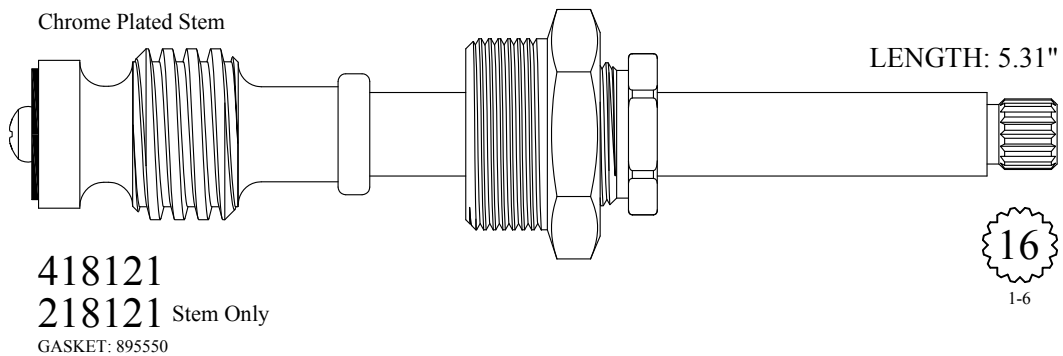
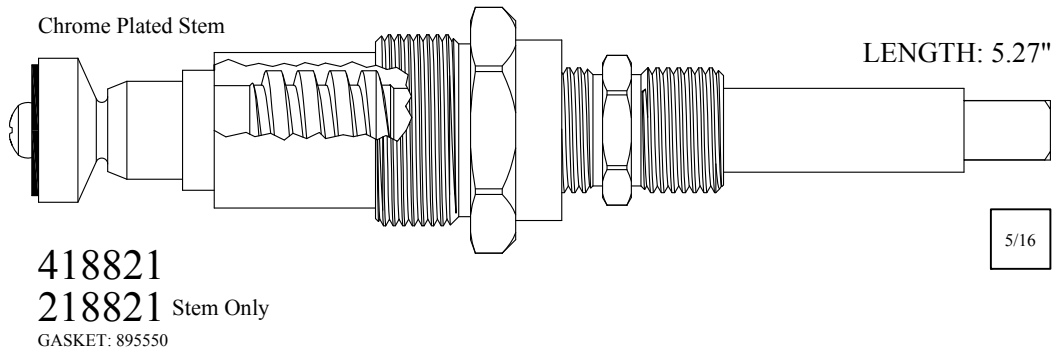
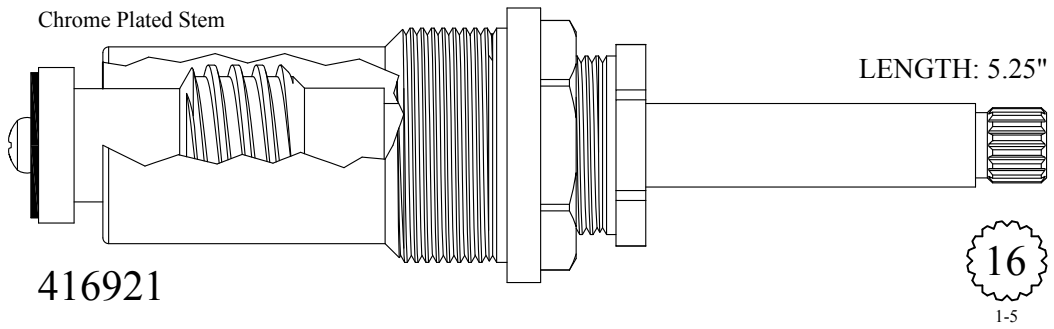
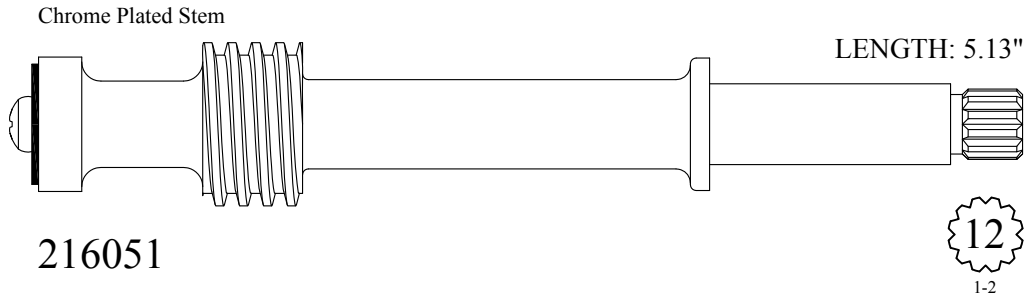
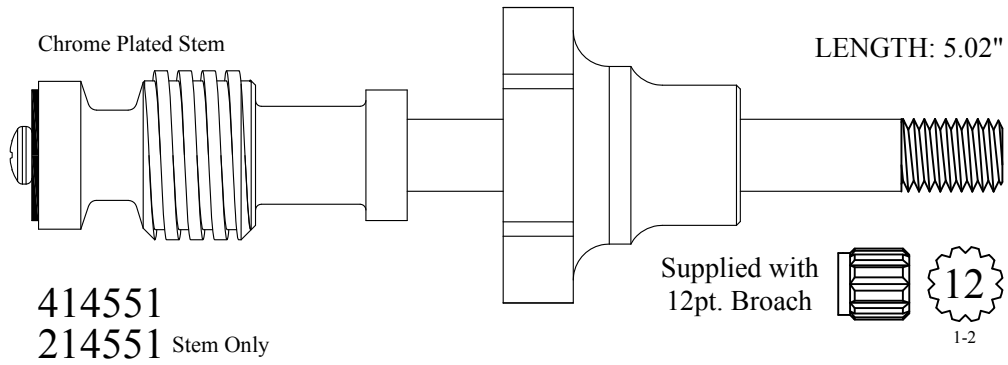

UNKNOWN

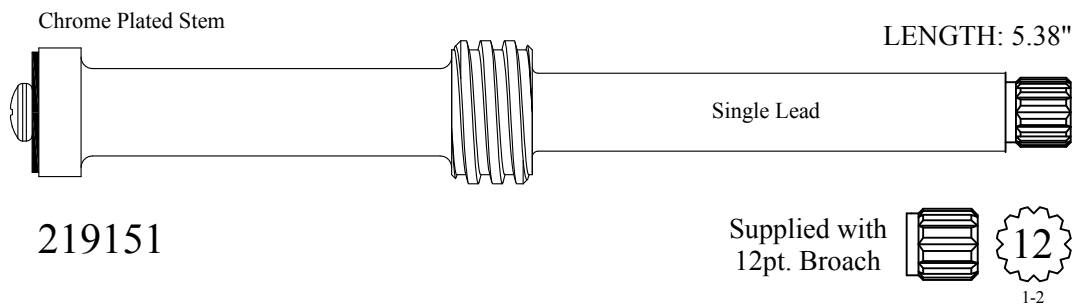
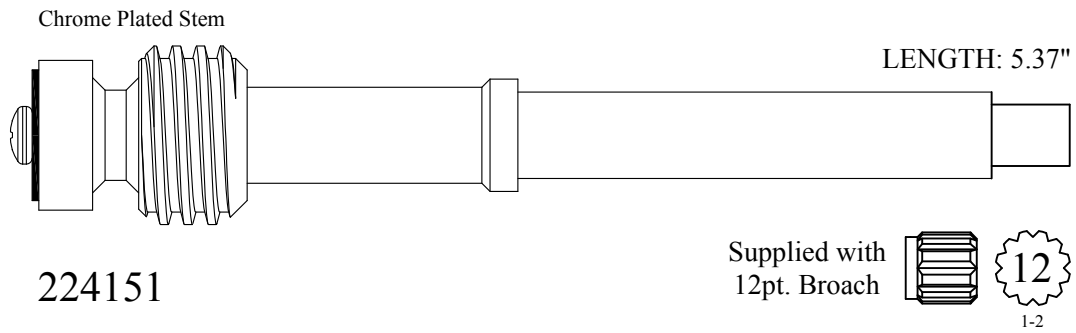
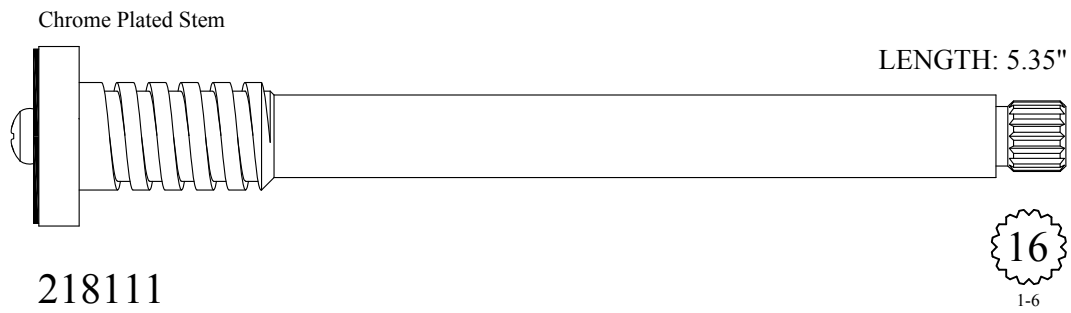
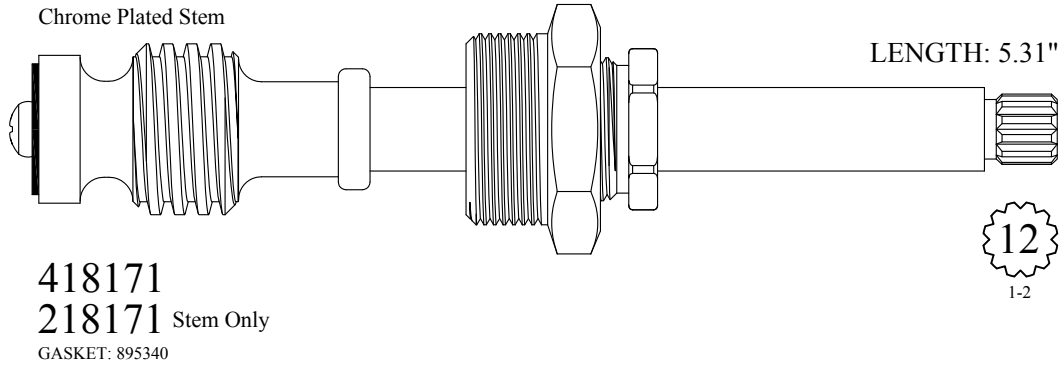

UNKNOWN

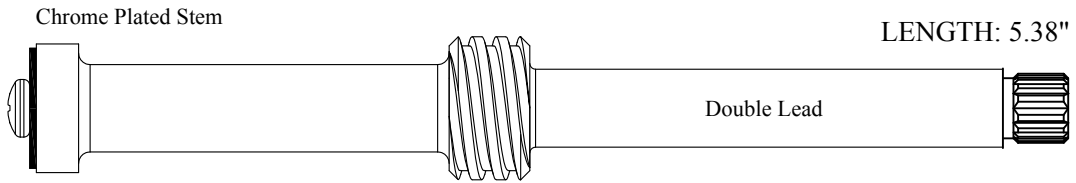

219161/ 219162

Supplied with
12pt. Broach

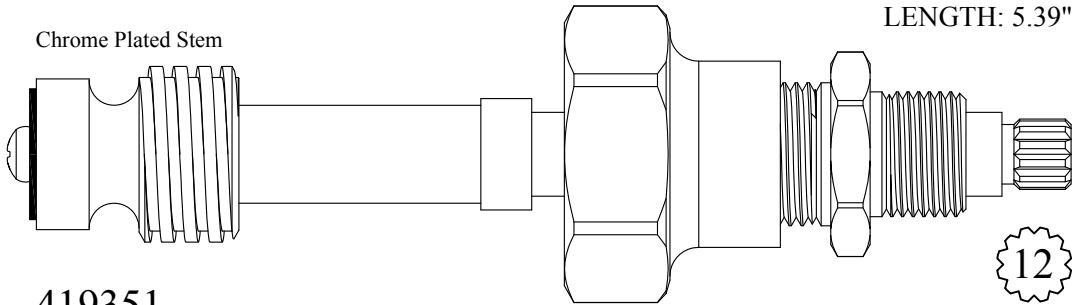
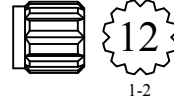

419351
219351 Stem Only

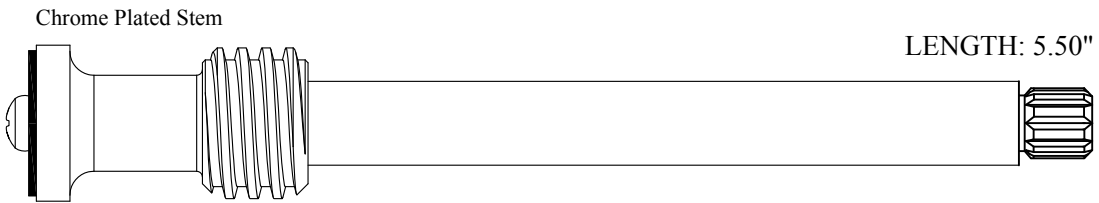

221021

Supplied with
12pt. Broach

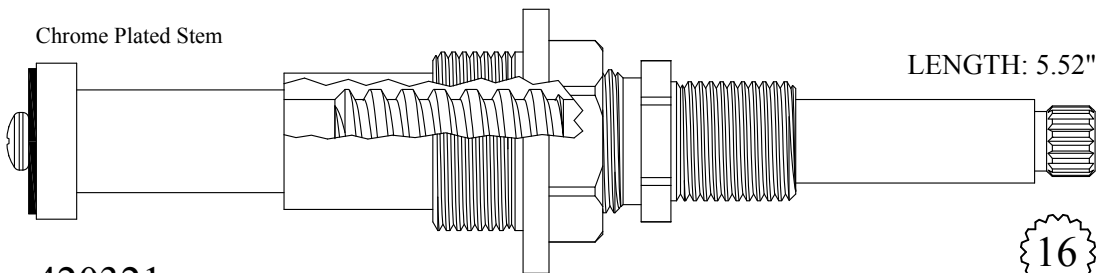
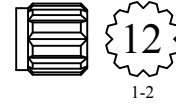

420321
GASKET: 895370

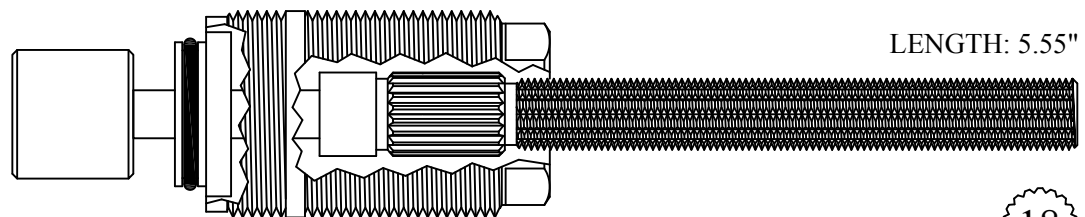

434610



UNKNOWN

Chrome Plated Stem

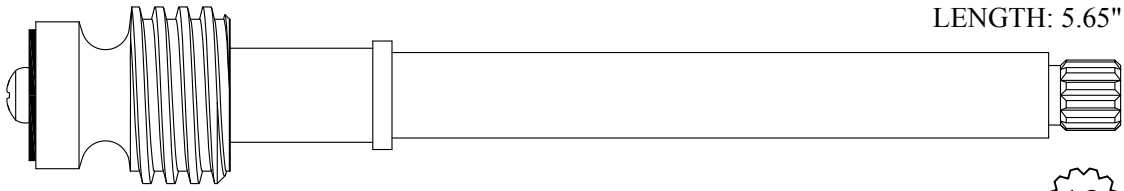

LENGTH: 5.65"

223751

12
1-2

Chrome Plated Stem

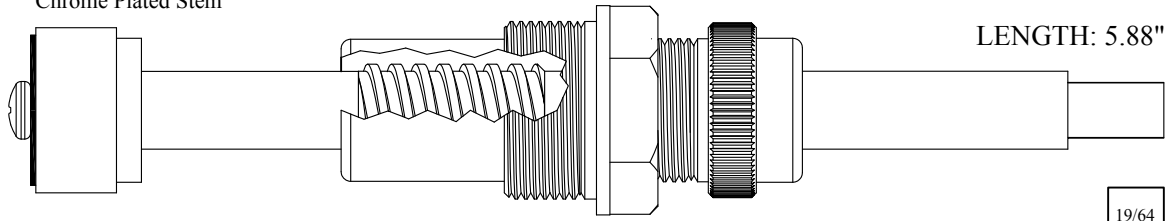

LENGTH: 5.88"

426261

19/64

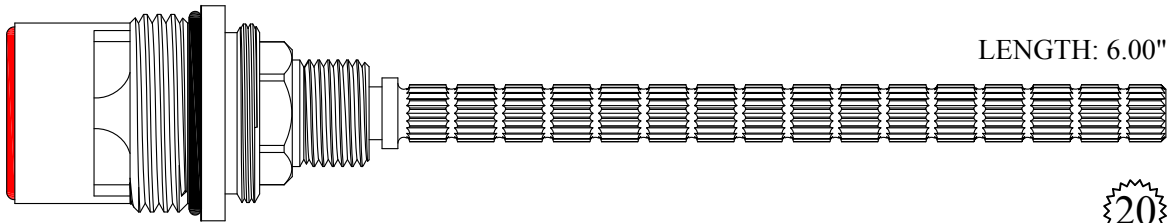

LENGTH: 6.00"

423671/ 423672

GASKET: 890170 O-RING INCLUDED
SEAL: 898610-R/B
DISC SET: 109850-PKG

20
3-20

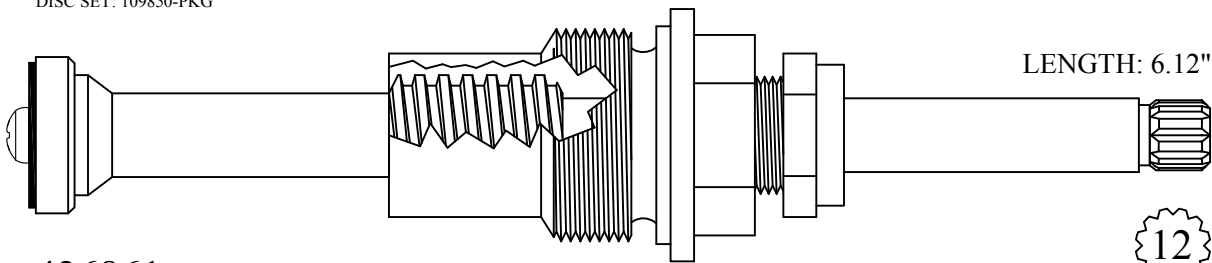

LENGTH: 6.12"

426861

GASKET: 895450

12
1-2

Chrome Plated Stem

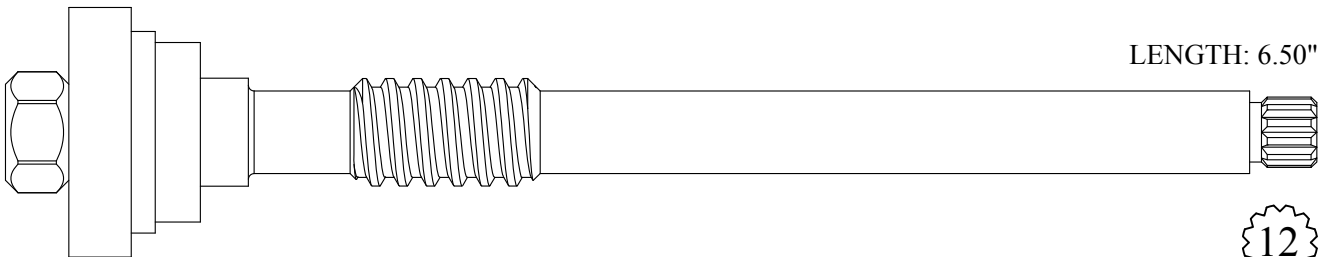

LENGTH: 6.50"

227461

12
1-2