

SINGLE LEVER COMPONENTS

STOP FOR DANZE/
GERBER/PEGASUS



CC19056-3

TEMPURATURE RING
FOR S/L CARTRIDGES



CC-RING

TEMPURATURE RING
FORT & S CARTRIDGES



PBCV-RING

CHECK VALVE FOR DELTA



OEM # RP73625

CC19054-CV

MIXER FOR PRESSURE
BALANCE VALVES

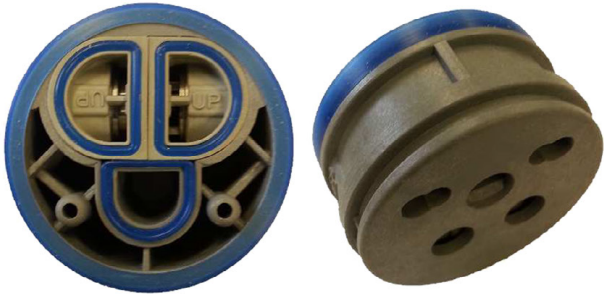

CC-MIX

CHECK VALVE FOR 40mm
PRESSURE BALANCE VALVES



CC19079-CV

CHECK VALVE FOR 40mm
PRESSURE BALANCE VALVES



PBCV-CV

SINGLE LEVER MIXER FOR
PRESSURE BALANCE VALVES



PBCV-MIX

SINGLE LEVER COMPONENTS

PRESSURE BALANCE
CARTRIDGE FOR KOHLER

PRESSURE BALANCE
MIXER FOR PRICE PFISTER



OEM # GP500520
KO11182

OEM # C974-291
PP11695

PRESSURE BALANCE
CARTRIDGE FOR KOHLER



OEM # GP800820
KO11186

PRESSURE BALANCE
MIXER FOR PEGASUS

PRESSURE BALANCE
MIXER FOR PRICE PFISTER

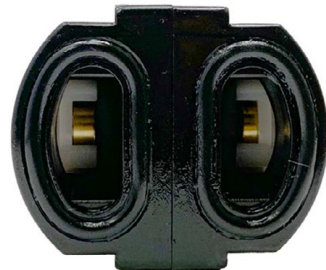
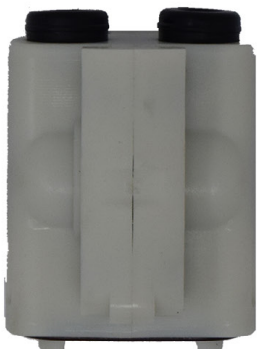

PE-BALMIX

OEM # 974-491
PP11693

SINGLE LEVER COMPONENTS

FOR AMERICAN STANDARD
LENGTH: 57mm / 2.26"



OEM # 077171-0070A

AS10183

FOR AMERICAN STANDARD
LENGTH: 61mm / 2.415"



OEM # 51091-0070A

AS10181

FOR AMERICAN STANDARD
LENGTH: 65mm / 2.54"



OEM # M952100-0070A

AS10182

FOR GERBER
LENGTH: 90mm / 3.56"



OEM # 97-013
GE10780

FOR GERBER
LENGTH: 90mm / 3.56"



OEM # 97-014
GE10781

SINGLE LEVER CARTRIDGES

FOR SIGMA
LENGTH: 42mm / 1.635"



DIAMETER: 22mm
OEM #18.30.219

CC19100

VARIOUS MANUFACTURERS
LENGTH: 42mm / 1.65"



DIAMETER: 22mm
DIVERTER

CC19003

FOR DELTA
LENGTH: 49mm / 1.90"



OEM # RP20111
CONVERSION BALL
DE10487

VARIOUS MANUFACTURERS
LENGTH: 49mm / 1.93"



DIAMETER: 25mm

CC19002

FOR PRICE PFISTER
LENGTH: 50mm / 1.97"



DIAMETER: 25mm
PP OEM # 974-074

FITS VARIOUS MANUFACTURERS

CC19001

FOR PEGASUS
LENGTH: 50mm / 1.975"



PE11502

FOR PEGASUS
LENGTH: 50mm / 1.98"

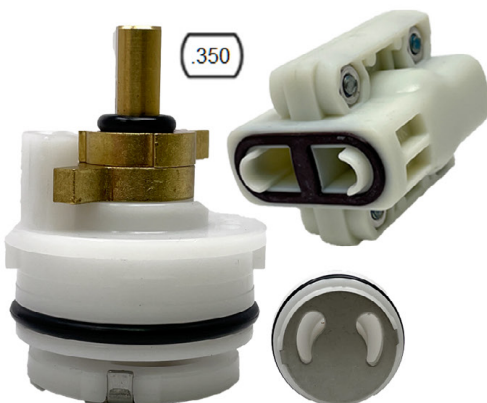

OEM: RP70538 (New Style)

PE11504

FOR HUNTINGTON
LENGTH: 51mm / 2.00"



OEM # ST5000
OPERATING STEM FOR CC19030

CC19031

FOR DELTA
LENGTH: 51mm / 2.00"



OEM # RP1991

DE10480

SINGLE LEVER CARTRIDGES

FOR GRAFF
LENGTH: 53mm / 2.07"



DIAMETER: 28mm
OEM # 5057350 / KEROX # KRB-28
CLOSES CLOCKWISE
CC19113

FOR GRAFF
LENGTH: 53mm / 2.07"



DIAMETER: 28mm
OEM # 5057650 / KEROX # KRJ-28
CLOSES COUNTER-CLOCKWISE
CC19114

FOR SLOAN
LENGTH: 53mm / 2.07"



DIAMETER: 28mm
OEM # MIX-59 / KEROX # KDN-28
CERAMIC MIXER or 2-PORT VARIABLE DIVERTER
CC19129

FOR GLACIER BAY
LENGTH: 53mm / 2.09"



DIAMETER: 25mm
OEM # A507084N / KEROX # K-25 OP 5
CC19112

KEROX
LENGTH: 54mm / 2.12"



DIAMETER: 28mm
KEROX # K-28
FITS VARIOUS MANUFACTURERS
CC19069

FOR VOLA
LENGTH: 54mm / 2.12"



DIAMETER: 28mm
OEM # VR277K
CC19087

FOR PRICE PFISTER
LENGTH: 54mm / 2.12"



OEM # 900-022
FLOWMATIC CARTRIDGE
PP11702

FOR AMERICAN STANDARD
LENGTH: 54mm / 2.125"



DIAMETER: 47mm
OEM # A954440-007A
AS10185

FOR GERBER
LENGTH: 54mm / 2.125"



OEM # 97-022
SAFETEMP CONTROL CARTRIDGE
GE10782

SINGLE LEVER CARTRIDGES

FOR DANZE/GERBER/PEGASUS
LENGTH: 54mm / 2.135"

FOR DANZE/GERBER/PEGASUS
LENGTH: 54mm / 2.135"

FOR AMERICAN STANDARD
LENGTH: 56mm / 2.20"



OEM # 603566

DIAMETER: 45mm
OEM # 057864-0070A

CC19056

CC19056WS

AS10190

FOR AMERICAN STANDARD
LENGTH: 57mm / 2.24"

FOR HUNTINGTON
LENGTH: 57mm / 2.25"

FOR CONCINNITY / JACLO
LENGTH: 57mm / 2.25"



DIAMETER: 47mm
OEM # 050536-0070A
W/ FLOW CONTROL
AS10197

DIAMETER: 35mm
OEM # ST9000
FITS VARIOUS MANUFACTURERS
CC19006

DIAMETER: 35mm
CC19027

SINGLE LEVER CARTRIDGES

FOR KOHLER
LENGTH: 57mm / 2.25"



DIAMETER: 35mm
KOHLER # GP1016515
FITS VARIOUS MANUFACTURERS
CC19034

FOR GERBER
LENGTH: 57mm / 2.25"



DIAMETER: 35mm
GERBER # 92-298 / KEROX # K35A
FITS VARIOUS MANUFACTURERS
CC19050

KEROX
LENGTH: 57mm / 2.25"



DIAMETER: 35mm
FITS VARIOUS MANUFACTURERS
CC19050-LS

FOR VOLA
LENGTH: 57mm / 2.25"



DIAMETER: 35mm
OEM # VR1277K
CC19086

FOR SYMMONS
LENGTH: 57mm / 2.25"



DIAMETER: 35mm
OEM # KN-4
CC19111

FOR AMERICAN STANDARD
LENGTH: 57mm / 2.25"



DIAMETER: 47mm
OEM # 023529-0070A
AS10186

SINGLE LEVER CARTRIDGES

FOR AMERICAN STANDARD
LENGTH: 57mm / 2.25"



DIAMETER: 40mm
OEM # A951470-0070A
AS10188

FOR GERBER
LENGTH: 57mm / 2.25"



OEM # 97-142
EZ-MIX CARTRIDGE
GE10785

VARIOUS MANUFACTURERS
LENGTH: 58mm / 2.28"



DIAMETER: 35mm
JOYSTICK TYPE
CC19011

FOR CONCINNITY
LENGTH: 58mm / 2.28"



DIAMETER: 35mm
OEM # 30820-24
CC19026

FOR WOLVERINE
LENGTH: 58mm / 2.28"



DIAMETER: 35mm
OEM # 85107W
CC19049

FOR KOHLER
LENGTH: 58mm / 2.28"



DIAMETER: 30mm
OEM # GP77548
CC19085

SINGLE LEVER CARTRIDGES

FOR VALLEY
LENGTH: 59mm / 2.31"

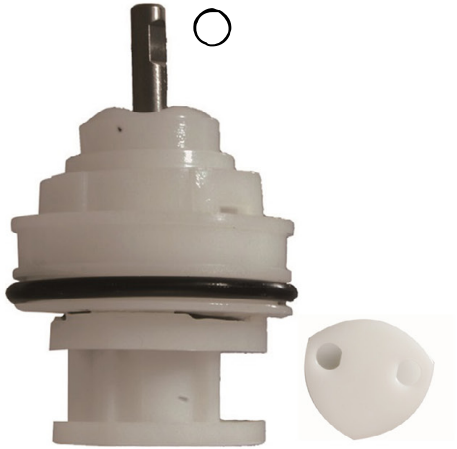

OEM # V6680

VA12248

FOR DELTA
LENGTH: 59mm / 2.31"



DIAMETER: 32mm
OEM # RP73000
EURO-MOTION CARTRIDGE - SHORT STEM
DE10491

KEROX
LENGTH: 59mm / 2.34"



DIAMETER: 35mm
OEM # KDN-35A
CERAMIC MIXER or 2-PORT VARIABLE DIVERTER
CC19115

FOR DELTA
LENGTH: 60mm / 2.37"



DIAMETER: 28mm

CC19123

FOR DELTA
LENGTH: 60mm / 2.37"



DIAMETER: 28mm

OEM # RP91507
W/ BONNET NUT
CC19124

SINGLE LEVER CARTRIDGES

FOR VALLEY
LENGTH: 60mm / 2.375"

FOR VALLEY
LENGTH: 60mm / 2.375"

VARIOUS MANUFACTURERS
LENGTH: 61mm / 2.40"



OEM # VP1965
CARTRIDGE WITH SPRAY
VA12246

OEM # VP1964
CARTRIDGE WITHOUT SPRAY
VA12247

DIAMETER: 40mm
JOYSTICK TYPE
CC19017

FOR PAIJO
LENGTH: 61mm / 2.40"

FOR GERBER
LENGTH: 61mm / 2.40"

KEROX
LENGTH: 62mm / 2.43"



DIAMETER: 25mm
FITS MANY MANUFACTURERS

DIAMETER: 40mm
OEM # 95-154

DIAMETER: 35mm
KEROX # KDZ-35A
CERAMIC DIVERTER CARTRIDGE

CC19028

PBCV-CTG

CC19073

SINGLE LEVER CARTRIDGES

FOR SAYCO
LENGTH: 62mm / 2.44"

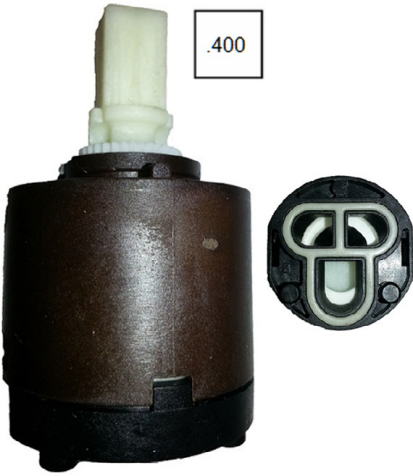

DIAMETER: 38mm
OEM # P1050
CC19042

FOR PRICE PFISTER
LENGTH: 62mm / 2.45"



OEM # 971-250
PP11697

FOR STERLING
LENGTH: 62mm / 2.45"



OEM # A05023
CARTRIDGE WITH DIVERTER
SL11982

FOR STERLING
LENGTH: 62mm / 2.45"



OEM # A05013
CARTRIDGE WITHOUT DIVERTER
SL11983

HYDROPLAST
LENGTH: 63mm / 2.46"



DIAMETER: 42mm
HYDROPLAST # C42
CC19095

FOR ZURN
LENGTH: 63mm / 2.48"



DIAMETER: 40mm
OEM # RK7440
CC19012

SINGLE LEVER CARTRIDGES

FOR PRICE PFISTER
LENGTH: 63mm / 2.48"



DIAMETER: 35mm
OEM # 974-505 / 974-570

CC19037

FOR PRICE PFISTER
LENGTH: 63mm / 2.48"



DIAMETER: 35mm
OEM # 974-035

CC19038

KEROX
LENGTH: 63mm / 2.48"



DIAMETER: 40mm
KEROX # K40A
FITS MANY MANUFACTURERS

CC19044

FOR DELTA
LENGTH: 63mm / 2.485"



DIAMETER: 36mm
OEM # RP50587

DE10485

HYDROPLAST
LENGTH: 64mm / 2.50"



DIAMETER: 40mm
HYDROPLAST # G40
FITS MANY MANUFACTURERS

CC19036

FOR HUNTINGTON BRASS
LENGTH: 63mm / 2.50"



DIAMETER: 40mm
WITHOUT MIXER

CC19058

SINGLE LEVER CARTRIDGES

STSR
LENGTH: 65mm / 2.56"



DIAMETER: 40mm
DIVERTER CARTRIDGE
CC19098

FOR DELTA
LENGTH: 65mm / 2.57"



DIAMETER: 32mm
OEM # RP60114
EURO-MOTION CARTRIDGE
DE10489

KEROX
LENGTH: 67mm / 2.625"



DIAMETER: 35mm
KEROX # KJ-35A
CC19071

FOR MILWAUKEE
LENGTH: 67mm / 2.655"



OEM # R1005
MW11329

FOR STERLING
LENGTH: 69mm / 2.70"



OEM # 05300
SL11981

FOR AMERICAN STANDARD
LENGTH: 69mm / 2.72"



OEM # 51337-0070A
AS10192

SINGLE LEVER CARTRIDGES

FOR AMERICAN STANDARD
LENGTH: 69mm / 2.72"



OEM # 66269-0070A

AS10193

HYDROPLAST
LENGTH: 69mm / 2.72"



DIAMETER: 35mm
HYDROPLAST # BX35

CC19094

FOR PRICE PFISTER
LENGTH: 70mm / 2.75"



DIAMETER: 35mm
OEM # 974-092

FITS MANY MANUFACTURERS

CC19008

HYDROPLAST
LENGTH: 70mm / 2.75"



DIAMETER: 35mm
HYDROPLAST # GX35

CC19035

VARIOUS MANUFACTURERS
LENGTH: 70mm / 2.76"



DIAMETER: 35mm
CONNECTED PIPE

CC19117

FOR AQUABRASS
LENGTH: 71mm / 2.78"



DIAMETER: 35mm
OEM # ABCA03240

CC19083

SINGLE LEVER CARTRIDGES

VARIOUS MANUFACTURERS
LENGTH: 71mm / 2.80"



DIAMETER: 35mm
JOYSTICK TYPE

CC19010

HYDROPLAST
LENGTH: 72mm / 2.85"

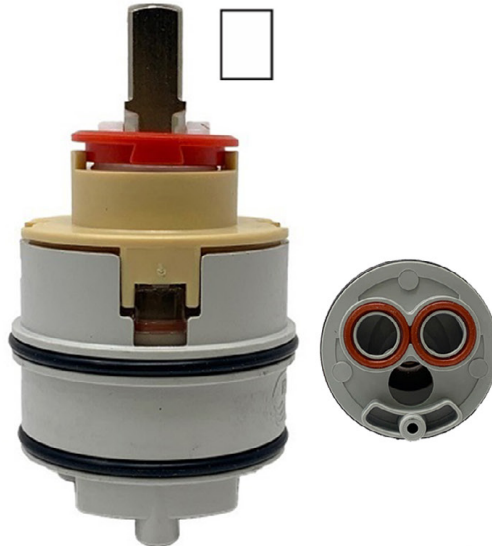

DIAMETER: 38mm
HYDROPLAST # AX38

CC19093

FOR MOEN
LENGTH: 72mm / 2.85"



DIAMETER: 35mm
MOEN # 194149 / KEROX # KDZ-35B
DIVERTER CARTRIDGE

CC19096

FOR KOHLER
LENGTH: 72mm / 2.855"



OEM # GP30413

KO11183

KEROX
LENGTH: 73mm / 2.86"



DIAMETER: 35mm
KEROX # K-35B HWS
FITS MANY MANUFACTURERS

CC19070

KEROX
LENGTH: 73mm / 2.86"



DIAMETER: 35mm
KEROX # K-35B
FITS MANY MANUFACTURERS

CC19070-LS

SINGLE LEVER CARTRIDGES

VARIOUS MANUFACTURERS
LENGTH: 74mm / 2.90"



DIAMETER: 40mm
JOYSTICK TYPE
CC19016

VARIOUS MANUFACTURERS
LENGTH: 75mm / 2.95"



DIAMETER: 40mm
IMPORT # JH02BD
CC19025

FOR GLACIER BAY/ PEGASUS
LENGTH: 75mm / 2.95"



DIAMETER: 40mm
OEM # RP20006
CC19032

FOR KOHLER
LENGTH: 76mm / 2.98"



DIAMETER: 40mm
OEM # 78896
CC19105

FOR SAYCO
LENGTH: 76mm / 2.99"

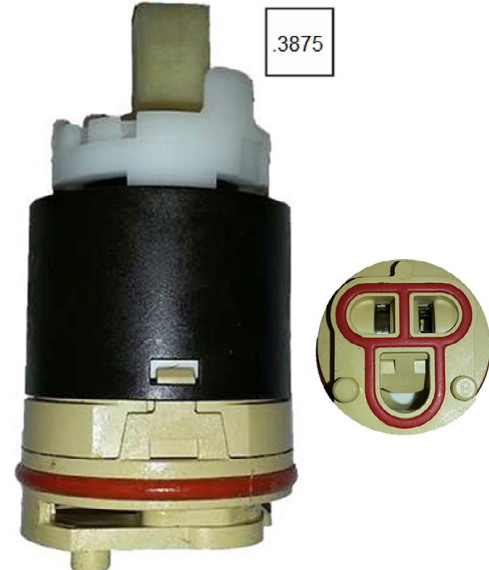

DIAMETER: 38mm
OEM # P1071
CC19040

SINGLE LEVER CARTRIDGES

KEROX
LENGTH: 76mm / 2.99"



DIAMETER: 40mm
KEROX # PBS40
CC19045

KEROX
LENGTH: 76mm / 2.99"

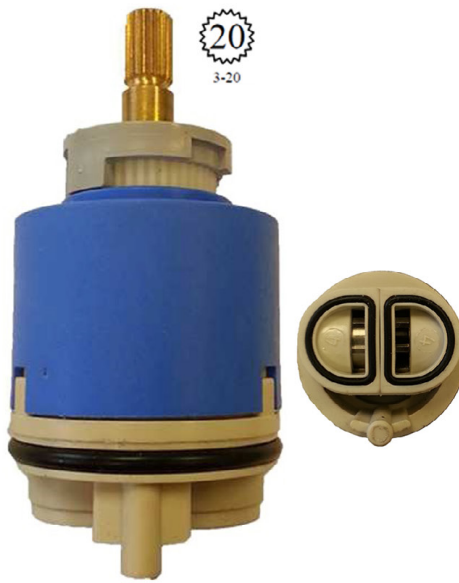

DIAMETER: 40mm
KEROX # PBR40
CC19046

FOR PROFLO
LENGTH: 76mm / 3.00"



DIAMETER: 40mm
OEM # ACF300CRT2 (LESS CHECK)
CC19107

VARIOUS MANUFACTURERS
LENGTH: 76mm / 3.00"



DIAMETER: 40mm
CC19014

FOR MOEN
LENGTH: 76mm / 3.00"



DIAMETER: 40mm
OEM # 121549 / KEROX # K40B
ALSO FITS VARIOUS MANUFACTURERS
CC19051

VARIOUS MANUFACTURERS
LENGTH: 77mm / 3.02"



DIAMETER: 40mm
IMPORT # N40HKC
CC19108

SINGLE LEVER CARTRIDGES

FOR EZ-FLO
LENGTH: 78mm / 3.07"



DIAMETER: 40mm
OEM # 90030 / IMPORT # JLO2BJ
ALSO FITS VARIOUS MANUFACTURERS
CC19024

FOR SAYCO
LENGTH: 78mm / 3.07"



DIAMETER: 38mm
OEM # P1070
CC19039

VARIOUS MANUFACTURERS
LENGTH: 78mm / 3.07"



DIAMETER: 40mm
CC19116

FOR ZURN
LENGTH: 79mm / 3.10"



DIAMETER: 40mm
OEM # RK7300-CART-3P / IMPORT # JH02BJ
ALSO FITS VARIOUS MANUFACTURERS
CC19025-OS

VARIOUS MANUFACTURERS
LENGTH: 79mm / 3.11"



DIAMETER: 40mm
IMPORT # JL04BD
CC19023

FOR HUNTINGTON
LENGTH: 79mm / 3.12"



DIAMETER: 40mm
SPECIAL HUNTINGTON CARTRIDGE
WITH SMALLER .365 BROACH
CC19023SP

SINGLE LEVER CARTRIDGES

FOR HUNTINGTON
LENGTH: 79mm / 3.12"



DIAMETER: 40mm
OEM # ST7100 / IMPORT # JL01GJ
FITS VARIOUS MANUFACTURERS
CC19023-OS

FOR KOHLER
LENGTH: 80mm / 3.14"



DIAMETER: 35mm
OEM # 1126312 / KEROX # KJ-35B
CC19072

FOR VARIOUS MANUFACTURERS
LENGTH: 80mm / 3.14"



DIAMETER: 40mm
IMPORT # JH01GJ
CC19079

FOR DELTA / PEERLESS
LENGTH: 80mm / 3.15"



DIAMETER: 40mm
OEM # RP70538
CC19054

FOR DELTA / PEERLESS
LENGTH: 80mm / 3.15"



DIAMETER: 40mm
OEM # RP70538 (NEW STYLE)
CC19054-NS

VARIOUS MANUFACTURERS
LENGTH: 81mm / 3.20"



DIAMETER: 33mm
3-WAY DIVERTER CARTRIDGE
CC19080

SINGLE LEVER CARTRIDGES

VARIOUS MANUFACTURERS
LENGTH: 81mm / 3.20"

PROFLO / SIGNATURE HARDWARE
LENGTH: 82mm / 3.23"

FOR DELTA
LENGTH: 83mm / 3.25"



DIAMETER: 35mm
4-WAY DIVERTER CARTRIDGE

CC19081



DIAMETER: 42mm
OEM # HC-7002
DIVERTER CARTRIDGE

CC19127



OEM # RP32104

DE10481

FOR DELTA
LENGTH: 83mm / 3.25"

FOR STERLING
LENGTH: 83mm / 3.25"

FOR GLACIER BAY
LENGTH: 83mm / 3.27"



OEM # RP46463

DE10483

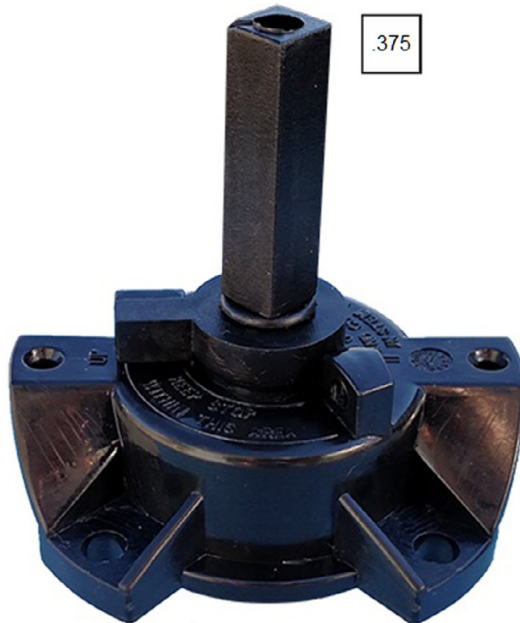

OEM # 05200

SL11980

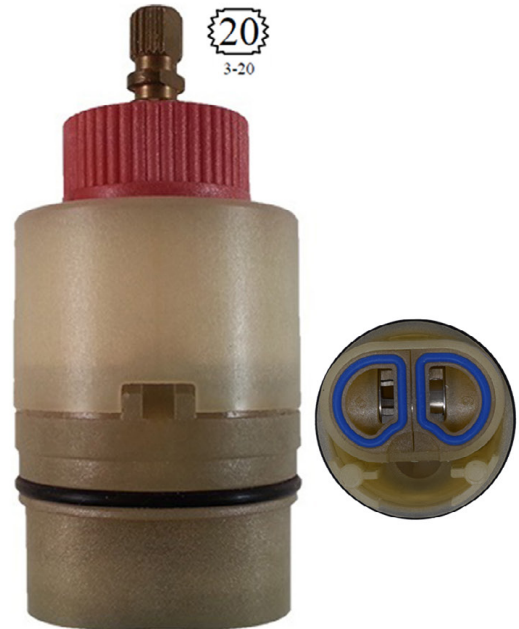

DIAMETER: 40mm

CC19033

SINGLE LEVER CARTRIDGES

FOR MOEN
LENGTH: 83mm / 3.27"



DIAMETER: 33mm
OEM # 163127
DIVERTER CARTRIDGE
CC19084

FOR PAINI / LA TOSCANA
LENGTH: 83mm / 3.27"



DIAMETER: 40mm
PROGRESSIVE CARTRIDGE
CC19103

FOR WOLVERINE
LENGTH: 84mm / 3.30"



DIAMETER: 40mm
OEM # 85116
CC19048

VARIOUS MANUFACTURERS
LENGTH: 84mm / 3.30"



DIAMETER: 40mm
CC19076

FOR SIGNATURE HARDWARE
LENGTH: 84mm / 3.30"



DIAMETER: 40mm
OEM # 163127
DIVERTER CARTRIDGE
CC19130

FOR TEMPRESS
LENGTH: 85mm / 3.33"



GROHE # 47 080, NEWPORT BRASS # 1-027
CAL FAUCETS # CART-PBS
PRESSURE BALANCE CARTRIDGE
TE11990

SINGLE LEVER CARTRIDGES

FOR BRIZO (DELTA)
LENGTH: 85mm / 3.335"



DIAMETER: 45mm
OEM # RP75213
TUB FILLER CARTRIDGE
CC19074

FOR PROFLO
LENGTH: 85mm / 3.34"



DIAMETER: 40mm
OEM # ACF3001LSCRT
W/ CHECK
CC19047CHK

FOR BRIGGS, BRADLEY,
KOHLER, SAYCO
LENGTH: 85mm / 3.35"



BR10213-GASKET
GASKET ONLY

PART ONLY
BR10213
BR10213-W/GASKET
PART & GASKET TOGETHER

FOR BRIGGS
LENGTH: 85mm / 3.35"



OEM # P310
W/ CHROME SLEEVE
BR10214

SINGLE LEVER CARTRIDGES

FOR SAYCO
LENGTH: 85mm / 3.35"



DIAMETER: 40mm
OEM # R200CC

CC19041

FOR PROFLO
LENGTH: 85mm / 3.35"



DIAMETER: 40mm
OEM # ACF3001CRT

CC19047

FOR GERBER
LENGTH: 85mm / 3.35"



DIAMETER: 40mm
OEM # 95-154 / 95-152
FITS VARIOUS MANUFACTURERS

PBCV

FOR KOHLER
LENGTH: 86mm / 3.375"



OEM # GP77886

KO11181

FOR AQUABRASS
LENGTH: 87mm / 3.42"



DIAMETER: 40mm
PRESSURE BALANCE CARTRIDGE
OEM # ABCA40299

CC19125

FOR EZ-FLO
LENGTH: 87mm / 3.425"



DIAMETER: 40mm
FITS VARIOUS MANUFACTURERS

CC19015

SINGLE LEVER CARTRIDGES

FOR DANZE / GERBER
LENGTH: 90mm / 3.55"



DIAMETER: 40mm
OEM # A50797
CC19061

VARIOUS MANUFACTURERS
LENGTH: 91mm / 3.58"



DIAMETER: 40mm
CC19055

VARIOUS MANUFACTURERS
LENGTH: 92mm / 3.62"



DIAMETER: 40mm
IMPORT # JHO4BD
WITH CHECK VALVE
CC19053

SINGLE LEVER CARTRIDGES

FOR SAYCO
LENGTH: 88mm / 3.465"



DIAMETER: 38mm
OEM # P1079
CC19043

PAINI / LA TOSCANA
LENGTH: 88mm / 3.475"



DIAMETER: 40mm
CC19102

PAINI / LA TOSCANA
LENGTH: 88mm / 3.475"



DIAMETER: 40mm
WITH CHECK VALVES
CC19102CHK

FOR HUNTINGTON
LENGTH: 89mm / 3.50"



DIAMETER: 47mm
OEM # ST5000C
CC19030

SINGLE LEVER CARTRIDGES

FOR KOHLER
LENGTH: 92mm / 3.65"



OEM # GP77759
KO11180

KOHLER
LENGTH: 85mm / 3.34"



DIAMETER: 40mm
OEM # GP876851
RITE-TEMP MIXER & PRESSURE BALANCE CARTRIDGE
KO11189

KOHLER
LENGTH: 85mm / 3.34"



DIAMETER: 40mm
OEM # GP76851
KO11184

SINGLE LEVER CARTRIDGES

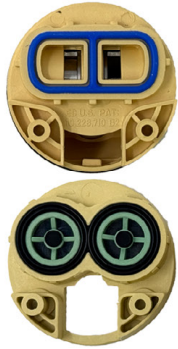

PBCVCHK

FOR DANZE
LENGTH: 96mm / 3.765"

20
3-20



CC19068

FOR DANZE
LENGTH: 96mm / 3.765"

.350

DIAMETER: 45mm
OEM # A507150

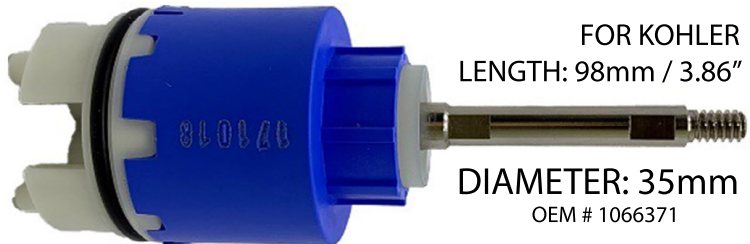

CC19082

FOR KOHLER
LENGTH: 98mm / 3.86"

DIAMETER: 35mm
OEM # 1066371

M6 X 1.00



MO21304-LF

FOR MOEN
LENGTH: 100mm / 3.94"

.300

OEM # 1225
PLASTIC WITH BRASS CORE
LEAD FREE

SINGLE LEVER CARTRIDGES

FOR MOEN
LENGTH: 100mm / 3.94"



MO21305
MO21305-LF LEAD FREE VERSION

OEM # 1200
BRASS CARTRIDGE

FOR VALLEY
LENGTH: 100mm / 3.94"



VA12253

DIAMETER: 40mm
OEM # V4268

FOR DANZE
LENGTH: 101mm / 3.99"

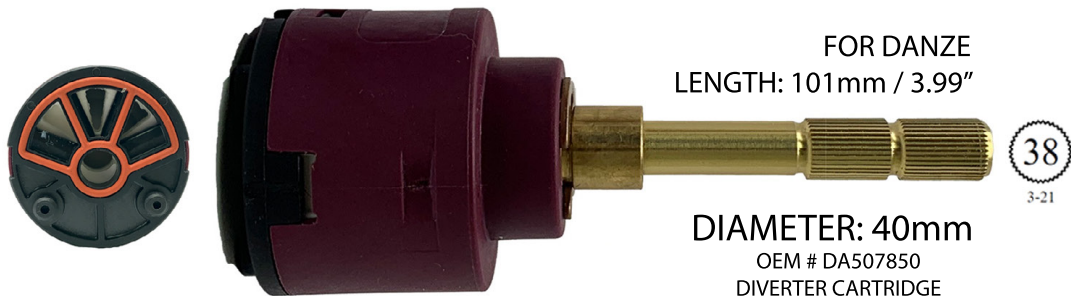

CC19101

DIAMETER: 40mm
OEM # DA507850
DIVERter CARTRIDGE

38
3-21

FOR DANZE/GERBER/PEGASUS
LENGTH: 102mm / 4.00"



CC19057

OEM # 603567

38
3-21

SINGLE LEVER CARTRIDGES



FOR DANZE/GERBER/PEGASUS
LENGTH: 102mm / 4.00"

38
3-21

CC19057WS



FOR DANZE / GERBER
LENGTH: 102mm / 4.03"

16
2-3

CC19064

DIAMETER: 40mm
OEM # A507979



FOR DELTA
LENGTH: 104mm / 4.094"

240

DE10482

OEM # RP19804

SINGLE LEVER CARTRIDGES

FOR NIBCO
LENGTH: 105mm / 4.125"

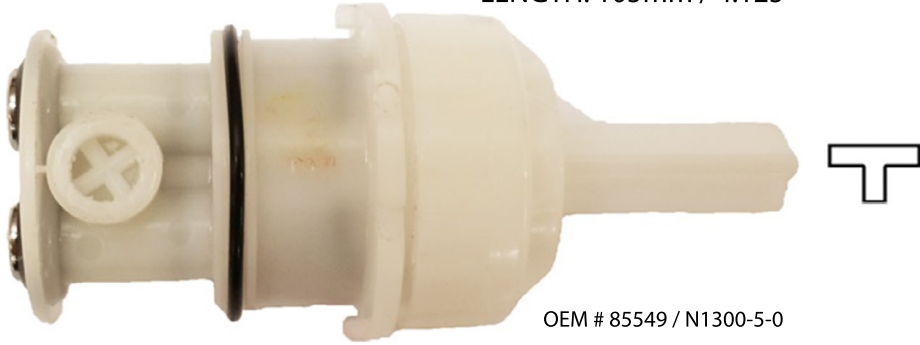

OEM # 85549 / N1300-5-0

NI11440

FOR MOEN
LENGTH: 105mm / 4.125"



OEM # 1222B
POSI-TEMP

MO21306

FOR PRICE PFISTER
LENGTH: 105mm / 4.125"



OEM # 974-292
AVANTE CARTRIDGE

PP11691

FOR GLACIER BAY / GROHE
LENGTH: 405mm / 4.130"

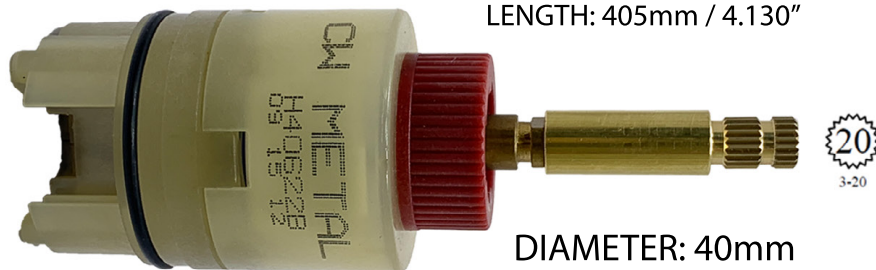

DIAMETER: 40mm
OEM # RP64318

CC19106

SINGLE LEVER CARTRIDGES

FOR PRICE PFISTER
LENGTH: 105mm / 4.13"

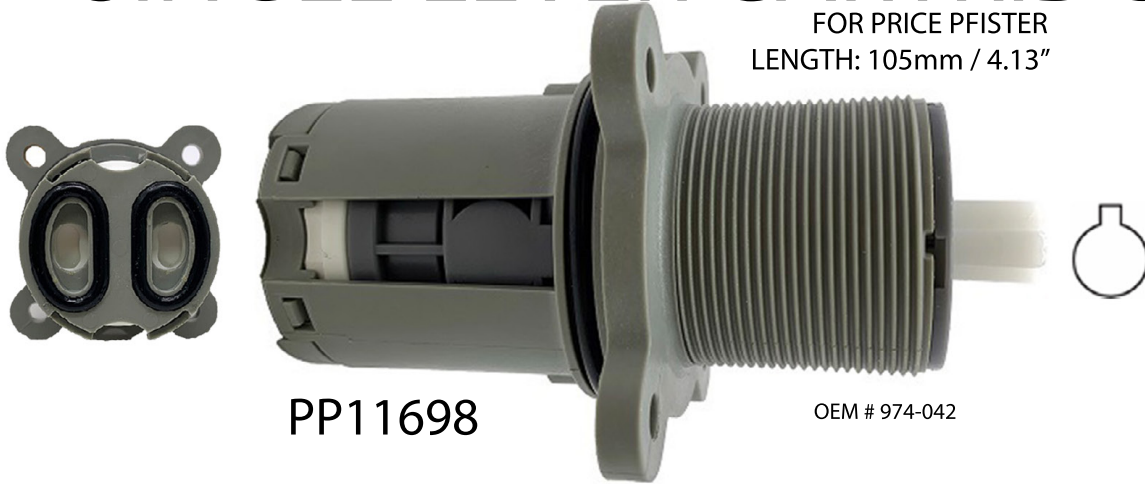

PP11698

OEM # 974-042

FOR PRICE PFISTER
LENGTH: 106mm / 4.165"

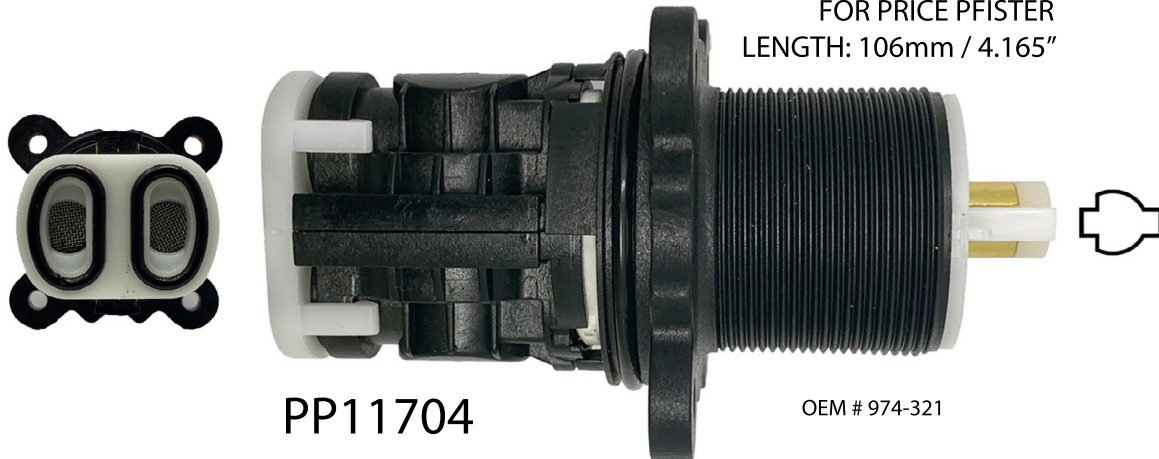

PP11704

OEM # 974-321

FOR GLACIER BAY & OTHERS
LENGTH: 106mm / 4.18"



CC19091

DIAMETER: 40mm
OEM # A507887

.350

SINGLE LEVER CARTRIDGES

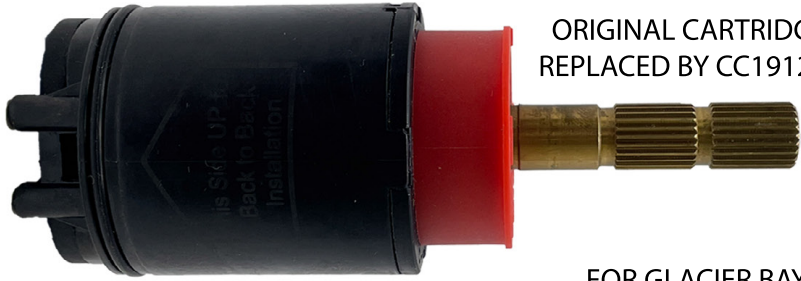

ORIGINAL CARTRIDGE
REPLACED BY CC19128

FOR GLACIER BAY
LENGTH: 106mm / 4.18"

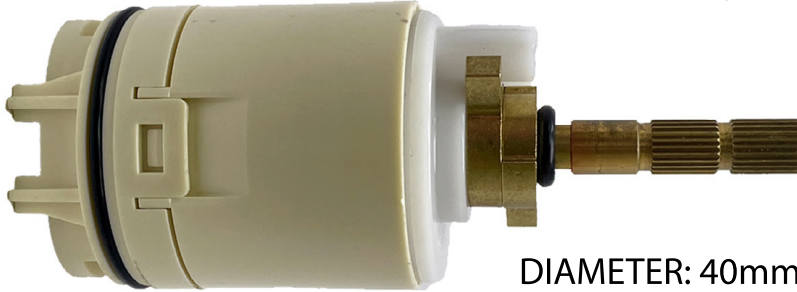

DIAMETER: 40mm
OEM # RP20124

CC19128



FOR DELTA
LENGTH: 110mm / 4.325"

DE10484

OEM # RP46074



FOR PROFLO LENGTH:
110mm / 4.35"

CC19109

DIAMETER: 45mm
OEM # PF1006LSCRT

SINGLE LEVER CARTRIDGES

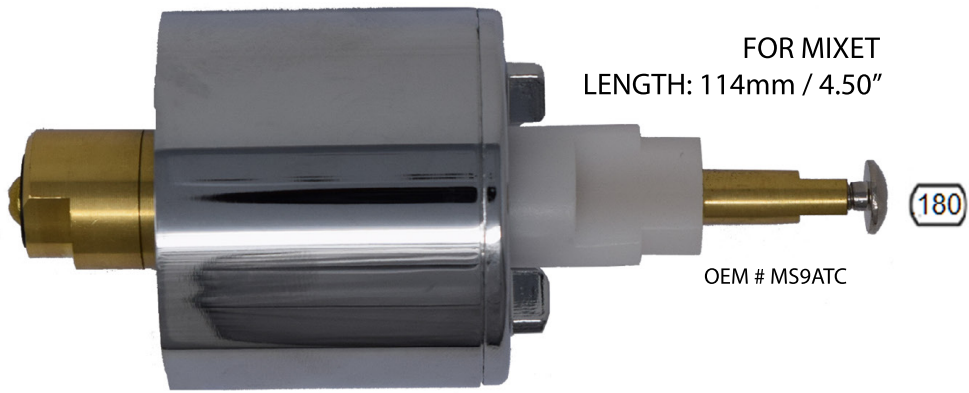

FOR MIXET
LENGTH: 114mm / 4.50"

OEM # MS9ATC

MX21354

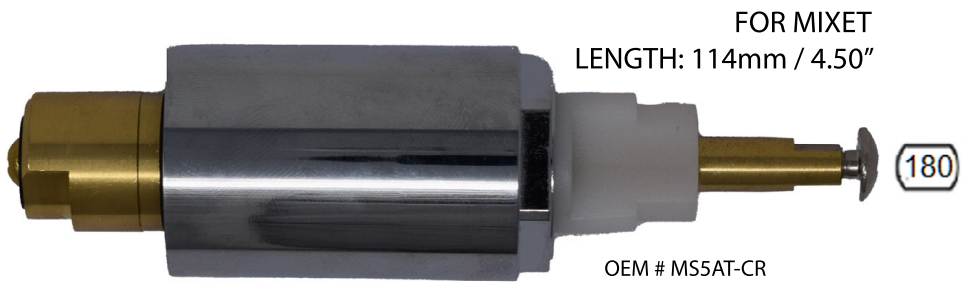

FOR MIXET
LENGTH: 114mm / 4.50"

OEM # MS5AT-CR

MX21348-B



FOR GERBER
LENGTH: 119mm / 4.68"

OEM # 97-014 / 97-022

GE10783

SINGLE LEVER CARTRIDGES

FOR GERBER
LENGTH: 119mm / 4.68"



GE10784

OEM # 97-013 / 92-298

FOR DANZE
LENGTH: 127mm / 4.70"

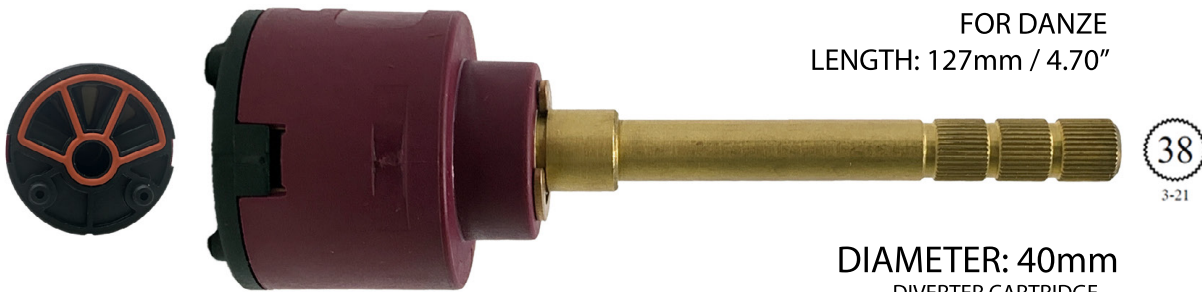

CC19110

DIAMETER: 40mm
DIVERTER CARTRIDGE
OEM # A507706

FOR DANZE / GERBER
LENGTH: 126mm / 4.95"



CC19060

DIAMETER: 40mm
OEM # A507902

FOR DANZE / GERBER
LENGTH: 128mm / 5.025"



CC19066

DIAMETER: 45mm
OEM # DA507107 / 97-232

SINGLE LEVER CARTRIDGES

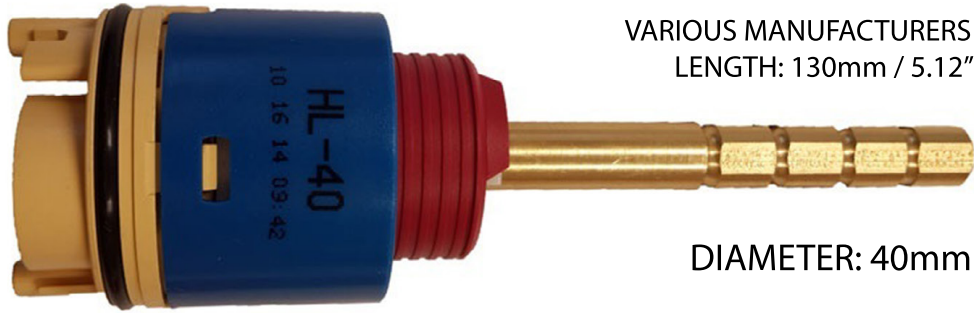

VARIOUS MANUFACTURERS
LENGTH: 130mm / 5.12"

.350

DIAMETER: 40mm

CC19029

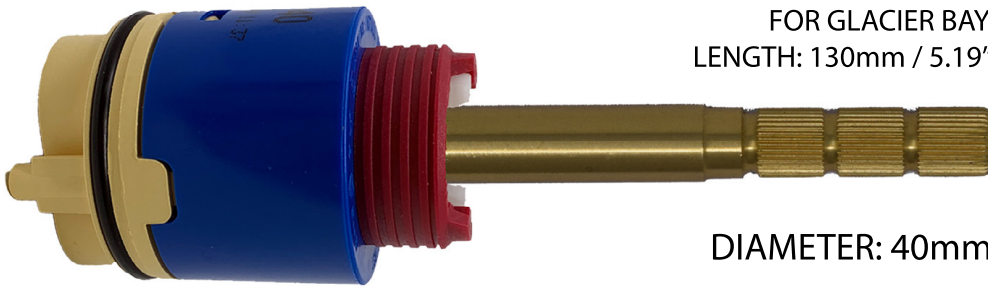

FOR GLACIER BAY
LENGTH: 130mm / 5.19"

38
3-21

DIAMETER: 40mm

CC19052

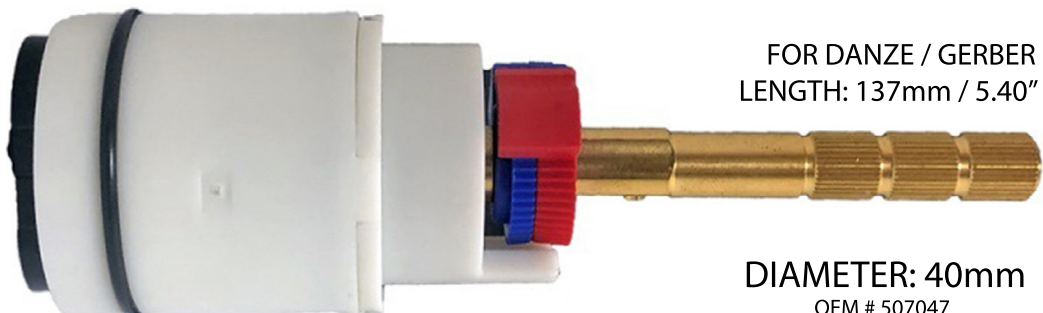

FOR DANZE / GERBER
LENGTH: 137mm / 5.40"

38
3-21

DIAMETER: 40mm
OEM # 507047

CC19062

SINGLE LEVER CARTRIDGES

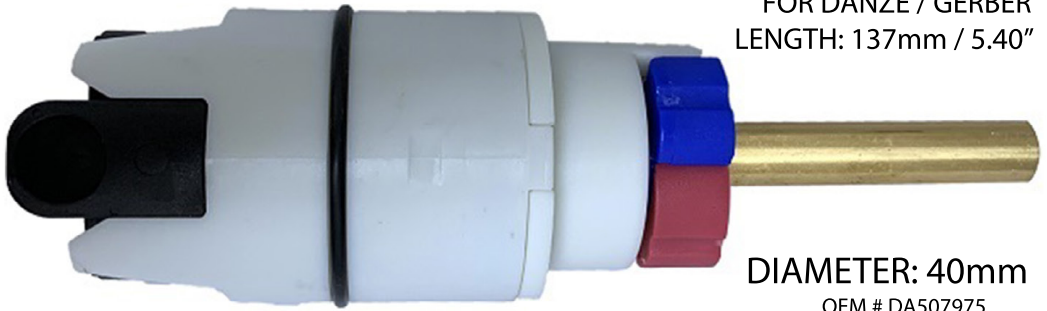

FOR DANZE / GERBER
LENGTH: 137mm / 5.40"

.350

DIAMETER: 40mm
OEM # DA507975

CC19063

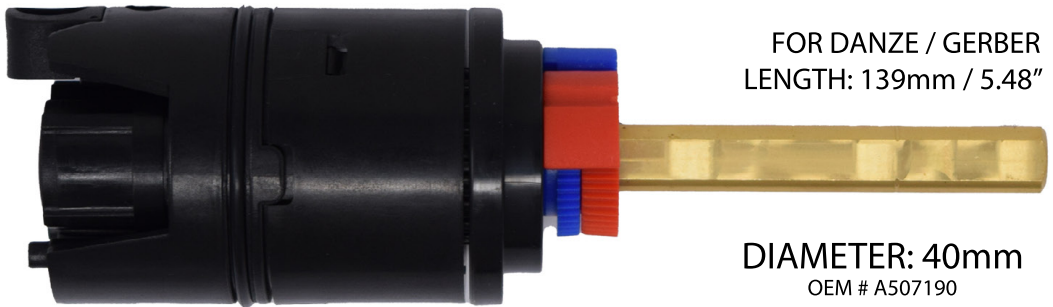

FOR DANZE / GERBER
LENGTH: 139mm / 5.48"

.350

DIAMETER: 40mm
OEM # A507190

CC19090



FOR DANZE / GERBER
LENGTH: 141mm / 5.55"

.350

DIAMETER: 45mm
OEM # A507165

CC19077

SINGLE LEVER CARTRIDGES

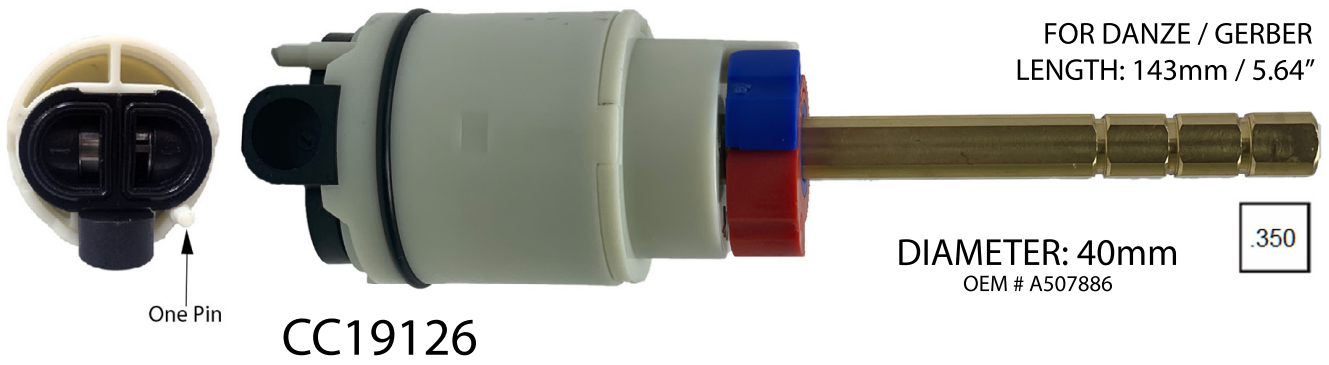

SINGLE LEVER CARTRIDGES

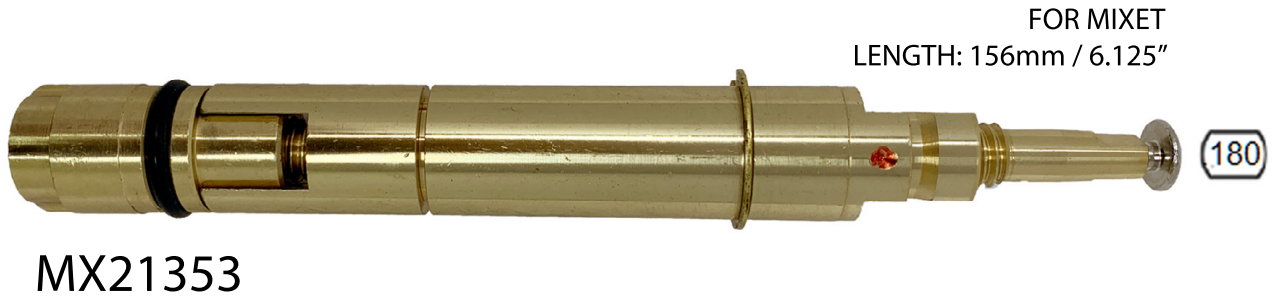

SINGLE LEVER CARTRIDGES

VARIOUS MANUFACTURERS
LENGTH: 192mm / 7.575"

FOR PHYLRICH
LENGTH: 195mm / 7.685"

FOR DANZE / GERBER
LENGTH: 165mm / 6.48"



.350

DIAMETER: 40mm
OEM # A507193
CC19088



20
3-20

DIAMETER: 40mm
CC19078



16
1-6

DIAMETER: 40mm
OEM # 1-130
CC19075