

SINGLE LEVER COMPONENTS

STOP FOR DANZE/
GERBER/PEGASUS



CC19056-3

TEMPURATURE RING
FOR S/L CARTRIDGES

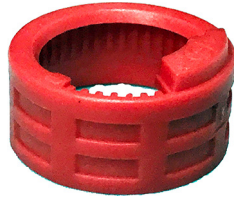

CC-RING

TEMPURATURE RING
FORT T & S CARTRIDGES



PBCV-RING

CHECK VALVE FOR DELTA



OEM # RP73625
CC19054-CV

MIXER FOR PRESSURE
BALANCE VALVES



CC-MIX



CHECK VALVE FOR 40MM PRESSURE
BALANCE CARTRIDGE



CC19079-CV



CHECK VALVE FOR 40MM PRESSURE
BALANCE CARTRIDGE



CC19023-CV



CHECK VALVE FOR 40MM PRESSURE
BALANCE CARTRIDGE

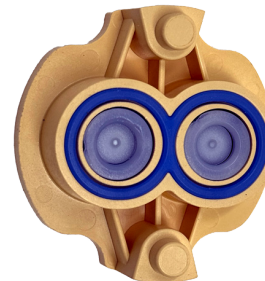

CC19025-CV



CHECK VALVE FOR 40MM PRESSURE
BALANCE CARTRIDGE



PBCV-CV



SINGLE LEVER MIXER FOR
PRESSURE BALANCE VALVES



PBCV-MIX



SINGLE LEVER COMPONENTS

PRESSURE BALANCE
CARTRIDGE FOR KOHLER

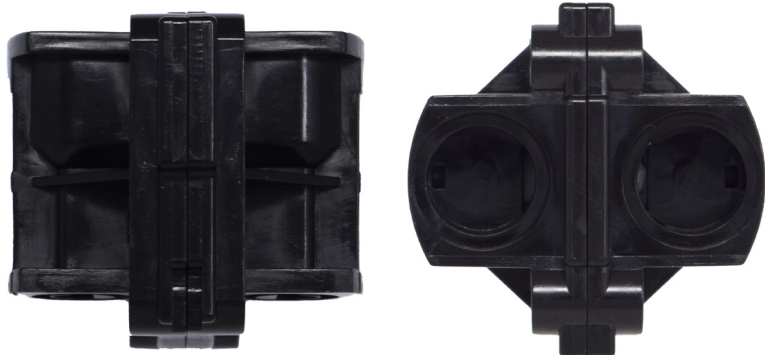

OEM # GP500520
KO11182

PRESSURE BALANCE
CARTRIDGE FOR PRICE PFISTER

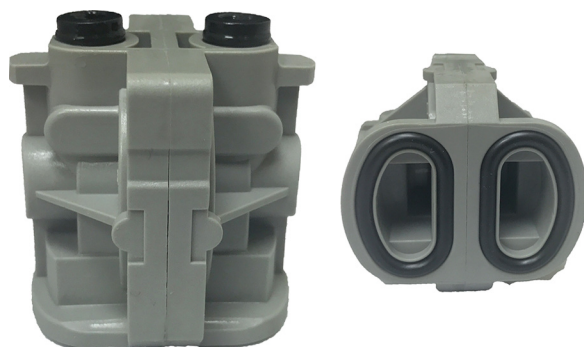

OEM # C974-291
PP11695

PRESSURE BALANCE
CARTRIDGE FOR KOHLER

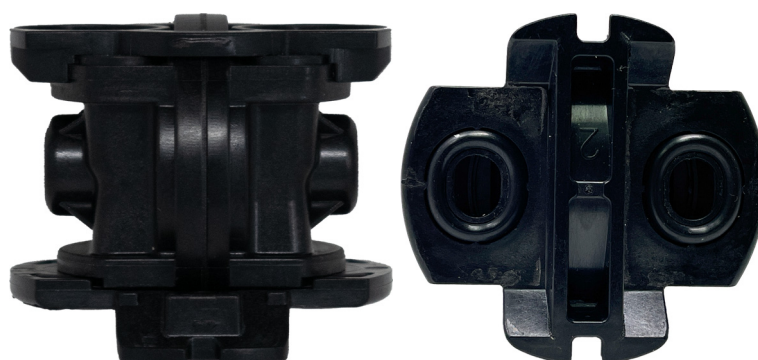

OEM # GP800820
KO11186

PRESSURE BALANCE
CARTRIDGE FOR PEGASUS



PE-BALMIX

PRESSURE BALANCE
CARTRIDGE FOR PRICE PFISTER



OEM # 974-491
PP11693

SINGLE LEVER COMPONENTS

FOR AMERICAN STANDARD
LENGTH: 57mm / 2.26"



OEM # 077171-0070A
AS10183

FOR AMERICAN STANDARD
LENGTH: 61mm / 2.415"



OEM # 51091-0070A
AS10181

FOR AMERICAN STANDARD
LENGTH: 65mm / 2.54"



OEM # M952100-0070A
AS10182

FOR GERBER
LENGTH: 90mm / 3.56"



OEM # 97-013
GE10780

FOR GERBER
LENGTH: 90mm / 3.56"



OEM # 97-014
GE10781

SINGLE LEVER CARTRIDGES

FOR SIGMA
LENGTH 42mm / 1.635"



DIAMETER: 22mm
OEM # 18.30.219
CC19100

VARIOUS MANUFACTURERS
LENGTH 42mm / 1.65"



DIAMETER: 22mm
DIVERTER
CC19003

STSR
LENGTH 44mm / 1.73"

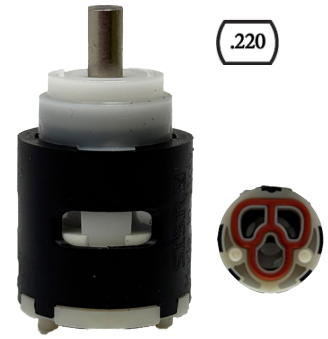

DIAMETER: 22mm
PROGRESSIVE CARTRIDGE
CC19097

FOR KEROX
LENGTH 49mm / 1.90"



DIAMETER: 25mm
CERAMIC CARTRIDGE
CC19147

FOR DELTA
LENGTH 49mm / 1.90"



OEM # RP20111
CONVERSION BALL
DE10487

FOR DELTA
LENGTH 49mm / 1.90"



OEM # RP10797
DE1-70SS

FOR DELTA
LENGTH 49mm / 1.90"



OEM # RP70
DE1-70SS-OEM

FOR DELTA
LENGTH 49mm / 1.90"



DE1-70B

FOR DELTA
LENGTH 49mm / 1.90"



DE1-70B-LF

SINGLE LEVER CARTRIDGES

FOR DELTA
LENGTH 49mm / 1.90"



DE1-70B-SP

FOR DELTA
LENGTH 49mm / 1.90"



DE1-212B

FOR DELTA
LENGTH 49mm / 1.90"



DE1-212B-LF

FOR DELTA
LENGTH 49mm / 1.90"



DE1-212SS

OEM # RP212MBS

FOR PRICE PFISTER
LENGTH 50mm / 1.97"



DIAMETER: 25mm

PP OEM # 974-074
FITS VARIOUS MANUFACTURERS

CC19001

VARIOUS MANUFACTURERS
LENGTH 50mm / 1.97"



DIAMETER: 25mm

CC19002

FOR PEGASUS
LENGTH 50mm / 1.975"



PE11502

FOR PEGASUS
LENGTH 50mm / 1.98"



OPERATING STEM AND
PRESSURE BALANCE CARTRIDGE

PE11504

FOR HUNTINGTON
LENGTH 51mm / 2.00"

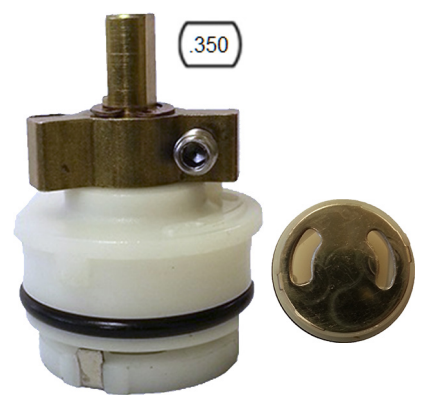

OEM # ST5000
OPERATING STEM FOR CC19030

CC19031

SINGLE LEVER CARTRIDGES

FOR DELTA
LENGTH 51mm / 2.00"



OEM # RP1991

DE10480

FOR GRAFF
LENGTH: 53mm / 2.07"



DIAMETER: 28mm
OEM # 5057350 / KEROX # KRB-28
CLOSES CLOCKWISE

CC19113

FOR GRAFF
LENGTH: 53mm / 2.07"



DIAMETER: 28mm
OEM # 5057650 / KEROX # KRJ-28
CLOSES COUNTER-CLOCKWISE

CC19114

FOR SLOAN
LENGTH: 53mm / 2.07"



DIAMETER: 28mm
OEM # MIX-59 / KEROX # KDN-28
CERAMIC MIXER or 2-PORT VARIABLE DIVERTER

CC19129

FOR GLACIER BAY
LENGTH 53mm / 2.09"



DIAMETER: 25mm
OEM # A507084N / KEROX # K-25 OP S

CC19112

FOR HYDROPLAST
LENGTH 53mm / 2.10"



DIAMETER: 26mm
HYDROPLAST # E26

CC19134

SINGLE LEVER CARTRIDGES

FOR KEROX
LENGTH 54mm / 2.12"



DIAMETER: 28mm
KEROX # K-28
FITS VARIOUS MANUFACTURERS
CC19069

FOR VOLA
LENGTH 54mm / 2.12"



DIAMETER: 28mm
OEM # VR277K
CC19087

FOR PRICE PFISTER
LENGTH: 54mm / 2.12"



OEM # 900-022
FLOWMATIC CARTRIDGE
PP11702

FOR AMERICAN STANDARD
LENGTH: 54mm / 2.125"



DIAMETER: 47mm
OEM # A954440-007A
AS10185

FOR GERBER
LENGTH: 54mm / 2.125"



OEM # 97-022
SAFETEMP CONTROL CARTRIDGE
GE10782

FOR DANZE/GERBER/PEGASUS
LENGTH: 54mm / 2.135"



OEM # 603566
CC19056

SINGLE LEVER CARTRIDGES

FOR DANZE/GERBER/PEGASUS
LENGTH: 54mm / 2.135"



CC19056WS

FOR AMERICAN STANDARD
LENGTH: 56mm / 2.20"



DIAMETER: 45mm
OEM # 057864-0070A
AS10190

FOR HYDROPLAST
LENGTH: 56mm / 2.20"



DIAMETER: 25mm
HYDROPLAST # F25
CC19135

FOR KRAUS
LENGTH: 56mm / 2.20"



DIAMETER: 35mm
OEM # KP44087
CERAMIC CARTRIDGE
CC19141

FOR KEROX
LENGTH: 56mm / 2.22"



DIAMETER: 35mm
KEROX # NKJ-35A
FITS VARIOUS MANUFACTURERS
CC19145

FOR AMERICAN STANDARD
LENGTH: 57mm / 2.25"



DIAMETER: 47mm
OEM # 023529-0070A
AS10186

SINGLE LEVER CARTRIDGES

FOR AMERICAN STANDARD
LENGTH: 57mm / 2.25"



DIAMETER: 40mm
OEM # A951470-0070A

AS10188

FOR AMERICAN STANDARD
LENGTH: 57mm / 2.25"



DIAMETER: 47mm
OEM # 050536-0070A

W/FLOW CONTROL

AS10197

FOR HUNTINGTON
LENGTH: 57mm / 2.25"



DIAMETER: 35mm
OEM # ST9000

FITS VARIOUS MANUFACTURERS

CC19006

FOR CONCINNITY / JACLO
LENGTH: 57mm / 2.25"

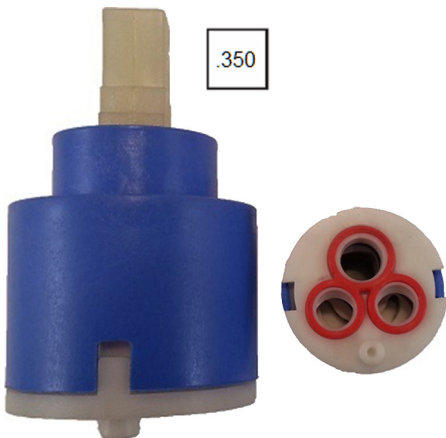

DIAMETER: 35mm

CC19027

FOR KOHLER
LENGTH: 57mm / 2.25"



DIAMETER: 35mm

OEM # GP1016515

FITS VARIOUS MANUFACTURERS

CC19034

FOR GERBER
LENGTH: 57mm / 2.25"



DIAMETER: 35mm

GERBER # 92-298 / KEROX # K35A

FITS VARIOUS MANUFACTURERS

CC19050

SINGLE LEVER CARTRIDGES

FOR KEROX
LENGTH: 57mm / 2.25"



DIAMETER: 35mm
FITS VARIOUS MANUFACTURERS

CC19050-LS

FOR VOLA
LENGTH: 57mm / 2.25"



DIAMETER: 35mm
OEM # VR1277K

CC19086

FOR SYMMONS
LENGTH: 57mm / 2.25"



DIAMETER: 35mm
OEM # KN-4

CC19111

FOR GERBER
LENGTH: 57mm / 2.25"



OEM # 97-142
EZ-MIX CARTRIDGE
GE10785

VARIOUS MANUFACTURERS
LENGTH: 58mm / 2.28"



DIAMETER: 35mm
JOYSTICK TYPE

CC19011

FOR NEWPORT BRASS
LENGTH: 58mm / 2.28"



DIAMETER: 35mm
OEM # 1-064

CC19026

SINGLE LEVER CARTRIDGES

FOR WOLVERINE
LENGTH: 58mm / 2.28"

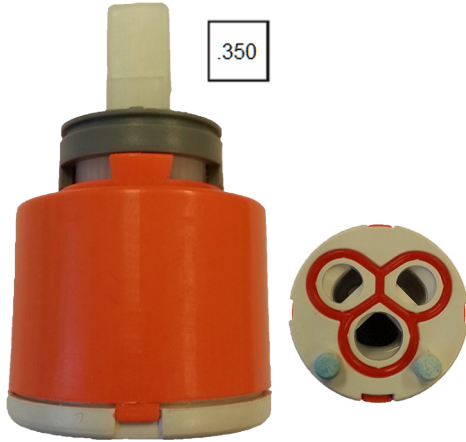

DIAMETER: 35mm
OEM # 85107W

CC19049

FOR KOHLER
LENGTH: 58mm / 2.28"



DIAMETER: 30mm
OEM # GP77548

CC19085

FOR VALLEY
LENGTH: 59mm / 2.31"



OEM # V6680

VA12248

FOR DELTA
LENGTH: 59mm / 2.31"



DIAMETER: 32mm
OEM # RP73000

EURO-MOTION CARTRIDGE - SHORT STEM
DE10491

KEROX
LENGTH: 59mm / 2.37"



DIAMETER: 35mm
KEROX # KDZ-35A
CERAMIC DIVERTER CARTRIDGE

CC19073

KEROX
LENGTH: 59mm / 2.37"



DIAMETER: 35mm
OEM # KDN-35A
CERAMIC MIXER or 2-PORT VARIABLE DIVERTER

CC19115

SINGLE LEVER CARTRIDGES

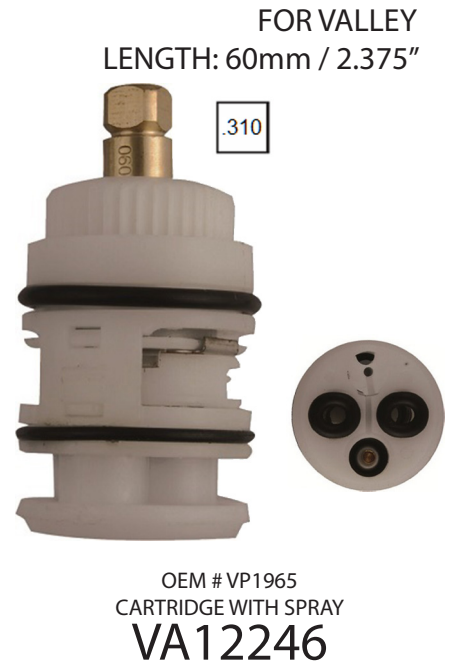

SINGLE LEVER CARTRIDGES

FOR GERBER
LENGTH: 61mm / 2.40"



DIAMETER: 40mm
OEM # 95-154

PBCV-CTG

FOR SAYCO
LENGTH: 62mm / 2.44"



DIAMETER: 38mm
OEM # P1050

CC19042

FOR NEWPORT BRASS
LENGTH: 62mm / 2.44"



DIAMETER: 25mm
OEM # 1-259

CC19150

FOR PRICE PFISTER
LENGTH: 62mm / 2.45"



OEM # 971-250

PP11697

SINGLE LEVER CARTRIDGES

FOR STERLING
LENGTH: 62mm / 2.45"



OEM # A05023
CARTRIDGE WITH DIVERTER
SL11982

FOR STERLING
LENGTH: 62mm / 2.45"



OEM # A05013
CARTRIDGE WITHOUT DIVERTER
SL11983

HYDROPLAST
LENGTH: 63mm / 2.46"



DIAMETER: 42mm
HYDROPLAST # C42
CC19095

FOR ZURN
LENGTH: 63mm / 2.48"



DIAMETER: 40mm
OEM # RK7440

CC19012

FOR PRICE PFISTER
LENGTH: 63mm / 2.48"



DIAMETER: 35mm
OEM # 974-505 / 974-570

CC19037

FOR PRICE PFISTER
LENGTH: 63mm / 2.48"



DIAMETER: 35mm
OEM # 974-035

CC19038

SINGLE LEVER CARTRIDGES

FOR DELTA
LENGTH: 63mm / 2.485"



DIAMETER: 36mm
OEM # RP50587

DE10485

HYDROPLAST
LENGTH: 63mm / 2.50"



DIAMETER: 40mm
HYDROPLAST # G40
FITS MANY MANUFACTURERS

CC19036

FOR HUNTINGTON BRASS
LENGTH: 63mm / 2.50"



DIAMETER: 40mm
WITHOUT MIXER

CC19058

KEROX
LENGTH: 63mm / 2.50"

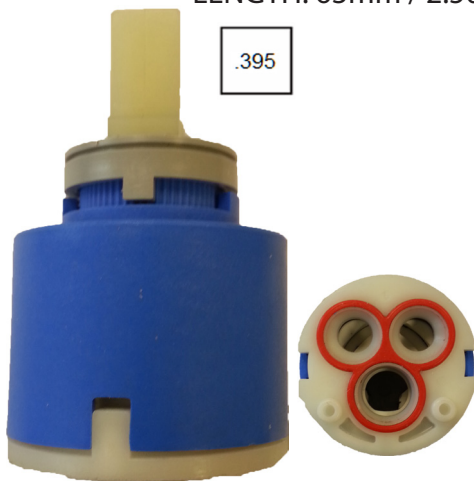

DIAMETER: 40mm
KEROX # K40A
FITS MANY MANUFACTURERS

CC19044

FOR KEROX
LENGTH: 63mm / 2.50"



DIAMETER: 40mm

CC19044-LS

FOR KEROX
LENGTH: 63mm / 2.50"



DIAMETER: 40mm

CC19144

SINGLE LEVER CARTRIDGES



CC19154

DIAMETER: 40mm
OEM # 1213
M-CORE SHOWER CARTRIDGE



DIAMETER: 35mm
HYDROPLAST # G35S

CC19136

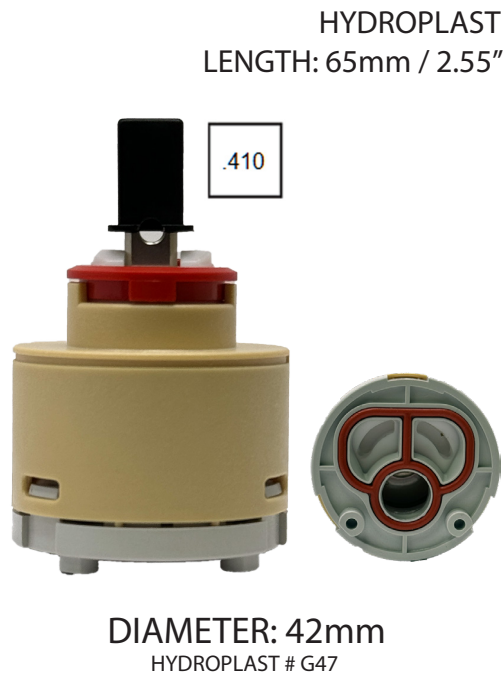

DIAMETER: 42mm
HYDROPLAST # G47

CC19137



DIAMETER: 40mm
DIVERTER CARTRIDGE

CC19098

SINGLE LEVER CARTRIDGES

FOR DELTA
LENGTH: 65mm / 2.57"



DIAMETER: 32mm
OEM # RP60114
EURO-MOTION CARTRIDGE
DE10489

FOR HANSGROHE
LENGTH: 66mm / 2.60"



DIAMETER: 35mm
OEM # 9273000
HG10902

KEROX
LENGTH: 67mm / 2.625"



DIAMETER: 35mm
KEROX # KJ-35A
CC19071

FOR VALLEY
LENGTH: 67mm / 2.63"



OEM # V4299BG
VA12255

FOR MILWAUKEE
LENGTH: 68mm / 2.66"



OEM # R1005
MW11329

FOR STERLING
LENGTH: 69mm / 2.70"



OEM # 05300
SL11981

SINGLE LEVER CARTRIDGES

FOR AMERICAN STANDARD
LENGTH: 69mm / 2.72"

FOR AMERICAN STANDARD
LENGTH: 69mm / 2.72"

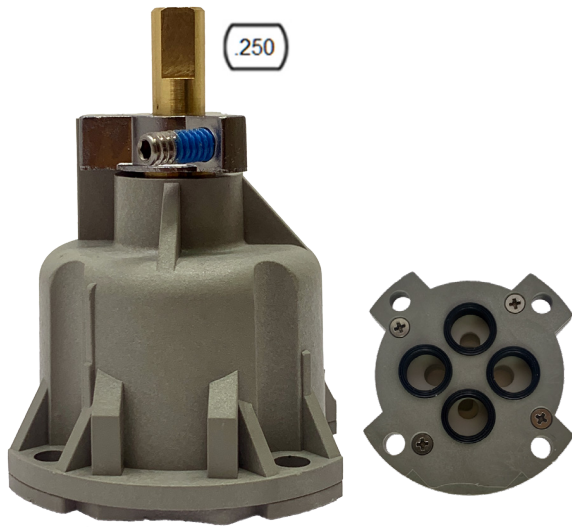

OEM # 51337-0070A

AS10192

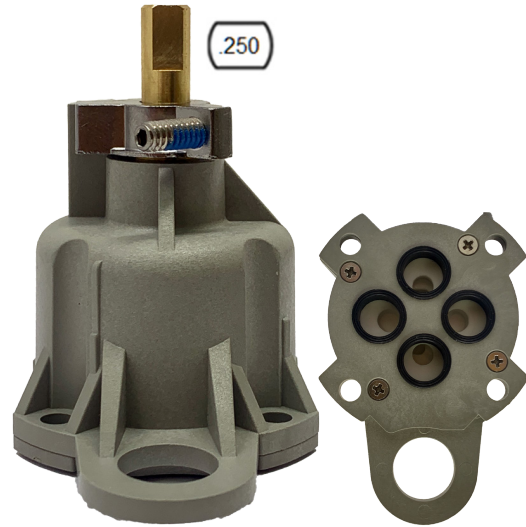

OEM # 66269-0070A

AS10193

HYDROPLAST
LENGTH: 63mm / 2.50"

VARIOUS MANUFACTURERS
LENGTH: 69mm / 2.73"

FOR PRICE PFISTER
LENGTH: 70mm / 2.75"



DIAMETER: 35mm
HYDROPLAST # BX35

CC19094



DIAMETER: 35mm

CC19132



DIAMETER: 35mm

OEM # 974-092
FITS MANY MANUFACTURERS

CC19008

SINGLE LEVER CARTRIDGES

HYDROPLAST
LENGTH: 70mm / 2.75"



DIAMETER: 35mm
HYDROPLAST # GX35

CC19035

VFOR GROHE
LENGTH: 70mm / 2.75"



OEM # 46374000

GR10836

VARIOUS MANUFACTURERS
LENGTH: 70mm / 2.76"



DIAMETER: 35mm
CONNECTED PIPE

CC19117

FOR AQUABRASS
LENGTH: 71mm / 2.78"



DIAMETER: 35mm
OEM # ABCA03240

CC19083

VARIOUS MANUFACTURERS
LENGTH: 71mm / 2.80"



DIAMETER: 35mm
JOYSTICK TYPE

CC19010

FOR ROHL
LENGTH: 72mm / 2.85"

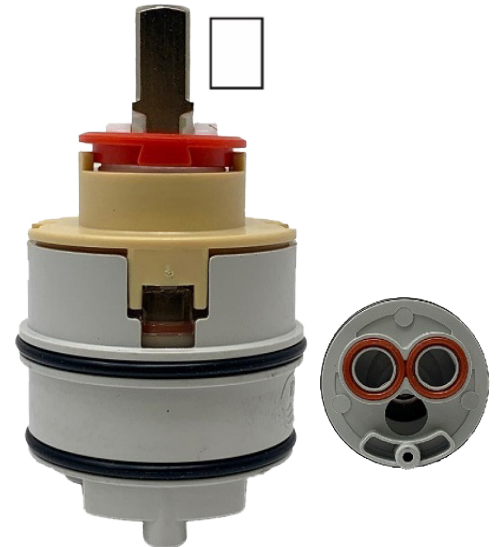

DIAMETER: 38mm
ROHL # ZZ93196000/ HYDROPLAST # AX38

CC19093

SINGLE LEVER CARTRIDGES

FOR MOEN
LENGTH: 72mm / 2.85"



DIAMETER: 35mm
MOEN # 194149 / KEROX # KDZ-35B
DIVERTER CARTRIDGE
CC19096

FOR KOHLER
LENGTH: 72mm / 2.855"



OEM # GP30413
KO11183

KEROX
LENGTH: 73mm / 2.86"



DIAMETER: 35mm
KEROX # K-35B HWS
FITS MANY MANUFACTURERS
CC19070

KEROX
LENGTH: 73mm / 2.86"



DIAMETER: 35mm
KEROX # K-35B
FITS MANY MANUFACTURERS
CC19070-LS

KEROX
LENGTH: 73mm / 2.86"



DIAMETER: 35mm
DIVERTER CARTRIDGE
CC19146

SINGLE LEVER CARTRIDGES

VARIOUS MANUFACTURERS
LENGTH: 74mm / 2.90"



DIAMETER: 40mm
JOYSTICK TYPE

CC19016

VARIOUS MANUFACTURERS
LENGTH: 75mm / 2.95"



DIAMETER: 40mm
IMPORT # JH02BD

CC19025

FOR GLACIER BAY/ PEGASUS
LENGTH: 75mm / 2.95"



DIAMETER: 40mm
OEM # RP20006

CC19032

FOR KOHLER
LENGTH: 76mm / 2.98"



DIAMETER: 40mm
OEM # 78896

CC19105

HYDROPLAST
LENGTH: 76mm / 2.98"



DIAMETER: 40mm
HYDROPLAST # GX40

CC19138

SINGLE LEVER CARTRIDGES

FOR SAYCO
LENGTH: 76mm / 2.99"

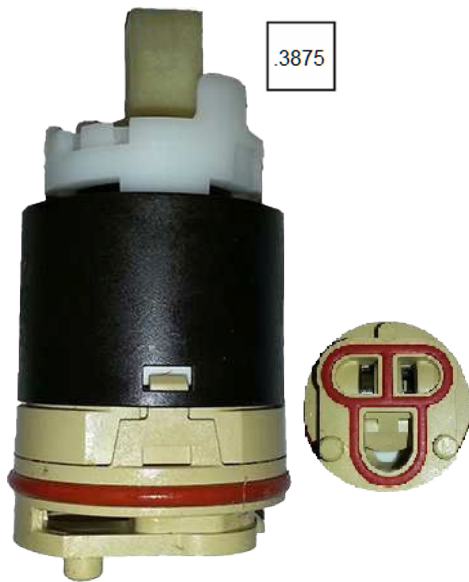

DIAMETER: 38mm
OEM # P1071

CC19040

KEROX
LENGTH: 76mm / 2.99"



DIAMETER: 40mm
KEROX # PBS40

CC19045

KEROX
LENGTH: 76mm / 2.99"

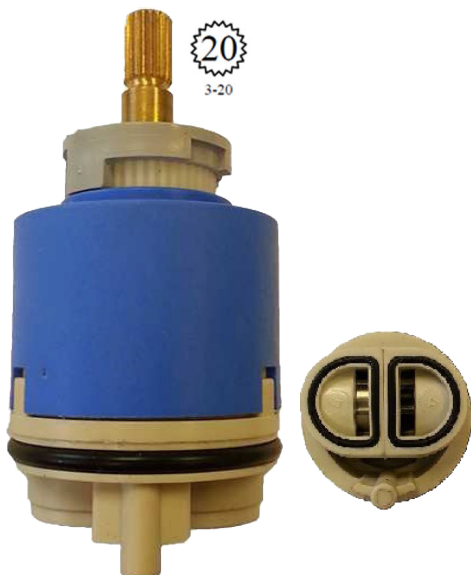

DIAMETER: 40mm
KEROX # PBR40

CC19046

FOR PROFLO
LENGTH: 76mm / 3.00"



DIAMETER: 40mm
OEM # ACF300CRT2 (LESS CHECK)

CC19107

SINGLE LEVER CARTRIDGES

VARIOUS MANUFACTURERS
LENGTH: 76mm / 3.00"



DIAMETER: 40mm

CC19014

FOR MOEN
LENGTH: 76mm / 3.00"



DIAMETER: 40mm
OEM # 121549 / KEROX # K40B
ALSO FITS VARIOUS MANUFACTURERS

CC19051

FOR MOEN
LENGTH: 76mm / 3.00"



DIAMETER: XXmm
IMPORT # 121549

CC19140

VARIOUS MANUFACTURERS
LENGTH: 77mm / 3.02"

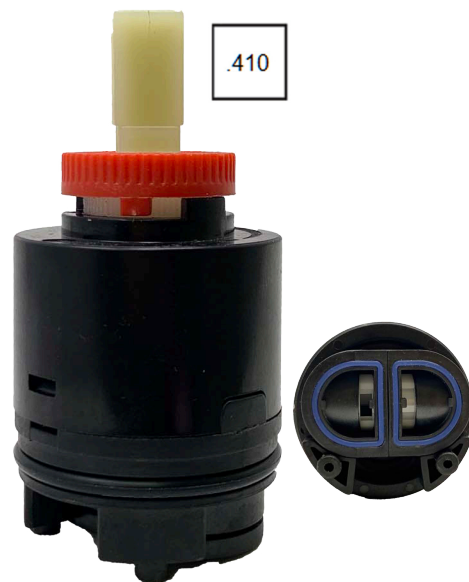

DIAMETER: 40mm
IMPORT # N40HKC

CC19108

SINGLE LEVER CARTRIDGES

FOR EZ-FLO
LENGTH: 78mm / 3.07"



DIAMETER: 40mm
OEM # 90030 / IMPORT # JL02BJ
ALSO FITS VARIOUS MANUFACTURERS

CC19024

FOR SAYCO
LENGTH: 78mm / 3.07"

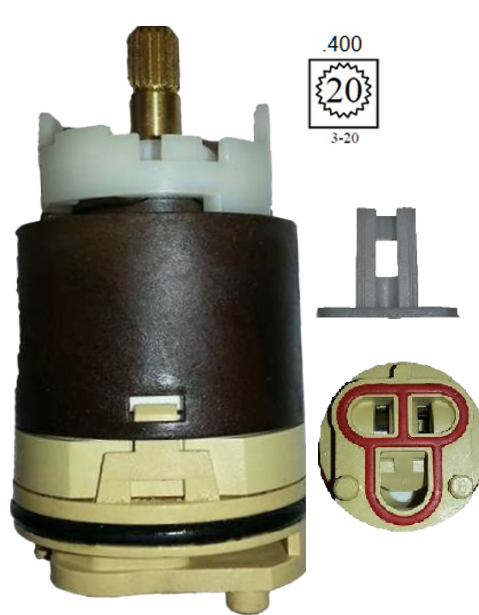

DIAMETER: 38mm
OEM # P1070

CC19039

VARIOUS MANUFACTURERS
LENGTH: 78mm / 3.08"



DIAMETER: 40mm

CC19116

FOR ZURN
LENGTH: 79mm / 3.10"

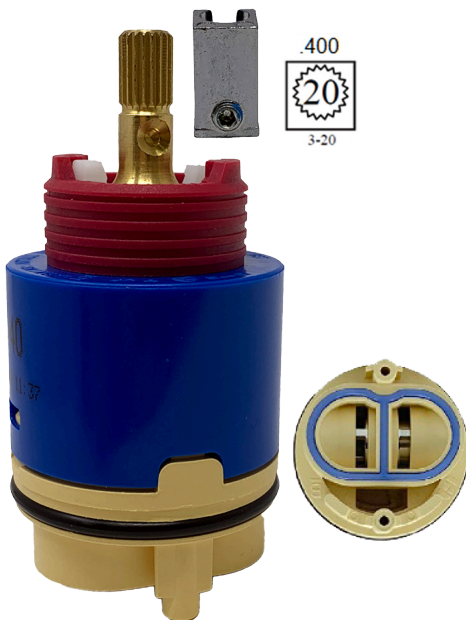

DIAMETER: 40mm
OEM # RK7300-CART-3P / IMPORT # JH02BJ
ALSO FITS VARIOUS MANUFACTURERS

CC19025-OS

HYDROPLAST
LENGTH: 79mm / 3.11"



DIAMETER: 42mm
HYDROPLAST # CX42

CC19133

VARIOUS MANUFACTURERS
LENGTH: 79mm / 3.11"



DIAMETER: 40mm
IMPORT # JL04BD

CC19023

SINGLE LEVER CARTRIDGES

FOR HUNTINGTON
LENGTH: 79mm / 3.12"



DIAMETER: 40mm
SPECIAL HUNTINGTON CARTRIDGE
WITH SMALLER .365 BROACH
CC19023SP

FOR HUNTINGTON
LENGTH: 79mm / 3.12"



DIAMETER: 40mm
OEM # ST7100 / IMPORT # JL01GJ
FITS VARIOUS MANUFACTURERS
CC19023-OS

FOR KOHLER
LENGTH: 80mm / 3.14"



DIAMETER: 35mm
OEM # 1126312 / KEROX # KJ-35B
CC19072

VARIOUS MANUFACTURERS
LENGTH: 80mm / 3.14"



DIAMETER: 40mm
IMPORT # JH01GJ
CC19079

FOR DELTA / PEERLESS
LENGTH: 80mm / 3.15"



DIAMETER: 40mm
OEM # RP70538
CC19054

FOR DELTA / PEERLESS
LENGTH: 80mm / 3.15"



DIAMETER: 40mm
OEM # RP70538 (NEW STYLE)
CC19054-NS

SINGLE LEVER CARTRIDGES

VARIOUS MANUFACTURERS
LENGTH: 81mm / 3.20"

VARIOUS MANUFACTURERS
LENGTH: 81mm / 3.20"

FOR PROFLO / SIGNATURE HARDWARE
LENGTH: 82mm / 3.23



DIAMETER: 33mm
3-WAY DIVERTER CARTRIDGE

CC19080



DIAMETER: 35mm
4-WAY DIVERTER CARTRIDGE

CC19081



DIAMETER: 42mm
OEM # HC-7002
DIVERTER CARTRIDGE

CC19127

FOR DELTA
LENGTH: 83mm / 3.25"

FOR DELTA
LENGTH: 83mm / 3.25"

FOR STERLING
LENGTH: 83mm / 3.25



OEM # RP32104

DE10481



OEM # RP46463

DE10483

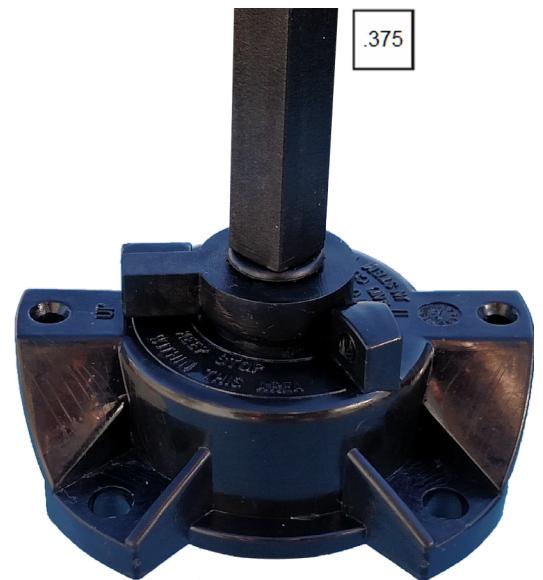

OEM # 05200

SL11980

SINGLE LEVER CARTRIDGES

FOR GLACIER BAY
LENGTH: 83mm / 3.27



DIAMETER: 40mm

CC19033

FOR MOEN
LENGTH: 83mm / 3.27



DIAMETER: 33mm

OEM # 163127
DIVERter CARTRIDGE

CC19084

FOR PAINI / LA TOSCANA
LENGTH: 83mm / 3.27



DIAMETER: 40mm
PROGRESSIVE CARTRIDGE

CC19103

FOR GALATRON
LENGTH: 83mm / 3.27



DIAMETER: 40mm
PROGRESSIVE CARTRIDGE
WITH CHECK

CC19103CHK

FOR ELKAY
LENGTH: 83mm / 3.28"



EK10594

FOR WOLVERINE
LENGTH: 84mm / 3.30"



DIAMETER: 40mm
OEM # 85116

CC19048

SINGLE LEVER CARTRIDGES

VARIOUS MANUFACTURERS
LENGTH: 84mm / 3.30"

FOR SIGNATURE HARDWARE
LENGTH: 84mm / 3.30"

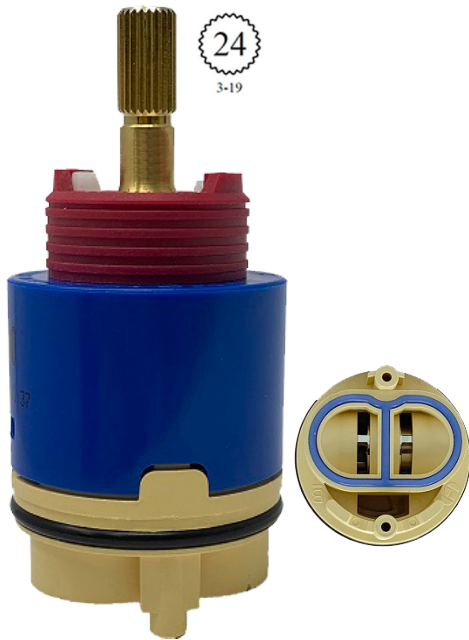

DIAMETER: 40mm

CC19076



DIAMETER: 40mm

CC19130

FOR TEMPRESS
LENGTH: 85mm / 3.33"

FOR TEMPRESS
LENGTH: 85mm / 3.33"

FOR TEMPRESS
LENGTH: 85mm / 3.33"



GROHE # 47 080, NEWPORT BRASS # 1-027
CAL FAUCETS # CART-PBS
PRESSURE BALANCE CARTRIDGE

TE11990



OEM #
Grohe: 47157000
Phylrich: 062N1285EF
Cal Faucets: CART-PBS-EF-CK
Rohl: 4113-0001
Sigma: 18.30.209
Hi Flow Pressure Balance Cartridge

TE11992



OEM #
Grohe: 47678000
Newport Brass: 1-207
Rohl: 4115-0040
Modular Pressure Balance Cartridge

TE11994

SINGLE LEVER CARTRIDGES

FOR BRIZO (DELTA)
LENGTH: 85mm / 3.335"



DIAMETER: 45mm
OEM # RP75213
TUB FILLER CARTRIDGE

CC19074

FOR BRIGGS, BRADLEY, KOHLER, SAYCO
LENGTH: 85mm / 3.35"



CARTRIDGE ONLY
BR10213
CARTRIDGE & GASKET TOGETHER

FOR BRIGGS
LENGTH: 85mm / 3.35"



OEM # P310
CARTRIDGE W/ CHROME SLEEVE

BR10214

FOR BRIGGS
LENGTH: 85mm / 3.35"



OEM # P301
CARTRIDGE W/ SHORT CHROME SLEEVE

BR10216

FOR SAYCO
LENGTH: 85mm / 3.35"

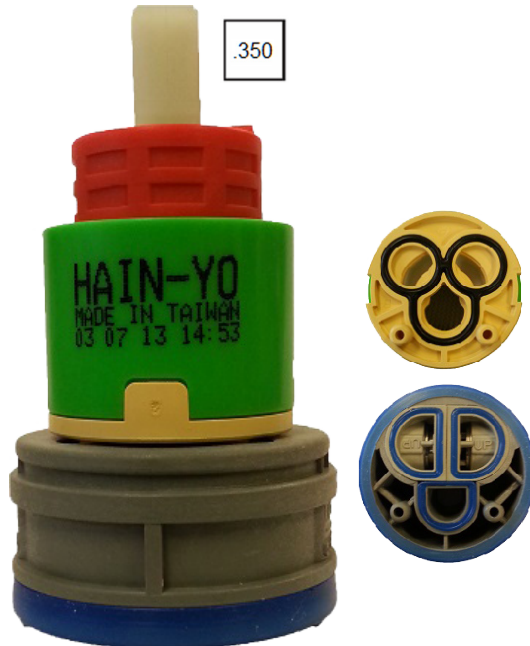

DIAMETER: 40mm
OEM # R200CC

CC19041

FOR PROFLO
LENGTH: 85mm / 3.35"



DIAMETER: 40mm
OEM # ACF3001CRT

CC19047

SINGLE LEVER CARTRIDGES

FOR GERBER
LENGTH: 85mm / 3.35"



DIAMETER: 40mm
OEM # 95-154 / 95-152
FITS VARIOUS MANUFACTURERS
PBCV

FOR KOHLER
LENGTH: 86mm / 3.375"



OEM # GP77886
KO11181

FOR AQUABRASS
LENGTH: 87mm / 3.42"



DIAMETER: 40mm
OEM # ABCA40299
PRESSURE BALANCE CARTRIDGE
CC19125

FOR EZ-FLO
LENGTH: 87mm / 3.42"



DIAMETER: 40mm
FITS VARIOUS MANUFACTURERS

CC19015

FOR DANZE / GERBER
LENGTH: 90mm / 3.55"

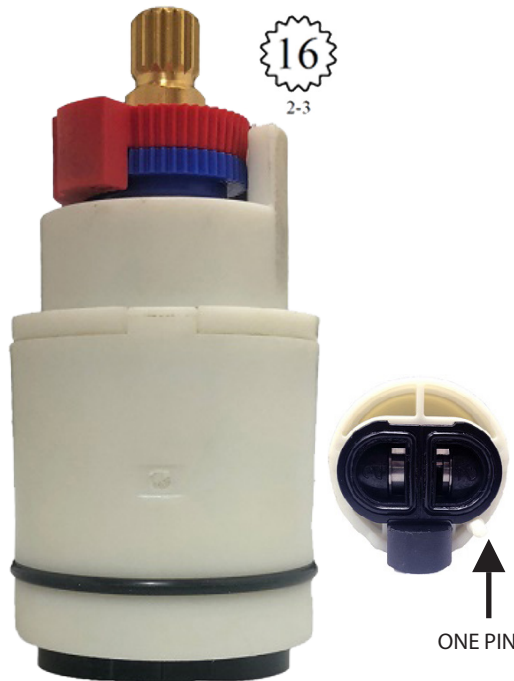

DIAMETER: 40mm
OEM # A50797

CC19061

VARIOUS MANUFACTURERS
LENGTH: 91mm / 3.58"



DIAMETER: 40mm

CC19055

SINGLE LEVER CARTRIDGES

FOR SAYCO
LENGTH: 88mm / 3.465"



DIAMETER: 38mm
OEM # P1079

CC19043

PAINI / LA TOSCANA
LENGTH: 88mm / 3.475"



DIAMETER: 40mm

CC19102

PAINI / LA TOSCANA
LENGTH: 88mm / 3.475"



DIAMETER: 40mm
WITH CHECK VALVES

CC19102CHK

FOR HUNTINGTON
LENGTH: 89mm / 3.50"



DIAMETER: 47mm
OEM # ST5000C

CC19030

VARIOUS MANUFACTURERS
LENGTH: 92mm / 3.62"



DIAMETER: 40mm
IMPORT # JH04BD
WITH CHECK VALVE

CC19053

SINGLE LEVER CARTRIDGES

FOR KOHLER
LENGTH: 92mm / 3.65"

FOR KOHLER
LENGTH: 92mm / 3.65

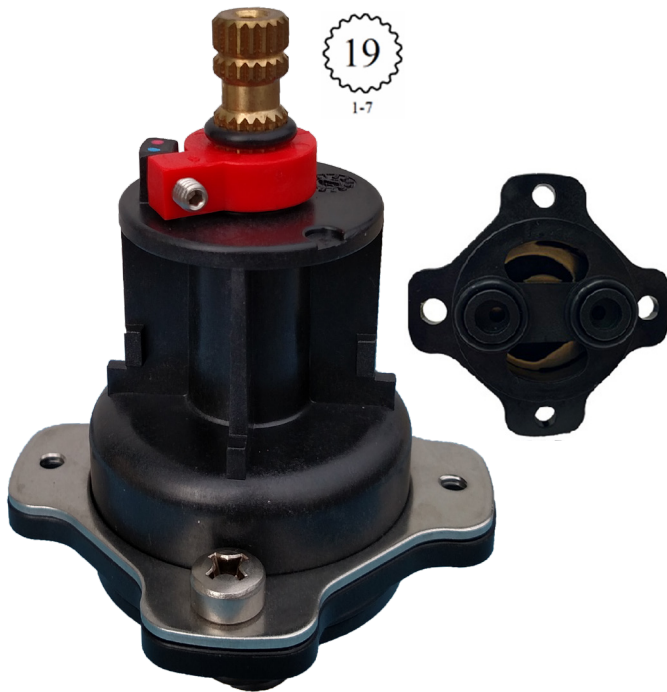

OEM # GP77759

KO11180

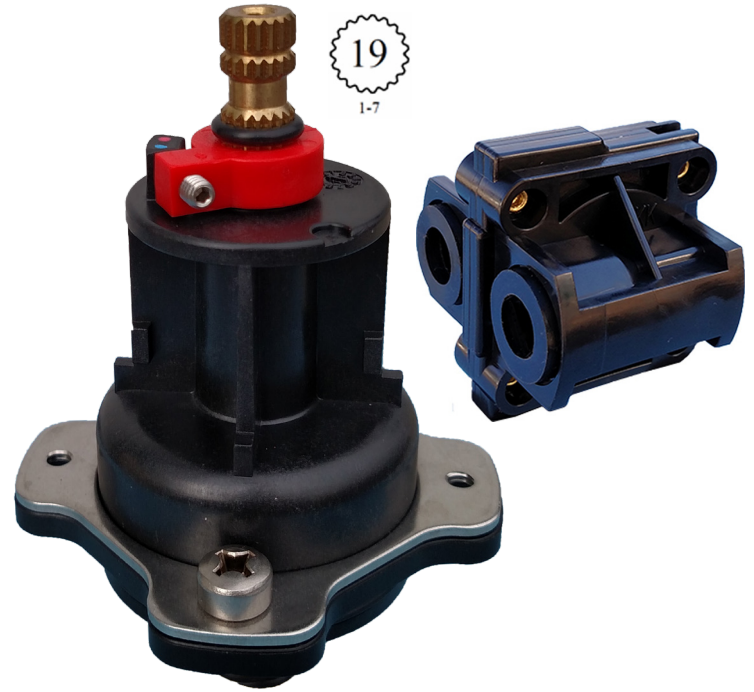

OEM # GP76851
RITE-TEMP MIXER & PRESSURE BALANCE CARTRIDGE

KO11184

FOR KOHLER
LENGTH: 92mm / 3.65"

FOR PROFLO
LENGTH: 96mm / 3.765"

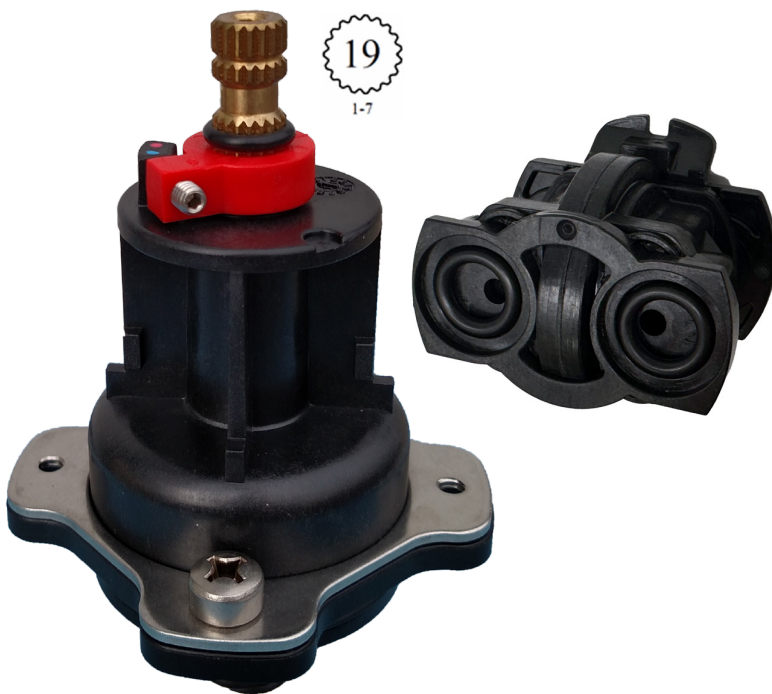

OEM # GP876851
RITE-TEMP MIXER & PRESSURE BALANCE CARTRIDGE

KO11189



DIAMETER: 40mm
OEM # ACF3001LSCRT
W/ CHECK

CC19047CHK

SINGLE LEVER CARTRIDGES

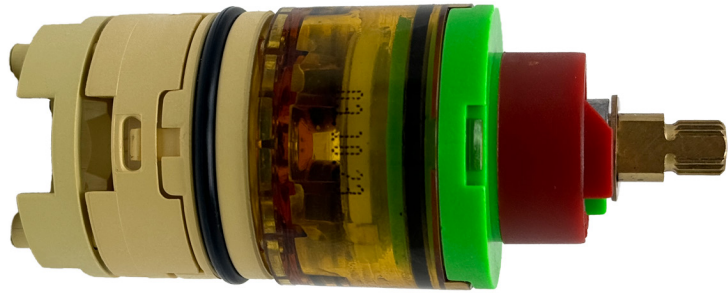

FOR GERBER
LENGTH: 96mm / 3.765"

20
3-20

PBCVCHK

DIAMETER: 40mm
WITH CHECK VALVES



FOR DANZE
LENGTH: 96mm / 3.765"

.350

CC19068

DIAMETER: 45mm
OEM # A507150

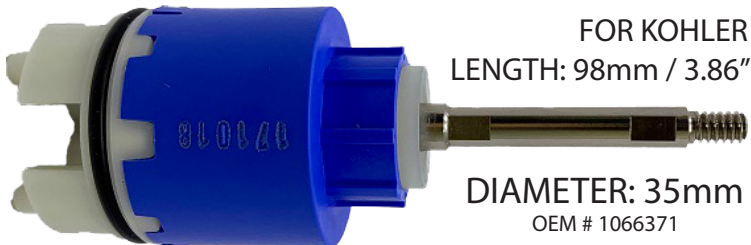

FOR KOHLER
LENGTH: 98mm / 3.86"

M6 X 1.00

DIAMETER: 35mm
OEM # 1066371

CC19082

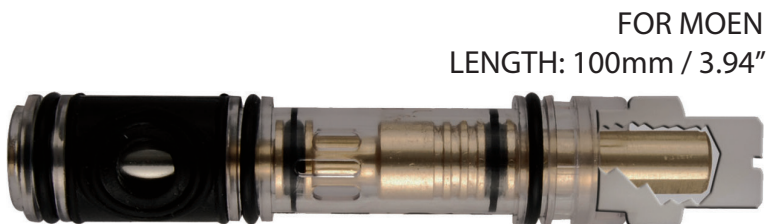

FOR MOEN
LENGTH: 100mm / 3.94"

.300

MO21304-LF

OEM # 1225
PLASTIC WITH BRASS CORE
LEAD FREE

SINGLE LEVER CARTRIDGES

FOR MOEN
LENGTH: 100mm / 3.94"



MO21305
MO21305-LF

OEM # 1200
BRASS CARTRIDGE

FOR VALLEY
LENGTH: 100mm / 3.94"



VA12253

DIAMETER: 40mm
OEM # V4268

FOR DANZE
LENGTH: 101mm / 3.99"



CC19101

DIAMETER: 40mm
OEM # DA507850
DIVERTER CARTRIDGE

38
3-21

FOR DANZE/GERBER/PEGASUS
LENGTH: 102mm / 4.00"



CC19057



OEM # 603567

38
3-21

SINGLE LEVER CARTRIDGES

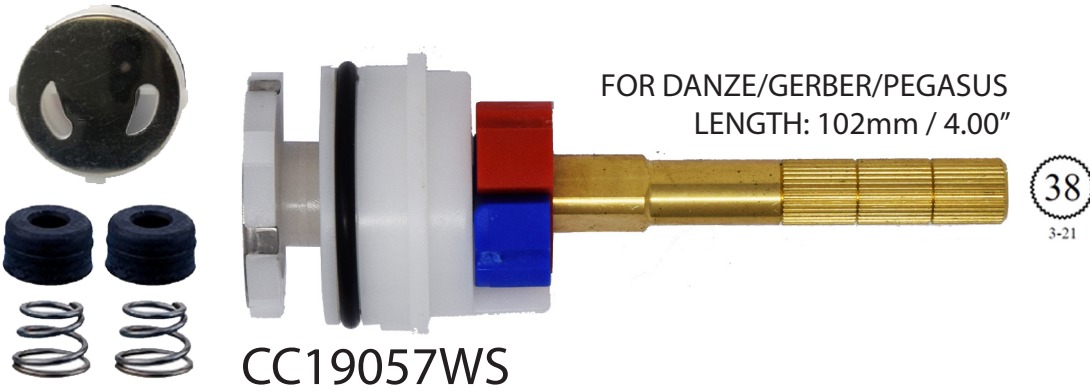

SINGLE LEVER CARTRIDGES

FOR SPEAKMAN
LENGTH: 104mm / 4.10"



SP11985

OEM # RPG05-1124
PRESSURE BALANCE CARTRIDGE

FOR NIBCO
LENGTH: 105mm / 4.125"

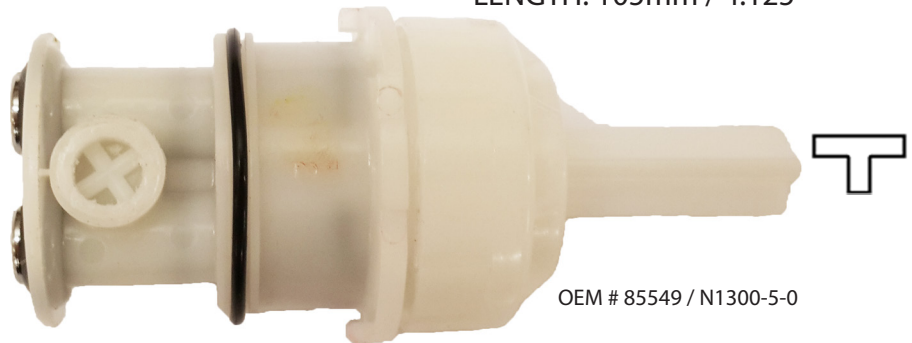

NI11440

OEM # 85549 / N1300-5-0

FOR MOEN
LENGTH: 105mm / 4.125



MO21306

OEM # 1222B
POSI-TEMP

FOR PRICE PFISTER
LENGTH: 105mm / 4.125"



PP11691

OEM # 974-292
AVANTE CARTRIDGE

SINGLE LEVER CARTRIDGES

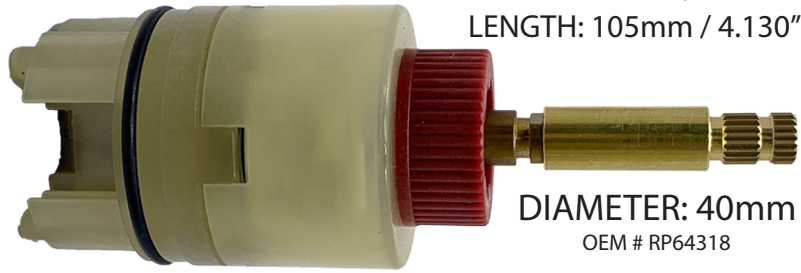

FOR GLACIER BAY / GROHE
LENGTH: 105mm / 4.130"



DIAMETER: 40mm
OEM # RP64318

CC19106

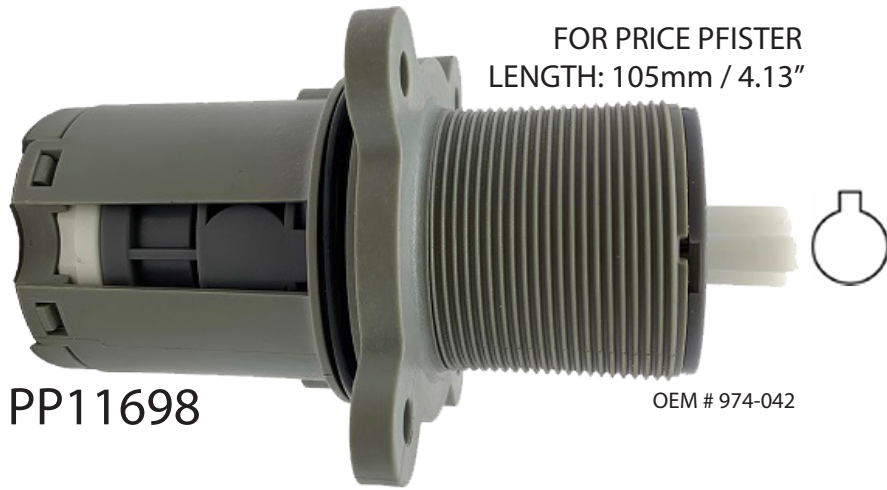

FOR PRICE PFISTER
LENGTH: 105mm / 4.13"



PP11698

OEM # 974-042



FOR PRICE PFISTER
LENGTH: 106mm / 4.165"

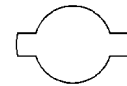

PP11704

OEM # 974-321



FOR GLACIER BAY & OTHERS
LENGTH: 106mm / 4.18"



DIAMETER: 40mm
OEM # A507887

CC19091

SINGLE LEVER CARTRIDGES

ORIGINAL CARTRIDGE
REPLACED BY CC19128



FOR GLACIER BAY
LENGTH: 106mm / 4.18"



CC19128

DIAMETER: 40mm
OEM # RP20124

FOR DELTA
LENGTH: 110mm / 4.325"



DE10484

OEM # RP46074

FOR DELTA
LENGTH: 110mm / 4.325"



DE10484-NS

OEM # RP46074

SINGLE LEVER CARTRIDGES

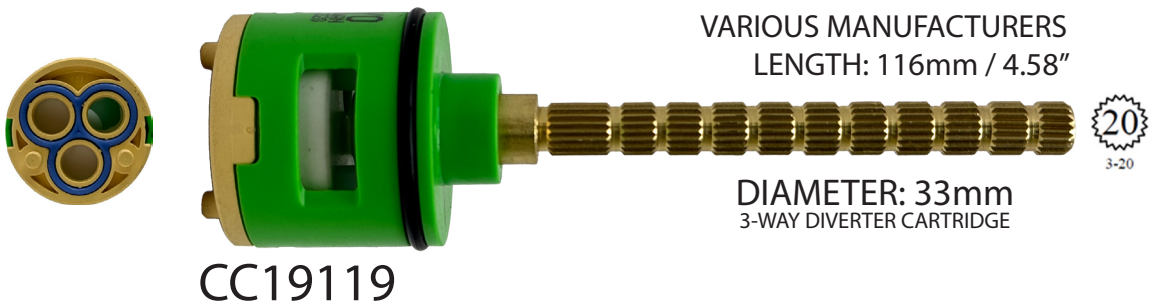
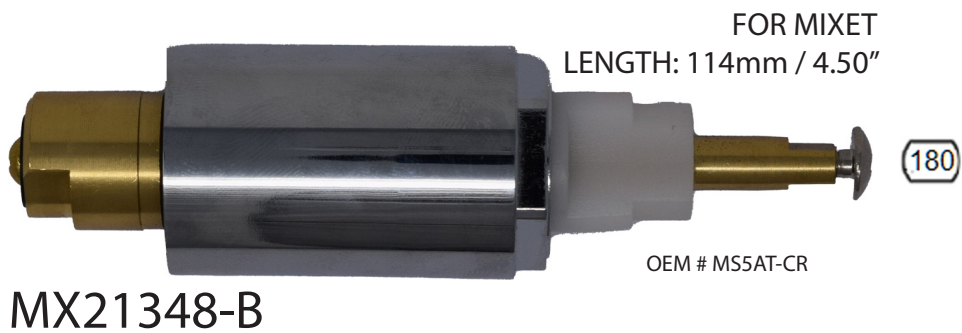
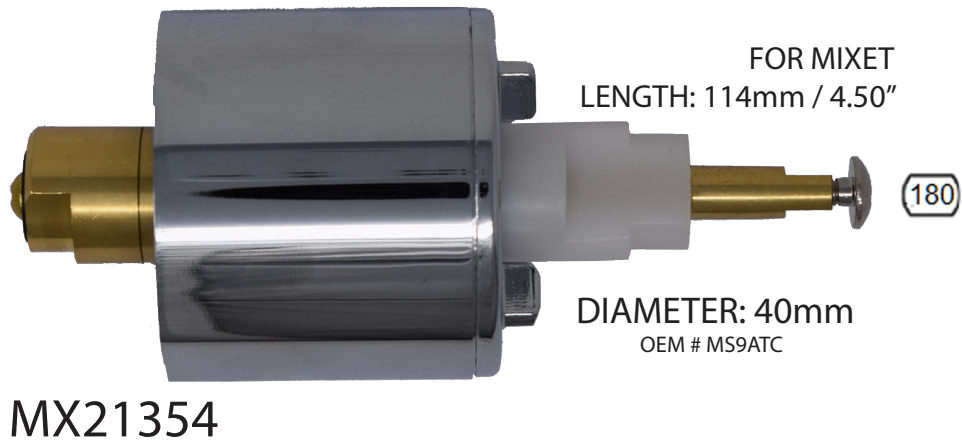
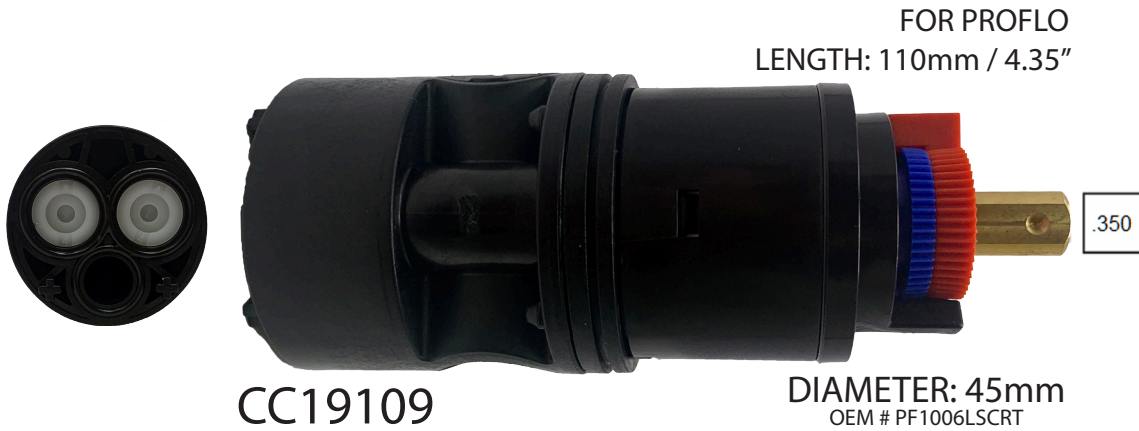

SINGLE LEVER CARTRIDGES



VARIOUS MANUFACTURERS
LENGTH: 116mm / 4.58"

24
3-19

DIAMETER: 33mm
3-WAY DIVERTER CARTRIDGE

CC19120



VARIOUS MANUFACTURERS
LENGTH: 116mm / 4.58"

20
3-20

DIAMETER: 35mm
4-WAY DIVERTER CARTRIDGE

CC19121



VARIOUS MANUFACTURERS
LENGTH: 116mm / 4.58"

24
3-19

DIAMETER: 35mm
4-WAY DIVERTER CARTRIDGE

CC19122

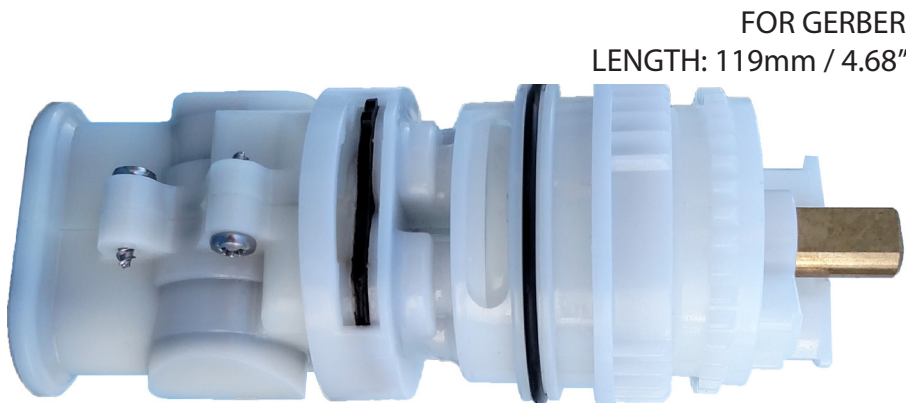

FOR GERBER
LENGTH: 119mm / 4.68"

240

GE10783

OEM # 97-014 / 97-022

SINGLE LEVER CARTRIDGES

FOR GERBER
LENGTH: 119mm / 4.68"



GE10784

FOR DANZE
LENGTH: 127mm / 4.70"

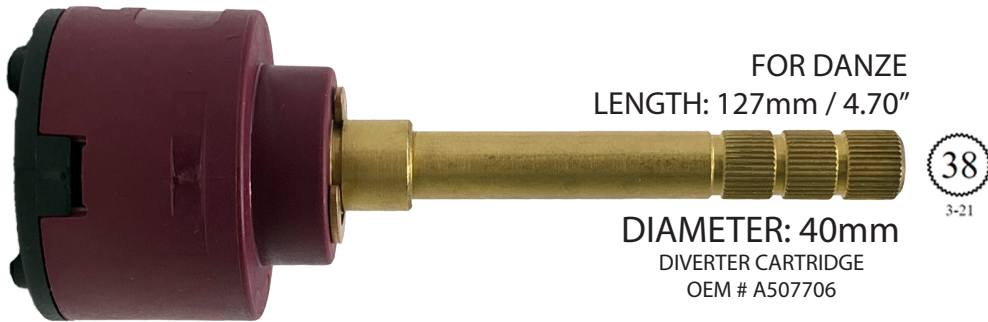

CC19110

FOR KOHLER
LENGTH: 127mm / 4.70"



KO11187

SINGLE LEVER CARTRIDGES

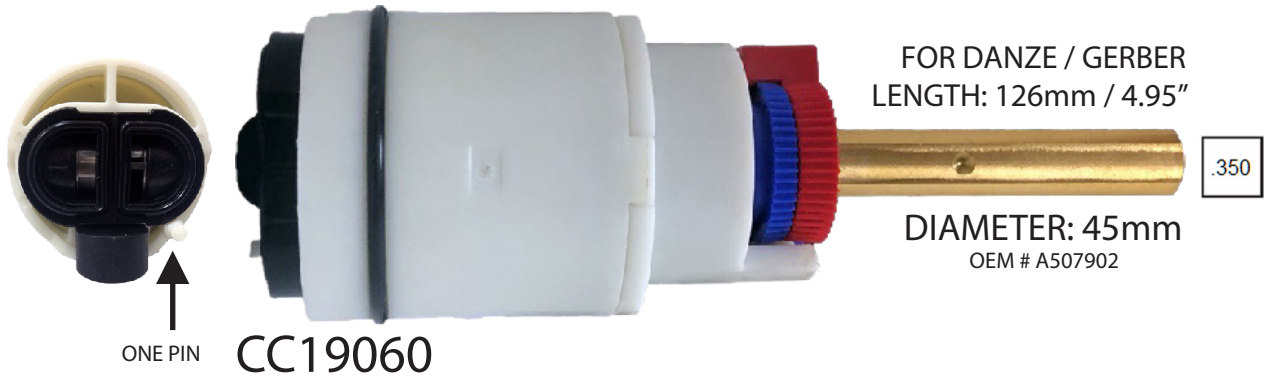

SINGLE LEVER CARTRIDGES

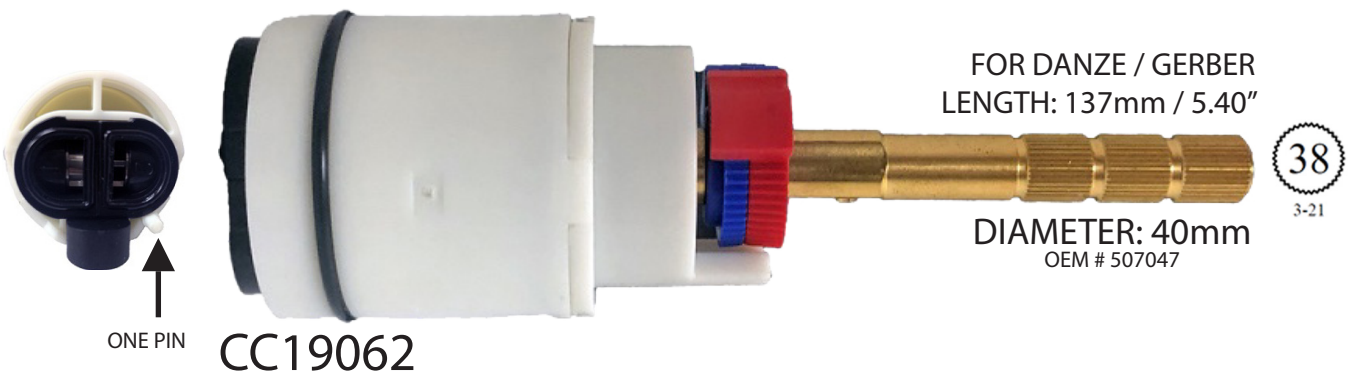
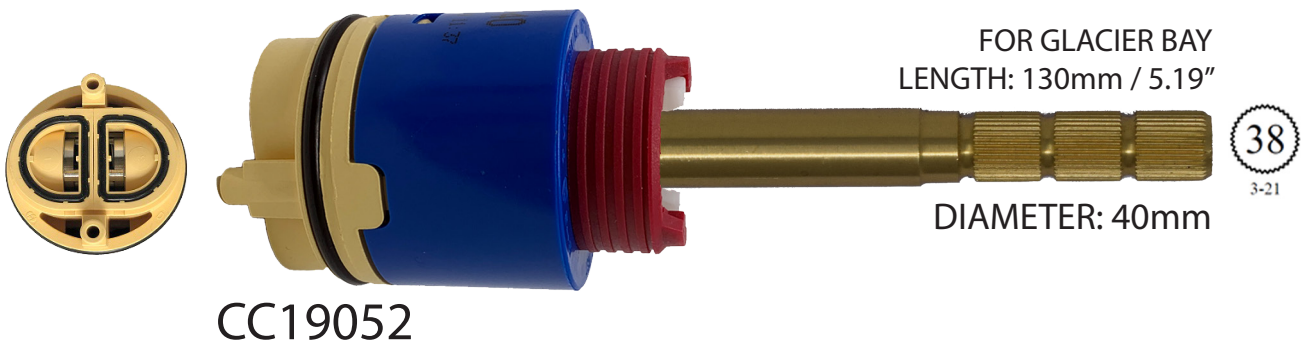
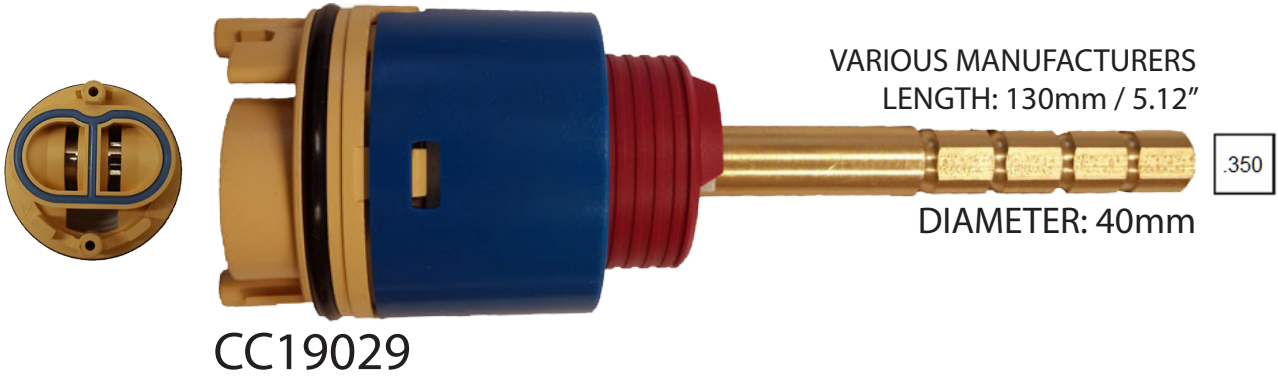

SINGLE LEVER CARTRIDGES

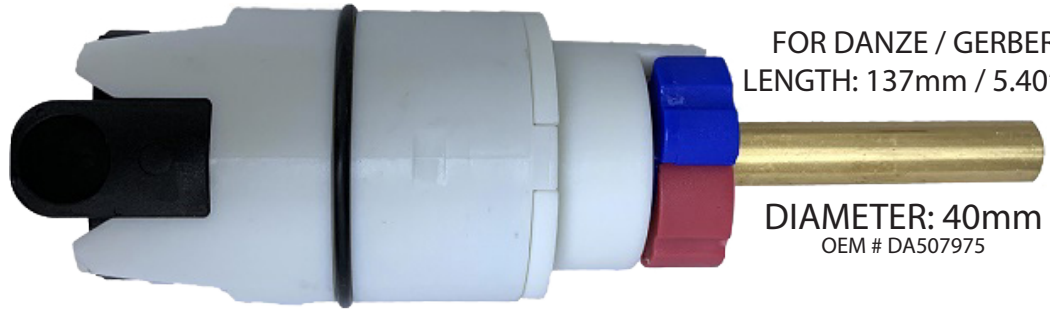

FOR DANZE / GERBER
LENGTH: 137mm / 5.40"

.350

DIAMETER: 40mm
OEM # DA507975

CC19063

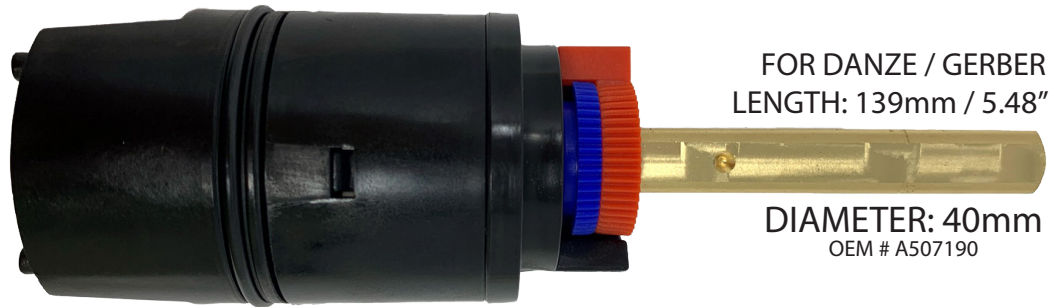

FOR DANZE / GERBER
LENGTH: 139mm / 5.48"

.350

DIAMETER: 40mm
OEM # A507190

CC19090



FOR DANZE / GERBER
LENGTH: 141mm / 5.55"

.350

DIAMETER: 45mm
OEM # A507165

CC19077

SINGLE LEVER CARTRIDGES

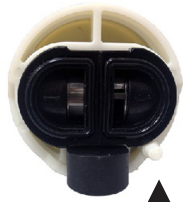

ONE PIN

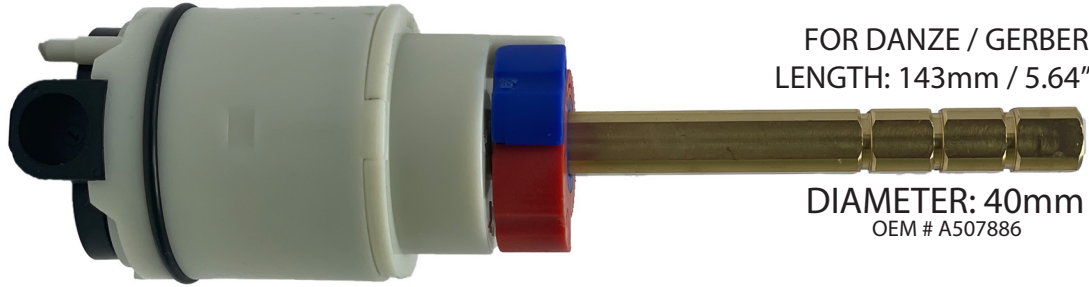

CC19126

FOR DANZE / GERBER
LENGTH: 143mm / 5.64"

DIAMETER: 40mm
OEM # A507886

.350



CC19067

FOR DANZE / GERBER
LENGTH: 145mm / 5.725"

DIAMETER: 45mm
OEM # A507108 / 97-231

38

3-21

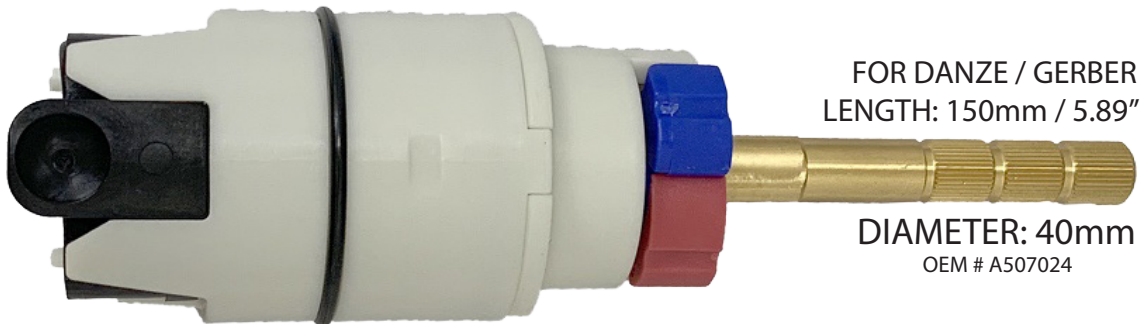

CC19065

FOR DANZE / GERBER
LENGTH: 150mm / 5.89"

DIAMETER: 40mm
OEM # A507024

38

3-21

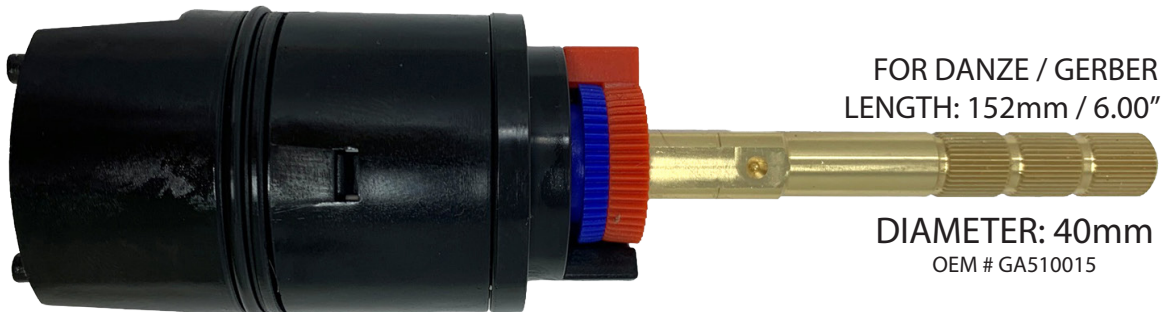

CC19089

FOR DANZE / GERBER
LENGTH: 152mm / 6.00"

DIAMETER: 40mm
OEM # GA510015

38

3-21

SINGLE LEVER CARTRIDGES



MX21349

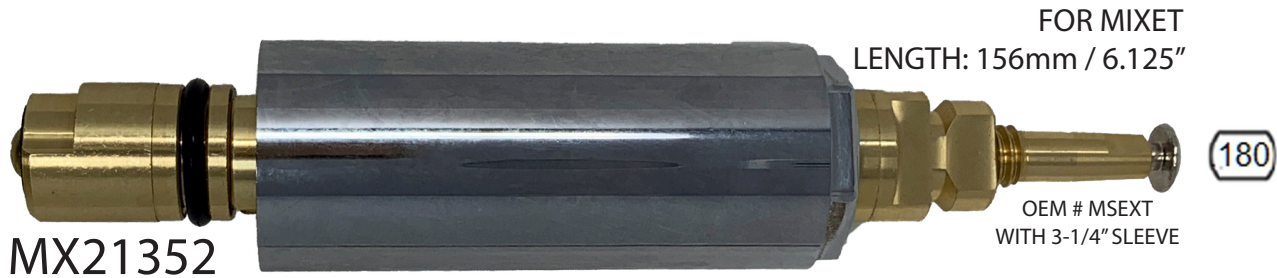

MX21352

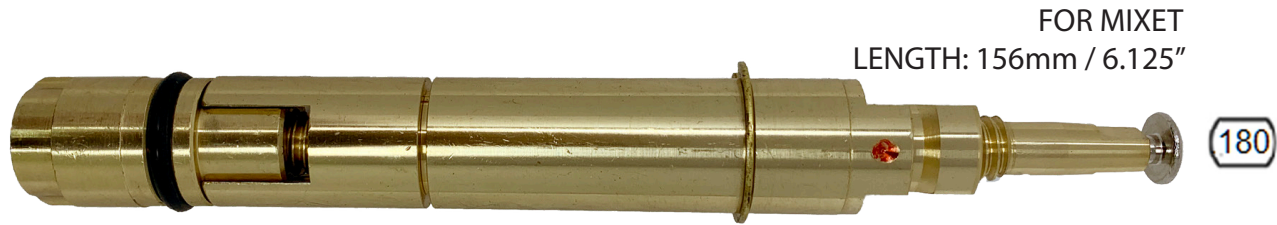

MX21353

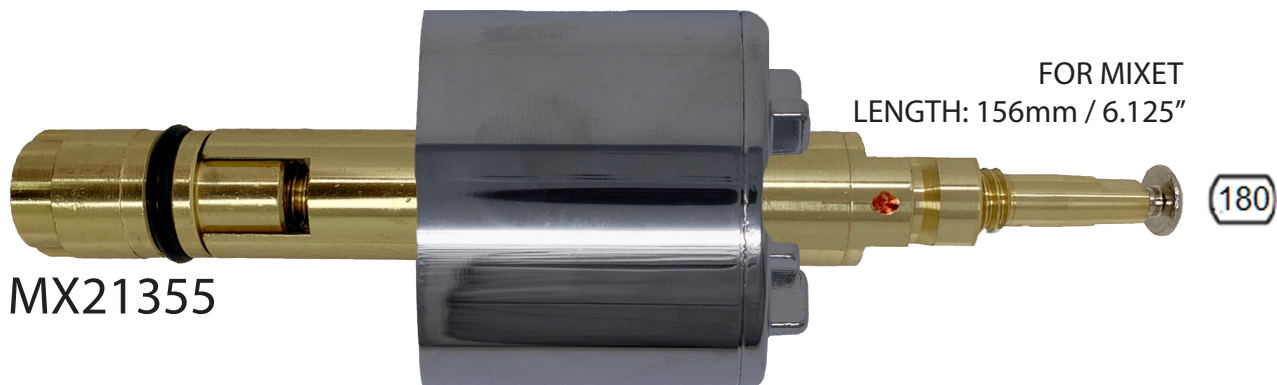

MX21355

SINGLE LEVER CARTRIDGES

FOR DANZE / GERBER
LENGTH: 165mm / 6.48"

VARIOUS MANUFACTURERS
LENGTH: 192mm / 7.575"

FOR PHLRICH
LENGTH: 194mm / 7.65"



.350

DIAMETER: 40mm
OEM # A507193
CC19088



20
3-20

DIAMETER: 40mm
CC19078



16
3-16

DIAMETER: 40mm
OEM #1-165
CC19131

SINGLE LEVER CARTRIDGES

FOR PHYLRICH
LENGTH: 195mm / 7.685"



16
3-16

DIAMETER: 40mm
OEM # 1-130

CC19075

FOR PHYLRICH
LENGTH: 195mm / 7.685"



16
3-16

DIAMETER: 40mm
OEM # 1-130 (NEW STYLE)

CC19075-NS